



ComplianceTesting.com

Previously Flom Test Lab

EMI, EMC, RF Testing Experts Since 1963

toll-free: (866) 311-3268

fax: (480) 926-3598

<http://www.ComplianceTesting.com>

info@ComplianceTesting.com

Date: July 8, 2009

Applicant: Kenwood USA Corporation
Communications Division
3970 Johns Creek Court, Suite 100
Suwanee, GA 30024

Attention of: Joel E. Berger, Research & Development
JBerger@kenwoodusa.com
(678) 474-4722; FAX: -4731

Equipment: TK-3140-02
FCC ID: ALH322601
FCC Rules: Part 90, 90.210

Gentlemen:

Enclosed please find your copy of the Engineering Test Report for which you are subject to the restrictions as listed on the attached summary.

Once a Telecommunication Certification Body (TCB) issues a Grant the Federal Communication Commission (FCC) has 30 days to review the application and request added information. It is your decision whether or not to market the equipment subject to a possible recall before the end of the 30 days.

If your equipment is still retained by us, it will be returned to you 30 days after approval is achieved. Our invoice for services has been directed to your Accounts Payable Department.

For any additional information please contact us.

Thank you.

Sincerely yours,

John Erhard, Engineering Manager

Summary of Restrictions

1. All submissions to the FCC are subject to **their** Examiner's interpretation.
2. Please allow from 60 to 90 days before hearing from the FCC with regard to any submission.
3. The FCC can set aside any action; modify or set aside any action, within 30 days. (FCC Rule 1.108, 1.113).
4. Under Rule 2.803, if device is not type accepted/certificated then it must **not** be sold, leased, offered for sale, imported, shipped or distributed or advertised for sale.
5. FCC can revoke its certificates at any time if the equipment does not meet or **continue** to meet their Rules. (Rule Parts 2.927, 2.939).
6. FCC can request a sample at any time (2.936).



ComplianceTesting.com

Previously Flom Test Lab

EMI, EMC, RF Testing Experts Since 1963

toll-free: (866) 311-3268

fax: (480) 926-3598

<http://www.ComplianceTesting.com>

info@ComplianceTesting.com

Date: July 8, 2009

Federal Communications Commission
Via: Electronic Filing

Attention: Authorization & Evaluation Division

Applicant: Kenwood USA Corporation

Equipment: TK-3140-02

FCC ID: ALH322601

FCC Rules: Part 90, 90.210

Dear Gentleman:

On behalf of the Applicant, enclosed please find Application Form 731, Engineering Test Report and all pertinent documentation, the whole for approval of the referenced equipment as shown.

We trust the same is in order. Should you need any further information, kindly contact the writer who is authorized to act as agent.

Best regards,

John Erhard, Engineering Manager



ComplianceTesting.com

Previously Flom Test Lab

EMI, EMC, RF Testing Experts Since 1963

toll-free: (866) 311-3268

fax: (480) 926-3598

<http://www.ComplianceTesting.com>

info@ComplianceTesting.com

Test Report

for

Model: TK-3140-02

to

Federal Communications Commission

Rule Part 90, 90.210

Date of report: July 8, 2009

On the Behalf of the Applicant: Kenwood USA Corporation

At the Request of: Kenwood USA Corporation
Communications Division
3970 Johns Creek Court, Suite 100
Suwanee, GA 30024

Attention of: Joel E. Berger, Research & Development
JBerger@kenwoodusa.com
(678) 474-4722; FAX: -4731

John Erhard, Engineering Manager

Reviewed by:

Test Report Revision History

Revision	Date	Revised By	Reason for revision
1.0	July 8, 2009	Greg Corbin	Original Document
2.0	July 20, 2009	G. Corbin	Revised table on pg 8 to add measured units.

List of Exhibits

(FCC **Certification** (Transmitters) - Revised 9/28/98)**Applicant:** Kenwood USA Corporation**FCC ID:** ALH322601**By Applicant:**

1. Letter of Authorization
2. Confidentiality Request: 0.457 And 0.459
3. Identification Drawings, 2.1033(c)(11)
 - Label
 - Location of Label
 - Compliance Statement
 - Location of Compliance Statement
4. Photographs, 2.1033(c)(12)
5. Documentation: 2.1033(c)
 - (3) User Manual
 - (9) Tune Up Info
 - (10) Schematic Diagram
 - (10) Circuit Description
 - Block Diagram
 - Parts List
 - Active Devices
6. MPE/SAR Report

By C.T.:

- A. Testimonial & Statement of Certification

The Applicant has been cautioned as to the following:

15.21 **Information to the User.**

The users manual or instruction manual for an intentional radiator shall caution the user that changes or modifications not expressly approved by the party responsible for compliance could void the user's authority to operate the equipment.

15.27(a) **Special Accessories.**

Equipment marketed to a consumer must be capable of complying with the necessary regulations in the configuration in which the equipment is marketed. Where special accessories, such as shielded cables and/or special connectors are required to enable an unintentional or intentional radiator to comply with the emission limits in this part, the equipment must be marketed with, i.e. shipped and sold with, those special accessories. However, in lieu of shipping or packaging the special accessories with the unintentional or intentional radiator, the responsible party may employ other methods of ensuring that the special accessories are provided to the consumer, without additional charge.

Information detailing any alternative method used to supply the special accessories for a grant of equipment authorization or retained in the verification records, as appropriate. The party responsible for the equipment, as detailed in § 2.909 of this chapter, shall ensure that these special accessories are provided with the equipment. The instruction manual for such devices shall include appropriate instructions on the first page of text concerned with the installation of the device that these special accessories must be used with the device. It is the responsibility of the user to use the needed special accessories supplied with the equipment.

Testimonial and Statement of Certification

This is to Certify:

1. **That** the application was prepared either by, or under the direct supervision of, the undersigned.
2. **That** the technical data supplied with the application was taken under my direction and supervision.
3. **That** the data was obtained on representative units, randomly selected.
4. **That**, to the best of my knowledge and belief, the facts set forth in the application and accompanying technical data are true and correct.



Certifying Engineer:

Greg Corbin

Table of Contents

<u>Rule</u>	<u>Description</u>	<u>Page</u>
2.1033(c)(14)	Rule Summary	3
	Standard Test Conditions and Engineering Practices	4
2.1033(c)	General Information Required	5
	Test Results Summary	7
2.1046	Carrier Output Power (Conducted)	8
2.1051	Conducted Spurious Emissions	9
2.1053	Field Strength of Spurious Radiation	13
90.210	Emission Masks (Occupied Bandwidth)	18
90.214	Transient Frequency Behavior	24
2.1047	Audio Low Pass Filter (Voice Input)	27
2.1047	Audio Frequency Response	29
2.1047	Modulation Limiting	31
90.213	Frequency Stability (Temperature Variation)	36
90.213	Frequency Stability (Voltage Variation)	37
	Test Equipment Utilized	38

Required information per ISO 17025-2005, paragraph 5.10.2:

- a) **Test Report**
- b) Laboratory: Compliance Testing
 (FCC: 31040/SIT) 3356 N. San Marcos Place, Suite 107
 (Canada: IC 2044-A) Chandler, AZ 85225
- c) Report Number: d0970007
- d) Client: Kenwood USA Corporation
 Communications Division
 3970 Johns Creek Court, Suite 100
 Suwanee, GA 30024
- e) Identification: TK-3140-02
 EUT Description: UHF FM Transceiver
- f) EUT Condition: Not required unless specified in individual tests.
- g) Report Date: July 8, 2009
- h, j, k): As indicated in individual tests.
- i) Sampling method: No sampling procedure used.
- l) Measurement Uncertainty: In accordance with FTL internal quality manual.
- m) Reviewed by:

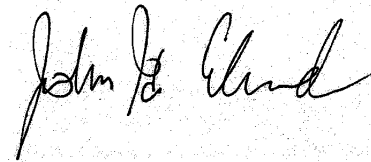

John Erhard, Engineering Manager

- n) Results: The results presented in this report relate only to the item tested.
- o) Reproduction: This report must not be reproduced, except in full, without written permission from this laboratory.

Accessories used during testing:

Type	Quantity	Manufacturer	Model	Serial No.	FCC ID
Antenna	1	Kenwood	KRA-15M2	0179	N/A
Antenna	1	Kenwood	KRA-23M2	0176	N/A
Antenna	1	Kenwood	KRA-27M2	0101	N/A
Microphone	1	Kenwood	KMC-25	N/A	N/A
Battery	1	Kenwood	KNB-26N	0161	N/A
Battery Charger	1	Kenwood	KSC-25	N/A	N/A
AC Adapter	1	Kenwood	W08-1058	N/A	N/A
Power Supply	1	HP	6286A	N/A	N/A
Battery Jig	1	Kenwood	N/A	0151	N/A
Audio Test Jig	1	Kenwood	N/A	0152	N/A

Sub-part
2.1033(c)(14):

Test and Measurement Data

All tests and measurement data shown were performed in accordance with FCC Rules and Regulations, Volume II; Part 2, Sub-part J, Sections 2.947, 2.1033(c), 2.1041, 2.1046, 2.1047, 2.1079, 2.1051, 2.1053, 2.1055, 2.1057 and the following individual Parts: 90, 90.210.

Standard Test Conditions and Engineering Practices

Except as noted herein, the following conditions and procedures were observed during the testing:

In accordance with ANSI/TIA-603-C-2004, and unless otherwise indicated in the specific measurement results, the ambient temperature of the actual EUT was maintained within the range of 10° to 40°C (50° to 104 °F) unless the particular equipment requirements specify testing over a different temperature range. Also, unless otherwise indicated, the humidity levels were in the range of 10% to 90% relative humidity.

Measurement results, unless otherwise noted, are worst-case measurements.

A2LA

“A2LA has accredited Compliance Testing, Chandler, AZ for technical competence in the field of Electrical testing. The accreditation covers the specific tests and types of tests listed on the agreed scope of accreditation. This laboratory meets the requirements of ISO 17025:2005 ‘General Requirements for the Competence of Testing and Calibration Laboratories’ and any additional program requirements in the identified field of testing.”

Please refer to www.a2la.org for current scope of accreditation.

Certificate number: 2152.01



FCC OATS Reg. #933597

IC Reg. # 2044A-1

List of General Information Required for Certification

In Accordance with FCC Rules and Regulations,
Volume II, Part 2 and to Sub-part 2.1033

(c)(1):

Name and Address of Applicant: Kenwood USA Corporation
Communications Division
3970 Johns Creek Court, Suite 100
Suwanee, GA 30024

Manufacturer: Kenwood Corporation
14-6, Dogenzaka 1-Chome
Shibuya-ku, Tokyo 150, Japan
OR
Kenwood Electronics Technologies PTE Ltd.
1 Ang Mo Kio Street 63
Singapore 569110

(c)(2): **FCC ID:** ALH322601

Model Number: TK-3140-02

(c)(3): **Instruction Manual(s):**

Please see attached exhibits

(c)(4): **Type of Emission:** 16K0F3E, 11K0F3E

(c)(5): **Frequency Range, MHz:** 470 – 512 MHz

(c)(6): **Power Rating, Watts:** 4W continuously variable to 1W
 Switchable Variable N/A

FCC Grant Note: N/A

(c)(7): **Maximum Allowable Power, Watts:** 4

DUT Results: Passes Fails _____

Subpart 2.1033 (continued)

(c)(8): Voltages & currents in all elements in final RF stage, including final transistor or solid-state device:

Collector Current, A	=	2.0
Collector Voltage, Vdc	=	7.5
Supply Voltage, Vdc	=	7.5

(c)(9): **Tune-Up Procedure:**

Please see attached exhibits

(c)(10): **Circuit Diagram/Circuit Description:**

Including description of circuitry & devices provided for determining and stabilizing frequency, for suppression of spurious radiation, for limiting modulation and limiting power.

Please see attached exhibits

(c)(11): **Label Information:**

Please see attached exhibits

(c)(12): **Photographs:**

Please see attached exhibits

(c)(13): **Digital Modulation Description:**

Attached Exhibits
 N/A

(c)(14): **Test and Measurement Data:**

Follows

Test Results Summary

Specification	Test Name	Pass, Fail, N/A	Comments
2.1046	Carrier Output Power (Conducted)	Pass	
2.1051	Unwanted Emissions (Transmitter Conducted)	Pass	
2.1053	Field Strength of Spurious Radiation	Pass	
90.210	Emission Masks (Occupied Bandwidth)	Pass	
2.1047	Audio Low Pass Filter (Voice Input)	Pass	
2.1047	Audio Frequency Response	Pass	
2.1047	Modulation Limiting	Pass	
90.213	Frequency Stability (Temperature Variation)	Pass	
90.213	Frequency Stability (Voltage Variation)	Pass	

Name of Test: Carrier Output Power (Conducted)
Specification: 2.1046
Test Equipment Utilized: i00228, i00341

Engineer: G. Corbin
Test Date: 5/27/09

Measurement Procedure

The Unit Under Test (UUT) was connected directly to a power meter input. The peak readings were taken and the result was then compared to the limit.

Test Setup

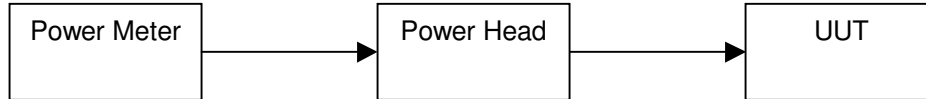

High Power Transmitter Peak Output Power

Tuned Frequency MHz	Recorded Measurement dBm	Result
470.05	36.13	Pass
491.05	35.98	Pass
511.95	36.04	Pass

Name of Test: Conducted Spurious Emissions
Specification: 2.1051
Test Equipment Utilized: i00124, i00049

Engineer: G. Corbin
Test Date: 7/7/09

Test Procedure

The UUT was connected directly to a spectrum analyzer to verify that the UUT met the requirements for spurious emissions. A tunable notch filter was utilized to ensure the fundamental did not put the spectrum analyzer into compression. The resolution bandwidth set for 100 kHz and the reference level was adjusted to ensure the system had sufficient dynamic range to measure spurious emissions. A reference level offset was programmed into the spectrum analyzer to account for the attenuator and cable loss. The notch filter was utilized to suppress the fundamental preventing compression of the spectrum analyzer. The frequency range from 30 MHz to the 10th harmonic of the fundamental transmitter was observed and plotted.

Test Setup

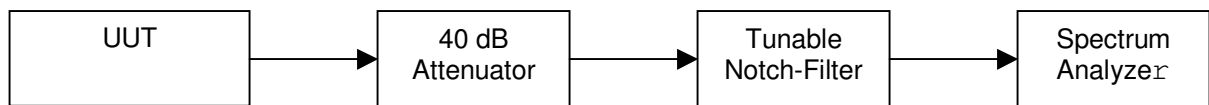

High Power Conducted Spurious Emissions Summary Test Table

Tuned Frequency MHz	Spurious Frequency MHz	Measured Spurious Level (dBm)	Specification Limit (dBm)	Result
470.05	2834	-31.6	-20	Pass
491.95	2856	-30.1	-20	Pass
511.95	2958	-30.1	-20	Pass

Conducted Spurious Emissions Test Plots

470.05 MHz (30 MHz – 1 GHz)

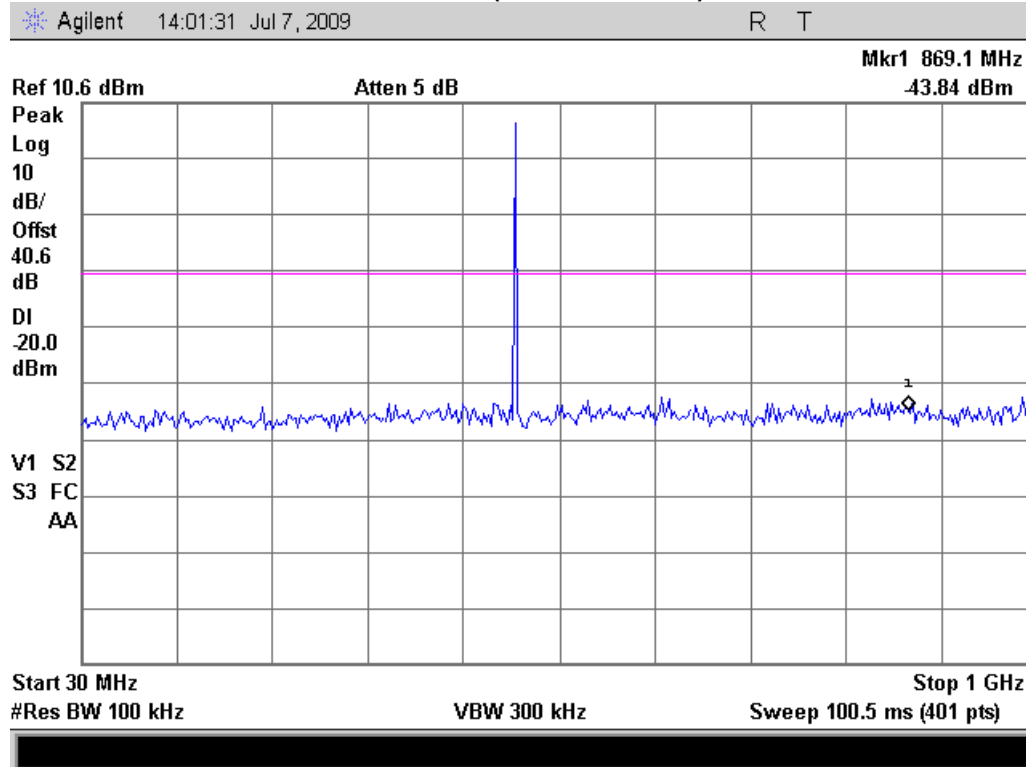

470.05 MHz (1 GHz – 5.5 GHz)

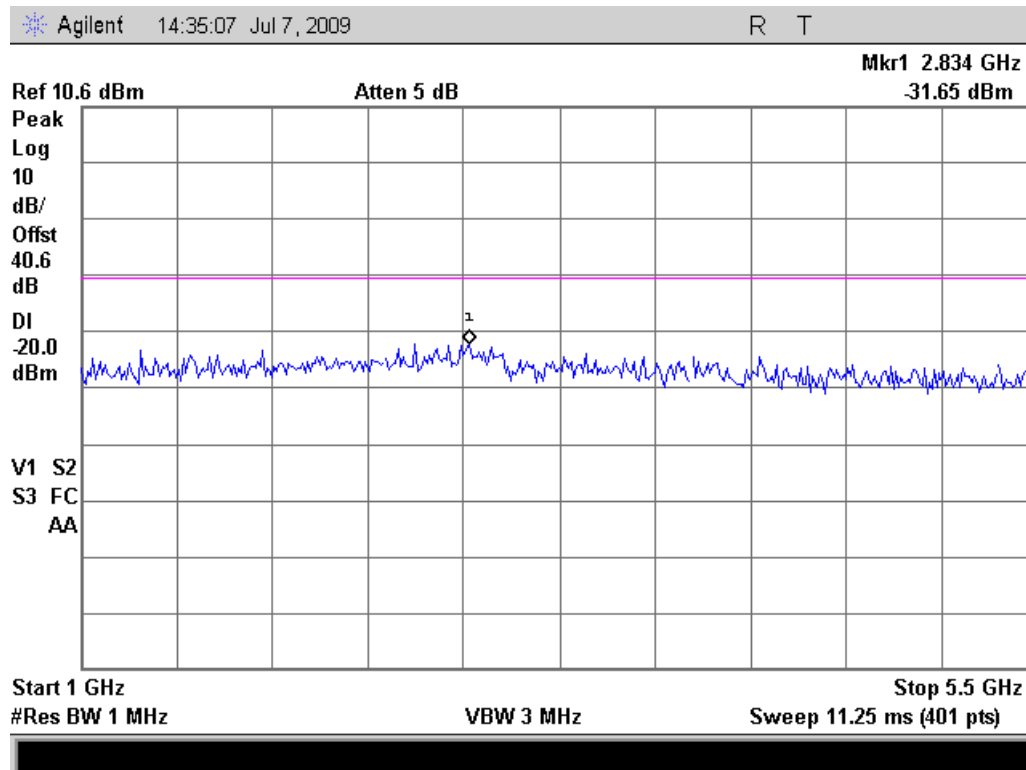

491.05 MHz (30 MHz – 1 GHz)

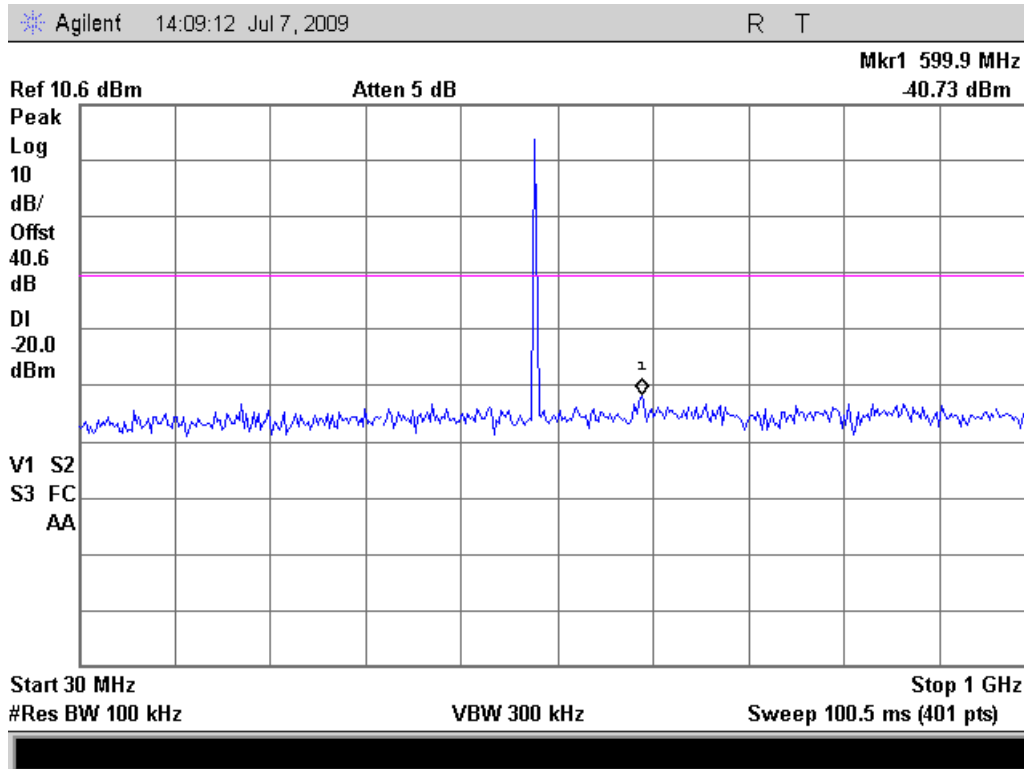

491.05 MHz (1 GHz – 5.5 GHz)

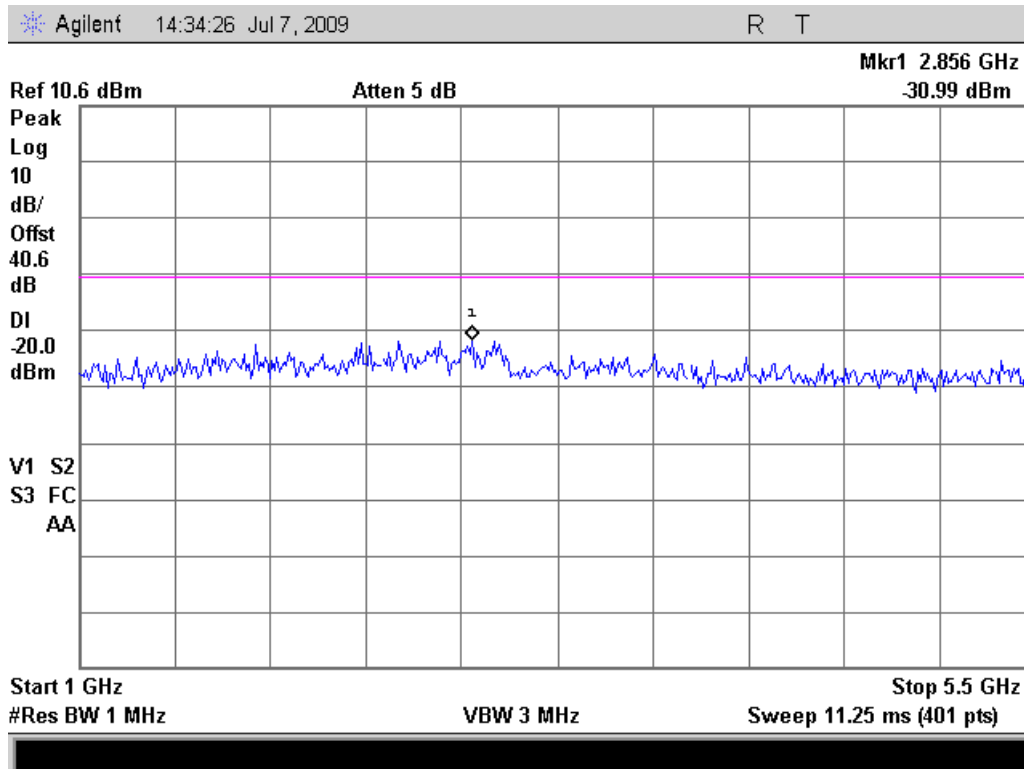

511.95 MHz (30 MHz – 1.1 GHz)

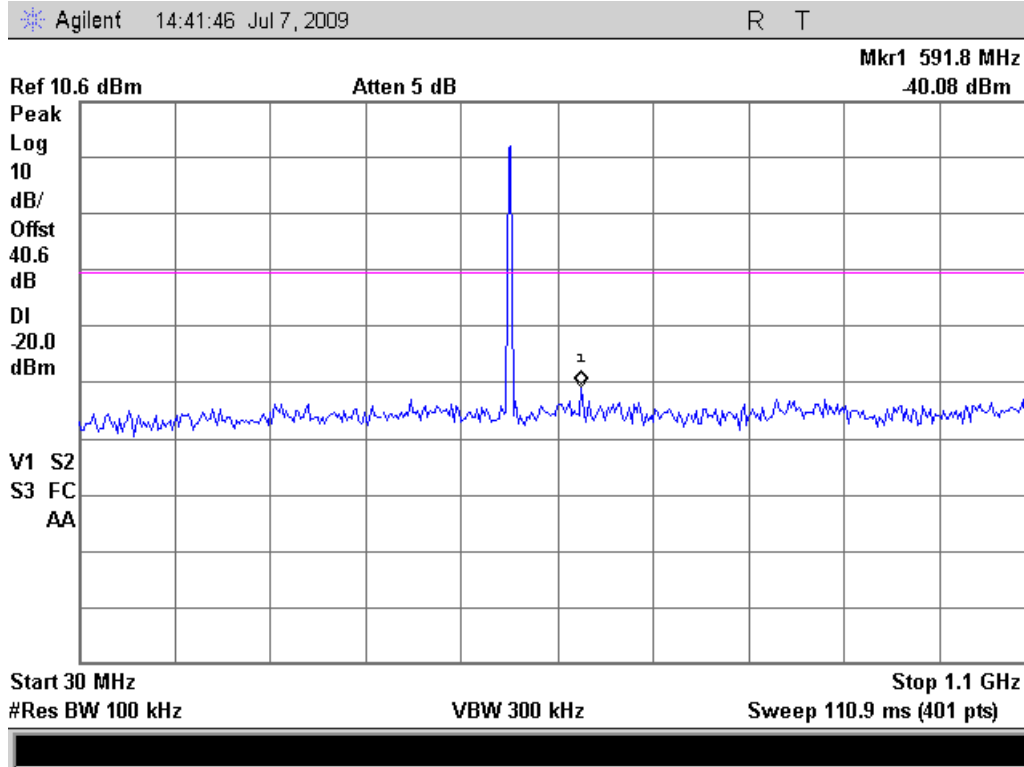

491.05 MHz (1 GHz – 5.5 GHz)

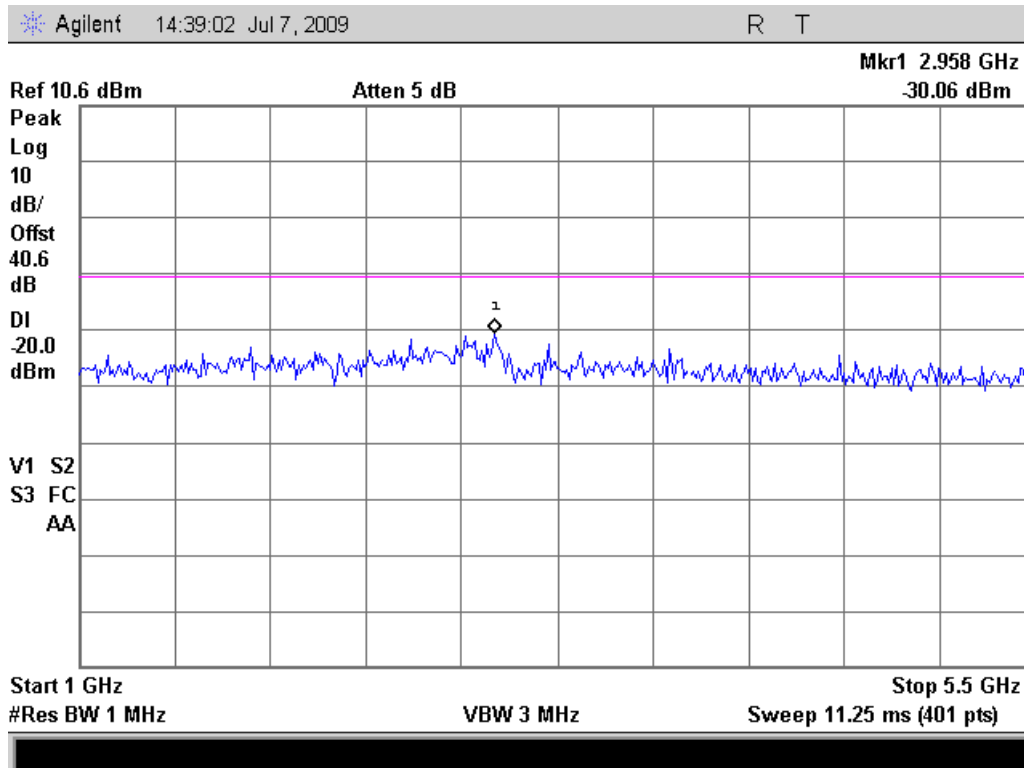

Name of Test: Field Strength of Spurious Radiation
Specification: 2.1053
Test Equipment Utilized: i00049, i00267, i00103

Engineer: G. Corbin
Test Date: 5/12/09

Test Procedure

- A) Connect the equipment as illustrated
- B) Adjust the spectrum analyzer for the following settings:
 - 1) Resolution Bandwidth 100 kHz (<1 GHz), 1 MHz (> 1GHz).
 - 2) Video Bandwidth ≥ 3 times Resolution Bandwidth, or 30 kHz
 - 3) Sweep Speed ≤ 2000 Hz/second
 - 4) Detector Mode = Mean or Average Power
- C) Place the transmitter to be tested on the turntable in the standard test site. The transmitter is transmitting into a non-radiating load that is placed on the turntable. The RF cable to this load should be of minimum length.
- D) For each spurious measurement the test antenna should be adjusted to the correct length for the frequency involved. This length may be determined from a calibration ruler supplied with the equipment. Measurements shall be made from the lowest radio frequency generated in the equipment to the tenth harmonic of the carrier, except for the region close to the carrier equal to \pm the test bandwidth (see section 1.3.4.4).
- E) For each spurious frequency, raise and lower the test antenna from 1 m to 4 m to obtain a maximum reading on the spectrum analyzer with the test antenna at horizontal polarity. Repeat this procedure to obtain the highest possible reading. Record this maximum reading.
- F) Repeat step E) for each spurious frequency with the test antenna polarized vertically.
- G) Reconnect the equipment as illustrated.
- H) Keep the spectrum analyzer adjusted as in step B).
- I) Remove the transmitter and replace it with a substitution antenna (the antenna should be half-wavelength for each frequency involved). The center of the substitution antenna should be approximately at the same location as the center of the transmitter. At lower frequencies, where the substitution antenna is very long, this will be impossible to achieve when the antenna is polarized vertically. In such case the lower end of the antenna should be 0.3 m above the ground.
- J) Feed the substitution antenna at the transmitter end with a signal generator connected to the antenna by means of a non-radiating cable. With the antennas at both ends horizontally polarized and with the signal generator tuned to a particular spurious frequency, raise and lower the test antenna to obtain a maximum reading at the spectrum analyzer. Adjust the level of the signal generator output until the previously recorded maximum reading for this set of conditions is obtained. This should be done carefully repeating the adjustment of the test antenna and generator output.
- K) Repeat step J) with both antennas vertically polarized for each spurious frequency.
- L) Calculate power in dBm into a reference ideal half-wave dipole antenna by reducing the readings obtained in steps J) and K) by the power loss in the cable between the generator and the antenna and further corrected for the gain of the substitution antenna used relative to an ideal half-wave dipole antenna.
- M) The levels recorded in step L) are absolute levels of radiated spurious emissions in dBm. The radiated spurious emissions in dB can be calculated by the following:

Radiated spurious emissions dB = $10\log_{10}(\text{TX power in watts}/0.001) - \text{the levels in step I)}$

NOTE: It is permissible that other antennas provided can be referenced to a dipole.

Test Setup

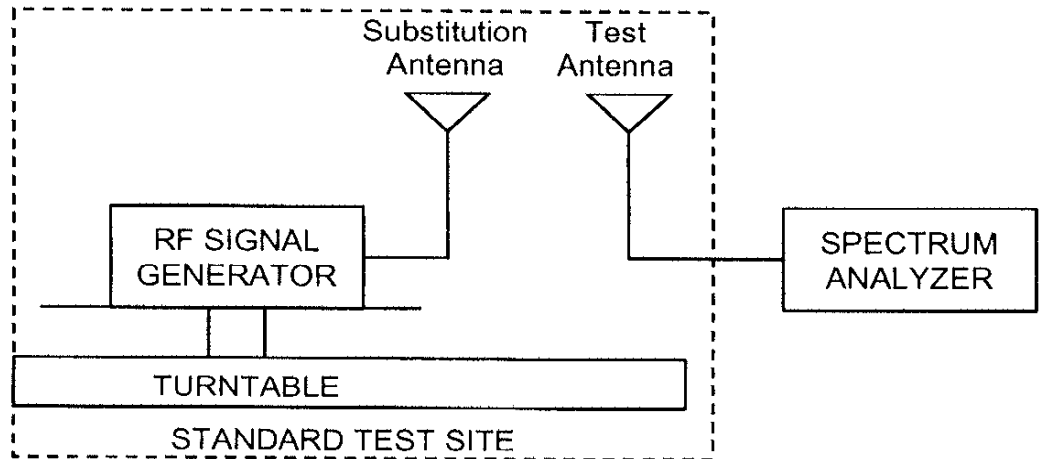
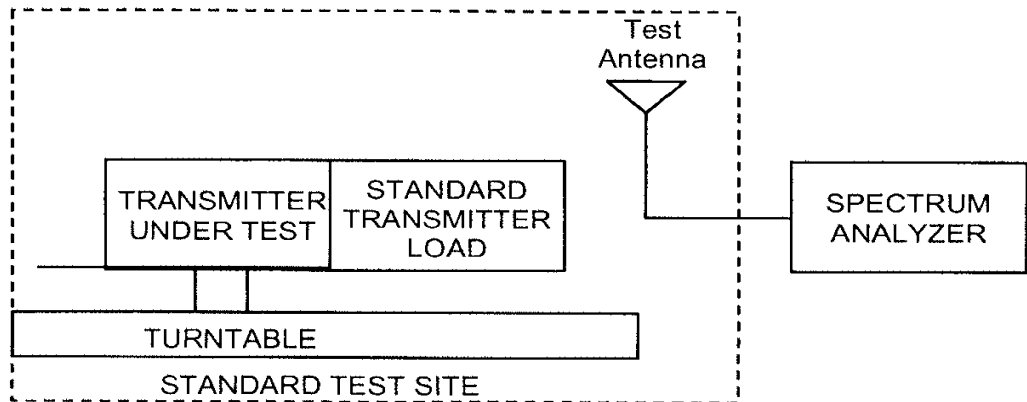

Test Results

KRA-15M2 Antenna 470.05 MHz (Part 90)

Power output = 26.1 dBm ERP

Emission Frequency (MHz)	Measured Level (dBm)	Correction Factor (dB)	Corrected Value (dBm)	Limit (dBm) ERP/EIRP	Result (dBc)
940.1	-58.4	28.7	-29.7	-13	-55.8
1410.15	-70.7	29.5	-41.2	-13	-67.3
1880.2	-71.4	31.2	-40.2	-13	-66.3
2350.25	-71.0	32.8	-38.2	-13	-64.3

KRA-15M2 Antenna 491.05 MHz (Part 90)

Power output = 27.2 dBm ERP

Emission Frequency (MHz)	Measured Level (dBm)	Correction Factor (dB)	Corrected Value (dBm)	Limit (dBm) ERP/EIRP	Result (dBc)
982.1	-57.7	28.8	-28.9	-13	-56.1
1473.15	-70.2	29.6	-40.6	-13	-67.8
1964.2	-68.7	31.5	-37.2	-13	-64.4
2455.25	-69.6	33.1	-36.5	-13	-63.7

KRA-15M2 Antenna 511.95 MHz (Part 90)

Power output = 28.4 dBm ERP

Emission Frequency (MHz)	Measured Level (dBm)	Correction Factor (dB)	Corrected Value (dBm)	Limit (dBm) ERP/EIRP	Result (dBc)
1023.9	-62.9	28.8	-34.1	-13	-62.5
1535.85	-70.6	29.8	-40.8	-13	-69.2
2047.8	-70.2	31.8	-38.4	-13	-66.8
2559.75	-69.8	33.4	-36.4	-13	-64.8

**KRA-23M2 Antenna
470.05 MHz (Part 90)**

Power output = 26.9 dBm ERP

Emission Frequency (MHz)	Measured Level (dBm)	Correction Factor (dB)	Corrected Value (dBm)	Limit (dBm) ERP/EIRP	Result (dBc)
940.1	-57.6	28.7	-28.9	-13	-55.8
1410.15	-68.0	29.5	-38.5	-13	-65.4
1880.2	-68.9	31.2	-37.7	-13	-64.6
2350.25	-69.7	32.8	-36.9	-13	-63.8

**KRA-23M2 Antenna
491.05 MHz (Part 90)**

Power output = 29.6 dBm ERP

Emission Frequency (MHz)	Measured Level (dBm)	Correction Factor (dB)	Corrected Value (dBm)	Limit (dBm) ERP/EIRP	Result (dBc)
982.1	-52.9	28.8	-24.1	-13	-53.7
1473.15	-66.2	29.6	-36.6	-13	-66.2
1964.2	-68.0	31.5	-36.5	-13	-66.1
2455.25	-67.6	33.1	-34.5	-13	-64.1

**KRA-23M2 Antenna
511.95 MHz (Part 90)**

Power output = 28.2 dBm ERP

Emission Frequency (MHz)	Measured Level (dBm)	Correction Factor (dB)	Corrected Value (dBm)	Limit (dBm) ERP/EIRP	Result (dBc)
1023.9	-64.3	28.8	-35.5	-13	-63.7
1535.85	-68.4	29.8	-38.6	-13	-66.8
2047.8	-70.0	31.8	-38.2	-13	-66.4
2559.75	-69.5	33.4	-36.1	-13	-64.3

**KRA-27M2 Antenna
470.05 MHz (Part 90)**

Power output = 26.5 dBm ERP

Emission Frequency (MHz)	Measured Level (dBm)	Correction Factor (dB)	Corrected Value (dBm)	Limit (dBm) ERP/EIRP	Result (dBc)
940.1	-67.5	28.7	-38.8	-13	-55.7
1410.15	-80.2	29.5	-50.7	-13	-67.6
1880.2	-79.5	31.2	-48.3	-13	-65.2
2350.25	-80.9	32.8	-48.1	-13	-65

**KRA-27M2 Antenna
491.05 MHz (Part 90)**

Power output = 27.6dBm ERP

Emission Frequency (MHz)	Measured Level (dBm)	Correction Factor (dB)	Corrected Value (dBm)	Limit (dBm) ERP/EIRP	Result (dBc)
982.1	-67.5	28.8	-38.7	-13	-56.7
1473.15	-77.4	29.6	-47.8	-13	-65.8
1964.2	-80	31.5	-48.5	-13	-66.5
2455.25	-78.6	33.1	-45.5	-13	-63.5

**KRA-27M2 Antenna
511.95 MHz (Part 90)**

Power output = 28.9 dBm ERP

Emission Frequency (MHz)	Measured Level (dBm)	Correction Factor (dB)	Corrected Value (dBm)	Limit (dBm) ERP/EIRP	Result (dBc)
1023.9	-74.2	28.8	-45.4	-13	-64.7
1535.85	-80	29.8	-50.2	-13	-69.5
2047.8	-80.4	31.8	-48.6	-13	-67.9
2559.75	-80.6	33.4	-47.2	-13	-66.5

Name of Test: Emission Masks (Occupied Bandwidth)
Specification: 90.210
Test Equipment Utilized: i00331

Engineer: G. Corbin
Test Date: 7/7/09

The EUT was connected directly to a spectrum analyzer to verify that the EUT meets the required emissions mask. A reference level plot is provided to verify that the peak power was established prior to testing the mask. A modulation frequency of 2.5 kHz at a level of 500 mVPP was input into the UUT for the analog tests and an internal test pattern was utilized for the digital input.

Test Setup

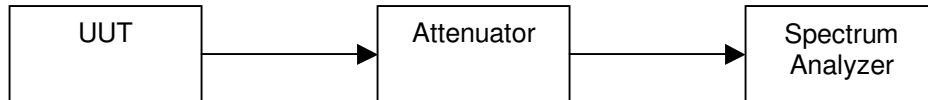

Necessary Bandwidth calculations

Modulation = 11K0F3E

Necessary Bandwidth Calculation:

Maximum Modulation (M), kHz	=	3
Maximum Deviation (D), kHz	=	2.5
Constant Factor (K)	=	1
Necessary Bandwidth (B _N), kHz	=	(2xM)+(2xDxK)
	=	11.0

Modulation = 16K0F3E

Necessary Bandwidth Calculation:

Maximum Modulation (M), kHz	=	3
Maximum Deviation (D), kHz	=	5
Constant Factor (K)	=	1
Necessary Bandwidth (B _N), kHz	=	(2xM)+(2xDxK)
	=	16.0

Occupied Bandwidth Plots

Reference Plot – 470.05 MHz

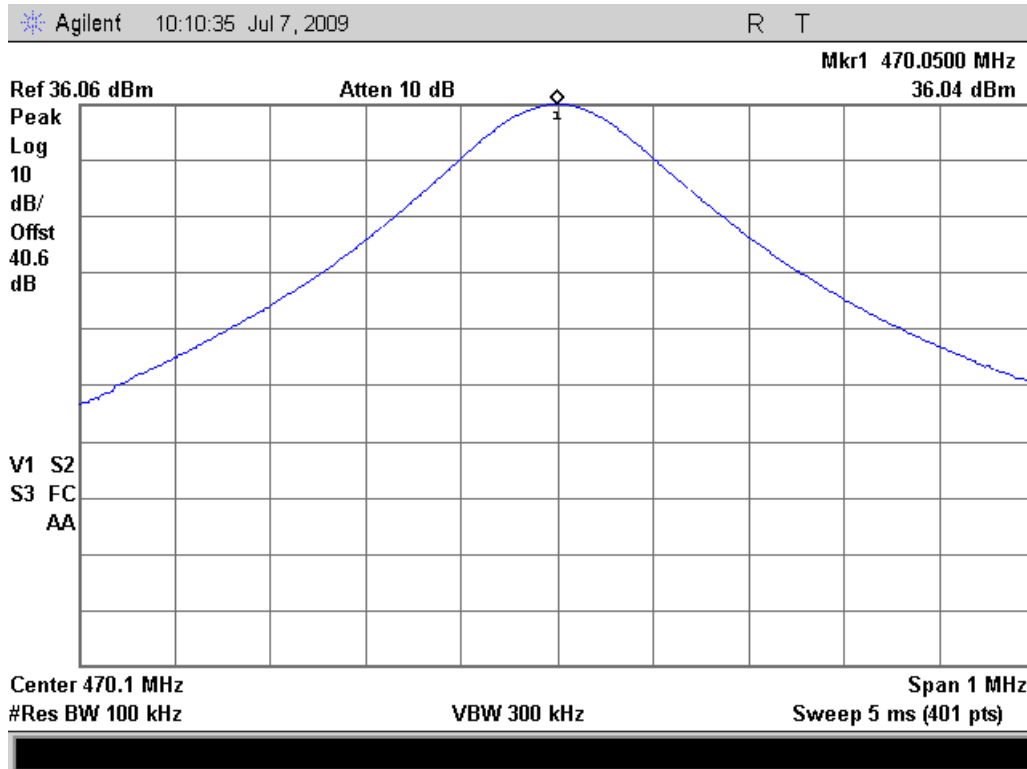

Emission Mask D – 470.05 MHz – 12.5 KHz BW (Part 90)

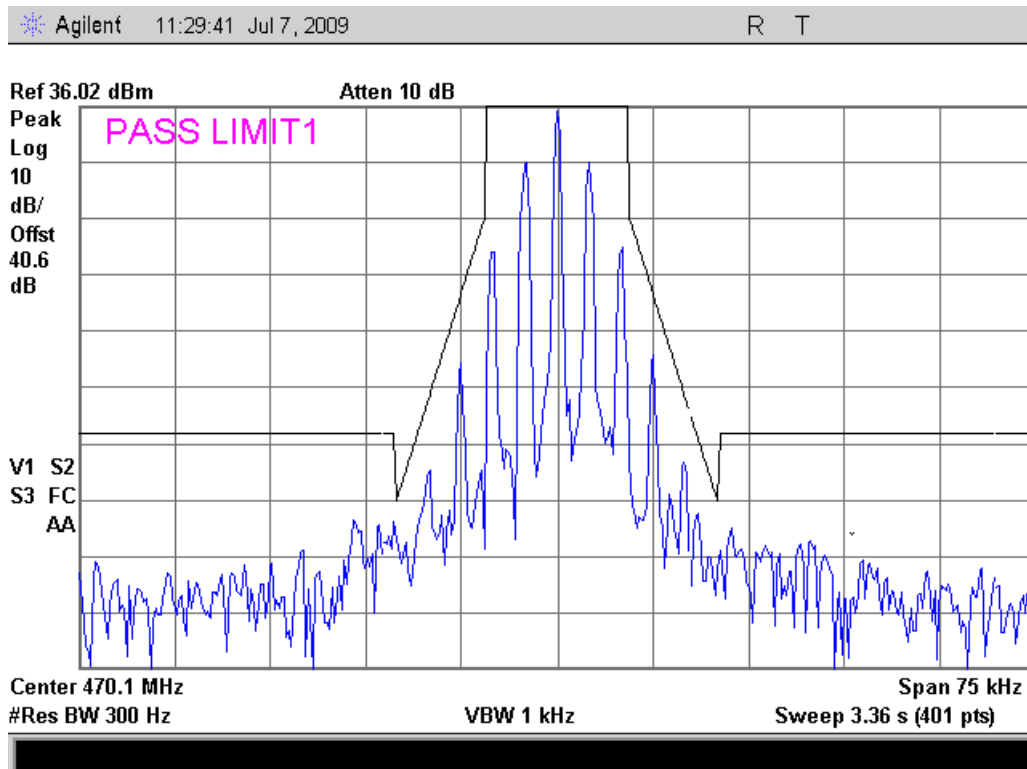

Emission Mask B – 470.05 MHz – 25 KHz BW (Part 90)

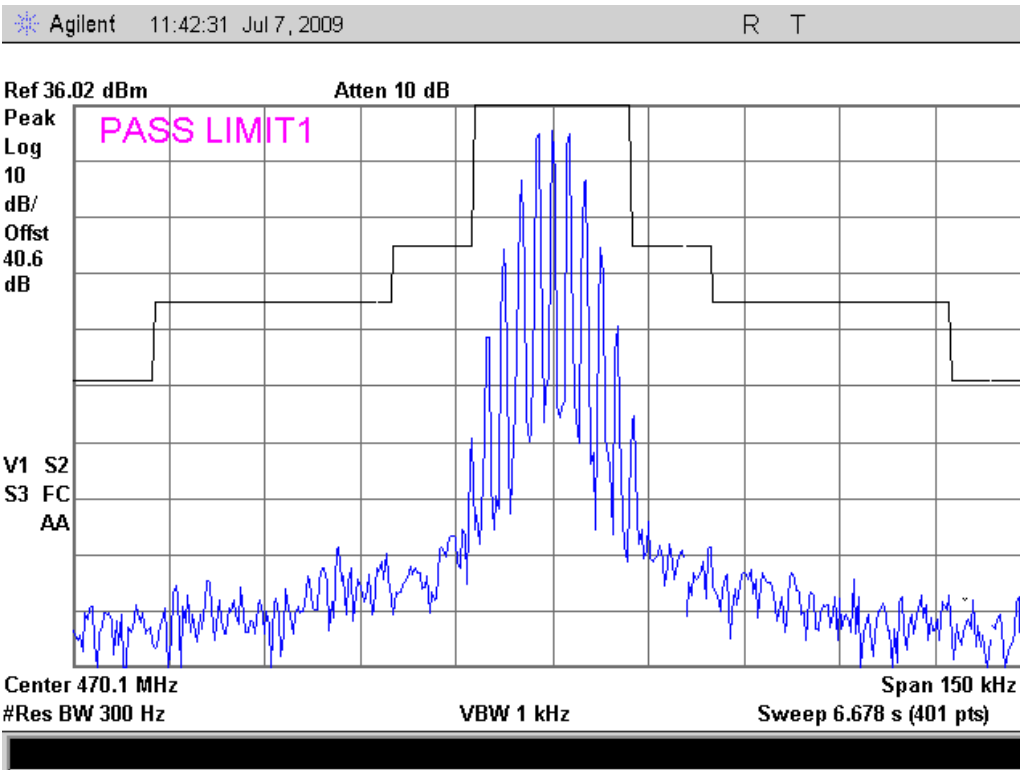

Reference Plot – 491 MHz

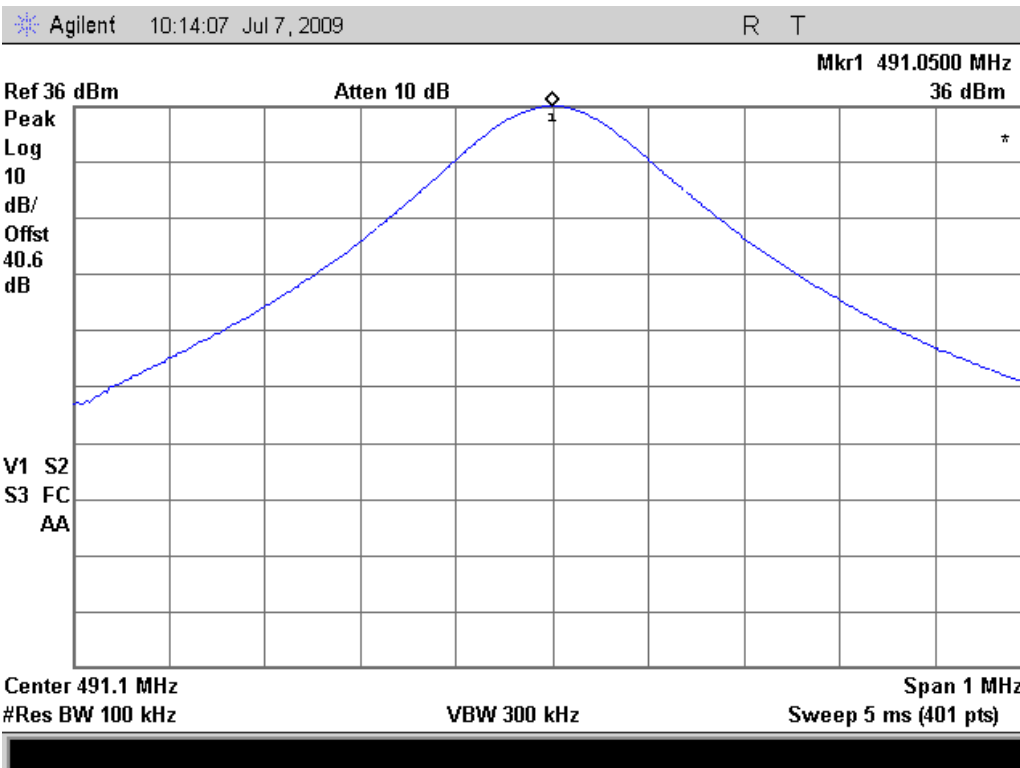

Emission Mask D – 491.05 MHz – 12.5 KHz BW (Part 90)

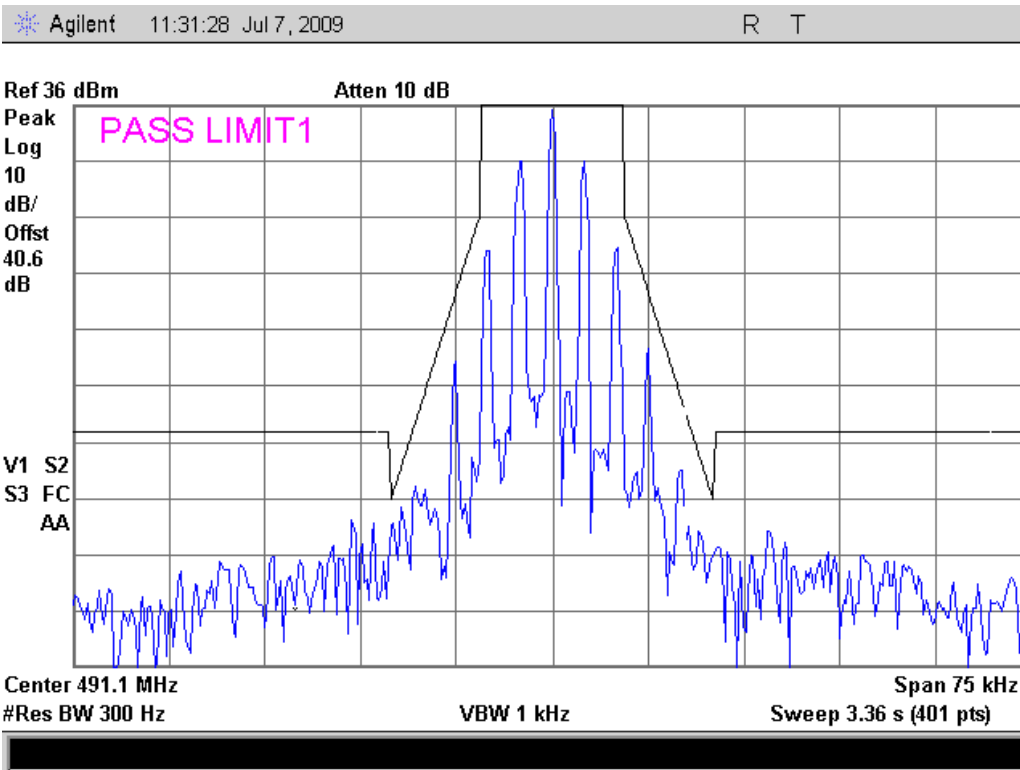

Emission Mask B – 491.05 MHz – 25 KHz BW (Part 90)

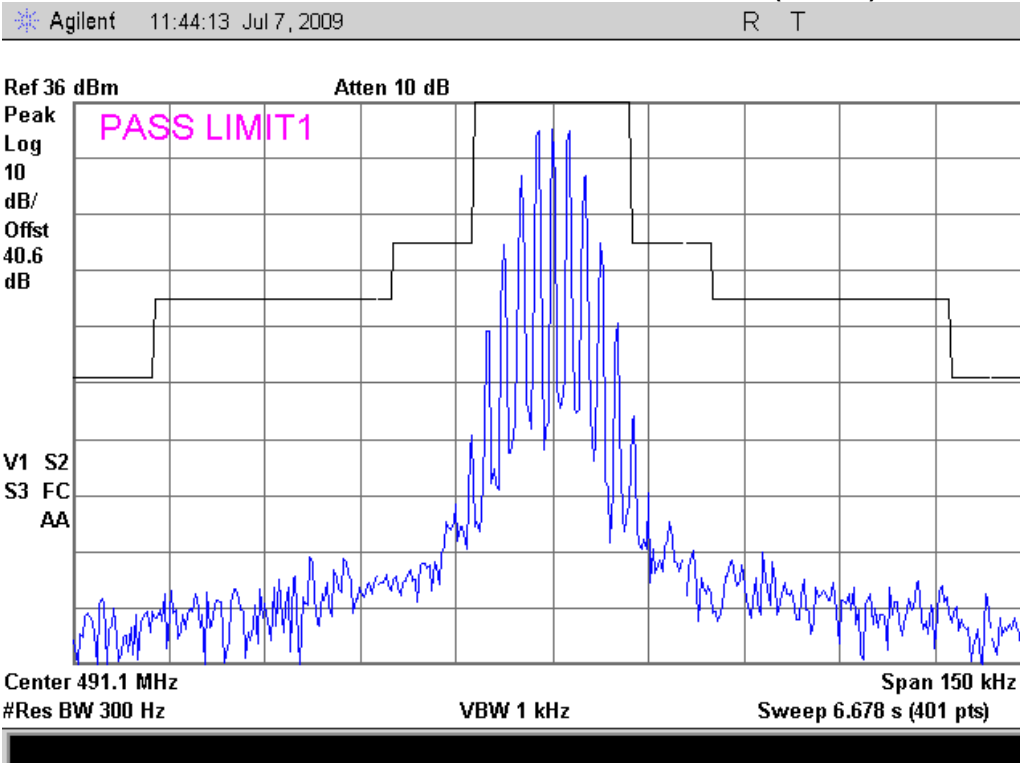

Reference Plot – 511.95 MHz

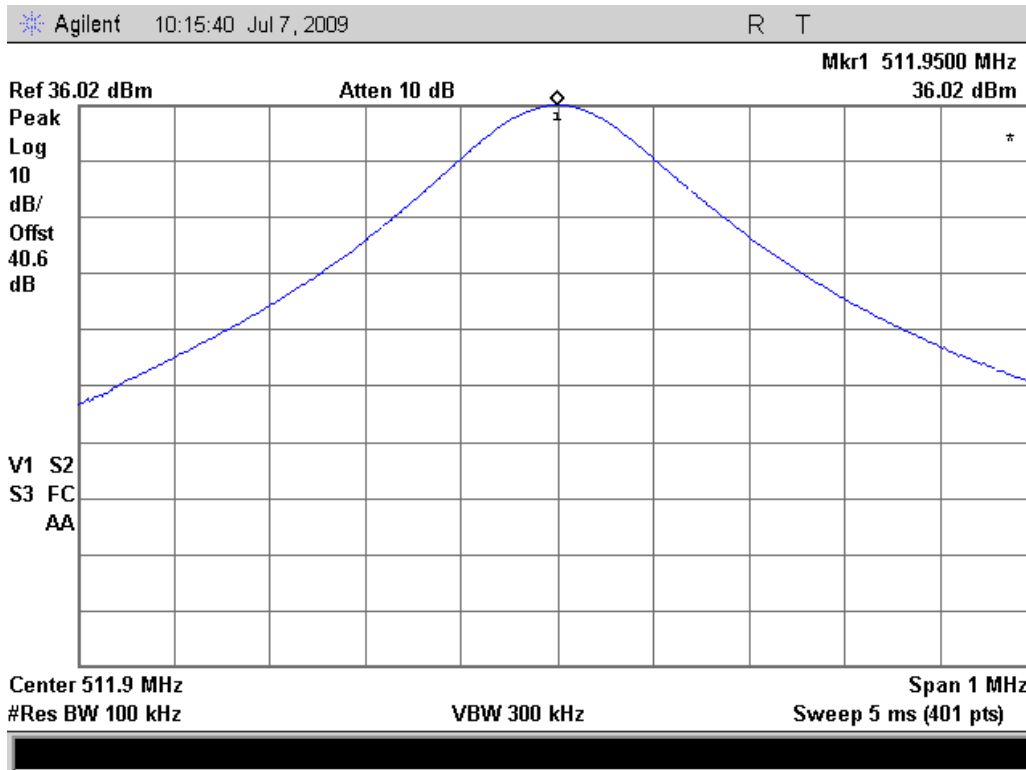

Emission Mask D – 511.95 MHz – 12.5 KHz BW (Part 90)

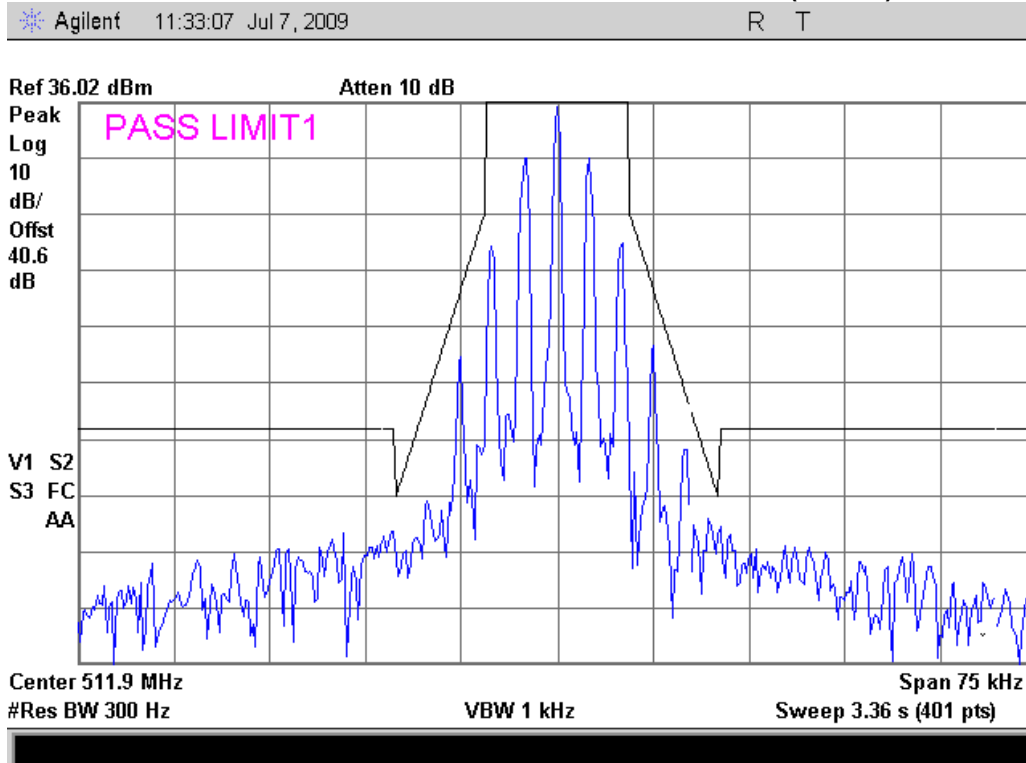

Emission Mask B – 511.95 MHz – 25 KHz BW (Part 90)

Agilent 11:45:16 Jul 7, 2009 R T

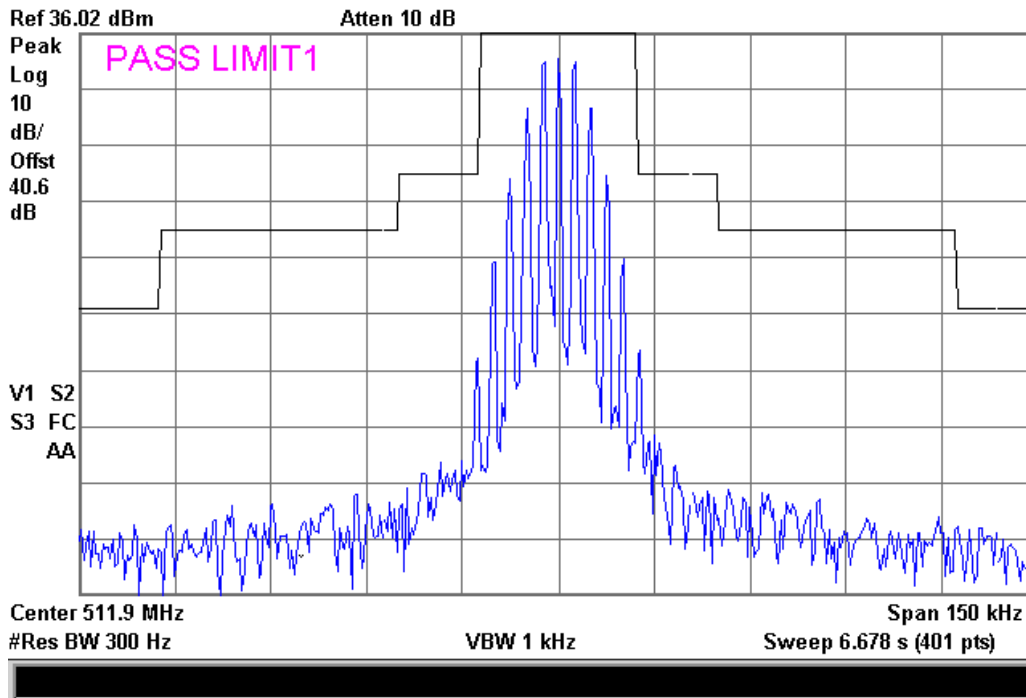

Name of Test: Transient Frequency Behavior
Specification: 90.214
Test Equipment Utilized: i00321, i00318, i00159

Engineer: G. Corbin
Test Date: 6/26/09

Measurement Procedure

The EUT was setup as shown with the following settings; Freq = 469.95 MHz, High power. The on / off times were recorded for both BW settings, 12.5 KHz and 25 KHz.
 The transmitter was keyed on and the Modulation Analyzer demodulated the signal providing the output to the oscilloscope. The oscilloscope was set-up to record the carrier on and off time.

Test Setup

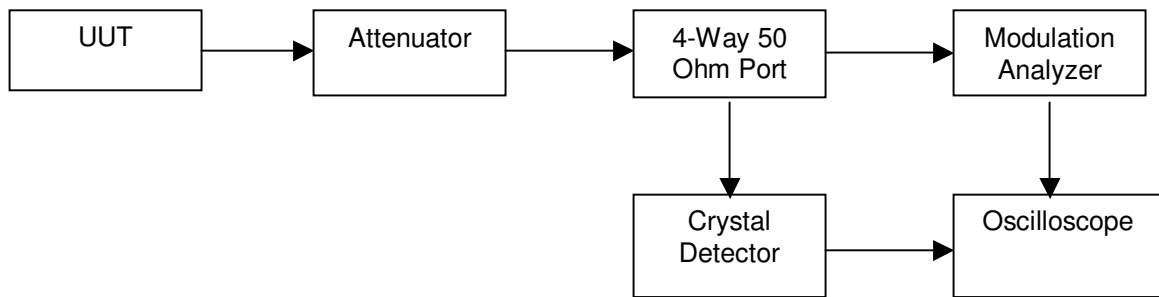

Test Results

On Time – 12.5 KHz BW

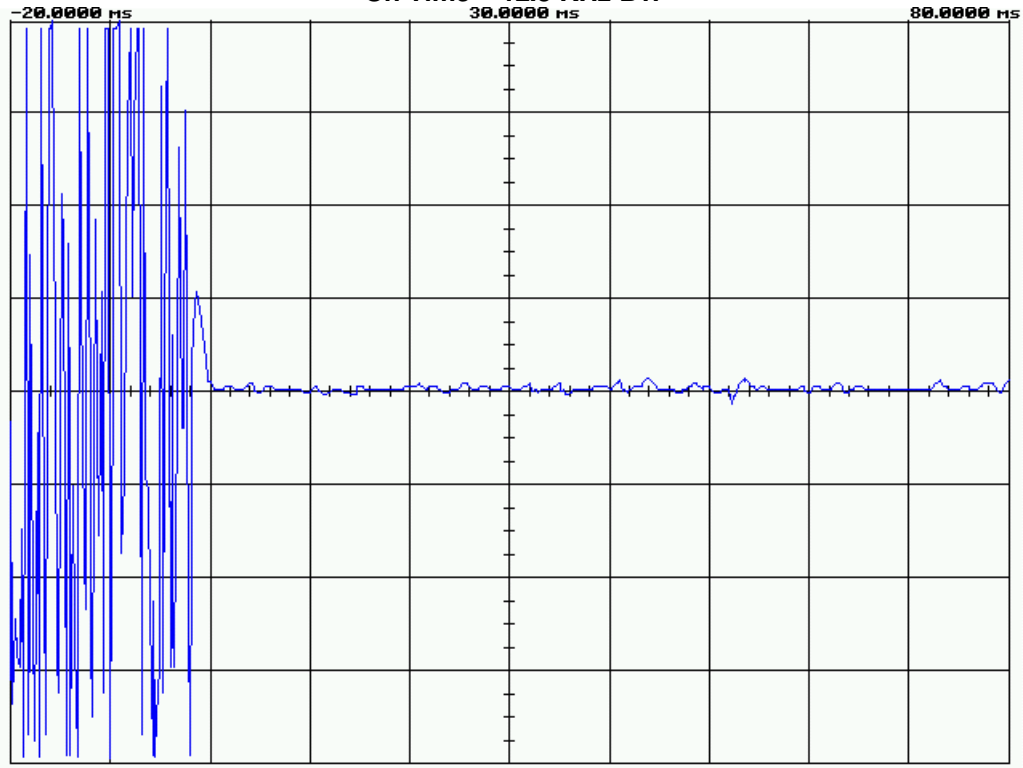

Off Time – 12.5 KHz BW

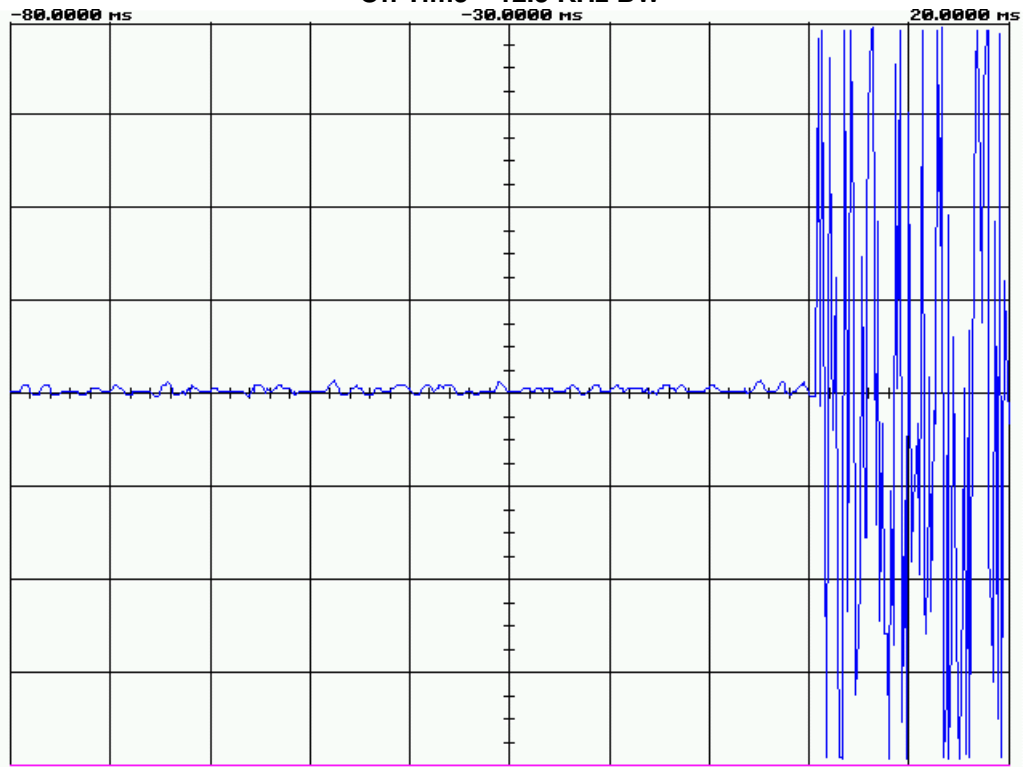

On Time – 25 KHz BW

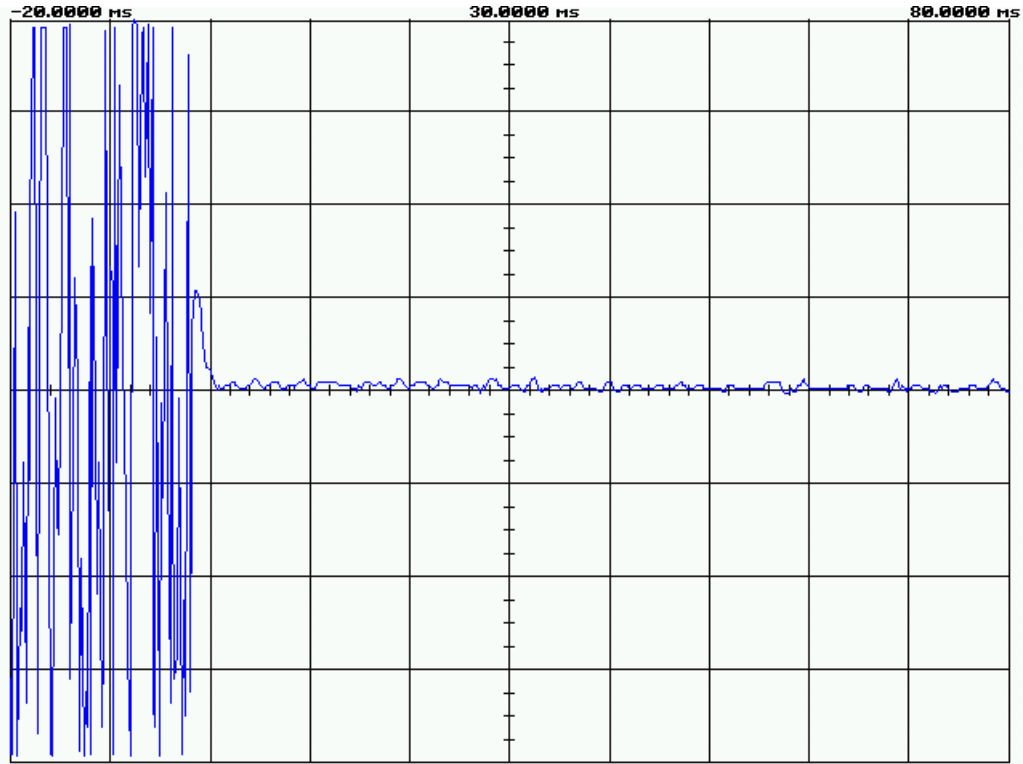

Off time – 25 KHz BW

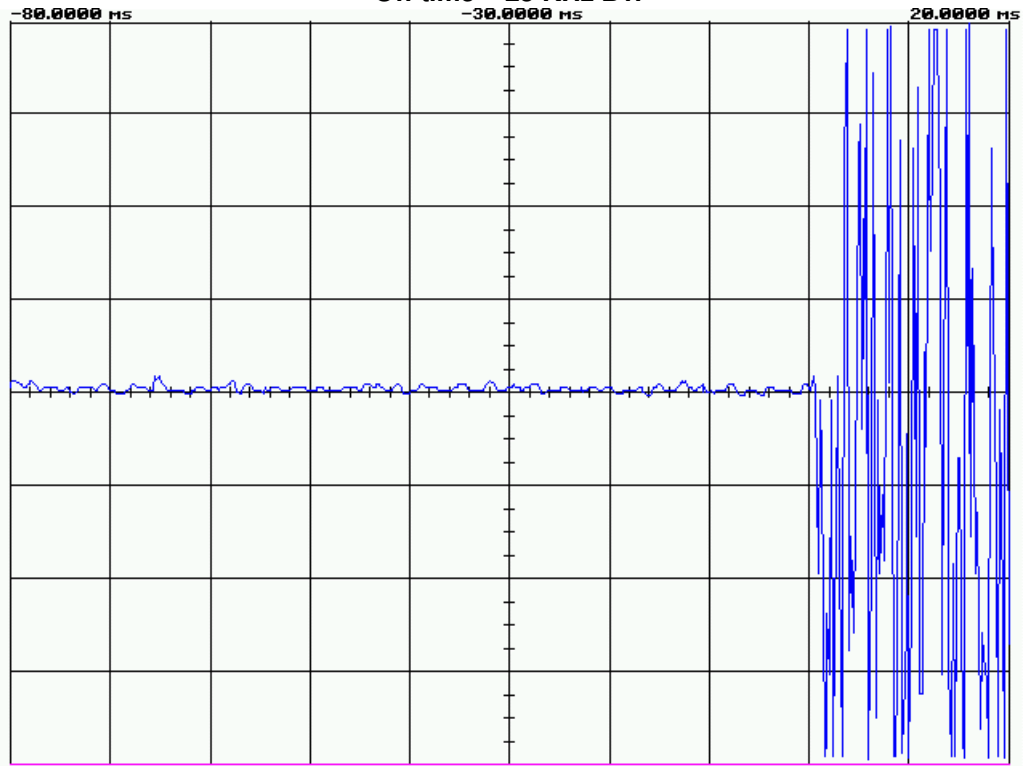

Name of Test: Audio Low Pass Filter (Voice Input)
2.1047
Test Equipment Utilized: i00321, i00324

Engineer: G. Corbin
Test Date: 7/7/09

Measurement Procedure

- A) The UUT and test equipment were set up such that the audio input was connected at the input to the modulation limiter, and the modulated stage.
- B) The audio output was connected at the output to the modulated stage.

Transmitter Test Set-Up

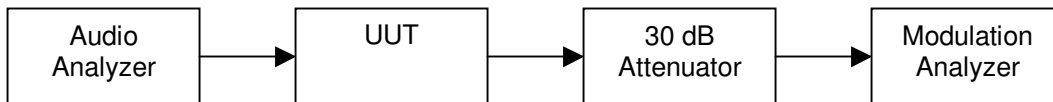

Low Pass Filter Measurement Results

12.5 KHz BW

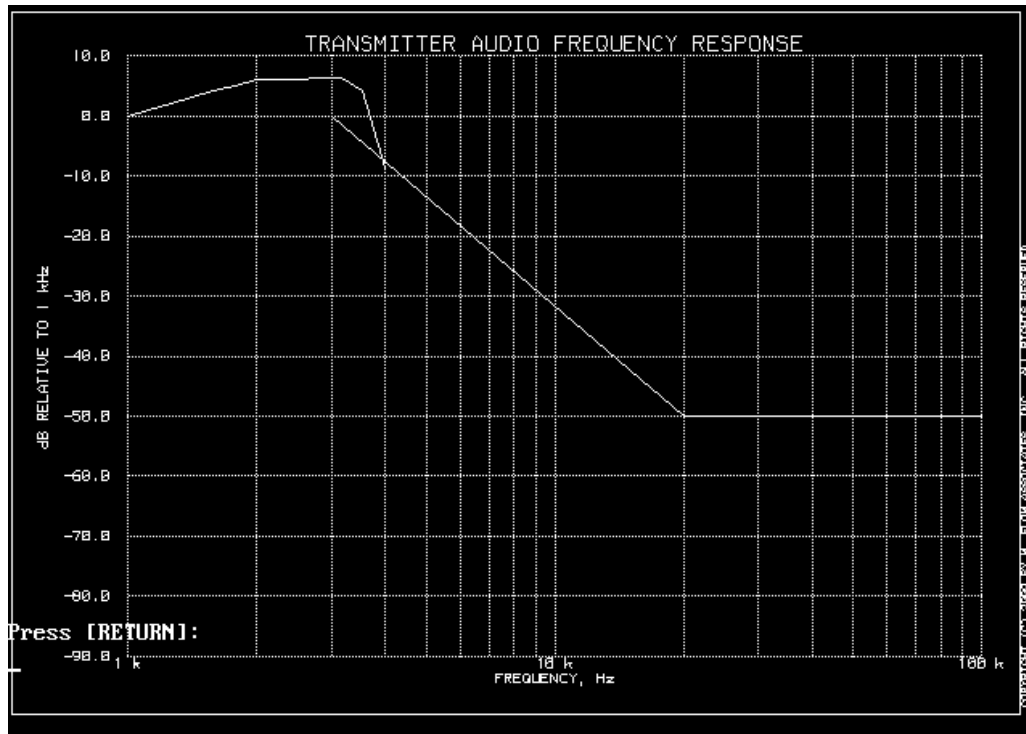

25 KHz BW

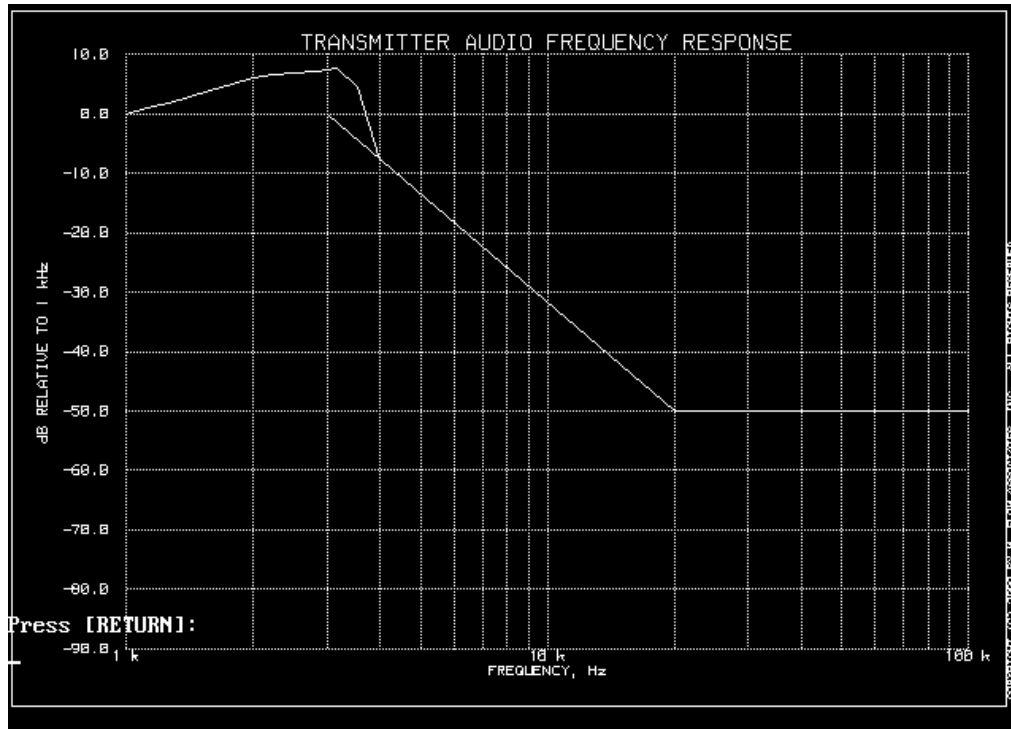

This unit is a digital radio and the roll-off for the filter is very linear in the operational band and sharp out of the band,

Name of Test: Audio Frequency Response
Specification: 2.1047
Test Equipment Utilized: i00321, i00324

Engineer: G. Corbin
Test Date: 7/7/09

Measurement Procedure

- A) The EUT and test equipment were set up as shown below.
- B) The audio signal generator was connected to the audio input circuit/microphone of the EUT.
- C) The audio signal input was adjusted to obtain 20% modulation at 1 kHz, and this point was taken as the 0 dB reference level.
- D) With input levels held constant and below limiting at all frequencies, the audio signal generator was varied from 100 Hz to 50 kHz.
- E) The response in dB relative to 1 kHz was measured, using the HP 8901A Modulation Meter.

Test Setup

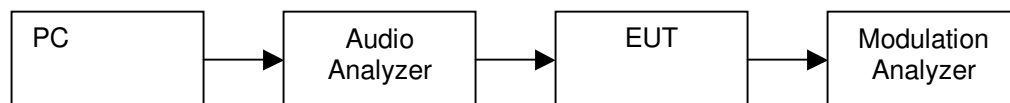

Audio Frequency Response Test Results

12.5 KHz BW



25 KHz BW

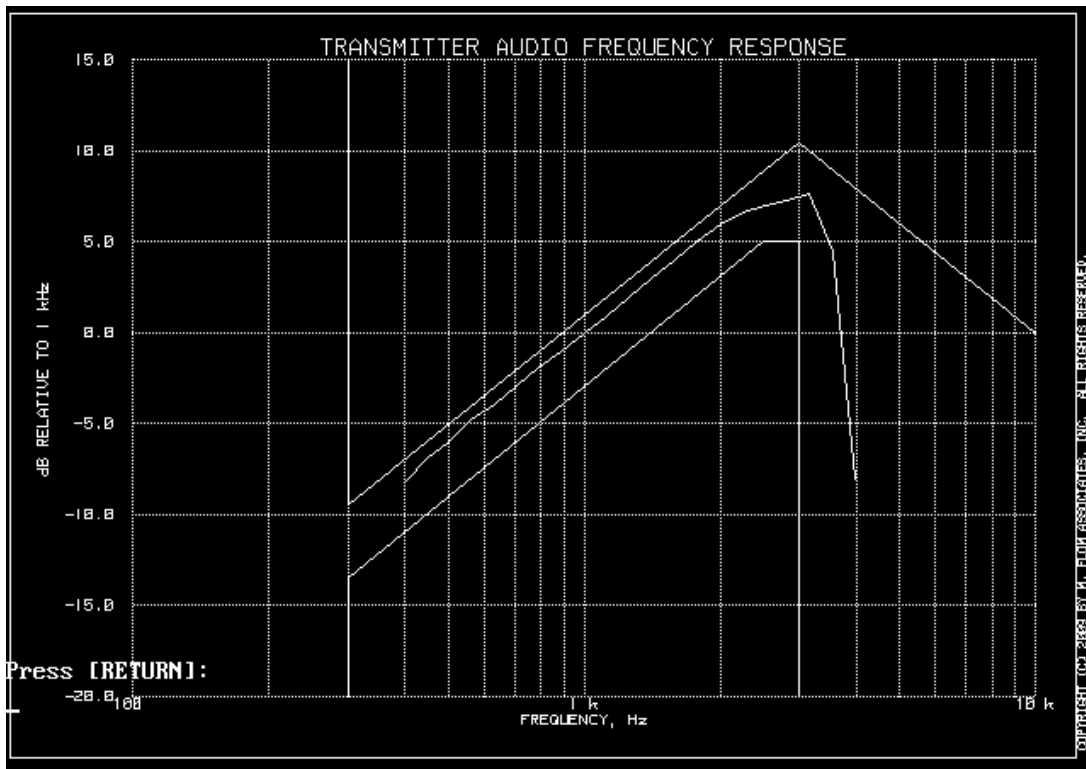

Name of Test: Modulation Limiting
Specification: 2.1047(a)
Test Equipment Utilized: i00321, i00324

Engineer: G. Corbin
Test Date: 7/7/09

Measurement Procedure

- A) The signal generator was connected to the input of the EUT as shown below.
- B) The modulation response was measured for each of three frequencies (one of which was the frequency of maximum response), and the input voltage was varied and was observed on an HP 8901A Modulation Analyzer.
- C) The input level was varied from 30% modulation (± 1.5 kHz deviation) to at least 20 dB higher than the saturation point.
- D) Measurements were performed for both negative and positive modulation and the respective results were recorded.

Test Setup

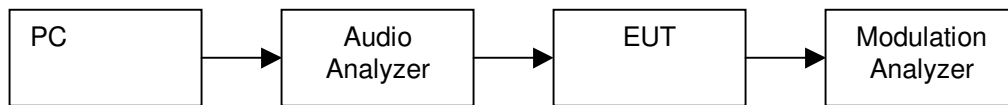

Swept Frequency – Positive Peaks – 12.5 KHz BW

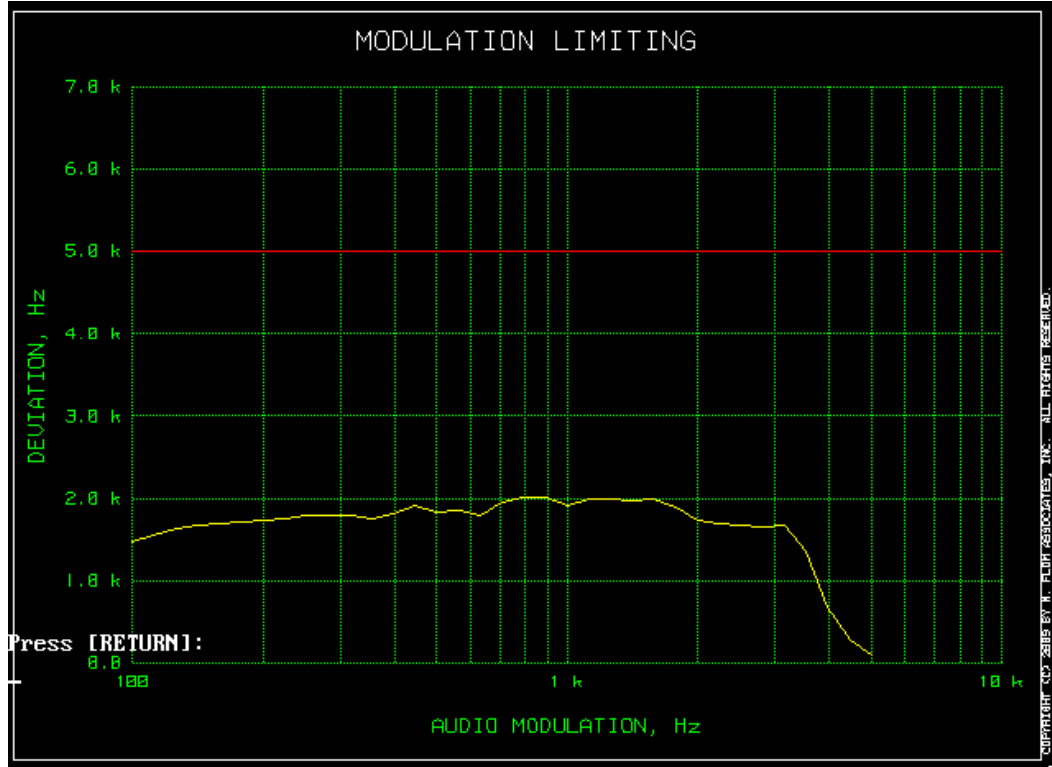

Swept Frequency – Negative Peaks – 12.5 KHz BW



Swept Amplitude – Positive Peaks – 12.5 KHz BW

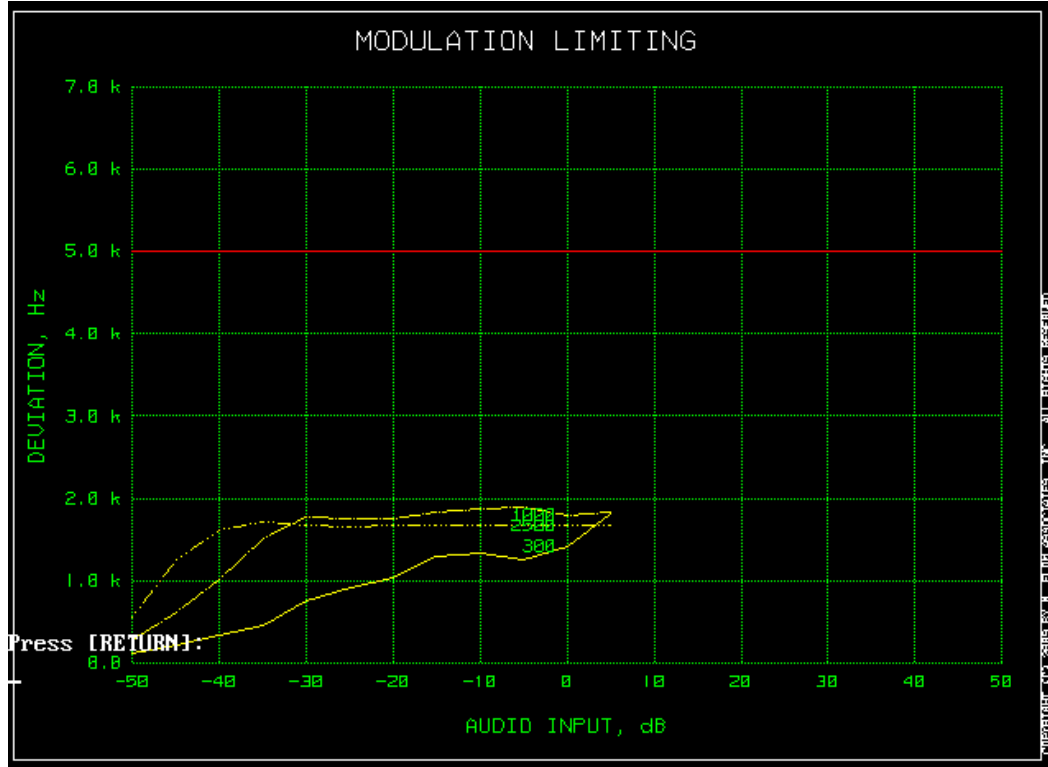

Swept Amplitude – Negative Peaks – 12.5 KHz BW

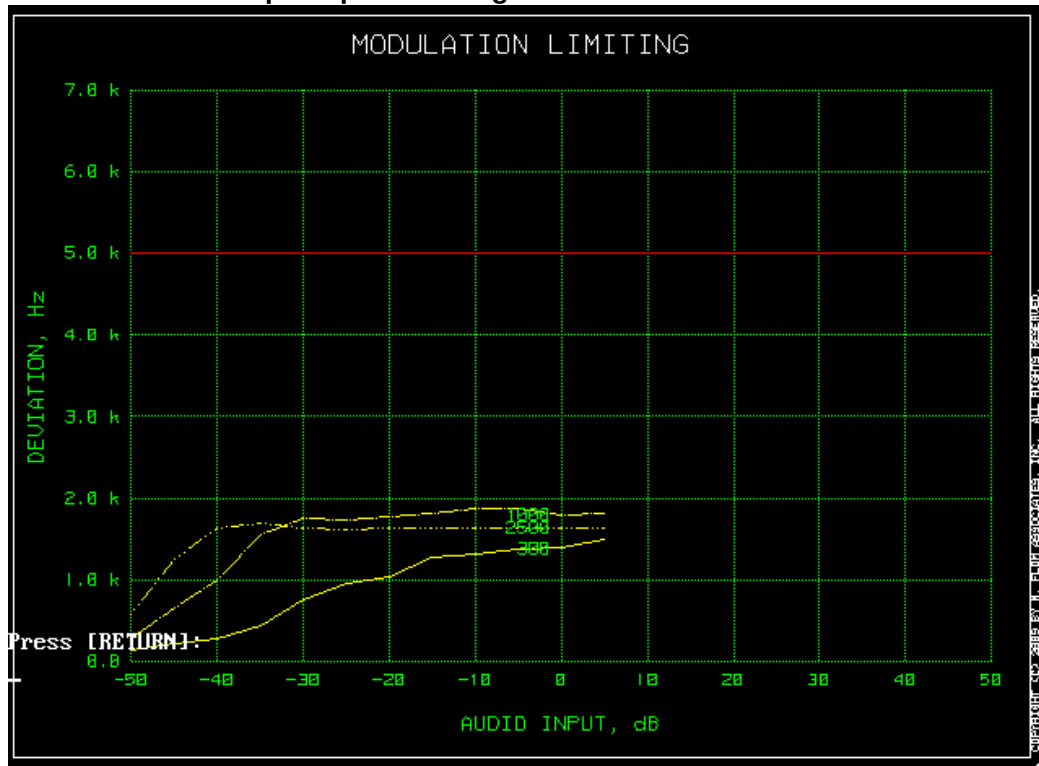

Swept Frequency – Positive Peaks – 25 KHz BW



Swept Frequency – Negative Peaks – 25 KHz BW

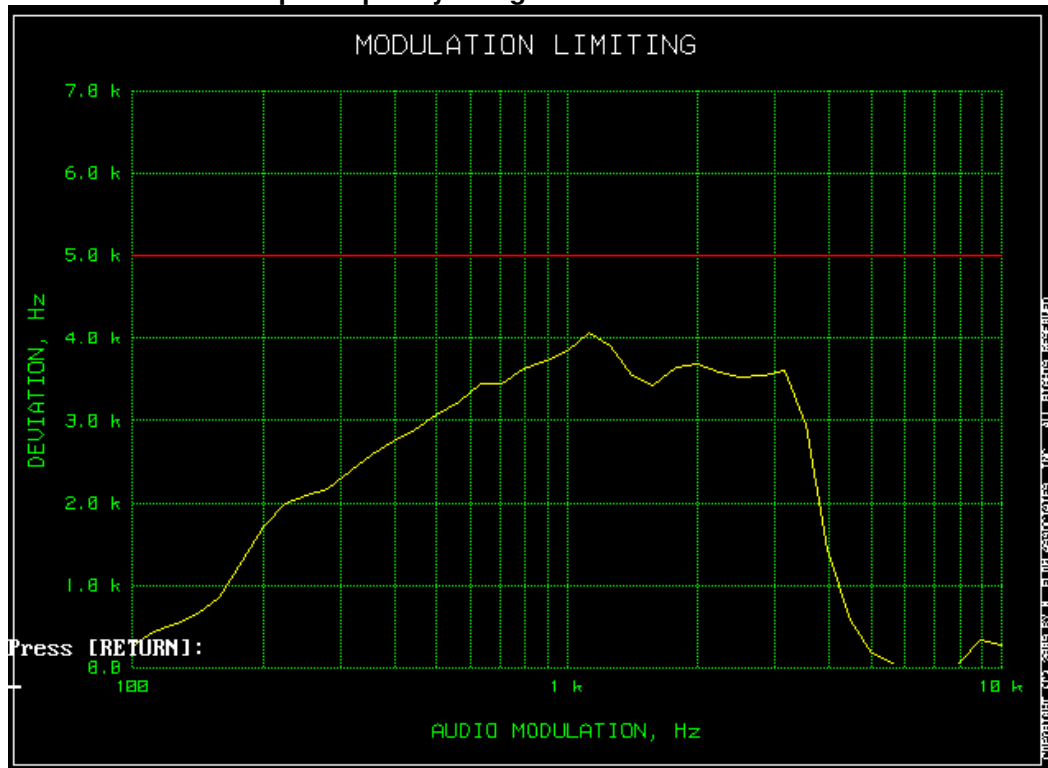

Swept Amplitude – Positive Peaks – 25 KHz BW

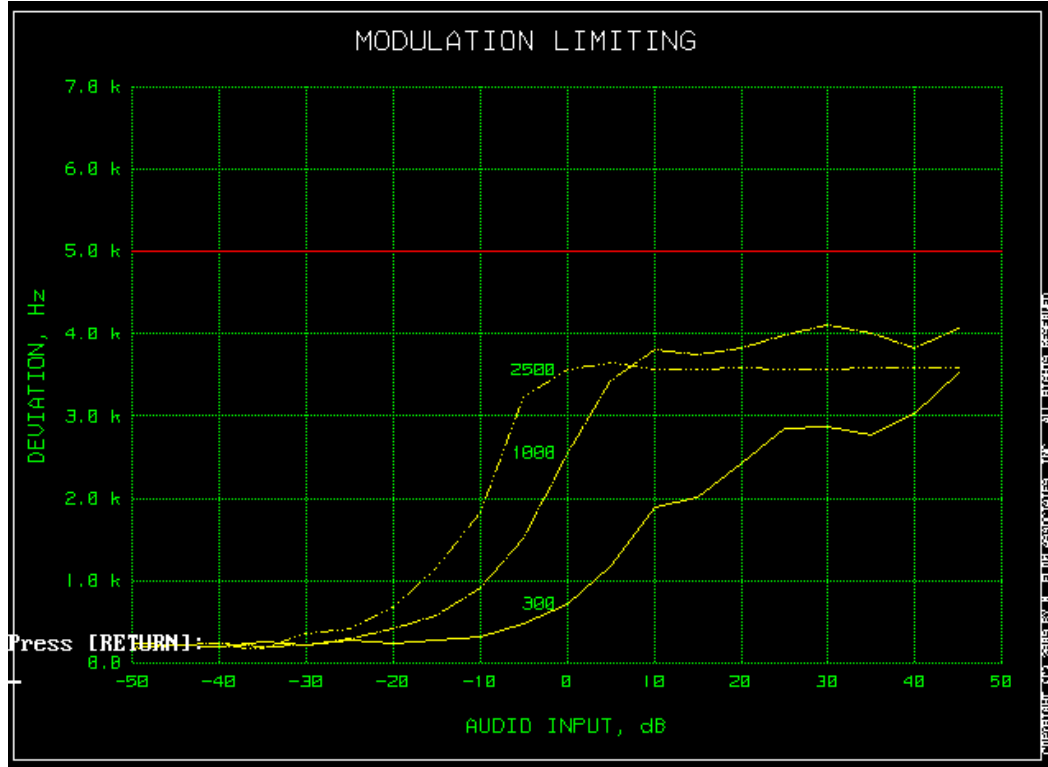

Swept Amplitude – Negative Peaks – 25 KHz BW



Name of Test: Frequency Stability (Temperature Variation)
Specification: 90.213 **Engineer:** G. Corbin
Test Equipment Utilized: i00019, i00027 **Test Date:** 6/5/09

Measurement Procedure

The EUT was placed in an environmental test chamber and the RF output was connected directly to a frequency counter. The temperature was varied from -30°C to 50°C in 10°C increments. After a sufficient time for temperature stabilization the RF output frequency was measured.

Measurement Setup

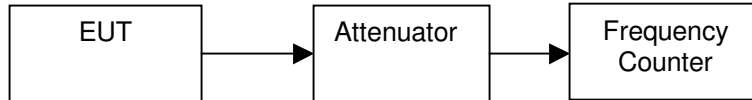

Measurement Results

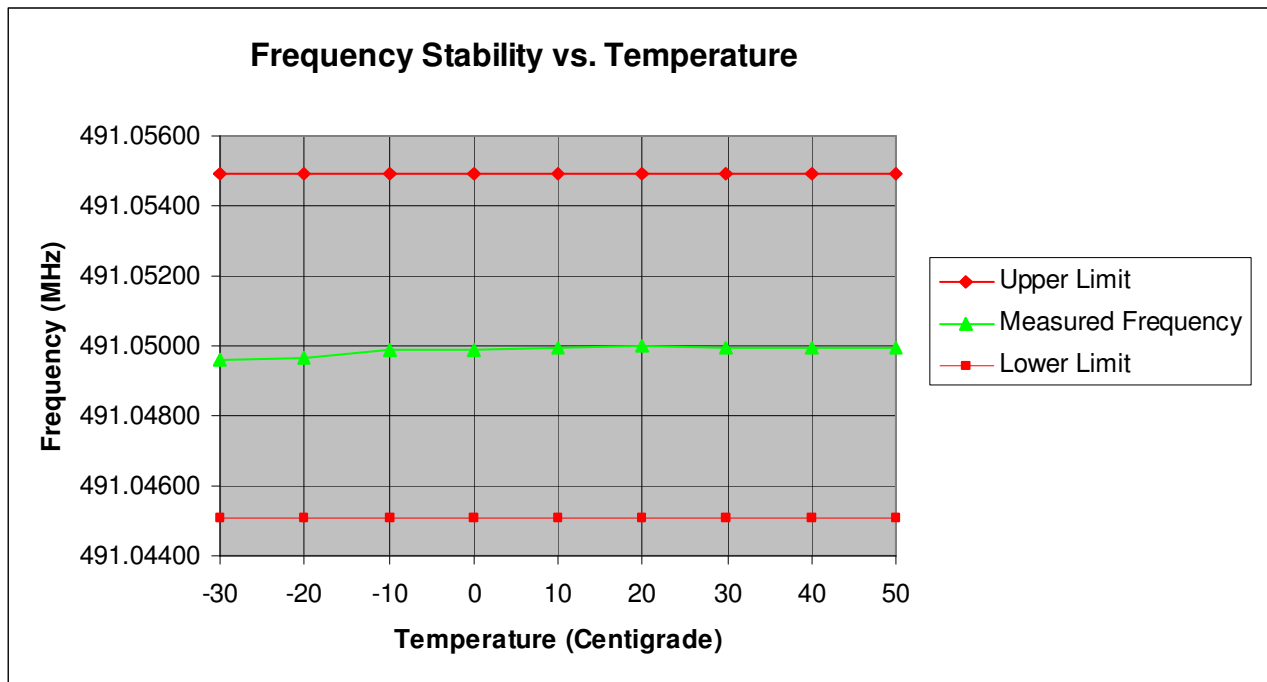

Name of Test: Frequency Stability (Voltage Variation)
Specification: 90.213
Test Equipment Utilized: i00019, i00319, i00027

Engineer: G. Corbin
Test Date: 6/5/09

Measurement Procedure

The EUT was placed in a temperature chamber at 25±5°C and connected directly to a frequency counter and variable power supply. The power supply voltage to the EUT was varied from 85% to 115% of the nominal value and the RF output was measured.

Measurement Setup

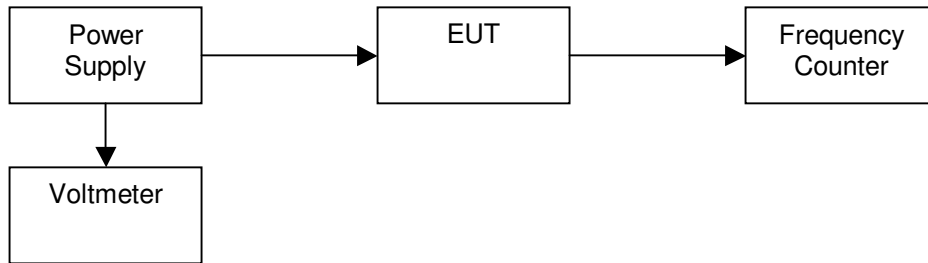

Measurement Results

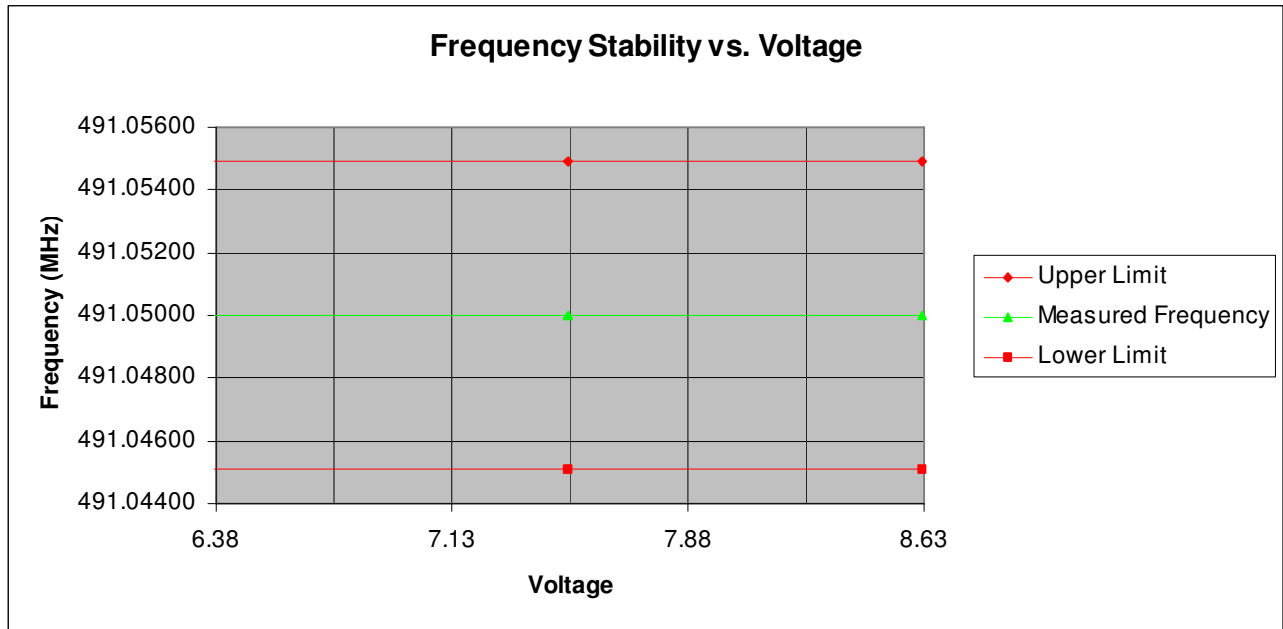

Test Equipment Utilized

Description	MFG	Model Number	FTL Asset Number	Last Cal Date	Cal Due Date
Power Supply	HP	6286A	i00054	NCR	NCR
Power Supply	Kenwood	PR18-3A	i00008	NCR	NCR
Temperature Chamber	Tenney	Tenney Jr.	i00027	12/8/08	12/08/09
Monopole Antenna Set	Ailtech	DM-105A-T1, T2, T3	i0003, 39, 42, 48	Verified	Verified
Spectrum Analyzer	HP	8566B	i00049	8/22/08	8/22/09
Bi Con Antenna	EMCO	3109B	i00088	10/15/07	10/15/09
Log Periodic Antenna	Apral	2001	i00089	10/22/07	10/22/09
Horn Antenna	EMCO	3115	i00103	11/25/08	11/25/10
Tunable Notch Filter	Eagle	TNF-1	i00124	NCR	NCR
Crystal Detector	HP	8472B	i00159	NCR	NCR
Power Meter	HP	E4418B	i00228	10/1/08	10/1/09
Signal Generator	R&S	SMT-03	i00266	NCR	NCR
Power sensor	HP	8485A	i00344	9/30/08	9/30/09
Digitizing Oscilloscope	HP	54502	i00318	1/30/09	1/30/10
Modulation Analyzer	HP	8901A	i00321	2/5/09	2/5/10
Audio Analyzer	HP	8903A	i00324	10/27/08	10/27/09
Spectrum analyzer	Textronix	RSA3308A	i00345	10/16/08	10/16/09
Bi Log Antenna	Schaffner	CBL6111C	i00267	11/7/07	11/6/09
Signal Generator	Agilent	E4438C	i00348	NCR	NCR
Spectrum Analyzer	Agilent	E4407B	i00331	11/3/08	11/3/09
Frequency Counter	HP	5334B	i00019	1/9/09	1/9/10
Voltmeter	Fluke	87III	i00319	12/5/08	12/5/09

In addition to the above listed equipment standard RF connectors and cables were utilized in the testing of the described equipment. Prior to testing these components were tested to verify proper operation.

END OF TEST REPORT