

PAGE NO. 1 of 41.

Required information per ISO/IEC Guide 25-1990, paragraph 13.2:

- a) TEST REPORT
- b) Laboratory: M. Flom Associates, Inc.
(FCC: 31040/SIT) 3356 N. San Marcos Place, Suite 107
(Canada: IC 2044) Chandler, AZ 85224
- c) Report Number: d9990036
- d) Client: Kenwood Communications Corporation
P.O. Box 22745
Long Beach, CA 90801-5745
- e) Identification: TKR-740-3
FCC ID: ALH30633130
Description: VHF FM Repeater
- f) EUT Condition: Not required unless specified in individual tests.
- g) Report Date: September 10, 1999
EUT Received: August 12, 1999
- h, j, k): As indicated in individual tests.
- i) Sampling method: No sampling procedure used.
- l) Uncertainty: In accordance with MFA internal quality manual.
- m) Supervised by: 
William H. Graff, Director
of Engineering
- n) Results: The results presented in this report relate only to the item tested.
- o) Reproduction: This report must not be reproduced, except in full, without written permission from this laboratory.

PAGE NO. 2 of 41.

LIST OF GENERAL INFORMATION REQUIRED FOR CERTIFICATION

IN ACCORDANCE WITH FCC RULES AND REGULATIONS,
VOLUME II, PART 2 AND TO

22, 74, 80, 90, 97

Sub-part 2.1033

(c) (1): NAME AND ADDRESS OF APPLICANT:

Kenwood Communications Corporation
2201 E. Dominguez St
P.O. Box 22745
Long Beach, CA 90801-5745

MANUFACTURER:

Kenwood Corporation
14-6, Dogenzaka 1-Chome
Shibuya-ku, Tokyo 150, Japan

(c) (2): FCC ID: ALH30633130

MODEL NO: TKR-740-3

(c) (3): INSTRUCTION MANUAL(S):

PLEASE SEE ATTACHED EXHIBITS

(c) (4): TYPE OF EMISSION: 16K0F3E, 11K0F3E

(c) (5): FREQUENCY RANGE, MHz: 136 to 174

(c) (6): POWER RATING, Watts: 0.1 to 5
___ Switchable ___ x Variable ___ N/A

(c) (7): MAXIMUM POWER RATING, Watts: 300

M. Flom Associates, Inc. is accredited by the American Association for Laboratory Association (A2LA) as shown in the scope below.



THE AMERICAN ASSOCIATION FOR LABORATORY ACCREDITATION

ACCREDITED LABORATORY

A2LA has accredited

M. FLOM ASSOCIATES, INC.
Chandler, AZ

for technical competence in the field of

Electrical (EMC) Testing

The accreditation covers the specific tests and types of tests listed on the agreed scope of accreditation. This laboratory meets the requirements of ISO/IEC Guide 25:1990 "General Requirements for the Competence of Calibration and Testing Laboratories" (equivalent to relevant requirements of the ISO 9000 series of standards) and any additional program requirements in the identified field of testing.

Presented this 24th day of November, 1998.



Peter Almy
President
For the Accreditation Council
Certificate Number 1008.01
Valid to December 31, 2000

For tests or types of tests to which this accreditation applies, please refer to the laboratory's Electrical (EMC) Scope of Accreditation.



American Association for Laboratory Accreditation

SCOPE OF ACCREDITATION TO ISO/IEC GUIDE 25:1990 AND EN 45001

M. FLOM ASSOCIATES, INC.
Electronics Testing Laboratory
3156 North Guadalupe Place, Suite 107
Chandler, AZ 85226-1371
Martin Flom Phone: 602.926.3160

ELECTRICAL (EMC)

Valid to: December 31, 2000 Certificate Number: 1008-01

In recognition of the successful completion of the A2LA evaluation process, accreditation is granted to the laboratory to perform the following **ELECTROMAGNETIC INTERFERENCE** tests:

Test	Standards
RF Immunity	FCC Part 15 (Subpart B and C) using ANSI C63.4-1992; CISPR 11, CISPR 12, CISPR 14, CISPR 22, EN 55011, EN 55013, EN 55014, EN 55022, EN 14001-1; EN 50011-2, FCC Part 18, MIL-STD-883C 1044; AS/NZS 1044; AS/NZS 1055; AS/NZS 3541, AS/NZS 4251.1
RF Emission	EN 55002-1; EN 55002-2; AS/NZS 4251.1
Radiated Susceptibility	EN 61000-4-3; IECV 50140; ENV 50204; IEC 1000-4-3; IEC 101-3
ESD	EN 61000-4-2 IEC 1000-4-2; IEC 801-2
EFT	EN 61000-4-4; IEC 1000-4-4; IEC 801-4
Surge	EN 61000-4-5; ENV 50142; IEC 1000-4-5; IEC 801-5
IEC/EN (PCE)	2, 11, 21, 22, 24, 24, 80, 87, 90, 95, 97

Peter Almy

5301 Rustydown Pike, Suite 350 • Frederick, MD 21784-8397 • Phone: 301 644 5388 • Fax: 301 662 2974

"This laboratory is accredited by the American Association for Laboratory Accreditation (A2LA) and the results shown in this report have been determined in accordance with the laboratory's terms of accreditation unless stated otherwise in the report."

Should this report contain any data for tests for which we are not accredited, or which have been undertaken by a subcontractor that is not A2LA accredited, such data would not covered by this laboratory's A2LA accreditation.

PAGE NO.

4 of 41.

Subpart 2.1033 (continued)

(c) (8): VOLTAGES & CURRENTS IN ALL ELEMENTS IN FINAL R. F. STAGE,
INCLUDING FINAL TRANSISTOR OR SOLID STATE DEVICE:

COLLECTOR CURRENT, A = per manual
COLLECTOR VOLTAGE, Vdc = per manual
SUPPLY VOLTAGE, Vdc = 13.8

(c) (9): TUNE-UP PROCEDURE:

PLEASE SEE ATTACHED EXHIBITS

(c) (10): CIRCUIT DIAGRAM/CIRCUIT DESCRIPTION:

Including description of circuitry & devices provided for determining and stabilizing frequency, for suppression of spurious radiation, for limiting modulation and limiting power.

PLEASE SEE ATTACHED EXHIBITS

(c) (11): LABEL INFORMATION:

PLEASE SEE ATTACHED EXHIBITS

(c) (12): PHOTOGRAPHS:

PLEASE SEE ATTACHED EXHIBITS

(c) (13): DIGITAL MODULATION DESCRIPTION:

ATTACHED EXHIBITS
x N/A

(c) (14): TEST AND MEASUREMENT DATA:

FOLLOWS

PAGE NO.

5 of 41.

Sub-part
2.1033(c) (14):TEST AND MEASUREMENT DATA

All tests and measurement data shown were performed in accordance with FCC Rules and Regulations, Volume II; Part 2, Sub-part J, Sections 2.947, 2.1033(c), 2.1041, 2.1046, 2.1047, 2.1079, 2.1051, 2.1053, 2.1055, 2.1057 and the following individual Parts:

- ___ 21 - Domestic Public Fixed Radio Services
- x ___ 22 - Public Mobile Services
- ___ 22 Subpart H - Cellular Radiotelephone Service
- ___ 22.901(d) - Alternative technologies and auxiliary services
- ___ 23 - International Fixed Public Radiocommunication services
- ___ 24 - Personal Communications Services
- x ___ 74 Subpart H - Low Power Auxiliary Stations
- x ___ 80 - Stations in the Maritime Services
- ___ 80 Subpart E - General Technical Standards
- ___ 80 Subpart F - Equipment Authorization for Compulsory Ships
- ___ 80 Subpart K - Private Coast Stations and Marine Utility Stations
- ___ 80 Subpart S - Compulsory Radiotelephone Installations for Small Passenger Boats
- ___ 80 Subpart T - Radiotelephone Installation Required for Vessels on the Great Lakes
- ___ 80 Subpart U - Radiotelephone Installations Required by the Bridge-to-Bridge Act
- ___ 80 Subpart V - Emergency Position Indicating Radiobeacons (EPIRB'S)
- ___ 80 Subpart W - Global Maritime Distress and Safety System (GMDSS)
- ___ 80 Subpart X - Voluntary Radio Installations
- ___ 87 - Aviation Services
- x ___ 90 - Private Land Mobile Radio Services
- ___ 94 - Private Operational-Fixed Microwave Service
- ___ 95 Subpart A - General Mobile Radio Service (GMRS)
- ___ 95 Subpart C - Radio Control (R/C) Radio Service
- ___ 95 Subpart D - Citizens Band (CB) Radio Service
- ___ 95 Subpart E - Family Radio Service
- ___ 95 Subpart F - Interactive Video and Data Service (IVDS)
- ___ 101 - Fixed Microwave Services

PAGE NO.

6 of 41.

STANDARD TEST CONDITIONS
and
ENGINEERING PRACTICES

Except as noted herein, the following conditions and procedures were observed during the testing:

In accordance with ANSI C63.4-1992, section 6.1.9, and unless otherwise indicated in the specific measurement results, the ambient temperature of the actual EUT was maintained within the range of 10° to 40°C (50° to 104 °F) unless the particular equipment requirements specify testing over a different temperature range. Also, unless otherwise indicated, the humidity levels were in the range of 10% to 90% relative humidity.

Prior to testing, the EUT was tuned up in accordance with the manufacturer's alignment procedures. All external gain controls were maintained at the position of maximum and/or optimum gain throughout the testing.

Measurement results, unless otherwise noted, are worst case measurements.

PAGE NO. 7 of 41.
NAME OF TEST: Carrier Output Power (Conducted)
SPECIFICATION: 47 CFR 2.1046(a)
GUIDE: ANSI/TIA/EIA-603-1992, Paragraph 2.2.1
TEST EQUIPMENT: As per attached page

MEASUREMENT PROCEDURE

1. The EUT was connected to a resistive coaxial attenuator of normal load impedance, and the unmodulated output power was measured by means of an R. F. Power Meter.
2. Measurement accuracy is $\pm 3\%$.

MEASUREMENT RESULTS
(Worst case)

FREQUENCY OF CARRIER, MHz = 155, 136, 174

<u>POWER SETTING</u>	<u>R. F. POWER, WATTS</u>
Low	0.1
High	5

SUPERVISED BY:

William H. Graff, Director
of Engineering

TRANSMITTER POWER CONDUCTED MEASUREMENTS

TEST 1: R. F. POWER OUTPUT
 TEST 2: FREQUENCY STABILITY

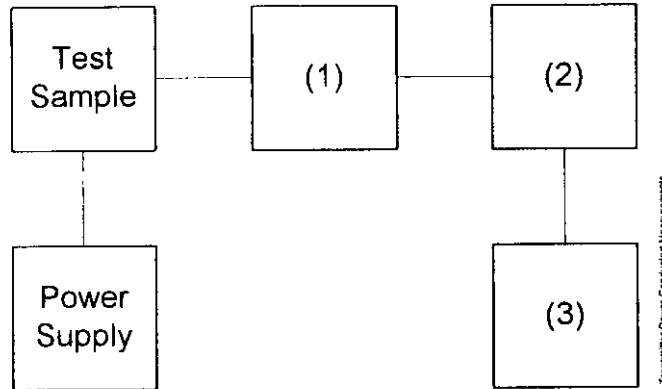

Asset	Description	s/n
(1)	<u>COAXIAL ATTENUATOR</u>	
_____	i00122 Narda 766-10	7802
_____	i00123 Narda 766-10	7802A
_____	i00069 Bird 8329 (30 dB)	1006
<u>x</u>	i00113 Sierra 661A-3D	1059
(2)	<u>POWER METERS</u>	
_____	i00014 HP 435A	1733A05836
<u>x</u>	i00039 HP 436A	2709A26776
<u>x</u>	i00020 HP 8901A POWER MODE	2105A01087
(3)	<u>FREQUENCY COUNTER</u>	
_____	i00042 HP 5383A	1628A00959
<u>x</u>	i00019 HP 5334B	2704A00347
<u>x</u>	i00020 HP 8901A FREQUENCY MODE	2105A01087

PAGE NO. 9 of 41.
NAME OF TEST: Unwanted Emissions (Transmitter Conducted)
SPECIFICATION: 47 CFR 2.1051
GUIDE: ANSI/TIA/EIA-603-1992, Paragraph 2.2.13
TEST EQUIPMENT: As per attached page

MEASUREMENT PROCEDURE

1. The emissions were measured for the worst case as follows:
 - (a): within a band of frequencies defined by the carrier frequency plus and minus one channel.
 - (b): from the lowest frequency generated in the EUT and to at least the 10th harmonic of the carrier frequency, or 40 GHz, whichever is lower.
2. The magnitude of spurious emissions that are attenuated more than 20 dB below the permissible value need not be specified.
3. MEASUREMENT RESULTS: ATTACHED FOR WORST CASE

FREQUENCY OF CARRIER, MHz	= 155, 136, 174
SPECTRUM SEARCHED, GHz	= 0 to 10 x F _c
MAXIMUM RESPONSE, Hz	= 2510
ALL OTHER EMISSIONS	= ≥ 20 dB BELOW LIMIT
LIMIT(S), dBc	
	-(50+10xLOG P) = -30 (0.1 Watt)
	-(50+10xLOG P) = -57 (5 Watts)

SUPERVISED BY:



William H. Graff, Director
of Engineering

TRANSMITTER SPURIOUS EMISSION

TEST A. OCCUPIED BANDWIDTH (IN-BAND SPURIOUS)
 TEST B. OUT-OF-BAND SPURIOUS

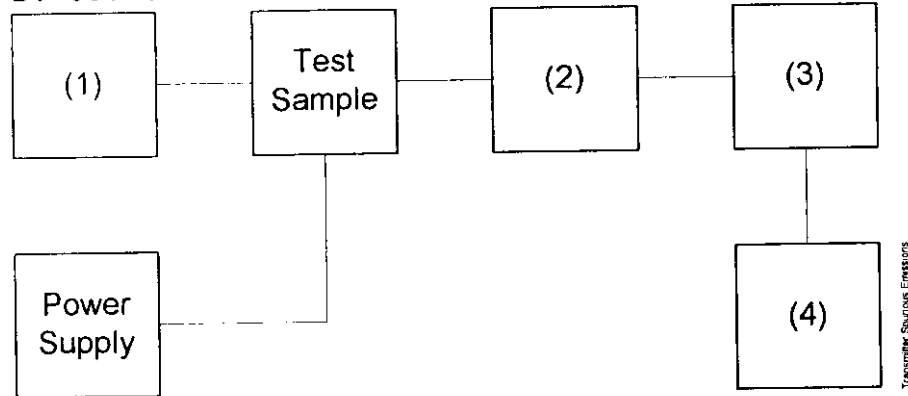

Asset	Description	s/n
<u>(1) AUDIO OSCILLATOR/GENERATOR</u>		
---	i00010 HP 204D	1105A04683
---	i00017 HP 8903A	2216A01753
<u>x</u>	i00012 HP 3312A	1432A11250
<u>(2) COAXIAL ATTENUATOR</u>		
---	i00122 Narda 766-10	7802
---	i00123 Narda 766-10	7802A
<u>x</u>	i00069 Bird 8329 (30 dB)	1006
<u>x</u>	i00113 Sierra 661A-3D	1059
<u>(3) FILTERS; NOTCH, HP, LP, BP</u>		
<u>x</u>	i00126 Eagle TNF-1	100-250
<u>x</u>	i00125 Eagle TNF-1	50-60
<u>x</u>	i00124 Eagle TNF-1	250-850
<u>(4) SPECTRUM ANALYZER</u>		
<u>x</u>	i00048 HP 8566B	2511A01467
---	i00029 HP 8563E	3213A00104

PAGE NO.

11 of 41.

NAME OF TEST: Unwanted Emissions (Transmitter Conducted)
 g9980095: 1999-Aug-18 Wed 14:01:00
 STATE: 2:Low Power

FREQUENCY TUNED, MHz	FREQUENCY EMISSION, MHz	LEVEL, dBm	LEVEL, dBc	MARGIN, dB
136.000000	272.333000	-43.6	-80.5	-23.6
155.000000	310.211000	-44.3	-81.2	-24.3
174.000000	348.138000	-43.4	-80.3	-23.4
136.000000	407.991000	-43	-79.9	-23
155.000000	465.296000	-43.5	-80.4	-23.5
174.000000	521.917000	-44.1	-81	-24.1
136.000000	544.073000	-43.7	-80.6	-23.7
155.000000	620.038000	-43.6	-80.5	-23.6
136.000000	679.967000	-44.1	-81	-24.1
174.000000	696.430000	-44	-80.9	-24
155.000000	774.681000	-45.1	-82	-25.1
136.000000	816.301000	-44.3	-81.2	-24.3
174.000000	869.637000	-44.1	-81	-24.1
155.000000	929.958000	-44.6	-81.5	-24.6
136.000000	952.419000	-44.9	-81.8	-24.9
174.000000	1043.584000	-44.6	-81.5	-24.6
155.000000	1084.518000	-43.8	-80.7	-23.8
136.000000	1087.800000	-44.9	-81.8	-24.9
174.000000	1218.034000	-44	-80.9	-24
136.000000	1224.238000	-43.9	-80.8	-23.9
155.000000	1239.874000	-43.7	-80.6	-23.7
136.000000	1359.750000	-43	-79.9	-23
174.000000	1392.471000	-44.2	-81.1	-24.2
155.000000	1394.883000	-43.9	-80.8	-23.9
136.000000	1496.080000	-42.9	-79.8	-22.9
155.000000	1550.108000	-43.3	-80.2	-23.3
174.000000	1565.723000	-42.2	-79.1	-22.2
136.000000	1631.602000	-42.6	-79.5	-22.6
155.000000	1704.987000	-42.3	-79.2	-22.3
174.000000	1739.636000	-43.6	-80.5	-23.6
136.000000	1767.987000	-43	-79.9	-23
155.000000	1859.601000	-43.9	-80.8	-23.9
136.000000	1903.566000	-44.3	-81.2	-24.3
174.000000	1913.997000	-43.5	-80.4	-23.5
155.000000	2014.837000	-42.5	-79.4	-22.5
136.000000	2040.457000	-42.1	-79	-22.1
174.000000	2088.271000	-43.2	-80.1	-23.2
155.000000	2170.429000	-43.5	-80.4	-23.5
174.000000	2262.203000	-43.4	-80.3	-23.4
155.000000	2325.230000	-42.9	-79.8	-22.9
174.000000	2435.632000	-41.9	-78.8	-21.9
174.000000	2609.735000	-44.8	-81.7	-24.8

PAGE NO.

12 of 41.

NAME OF TEST: Unwanted Emissions (Transmitter Conducted)
 g9980107: 1999-Aug-19 Thu 16:47:00
 STATE: 2:High Power

FREQUENCY TUNED, MHz	FREQUENCY EMISSION, MHz	LEVEL, dBm	LEVEL, dBc	MARGIN, dB
136.000000	272.003000	-52.3	-72.3	-32.3
155.000000	310.004000	-61.1	-81.1	-41.1
174.000000	348.002000	-62.2	-82.2	-42.2
136.000000	408.378000	-64.9	-84.9	-44.9
155.000000	464.659000	-64	-84	-44
174.000000	521.709000	-64.3	-84.3	-44.3
136.000000	544.205000	-64.8	-84.8	-44.8
155.000000	619.550000	-63.8	-83.8	-43.8
136.000000	680.265000	-64.8	-84.8	-44.8
174.000000	695.705000	-63.6	-83.6	-43.6
155.000000	775.095000	-64.8	-84.8	-44.8
136.000000	816.323000	-64.4	-84.4	-44.4
174.000000	870.290000	-64.2	-84.2	-44.2
155.000000	930.498000	-64.3	-84.3	-44.3
136.000000	951.844000	-63	-83	-43
174.000000	1043.744000	-65	-85	-45
155.000000	1084.901000	-64.5	-84.5	-44.5
136.000000	1088.171000	-63.8	-83.8	-43.8
174.000000	1217.536000	-63.6	-83.6	-43.6
136.000000	1223.608000	-64.4	-84.4	-44.4
155.000000	1239.598000	-64.3	-84.3	-44.3
136.000000	1360.021000	-61.2	-81.2	-41.2
174.000000	1391.997000	-63.5	-83.5	-43.5
155.000000	1394.638000	-64.5	-84.5	-44.5
136.000000	1496.330000	-64.2	-84.2	-44.2
155.000000	1550.295000	-64.4	-84.4	-44.4
174.000000	1565.831000	-63.7	-83.7	-43.7
136.000000	1632.030000	-62.8	-82.8	-42.8
155.000000	1705.029000	-62.8	-82.8	-42.8
174.000000	1739.994000	-63.3	-83.3	-43.3
136.000000	1768.229000	-62.4	-82.4	-42.4
155.000000	1859.507000	-63.6	-83.6	-43.6
136.000000	1904.463000	-63.5	-83.5	-43.5
174.000000	1913.619000	-62.7	-82.7	-42.7
155.000000	2014.505000	-63.2	-83.2	-43.2
136.000000	2040.327000	-63.3	-83.3	-43.3
174.000000	2087.866000	-62.5	-82.5	-42.5
155.000000	2169.901000	-61.9	-81.9	-41.9
174.000000	2261.717000	-62.9	-82.9	-42.9
155.000000	2325.133000	-61.9	-81.9	-41.9
174.000000	2435.935000	-61.6	-81.6	-41.6
174.000000	2609.679000	-64.5	-84.5	-44.5

PAGE NO. 13 of 41.
NAME OF TEST: Field Strength of Spurious Radiation
SPECIFICATION: 47 CFR 2.1053(a)
GUIDE: ANSI/TIA/EIA-603-1992, Paragraph 2.2.12
TEST EQUIPMENT: As per attached page

MEASUREMENT PROCEDURE

1. A description of the measurement facilities was filed with the FCC and was found to be in compliance with the requirements of Section 2.948, by letter from the FCC dated March 3, 1997, FILE 31040/SIT. All pertinent changes will be reported to the Commission by up-date prior to March 2000.
2. At first, in order to locate all spurious frequencies and approximate amplitudes, and to determine proper equipment functioning, the test sample was set up at a distance of three meters from the test instrument. Valid spurious signals were determined by switching the power on and off.
3. In the field, the test sample was placed on a wooden turntable above ground at three (or thirty) meters away from the search antenna. Excess power leads were coiled near the power supply.

The cables were oriented in order to obtain the maximum response. At each emission frequency, the turntable was rotated and the search antennas were raised and lowered vertically.
4. The emission was observed with both a vertically polarized and a horizontally polarized search antenna and the worst case was used.
6. The field strength of each emission within 20 dB of the limit was recorded and corrected with the appropriate cable and transducer factors.
7. The worst case for all channels is shown.
8. Measurement results: ATTACHED FOR WORST CASE

RADIATED TEST SETUP

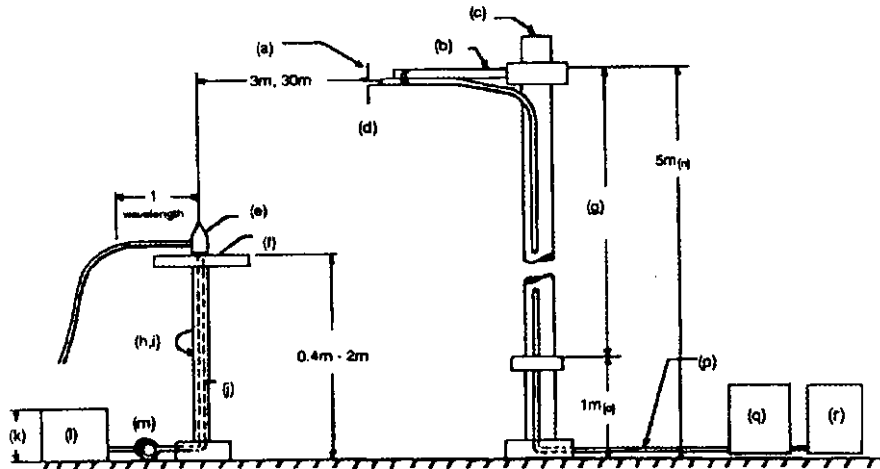

NOTES:

- (a) Search Antenna - Rotatable on boom
- (b) Non-metallic boom
- (c) Non-metallic mast
- (d) Adjustable horizontally
- (e) Equipment Under Test
- (f) Turntable
- (g) Boom adjustable in height.
- (h) External control cables routed horizontally at least one wavelength.
- (i) Rotatable
- (j) Cables routed through hollow turntable center
- (k) 30 cm or less
- (l) External power source
- (m) 10 cm diameter coil of excess cable
- (n) 25 cm (V), 1 m-7 m (V, H)
- (o) 25 cm from bottom end of 'V', 1m normally
- (p) Calibrated Cable at least 10m in length
- (q) Amplifier (optional)
- (r) Spectrum Analyzer

Asset	Description	s/n	Cycle	Last Cal
<u>TRANSDUCER</u>				
_____	i00065	EMCO 3109B 100Hz-50MHz	2336	12 mo.
_____	i00033	Singer 94593-1 10kHz-32MHz	0219	12 mo.
x	i00088	EMCO 3109-B 25MHz-300MHz	2336	12 mo. Oct-98
x	i00089	Apral 2001 200MHz-1GHz	001500	12 mo. Oct-98
x	i00103	EMCO 3115 1GHz-18GHz	9208-3925	12 mo. Oct-98
_____	i00085	EMCO 3116 10GHz-40GHz	2076	12 mo.
<u>AMPLIFIER</u>				
_____	i00028	HP 8449A	2749A00121	12 mo. Mar-99
<u>SPECTRUM ANALYZER</u>				
_____	i00029	HP 8563E	3213A00104	12 mo. Aug-98
x	i00033	HP 85462A	3625A00357	12 mo. Dec-98
_____	i00048	HP 8566B	2511AD1467	6 mo. Dec-98

PAGE NO. 15 of 41.

NAME OF TEST: Field Strength of Spurious Radiation

ALL OTHER EMISSIONS = \geq 20 dB BELOW LIMIT

EMISSION, MHz/HARMONIC	SPURIOUS LEVEL, dBc	
	Low	High
2nd to 10th	<-70	<-75

SUPERVISED BY:

 William H. Graff, Director
 of Engineering

PAGE NO. 16 of 41.
NAME OF TEST: Emission Masks (Occupied Bandwidth)
SPECIFICATION: 47 CFR 2.1049(c) (1)
GUIDE: ANSI/TIA/EIA-603-1992, Paragraph 2.2.11
TEST EQUIPMENT: As per previous page

MEASUREMENT PROCEDURE

1. The EUT and test equipment were set up as shown on the following page, with the Spectrum Analyzer connected.
2. For EUTs supporting audio modulation, the audio signal generator was adjusted to the frequency of maximum response and with output level set for ± 2.5 kHz deviation (or 50% modulation). With level constant, the signal level was increased 16 dB.
3. For EUTs supporting digital modulation, the digital modulation mode was operated to its maximum extent.
4. The Occupied Bandwidth was measured with the Spectrum Analyzer controls set as shown on the test results.
5. MEASUREMENT RESULTS: ATTACHED

PAGE NO. 17 of 41.

NAME OF TEST: Emission Masks (Occupied Bandwidth)
g9980104: 1999-Aug-19 Thu 16:41:00
STATE: 1:Low Power

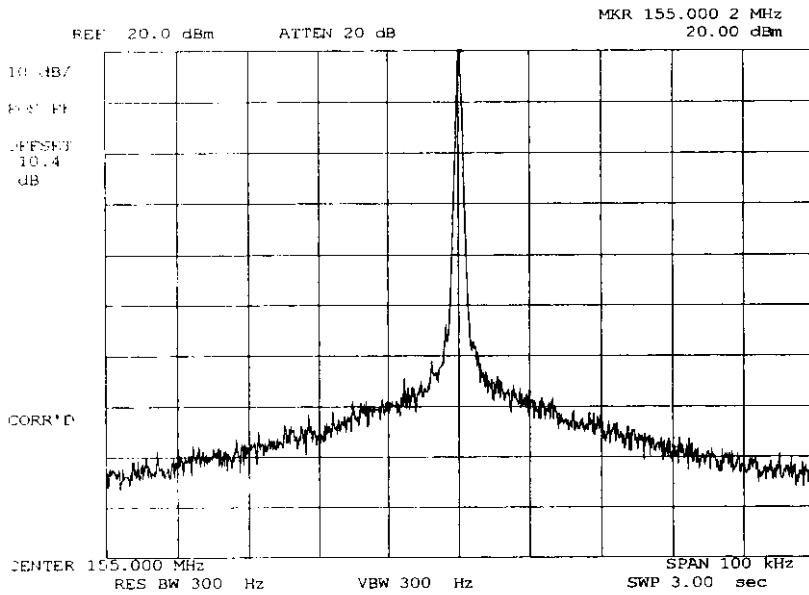

POWER: LOW
MODULATION: NONE

SUPERVISED BY:

William H. Graff, Director
of Engineering

PAGE NO.

18 of 41.

NAME OF TEST: Emission Masks (Occupied Bandwidth)
g9980105: 1999-Aug-19 Thu 16:43:00
STATE: 1:Low Power

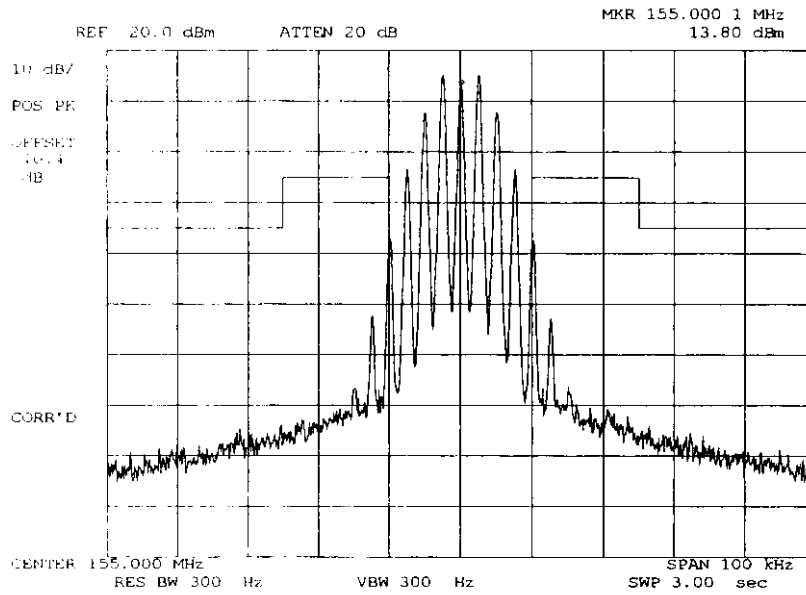

POWER:
MODULATION:

LOW
VOICE: 2500 Hz SINE WAVE
MASK: B, VHF/UHF 25kHz,
w/LPF

SUPERVISED BY:

William H. Graff, Director
of Engineering

PAGE NO. 19 of 41.

NAME OF TEST: Emission Masks (Occupied Bandwidth)
g9980106: 1999-Aug-19 Thu 16:45:00
STATE: 1:Low Power

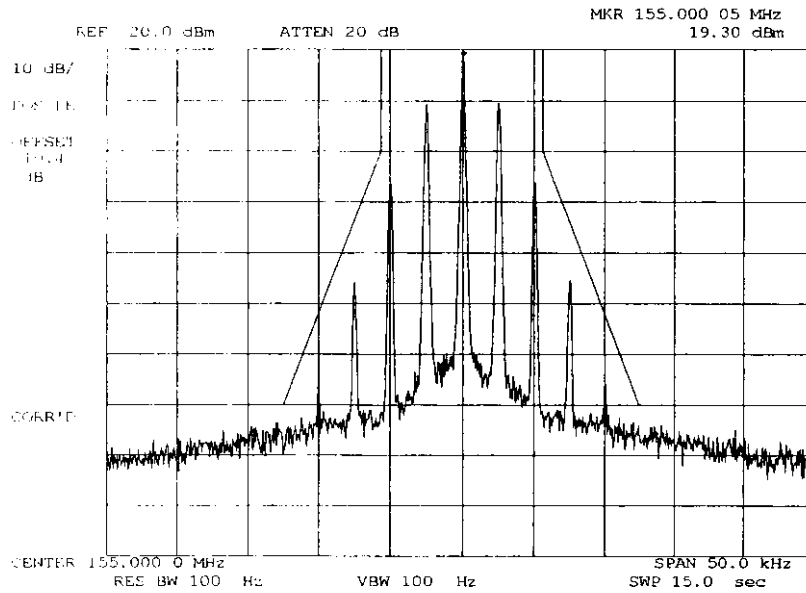

POWER:
MODULATION:

LOW
VOICE: 2500 Hz SINE WAVE
MASK: D, VHF/UHF 12.5kHz BW

SUPERVISED BY:

William H. Graff, Director
of Engineering

PAGE NO. 20 of 41.

NAME OF TEST: Emission Masks (Occupied Bandwidth)
q9980088: 1999-Aug-18 Wed 11:23:00
STATE: 2:High Power

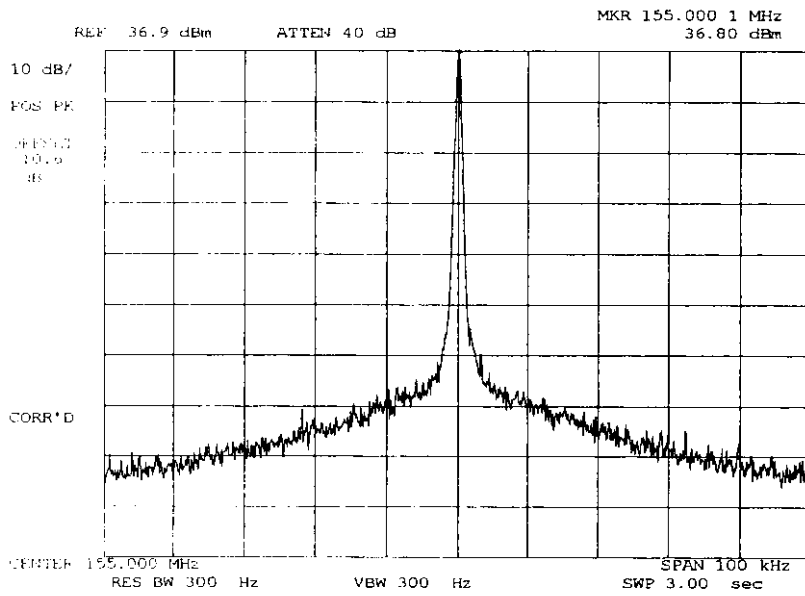

POWER: HIGH
MODULATION: NONE

SUPERVISED BY:

William H. Graff, Director
of Engineering

PAGE NO.

21 of 41.

NAME OF TEST: Emission Masks (Occupied Bandwidth)
g9980089: 1999-Aug-18 Wed 11:39:00
STATE: 2:High Power

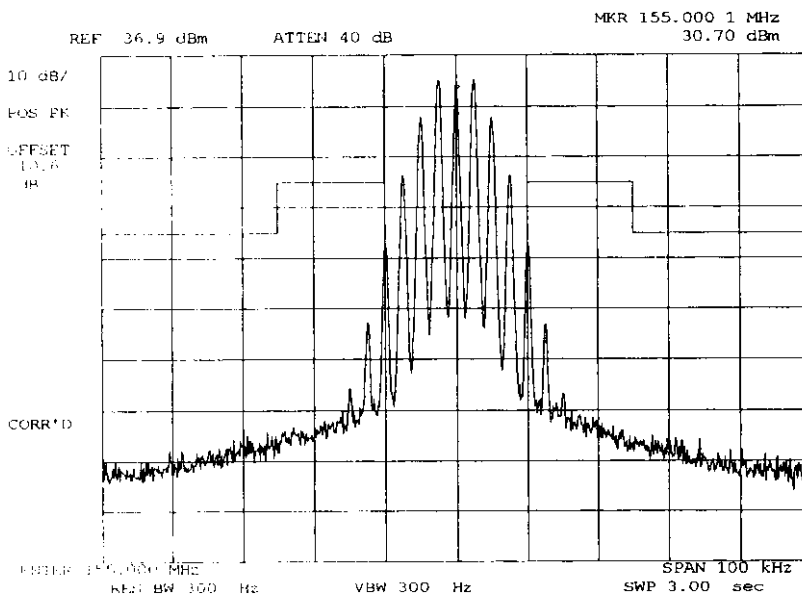

POWER:
MODULATION:

HIGH
VOICE: 2500 Hz SINE WAVE
MASK: B, VHF/UHF 25kHz,
w/LPF

SUPERVISED BY:

William H. Graff
William H. Graff, Director
of Engineering

PAGE NO. 22 of 41.

NAME OF TEST: Emission Masks (Occupied Bandwidth)
g9980092: 1999-Aug-18 Wed 13:18:00
STATE: 2:High Power

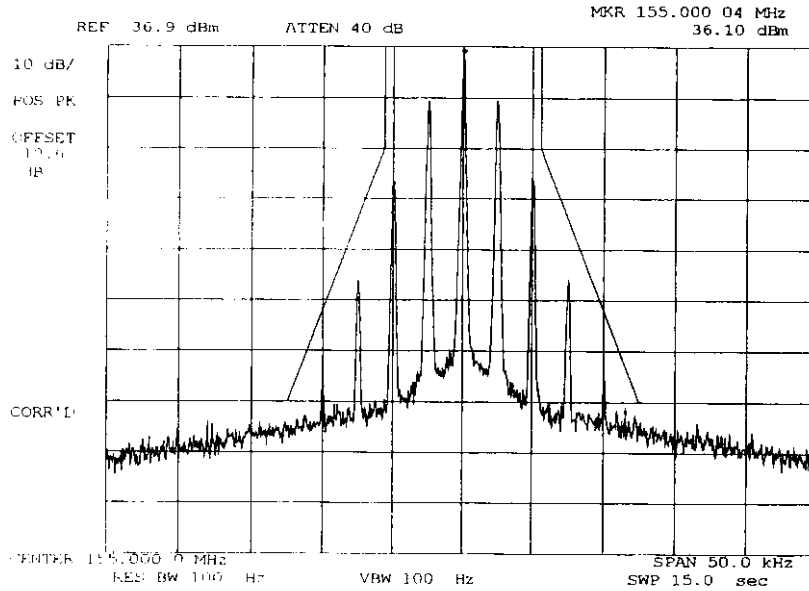

POWER:
MODULATION:

HIGH
VOICE: 2500 Hz SINE WAVE
MASK: D, VHF/UHF 12.5kHz BW

SUPERVISED BY:

William H. Graff, Director
of Engineering

PAGE NO. 23 of 41.
NAME OF TEST: Transient Frequency Behavior
SPECIFICATION: 47 CFR 90.214
GUIDE: ANSI/TIA/EIA-603-1992, Paragraph 2.2.19
TEST EQUIPMENT: As per attached page

MEASUREMENT PROCEDURE

1. The EUT was setup as shown on the attached page, following TIA/EIA-603 steps a, b, and c as a *guide*.
2. The transmitter was turned on.
3. Sufficient attenuation was provided so that the transmitter carrier level measured at the output of the combiner was 40 dB below the maximum input level of the test receiver. This level was recorded as step f.
4. The transmitter was turned off.
5. An RF signal generator (1) modulated with a 1 kHz tone at either 25, 12.5, or 6.25 kHz deviation, and set to the same frequency as the assigned transmitter frequency, (2) was adjusted to a level -20 dB below the level recorded for step f, as measured at the output of the combiner. This level was then fixed for the remainder of the test and is recorded at step h.
6. The oscilloscope was setup using TIA/EIA-603 steps j and k as a guide, and to either 10 ms/div (UHF) or 5 ms/div (VHF).
7. The 30 dB attenuator was removed, the transmitter was turned on, and the level of the carrier at the output of the combiner was recorded as step l.
8. The carrier on-time as referenced in TIA/EIA-603 steps m, n, and o was captured and plotted. The carrier off-time as referenced in TIA/EIA-603 steps p, q, r, and s was captured and plotted.

LEVELS MEASURED:

step f, dBm	=	-16.9
step h, dBm	=	-33.9
step l, dBm	=	16.4

SUPERVISED BY:

 William H. Graff, Director
 of Engineering

TRANSIENT FREQUENCY BEHAVIOR

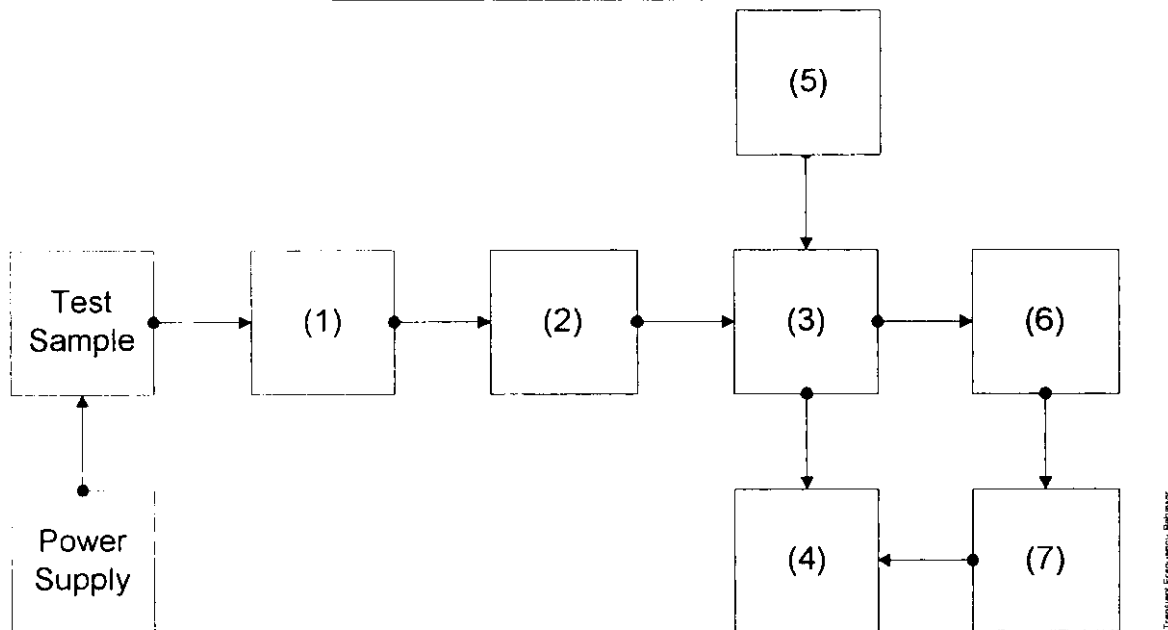

Asset	Description	s/n
(1)	ATTENUATOR (Removed after 1st step)	
x	i00112 Philco 30 dB	989
(2)	ATTENUATOR	
	i00112 Philco 30 dB	989
	i00172 Bird 30 dB	989
x	i00122 Narda 10 dB	7802
	i00123 Narda 10 dB	7802A
	i00110 Kay Variable	145-387
(3)	COMBINER	
x	i00154 4 x 25 Ω COMBINER	154
(4)	CRYSTAL DETECTOR	
x	i00159 HP 8470B	1822A10054
(5)	RF SIGNAL GENERATOR	
	i00018 HP 8656A	2228A03472
	i00031 HP 8656A	2402A06180
x	i00067 HP 8920A	3345U01242
(6)	MODULATION ANALYZER	
x	i00020 HP 8901A	2105A01087
(7)	SCOPE	
x	i00030 HP 54502A	2927A00209

PAGE NO. 25 of 41.

NAME OF TEST: Transient Frequency Behavior

STATE:

LAB DATA

POWER:
 MODULATION:
 DESCRIPTION:

PAGE NO. 25 of 41.

NAME OF TEST: Transient Frequency Behavior

g9980096: 1999-Aug-18 Wed 14:28:00

STATE: 2:High Power

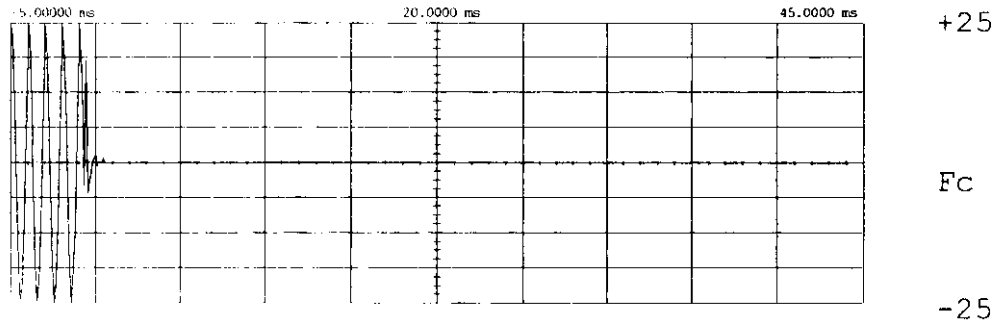

Time-base:	5.00 ns/div	Delay Pos:	00.0000 ns	Reference:	Center	Mode:	Repetitive
Sensitivity:	600 mV/div	Offset:	0.00000 V	Probe:	1.000 :1	Coupling:	dc (1M Ohm)

Trigger mode : Edge
 On Negative Edge Of Chan2
 Trigger Level
 Chan2 = 24.000 mV (noise reject ON)
 Hold-off = 40.000 us

POWER:
 MODULATION:
 DESCRIPTION:

HIGH
 Ref Gen=25 kHz Deviation
 CARRIER ON TIME

SUPERVISED BY:

William H. Graff
 William H. Graff, Director
 of Engineering

PAGE NO.

26 of 41.

NAME OF TEST: Transient Frequency Behavior
 g9980097: 1999-Aug-18 Wed 14:35:00
 STATE: 2:High Power

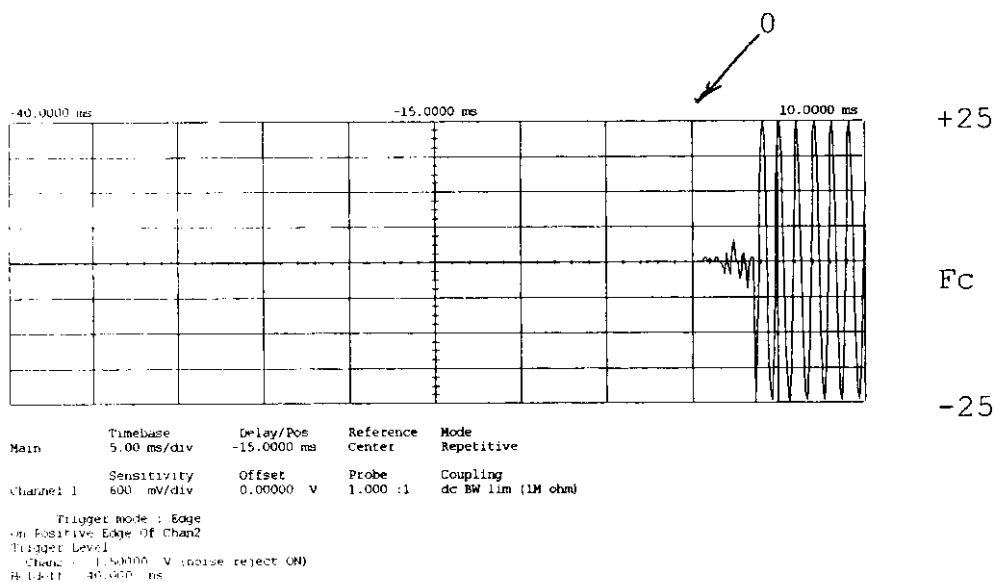

POWER:
 MODULATION:
 DESCRIPTION:

HIGH
 Ref Gen=25 kHz Deviation
 CARRIER OFF TIME

SUPERVISED BY:

William H. Graff
 William H. Graff, Director
 of Engineering

PAGE NO.

27 of 41.

NAME OF TEST: Transient Frequency Behavior
g9980099: 1999-Aug-18 Wed 14:44:00
STATE: 2:High Power

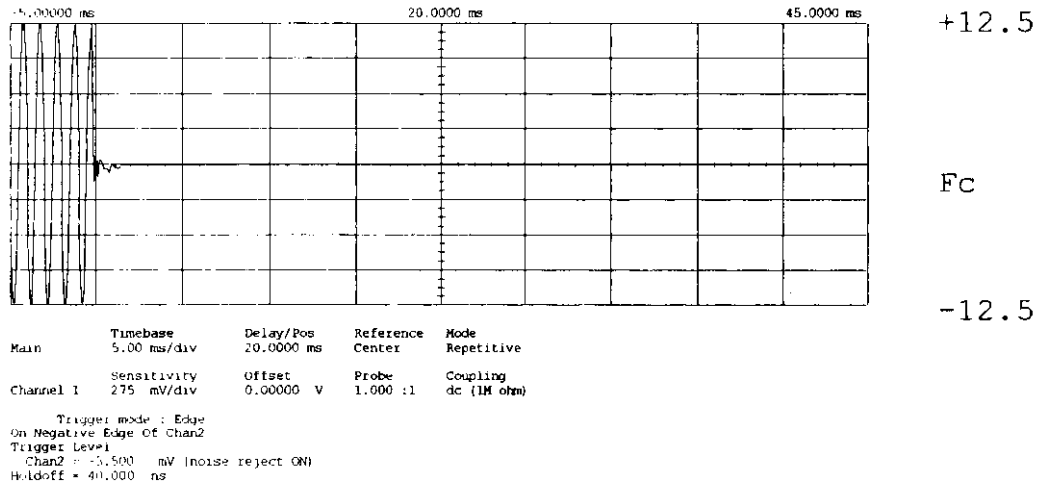

POWER:
MODULATION:
DESCRIPTION:

HIGH
Ref Gen=12.5 kHz Deviation
CARRIER ON TIME

SUPERVISED BY:

William H. Graff
William H. Graff, Director
of Engineering

PAGE NO. 28 of 41.

NAME OF TEST: Transient Frequency Behavior
 g9980100: 1999-Aug-18 Wed 14:49:00
 STATE: 2:High Power

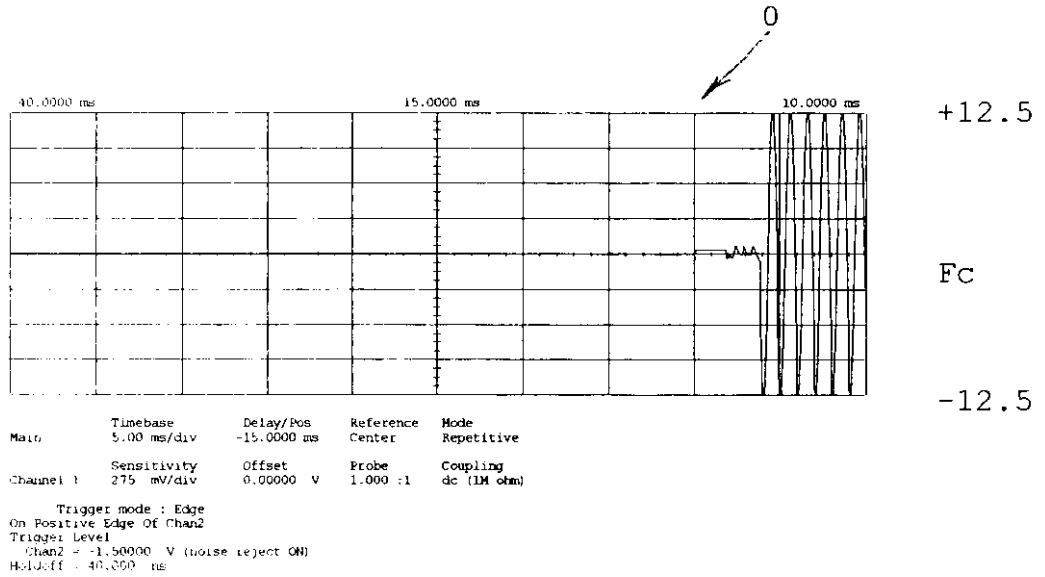

POWER:
 MODULATION:
 DESCRIPTION:

HIGH
 Ref Gen=12.5 kHz Deviation
 CARRIER OFF TIME

SUPERVISED BY:

William H. Graff
 William H. Graff, Director
 of Engineering

PAGE NO. 29 of 41.
NAME OF TEST: Audio Low Pass Filter (Voice Input)
SPECIFICATION: 47 CFR 2.1047(a)
GUIDE: ANSI/TIA/EIA-603-1992, Paragraph 2.2.15
TEST EQUIPMENT: As per attached page

MEASUREMENT PROCEDURE

1. The EUT and test equipment were set up such that the audio input was connected at the input to the modulation limiter, and the modulated stage.
2. The audio output was connected at the output to the modulated stage.
3. MEASUREMENT RESULTS: ATTACHED

TRANSMITTER TEST SET-UP

- TEST A. MODULATION CAPABILITY/DISTORTION
- TEST B. AUDIO FREQUENCY RESPONSE
- TEST C. HUM AND NOISE LEVEL
- TEST D. RESPONSE OF LOW PASS FILTER
- TEST E. MODULATION LIMITING

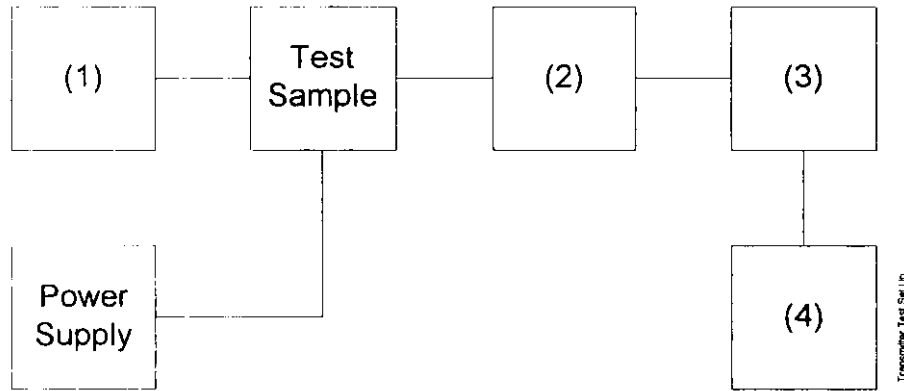

Asset	Description	s/n
(1)	<u>Audio Oscillator</u>	
	i00010 HP 204D	1105A04683
<u>x</u>	i00017 HP 8903A	2216A01753
<u>x</u>	i00118 HP 33120A	US36002064
(2)	<u>COAXIAL ATTENUATOR</u>	
	i00122 NARDA 766-10	7802
	i00123 NARDA 766-10	7802A
<u>x</u>	i00113 SIERRA 661A-3D	1059
	i00069 BIRD 8329 (30 dB)	10066
(3)	<u>MODULATION ANALYZER</u>	
<u>x</u>	i00020 HP 8901A	2105A01087
(4)	<u>AUDIO ANALYZER</u>	
<u>x</u>	i00017 HP 8903A	2216A01753

PAGE NO.

31 of 41.

NAME OF TEST: Audio Low Pass Filter (Voice Input)
g9980047: 1999-Aug-18 Wed 14:56:00
STATE: 0:General

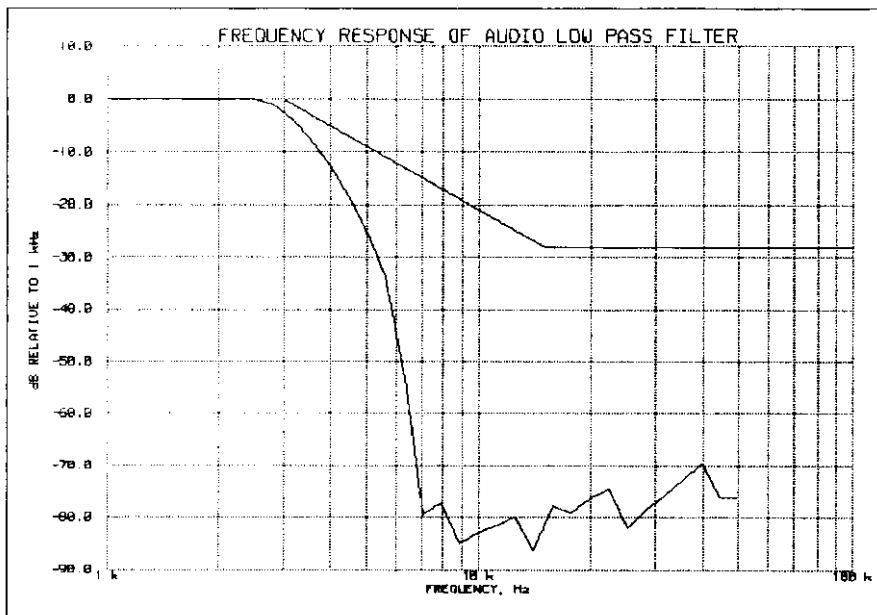

SUPERVISED BY:

William H. Graff, Director
of Engineering

PAGE NO. 32 of 41.
NAME OF TEST: Audio Frequency Response
SPECIFICATION: 47 CFR 2.1047(a)
GUIDE: ANSI/TIA/EIA-603-1992, Paragraph 2.2.6
TEST EQUIPMENT: As per previous page

MEASUREMENT PROCEDURE

1. The EUT and test equipment were set up as shown on the following page.
2. The audio signal generator was connected to the audio input circuit/microphone of the EUT.
3. The audio signal input was adjusted to obtain 20% modulation at 1 kHz, and this point was taken as the 0 dB reference level.
4. With input levels held constant and below limiting at all frequencies, the audio signal generator was varied from 100 Hz to 50 kHz.
5. The response in dB relative to 1 kHz was then measured, using the HP 8901A Modulation Analyzer.
6. MEASUREMENT RESULTS: ATTACHED

PAGE NO. 33 of 41.

NAME OF TEST: Audio Frequency Response
 g9980050: 1999-Aug-18 Wed 15:05:00
 STATE: 0:General

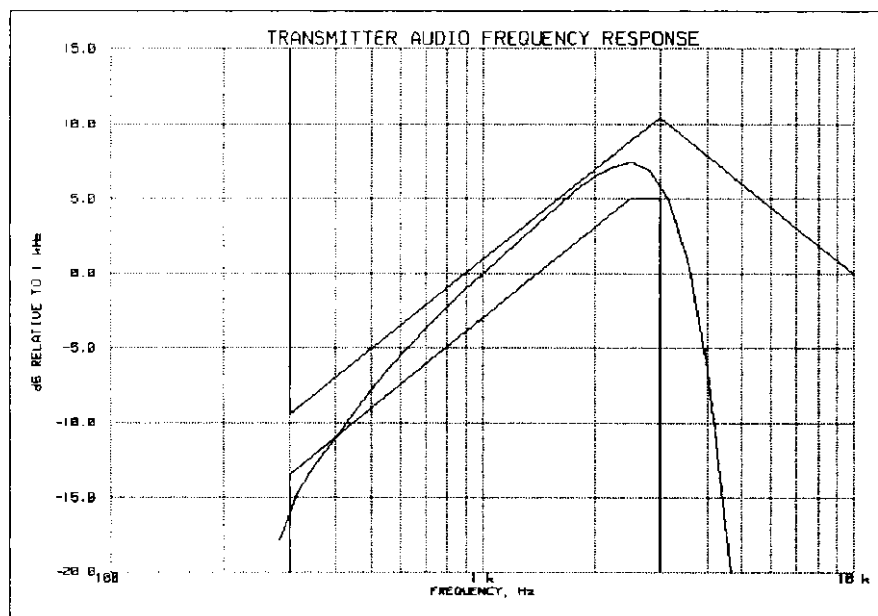

Additional points:

FREQUENCY, Hz	LEVEL, dB
300	-15.74
20000	-34.16
30000	-34.10
50000	-34.10

SUPERVISED BY:

William H. Graff
 William H. Graff, Director
 of Engineering

PAGE NO. 34 of 41.

NAME OF TEST: Modulation Limiting
SPECIFICATION: 47 CFR 2.1047(b)
GUIDE: ANSI/TIA/EIA-603-1992, Paragraph 2.2.3
TEST EQUIPMENT: As per previous page

MEASUREMENT PROCEDURE

1. The signal generator was connected to the input of the EUT as for "Frequency Response of the Modulating Circuit."
2. The modulation response was measured for each of three frequencies (one of which was the frequency of maximum response), and the input voltage was varied and was observed on an HP 8901A Modulation Analyzer.
3. The input level was varied from 30% modulation (± 1.5 kHz deviation) to at least 20 dB higher than the saturation point.
4. Measurements were performed for both negative and positive modulation and the respective results were recorded.
5. MEASUREMENT RESULTS: ATTACHED

PAGE NO.

35 of 41.

NAME OF TEST: Modulation Limiting
g9980051: 1999-Aug-18 Wed 15:08:00
STATE: 0:General

Positive
Peaks:

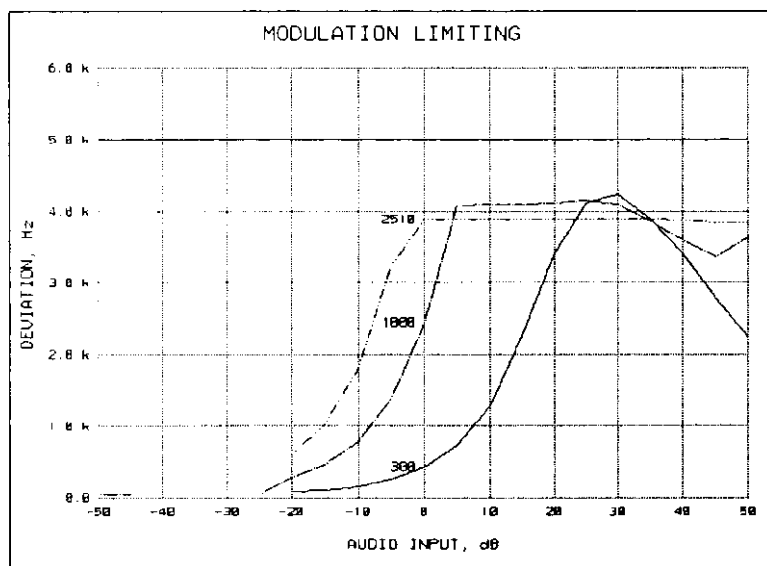

Negative
Peaks:

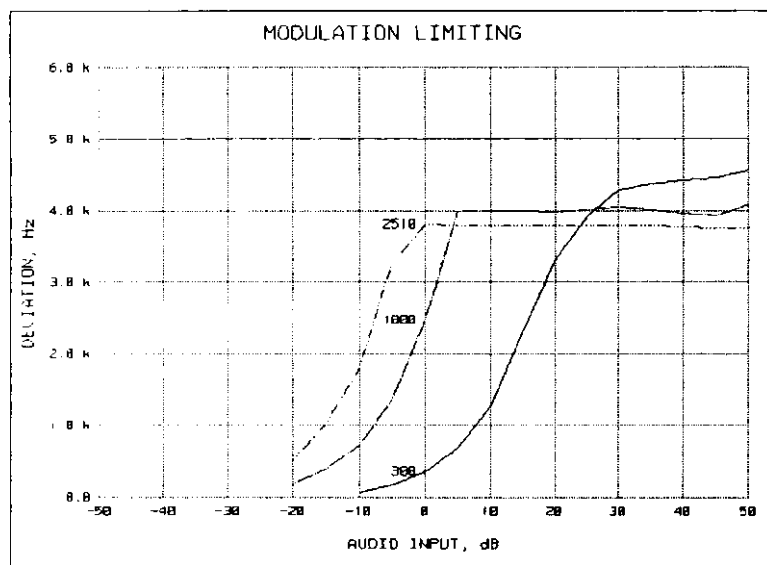

SUPERVISED BY:



William H. Graff, Director
of Engineering

PAGE NO.

36 of 41.

NAME OF TEST: Modulation Limiting
g9980052: 1999-Aug-18 Wed 15:13:00
STATE: 0:General

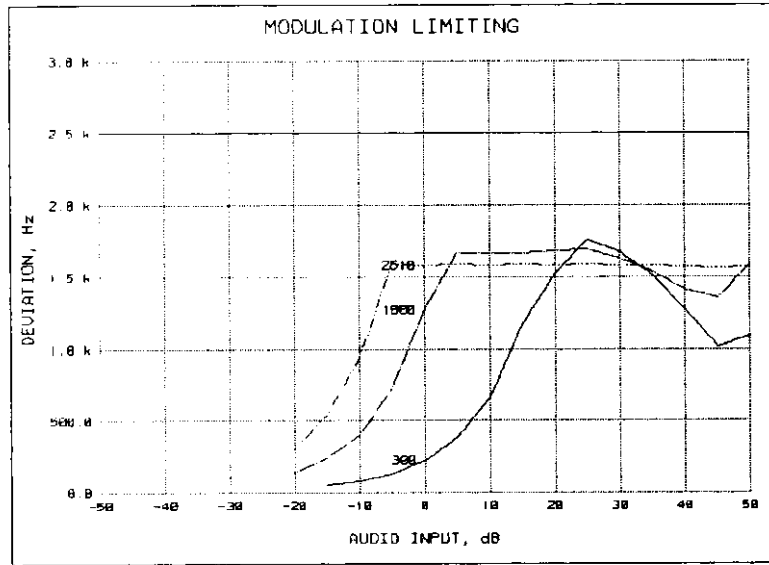
Positive
Peaks:



Negative
Peaks:

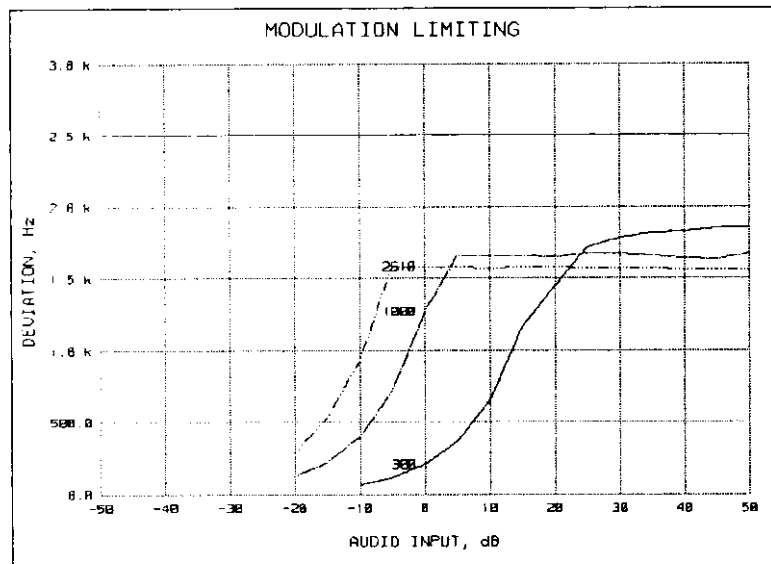

SUPERVISED BY:

William H. Graff, Director
of Engineering

PAGE NO. 37 of 41.
NAME OF TEST: Frequency Stability (Temperature Variation)
SPECIFICATION: 47 CFR 2.1055(a)(1)
GUIDE: ANSI/TIA/EIA-603-1992, Paragraph 2.2.2
TEST CONDITIONS: As Indicated
TEST EQUIPMENT: As per previous page

MEASUREMENT PROCEDURE

1. The EUT and test equipment were set up as shown on the following page.
2. With all power removed, the temperature was decreased to -30°C and permitted to stabilize for three hours. Power was applied and the maximum change in frequency was noted within one minute.
3. With power OFF, the temperature was raised in 10°C steps. The sample was permitted to stabilize at each step for at least one-half hour. Power was applied and the maximum frequency change was noted within one minute.
4. The temperature tests were performed for the worst case.
5. MEASUREMENT RESULTS: ATTACHED

TRANSMITTER TEST SET-UP

- TEST A. OPERATIONAL STABILITY
- TEST B. CARRIER FREQUENCY STABILITY
- TEST C. OPERATIONAL PERFORMANCE STABILITY
- TEST D. HUMIDITY
- TEST E. VIBRATION
- TEST F. ENVIRONMENTAL TEMPERATURE
- TEST G. FREQUENCY STABILITY: TEMPERATURE VARIATION
- TEST H. FREQUENCY STABILITY: VOLTAGE VARIATION

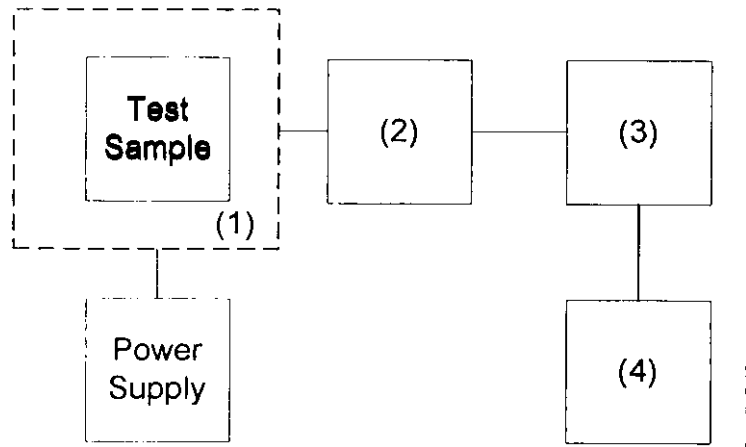

Asset	Description	s/n
<u>(1) TEMPERATURE, HUMIDITY, VIBRATION</u>		
<u>x</u>	i00027 Tenny Temp. Chamber	9083-765-234
___	i00 Weber Humidity Chamber	
___	i00 L.A.B. RVH 18-100	
<u>(2) COAXIAL ATTENUATOR</u>		
___	i00122 NARDA 766-10	7802
___	i00123 NARDA 766-10	7802A
<u>x</u>	i00113 SIERRA 661A-3D	1059
___	i00069 BIRD 8329 (30 dB)	10066
<u>(3) R.F. POWER</u>		
___	i00014 HP 435A POWER METER	1733A05839
<u>x</u>	i00039 HP 436A POWER METER	2709A26776
<u>x</u>	i00020 HP 8901A POWER MODE	2105A01087
<u>(4) FREQUENCY COUNTER</u>		
___	i00042 HP 5383A	1628A00959
<u>x</u>	i00019 HP 5334B	2704A00347
<u>x</u>	i00020 HP 8901A	2105A01087

PAGE NO.

39 of 41.

NAME OF TEST: Frequency Stability (Temperature Variation)
g9980043: 1999-Aug-17 Tue 09:52:00
STATE: 0:General

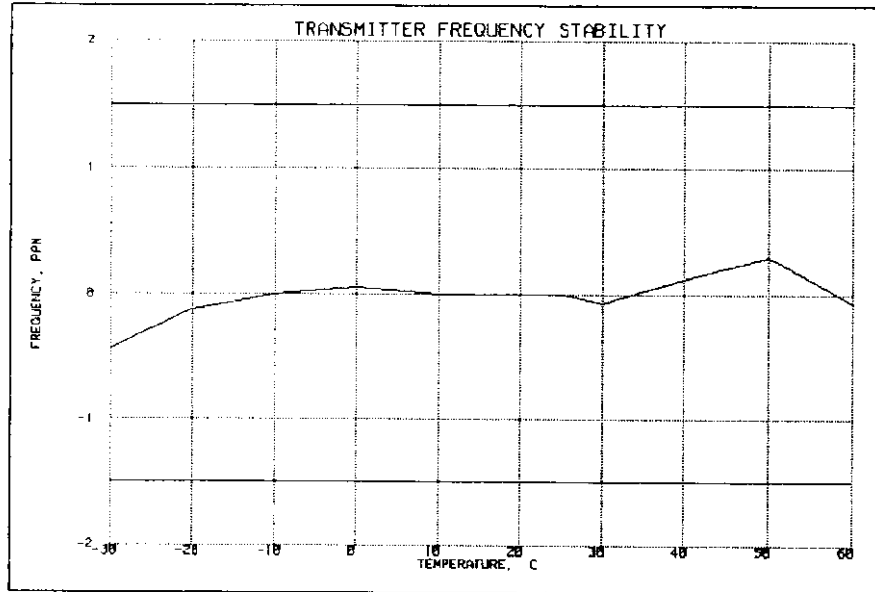

SUPERVISED BY:

William H. Graff, Director
of Engineering

PAGE NO. 40 of 41.
NAME OF TEST: Frequency Stability (Voltage Variation)
SPECIFICATION: 47 CFR 2.1055(b) (1)
GUIDE: ANSI/TIA/EIA-603-1992, Paragraph 2.2.2
TEST EQUIPMENT: As per previous page

MEASUREMENT PROCEDURE

1. The EUT was placed in a temperature chamber at 25±5°C and connected as for "Frequency Stability - Temperature Variation" test.
2. The power supply voltage to the EUT was varied from 85% to 115% of the nominal value measured at the input to the EUT.
3. The variation in frequency was measured for the worst case.

RESULTS: Frequency Stability (Voltage Variation)
g9980101: 1999-Aug-18 Wed 15:21:04
STATE: 0:General

LIMIT, ppm = 2.5
LIMIT, Hz = 388
BATTERY END POINT (Voltage) = 8.7

% of STV	Voltage	Frequency, MHz	Change, Hz	Change, ppm
85	11.73	155.000000	0	0.00
100	13.8	155.000000	0	0.00
115	15.87	154.999990	-10	-0.06
63	8.7	155.000000	0	0.00

SUPERVISED BY:



William H. Graff, Director
of Engineering

PAGE NO. 41 of 41.
NAME OF TEST: Necessary Bandwidth and Emission Bandwidth
SPECIFICATION: 47 CFR 2.202(g)

MODULATION = 16K0F3E

NECESSARY BANDWIDTH CALCULATION:

MAXIMUM MODULATION (M), kHz = 3
 MAXIMUM DEVIATION (D), kHz = 5
 CONSTANT FACTOR (K) = 1
 NECESSARY BANDWIDTH (B_N), kHz = (2 x M) + (2 x D x K)
 = 16.0

MODULATION = 11K0F3E

NECESSARY BANDWIDTH CALCULATION:

MAXIMUM MODULATION (M), kHz = 3
 MAXIMUM DEVIATION (D), kHz = 2.5
 CONSTANT FACTOR (K) = 1
 NECESSARY BANDWIDTH (B_N), kHz = (2 x M) + (2 x D x K)
 = 11.0

SUPERVISED BY:



 William H. Graff, Director
 of Engineering

TESTIMONIAL
AND
STATEMENT OF CERTIFICATION

THIS IS TO CERTIFY THAT:

1. THAT the application was prepared either by, or under the direct supervision of, the undersigned.
2. THAT the technical data supplied with the application was taken under my direction and supervision.
3. THAT the data was obtained on representative units, randomly selected.
4. THAT, to the best of my knowledge and belief, the facts set forth in the application and accompanying technical data are true and correct.

CERTIFYING ENGINEER:

William H. Graff, Director
of Engineering