

REV	SYMBOL	REVISION NO	CODE	ISSUED
19	△ X	Y54-3140-10		
18	△ X			
17	△ X			
16	△ X			
15	△ X			

DESIGNED	DRAWN	CHECKED	APPROVED	PARTS NAME
	99/JUL/12			TKR-740 (EX)
	T. SATO			松尾電機
				PARTS NUMBER
				Z83-3070-03 1/

TKR

KENWOOD CORPORATION

page: TKR740

time: 0416 22-JUL-88

name: scadb directory: /users/sch/work/e5231

comment: #265703 704

Part	Last REF No	Absence REF No
R	R88	R55, R56, R75, R76, R80-83
C	C82	C18, C44, C48, C49, C61
D	D1	D10, D16, D18, D20
IC	IC4	-
D	D82	D8-10, D13-14
R	R180	R103, R104, R110, R111, R116, R128-134, R135, R146, R152-176, R187-189
C	C186	C117, C122, C128, C137, C142, C148-164, C176-185
Q	Q116	Q106, Q109, Q109-105, Q111
IC	IC10	IC104
D	D103	D100, D102
R	R276	R200, R209-230, R246, R248, R256, R258
C	C188	C300, C301, C317, C321-330
Q	Q242	Q206, Q204, Q209-239
IC	IC206	-
D	D206	D200
R	R605	R302, R307, R309, R316, R351-353, R361-380, R401, R402, R404-408, R411-410, R601-604
C	C114	C300, C347, C358, C359-412
Q	Q213	Q300, Q301, Q311
IC	IC304	IC300, IC301
D	D500	D300-302, D302, D311, D313-316, D316, 400

Semiconductor Parts List	
16C355	3013, D11, D12, D204, D304, D317, D318
15V285	8D16, 8T, D101, D103
15V289	D1-6, D201-203
05C215(K, Y)	D12
830-2148-05	D58
830-2130-05	D50, D51
09Y941	D509
83C-4148220M	1009
KS4845	D205, D306, 308
MM1000C07-02	D306, D310
MM1000C08	D500
UX24, Y (R)	D303
28B01A(3)	IC06, Q309
28B1386(2)	Q11
28C3120	Q6, Q9, Q107
28C3336	Q13
28C372K(5)	Q3, C4, Q17
28C4091(8)	Q101
28C4215(7)	Q102, Q104, Q106, Q109, Q115, Q201, Q202, Q206, C250-242
28C502(7)	Q15
28F009P/K52	Q1, Q2
28Y1824	Q1, Q17, Q18, Q112, Q113, Q205, Q206, Q208
28Y2598	Q14
DTA1481A	Q216, Q114
DTCL1481A	Q205, Q201, Q19, Q207, Q205, Q218, Q215

PM01
1M02
UN05
AR583800
AT4249010C12, 5
BM0948CFV
MC2044P
MS7574
NJ4781070A
NJ4781080A
NJ4781090A
NJ4781100A
NJ4781110A
NJ4781120A
NJ4781130A
NJ4781140A
NJ4781150A
NJ4781160A
NJ4781170A
NJ4781180A
NJ4781190A
NJ4781200A
NJ4781210A
NJ4781220A
NJ4781230A
NJ4781240A
NJ4781250A
NJ4781260A
NJ4781270A
NJ4781280A
NJ4781290A
NJ4781300A
NJ4781310A
NJ4781320A
NJ4781330A
NJ4781340A
NJ4781350A
NJ4781360A
NJ4781370A
NJ4781380A
NJ4781390A
NJ4781400A
NJ4781410A
NJ4781420A
NJ4781430A
NJ4781440A
NJ4781450A
NJ4781460A
NJ4781470A
NJ4781480A
NJ4781490A
NJ4781500A
NJ4781510A
NJ4781520A
NJ4781530A
NJ4781540A
NJ4781550A
NJ4781560A
NJ4781570A
NJ4781580A
NJ4781590A
NJ4781600A
NJ4781610A
NJ4781620A
NJ4781630A
NJ4781640A
NJ4781650A
NJ4781660A
NJ4781670A
NJ4781680A
NJ4781690A
NJ4781700A
NJ4781710A
NJ4781720A
NJ4781730A
NJ4781740A
NJ4781750A
NJ4781760A
NJ4781770A
NJ4781780A
NJ4781790A
NJ4781800A
NJ4781810A
NJ4781820A
NJ4781830A
NJ4781840A
NJ4781850A
NJ4781860A
NJ4781870A
NJ4781880A
NJ4781890A
NJ4781900A
NJ4781910A
NJ4781920A
NJ4781930A
NJ4781940A
NJ4781950A
NJ4781960A
NJ4781970A
NJ4781980A
NJ4781990A
NJ4782000A

X56-3040-10 A73

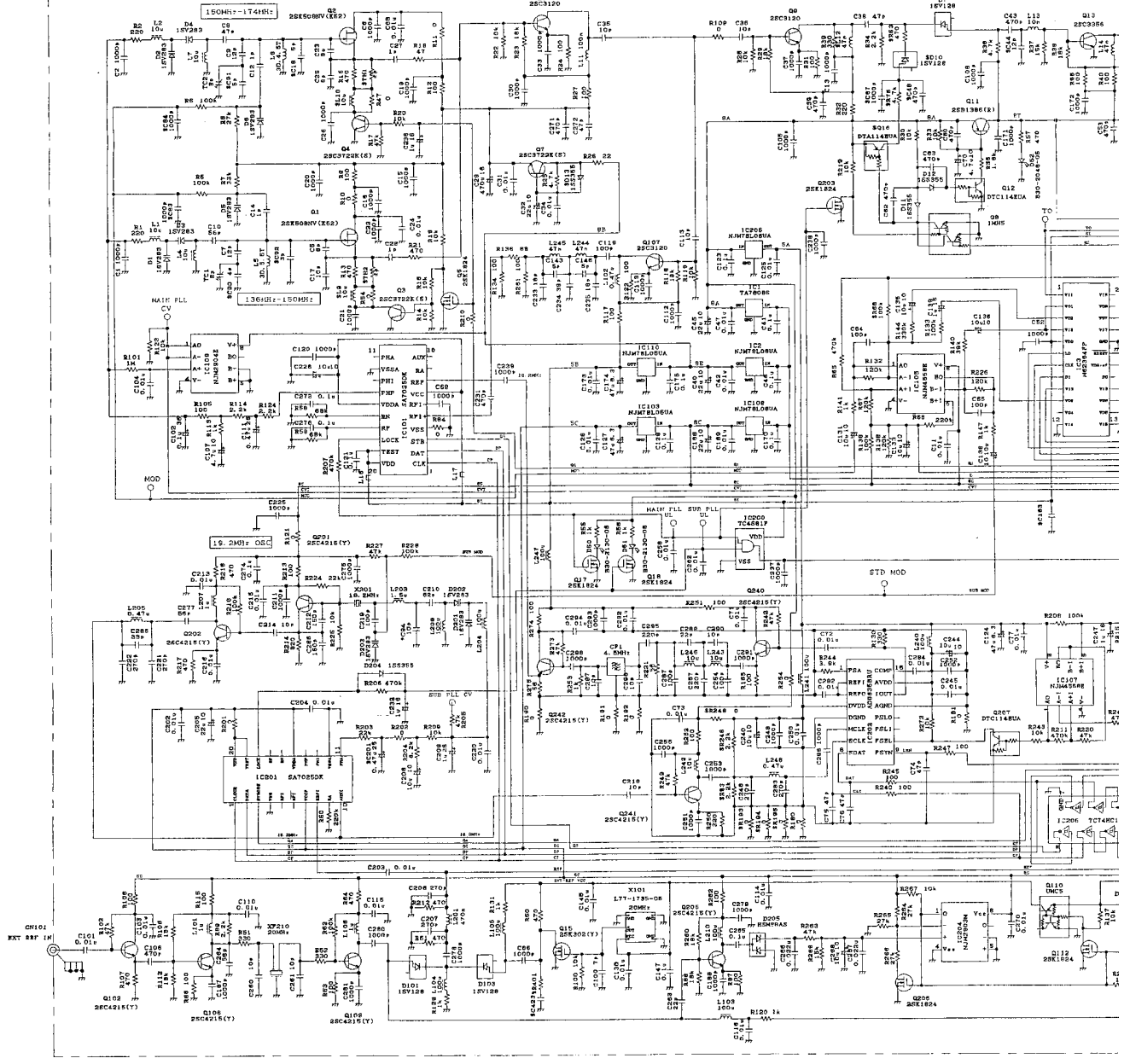

C307, C310
 C308, C304
 C21, C110, C308
 IC002
 IC108
 IC1
 IC3
 IC103
 IC103, IC110, IC205
 IC2, IC108
 IC204
 IC109, IC202
 IC105, IC107
 IC309, IC303
 IC101, IC201
 IC100, IC102
 IC1
 IC200
 IC204
 IC205

USE FOR	SYMBOL	REVISION NO	CODE	ISSUED	DATE
X56-3040-10	△ X				19
	△ X				19
	△ X				19
	△ X				19
	△ X				19
	△ X				19
	△ X				19
	△ X				19

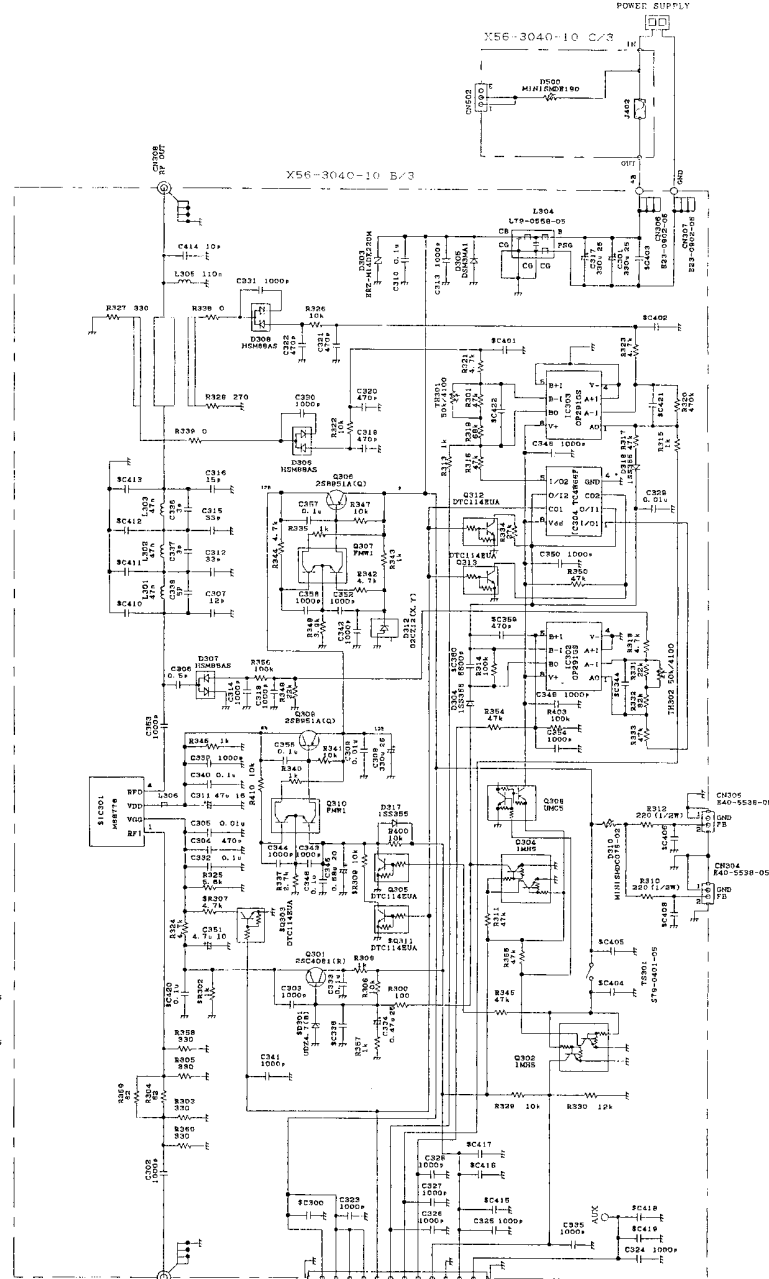
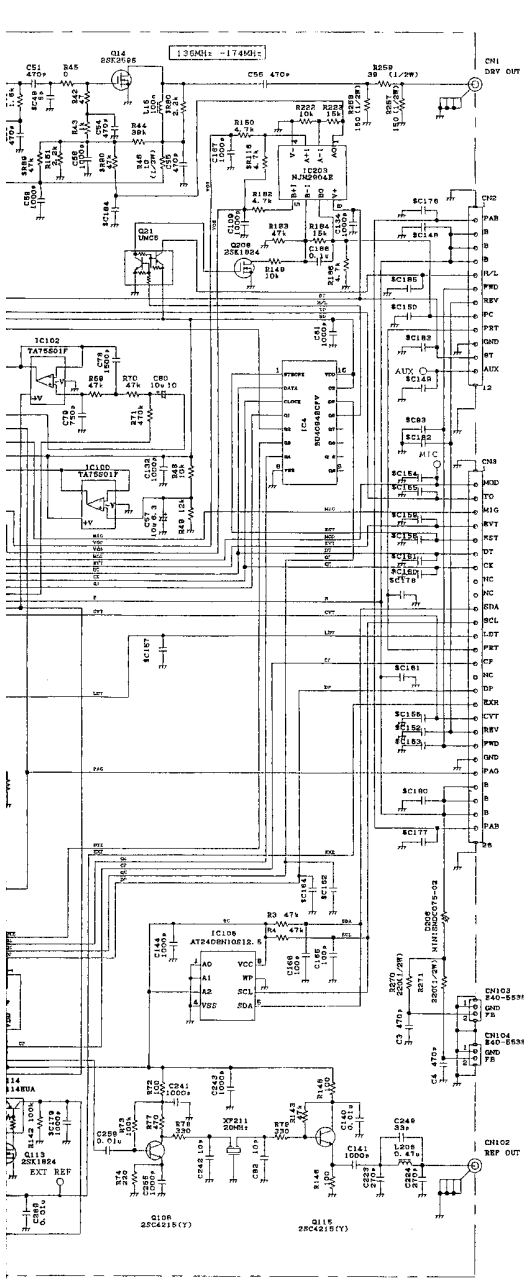

Destination	
RFD0	R604
R601	R603
R602	R606
R603	R607

TKR-740

DESIGNED	DRAWN	CHECKED	APPROVED	PARTS NAME
26/JUN/1999	28/JUN/1999			ユニット配線図
T. SATO	T. SATO			SCHEMATIC DIAGRAM
				PARTS NUMBER
				Z92-0696-01 1/1 00

株式会社ケンウッド KENWOOD CORPORATION

0-12	-	0	19*	2*	12*	27*	15*	11*	22*	27*	2*	-172*	-159*	-459*	-172*	2*	
0-11	0	0	15*	1000*	2*	18*	-	-	18*	4*	-	-172*	-459*	-459*	-172*	-	
0-10	0	-	15*	1000*	10*	22*	-	-	22*	4*	-	-172*	-459*	-459*	-172*	-	
	R27	R28	R31	C33	C70	C78	C30	C36	C27	C37	C20	C22	L3	L8	L10	L16	L25

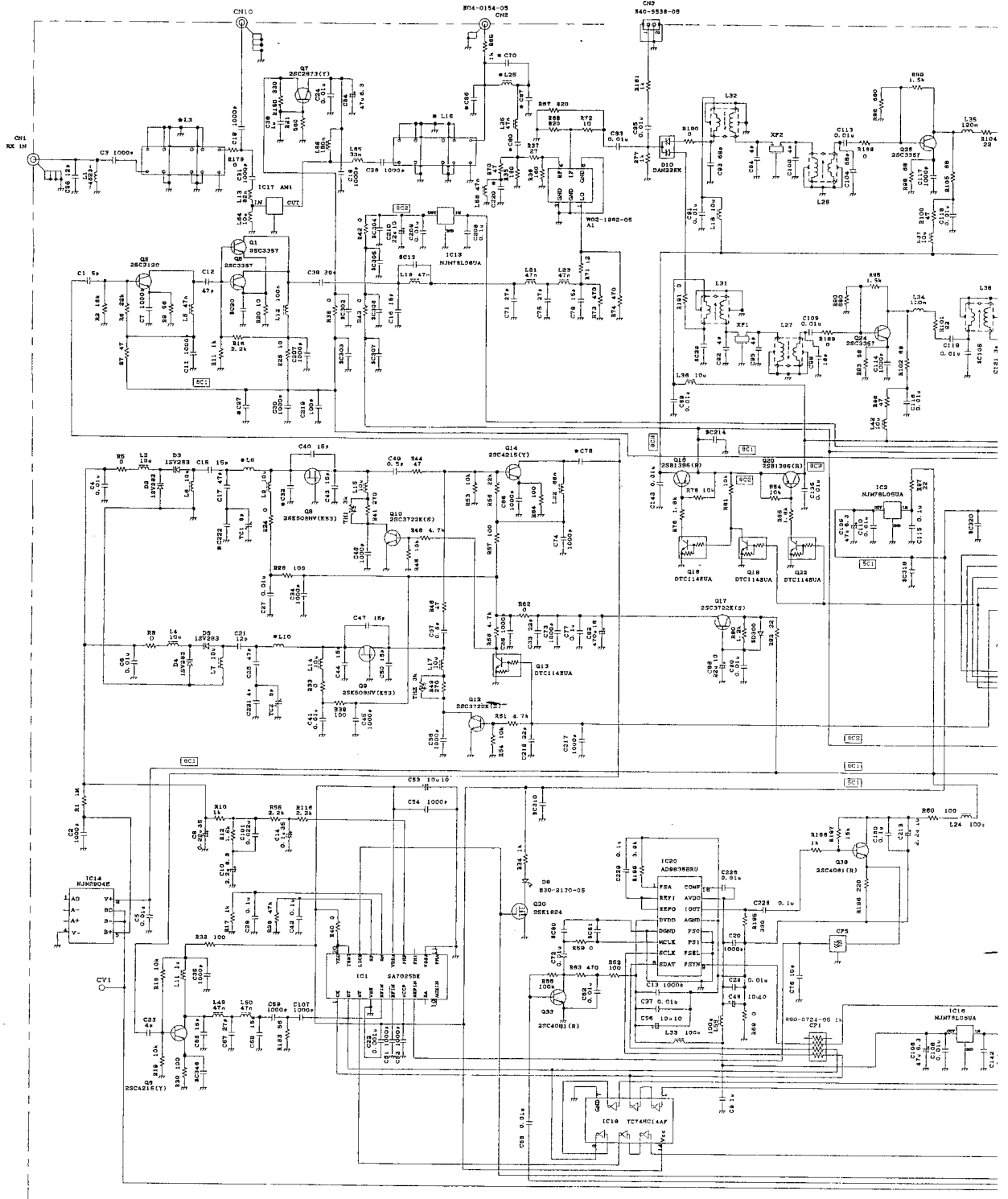

USE FOR	SYMBOL	REVISION NO	CODE	ISSUED	DATE
XSS-3050-10	X				19
XSS-3050-11	X				19
XSS-3050-12	X				19
	X				19
	X				19
	X				19
	X				19
	X				19

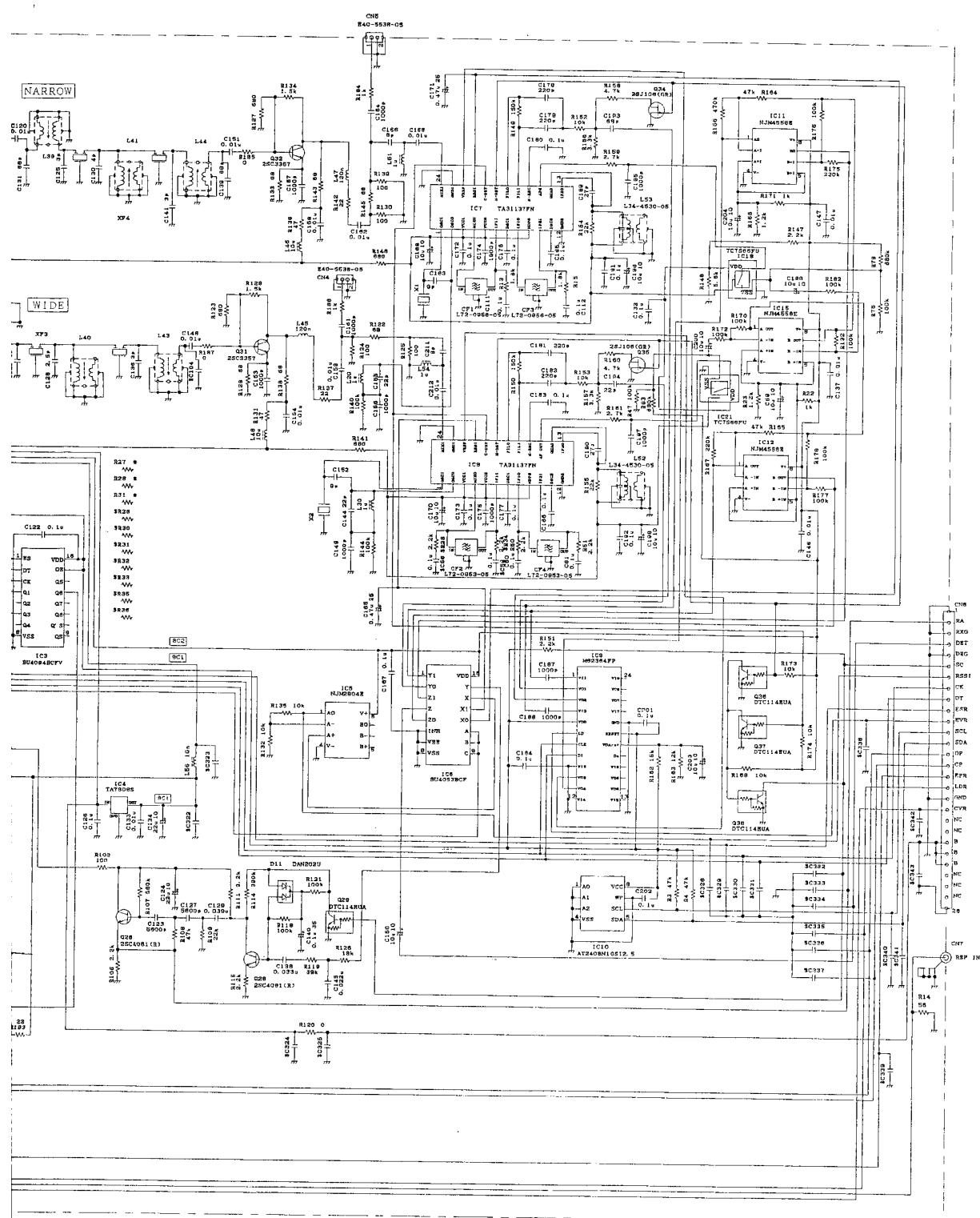

TKR-740

DESIGNED	DRAWN	CHECKED	APPROVED	PARTS NAME	TKR-740 AX UNIT
13/JUL/1999	13/JUL/1999			ユニット配線図	
K. MIYAKOSHI	K. MIYAKOSHI			SCHEMATIC DIAGRAM	
				PARTS NUMBER	
株式会社ケンウッド KENWOOD CORPORATION					Z92-0693-01 1/1 00

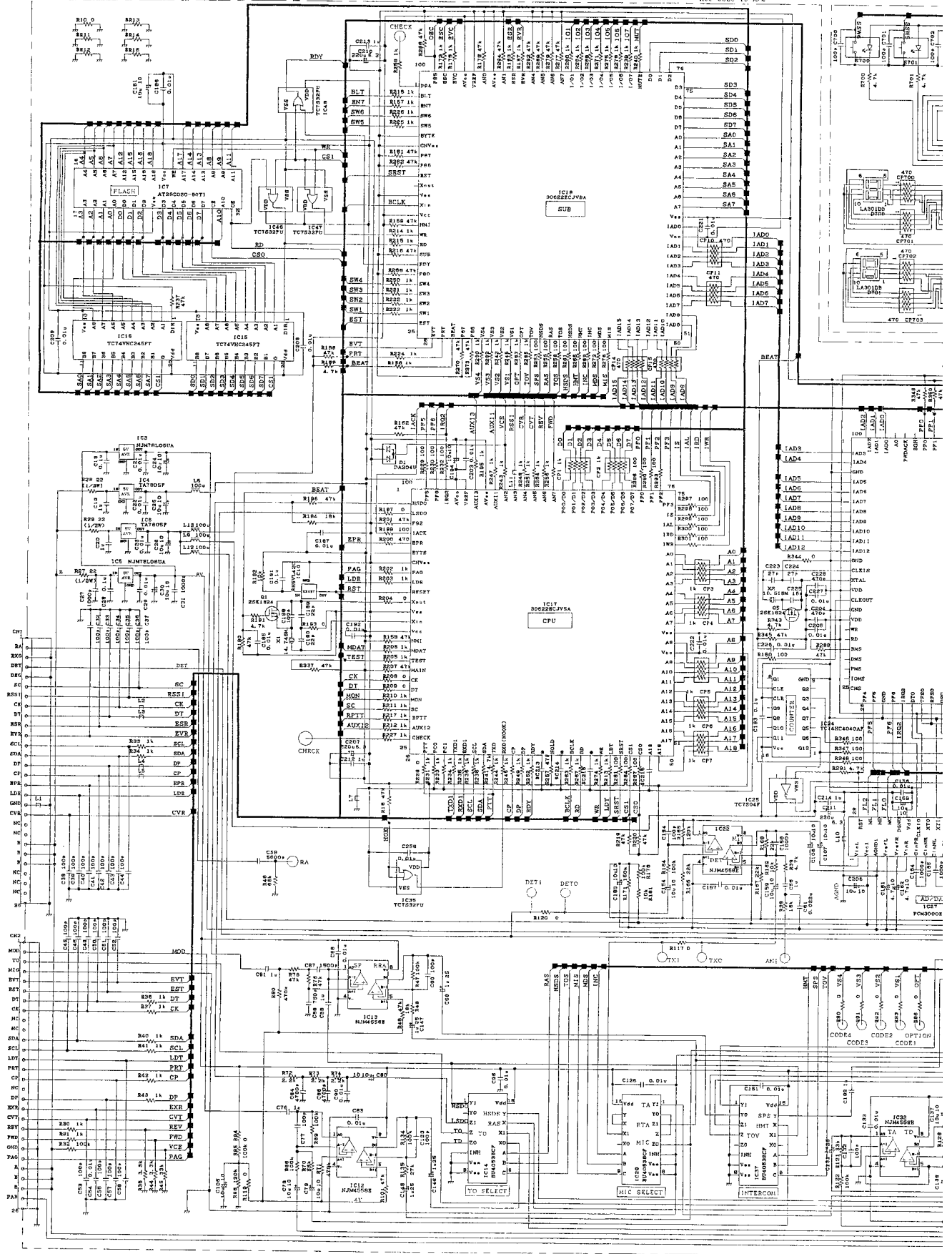

USE FOR	SYMBOL	REVISION NO	CODE	ISSUED	DATE
X52-389C-10	△				10
	×				10
	△				10
	×				10
	△				10
	×				10
	△				10
	×				10
	△				10
	×				10

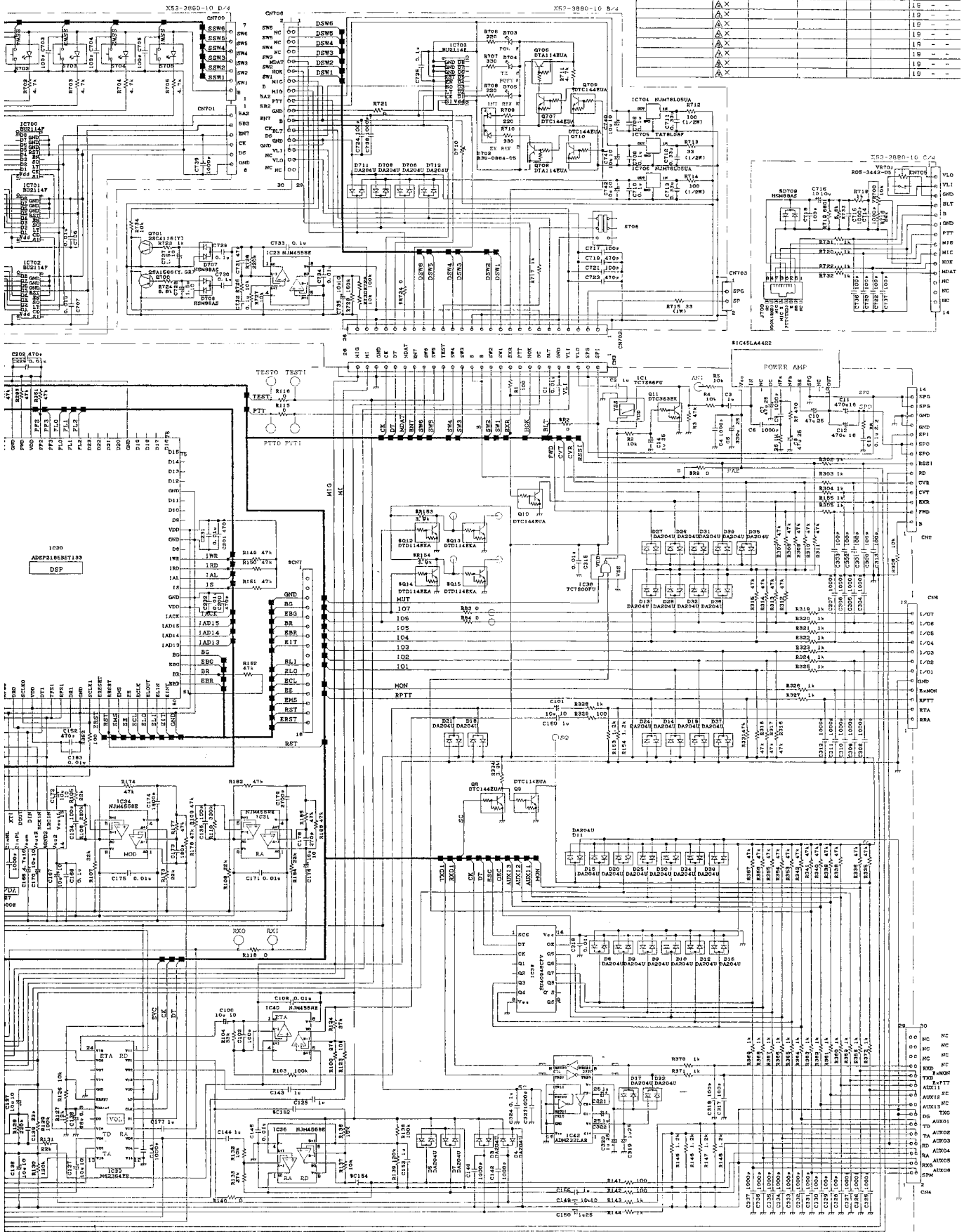

T KR-740

DESIGNED	DRAWN	CHECKED	APPROVED	PARTS NAME (EX-3065 CONTROL UNIT)
11/JAN/1999	2/JULY/1999			ユニット回路図
Y. SAITOU	Y. SAITOU			SCHEMATIC DIAGRAM
				PARTS NUMBER
株式会社ケンウッド				KENWOOD CORPORATION
				Z92-0695-01 1/1 00