

PAGE NO.

1 of 39.

Required information per ISO/IEC Guide 25-1990, paragraph 13.2:

- a) TEST REPORT
- b) Laboratory: M. Flom Associates, Inc.
 (FCC: 31040/SIT) 3356 N. San Marcos Place, Suite 107
 (Canada: IC 2044) Chandler, AZ 85224
- c) Report Number: d9890015
- d) Client: Kenwood Communications Corporation
 P.O. Box 22745
 Long Beach, CA 90801-5745
- e) Identification: TK-2100
 FCC ID: ALH27293110
 Description: Handheld Transceiver
- f) EUT Condition: Not required unless specified in individual tests.
- g) Report Date: September 10, 1998
 EUT Received: 1998-Sep-02
- h, j, k): As indicated in individual tests.
- i) Sampling method: No sampling procedure used.
- l) Uncertainty: In accordance with MFA internal quality manual.
- m) Supervised by: 
 Morton Flom, P. Eng.
- n) Results: The results presented in this report relate only to the item tested.
- o) Reproduction: This report must not be reproduced, except in full, without written permission from this laboratory.

PAGE NO.

2 of 39.

LIST OF GENERAL INFORMATION REQUIRED FOR TYPE ACCEPTANCEIN ACCORDANCE WITH FCC RULES AND REGULATIONS,
VOLUME II, PART 2 AND TO

22, 74, 80, 90

Sub-part2.983(a): NAME AND ADDRESS OF APPLICANT:Kenwood Communications Corporation
2201 E. Dominguez St
P.O. Box 22745
Long Beach, CA 90801-5745VENDOR:Kenwood Communications Corporation
P.O. Box 22745
Long Beach, CA 90801-57452.983(b): FCC ID: ALH27293110MODEL NO: TK-21002.983(c): QUANTITY PRODUCTION PLANNED.2.983(d): TECHNICAL DESCRIPTION: SEE ATTACHED EXHIBITS(1): TYPE OF EMISSION: 16K0F3E, 11K0F3E(2): FREQUENCY RANGE, MHz: 150 to 160(3): POWER RATING, Watts: 2
___ Switchable ___ Variable x N/A(4): MAXIMUM POWER RATING, Watts: 500

PAGE NO. 3 of 39.

2.983(d)

(5): VOLTAGES & CURRENTS IN ALL ELEMENTS IN FINAL R. F. STAGE, INCLUDING FINAL TRANSISTOR OR SOLID STATE DEVICE:

COLLECTOR CURRENT, A = per manual
 COLLECTOR VOLTAGE, Vdc = per manual
 SUPPLY VOLTAGE, Vdc = 7.5

(6): FUNCTION OF ACTIVE CIRCUIT DEVICES:

PLEASE SEE ATTACHED EXHIBITS

(7): CIRCUIT DIAGRAM:

PLEASE SEE ATTACHED EXHIBITS

(8): MANUAL:

PLEASE SEE ATTACHED EXHIBITS

(9): TUNE-UP PROCEDURE:

PLEASE SEE ATTACHED EXHIBITS

(10): DESCRIPTION OF CIRCUITRY & DEVICES PROVIDED FOR DETERMINING AND STABILIZING FREQUENCY:

PLEASE SEE ATTACHED EXHIBITS

(11): DESCRIPTION OF CIRCUITS OR DEVICES EMPLOYED FOR

- (a) SUPPRESSION OF SPURIOUS RADIATION,
- (b) LIMITING MODULATION,
- (c) LIMITING POWER:

PLEASE SEE ATTACHED EXHIBITS

(12): DIGITAL MODULATION DESCRIPTION:

ATTACHED EXHIBITS	
N/A	<u>X</u>

2.983(e): TEST AND MEASUREMENT DATA:

FOLLOWS

2.983(f): LABEL INFORMATION:

PLEASE SEE ATTACHED EXHIBITS

2.983(g): PHOTOGRAPHS:

PLEASE SEE ATTACHED EXHIBITS

PAGE NO.

4 of 39.

Sub-part
2.983(e):TEST AND MEASUREMENT DATA

All tests and measurement data shown were performed in accordance with FCC Rules and Regulations, Volume II; Part 2, Sub-part J, Sections 2.981, 2.983, 2.985, 2.987, 2.989, 2.991, 2.993, 2.995, 2.997, 2.999 and the following individual Parts:

- 21 - Domestic Public Fixed Radio Services
- 22 - Public Mobile Services
- 22 Subpart H - Cellular Radiotelephone Service
- 22.901(d) - Alternative technologies and auxiliary services
- 23 - International Fixed Public Radiocommunication services
- 24 - Personal Communications Services
- 74 Subpart H - Low Power Auxiliary Stations
- 80 - Stations in the Maritime Services
- 80 Subpart E - General Technical Standards
- 80 Subpart F - Equipment Authorization for Compulsory Ships
- 80 Subpart K - Private Coast Stations and Marine Utility Stations
- 80 Subpart S - Compulsory Radiotelephone Installations for Small Passenger Boats
- 80 Subpart T - Radiotelephone Installation Required for Vessels on the Great Lakes
- 80 Subpart U - Radiotelephone Installations Required by the Bridge-to-Bridge Act
- 80 Subpart V - Emergency Position Indicating Radiobeacons (EPIRB'S)
- 80 Subpart W - Global Maritime Distress and Safety System (GMDSS)
- 80 Subpart X - Voluntary Radio Installations
- 87 - Aviation Services
- 90 - Private Land Mobile Radio Services
- 94 - Private Operational-Fixed Microwave Service
- 95 Subpart A - General Mobile Radio Service (GMRS)
- 95 Subpart C - Radio Control (R/C) Radio Service
- 95 Subpart D - Citizens Band (CB) Radio Service
- 95 Subpart E - Family Radio Service
- 95 Subpart F - Interactive Video and Data Service (IVDS)
- 101 - Fixed Microwave Services

PAGE NO.

5 of 39.

STANDARD TEST CONDITIONS
and
ENGINEERING PRACTICES

Except as noted herein, the following conditions and procedures were observed during the testing:

In accordance with ANSI C63.4-1992, section 6.1.9, and unless otherwise indicated in the specific measurement results, the ambient temperature of the actual EUT was maintained within the range of 10° to 40°C (50° to 104 °F) unless the particular equipment requirements specify testing over a different temperature range. Also, unless otherwise indicated, the humidity levels were in the range of 10% to 90% relative humidity.

Prior to testing, the EUT was tuned up in accordance with the manufacturer's alignment procedures. All external gain controls were maintained at the position of maximum and/or optimum gain throughout the testing.

Measurement results, unless otherwise noted, are worst case measurements.

PAGE NO. 6 of 39.

NAME OF TEST: Carrier Output Power (Conducted)

SPECIFICATION: FCC: 47 CFR 2.985(a)
IC: RSS-119, Section 6.2

GUIDE: TIA/EIA-603, Paragraph 2.2.1

TEST EQUIPMENT: As per attached page

MEASUREMENT PROCEDURE

1. The EUT was connected to a resistive coaxial attenuator of normal load impedance, and the unmodulated output power was measured by means of an R. F. Power Meter.
2. Measurement accuracy is $\pm 3\%$.

MEASUREMENT RESULTS

FREQUENCY OF CARRIER, MHz = 151.955, 150.05, 159.95

POWER SETTING	R. F. POWER, WATTS
High	2

SUPERVISED BY:

Morton Flom, P. Eng.

TRANSMITTER POWER CONDUCTED MEASUREMENTS

TEST 1: R. F. POWER OUTPUT
 TEST 2: FREQUENCY STABILITY

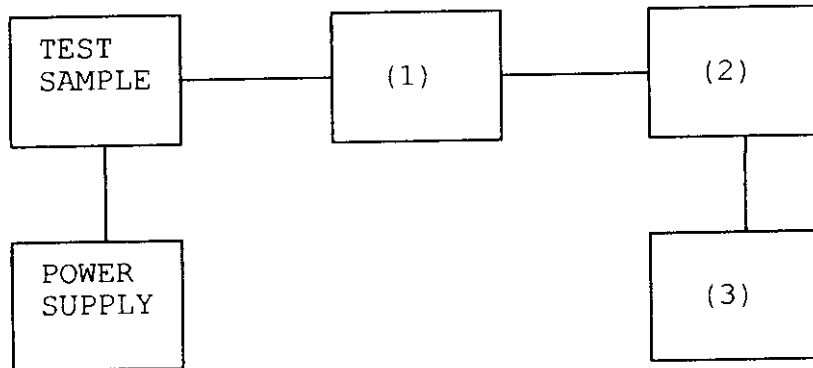

Asset Description s/n

<u>(1) COAXIAL ATTENUATOR</u>		
_____	i00122 Narda 766-10	7802
_____	i00123 Narda 766-10	7802A
_____	i00069 Bird 8329 (30 dB)	1006
<u>x</u>	i00113 Sierra 661A-3D	1059
<u>(2) POWER METERS</u>		
_____	i00014 HP 435A	1733A05836
<u>x</u>	i00039 HP 436A	2709A26776
<u>x</u>	i00020 HP 8901A POWER MODE	2105A01087
<u>(3) FREQUENCY COUNTER</u>		
_____	i00042 HP 5383A	1628A00959
<u>x</u>	i00019 HP 5334B	2704A00347
<u>x</u>	i00020 HP 8901A FREQUENCY MODE	2105A01087

PAGE NO. 8 of 39.
NAME OF TEST: Unwanted Emissions (Transmitter Conducted)
SPECIFICATION: FCC: 47 CFR 2.991
 IC: RSS-119, Section 6.3
GUIDE: TIA/EIA-603, Paragraph 2.2.13
TEST EQUIPMENT: As per attached page

MEASUREMENT PROCEDURE

1. The emissions were measured for the worst case as follows:
 - (a): within a band of frequencies defined by the carrier frequency plus and minus one channel.
 - (b): from the lowest frequency generated in the EUT and to at least the 10th harmonic of the carrier frequency, or 40 GHz, whichever is lower.
2. The magnitude of spurious emissions that are attenuated more than 20 dB below the permissible value need not be specified.

3. MEASUREMENT RESULTS: ATTACHED FOR WORST CASE

FREQUENCY OF CARRIER, MHz = 151.955, 150.05, 159.95
 SPECTRUM SEARCHED, GHz = 0 to 10 x F_c
 MAXIMUM RESPONSE, Hz = 2510
 ALL OTHER EMISSIONS = ≥ 20 dB BELOW LIMIT
 LIMIT(S), dBc
 -(43+10xLOG P) = -46 (2 Watts)

Morton Flom, P. Eng.

SUPERVISED BY:

TRANSMITTER SPURIOUS EMISSION

TEST A. OCCUPIED BANDWIDTH (IN-BAND SPURIOUS)
 TEST B. OUT-OF-BAND SPURIOUS

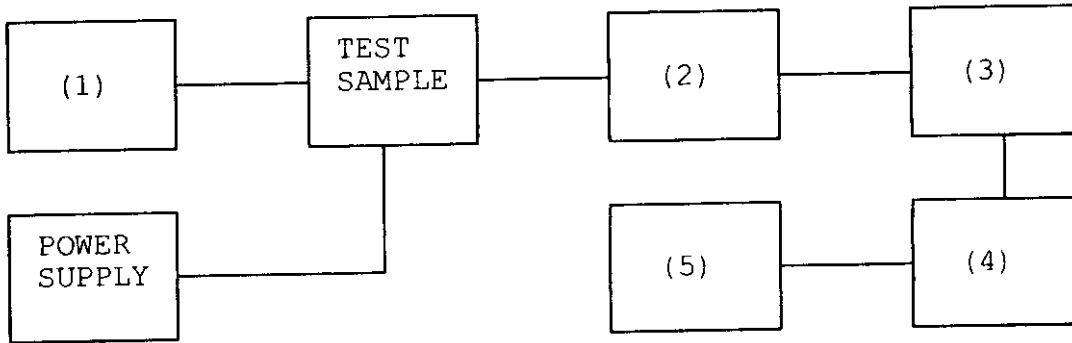

Asset	Description	s/n
(1)	<u>AUDIO OSCILLATOR/GENERATOR</u>	
—	i00010 HP 204D	1105A04683
—	i00017 HP 8903A	2216A01753
x	i00012 HP 3312A	1432A11250
(2)	<u>COAXIAL ATTENUATOR</u>	
—	i00122 Narda 766-10	7802
—	i00123 Narda 766-10	7802A
x	i00069 Bird 8329 (30 dB)	1006
x	i00113 Sierra 661A-3D	1059
(3)	<u>FILTERS; NOTCH, HP, LP, BP</u>	
x	i00126 Eagle TNF-1	100-250
x	i00125 Eagle TNF-1	50-60
x	i00124 Eagle TNF-1	250-850
(4)	<u>SPECTRUM ANALYZER</u>	
x	i00048 HP 8566B	2511A01467
—	i00029 HP 8563E	3213A00104
(5)	<u>SCOPE</u>	
—	i00058 HP 1741A	2251A09356
—	i00030 HP 54502A	2927A00209
—	i00071 Tektronix 935	1935-B011343

PAGE NO.

10 of 39.

NAME OF TEST: Unwanted Emissions (Transmitter Conducted)
 g9890028: 1998-Sep-04 Fri 10:51:00
 STATE: 2:High Power

FREQUENCY TUNED, MHz	FREQUENCY EMISSION, MHz	LEVEL, dBm	LEVEL, dBc	LEVEL, uV
151.95500	304.228000	-43.8	-76.8	0
151.95500	456.352000	-44.9	-77.9	0
151.95500	608.218000	-44.3	-77.3	0
151.95500	760.035000	-44.4	-77.4	0
151.95500	912.007000	-44.9	-77.9	0
151.95500	1063.370000	-45.5	-78.5	0
151.95500	1215.745000	-44.8	-77.8	0
151.95500	1367.344000	-44.6	-77.6	0
151.95500	1519.569000	-44.3	-77.3	0
151.95500	1671.191000	-43.9	-76.9	0
151.95500	1823.580000	-44.6	-77.6	0
151.95500	1975.371000	-43.3	-76.3	0
151.95500	2127.043000	-43.2	-76.2	0
151.95500	2278.929000	-44	-77	0

PAGE NO. 11 of 39.

NAME OF TEST: Field Strength of Spurious Radiation

SPECIFICATION: FCC: 47 CFR 2.993(a)
IC: N/A

GUIDE: TIA/EIA-603, Paragraph 2.2.12

TEST EQUIPMENT: As per attached page

MEASUREMENT PROCEDURE

1. A description of the measurement facilities was filed with the FCC and was found to be in compliance with the requirements of Section 15.38, by letter from the FCC dated March 3, 1997, FILE 31040/SIT. All pertinent changes will be reported to the Commission by up-date prior to March 2000.
2. At first, in order to locate all spurious frequencies and approximate amplitudes, and to determine proper equipment functioning, the test sample was set up at a distance of three meters from the test instrument. Valid spurious signals were determined by switching the power on and off.
3. In the field, the test sample was placed on a wooden turntable above ground at three (or thirty) meters away from the search antenna. The test sample was connected to an R.F. Wattmeter and a 50 ohm dummy load, and adjusted to its rated output.

In order to obtain the maximum response at each spurious frequency, the turntable was rotated. Also, the Search Antennas were raised and lowered vertically, and all cables were oriented. Excess power lead was coiled near the power supply.
4. A signal generator, connected with a non-radiating cable to a vertically polarized half-wave antenna (for each frequency involved) was substituted for the transmitter. The Search Antenna was raised and lowered to obtain maximum indicated.
5. The signal generator output was adjusted until a signal level indication equal to that from the transmitter was obtained.
6. Steps 4 and 5 were repeated, using a horizontally polarized half-wave antenna. The higher of the two observations was noted.

PAGE NO. 12 of 39.
NAME OF TEST: Field Strength of Spurious Radiation
SPECIFICATION: FCC: 47 CFR 2.993(a)
 IC: N/A

MEASUREMENT PROCEDURE (CONT.)

7. Power into the half-wave antenna was calculated from the characteristic impedance of the line, and the voltage output from the signal generator.

8. The level of each spurious radiation with reference to the transmitter power in dB, was calculated from:

$$\text{SPURIOUS LEVEL, dB} = 10 \text{ LOG } \left(\frac{\text{Calculated Spurious Power}}{\text{Tx Power (Wattmeter)}} \right) \text{ [from para. 7].}$$

9. The worst case for all channels is shown.

10. Measurement summary:

FREQUENCY OF CARRIER, MHz = 151.955, 150.05, 159.95
 SPECTRUM SEARCHED, GHz = 0 to 10 x F_c
 MAXIMUM RESPONSE, Hz = 2510
 ALL OTHER EMISSIONS = ≥ 20 dB BELOW LIMIT
 LIMIT(S), dBc
 -(43+10xLOG P) = -46 (2 Watts)

11. Measurement results: ATTACHED FOR WORST CASE

RADIATED TEST SETUP

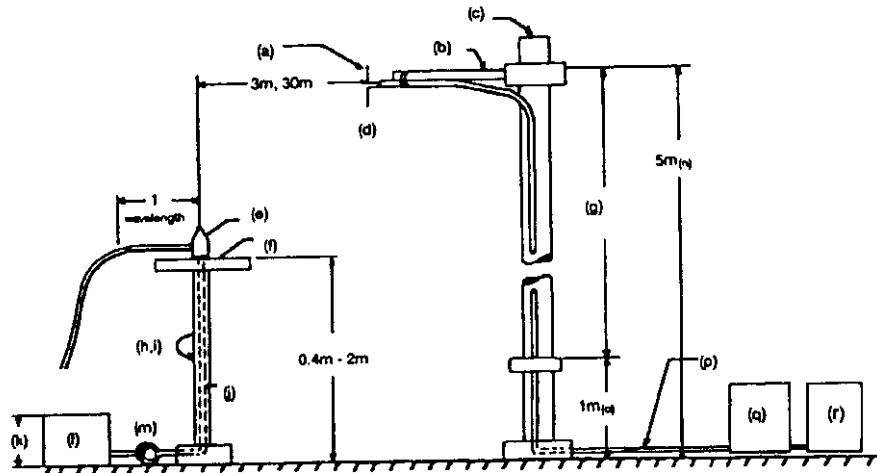

NOTES:

- (a) Search Antenna - Rotatable on boom
- (b) Non-metallic boom
- (c) Non-metallic mast
- (d) Adjustable horizontally
- (e) Equipment Under Test
- (f) Turntable
- (g) Boom adjustable in height.
- (h) External control cables routed horizontally at least one wavelength.
- (i) Rotatable
- (j) Cables routed through hollow turntable center
- (k) 30 cm or less
- (l) External power source
- (m) 10 cm diameter coil of excess cable
- (n) 25 cm (V), 1 m-7 m (V, H)
- (o) 25 cm from bottom end of 'V', 1m normally
- (p) Calibrated Cable at least 10m in length
- (q) Amplifier (optional)
- (r) Spectrum Analyzer

Asset	Description	s/n	Cycle	Last Cal
<u>TRANSDUCER</u>				
___	i00065	EMCO 3109B 100Hz-50MHz	2336	12 month
___	i00033	Singer 94593-1 10kHz-32MHz	0219	12 month
x	i00088	EMCO 3109-B 25MHz-300MHz	2336	12 month none
x	i00089	Apral 2001 200MHz-1GHz	001500	12 month none
x	i00103	EMCO 3115 1GHz-18GHz	9208-3925	12 month none
___	i00085	EMCO 3116 10GHz-40GHz	2076	12 month
<u>AMPLIFIER</u>				
___	i00028	HP 8449A	2749A00121	12 month Mar. 98
<u>SPECTRUM ANALYZER</u>				
___	i00029	HP 8563E	3213A00104	12 month
x	i00033	HP 85462A	3625A00357	12 month Dec. 97
___	i00048	HP 8566B	2511AD1467	6 month 3/19/98

PAGE NO. 14 of 39.

NAME OF TEST: Field Strength of Spurious Radiation

ALL OTHER EMISSIONS = ≥ 20 dB BELOW LIMIT

<u>EMISSION, MHz/HARMONIC</u>	<u>SPURIOUS LEVEL, dBc</u>
2nd to 10th	<-75

SUPERVISED BY:

Morton Flom, P. Eng.

PAGE NO. 15 of 39.

NAME OF TEST: Emission Masks (Occupied Bandwidth)

SPECIFICATION: FCC: 47 CFR 2.989(c)(1)
IC: RSS-119, Section 6.4

GUIDE: TIA/EIA-603, Paragraph 2.2.11

TEST EQUIPMENT: As per previous page

MEASUREMENT PROCEDURE

1. The EUT and test equipment were set up as shown on the following page, with the Spectrum Analyzer connected.
2. For EUTs supporting audio modulation, the audio signal generator was adjusted to the frequency of maximum response and with output level set for ± 2.5 kHz deviation (or 50% modulation). With level constant, the signal level was increased 16 dB.
3. For EUTs supporting digital modulation, the digital modulation mode was operated to its maximum extent.
4. The Occupied Bandwidth was measured with the Spectrum Analyzer controls set as shown on the test results.
5. MEASUREMENT RESULTS: ATTACHED

SPECTRUM ANALYZER PRESENTATION
KENWOOD, TK-2100
1998-SEP-04, 10:13, FRI

POWER: HIGH
MODULATION: NONE

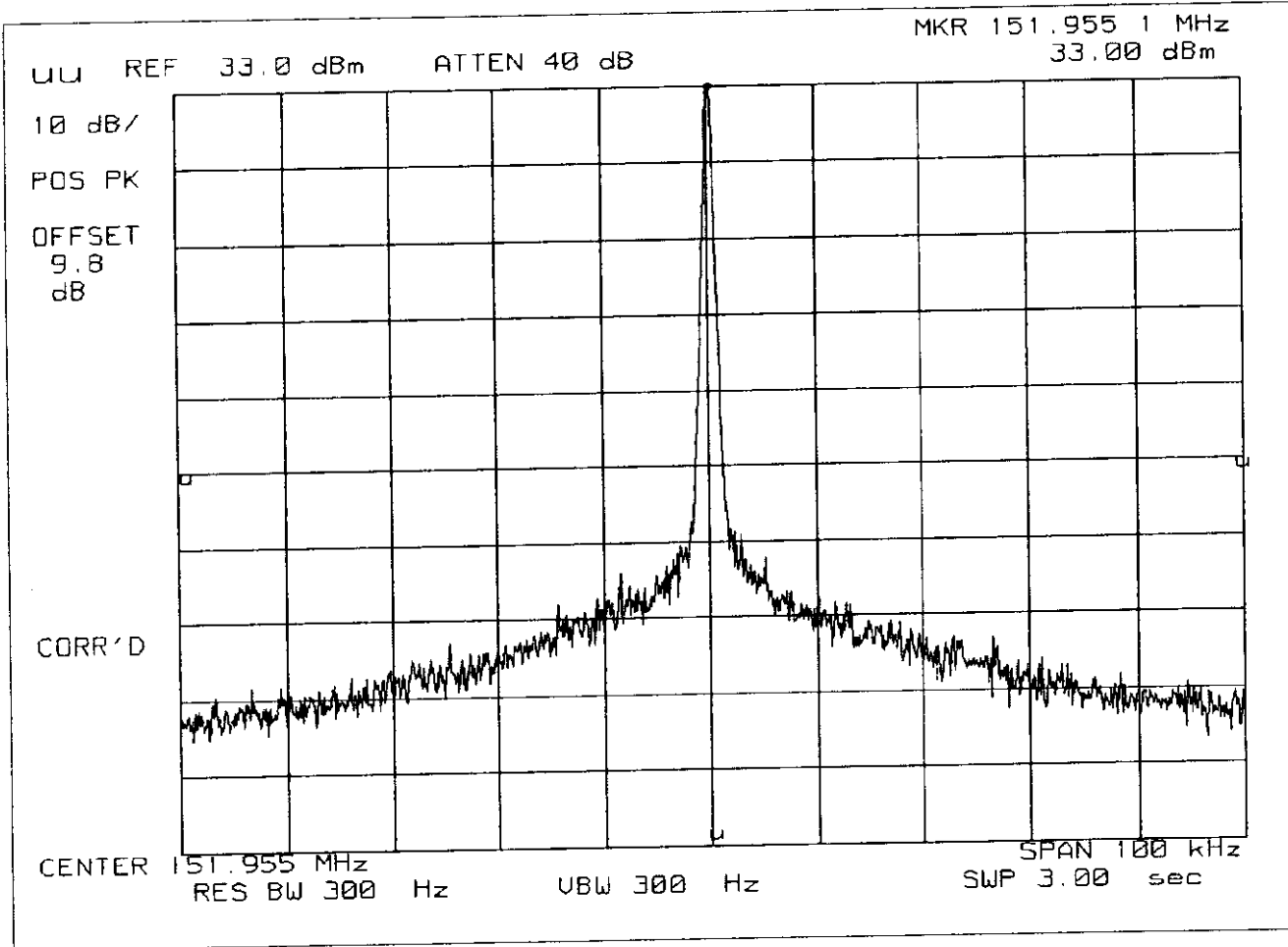

SPECTRUM ANALYZER PRESENTATION

KENWOOD, TK-2100

1998-SEP-04, 10:31, FRI

POWER: HIGH
MODULATION: VOICE: 2500 Hz SINE WAVE
MASK: D, VHF/UHF 12.5kHz BW

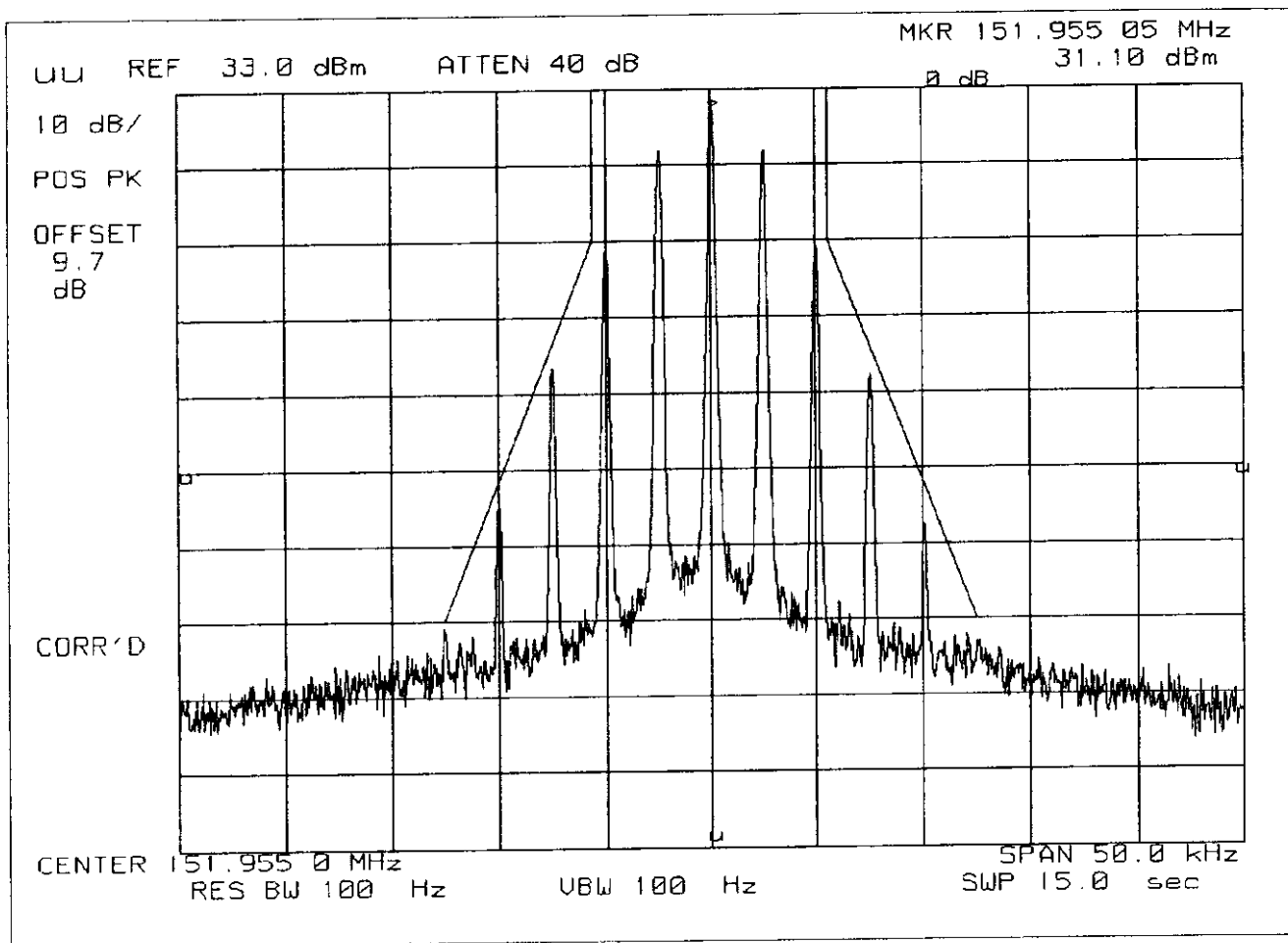

SPECTRUM ANALYZER PRESENTATION
KENWOOD, TK-2100
1998-SEP-04, 10:16, FRI

POWER: HIGH
MODULATION: VOICE: 2500 Hz SINE WAVE
MASK: B, VHF/UHF 25kHz, w/LPF

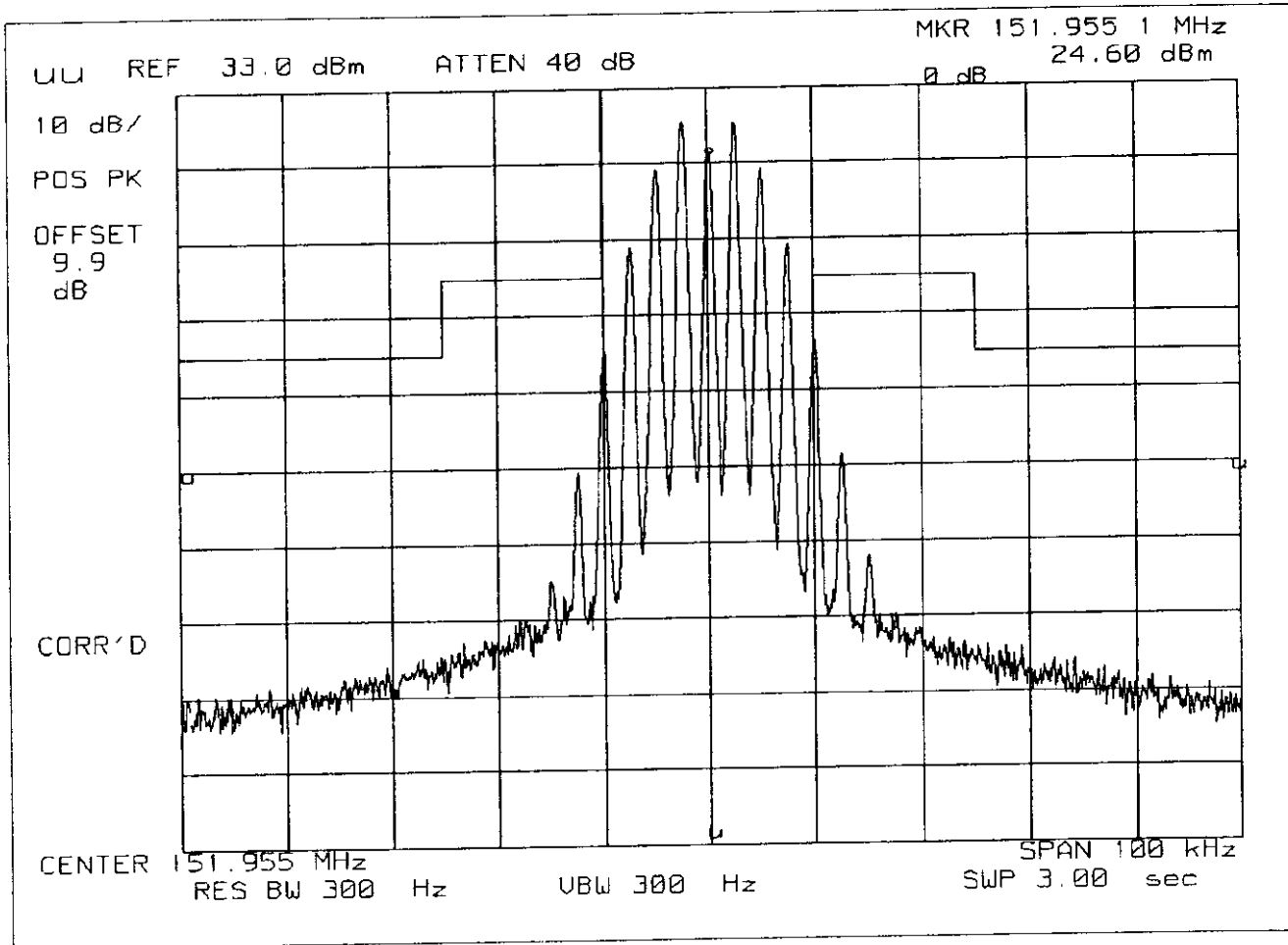

C:\LOCALIZATION\88984885.PLT COPYRIGHT (C) 1998 BY H. FLOM ASSOCIATES, INC. ALL RIGHTS RESERVED

PAGE NO. 19 of 39.

NAME OF TEST: Transient Frequency Behavior

SPECIFICATION: FCC: 47 CFR 90.214
IC: RSS-119, Section 6.5

GUIDE: TIA/EIA-603, Paragraph 2.2.19

TEST EQUIPMENT: As per attached page

MEASUREMENT PROCEDURE

1. The EUT was setup as shown on the attached page, following TIA/EIA-603 steps a, b, and c as a guide.
2. The transmitter was turned on.
3. Sufficient attenuation was provided so that the transmitter carrier level measured at the output of the combiner was 40 dB below the maximum input level of the test receiver. This level was recorded as step f.
4. The transmitter was turned off.
5. An RF signal generator (1) modulated with a 1 kHz tone at either 25, 12.5, or 6.25 kHz deviation, and set to the same frequency as the assigned transmitter frequency, (2) was adjusted to a level -20 dB below the level recorded for step f, as measured at the output of the combiner. This level was then fixed for the remainder of the test and is recorded at step h.
6. The oscilloscope was setup using TIA/EIA-603 steps j and k as a guide, and to either 10 ms/div (UHF) or 5 ms/div (VHF).
7. The 30 dB attenuator was removed, the transmitter was turned on, and the level of the carrier at the output of the combiner was recorded as step l.
8. The carrier on-time as referenced in TIA/EIA-603 steps m, n, and o was captured and plotted. The carrier off-time as referenced in TIA/EIA-603 steps p, q, r, and s was captured and plotted.

LEVELS MEASURED:

step f, dBm	= -20.4
step h, dBm	= -37.1
step l, dBm	= 13.2

Morton Flom P. Eng.

Morton Flom, P. Eng.

SUPERVISED BY:

TRANSIENT FREQUENCY BEHAVIOR

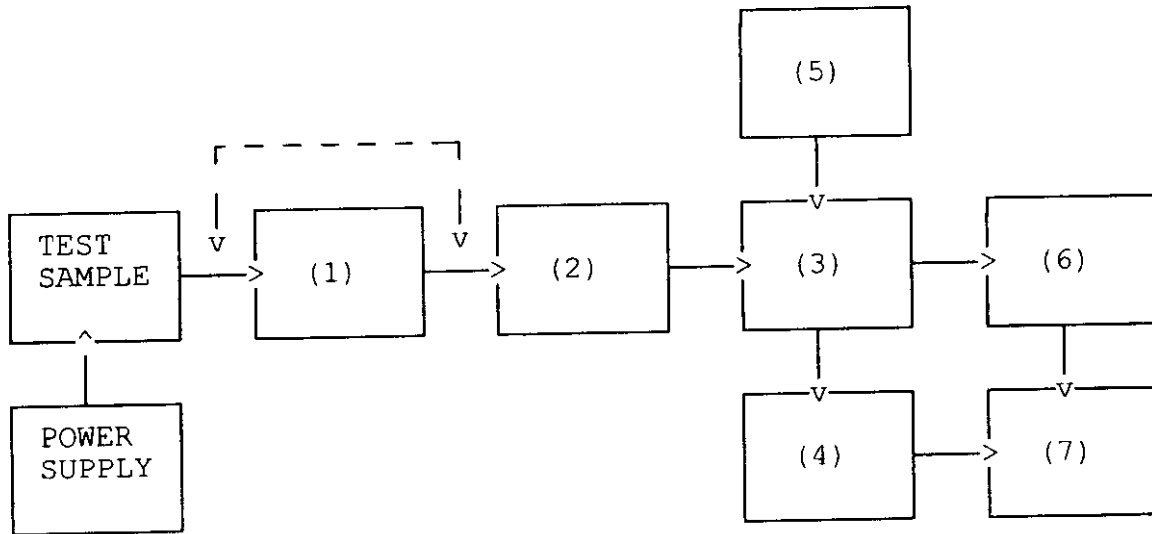

Asset	Description	s/n
(1)	ATTENUATOR (Removed after 1st step)	
<u>x</u>	i00112 Philco 30 dB	989
(2)	ATTENUATOR	
	i00112 Philco 30 dB	989
	i00172 Bird 30 dB	989
<u>x</u>	i00122 Narda 10 dB	7802
	i00123 Narda 10 dB	7802A
	i00110 Kay Variable	145-387
(3)	COMBINER	
<u>x</u>	i00154 4 x 25 Ω COMBINER	154
(4)	CRYSTAL DETECTOR	
<u>x</u>	i00159 HP 8470B	1822A10054
(5)	RF SIGNAL GENERATOR	
	i00018 HP 8656A	2228A03472
	i00031 HP 8656A	2402A06180
<u>x</u>	i00067 HP 8920A	3345U01242
(6)	MODULATION ANALYZER	
<u>x</u>	i00020 HP 8901A	2105A01087
(7)	SCOPE	
<u>x</u>	i00030 HP 54502A	2927A00209

OSCILLOSCOPE PRESENTATION
KENWOOD, TK-2100
1998-SEP-04, 11:17, FRI

MODULATION: Ref Gen=12.5 kHz Deviation
REMARK: CARRIER OFF TIME

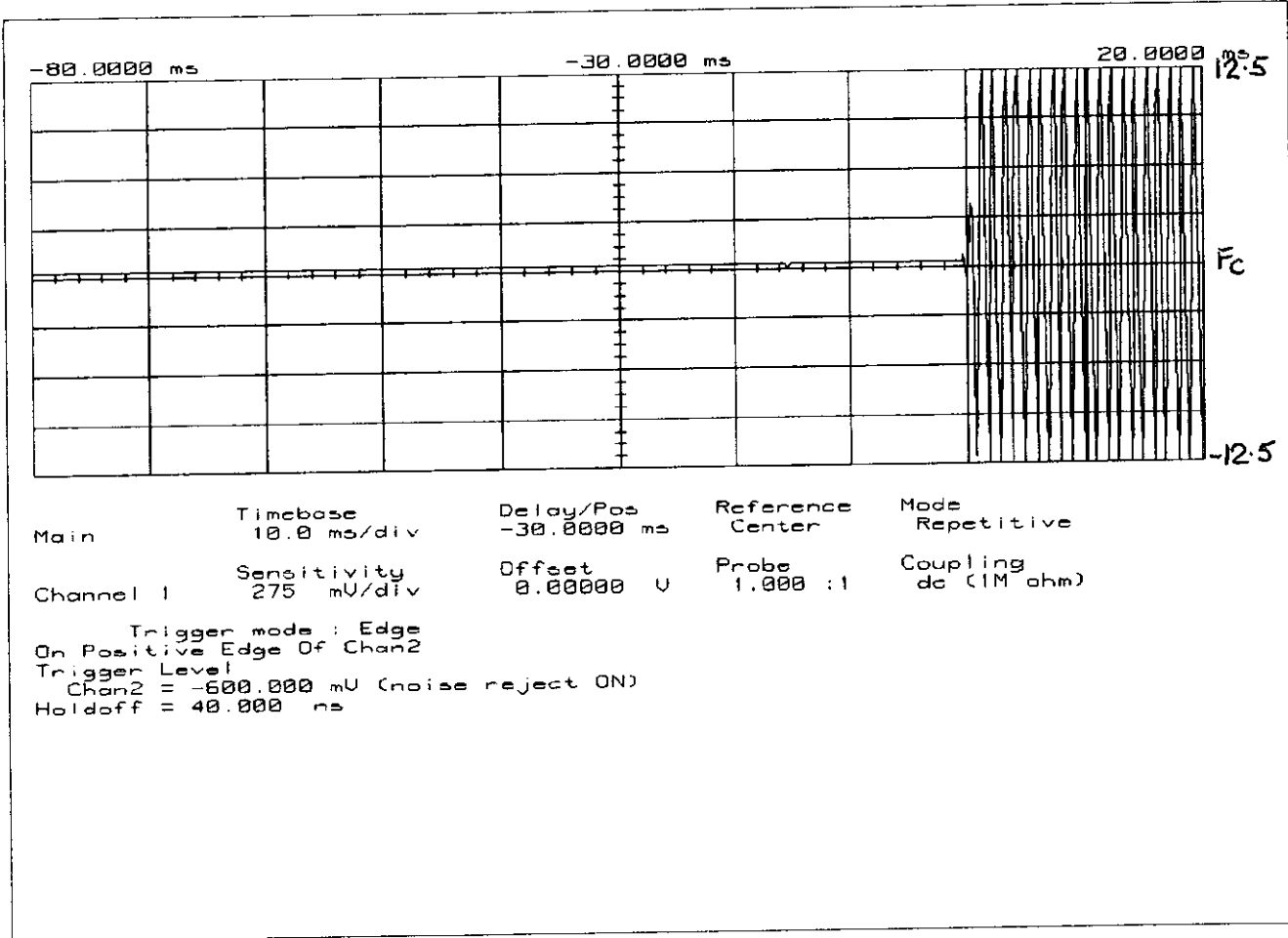

OSCILLOSCOPE PRESENTATION

KENWOOD, TK-2100

1998-SEP-04, 11:11, FRI

MODULATION: Ref Gen=25 kHz Deviation

REMARK: CARRIER ON TIME

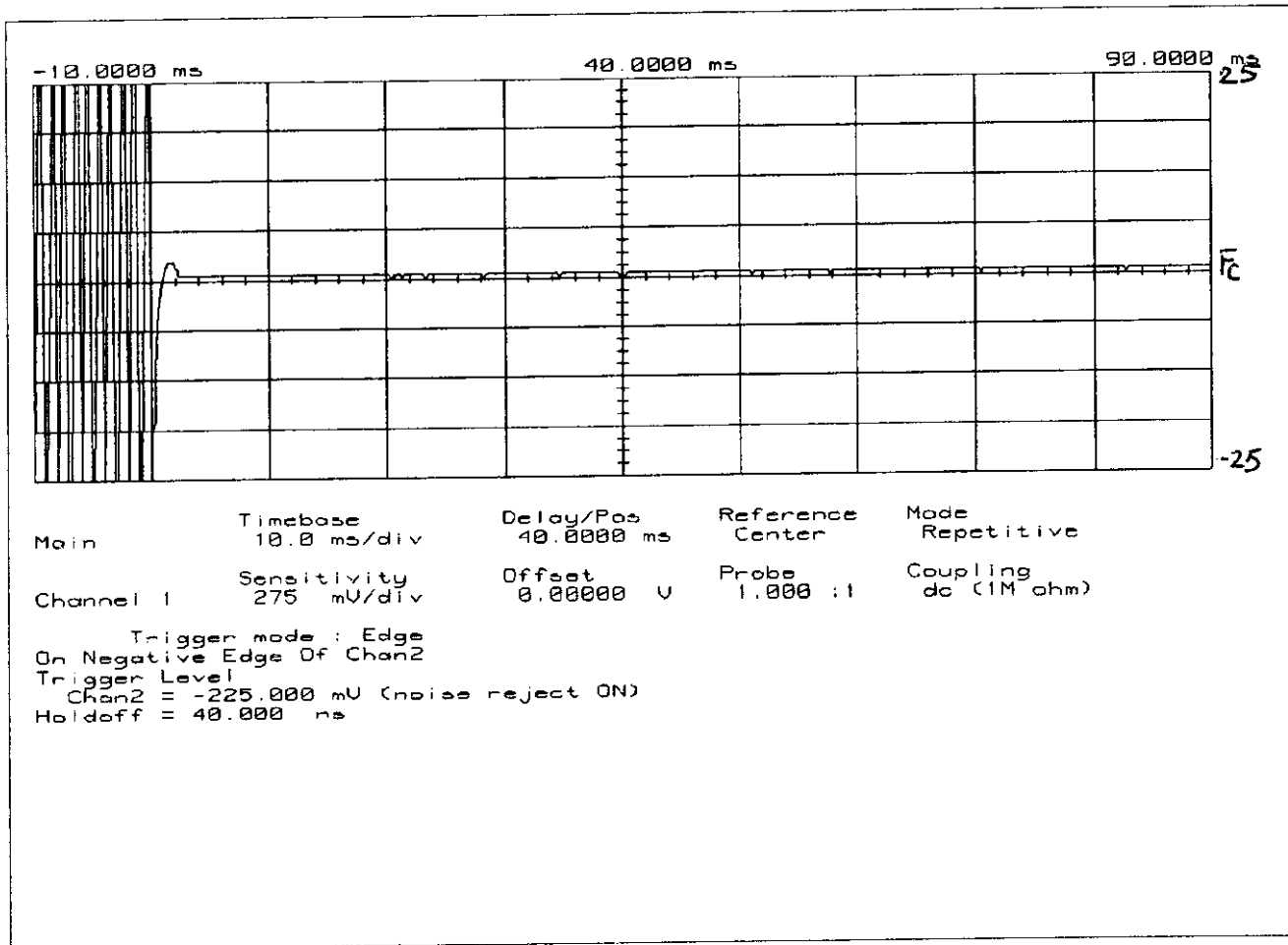

OSCILLOSCOPE PRESENTATION
KENWOOD, TK-2100
1998-SEP-04, 11:12, FRI

MODULATION: Ref Gen=25 kHz Deviation
REMARK: CARRIER OFF TIME

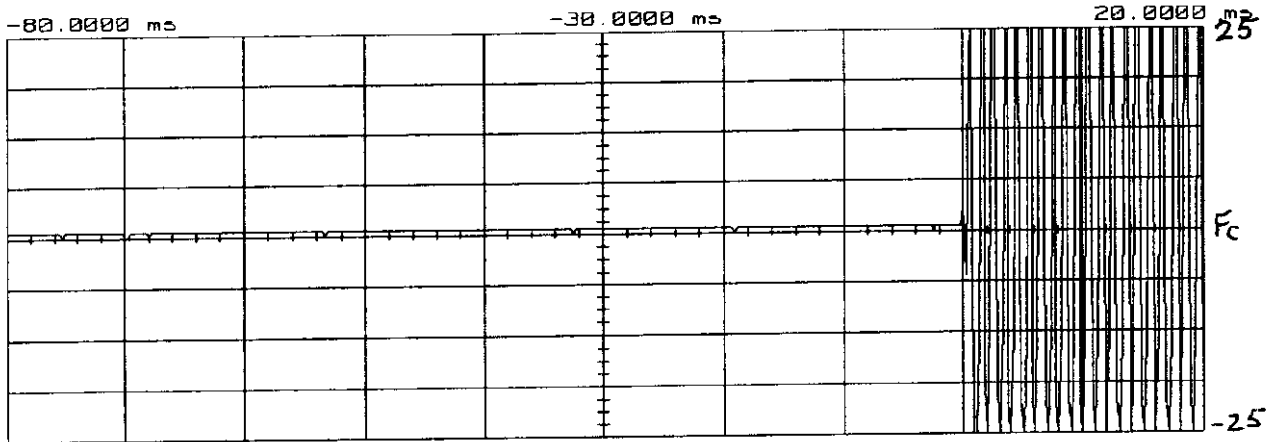

Main	Timebase 10.0 ms/div	Delay/Pos -30.0000 ms	Reference Center	Mode Repetitive
Channel 1	Sensitivity 275 mV/div	Offset 0.00000 U	Probe 1.000 :1	Coupling dc (1M ohm)

Trigger mode : Edge
On Positive Edge Of Chan2
Trigger Level
Chan2 = -600.000 mV (noise reject ON)
Holdoff = 40.000 ns

UNLESS OTHERWISE SPECIFIED, ALL RIGHTS RESERVED

PAGE NO. 25 of 39.
NAME OF TEST: Audio Low Pass Filter (Voice Input)
SPECIFICATION: FCC: 47 CFR 2.987(a)
IC: RSS-119, Section 6.6
GUIDE: TIA/EIA-603, Paragraph 2.2.15
TEST EQUIPMENT: As per attached page

MEASUREMENT PROCEDURE

1. The EUT and test equipment were set up such that the audio input was connected at the input to the modulation limiter, and the modulated stage.
2. The audio output was connected at the output to the modulated stage.
3. MEASUREMENT RESULTS: ATTACHED

TRANSMITTER TEST SET-UP

- TEST A. MODULATION CAPABILITY/DISTORTION
- TEST B. AUDIO FREQUENCY RESPONSE
- TEST C. HUM AND NOISE LEVEL
- TEST D. RESPONSE OF LOW PASS FILTER
- TEST E. MODULATION LIMITING

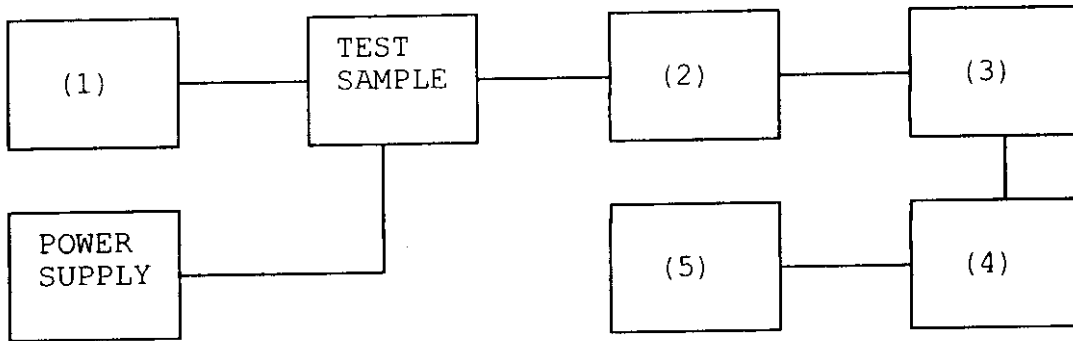

Asset	Description	s/n
(1)	<u>LINE IMPEDANCE STABILIZATION NETWORK</u>	
	i00010 HP 204D	1105A04683
x	i00017 HP 8903A	2216A01753
x	i00118 HP 33120A	US36002064
(2)	<u>COAXIAL ATTENUATOR</u>	
	i00122 NARDA 766-10	7802
	i00123 NARDA 766-10	7802A
x	i00113 SIERRA 661A-3D	1059
	i00069 BIRD 8329 (30 dB)	10066
(3)	<u>MODULATION ANALYZER</u>	
x	i00020 HP 8901A	2105A01087
(4)	<u>AUDIO ANALYZER</u>	
x	i00017 HP 8903A	2216A01753
(5)	<u>SCOPE</u>	
	i00058 HP 1741A	2215A09356
	i00071 Tektronix 935	1935-B011343

FREQUENCY RESPONSE OF AUDIO LOW PASS FILTER

KENWOOD, TK-2100

1 SEP 1998, 09:03

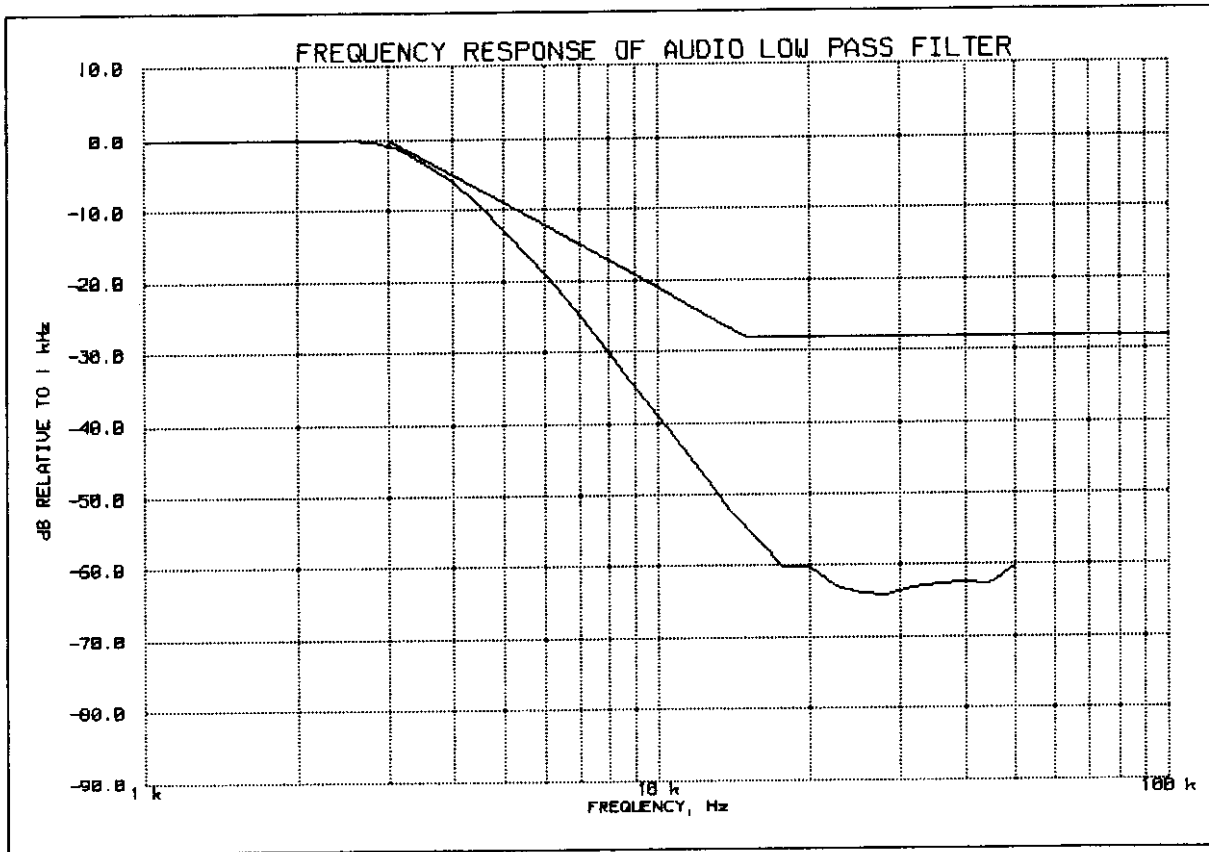

COPYRIGHT © 1988 BY M. FLOM ASSOCIATES, INC. ALL RIGHTS RESERVED.

PEAK AUDIO FREQUENCY, Hz: 2510

SUPERVISED BY:

MORTON FLOM, P. Eng.

PAGE NO. 28 of 39.
NAME OF TEST: Audio Frequency Response
SPECIFICATION: FCC: 47 CFR 2.987(a)
IC: N/A
GUIDE: TIA/EIA-603, Paragraph 2.2.6
TEST EQUIPMENT: As per previous page

MEASUREMENT PROCEDURE

1. The EUT and test equipment were set up as shown on the following page.
2. The audio signal generator was connected to the audio input circuit/microphone of the EUT.
3. The audio signal input was adjusted to obtain 20% modulation at 1 kHz, and this point was taken as the 0 dB reference level.
4. With input levels held constant and below limiting at all frequencies, the audio signal generator was varied from 100 Hz to 50 kHz.
5. The response in dB relative to 1 kHz was then measured, using the HP 8901A Modulation Analyzer.
6. MEASUREMENT RESULTS: ATTACHED

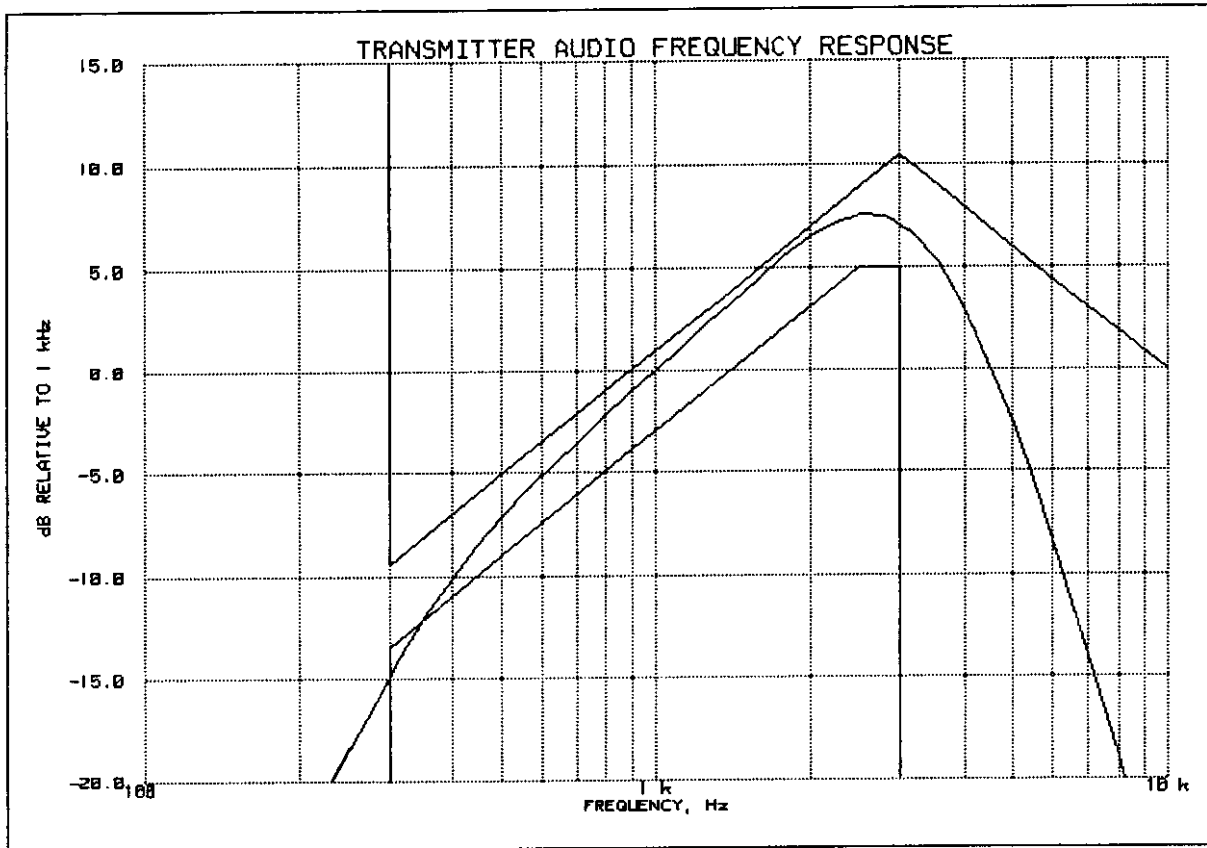

COPYRIGHT (C) 1998 BY W. FLOM ASSOCIATES, INC. ALL RIGHTS RESERVED.

PEAK AUDIO FREQUENCY, Hz: 2510

TABLE VALUES:

FREQUENCY, Hz	LEVEL, dB	FREQUENCY, Hz	LEVEL, dB	FREQUENCY, Hz	LEVEL, dB
300	-14.9	30000	-31.5		
20000	-31.4	50000	-31.4		

M. Flom P. Eng.

SUPERVISED BY:

MORTON FLOM, P. Eng.

PAGE NO. 30 of 39.

NAME OF TEST: Modulation Limiting

SPECIFICATION: FCC: 47 CFR 2.987(b)
IC: RSS-119, Section 6.6

GUIDE: TIA/EIA-603, Paragraph 2.2.3

TEST EQUIPMENT: As per previous page

MEASUREMENT PROCEDURE

1. The signal generator was connected to the input of the EUT as for "Frequency Response of the Modulating Circuit."
2. The modulation response was measured for each of three frequencies (one of which was the frequency of maximum response), and the input voltage was varied and was observed on an HP 8901A Modulation Analyzer.
3. The input level was varied from 30% modulation (± 1.5 kHz deviation) to at least 20 dB higher than the saturation point.
4. Measurements were performed for both negative and positive modulation and the respective results were recorded.
5. MEASUREMENT RESULTS: ATTACHED

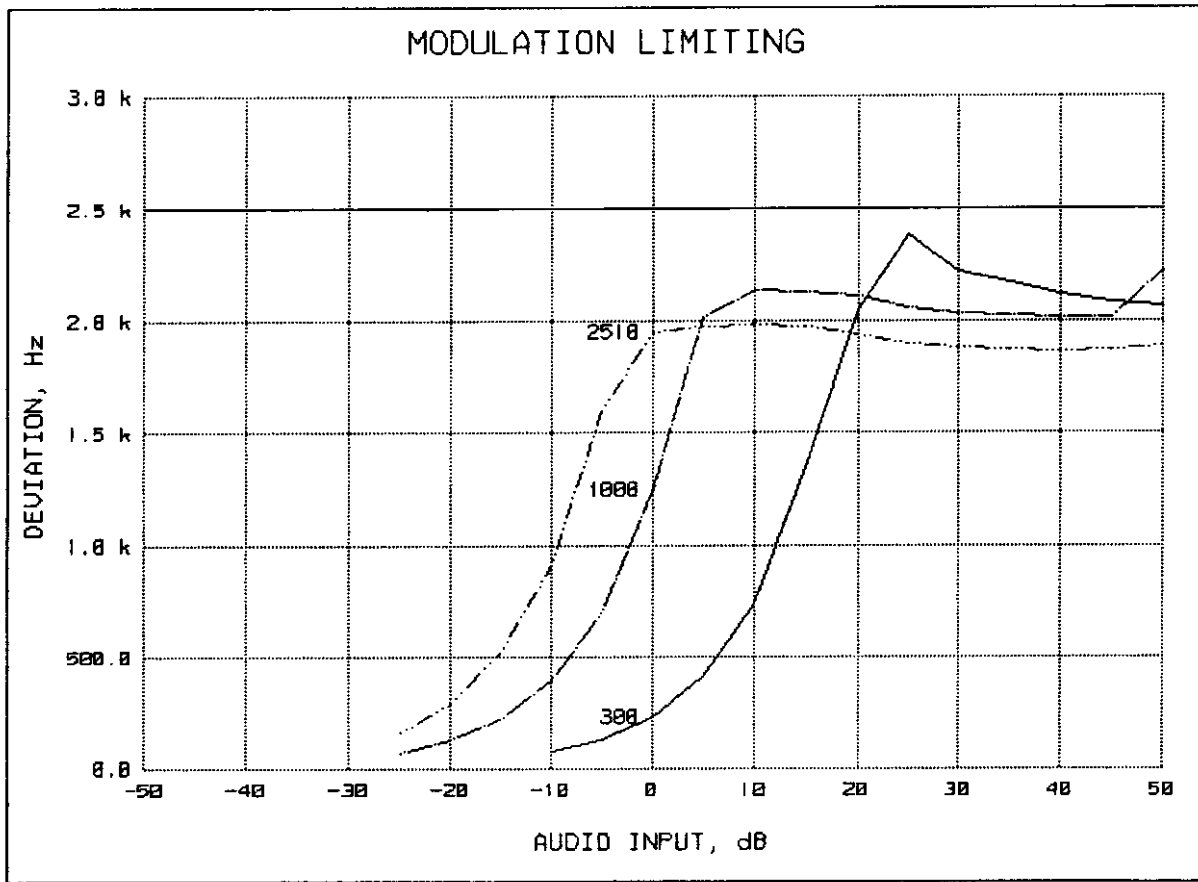

REFERENCE DEVIATION, kHz = 1.25
REFERENCE MODULATION, Hz = 1000
PEAKS = NEGATIVE
AUDIO AMPLITUDE, mV = 15.28

Morton Flom P. Eng.

SUPERVISED BY:

MORTON FLOM, P. Eng.

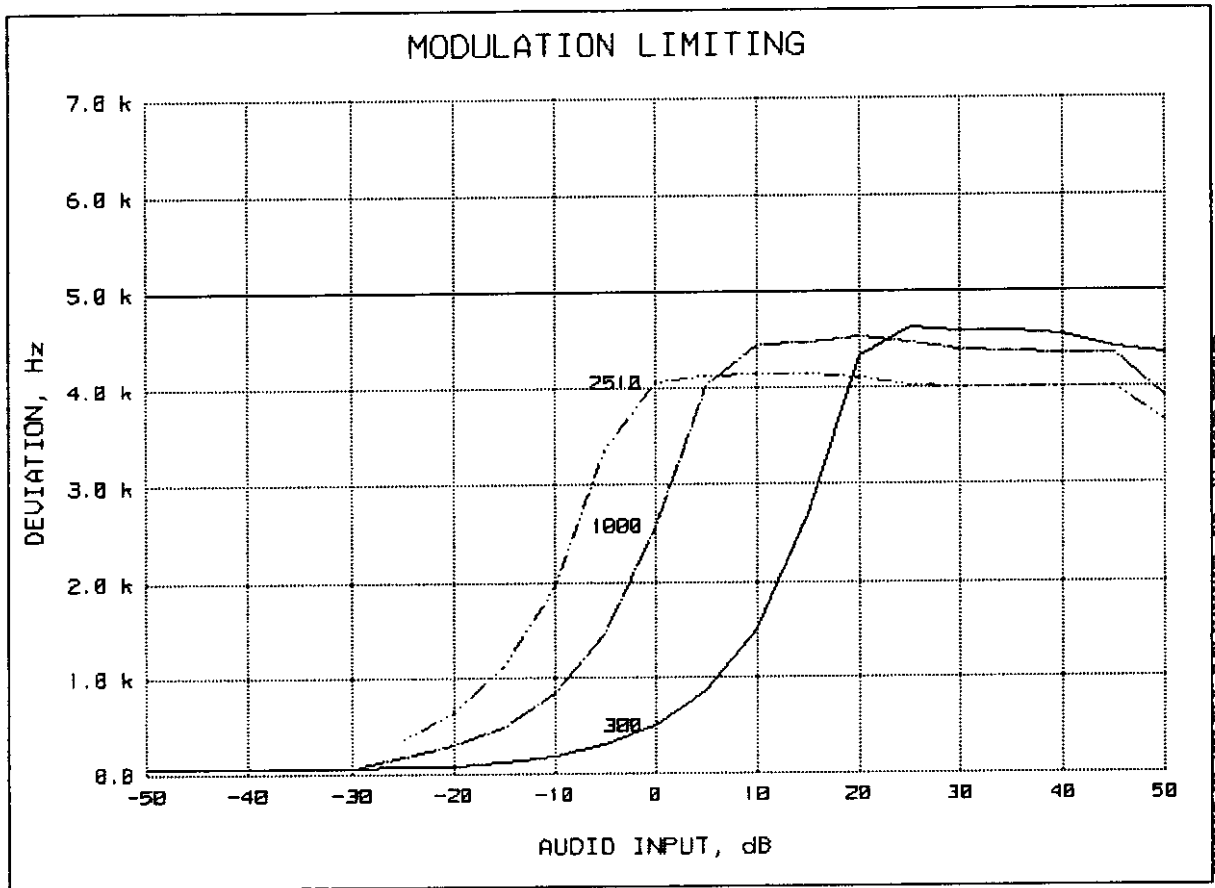

REFERENCE DEVIATION, kHz = 2.5
REFERENCE MODULATION, Hz = 1000
PEAKS = POSITIVE
AUDIO AMPLITUDE, mV = 15.28

M. Flom P. Eng.

SUPERVISED BY:

MORTON FLOM, P. Eng.

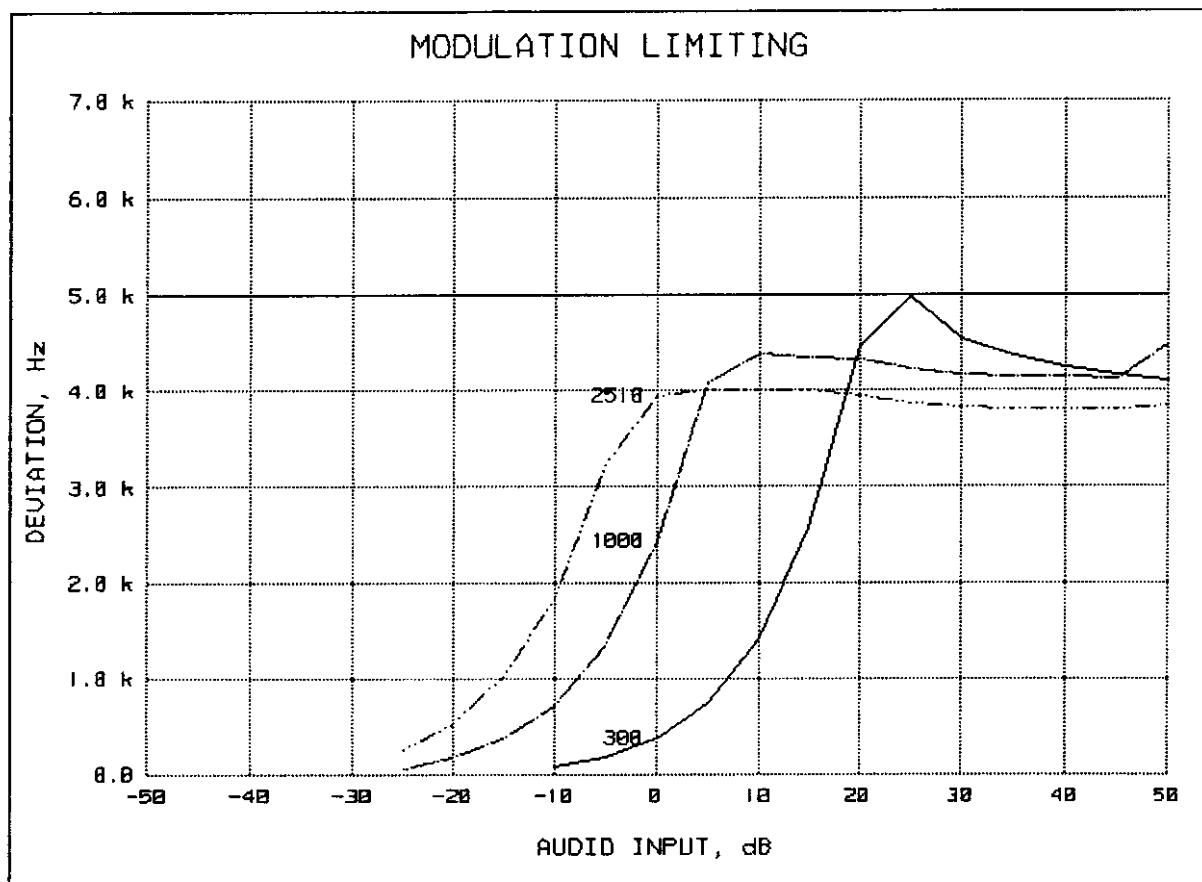

REFERENCE DEVIATION, kHz = 2.5
 REFERENCE MODULATION, Hz = 1000
 PEAKS = NEGATIVE
 AUDIO AMPLITUDE, mV = 15.28

Morton Flom P. Eng.

SUPERVISED BY:

MORTON FLOM, P. Eng.

PAGE NO. 35 of 39.

NAME OF TEST: Frequency Stability (Temperature Variation)

SPECIFICATION: FCC: 47 CFR 2.995(a)(1)
IC: RSS-119, Section 7.0

GUIDE: TIA/EIA-603, Paragraph 2.2.2

TEST CONDITIONS: As Indicated

TEST EQUIPMENT: As per previous page

MEASUREMENT PROCEDURE

1. The EUT and test equipment were set up as shown on the following page.
2. With all power removed, the temperature was decreased to -30°C and permitted to stabilize for three hours. Power was applied and the maximum change in frequency was noted within one minute.
3. With power OFF, the temperature was raised in 10°C steps. The sample was permitted to stabilize at each step for at least one-half hour. Power was applied and the maximum frequency change was noted within one minute.
4. The temperature tests were performed for the worst case.
5. MEASUREMENT RESULTS: ATTACHED

TRANSMITTER TEST SET-UP

TEST A. OPERATIONAL STABILITY
 TEST B. CARRIER FREQUENCY STABILITY
 TEST C. OPERATIONAL PERFORMANCE STABILITY
 TEST D. HUMIDITY
 TEST E. VIBRATION
 TEST F. ENVIRONMENTAL TEMPERATURE
 TEST G. FREQUENCY STABILITY: TEMPERATURE VARIATION
 TEST H. FREQUENCY STABILITY: VOLTAGE VARIATION

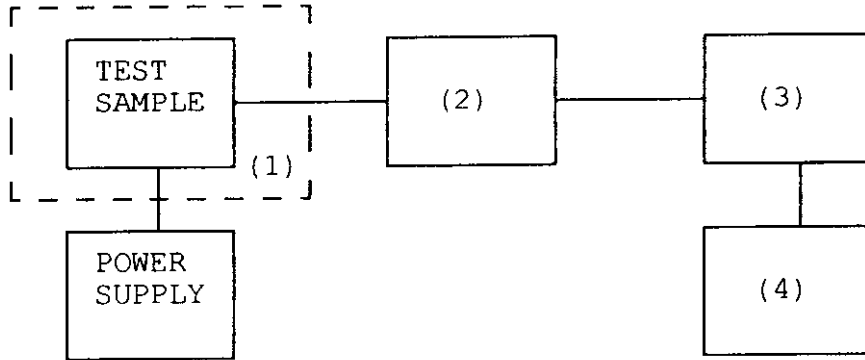

Asset	Description	s/n
<u>(1) TEMPERATURE, HUMIDITY, VIBRATION</u>		
<u>x</u>	i00027 Tenny Temp. Chamber	9083-765-234
---	i00 Weber Humidity Chamber	
---	i00 L.A.B. RVH 18-100	
<u>(2) COAXIAL ATTENUATOR</u>		
---	i00122 NARDA 766-10	7802
---	i00123 NARDA 766-10	7802A
<u>x</u>	i00113 SIERRA 661A-3D	1059
---	i00069 BIRD 8329 (30 dB)	10066
<u>(3) R.F. POWER</u>		
---	i00014 HP 435A POWER METER	1733A05839
<u>x</u>	i00039 HP 436A POWER METER	2709A26776
<u>x</u>	i00020 HP 8901A POWER MODE	2105A01087
<u>(4) FREQUENCY COUNTER</u>		
---	i00042 HP 5383A	1628A00959
<u>x</u>	i00019 HP 5334B	2704A00347
<u>x</u>	i00020 HP 8901A	2105A01087

TRANSMITTER FREQUENCY STABILITY

KENWOOD, TK-2100

8 SEP 1998, 08:09

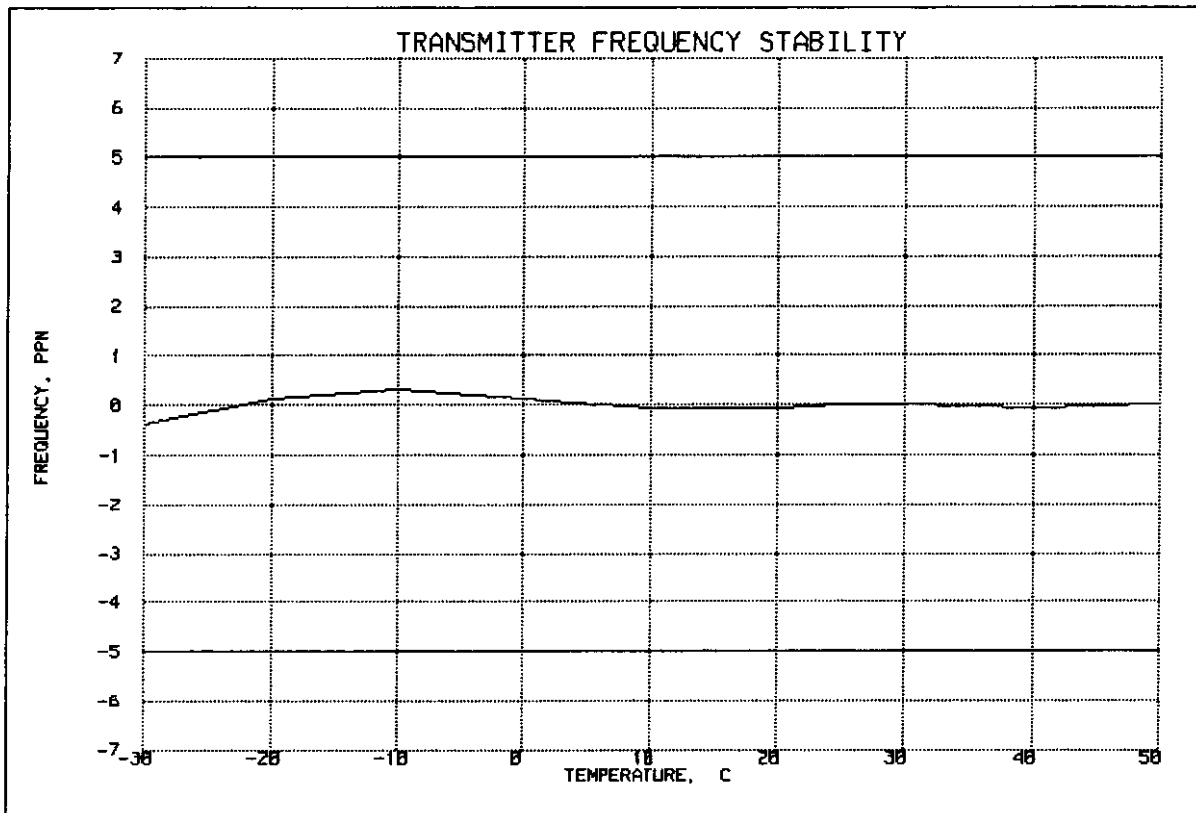

COPYRIGHT (C) 1998 BY N. FLUM ASSOCIATES, INC. ALL RIGHTS RESERVED.

FREQUENCY OF CARRIER, MHz = 151.95501

LIMIT, ppm = 5

LIMIT, Hz = 760

Morton Flom P. Eng.

SUPERVISED BY:

MORTON FLOM, P. Eng.

PAGE NO. 38 of 39.

NAME OF TEST: Frequency Stability (Voltage Variation)

SPECIFICATION: FCC: 47 CFR 2.995 (b) (1)
IC: RSS-119, Section 7.0

GUIDE: TIA/EIA-603, Paragraph 2.2.2

TEST EQUIPMENT: As per previous page

MEASUREMENT PROCEDURE

1. The EUT was placed in a temperature chamber at 25±5°C and connected as for "Frequency Stability - Temperature Variation" test.
2. The power supply voltage to the EUT was varied from 85% to 115% of the nominal value measured at the input to the EUT.
3. The variation in frequency was measured for the worst case.

RESULTS: Frequency Stability (Voltage Variation)
g9890024: 1998-Sep-01 Tue 09:55:39
STATE: 0:General

LIMIT, ppm = 5
LIMIT, Hz = 750
BATTERY END POINT (Voltage) = 6

% of STV	Voltage	Frequency, MHz	Change, Hz	Change, ppm
85	6.37	150.049990	-10	-0.07
100	7.5	150.050000	0	0.00
115	8.62	150.050000	0	0.00
80	6	150.050000	0	0.00

Morton Flom P. Eng.

SUPERVISED BY:

Morton Flom, P. Eng.