

Required information per ISO/IEC Guide 25-1990, paragraph 13.2:

TEST REPORT

a) Laboratory: M. Flom Associates, Inc.  
3356 N. San Marcos Place, Suite 107  
(Canada: IC 2044)  
Chandler, AZ 85224

b) Report Number: d98c0023

c) Client: Kenwood Communications Corporation  
P.O. Box 22745  
Long Beach, CA 90801-5745

d) Identification: Model To Be Advised  
FCC ID: ALH24593110  
UHF FM Mobile Transceiver

e) EUT Condition: Not required unless specified in individual tests.

f) Report Date: December 8, 1998  
EUT Received: November 11, 1998

g, j, k): As indicated in individual tests.

h) Sampling method: No sampling procedure used.

i) Uncertainty: In accordance with MFA internal quality manual.

m) Supervised by:



n) Results: The results presented in this report relate only to the item tested.

o) Reproduction: This report must not be reproduced, except in full, without written permission from this laboratory.

LIST OF GENERAL INFORMATION REQUIRED FOR CERTIFICATION

IN ACCORDANCE WITH FCC RULES AND REGULATIONS,  
VOLUME II, PART 2 AND TO

22, 74, 90, 95

Sub-part 2.1033

(c) (1) : NAME AND ADDRESS OF APPLICANT:

Kenwood Communications Corporation  
2201 E. Dominguez St  
P.O. Box 22745  
Long Beach, CA 90801-5745

MANUFACTURER:

Kenwood Electronics Technologies PTE Ltd.  
1 Ang Mo Kio Street 63  
Singapore 569110

(c) (2) : FCC ID: ALH24593110

MODEL NO: To Be Advised

(c) (3) : INSTRUCTION MANUAL(S) :

PLEASE SEE ATTACHED EXHIBITS

(c) (4) : TYPE OF EMISSION: 16K0F3E, 11K0F3E

(c) (5) : FREQUENCY RANGE, MHZ: 450 to 490

(c) (6) : POWER RATING, watts: 25  
Switchable Variable x N/A

(c) (7) : MAXIMUM POWER RATING, watts: 500

TRANSMITTER POWER CONDUCTED MEASUREMENTS

TEST 1: R. F. POWER OUTPUT  
 TEST 2: FREQUENCY STABILITY

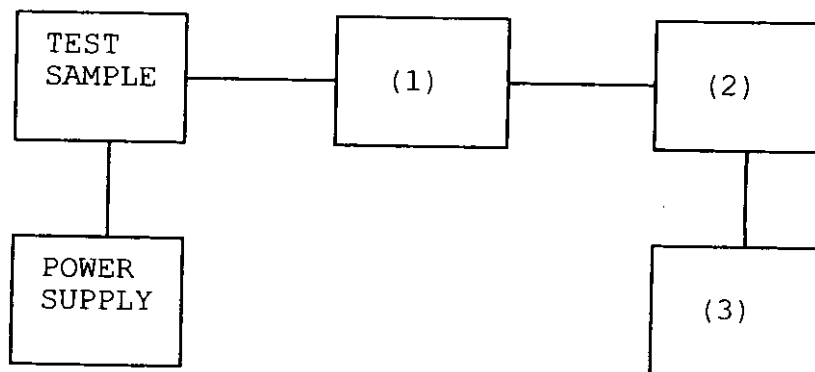

Asset	Description	s/n
<u>(1) COAXIAL ATTENUATOR</u>		
_____	i00122 Narda 766-10	7802
_____	i00123 Narda 766-10	7802A
_____	i00069 Bird 8329 (30 dB)	1006
<u>x</u>	i00113 Sierra 661A-3D	1059
<u>(2) POWER METERS</u>		
_____	i00014 HP 435A	1733A05836
<u>x</u>	i00039 HP 436A	2709A26776
<u>x</u>	i00020 HP 8901A POWER MODE	2105A01087
<u>(3) FREQUENCY COUNTER</u>		
_____	i00042 HP 5383A	1628A00959
<u>x</u>	i00019 HP 5334B	2704A00347
<u>x</u>	i00020 HP 8901A FREQUENCY MODE	2105A01087

PAGE NO. 8 of 36.  
NAME OF TEST: Unwanted Emissions (Transmitter Conducted)  
SPECIFICATION: 47 CFR 2.1051  
GUIDE: ANSI/TIA/EIA-603-1992, Paragraph 2.2.13  
TEST EQUIPMENT: As per attached page

MEASUREMENT PROCEDURE

1. The emissions were measured for the worst case as follows:
  - (a): within a band of frequencies defined by the carrier frequency plus and minus one channel.
  - (b): from the lowest frequency generated in the EUT and to at least the 10th harmonic of the carrier frequency, or 40 GHz, whichever is lower.
2. The magnitude of spurious emissions that are attenuated more than 20 dB below the permissible value need not be specified.

3. MEASUREMENT RESULTS: ATTACHED FOR WORST CASE

FREQUENCY OF CARRIER, MHz	=	470.1, 450.1, 489.9
SPECTRUM SEARCHED, GHz	=	0 to 10 x F <sub>c</sub>
MAXIMUM RESPONSE, Hz	=	3160
ALL OTHER EMISSIONS	=	≥ 20 dB BELOW LIMIT
LIMIT(S), dBc		
	- (43+10xLOG P)	= -57 (25 Watts)

SUPERVISED BY:

*Morton Flom P. Eng.*

Morton Flom, P. Eng.

TRANSMITTER SPURIOUS EMISSION

TEST A. OCCUPIED BANDWIDTH (IN-BAND SPURIOUS)  
 TEST B. OUT-OF-BAND SPURIOUS

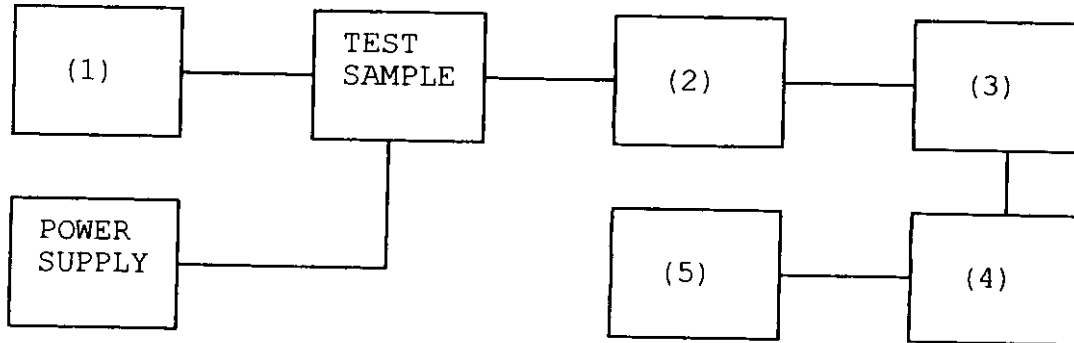

Asset Description

s/n

(1) AUDIO OSCILLATOR/GENERATOR

_____	i00010	HP 204D	1105A04683
_____	i00017	HP 8903A	2216A01753
<u>x</u>	i00012	HP 3312A	1432A11250

(2) COAXIAL ATTENUATOR

_____	i00122	Narda 766-10	7802
_____	i00123	Narda 766-10	7802A
<u>x</u>	i00069	Bird 8329 (30 dB)	1006
<u>x</u>	i00113	Sierra 661A-3D	1059

(3) FILTERS; NOTCH, HP, LP, BP

<u>x</u>	i00126	Eagle TNF-1	100-250
<u>x</u>	i00125	Eagle TNF-1	50-60
<u>x</u>	i00124	Eagle TNF-1	250-850

(4) SPECTRUM ANALYZER

<u>x</u>	i00048	HP 8566B	2511A01467
_____	i00029	HP 8563E	3213A00104

(5) SCOPE

_____	i00058	HP 1741A	2251A09356
_____	i00030	HP 54502A	2927A00209
_____	i00071	Tektronix 935	1935-B011343

PAGE NO. 10 of 36.

NAME OF TEST: Unwanted Emissions (Transmitter Conducted)  
 g98b0417: 1998-Nov-16 Mon 16:28:00  
 STATE: 2:High Power

FREQUENCY TUNED, MHz	FREQUENCY EMISSION, MHz	LEVEL, dBm	LEVEL, dBc	MARGIN, dB
470.100000	940.180000	-23.2	-67.1	-10.2
470.100000	1410.633000	-22.7	-66.6	-9.7
470.100000	1879.919000	-22.3	-66.2	-9.3
470.100000	2350.195000	-21.6	-65.5	-8.6
470.100000	2820.741000	-24.3	-68.2	-11.3
470.100000	3291.198000	-23.5	-67.4	-10.5
470.100000	3760.482000	-24.9	-68.8	-11.9
470.100000	4230.743000	-25.3	-69.2	-12.3
470.100000	4700.603000	-24.5	-68.4	-11.5
470.100000	5170.829000	-23.8	-67.7	-10.8
470.100000	5640.861000	-24.6	-68.5	-11.6
470.100000	6111.364000	-18.7	-62.6	-5.7
470.100000	6581.874000	-18.4	-62.3	-5.4
470.100000	7051.292000	-18.1	-62	-5.1

PAGE NO. 11 of 36.  
NAME OF TEST: Field Strength of Spurious Radiation  
SPECIFICATION: 47 CFR 2.1053(a)  
GUIDE: ANSI/TIA/EIA-603-1992, Paragraph 2.2.12  
TEST EQUIPMENT: As per attached page

MEASUREMENT PROCEDURE

1. A description of the measurement facilities was filed with the FCC and was found to be in compliance with the requirements of Section 15.38, by letter from the FCC dated March 3, 1997, FILE 31040/SIT. All pertinent changes will be reported to the Commission by up-date prior to March 2000.
2. At first, in order to locate all spurious frequencies and approximate amplitudes, and to determine proper equipment functioning, the test sample was set up at a distance of three meters from the test instrument. Valid spurious signals were determined by switching the power on and off.
3. In the field, the test sample was placed on a wooden turntable above ground at three (or thirty) meters away from the search antenna. Excess power leads were coiled near the power supply.  
  
The cables were oriented in order to obtain the maximum response. At each emission frequency, the turntable was rotated and the search antennas were raised and lowered vertically.
4. The emission was observed with both a vertically polarized and a horizontally polarized search antenna and the worst case was used.
6. The field strength of each emission within 20 dB of the limit was recorded and corrected with the appropriate cable and transducer factors.
7. The worst case for all channels is shown.
8. Measurement results: ATTACHED FOR WORST CASE

RADIATED TEST SETUP

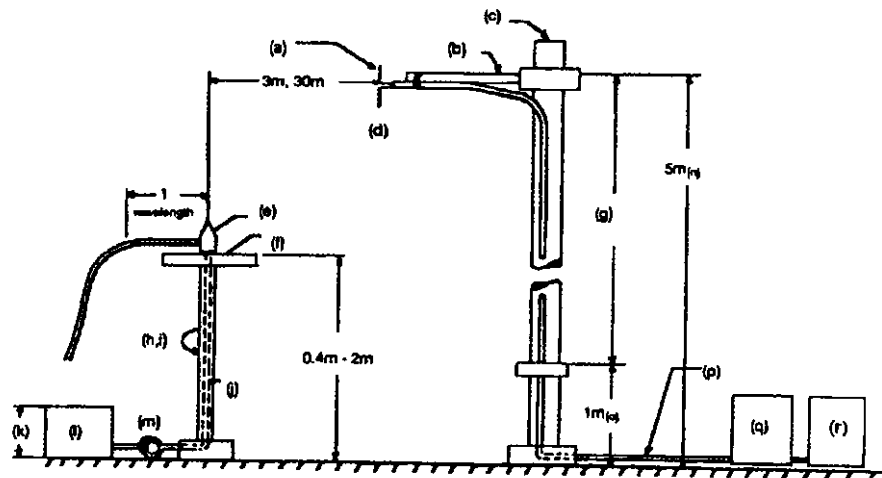

NOTES:

- (a) Search Antenna - Rotatable on boom
- (b) Non-metallic boom
- (c) Non-metallic mast
- (d) Adjustable horizontally
- (e) Equipment Under Test
- (f) Turntable
- (g) Boom adjustable in height.
- (h) External control cables routed horizontally at least one wavelength.
- (i) Rotatable
- (j) Cables routed through hollow turntable center
- (k) 30 cm or less
- (l) External power source
- (m) 10 cm diameter coil of excess cable
- (n) 25 cm (V), 1 m-7 m (V, H)
- (o) 25 cm from bottom end of 'V', 1m normally
- (p) Calibrated Cable at least 10m in length
- (q) Amplifier (optional)
- (r) Spectrum Analyzer

Asset	Description	s/n	Cycle	Last Cal
-------	-------------	-----	-------	----------

Per ANSI C63.4-1992, 10.1.4

TRANSDUCER

___	i00065	EMCO 3109B 100Hz-50MHz	2336	12 mo.	
___	i00033	Singer 94593-1 10kHz-32MHz	0219	12 mo.	
x	i00088	EMCO 3109-B 25MHz-300MHz	2336	12 mo.	Oct-98
x	i00089	Apral 2001 200MHz-1GHz	001500	12 mo.	Oct-98
x	i00103	EMCO 3115 1GHz-18GHz	9208-3925	12 mo.	Oct-98
___	i00085	EMCO 3116 10GHz-40GHz	2076	12 mo.	

AMPLIFIER

___	i00028	HP 8449A	2749A00121	12 mo.	Mar-98
-----	--------	----------	------------	--------	--------

SPECTRUM ANALYZER

___	i00029	HP 8563E	3213A00104	12 mo.	
x	i00033	HP 85462A	3625A00357	12 mo.	Dec-97
___	i00048	HP 8566B	2511AD1467	6 mo.	Mar-98



PAGE NO. 13 of 36.

NAME OF TEST: Field Strength of Spurious Radiation

ALL OTHER EMISSIONS =  $\geq$  20 dB BELOW LIMIT

<u>EMISSION, MHz/HARMONIC</u>	<u>SPURIOUS LEVEL, dBc</u>
2nd to 10th	<-60

SUPERVISED BY:

  
Morton Flom, P. Eng.

PAGE NO. 14 of 36.  
NAME OF TEST: Emission Masks (Occupied Bandwidth)  
SPECIFICATION: 47 CFR 2.1049(c)(1)  
GUIDE: ANSI/TIA/EIA-603-1992, Paragraph 2.2.11  
TEST EQUIPMENT: As per previous page

MEASUREMENT PROCEDURE

1. The EUT and test equipment were set up as shown on the following page, with the Spectrum Analyzer connected.
2. For EUTs supporting audio modulation, the audio signal generator was adjusted to the frequency of maximum response and with output level set for  $\pm 2.5$  kHz deviation (or 50% modulation). With level constant, the signal level was increased 16 dB.
3. For EUTs supporting digital modulation, the digital modulation mode was operated to its maximum extent.
4. The Occupied Bandwidth was measured with the Spectrum Analyzer controls set as shown on the test results.
5. MEASUREMENT RESULTS: ATTACHED

PAGE NO.

15 of 36.

NAME OF TEST: Emission Masks (Occupied Bandwidth)  
g98b0414: 1998-Nov-16 Mon 16:20:00  
STATE: 2:High Power

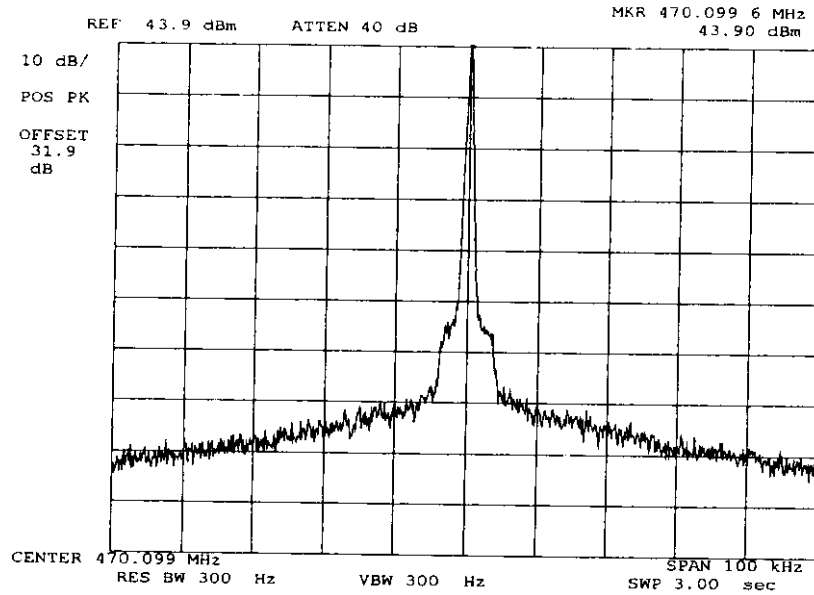

POWER: HIGH  
MODULATION: NONE

SUPERVISED BY:

*Morton Flom P. Eng.*  
Morton Flom, P. Eng.

PAGE NO.

16 of 36.

NAME OF TEST: Emission Masks (Occupied Bandwidth)  
g98b0415: 1998-Nov-16 Mon 16:22:00  
STATE: 2:High Power

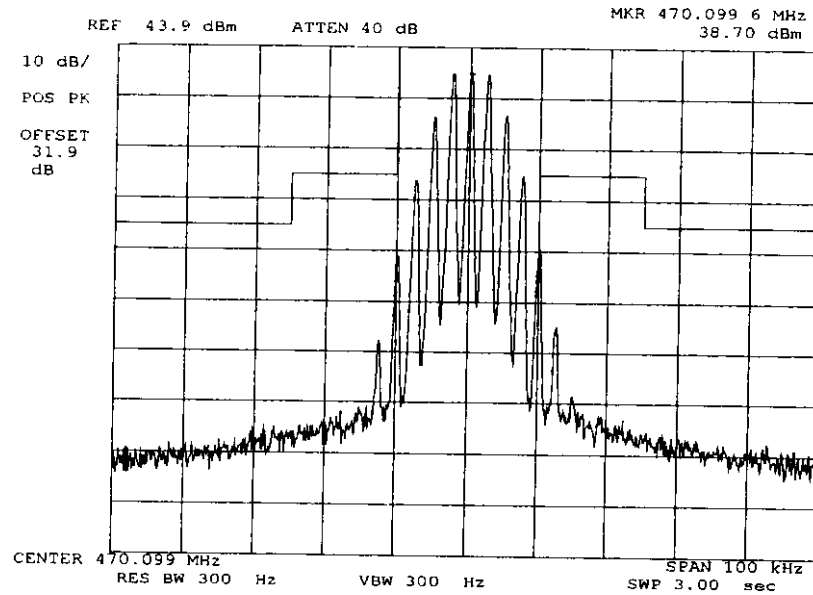

POWER:  
MODULATION:

HIGH  
VOICE: 2500 Hz SINE WAVE  
MASK: B, VHF/UHF 25kHz,  
w/LPF

SUPERVISED BY:

*Morton Flom P. Eng.*  
Morton Flom, P. Eng.

PAGE NO.

17 of 36.

NAME OF TEST: Emission Masks (Occupied Bandwidth)  
g98b0416: 1998-Nov-16 Mon 16:26:00  
STATE: 2:High Power

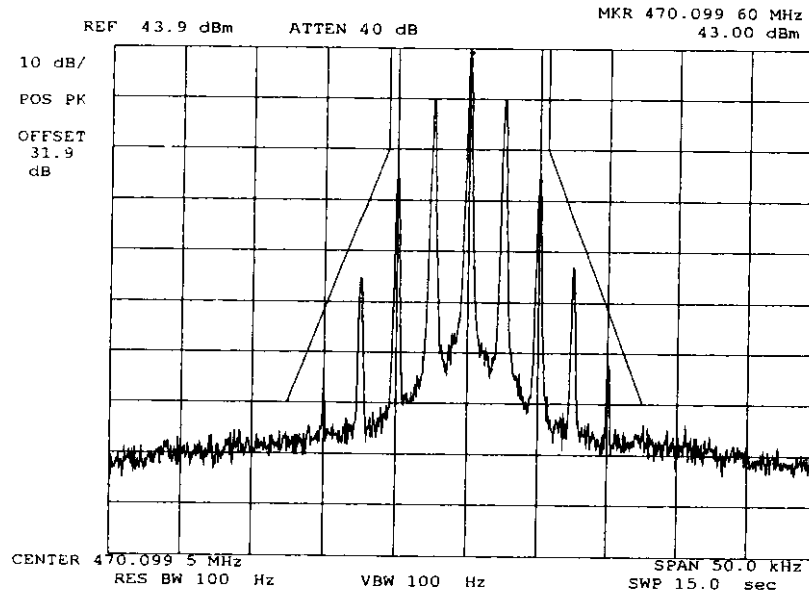

POWER:  
MODULATION:

HIGH  
VOICE: 2500 Hz SINE WAVE  
MASK: D, VHF/UHF 12.5kHz BW

SUPERVISED BY:

Morton Flom, P. Eng.

PAGE NO. 18 of 36.  
NAME OF TEST: Transient Frequency Behavior  
SPECIFICATION: 47 CFR 90.214  
GUIDE: ANSI/TIA/EIA-603-1992, Paragraph 2.2.19  
TEST EQUIPMENT: As per attached page

MEASUREMENT PROCEDURE

1. The EUT was setup as shown on the attached page, following TIA/EIA-603 steps a, b, and c as a guide.
2. The transmitter was turned on.
3. Sufficient attenuation was provided so that the transmitter carrier level measured at the output of the combiner was 40 dB below the maximum input level of the test receiver. This level was recorded as step f.
4. The transmitter was turned off.
5. An RF signal generator (1) modulated with a 1 kHz tone at either 25, 12.5, or 6.25 kHz deviation, and set to the same frequency as the assigned transmitter frequency, (2) was adjusted to a level -20 dB below the level recorded for step f, as measured at the output of the combiner. This level was then fixed for the remainder of the test and is recorded at step h.
6. The oscilloscope was setup using TIA/EIA-603 steps j and k as a guide, and to either 10 ms/div (UHF) or 5 ms/div (VHF).
7. The 30 dB attenuator was removed, the transmitter was turned on, and the level of the carrier at the output of the combiner was recorded as step l.
8. The carrier on-time as referenced in TIA/EIA-603 steps m, n, and o was captured and plotted. The carrier off-time as referenced in TIA/EIA-603 steps p, q, r, and s was captured and plotted.

LEVELS MEASURED:

step f, dBm	=	-7.3
step h, dBm	=	-28.3
step l, dBm	=	22.4



SUPERVISED BY:

Morton Flom, P. Eng.

TRANSIENT FREQUENCY BEHAVIOR

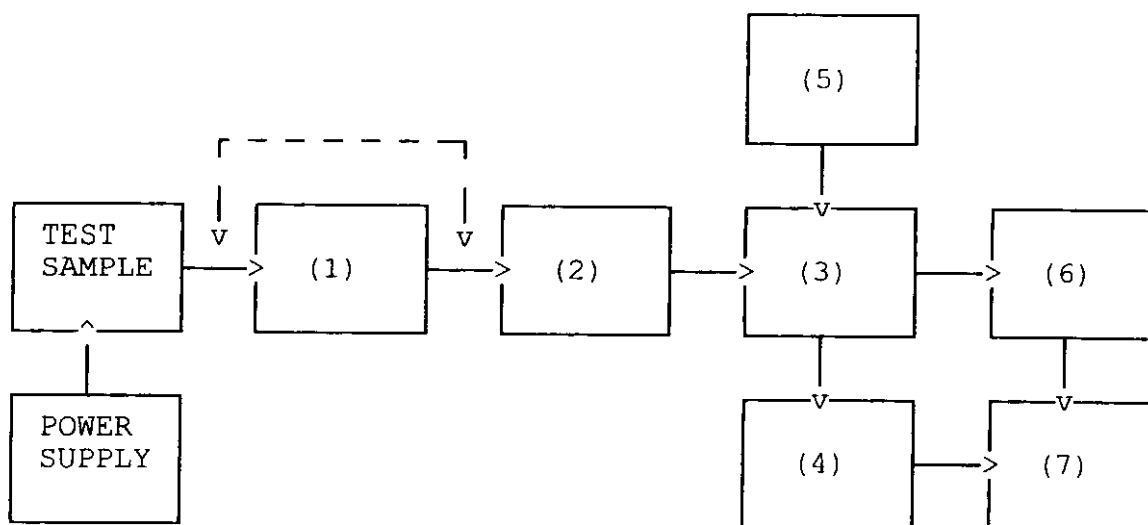

Asset Description s/n

(1) ATTENUATOR (Removed after 1st step)

x i00112 Philco 30 dB 989

(2) ATTENUATOR

i00112 Philco 30 dB 989

i00172 Bird 30 dB 989

x i00122 Narda 10 dB 7802

i00123 Narda 10 dB 7802A

i00110 Kay Variable 145-387

(3) COMBINER

x i00154 4 x 25 Ω COMBINER 154

(4) CRYSTAL DETECTOR

x i00159 HP 8470B 1822A10054

(5) RF SIGNAL GENERATOR

i00018 HP 8656A 2228A03472

i00031 HP 8656A 2402A06180

x i00067 HP 8920A 3345U01242

(6) MODULATION ANALYZER

x i00020 HP 8901A 2105A01087

(7) SCOPE

x i00030 HP 54502A 2927A00209

PAGE NO.

20 of 36.

NAME OF TEST: Transient Frequency Behavior  
 g98b0419: 1998-Nov-17 Tue 11:34:00  
 STATE: 0:General

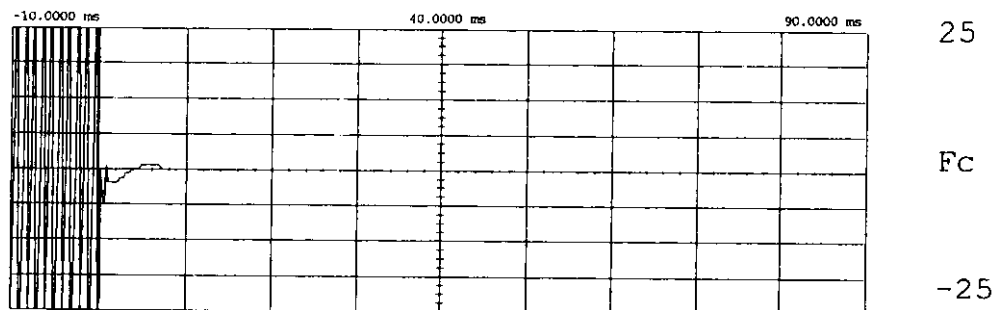

Main	Timebase 10.0 ms/div	Delay/Pos 40.0000 ms	Reference Center	Mode Repetitive
Channel 1	Sensitivity 275 mV/div	Offset 0.00000 V	Probe 1.000 :1	Coupling dc (1M ohm)

Trigger mode : Edge  
 On Negative Edge Of Chan2  
 Trigger Level  
 Chan2 = -225.000 mV (noise reject ON)  
 Holdoff = 40.000 ns

POWER:  
 MODULATION:  
 DESCRIPTION:

n/a  
 Ref Gen=25 kHz Deviation  
 CARRIER ON TIME

SUPERVISED BY:

Morton Flom, P. Eng.



PAGE NO. 21 of 36.

NAME OF TEST: Transient Frequency Behavior  
 g98b0420: 1998-Nov-17 Tue 11:51:00  
 STATE: 0:General

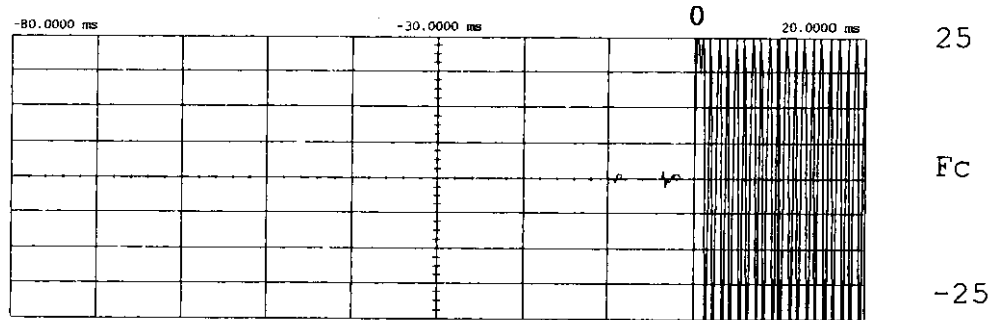

Main	Timebase 10.0 ms/div	Delay/Pos -30.0000 ms	Reference Center	Mode Repetitive
Channel 1	Sensitivity 275 mV/div	Offset 0.00000 V	Probe 1.000 :1	Coupling dc (1M ohm)

Trigger mode : Edge  
 On Positive Edge Of Chan2  
 Trigger Level  
 Chan2 = -600.000 mV (noise reject ON)  
 Holdoff = 40.000 ns

POWER:  
 MODULATION:  
 DESCRIPTION:

n/a  
 Ref Gen=25 kHz Deviation  
 CARRIER OFF TIME

SUPERVISED BY:

*Morton Flom P. Eng.*  
 Morton Flom, P. Eng.

PAGE NO. 22 of 36.

NAME OF TEST: Transient Frequency Behavior  
 g98b0421: 1998-Nov-17 Tue 11:53:00  
 STATE: 0:General

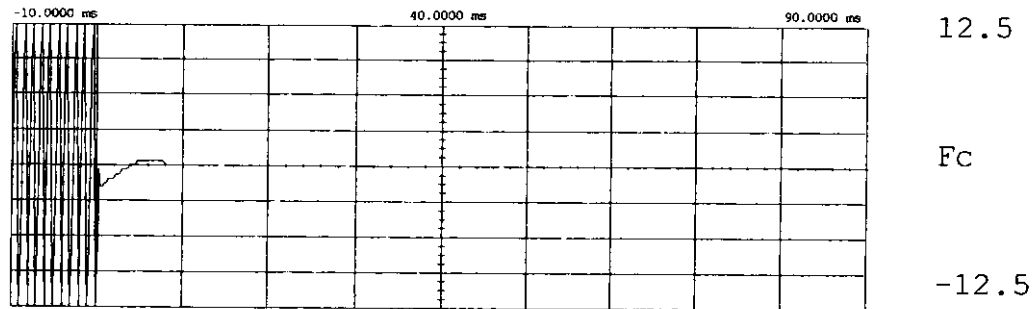

Main	Timebase 10.0 ms/div	Delay/Pos 40.0000 ms	Reference Center	Mode Repetitive
Channel 1	Sensitivity 275 mV/div	Offset 0.00000 V	Probe 1.000 :1	Coupling dc (1M ohm)

Trigger mode : Edge  
 On Negative Edge Of Chan2  
 Trigger Level  
 Chan2 = -225.000 mV (noise reject ON)  
 Holdoff = 40.000 ns

POWER:  
 MODULATION:  
 DESCRIPTION:

n/a  
 Ref Gen=12.5 kHz Deviation  
 CARRIER ON TIME

SUPERVISED BY:

*Morton Flom P. Eng.*  
 Morton Flom, P. Eng.

PAGE NO.

23 of 36.

NAME OF TEST: Transient Frequency Behavior  
g98b0422: 1998-Nov-17 Tue 11:55:00  
STATE: 0:General

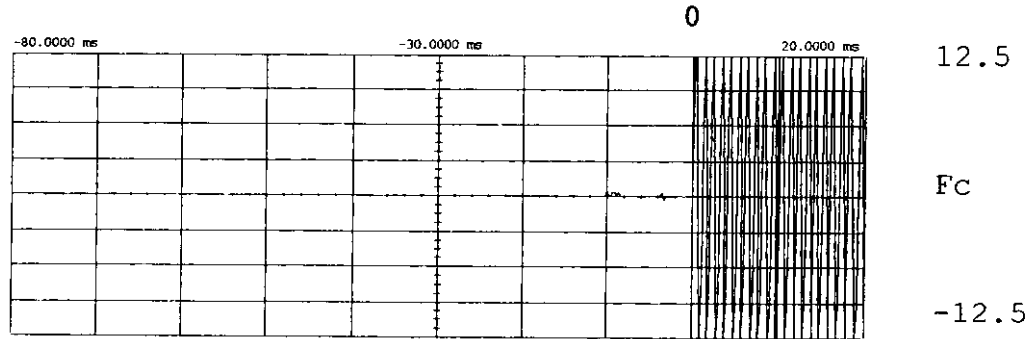

Main	Timebase	Delay/Pos	Reference	Mode
	10.0 ms/div	-30.0000 ms	Center	Repetitive
Channel 1	Sensitivity	Offset	Probe	Coupling
	275 mV/div	0.00000 v	1.000 :1	dc (1M ohm)

Trigger mode : Edge  
On Positive Edge OF Chan2  
Trigger Level  
Chan2 = -600.000 mV (noise reject ON)  
Holdoff = 40.000 ns

POWER:  
MODULATION:  
DESCRIPTION:

n/a  
Ref Gen=12.5 kHz Deviation  
CARRIER OFF TIME

SUPERVISED BY:

*Morton Flom P. Eng.*  
Morton Flom, P. Eng.

PAGE NO. 24 of 36.  
NAME OF TEST: Audio Low Pass Filter (Voice Input)  
SPECIFICATION: 47 CFR 2.1047(a)  
GUIDE: ANSI/TIA/EIA-603-1992, Paragraph 2.2.15  
TEST EQUIPMENT: As per attached page

MEASUREMENT PROCEDURE

1. The EUT and test equipment were set up such that the audio input was connected at the input to the modulation limiter, and the modulated stage.
2. The audio output was connected at the output to the modulated stage.
3. MEASUREMENT RESULTS: ATTACHED

TRANSMITTER TEST SET-UP

- TEST A. MODULATION CAPABILITY/DISTORTION
- TEST B. AUDIO FREQUENCY RESPONSE
- TEST C. HUM AND NOISE LEVEL
- TEST D. RESPONSE OF LOW PASS FILTER
- TEST E. MODULATION LIMITING

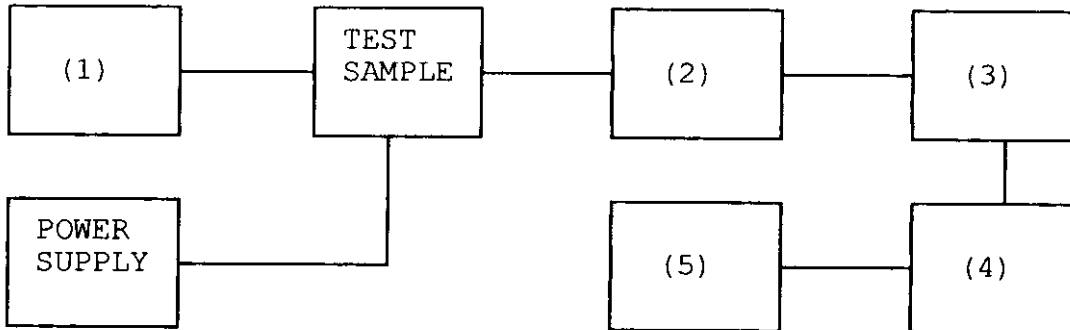

Asset Description

s/n

<u>(1) LINE IMPEDANCE STABILIZATION NETWORK</u>		
___	i00010 HP 204D	1105A04683
<u>x</u>	i00017 HP 8903A	2216A01753
<u>x</u>	i00118 HP 33120A	US36002064
<u>(2) COAXIAL ATTENUATOR</u>		
___	i00122 NARDA 766-10	7802
___	i00123 NARDA 766-10	7802A
<u>x</u>	i00113 SIERRA 661A-3D	1059
___	i00069 BIRD 8329 (30 dB)	10066
<u>(3) MODULATION ANALYZER</u>		
<u>x</u>	i00020 HP 8901A	2105A01087
<u>(4) AUDIO ANALYZER</u>		
<u>x</u>	i00017 HP 8903A	2216A01753
<u>(5) SCOPE</u>		
___	i00058 HP 1741A	2215A09356
___	i00071 Tektronix 935	1935-B011343

PAGE NO.

26 of 36.

NAME OF TEST: Audio Low Pass Filter (Voice Input)  
g98b0164: 1998-Nov-16 Mon 15:43:00  
STATE: 0:General

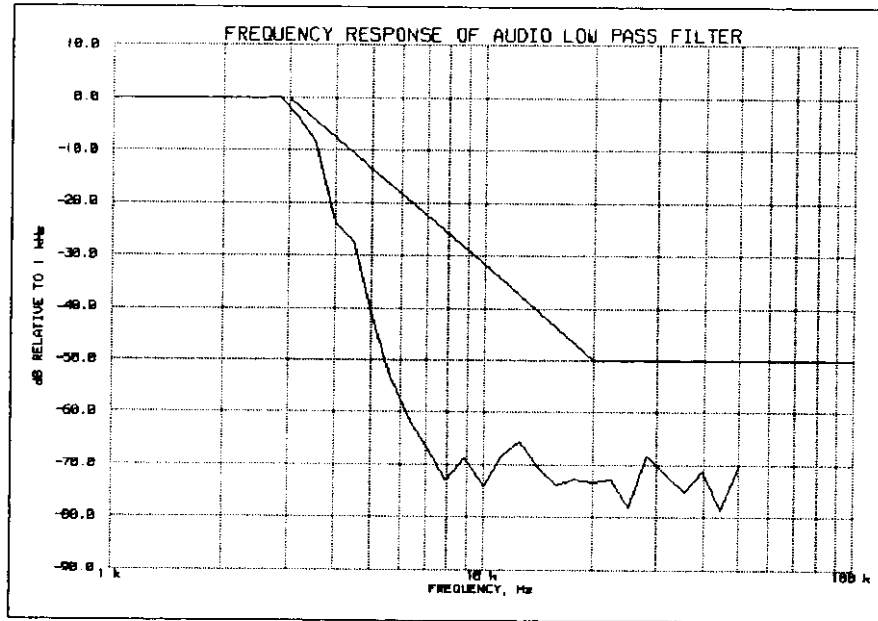

SUPERVISED BY:

*Morton Flom P. Eng.*

Morton Flom, P. Eng.

PAGE NO. 27 of 36.  
NAME OF TEST: Audio Frequency Response  
SPECIFICATION: 47 CFR 2.1047(a)  
GUIDE: ANSI/TIA/EIA-603-1992, Paragraph 2.2.6  
TEST EQUIPMENT: As per previous page

MEASUREMENT PROCEDURE

1. The EUT and test equipment were set up as shown on the following page.
2. The audio signal generator was connected to the audio input circuit/microphone of the EUT.
3. The audio signal input was adjusted to obtain 20% modulation at 1 kHz, and this point was taken as the 0 dB reference level.
4. With input levels held constant and below limiting at all frequencies, the audio signal generator was varied from 100 Hz to 50 kHz.
5. The response in dB relative to 1 kHz was then measured, using the HP 8901A Modulation Analyzer.
6. MEASUREMENT RESULTS: ATTACHED

PAGE NO. 28 of 36.

NAME OF TEST: Audio Frequency Response  
 g98b0166: 1998-Nov-16 Mon 15:46:00  
 STATE: 0:General

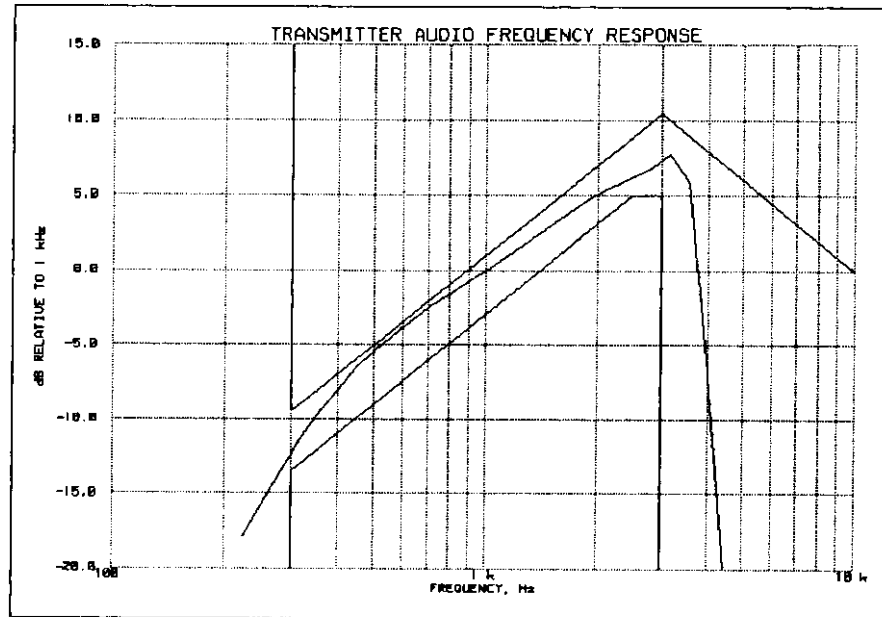

Additional points:

FREQUENCY, Hz	LEVEL, dB
300	-12.40
20000	-27.88
30000	-28.19
50000	-28.28

SUPERVISED BY:

*Morton P. Eng*

Morton Flom, P. Eng.



PAGE NO. 29 of 36.  
NAME OF TEST: Modulation Limiting  
SPECIFICATION: 47 CFR 2.1047(b)  
GUIDE: ANSI/TIA/EIA-603-1992, Paragraph 2.2.3  
TEST EQUIPMENT: As per previous page

MEASUREMENT PROCEDURE

1. The signal generator was connected to the input of the EUT as for "Frequency Response of the Modulating Circuit."
2. The modulation response was measured for each of three frequencies (one of which was the frequency of maximum response), and the input voltage was varied and was observed on an HP 8901A Modulation Analyzer.
3. The input level was varied from 30% modulation ( $\pm 1.5$  kHz deviation) to at least 20 dB higher than the saturation point.
4. Measurements were performed for both negative and positive modulation and the respective results were recorded.
5. MEASUREMENT RESULTS: ATTACHED

PAGE NO.

30 of 36.

NAME OF TEST: Modulation Limiting  
g98b0167: 1998-Nov-16 Mon 15:49:00  
STATE: 0:General

Positive  
Peaks:

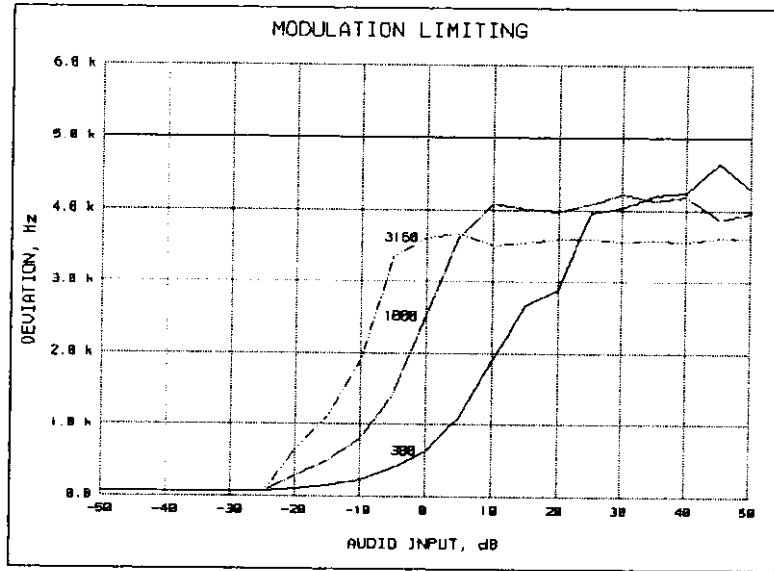

Negative  
Peaks:

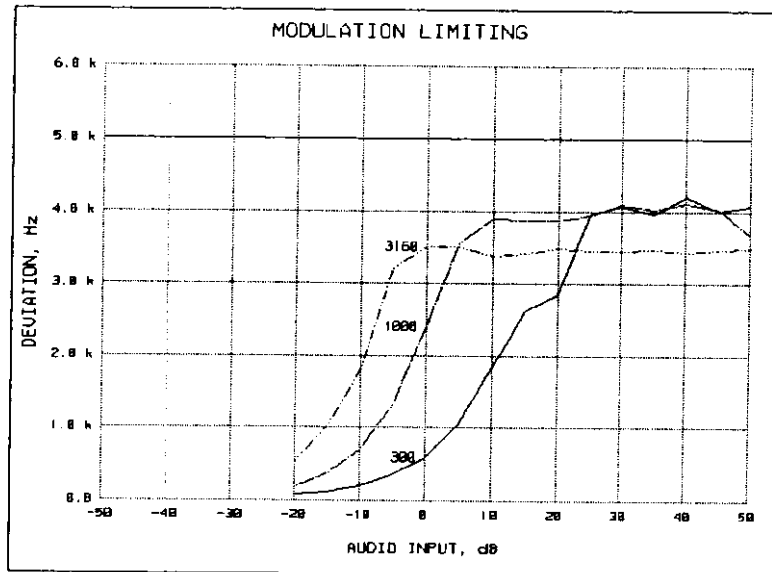

SUPERVISED BY:

Morton Flom, P. Eng.

PAGE NO.

31 of 36.

NAME OF TEST: Modulation Limiting  
g98b0168: 1998-Nov-16 Mon 15:54:00  
STATE: 0:General

Positive  
Peaks:

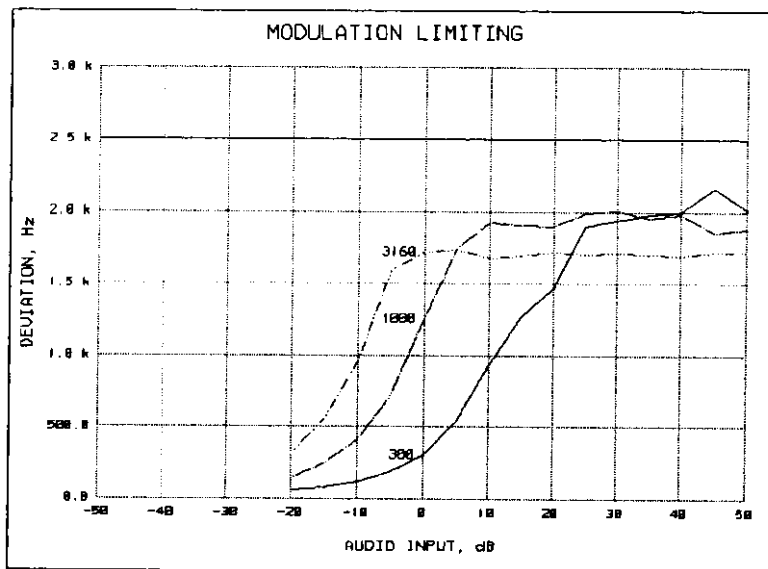

Negative  
Peaks:

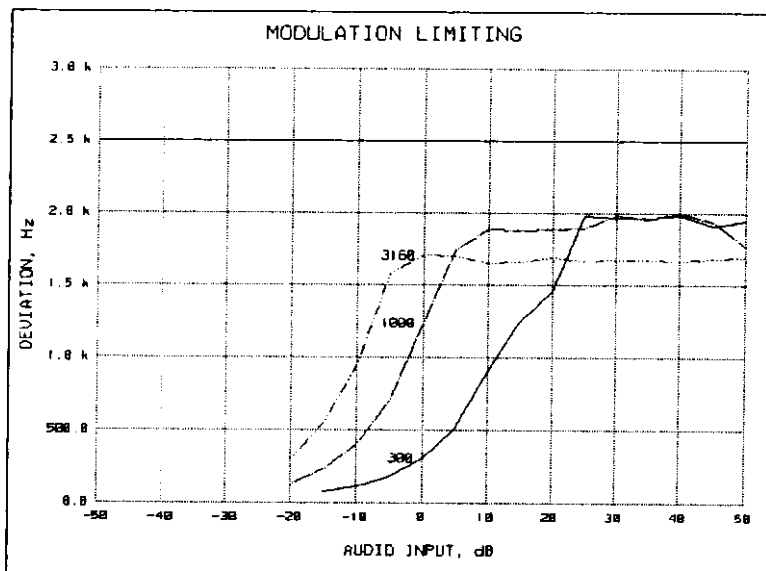

SUPERVISED BY:

Morton Flom, P. Eng.

PAGE NO. 32 of 36.  
NAME OF TEST: Frequency Stability (Temperature Variation)  
SPECIFICATION: 47 CFR 2.1055(a)(1)  
GUIDE: ANSI/TIA/EIA-603-1992, Paragraph 2.2.2  
TEST CONDITIONS: As Indicated  
TEST EQUIPMENT: As per previous page

MEASUREMENT PROCEDURE

1. The EUT and test equipment were set up as shown on the following page.
2. With all power removed, the temperature was decreased to -30°C and permitted to stabilize for three hours. Power was applied and the maximum change in frequency was noted within one minute.
3. With power OFF, the temperature was raised in 10°C steps. The sample was permitted to stabilize at each step for at least one-half hour. Power was applied and the maximum frequency change was noted within one minute.
4. The temperature tests were performed for the worst case.
5. MEASUREMENT RESULTS: ATTACHED

TRANSMITTER TEST SET-UP

- TEST A. OPERATIONAL STABILITY
- TEST B. CARRIER FREQUENCY STABILITY
- TEST C. OPERATIONAL PERFORMANCE STABILITY
- TEST D. HUMIDITY
- TEST E. VIBRATION
- TEST F. ENVIRONMENTAL TEMPERATURE
- TEST G. FREQUENCY STABILITY: TEMPERATURE VARIATION
- TEST H. FREQUENCY STABILITY: VOLTAGE VARIATION

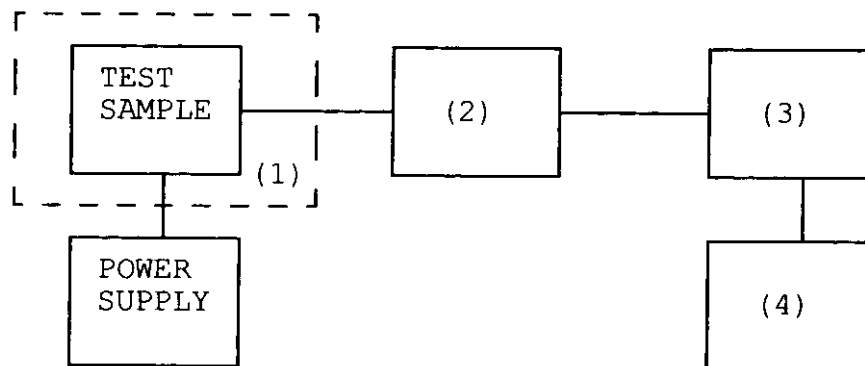

Asset Description s/n

(1) TEMPERATURE, HUMIDITY, VIBRATION

<u>x</u>	i00027	Tenny Temp. Chamber	9083-765-234
---	i00	Weber Humidity Chamber	
---	i00	L.A.B. RVH 18-100	

(2) COAXIAL ATTENUATOR

---	i00122	NARDA 766-10	7802
---	i00123	NARDA 766-10	7802A
<u>x</u>	i00113	SIERRA 661A-3D	1059
---	i00069	BIRD 8329 (30 dB)	10066

(3) R.F. POWER

---	i00014	HP 435A POWER METER	1733A05839
<u>x</u>	i00039	HP 436A POWER METER	2709A26776
<u>x</u>	i00020	HP 8901A POWER MODE	2105A01087

(4) FREQUENCY COUNTER

---	i00042	HP 5383A	1628A00959
<u>x</u>	i00019	HP 5334B	2704A00347
<u>x</u>	i00020	HP 8901A	2105A01087

PAGE NO.

34 of 36.

NAME OF TEST: Frequency Stability (Temperature Variation)  
g98b0169: 1998-Nov-17 Tue 07:21:00  
STATE: 0:General

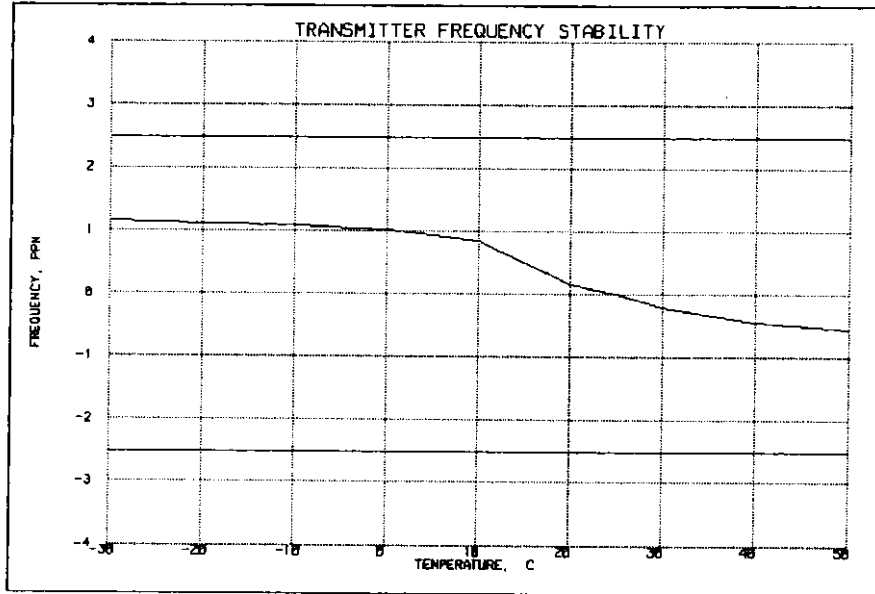

SUPERVISED BY:

Morton Flom, P. Eng.

PAGE NO. 35 of 36.  
NAME OF TEST: Frequency Stability (Voltage Variation)  
SPECIFICATION: 47 CFR 2.1055(b) (1)  
GUIDE: ANSI/TIA/EIA-603-1992, Paragraph 2.2.2  
TEST EQUIPMENT: As per previous page

MEASUREMENT PROCEDURE

1. The EUT was placed in a temperature chamber at 25±5°C and connected as for "Frequency Stability - Temperature Variation" test.
2. The power supply voltage to the EUT was varied from 85% to 115% of the nominal value measured at the input to the EUT.
3. The variation in frequency was measured for the worst case.

RESULTS: Frequency Stability (Voltage Variation)  
g98b0413: 1998-Nov-16 Mon 16:03:28  
STATE: 0:General

LIMIT, ppm = 2.5  
LIMIT, Hz = 1175  
BATTERY END POINT (Voltage) = 9.8

<u>% of STV</u>	<u>Voltage</u>	<u>Frequency, MHz</u>	<u>Change, Hz</u>	<u>Change, ppm</u>
85	11.56	470.100000	0	0.00
100	13.6	470.100000	0	0.00
115	15.64	470.100000	0	0.00
72	9.8	470.100000	0	0.00

*Morton Flom P. Eng.*

SUPERVISED BY:

Morton Flom, P. Eng.

PAGE NO. 36 of 36.  
NAME OF TEST: Necessary Bandwidth and Emission Bandwidth  
SPECIFICATION: 47 CFR 2.202(g)

MODULATION = 16K0F3E

NECESSARY BANDWIDTH CALCULATION:

MAXIMUM MODULATION (M), kHz = 3  
 MAXIMUM DEVIATION (D), kHz = 5  
 CONSTANT FACTOR (K) = 1  
 NECESSARY BANDWIDTH (B<sub>N</sub>), kHz = (2 x M) + (2 x D x K)  
 = 16.0

MODULATION = 11K0F3E

NECESSARY BANDWIDTH CALCULATION:

MAXIMUM MODULATION (M), kHz = 3  
 MAXIMUM DEVIATION (D), kHz = 2.5  
 CONSTANT FACTOR (K) = 1  
 NECESSARY BANDWIDTH (B<sub>N</sub>), kHz = (2 x M) + (2 x D x K)  
 = 11.0

SUPERVISED BY:

*Morton Flom P. Eng.*

Morton Flom, P. Eng.



TESTIMONIAL  
AND  
STATEMENT OF CERTIFICATION

THIS IS TO CERTIFY THAT:

1. THAT the application was prepared either by, or under the direct supervision of, the undersigned.
2. THAT the technical data supplied with the application was taken under my direction and supervision.
3. THAT the data was obtained on representative units, randomly selected.
4. THAT, to the best of my knowledge and belief, the facts set forth in the application and accompanying technical data are true and correct.

CERTIFYING ENGINEER:



Morton Flom, P. Eng.

STATEMENT OF QUALIFICATIONS

EDUCATION:

1. B. ENG. in ENGINEERING PHYSICS, 1949, McGill University, Montreal Canada.
2. Post Graduate Studies, McGill University & Sir Goerge Williams University, Montreal.

PROFESSIONAL AFFILIATIONS:

1. ARIZONA SOCIETY OF PROFESSIONAL ENGINEERS (NSPE), #026 031 821.
2. ORDER OF ENGINEERS (QUEBEC) 1949. #45 34.
3. ASSOCIATION OF PROFESSIONAL ENGINEERS, GEOPHYSICISTS & GEOLOGISTS OF ALBERIA #5916.
4. REGISTERED ENGINEERING CONSULTANT - GOVERNMENT OF CANADA, DEPARTMENT OF COMMUNICATIONS. Radio Equipment approvals.
5. IEEE, Lifetime member no. 041/204 (Member since 1947).

EXPERIENCE:

1. Research/Development/Senior Project Engineer. R.C.A. LIMITED (4 years).
2. Owner/Chief Engineer of Electronics. Design/Manufacturing & Cable TV Companies (10 years)
3. CONSULTING ENGINEER (over 25 years).

*Morton Flom P. Eng.*

MORTON FLOM, P. Eng.

PAGE NO.

5 of 36.

STANDARD TEST CONDITIONS  
and  
ENGINEERING PRACTICES

Except as noted herein, the following conditions and procedures were observed during the testing:

In accordance with ANSI C63.4-1992, section 6.1.9, and unless otherwise indicated in the specific measurement results, the ambient temperature of the actual EUT was maintained within the range of 10° to 40°C (50° to 104 °F) unless the particular equipment requirements specify testing over a different temperature range. Also, unless otherwise indicated, the humidity levels were in the range of 10% to 90% relative humidity.

Prior to testing, the EUT was tuned up in accordance with the manufacturer's alignment procedures. All external gain controls were maintained at the position of maximum and/or optimum gain throughout the testing.

Measurement results, unless otherwise noted, are worst case measurements.

PAGE NO. 6 of 36.  
NAME OF TEST: Carrier Output Power (Conducted)  
SPECIFICATION: 47 CFR 2.1046(a)  
GUIDE: ANSI/TIA/EIA-603-1992, Paragraph 2.2.1  
TEST EQUIPMENT: As per attached page

MEASUREMENT PROCEDURE

1. The EUT was connected to a resistive coaxial attenuator of normal load impedance, and the unmodulated output power was measured by means of an R. F. Power Meter.
2. Measurement accuracy is  $\pm 3\%$ .

MEASUREMENT RESULTS  
(Worst case)

FREQUENCY OF CARRIER, MHz = 470.1, 450.1, 489.9

POWER SETTING	R. F. POWER, WATTS
High	25

SUPERVISED BY:

*Morton Flom P. Eng.*

Morton Flom, P. Eng.

PAGE NO.

4 of 36.

Sub-part  
2.1033(c) (14):TEST AND MEASUREMENT DATA

All tests and measurement data shown were performed in accordance with FCC Rules and Regulations, Volume II; Part 2, Sub-part J, Sections 2.947, 2.1033(c), 2.1041, 2.1046, 2.1047, 2.1079, 2.1051, 2.1053, 2.1055, 2.1057 and the following individual Parts:

- 21 - Domestic Public Fixed Radio Services
- 22 - Public Mobile Services
- 22 Subpart H - Cellular Radiotelephone Service
- 22.901(d) - Alternative technologies and auxiliary services
- 23 - International Fixed Public Radiocommunication services
- 24 - Personal Communications Services
- 74 Subpart H - Low Power Auxiliary Stations
- 80 - Stations in the Maritime Services
- 80 Subpart E - General Technical Standards
- 80 Subpart F - Equipment Authorization for Compulsory Ships
- 80 Subpart K - Private Coast Stations and Marine Utility Stations
- 80 Subpart S - Compulsory Radiotelephone Installations for Small Passenger Boats
- 80 Subpart T - Radiotelephone Installation Required for Vessels on the Great Lakes
- 80 Subpart U - Radiotelephone Installations Required by the Bridge-to-Bridge Act
- 80 Subpart V - Emergency Position Indicating Radiobeacons (EPIRB'S)
- 80 Subpart W - Global Maritime Distress and Safety System (GMDSS)
- 80 Subpart X - Voluntary Radio Installations
- 87 - Aviation Services
- 90 - Private Land Mobile Radio Services
- 94 - Private Operational-Fixed Microwave Service
- 95 Subpart A - General Mobile Radio Service (GMRS)
- 95 Subpart C - Radio Control (R/C) Radio Service
- 95 Subpart D - Citizens Band (CB) Radio Service
- 95 Subpart E - Family Radio Service
- 95 Subpart F - Interactive Video and Data Service (IVDS)
- 101 - Fixed Microwave Services