

FCC ID: ALH22933210  
2.983 (d) (7) SCHEMATICS

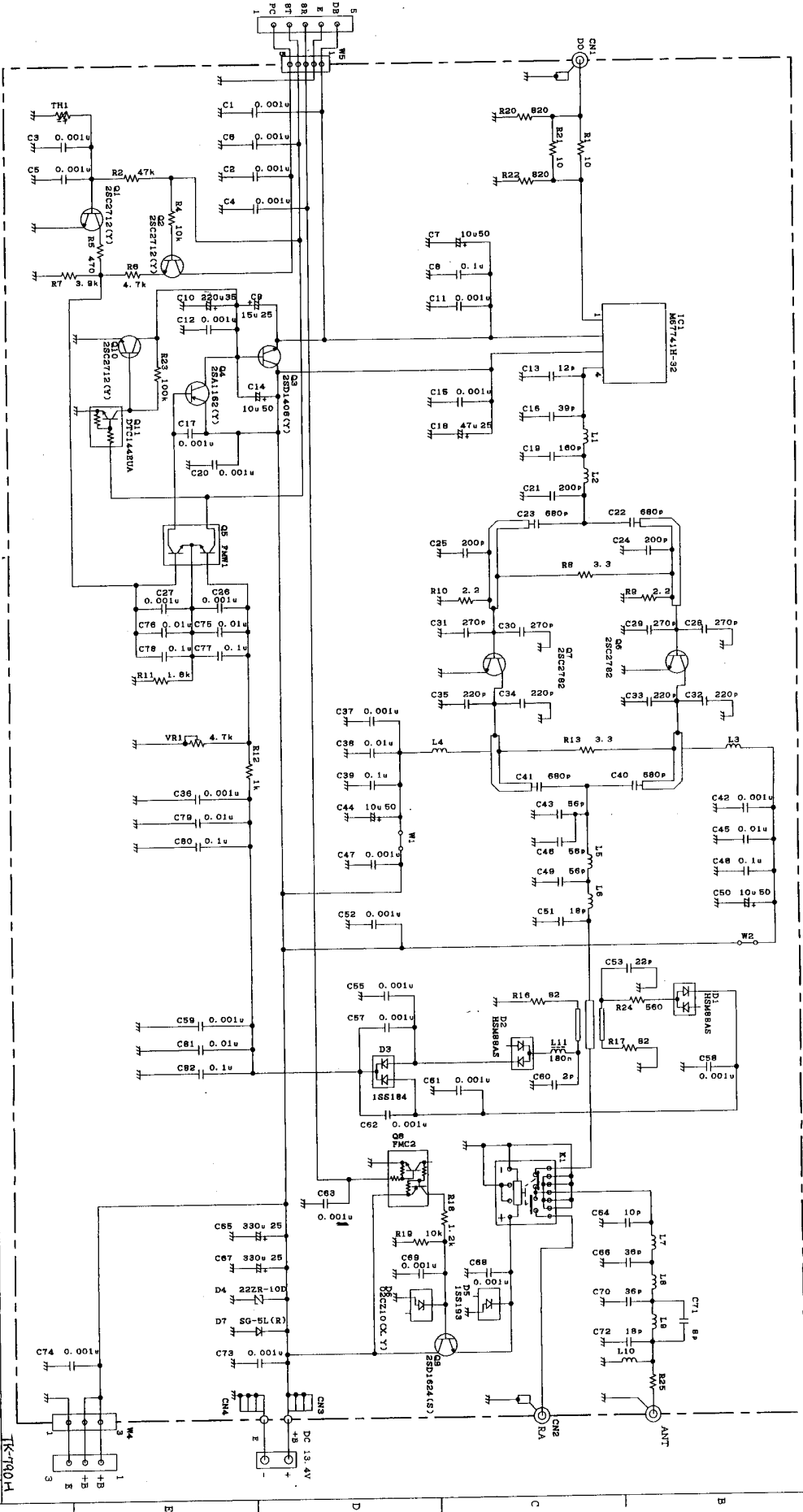

DESIGNED	24/JUN/1998	DRAWN	26/JUN/1998	CHECKED	29/JUN/1998	APPROVED	29/JUN/1998	PARTS NAME	EX-2293
J. KOIZUMI		Y. MATSU		T. NAGATA		K. HIKICHI		SCHEMATIC	HIGH POWER
CORPORATION								PARTS NUMBER	FINAL UNIT
SCHEMATIC DIAGRAM									
Z92-0612-03 1/1 01									

node: scad6 directory: /user/ech/work/c5236  
time: 11:19 03-aug-98 comment: C030403

part: X4535SH00

TK-79014

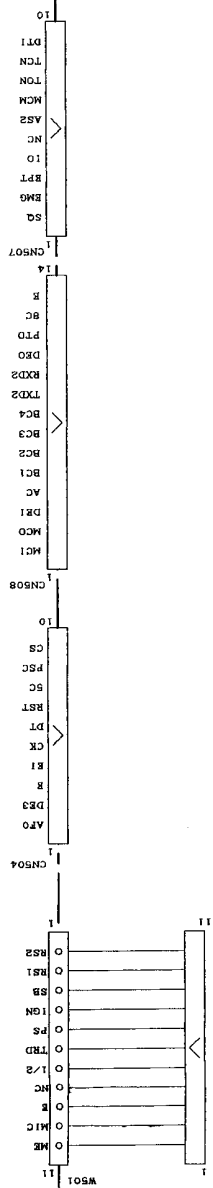

X57-5610-12 B/3  
 (Z92-0667-01)

SSSSS

KENWOOD CORPORATION				
T. SAITO	Y. MATUI	T. SAITOU	K. HIKICHI	Z83-3051-02 1/1 01
DESIGNED	DRAWN	CHECKED	APPROVED	PARTS NAME
05/JUN/1998	24/JUN/1998	24/JUN/1998	29/JUN/1998	TK-790H(B)
INTERCONNECT DIAGRAM				
PARTS NUMBER				

H  
G  
F  
E  
D  
C  
B  
A

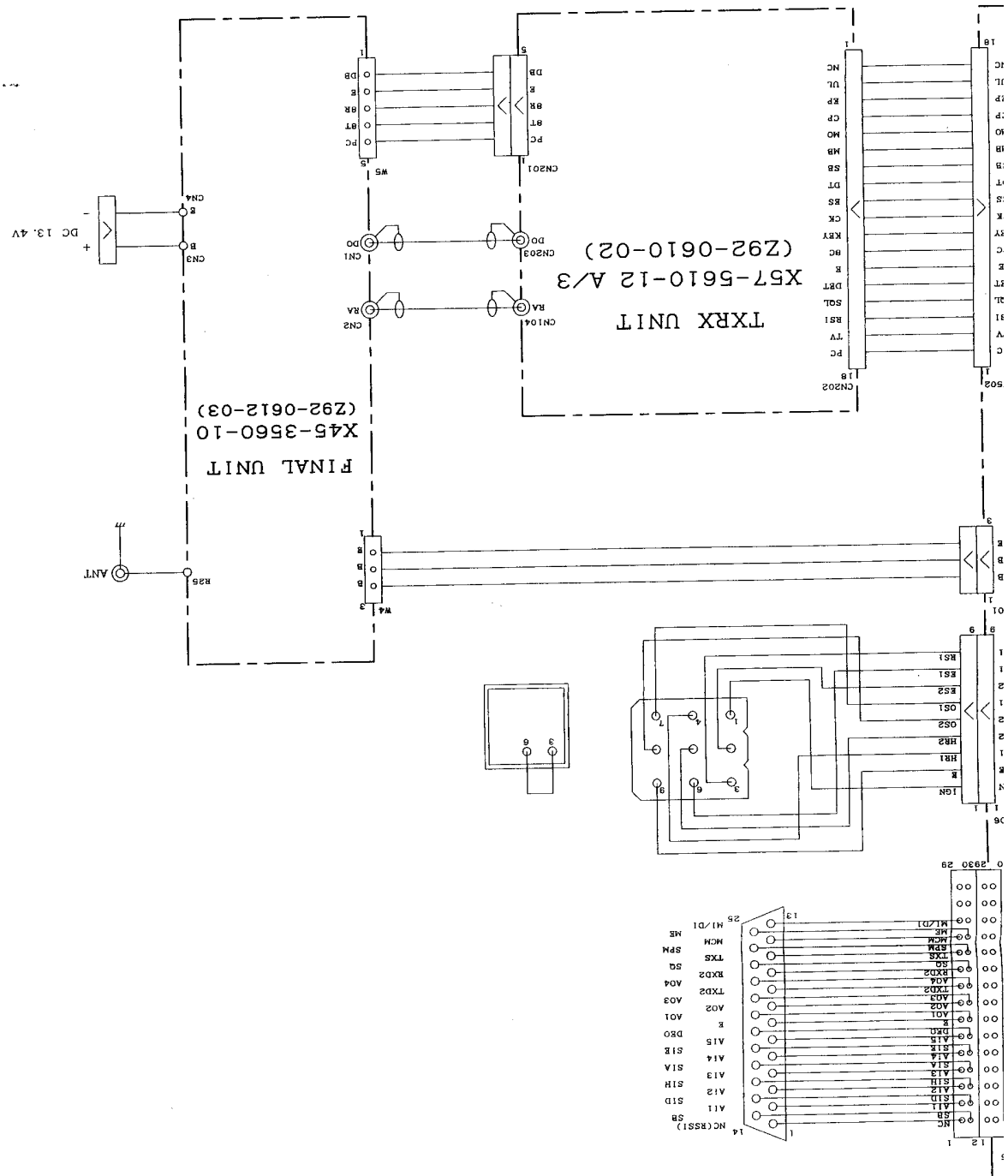

USE FOR	SYMBOL	REVISION NO	CODE	ISSUED	DATE
Y51-4490-10	△ X				19
	△ X				19
	△ X				19
	△ X				19
	△ X				19
	△ X				19
	△ X				19
	△ X				19
	△ X				19
	△ X				19

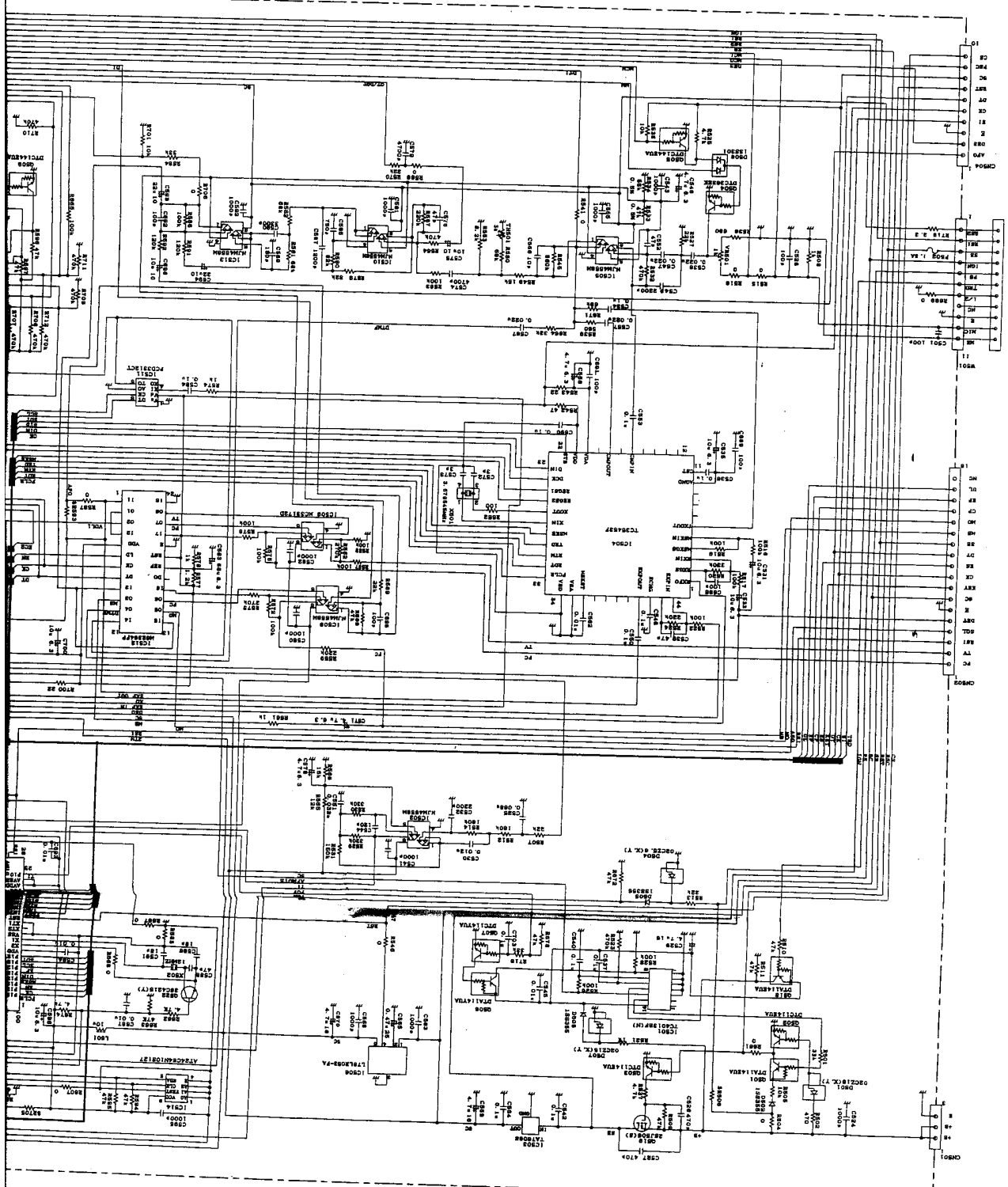



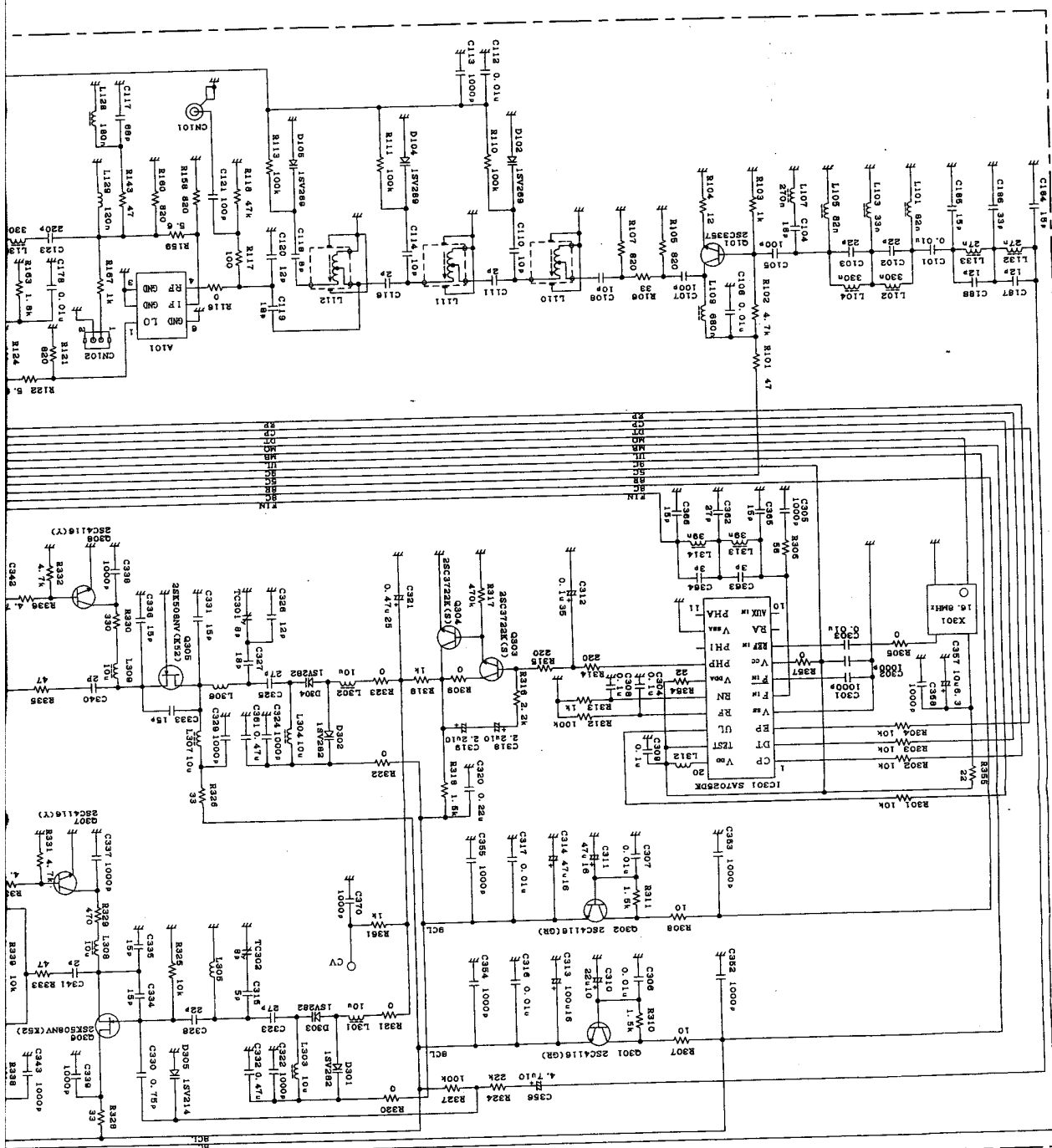









△	X	19	-
△	X	19	-
△	X	19	-

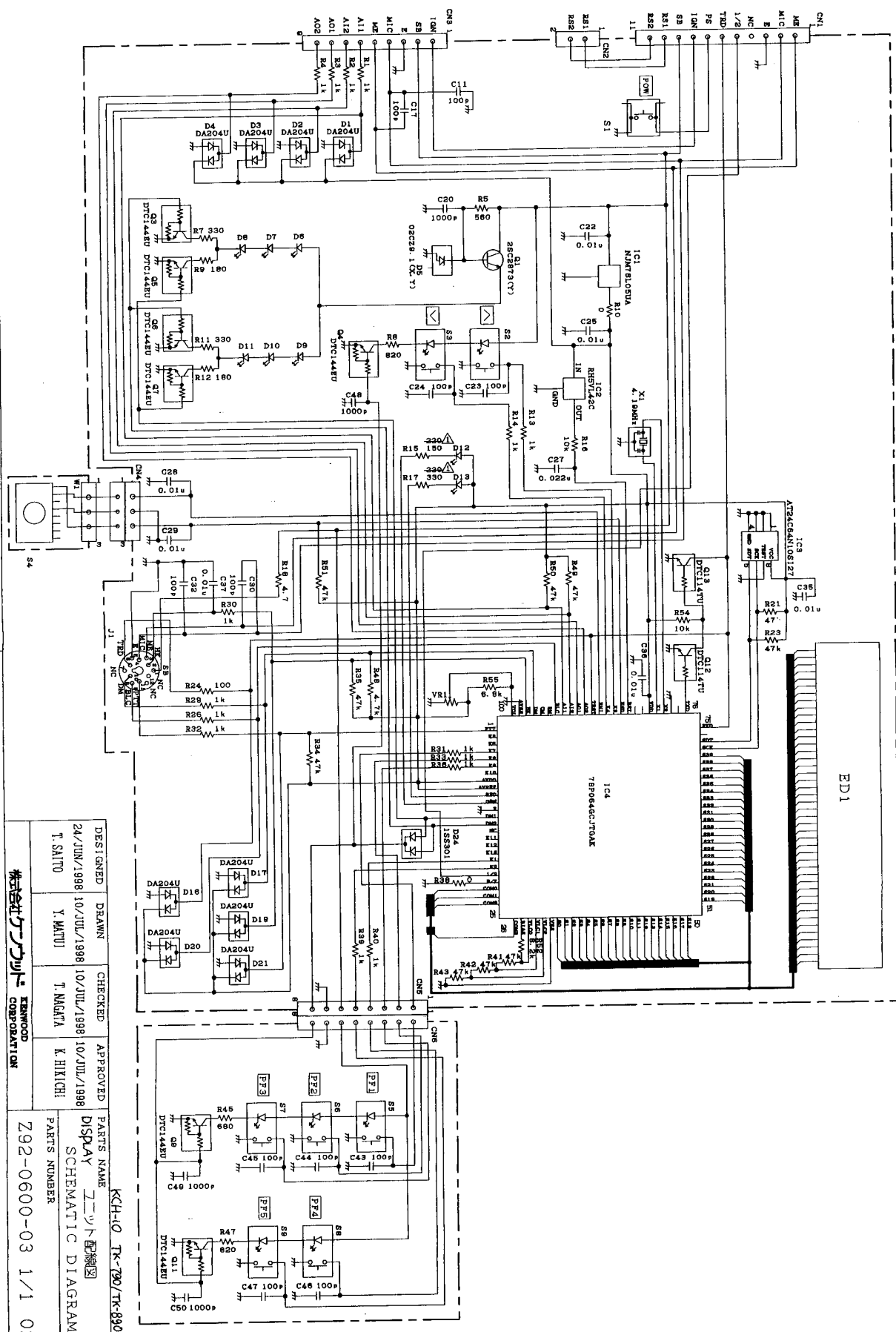

DESIGNED	DRAWN	CHECKED	APPROVED	PARTS NAME
24/JUN/1998	10/JUL/1998	10/JUL/1998	10/JUL/1998	ユニット配線図
T. SATTO	Y. MATSU	T. MAGATA	K. HIKICHI	SCHEMATIC DIAGRAM
KENWOOD CORPORATION				PARTS NUMBER
Z92-0600-03 1/1 02				

node: ceadd directory: /users/sch/work/ce5236 page: X54319H00

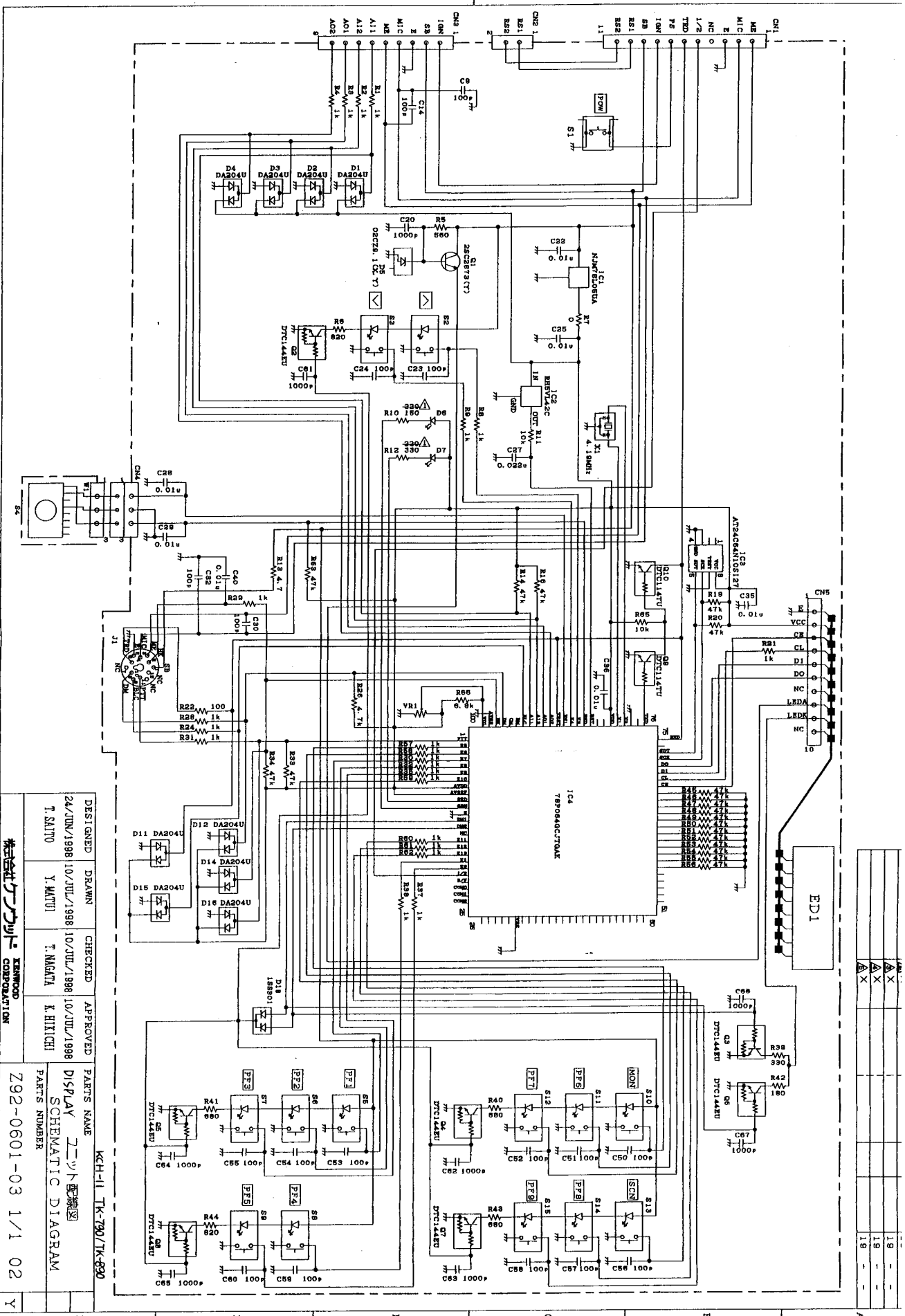

19	-
19	-
19	-

DESIGNED	24/JUN/1998	DRAWN	10/JUL/1998	CHECKED	10/JUL/1998	APPROVED	10/JUL/1998	PARTS NAME	DISPLAY ユニット配線図
								SCHMATIC DIAGRAM	
								PARTS NUMBER	Z92-0601-03 1/1 02
株式会社 伊藤電機製作所 ITO DENKI SEISAKUSHO CORPORATION									
KEH-11 TK-790/TK-690									

node: scad6 directory: /users/sch/work/c5236  
 time: 11:29 03-mar-98  
 name: ~~~~~

part: X54320H00

1	2	3	4
USE FOR	SYMBOL	REVISION NO	ISSUED DATE
Y60-3790-20	△ X		19 - -
	△ X		19 - -
	△ X		19 - -
	△ X		19 - -
	△ X		19 - -

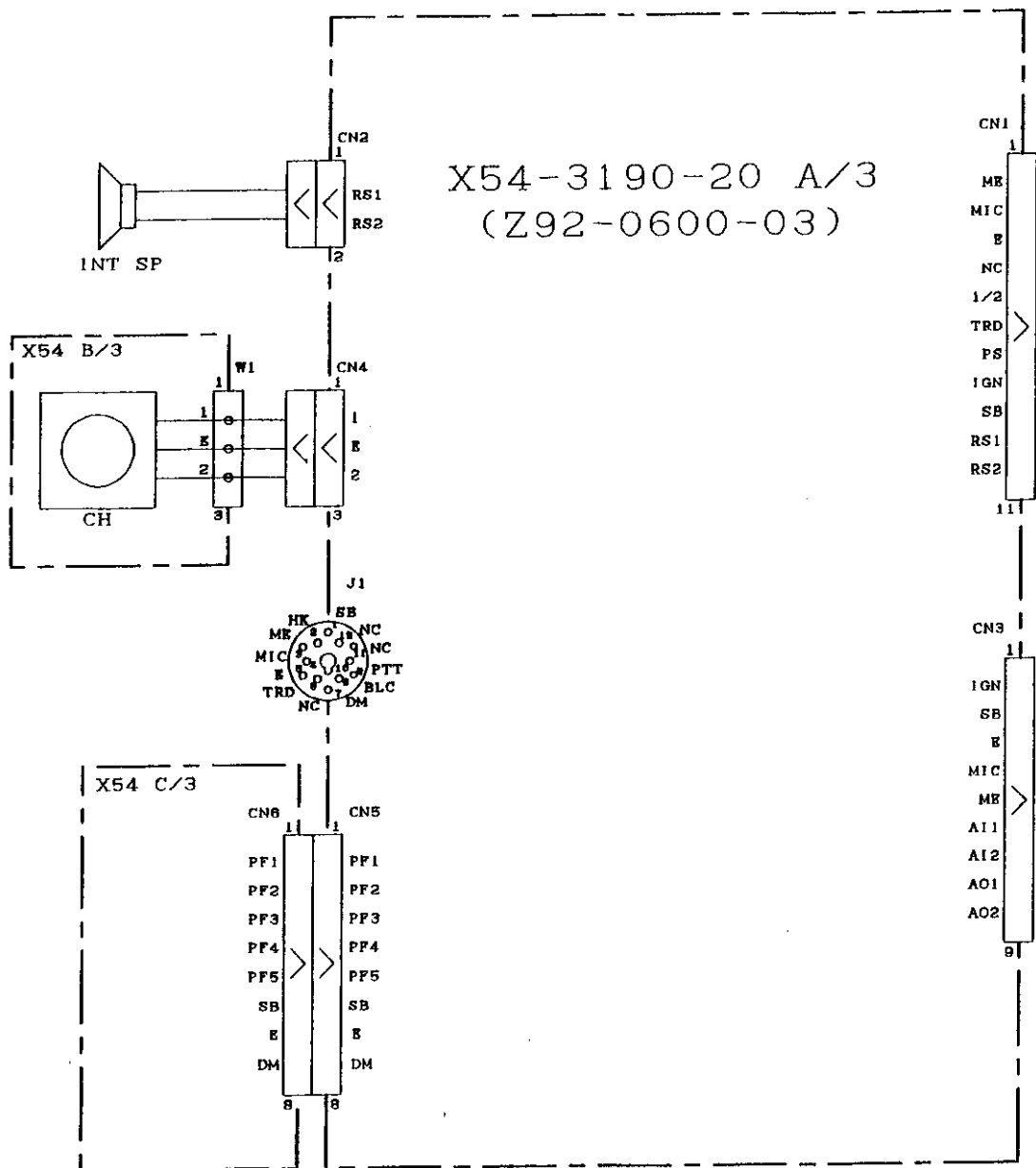

DESIGNED 05/JUN/1998 T. SAITO	DRAWN 24/JUN/1998 Y. MATUI	CHECKED 24/JUN/1998 T. SAITOU	APPROVED 29/JUN/1998 K. HIKICHI
-------------------------------------	----------------------------------	-------------------------------------	---------------------------------------

PARTS NAME 総配線図 INTERCONNECT DIAGRAM	TK-790/TK-890 KCH-10
PARTS NUMBER	

USE FOR	SYMBOL	REVISION NO	CODE	ISSUED	DATE
Y60-3800-20	△X				19 - -
	△X				19 - -
	△X				19 - -
	△X				19 - -
	△X				19 - -

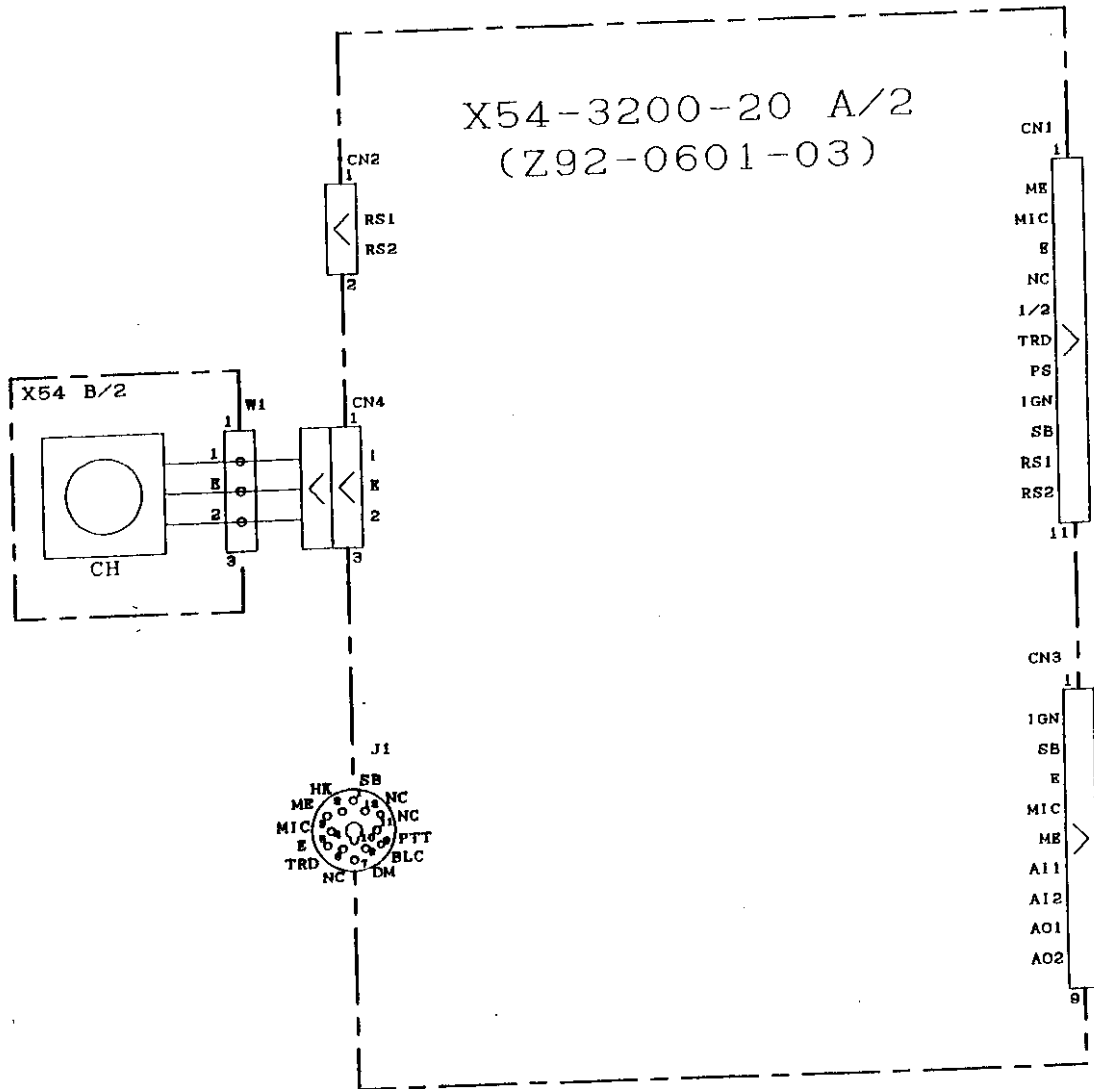

DESIGNED	DRAWN	CHECKED	APPROVED	PARTS NAME	TK-790 / TK-890
05/JUN/1998	24/JUN/1998	24/JUN/1998	29/JUN/1998	総配線図	KCH-11
T. SAITO	Y. MATUI	T. SAITOU	K. HIKICHI	INTERCONNECT DIAGRAM	
				PARTS NUMBER	
				783-3056-04 1/1 01	