



User Guide

Sempre

Amplified Telephone with Bluetooth Connectivity to Mobile Phones

TABLE OF CONTENTS

(to be updated when final)

Safety Instructions	4
Battery Instructions	7
Care and Maintenance.....	9
Technical Specifications.....	11
Clarity Logic	12
About Clarity	13
Package Contents	14
Installation.....	15
Getting to know your Sempre Phone.....	16
Using your Phone.....	21
Menu Operations.....	25
Phone Operations	40
Troubleshooting	43
FCC Requirements and Regulations.....	49
Warranty and Service.....	53

IMPORTANT SAFETY INSTRUCTIONS

To prevent severe injury and loss of life/property, read this section carefully before using the product to ensure proper and safe operation of your product.



Power connection

- Use only the power source marked on the product.
- Do not overload power outlets and extension cords. This can result in the risk of fire or electric shock.
- Completely insert the AC adapter/power plug into the power outlet. Failure to do so may cause electric shock and/or excessive heat resulting in a fire.
- Regularly remove any dust, etc. from the AC adapter/power plug by pulling it from the power outlet, then wiping with a dry cloth. Accumulated dust may cause an insulation defect from moisture, etc. resulting in a fire.
- Unplug the product from power outlets if it emits smoke, and abnormal smell, or makes an unusual noise. These conditions can cause fire or electric shock. Confirm that smoke has stopped emitting and contact the Clarity Customer Service at 800-426-3738.
- Unplug from power outlets and never touch the inside of the product if its casing has been broken open.
- Never touch the plug with wet hands. Danger of electric shock exists.

Installation

- To prevent the risk of fire or electrical shock, do not expose the product to rain or any type of moisture.
- Do not place or use this product near automatically controlled devices such as automatic doors and fire alarms. Radio waves emitted from this product may cause such devices to malfunction resulting in an accident.
- Do not allow the AC adaptor or telephone line cord to be excessively pulled, bent or placed under heavy objects.

IMPORTANT SAFETY INSTRUCTIONS

Operating safeguards

- Unplug the product from power outlets before cleaning. Do not use liquid or aerosol cleaners.
- Do not disassemble the product.
- Do not spill liquids (detergents, cleansers, etc.) onto the telephone line cord plug, or allow it to become wet at all. This may cause a fire. If the telephone line cord plug becomes wet, immediately pull it from the telephone wall jack, and do not use.

Medical

- Consult the manufacturer of any personal medical devices, such as pacemakers or hearing aids, to determine if they are adequately shielded from external RF (radio frequency) energy. (The product operates in the frequency range of 1.92 GHz to 1.93 GHz, and the RF transmission power is 100 mW (max.)) Do not disassemble the product.
- Do not use the product in health care facilities if any regulations posted in the area instruct you not to do so. Hospitals or health care facilities may be using equipment that could be sensitive to external RF energy.

IMPORTANT SAFETY INSTRUCTIONS



Installation and location

- Never install telephone wiring during an electrical storm.
- Never install telephone line jacks in wet locations unless the jack is specifically designed for wet locations.
- Never touch uninsulated telephone wires or terminals unless the telephone line has been disconnected at the network interface.
- Use caution when installing or modifying telephone lines.
- The AC adaptor is used as the main disconnect device. Ensure that the AC outlet is installed near the product and is easily accessible.
- This product is unable to make calls when there is a power failure (unless backup batteries have been installed and are fully charged).

When using your product, basic safety precautions should always be followed to reduce the risk of fire, electric shock, and injury to persons, including the following:

- Do not use this product near water for example, near a bathtub, washbowl, kitchen sink, or laundry tub, in a wet basement or near a swimming pool.
- Avoid using a telephone (other than a cordless type) during an electrical storm. There may be a remote risk of electric shock from lightning.
- Do not use the telephone to report a gas leak in the vicinity of the leak.
- Use only the power cord and batteries indicated in this manual. Do not dispose of batteries in a fire. They may explode. Check with local codes for possible disposal instructions.
- Do not mix old and new batteries.
- Do not open or mutilate the batteries. Released electrolyte from the batteries is corrosive and may cause burns or injury to the eyes and skin. The electrolyte is toxic and may be harmful if swallowed.

SAVE THESE INSTRUCTIONS

IMPORTANT BATTERY SAFETY INSTRUCTIONS

- Exercise care when handling the batteries. Do not allow conductive materials such as rings, bracelets, or keys to touch the batteries, otherwise a short circuit may cause the batteries and/or the conductive material to overheat and cause burns.
- Charge the batteries (optional) identified for use with this product only, in accordance with the instructions and limitations specified in this manual.
- Only use a compatible base unit (or charger) to charge the batteries. Do not tamper with the unit (or charger). Failure to follow these instructions may cause the batteries to swell or explode.

The base batteries are optional (for backup only). If you choose to install backup batteries, **use rechargeable batteries ONLY**. The backup batteries should be AA, NiMH, rechargeable only, rated 1900mAh. They must be fully charged for 3 days before using the backup batteries (before using the phone without the power adapter, during a power outage).

The backup batteries ensure the functionality of your unit for 3-4 hours in case of a power outage.

To install batteries in the base:

1. Turn the unit over and open battery compartment door.
2. Install batteries according to the polarity shown inside the battery compartment.
3. Close the battery compartment.

CAUTION: Disconnect the telephone line from the equipment before replacing batteries.

**WARNING: USE RECHARGEABLE BATTERIES ONLY.
DO NOT USE ALKALINE BATTERIES!**

**CAUTION: RISK OF EXPLOSION IF BATTERY IS REPLACED
BY INCORRECT TYPE. DISPOSE OF USED BATTERIES
ACCORDING TO THE INSTRUCTIONS.**

WARNING: Dispose of used batteries according to the instructions.

- Do not dispose of the battery in a fire as it may explode. Check with local codes for possible special disposal instructions.

SAVE THESE INSTRUCTIONS

IMPORTANT BATTERY SAFETY INSTRUCTIONS

- Do not open or mutilate the battery. Released electrolyte is corrosive and may cause damage to the eyes and skin. It may be toxic if swallowed.
- Exercise care in handling batteries in order not to short the battery with conducting materials such as rings, bracelets and keys. The battery or conduction material may over-heat and cause burns.
- Remove batteries when they are discharged and when the equipment will not be used for an extended period of time. Dispose of batteries according to local environmental laws.
- Do not disassemble, heat, crush, deform or puncture batteries.
- Do not attempt to charge non-rechargeable batteries.
- Keep batteries out of the reach of children.

SAVE THESE INSTRUCTIONS

CARE AND MAINTENANCE

FOR BEST PERFORMANCE

Base unit location/avoiding noise

The base unit and other compatible Clarity units use radio waves to communicate with each other.

- For maximum coverage and noise-free communications, place your base unit at a convenient, high, and central location with no obstructions between the handset and base unit in an indoor environment.
 - a. away from electronic appliances such as TVs, radios, personal computers, wireless devices, or other phones.
 - b. facing away from radio frequency transmitters, such as external antennas of mobile phone cell stations. (Avoid putting the base unit on a bay window or near a window.)
- Coverage and voice quality depends on the local environmental conditions.
- If the reception for a base unit location is not satisfactory, move the base unit to another location for better reception.

Environment

- Keep the product away from electrical noise generating devices, such as fluorescent lamps and motors.
- The product should be kept free from

excessive smoke, dust, high temperature, and vibration.

- The product should not be exposed to direct sunlight.
- Do not place heavy objects on top of the product.
- When you leave the product unused for along period of time, unplug the product from the power outlet.
- The product should be kept away from heat sources such as heaters, kitchen stoves, etc. It should not be placed in rooms where the temperature is less than 0 °C (32 °F) or greater than 40 °C (104 °F). Damp basements should also be avoided.
- The maximum calling distance may be shortened when the product is used in the following places: Near obstacles such as hills, tunnels, underground, near metal objects such as wire fences, etc.
- Operating the product near electrical appliances may cause interference. Move away from the electrical appliances.

Routine care

- Wipe the outer surface of the product with a soft moist cloth.
- Do not use benzene, thinner, or any abrasive powder.

CARE AND MAINTENANCE

Notice for product disposal, transfer, or return

- This product can store your private/confidential information. To protect your privacy/confidentiality, we recommend that you erase information such as phonebook or caller list from the memory before you dispose of, transfer, or return the product.
- This product is designed for use in the United States of America and Canada. Sale or use of this product in other countries may violate local laws.

TECHNICAL SPECIFICATIONS

Dimensions:

10.4" x 8" x 4.4" (26.4cm X 20.5cm x 11.2cm)

Weight: 2.7 lbs. (without AC adapter)

Standard: DECT 6.0 (Digital Enhanced Cordless Telecommunications 6.0)
Bluetooth wireless technology 2.0

Frequency range: 1.92 GHz to 1.93 GHz (DECT)
2.402 GHz to 2.48 GHz (Bluetooth)

RF transmission power:

100 mW (MAX)

Power specifications: AC Adapter

Input: 100V-240V AC, 50-60Hz

Output: 9V DC, 800mA

Use ONLY the power adapter supplied with your unit; using a different adapter may render your unit unusable and voids the warranty.

Power consumption:

Standby: 1.1 W

Maximum: 7 W

Battery information: Use ONLY rechargeable batteries, NiMH, AA, 1900mAh

Charge time: 6 hours
(from discharged to fully charged)

Note: *The batteries are charging while your phone is powered by the power adapter supplied with your unit.*

Use ONLY the power adapter supplied with your unit; using a different adapter may render your unit unusable and voids the warranty).

Standby time: Approx. 24 hours.

Talk time:

Sempre: Approx. 4 hours

Pendant: Approx. 4 hours

Operating conditions: 32 °F – 104 °F,
20 % – 80 % relative air humidity (dry)

CLARITY LOGIC™

Introduction to Clarity Logic

ClarityLogic is the name of our simplified and easy-to-use customer support service. When you use the ClarityLogic button to contact Clarity's Customer Support representatives, and authorize Clarity to receive information specific to your phone, Clarity may access information about your phone such as the phone's model name and settings. The representative is immediately aware of the type and current settings of the phone. This will allow any troubleshooting call to be quick and simple, helping you find exactly what you are looking for. Just use the pre-programmed ClarityLogic button on the Sempre phone or call 1-877-LOGIC24 (1-877-564-4224) to find out how Clarity is there to make life easier.

ClarityLogic® Memory Dial

For your convenience, Clarity has pre-programmed the customer support number into your phone's blue ClarityLogic button.

Note: *ClarityLogic has been designed to work with the Plain Old Telephone Service (POTS). If your phone service is provided by a broadband service provider, ClarityLogic may not work. ONLY CLARITYLOGIC MAY BE DISABLED. ALL OTHER FEATURES WORK AS DESCRIBED IN THIS USER GUIDE.*

INTRODUCTION

Thank you for purchasing your new Sempre from Clarity – the best home telephone in its class. Please read these instructions to ensure you take advantage of the complete set of rich features that this product offers.



Our Company

Clarity, a division of Plantronics (NYSE: PLT), creates smart communication solutions that help seniors live richer, more engaged lives. Founded more than 40 years ago, Clarity is a leader in amplified telephones, notification systems and assistive listening devices.

Clarity produces seven distinct lines of products and services: Clarity®, Clarity Professional®, ClarityLife®, Clarity AlertMaster®, ClarityLogic®, Ameriphone®, and Walker™ handset / test sets.

The company's innovative communication products are all designed to help people with hearing loss, low vision, limited mobility, dexterity issues and other health challenges.

PACKAGE CONTENTS

Your package includes all the items as shown below. If there is anything missing, please contact our Customer Care Department immediately.

NOTE: Please retain a copy of proof of purchase for your records.

- 1. Sempre telephone (pre-connected to the power adapter and telephone line cord)**
- 2. User guide**
- 3. Quick start guide**
- 4. Wall mount bracket**
- 5. Short phone line cord (for wall mounting)**

IMPORTANT: Please retain all packaging materials - including user guide etc - as well as accessories, in order to be able to receive full refund in case of returning.

INSTALLATION

Your product comes assembled as you take it out of the box. You will need to install three (3) AA NiMH re-chargeable batteries if you desire battery-power back-up in case of power failure. (Optional – batteries not included).

Connecting the Power and Phone cord

Step 1: Locate an electrical outlet (1) close to a phone outlet in your home.

Step 2: Pull the ends of the phone cord to untangle the cord; plug the free end of the phone cord into the phone outlet (2).

Step 3: Pull the ends of the power cord to untangle the cord; plug the power supply in the electrical outlet (3).

Step 4: Place handset in the cradle; lift the handset. If you hear dial tone, your telephone is ready to be used.

Battery Installation (Optional)

Step 1: Slide the battery compartment cover upward to remove.

Step 2: Insert three (3) AA NiMH rechargeable batteries as shown. Match the (+) and (-) terminals of individual batteries with the corresponding (+) and (-) connections located within the battery compartment.

Step 3: Slide the battery compartment cover back into position to complete the battery installation.

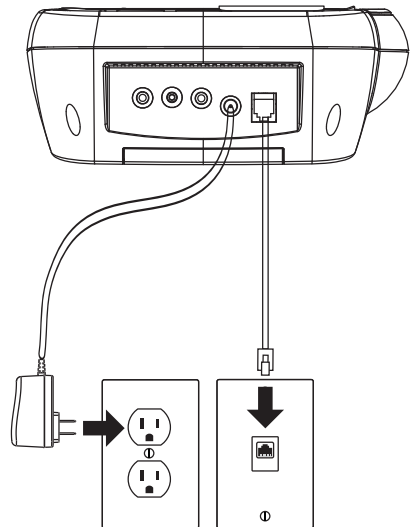
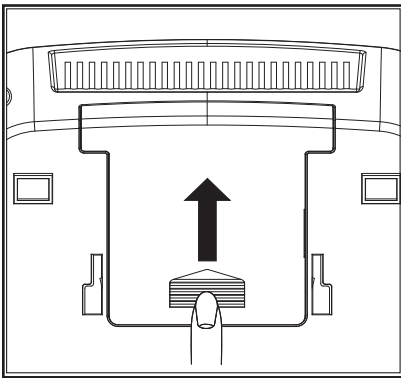

INSTALLATION

Wall Mount Installation

- Step 1:** Pull the handset hook out of the base and reverse its position so that the hook points up and will hold the handset when you hang up. **(See Figure 3)**
- Step 2:** Pull the ends of the phone cord to untangle the cord; run the cord through the groove on the back of the phone. Insert the tabs of the mounting bracket into the slots in the back of the phone. Push the mounting bracket in and down firmly until it snaps into place. **(See Figure 4)**
- Step 3:** Plug the flat telephone line cord into the wall plate jack, then align the mounting bracket's keyhole slots with the wall plate studs and slide the base of the phone downward to secure it on the wall. **(See Figure 5)**

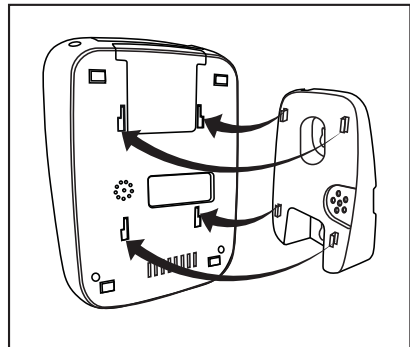
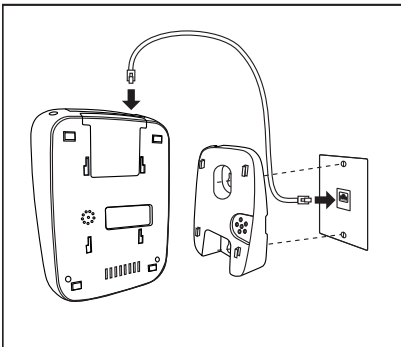
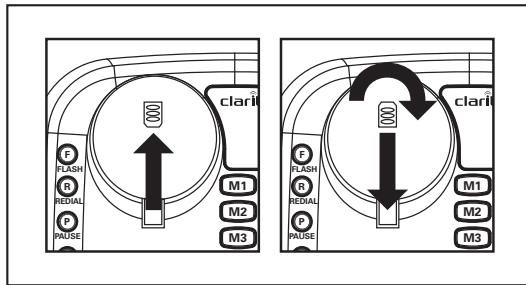

GETTING TO KNOW YOUR SEMPRE

Please take a moment to review your new product and its features.

This user guide applies to both versions. If your unit does not have an answering machine, ignore references to this feature during the review of this user guide.

1 FIND

- Press to find the pendant (*optional, purchased separately*) and/or the cordless handsets. (*optional, purchased separately*)

2 FLASH

- Press to switch between calls (*if you subscribe to Call Waiting as part of your phone service*) memory key.

3 REDIAL

- Press to redial the last phone number you called. Press and hold to enter a 2-second pause when programming records in your Phonebook.

4 MUTE/SILENT

- **During a ring** – press to temporarily silence the audible ringer. (*for ongoing calls only*)
- **During a call** – press to silence your side of the call. (*for privacy – button blinks red to indicate that the sound is temporarily muted*)
- **During idle mode** – press to silence the ringer. (*button light is lit solid red when ringer is turned off*)

5 SPEAKERPHONE button

6 CLARITYLOGIC (“blue button”)

- Press to directly contact our ClarityLogic customer service representatives – this allows you to get first rate assistance for your product through our custom patented remote access technology.

7 BOOST

- Press to engage additional power for your phone.

8 TONE button

- Press to toggle through the available tone settings.

9 VOLUME CONTROL

- Roll wheel up or down to increase/decrease the volume.

GETTING TO KNOW YOUR SEMPRE

10 VISUAL RINGER

- Flashes when calls are received.

11 TOUCHSCREEN

12 NUMERIC KEYPAD

13 BEDSHAKER PORT (3.5mm)

- Plug in a bed shaker (*C-2210 – optional, purchased separately*) – vibrates when the phone rings, for additional ringing signaling.

14 HEADSET PORT (2.5mm)

- Plug in a headset. (*M155 – optional, purchased separately*)

15 NECKLOOP PORT (3.5mm)

- Plug in a neckloop. (*CE-30 – optional, purchased separately*)

16 POWER PORT (3.5mm)

- Plug in AC power adapter. (*provided*)

17 LINE PORT

- Plug in phonecord. (*provided*)

18 BATTERY COMPARTMENT

- Use 3 AA rechargeable batteries to ensure continuous functionality in case of a power outage. (*see battery safety section*)

GETTING TO KNOW YOUR SEMPRE

Your touch screen has virtual buttons that will assist you with the simple functionality of this product.

General directions for navigating the menus and screens of your display (See Figure 1)

- At any time during the navigation through the menus and settings, press Flash to return to the idle screen.
- Use the on-screen arrow buttons for scrolling Up/Down through the menu options. Located in the upper left and right corner of the LCD menu screen.
- Use the on-screen “Back” button (located in the lower left corner of LCD menu screen) to return to the previous level in the settings menu.
- Use the on-screen Save button to save your settings; to exit without saving, use Back to discard changes, and return to previous screen.

In standby mode, your Sempre displays the following information on its screen (See Figure 2)

- **Status of Answering Machine:** (ON or OFF)
- **Date/Time:** Must be manually set in the Menu (see below) to accurately keep the time of your answering machine messages)
- **Menu button:** Access the settings for your phone.
- **Messages button:** Easily access the messages left on your answering machine.
- **Phonebook button:** Easily access the memory locations for your most often dialed phone numbers.

GETTING TO KNOW YOUR SEMPRE

Menu navigation buttons

(Press Up or Down buttons to scroll the menu listings.)

Functional buttons

Use these buttons to make selections, move backward, save, delete, and other functions.

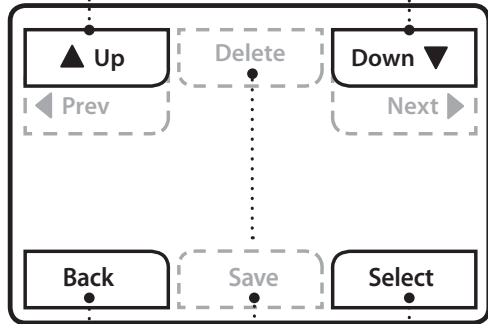

(Figure 1)

Automatic update of date and time

(with CID service)

Note: Must be initially set within the **System Setup Menu, Set Time/Set Date** in order for this feature to work correctly.

Automatic alert status of phone system operations

- Status of Answering Machine (ON/OFF) (Optional purchase)
- Phone line status (No Line) will display if phone cord not attached.
- Display of New Messages
- Ringer ON/OFF

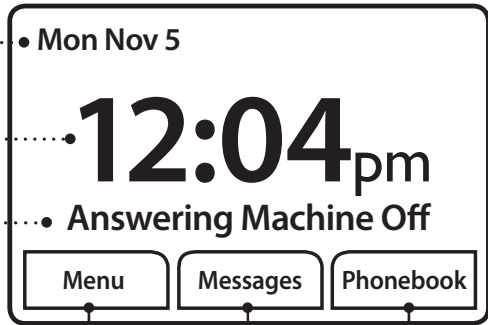

Touch buttons

Access the virtual menu features of the phone.

(Figure 2)

GETTING TO KNOW YOUR SEMPRE

MAKING CALLS

There are four methods for making an external call using your telephone - you can use the handset or the speakerphone for these methods: Preparatory dialing, Direct dialing, Phonebook dialing, and dialing from redial list.

Preparatory dialing

Enter the phone number using the numeric keypad then lift the handset. When using the mobile phone for outgoing calls, you **MUST** use this method.

Direct dialing

Lift the handset then manually dial the number using the numeric keypad. This method only works when dialing on your Home Phone line. It does **NOT** work when dialing out using the mobile phone.

Phonebook dialing

Press the “Phonebook” menu button on the main screen to access the phonebook directory. Press the “Next” or “Previous” button to find the phonebook number you wish to dial, then lift the handset. This method works for both Home Phone and Mobile Phone.

Dialing from Redial List

Press the “Redial” button to the left of the menu screen, then select the number to redial from the list by using the “Next” or “Previous” buttons, then lift the handset. This method works for both Home Phone and Mobile Phone.

Call timer

Your phone automatically times the duration of every call. During the call the timer will display the call duration in hours, minutes, and seconds. After the call is made, a “Talk Time” screen will display the total call time.

GETTING TO KNOW YOUR SEMPRE

RECEIVING CALLS

Answer a call

When there is an incoming call, the Visual Ringer will blink, and the ring tone will sound. When a call is incoming, the menu screen will display “Ringing”.

Note: To disable the audible ringer (during ringing or in standby), press MUTE/SILENT. Upon connection, the menu screen will display call information.

To answer and connect the call lift the handset.

Note: *You must subscribe to Caller ID services with your phone service provider in order for additional Caller ID information to be displayed.*

During a call

Use the volume wheel and the Tone (on screen or under the numeric keypad) button to best adjust the audio experience during a phone call.

Press the TONE button; you will see the current tone setting as a graph. While the graph is displayed on your screen, press the TONE button again to toggle through the available tone settings (there are 4 settings on this unit). When the audio adjustment best fits your needs, allow the unit to revert to the previous screen.

Adjust the volume of the incoming voice using the wheel – roll up to increase the volume, roll down to decrease the volume. As you move the wheel to increase the loudness, you will see three different colors on the screen.

Note: *During a call you can press the “Flash” button to switch between calls. However, you must subscribe to Call Waiting as part of your phone service.*

MENU OPERATIONS

CALLER LIST

("No records" if empty)

ANSWERING MACHINE

(If your model has this feature)

14 minutes of total recording time, each message can be up to 2-minutes long.

- **Answer On/Off**

- Default state is ON.

- **Outgoing Message (OGM)**

- Play OGM**

- Playing OGM? (Stop/Replay)

- Record OGM**

- Record OGM? (No/Yes)

- Please record after the tone (beep)
start recording your OGM

- "Recording OGM" – (End) – press
end to finish recording

- Select OGM**

- Default OGM (Save/Back)

- Recorded OGM**

- Becomes selected when OGM is
recorded by user.

- Erase OGM (No/Yes)**

- **Ring Number**

- Select from 3 – 8 Rings
and Toll Saver

- **Security PIN**

- Enter old PIN to change.
- Default PIN (123)

VOICE ASSIST

- **Talking Keypad (On/Off)**

- Default state is OFF.
- Pronounces the digits when dialing
the number to make an outgoing
call.

- **Talking CID (On/Off)**

- Default state is OFF.
- Pronounces the digits of the
number calling you – you will hear
"Call from (digits of incoming phone
number).

- Note:** this feature is active only if
you have CID with your phone ser-
vice. Purchased separately from your
phone service provider.

- **Talking Volume (Low/Medium/High)**

- BOOST OVERRIDE (On/Off)**

- Default state is OFF.
 - Press BOOST button to increase
sound amplification into extra-
loud range.

- VISUAL RINGER (On/Off)**

- Default state is ON.

ADVANCED MENU

- **Backlight Timeout**

- Select 30 seconds – or 1 minute up
to 30 minutes. Dims the screen to
extend the lifetime of the product.

- **Away Mode**

- Choose this option only if you
plan on not using your Sempre for
an extended period of time (like
vacation or similar). Your Sempre
is going to be in OFF mode, but the
backup batteries (if installed) will
remain properly charged. To exit
this mode and resume full function-
ality, press any key on the face of
your Sempre.

- **Note:** while in Away Mode, your
Sempre does not answer calls, ring,
communicate with accessories etc.

MENU OPERATIONS

SYSTEM SETUP

- **Register**

Use this feature to pair your Sempre with other compatible DECT6.0 devices. (*Clarity XLC3.5HSD/HSBD handset – sold separately*)

Alternatively, you can start registration mode by pressing and holding down the FIND button – until your screen displays “Registering...”.

- **Register (Deregister)**

- **Bluetooth** (*Pair/Unpair/Connect*)

Use to pair/connect with Bluetooth-equipped mobile phones.

- **Language** (*English/French/Spanish*)

Display language – for displayed text on your screen.

Voice language – for your talking keypad.

- **Ringer Style**

- Select from four (4) ringer tones.

- **Ringer Volume**

- Use Lo/Hi on-screen buttons to turn the ringer volume down or up.

Note: *You can also adjust the ringer volume by using the volume wheel in idle mode.*

- **Keypad Tone** (*On/Off*)

- **Note:** *If you have talking keypad enabled, you will not hear the keypad tones even if this feature is on.*

- **Set Time**

- Use keypad and on-screen buttons to set your local time.

Press Save on your screen to save your settings.

- **Set Date**

- Use keypad to set the date.

Press Save on your screen to save your settings.

Note: *If you have the CID enabled with your phone service provider, the time and day/month transmitted with your CID records overrides the manually set time/day/month. You still need to manually set the year to have an accurate time stamp for your answering machine messages.*

- **Tone/Pulse** (*Tone/Pulse*)

- **Default line**

- You have the choice of Home Phone line or Mobile Phone - this defines the method used to dial out the outgoing calls.

PHONEBOOK OPERATIONS

The phonebook can hold up to 100 entries. The name can be up to 26 characters (including spaces), and the number can be up to 60 digits. (See Figures 14–15)

- **Press Phonebook button**

The screen displays “Phonebook Empty”, then it shows “Add Phonebook Record?” with two buttons – Yes and No. Select Yes.

- **Enter Phonebook Number**

- (Enter digits) – Click Save
 - Enter Phonebook Name - enter letters (use keypad) to spell name. Click Save.
 - Additional Features: Skip/Add/Back, Skip/Phonebook and Record Saved.

- **Add**

- Features to be added are: record voice tag.

- **Record Voice Tag? (yes/no)**

- If a voice tag is associated with your phonebook record, then this voice tag will replace the voice digits during the Talking CID feature when there is an incoming call from this phone number. For example: if the phonebook number for the record is 123-456-7890, and the voice tag associated with this phonebook record is Mom, the phone will pronounce “Call from Mom” if there is an incoming call from this phone number (instead of “Call from 123-456-7890”).

Note: This feature works only when the Talking CID feature is activated.

Note: This feature is active only if you have CID with your phone service – purchased separately from your phone service provider.

- Select Yes
 - Please record after the tone (beep)
 - “Recording Voice Tag” – (End)
 - “Phonebook recorded with voice tag”

Note: A Play button is added to the main screen for the phonebook record.

- Select No
 - “Phonebook record saved”

If you have phonebook records saved in your phonebook, press the on-screen Phonebook button to enter your phonebook. Here you can review your saved records, edit them, or dial out from your phonebook.

To review/edit, navigate your saved records by using the Prev/Next buttons on your screen (upper left/right corners).

PHONEBOOK OPERATIONS

PHONEBOOK MENU BUTTON

On screen information

- Name
- Number
- Delete button: Press to delete the displayed record.
- Back: Press to exit the phonebook records menu.
- Add/Edit: Press to add another phonebook record, or to edit the displayed record; you will be asked to make a choice in the next screen.
- Play (*lower right corner*): Will be displayed only if the record has a voice tag associated with it.
- Add/Edit: Press the button for the action you wish to pursue.
Add – to add a new phonebook record.
Edit – to edit the currently displayed record.

MESSAGES MENU BUTTON

Press on-screen “Messages” button to access the answering machine messages. You can review/delete your messages as needed.

If you have new messages the “Messages” button will blink yellow. Press button to review, play, or delete the message.

To play messages, press the Play button; the screen briefly displays the number of new and old messages recorded by the answering machine. The newest message starts playing; during playback you have the option to stop the playback, to delete the message, or to press Next to skip to the next message. The screen shows the time/date of the message.

If there are no new messages, press the on-screen Messages button; the screen briefly displays the number of old messages. The screen shows the details of the last message recorded; press Play to review – follow on-screen buttons to delete/skip to next/previous message, or Back to exit the Messages menu.

CALLER LIST

CALLER LIST

Your phone saves the last 30 incoming calls placed to your phone number.

This list shows the details of the incoming calls – available only if your phone service has the Caller ID feature enabled. *(Purchased from your phone service provider).*

During an incoming call, the screen displays the phone number and name of the person calling you. These details are saved (along with the time and date of call) in your Caller List.

To review the Caller List, press “Menu” and then “Select” to review the list of the received calls.

To navigate between records, press Prev/Next (upper left and right corners on your screen).

Caller List Record

Name

As transmitted by your phone service provider.

Note: *some names are not transmitted; they can be displayed as “unknown” or similar.*

Note: *If the caller number is saved in your phonebook the name will be displayed when a call is received from that number.*

Number

Often received as 10-digit format: area code + local phone number)

Time

- Set hour and minute. Format: 11: 30
- Select 12 or 24 Hr
- Select am or pm

Date

- Set month, day and year.
Format: MM DD YY

Format button

Toggles the number format between 7 digits/10 digits/11 digits – to adjust according to your local dialing requirements; when the dialing format is correct, press the Talk button to call back the phone number displayed on the screen.

ADDITIONAL FEATURES

Save button

To save the number into your Phonebook; you will have the option to edit the name and/or number, as well as add the extra features available on this phone. We recommend you set the format of the phone number before saving the record to the phonebook.

BLUETOOTH FUNCTIONALITY

Your phone can be paired with a Bluetooth-enabled mobile phone – locate the user guide for your mobile phone to review the method of activating the pairing mode on your phone.

To pair a mobile phone with your Sempre: follow the on-screen prompts on your Sempre and your mobile phone.

Register a pendant or a spare cordless handset

(Optional, purchased separately)

You can have up to 4 devices connected to your phone:

- 4 spare handsets (XLC3.5HSD/XLC3.5HSBD) maximum
- 1 pendant + 3 (up to) spare handsets
- 2 pendants + 2 (up to) spare handsets

Place your pendant or handset in registration mode, and then start the registration mode on your phone.

To start registration mode on the pendant, press and hold the button on the pendant until you hear the third beep; release the button. The green/red lights will be flashing. Allow the registration process to complete, as it takes a few minutes.

Handset: you can use your handset for privacy; the handset can be used according to its user guide. You can page your handset by pressing the FIND button on your phone.

Pendant: you can use your pendant to access additional features for your phone.

Pendant features

(Optional – purchased separately)

Your pendant enhances the functionality of your telephone by adding the Quick Dial function to it. You can have two pendants registered to your phone; however, only one pendant will be active at one time (while the other is charging in its charger).

ADDITIONAL FEATURES

Quick Dial mode

- Default setting is OFF.
- If a pendant is registered to your phone, one of the Phonebook records can be set as your “Quick Access” contact. (This is part of the Additional Features associated with your phonebook records – accessible during Edit or Add modes for your phonebook records).
- Press and hold the pendant button for 3 seconds to activate this mode.

The phone dials out the phonebook record associated with the “Quick Dial” feature; upon answering the call, you can start a conversation with the contact in your phonebook that is associated with this feature; press the button again to end the conversation.

In case you are unable to end the call, the person contacted via this feature can end the conversation by pressing twice the “5” key on their phone.

TROUBLESHOOTING

Note: If you still have difficulties after following the instructions in this section, disconnect the AC adapter from the Sempre phone, then reconnect. If you are using an (optional) handset/s, remove and reinsert the batteries in the handset.

I cannot hear a dial tone.

- Make sure the AC adapter is connected properly.
- Confirm that the telephone line cord is connected properly.
- Disconnect the phone base unit from the telephone line cord and connect the line to a known working telephone. If the working telephone operates properly, contact our service personnel to have the unit repaired. If the working telephone does not operate properly, contact your telephone service provider.

The display is in a language I cannot read.

- Change the display language.
- Press the “Menu” button on the LCD screen. Press the “Down” arrow button to scroll to “System Setup”. Then select “Language”, then “Display”. Select your language from the three (3) options available. (English, French, Spanish)

Noise is heard — sound cuts in and out.

- You are using the handset or base unit in an area with high electrical interference.
- Lower the volume on your unit by turning down the Volume wheel.
- If you use a DSL/ADSL service, we recommend connecting a DSL/ADSL filter between the base unit and the telephone line jack. Contact your DSL/ADSL provider for details.

The base unit does not ring.

- Check the main LCD screen. If “Ringer Off” is displayed, then the silent/mute feature is active. Also check the “MUTE/SILENT” button light. If it is ON “red”, press the button to turn the light OFF which activates the ringer function.

I cannot make a call using the landline.

- The dialing mode may be set incorrectly.
- Change the setting by pressing the “Menu” button on the LCD screen. Then press the “Down” arrow button to scroll to “System Setup”. Select “Tone/Pulse”. Then select either the tone or pulse option as required or supported by your phone service.

TROUBLESHOOTING

I cannot make long distance calls.

- Confirm that you have long distance service.

Caller information is not displayed.

- You must subscribe to Caller ID service. Contact your telephone service provider for details.
- If your unit is connected to any additional telephone equipment such as a Caller ID box or cordless telephone line jack, plug the unit directly into the wall jack.
- If you use a DSL/ADSL service, we recommend connecting a DSL/ADSL filter between the base unit and the telephone line jack. Contact your DSL/ADSL provider for details.
- The name display service for landline calls may not be available in some areas. Contact your telephone service provider for details.
- Other telephone equipment may be interfering with this unit. Disconnect the other equipment and try again.

Caller information is displayed or announced late.

- Depending on your service provider, the unit may display or announce the caller's information at the second ring or later.
- Move closer to the base unit.

Caller information is not announced.

- The ringer volume is turned off. Adjust it by pressing the "Menu" button on the LCD screen. Then press the "Down" arrow button to scroll to "System Setup". Then select "Ringer Volume". Adjust the volume from "Lo" to "Hi" as needed.
- The talking Caller ID feature is turned off. Turn it ON. Change the setting by pressing the "Menu" button on the LCD screen. Then press the "Down" arrow button to scroll to "Voice Assist". Select "Talking CID", select ON and press "Save".
- Your unit does not announce caller information if the base unit or two or more handsets are on a call, or a headset is in use.

TROUBLESHOOTING

I cannot dial the phone number edited in the caller list.

- The phone number you dialed might have been edited incorrectly. For example, the long distance “1” or the area code is missing. Edit the phone number with another pattern.

Time on the unit has shifted.

- Incorrect time information from incoming Caller ID changes the time. To correct, reset the time and date using “System Setup” menu – “Set Time” – “Set Date”.

The second caller’s information is not displayed during an outside call.

- In order to use Caller ID, Call Waiting, or Call aiting Caller ID (CWID), you must first contact your service provider and subscribe to the desired service.
- After subscribing, you may need to contact your service provider again to activate this specific service, even if you already subscribed to both Caller ID and Call Waiting with Caller ID services (CWID).

An error tone is heard when I try to program the Bluetooth feature.

- The Bluetooth feature cannot be accessed immediately after connecting the AC adapter to the base unit. Wait a few seconds and try again.

The unit does not record new messages.

- The answering system is turned OFF. Turn it ON by pressing the “Menu” button on the LCD screen. Then press the “Down” arrow button to scroll to “Answering Machine”, then select “Answer On/Off”– complete the process by selecting “ON”.
- The message memory is full. Erase unnecessary messages by pressing the “Messages” button on the LCD screen. Then scroll through your messages, and press the “Delete” button for the message/s you wish to delete.
- If you subscribe to a voice mail service, messages are recorded by your service provider, not your telephone. Change the unit’s number of rings setting or contact your service provider.

TROUBLESHOOTING

I cannot operate the answering machine remotely.

- To remotely access your answering machine, call the phone number for your Sempre. When the Outgoing Message starts playing, enter the system pin (123) and follow the voice prompts for the unit, to play/delete messages on the unit.

Unable to access Automated Systems

- Automated systems used by banks, long distance voicemail and other applications require that a phone be set to “Tone” dialing. Confirm that the “Tone/Pulse” setting is set to “Tone”.

Poor audio quality.

- The base unit may be too close to electrical appliances, reinforced concrete walls or metal door frames. Move the base to another location.

I turned both the Sick Bell feature and the Quick Dial feature to on, but one of them doesn't work.

- You can't have both features active at the same time. You need to pick one to be active, and make sure that the other is set to off.

WARRANTY INFORMATION

The following warranty and service information applies only to products purchased and used in the U.S. and Canada. For warranty information in other countries, please contact your local retailer or distributor.

Limited Warranty: Clarity, a division of Plantronics, Inc. (“Clarity”) warrants to the original consumer purchaser that, except for limitations and exclusions set forth below, this product shall be free from defects in materials and workmanship for a period of one (1) year from the date of original purchase (“Warranty Period”). The obligation of Clarity under this warranty shall be at Clarity’s option, without charge, of any part or unit that proves to be defective in material or workmanship during the Warranty Period.

Exclusions from Warranty: This warranty applies only to defects in factory materials and factory workmanship. Any condition caused by accident, abuse, misuse or improper operation, violation of instructions furnished by Clarity, destruction or alteration, improper electrical voltages or currents, or repair or maintenance attempted by anyone other than Clarity or an authorized service center, is not a defect covered by this warranty. Telephone companies manufacture different types of equipment and Clarity does not warrant that its equipment is compatible with the equipment of a particular phone company.

Implied Warranties: Under state law, you may be entitled to the benefit of certain implied warranties. These implied warranties will continue in force only during the warranty period. Some states do allow limitations on how long an implied warranty lasts, so the above limitation may not apply to you.

Incidental or Consequential Damages: Neither Clarity nor your retail dealer or selling distributors has any responsibility for any incidental or consequential damages including without limitation, commercial loss or profit, or for any incidental expenses, loss of time, or inconvenience. Some states do not allow exclusion or limitation of incidental or consequential damage, so the above limitation or exclusion may not apply to you.

Other Legal Rights: This warranty gives you specific legal rights and you may also have other rights which vary from state to state.

To obtain warranty service, please prepay shipment and return the unit to the appropriate facility listed below.

WARRANTY INFORMATION

Clarity Service Center

Clarity, a Division of Plantronics, Inc.
6131 Preservation Drive
Chattanooga, TN 37416
Tel: 423-629-3500 or 800-426-3738
Fax: 423-622-7646 or 800-325-8871

Plantronics Service Centre

151 Hymus
Pointe-Claire, QC
H9R 1E9
Canada
Tel: 800-540-8363 or 514-956-8363
Fax: 514-956-1825

Please use the original container, or pack the unit(s) in a sturdy carton with sufficient packing material to prevent damage.

Include the following information:

- A proof-of-purchase indicating model number and date of purchase;
- Bill-to address;
- Ship-to address;
- Number and description of units shipped;
- Name and telephone number of person to call, should contact be necessary;
- Reason for return and description of the problem.

Damage occurring during shipment is deemed the responsibility of the carrier, and claims should be made directly with the carrier.

FCC REQUIREMENTS AND REGULATIONS

PART 68 OF FCC RULES INFORMATION

This equipment complies with Part 68 of the FCC rules and the requirements adopted by the ACTA. On the bottom of this equipment is a label that contains, among other information, a product identifier in the format US:AL8TE00BSEMPRE.

If requested, this number must be provided to the telephone company.

- Registration No. AL8 (found on the bottom of the unit)
- Ringer Equivalence No. (REN).....0.0B

A plug and jack used to connect this equipment to the premises wiring and telephone network must comply with the applicable FCC Part 68 rules and requirements adopted by the ACTA. A compliant telephone cord and modular plug is provided with the product. It is designed to be connected to a compatible modular jack that is also compliant.

The REN is used to determine the number of devices that may be connected to a telephone line. Excessive RENs on a telephone line may result in the devices not ringing in response to an incoming call. In most but not all areas, the sum of RENs should not exceed five (5.0). To be certain of the number of devices that may be connected to a line, as determined by the total RENs, contact the local telephone company. For products approved after July 23, 2001, the REN for the product is

part of the product identifier that has the format US:AL8TE00BSEMPRE. The digits represented by ## are the REN without a decimal point (e.g., 03 is a REN of 0.3).

If this equipment causes harm to the telephone network, the telephone company will notify you in advance that temporary discontinuance of service may be required. But if advance notice isn't practical, the telephone company will notify the customer as soon as possible. Also, you will be advised of your right to file a complaint with the FCC if you believe it is necessary.

The telephone company may make changes in its facilities, equipment, operations or procedures that could affect the operation of the equipment. If this happens the telephone company will provide advance notice in order for you to make necessary modifications to maintain uninterrupted service. If trouble is experienced with this equipment, for repair or warranty information, please contact a Factory Service Center or other Authorized Servicer.

If the equipment is causing harm to the telephone network, the telephone company may request that you disconnect the equipment until the problem is resolved.

Connection to party line service is subject to state tariffs. Contact the state public utility commission, public service commission or corporation commission for information.

FCC REQUIREMENTS AND REGULATIONS

If your home has specially wired alarm equipment connected to the telephone line, ensure the installation of this equipment does not disable your alarm equipment. If you have questions about what will disable alarm equipment, consult your telephone company or a qualified installer. This equipment is hearing aid compatible as defined by the FCC in 47 CFR Section 68.316.

When you hold the phone to your ear, noise might be heard in your Hearing Aid. Some Hearing Aids are not adequately shielded from external RF (radio frequency) energy. If noise occurs, use an optional headset accessory or the speakerphone option (if applicable) when using this phone. Consult with your audiologist or Hearing Aid manufacturer about the availability of Hearing Aids which provide adequate shielding to RF energy commonly emitted by digital devices.

WHEN PROGRAMMING EMERGENCY NUMBERS AND (OR) MAKING TEST CALLS TO EMERGENCY NUMBERS:

1. Remain on the line and briefly explain to the dispatcher the reason for the call.
2. Perform such activities in the off-peak hours, such as early morning or late evenings.

PART 15 OF FCC RULES INFORMATION

This device complies with Part 15 of the FCC Rules. Operation is subject to the following two conditions:(1) This device may not cause harmful interference, and (2) this device must accept any interference received, including interference that may cause undesired operation. Privacy of communications may not be ensured when using this phone.

CAUTION: Any changes or modifications not expressly approved by the party responsible for compliance could void the user's authority to operate this device.

NOTE: This equipment has been tested and found to comply with the limits for a Class B digital device, pursuant to Part 15 of the FCC Rules. These limits are designed to provide reasonable protection against harmful interference in a residential installation. This equipment generates, uses, and can radiate radio frequency energy and, if not installed and used in accordance with the instructions, may cause harmful interference to radio communications. However, there is no guarantee that interference will not occur in a particular installation. If this equipment does cause harmful interference to radio or television reception, which can be determined by turning the equipment off

FCC REQUIREMENTS AND REGULATIONS

and on, the user is encouraged to try to correct the interference by one or more of the following measures:

- Reorient or relocate the receiving antenna.
- Increase the separation between the equipment and receiver.
- Connect the equipment into an outlet on a circuit different from that to which the receiver is connected.
- Consult the dealer or an experienced radio/TV technician for help.

Some cordless telephones operate at frequencies that may cause interference to nearby TVs and VCRs. To minimize or prevent such interference, the base of the cordless telephone should not be placed near or on top of a TV or VCR. If interference is experienced, move the cordless telephone further away from the TV or VCR. This will often reduce or eliminate interference.

FCC RF Exposure Warning:

- This product complies with FCC radiation exposure limits set forth for an uncontrolled environment.
 - To comply with FCC RF exposure requirements, the base unit must be installed and operated 20 cm (8 inches) or more between the product and all person's body (excluding extremities of hands, wrist and feet).
- For body worn operation, this XLC3.5HSD/XLC3.5HSBD handset has been tested and meets the FCC RF exposure guidelines. Use of other accessories may not ensure compliance with FCC RF guidelines.
 - This product may not be collocated or operated in conjunction with any other antenna or transmitter.
 - The handset may be carried and operated with only the specific provided belt-clip. Other non-tested belt-clips or similar body-worn accessories may not comply and must be avoided.

Notice

FCC ID can be found on the bottom of the units.

INDUSTRY CANADA REGULATIONS

This product meets the applicable Industry Canada technical specifications/ Le présent matériel est conforme aux spécifications techniques applicables d'Industrie Canada

This device complies with Industry Canada licence-exempt RSS standard(s). Operation is subject to the following two conditions:

- (1) this device may not cause interference, and
- (2) this device must accept any interference, including interference that may cause undesired operation of the device.

Before installing this equipment, users should ensure that it is permissible to be connected to the facilities of the local telecommunications company. The equipment must also be installed using an acceptable method of connection. In some cases, the company's inside wiring associated with a single line individual service may be extended by means of a certified connector assembly (telephone extension cord).

The customer should be aware that compliance with the above conditions may not prevent degradation of service in some situations.

Users should ensure for their own protection that the electrical ground connections of the power utility, telephone lines and internal metallic water pipe system, if present, are connected together. This precaution may be particularly important in rural areas.

WARNING: Users should not attempt to make such connections themselves, but should contact the appropriate electric inspection authority, or electrician, as appropriate.

The Ringer Equivalence Number is an indication of the maximum number of terminals allowed to be connected to a telephone interface. The termination on an interface may consist of any combination of devices subject only to the requirement that the sum of the Ringer Equivalence Numbers of all the devices does not exceed five (5.0).

L'indice d'équivalence de la sonnerie (IES) sert à indiquer le nombre maximal de terminaux qui peuvent être raccordés à une interface téléphonique. La terminaison d'une interface peut consister en une combinaison quelconque de dispositifs, à la seule condition que la somme d'indices d'équivalence de la sonnerie de tous les dispositifs n'excède pas cinq.

This Class B digital apparatus complies with CAN ICES-003 (B)/NMB-3(B). [The term "IC:" before the certification/registration number only signifies that the Industry Canada technical specifications were met.]

PARTY RESPONSIBLE FOR REGULATORY COMPLIANCE:

Clarity, a Division of Plantronics, Inc.
6131 Preservation Drive
Chattanooga, TN 37416
Phone: 800-426-3738



Clarity, a Division of Plantronics, Inc.
6131 Preservation Drive
Chattanooga, TN 37416

Tel: 800-426-3738 Fax: 800-325-8871

E-mail: claritycs@plantronics.com

Website: www.clarityproducts.com

©2012 Clarity, a Division of Plantronics, Inc. All rights reserved. Clarity, Clarity Logic, Smart for Seniors, and Sempre are trademarks or registered trademarks of Plantronics, Inc.

Rev. 31 (11-13)

Printed in China