

C460C
Rev.0
08/08/2008

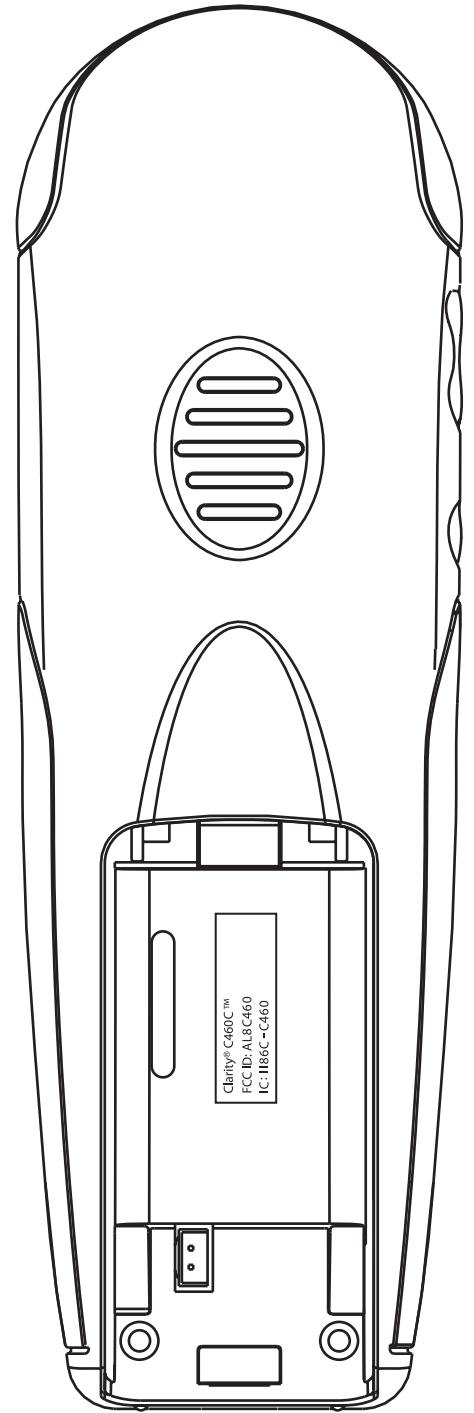

Label-LOUD
size: 15x10mm

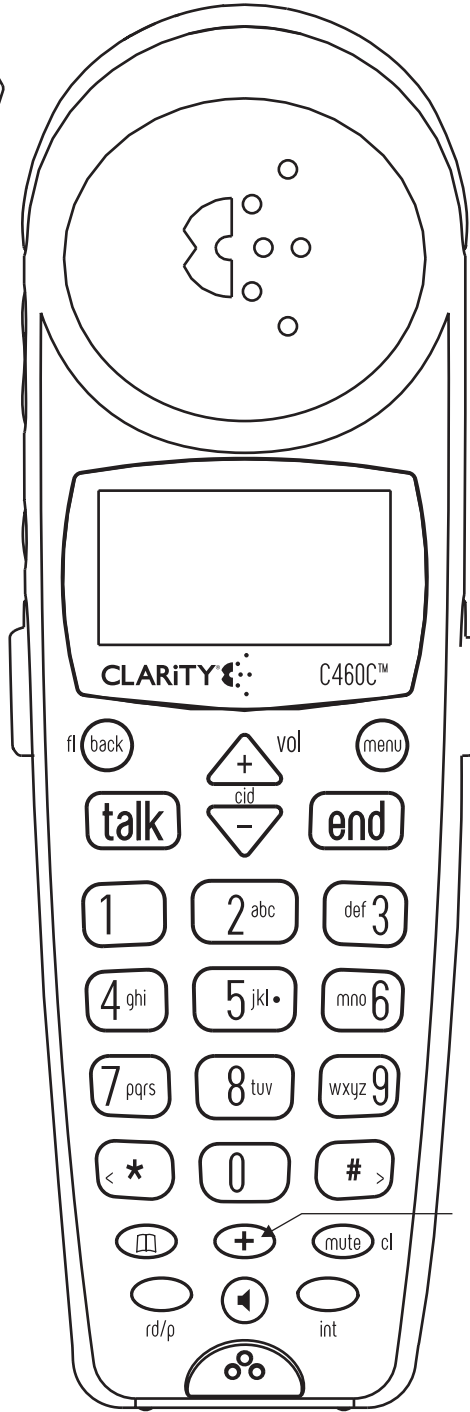
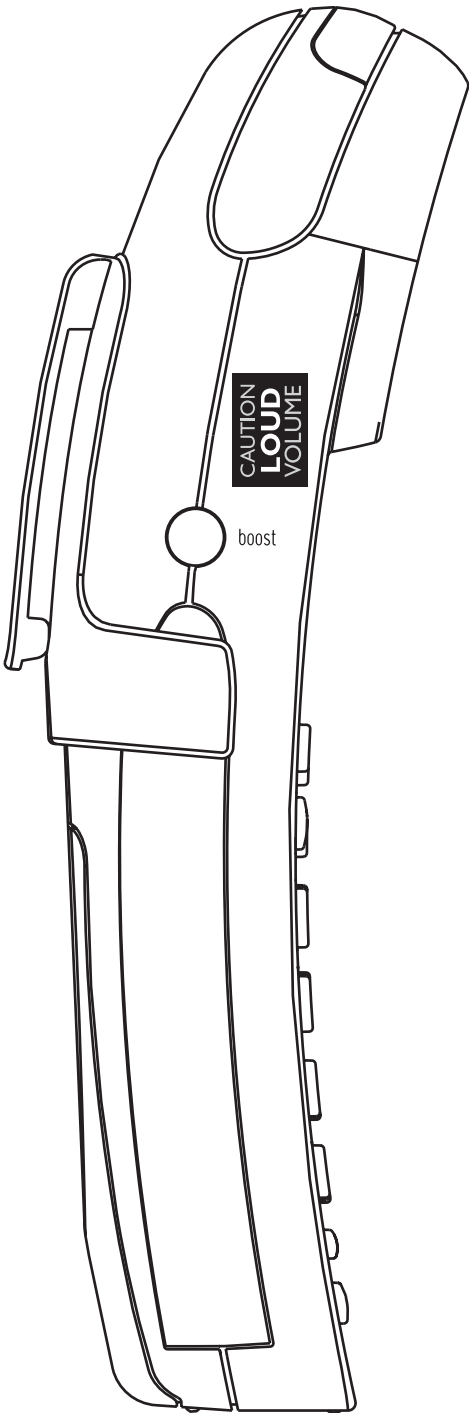
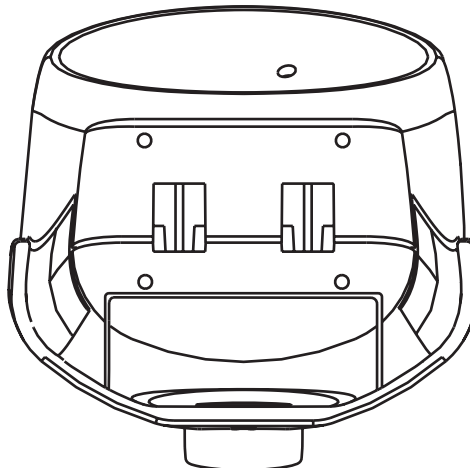

Label-H/S FCC
size: 25mm x 8mm

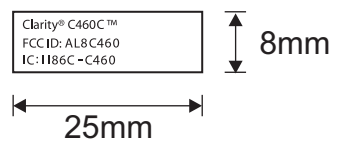

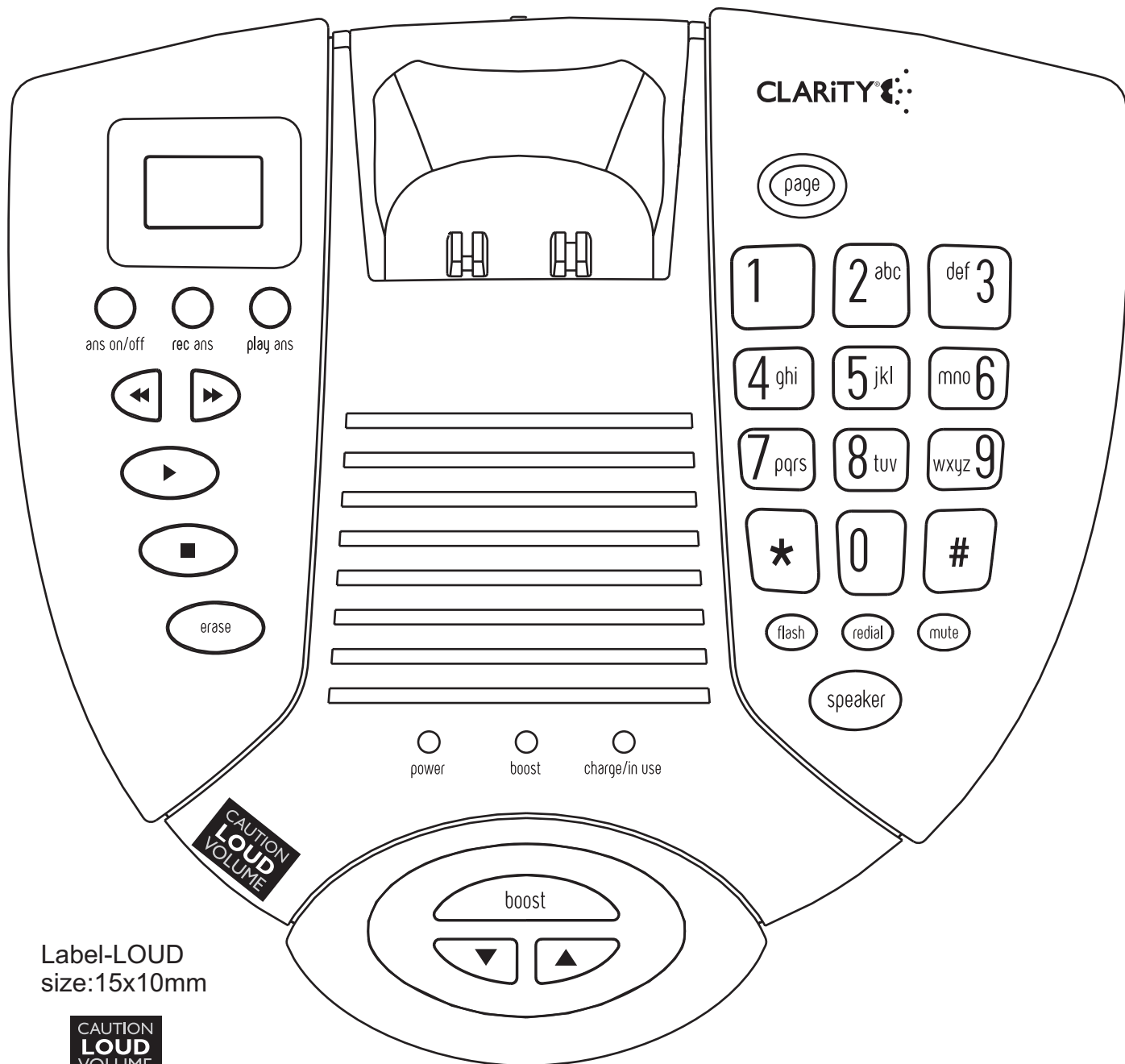
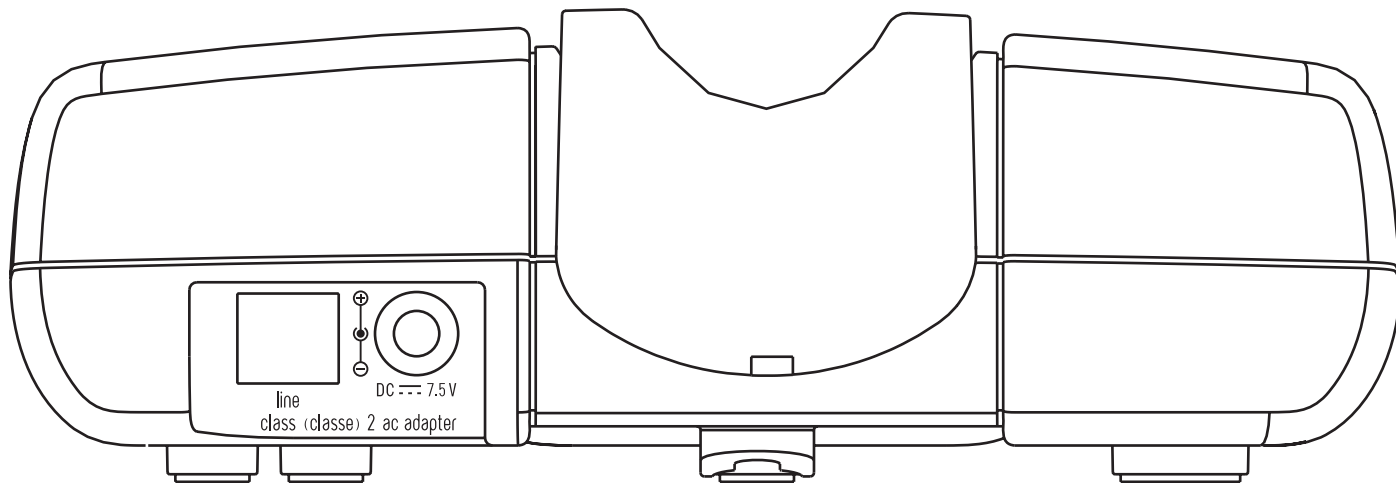

Label-LOUD
size:15x10mm



Label-BS FCC
size: 55mm x 40mm

Clarity C460C™ MFG CODE
Complies with 47CFR Part 68 Technical Requirements
FCC Reg. No.: US:AL8W400BC460 FCC ID: AL8C460
IC:1186C-C460 IC REN:0.0 Ringer Equivalence:0.0B USOC Jack:RJ11C
7.5V \equiv 500mA \ominus \oplus
Conforms to UL STD 60950-1
Certified to CAN/CSA STD C22.2 No. 60950-1-03.
This device complies with Part 15 of the FCC rules. Operation is subject to the following two conditions:
(1) This device may not cause harmful interference; (2) This device must accept any interference received, including interference that may cause undesired operation. Privacy of communications may not be ensured when using this phone.

Clarity, a division of Plantronics, Inc.
4289 Bonny Oaks Drive
Chattanooga, TN 37406
Voice: (800) 426-3738
Precision engineered in the USA. Made in China.
PL_C460_RevA



← Year
0098
Month
40 mm

55 mm

