



**FCC 47 CFR PART 15 SUBPART C**

**TEST REPORT**

**For**

**Bluetooth Headset**

**Model: Voyager PRO UC v2**

**Trade Name: Plantronics**

*Prepared for*

**Plantronics, Inc.**

**345 Encinal Street , Santa Cruz, CA 95060, USA**

*Issued by*

**COMPLIANCE CERTIFICATION SERVICES (KUNSHAN) INC.**

**10#Weiy Rd, Innovation Park Eco. & Tec. Development Zone**

**Kunshan city JiangSu, (215300) CHINA**

TEL: 86-512-57355888

FAX: 86-512-57370818



---

*Note: This report shall not be reproduced except in full, without the written approval of Compliance Certification Services Inc. This document may be altered or revised by Compliance Certification Services Inc. personnel only, and shall be noted in the revision section of the document.*



## TABLE OF CONTENTS

<b>1. TEST RESULT CERTIFICATION.....</b>	<b>3</b>
<b>2. EUT DESCRIPTION .....</b>	<b>4</b>
<b>3. TEST METHODOLOGY .....</b>	<b>5</b>
3.1 EUT CONFIGURATION .....	5
3.2 EUT EXERCISE.....	5
3.3 GENERAL TEST PROCEDURES.....	5
3.4 MEASUREMENT UNCERTAINTY .....	5
3.5 FCC PART 15.205 RESTRICTED BANDS OF OPERATIONS .....	6
3.6 DESCRIPTION OF TEST MODES .....	7
<b>4. INSTRUMENT CALIBRATION.....</b>	<b>8</b>
<b>5. FACILITIES AND ACCREDITATIONS .....</b>	<b>9</b>
5.1 FACILITIES .....	9
5.2 EQUIPMENT.....	9
5.3 TABLE OF ACCREDITATIONS AND LISTINGS.....	10
<b>6. SETUP OF EQUIPMENT UNDER TEST .....</b>	<b>11</b>
6.1 SETUP CONFIGURATION OF EUT.....	11
6.2 SUPPORT EQUIPMENT .....	11
<b>7. FCC PART 15.247 REQUIREMENTS.....</b>	<b>12</b>
7.1 PEAK POWER.....	12
7.2 BAND EDGES MEASUREMENT .....	14
7.3 FREQUENCY SEPARATION .....	25
7.4 NUMBER OF HOPPING FREQUENCY .....	31
7.5 TIME OF OCCUPANCY (DWELL TIME) .....	34
7.6 RADIO FREQUENCY EXPOSURE .....	41
7.7 SPURIOUS EMISSIONS.....	42
7.9 POWERLINE CONDUCTED EMISSIONS.....	59



# 1. TEST RESULT CERTIFICATION

**Applicant:** Plantronics, Inc.  
 345 Encinal Street , Santa Cruz, CA 95060, USA

**Equipment Under Test:** Bluetooth Headset

**Trade Name:** Plantronics

**Model:** Voyager PRO UC v2

**Date of Test:** From March 3, 2010 to March 10, 2010

APPLICABLE STANDARDS	
STANDARD	TEST RESULT
FCC 47 CFR Part 15 Subpart C	No non-compliance noted

### We here by certify that:

The above equipment was tested by Compliance Certification Services Inc. The test data, data evaluation, test procedures, and equipment configurations shown in this report were made in accordance with the procedures given in ANSI C63.4-2003: 2003 and the energy emitted by the sample EUT tested as described in this report is in compliance with the requirements of FCC Rules Part 15.207, 15.209, 15.247.

The test results of this report relate only to the tested sample EUT identified in this report.

Approved by:

Reviewed by:

Miro Chueh  
 EMC Manager  
 Compliance Certification Service Inc.

Lin Zhang  
 EMC Section Manager  
 Compliance Certification Service Inc.



## 2. EUT DESCRIPTION

<b>Product</b>	Bluetooth Headset
<b>Trade Name</b>	Plantronics
<b>Model Number</b>	Voyager PRO UC v2
<b>Bluetooth module Model Number</b>	BC05 MM
<b>Bluetooth module Brand name</b>	CSR
<b>Power Supply</b>	Built-in li-battery 3.75V 140mAh Charger: Trade name: PLANTRONICS Model number: SSA-3W-05 050018F Input: 100-240V, 50/60Hz, 0.2A Output: 5.0V, 180mA
<b>Frequency Range</b>	2402 ~ 2480 MHz
<b>Transmit Power</b>	2.61 dBm
<b>Modulation Technique</b>	FHSS
<b>Transmit Data Rate</b>	GFSK(1 Mbps), $\pi/4$ -DQPSK(2 Mbps),8-DPSK(3 Mbps)
<b>Number of Channels</b>	79 Channels
<b>Antenna Specification</b>	Antenna / Gain: -0.25 dBi

**Remark:** This submittal(s) (test report) is intended for FCC ID: AL8-VPRO filing to comply with Section 15.207, 15.209 and 15.247 of the FCC Part 15, Subpart C Rules.



### 3. TEST METHODOLOGY

The tests documented in this report were performed in accordance with ANSI C63.4-2003 and FCC CFR 47 2.1046, 2.1047, 2.1049, 2.1051, 2.1053, 2.1055, 2.1057, 15.207, 15.209 and 15.247.

#### 3.1 EUT CONFIGURATION

The EUT configuration for testing is installed on RF field strength measurement to meet the Commissions requirement and operating in a manner that intends to maximize its emission characteristics in a continuous normal application.

#### 3.2 EUT EXERCISE

The EUT was operated in the engineering mode to fix the TX frequency that was for the purpose of the measurements.

According to its specifications, the EUT must comply with the requirements of the Section 15.207, 15.209 and 15.247 under the FCC Rules Part 15 Subpart C.

#### 3.3 GENERAL TEST PROCEDURES

##### Conducted Emissions

The EUT is placed on the turntable, which is 0.8 m above ground plane. According to the requirements in Section 13.1.4.1 of ANSI C63.4-2003 Conducted emissions from the EUT measured in the frequency range between 0.15 MHz and 30MHz using CISPR Quasi-peak and average detector modes.

##### Radiated Emissions

The EUT is placed on a turn table, which is 0.8 m above ground plane. The turntable shall rotate 360 degrees to determine the position of maximum emission level. EUT is set 3m away from the receiving antenna, which varied from 1m to 4m to find out the highest emission. And also, each emission was to be maximized by changing the polarization of receiving antenna both horizontal and vertical. In order to find out the maximum emissions, exploratory radiated emission measurements were made according to the requirements in Section 13.1.4.1 of ANSI C63.4-2003.

#### 3.4 MEASUREMENT UNCERTAINTY

Where relevant, the following measurement uncertainty levels have been estimated for tests performed on the apparatus:

Measurement	Frequency	Uncertainty
Conducted emissions	9kHz~30MHz	+/- 1.13dB
Radiated emissions	30MHz ~ 200MHz	+/- 3.84dB
	200MHz ~1000MHz	+/- 3.82dB
	Above 1000MHz	+/-3.90dB

This uncertainty represents an expanded uncertainty expressed at approximately the 95% confidence level using a coverage factor of k=2.



### 3.5 FCC PART 15.205 RESTRICTED BANDS OF OPERATIONS

(a) Except as shown in paragraph (d) of this section, only spurious emissions are permitted in any of the frequency bands listed below:

MHz	MHz	MHz	GHz
0.090 - 0.110	16.42 - 16.423	399.9 - 410	4.5 - 5.15
<sup>1</sup> 0.495 - 0.505	16.69475 - 16.69525	608 - 614	5.35 - 5.46
2.1735 - 2.1905	16.80425 - 16.80475	960 - 1240	7.25 - 7.75
4.125 - 4.128	25.5 - 25.67	1300 - 1427	8.025 - 8.5
4.17725 - 4.17775	37.5 - 38.25	1435 - 1626.5	9.0 - 9.2
4.20725 - 4.20775	73 - 74.6	1645.5 - 1646.5	9.3 - 9.5
6.215 - 6.218	74.8 - 75.2	1660 - 1710	10.6 - 12.7
6.26775 - 6.26825	108 - 121.94	1718.8 - 1722.2	13.25 - 13.4
6.31175 - 6.31225	123 - 138	2200 - 2300	14.47 - 14.5
8.291 - 8.294	149.9 - 150.05	2310 - 2390	15.35 - 16.2
8.362 - 8.366	156.52475 -	2483.5 - 2500	17.7 - 21.4
8.37625 - 8.38675	156.52525	2655 - 2900	22.01 - 23.12
8.41425 - 8.41475	156.7 - 156.9	3260 - 3267	23.6 - 24.0
12.29 - 12.293	162.0125 - 167.17	3332 - 3339	31.2 - 31.8
12.51975 - 12.52025	167.72 - 173.2	3345.8 - 3358	36.43 - 36.5
12.57675 - 12.57725	240 - 285	3600 - 4400	( <sup>2</sup> )
13.36 - 13.41	322 - 335.4		

<sup>1</sup> Until February 1, 1999, this restricted band shall be 0.490-0.510 MHz.

<sup>2</sup> Above 38.6

(b) Except as provided in paragraphs (d) and (e), the field strength of emissions appearing within these frequency bands shall not exceed the limits shown in Section 15.209. At frequencies equal to or less than 1000 MHz, compliance with the limits in Section 15.209 shall be demonstrated using measurement instrumentation employing a CISPR quasi-peak detector. Above 1000 MHz, compliance with the emission limits in Section 15.209 shall be demonstrated based on the average value of the measured emissions. The provisions in Section 15.35 apply to these measurements.



### 3.6 DESCRIPTION OF TEST MODES

The EUT (Voyager PRO UC v2) has been tested under operating condition.

Software used to control the EUT for staying in continuous transmitting mode is programmed.

The field strength of spurious radiation emission was measured in the following position:

Mode 1: AC Mode at X Axis

Mode 2: AC Mode at Y Axis

Mode 3: AC Mode at Z Axis

Mode 4: DC Mode at X Axis

Mode 5: DC Mode at Y Axis

Mode 6: DC Mode at Z Axis

After verification, all tests were carried out with the worst case test modes as shown below

GFSK(1 Mbps) and 8-DPSK(3 Mbps) **Mode 1** Channel Low (2402MHz) · Mid (2441MHz) and High (2480MHz) were chosen for full testing.



## 4. INSTRUMENT CALIBRATION

The measuring equipment, which was utilized in performing the tests documented herein, has been calibrated in accordance with the manufacturer's recommendations for utilizing calibration equipment, which is traceable to recognized national standards.

### MEASUREMENT EQUIPMENT USED

#### Equipment Used for Emissions Measurement

*Remark: Each piece of equipment is scheduled for calibration once a year.*

Conducted Emissions Test Site				
Name of Equipment	Manufacturer	Model	Serial Number	Calibration Due
Spectrum Analyzer	Agilent	E4446A	MY44020154	08/15/2010
Peak and Avg Power Sensor	Agilent	E9327A	US40441788	07/29/2010
EPM-P Series Power Meter	Agilent	E4416A	QB41292714	07/29/2010

977 Chamber (3m)				
Name of Equipment	Manufacturer	Model	Serial Number	Calibration Due
Spectrum Analyzer	Agilent	E4446A	MY44020154	08/15/2010
ESPI3 EMI RECEIVER	R&S	ESPI3	101026	11/11/2010
Pre-Amplifier	MINI	ZFL-1000VH2	d041703	12/13/2010
Pre-Amplifier	Miteq	NSP4000-NF	870731	07/28/2010
Bilog Antenna	Sunol Sciences	JB1	A110204-2	11/22/2010
Horn Antenna	Austriah	BBHA9120D	D267	09/01/2010
Turn Table	CT	CT123	4162	N.C.R
Antenna Tower	CT	CTERG23	3253	N.C.R
Controller	CT	CT100	95635	N.C.R
Coax Switch	Anitsu	MP 598	M 80094	N/A
Site NSA	CCS Lab.	N/A	N/A	04/06/2010
Loop Antenna	ARA	PLA-1030/B	1029	02/24/2011

*Remark: Each piece of equipment is scheduled for calibration once a year.*

Conducted Emission Test Site				
Name of Equipment	Manufacturer	Model	Serial Number	Calibration Due
EMC Analyzer	Agilent	E7402A	US41160329	03/05/2011
V (V-LISN)	Schwarzbeck	NNLK 8129	8129-143	05/06/2010
LISN (EUT)	FCC	FCC-LISN-50/250-50-2-02	SN:05012	05/06/2010
TRANSIENT LIMITER	SCHAFFNER	CFL9206	1710	04/18/2010
RF Current Probe	FCC	F-65A	147	05/06/2010

*Remark: Each piece of equipment is scheduled for calibration once a year.*





## **5. FACILITIES AND ACCREDITATIONS**

### **5.1 FACILITIES**

All measurement facilities used to collect the measurement data are located at CCS China Kunshan Lab at 10#Weiye Rd, Innovation Park Eco. & Tec. Development Zone Kunshan city JiangSu, (215300), CHINA.

The sites are constructed in conformance with the requirements of ANSI C63.7, ANSI C63.4-2003 and CISPR Publication 22.

### **5.2 EQUIPMENT**

Radiated emissions are measured with one or more of the following types of linearly polarized antennas: tuned dipole, biconical, log periodic, bi-log, and/or ridged waveguide, horn. Spectrum analyzers with pre-selectors and quasi-peak detectors are used to perform radiated measurements.

Conducted emissions are measured with Line Impedance Stabilization Networks and EMI Test Receivers.

Calibrated wideband preamplifiers, coaxial cables, and coaxial attenuators are also used for making measurements.

All receiving equipment conforms to CISPR Publication 16-1, "Radio Interference Measuring Apparatus and Measurement Methods.



### 5.3 TABLE OF ACCREDITATIONS AND LISTINGS

Country	Agency	Scope of Accreditation	Logo
USA	A2LA	47 CFR FCC Part 15/18 (using ANSI C63.4:2003); VCCI V3; CNS 13438; CNS 13439; CNS 13803; CISPR 11; EN 55011; CISPR 13; EN 55013; CISPR 22:2005; CISPR 22:1997 +A1 :2000+A2 :2002; EN 55022:2006; EN55022 :1998 +A1 :2001+A2 :2003; EN 61000-6-3 (excluding discontinuous interference); EN 61000-6-4; AS/NZS CISPR 22; CAN/CSA-CEI/IEC CISPR 22; EN 61000-3-2; EN 61000-3-3; EN550024; EN 61000-4-2; EN 61000-4-3; EN61000-4-4; EN 61000-4-5; EN 61000-4-6; IEC 61000-4-8; EN 61000-4-11; IEC61000-3-2; IEC61000-3-3; IEC 61000-4-2; IEC 61000-4-3; IEC 61000-4-4; IEC 61000-4-5; IEC 61000-4-6; IEC 61000-4-8; IEC 61000-4-11; EN 300 220-3; EN 300 328; EN 300 330-2; EN 300 440-1; EN 300-440-2; EN 300 893; EN 301 489-01; EN 301 489-3; EN 301 489-07; EN 301 489-17, 301 489-19, 301 489-24, 301 489-25, 301 511clause4.2.2and clause4.2.3 and clause5.3.1 and clause5.3.2; EN 301 908-2 clause 4.2.4 and clause 4.2.10 and clause5.3.9; 47 CFR FCC Part 15, 22, 24	
USA	FCC	3/10 meter Sites to perform FCC Part 15/18 measurements	 238958, 424105
Japan	VCCI	3/10 meter Sites and conducted test sites to perform radiated/conducted measurements	 R-1600 C-1707 T-1499

*\* No part of this report may be used to claim or imply product endorsement by A2LA or any agency of the US Government.*



## 6. SETUP OF EQUIPMENT UNDER TEST

### 6.1 SETUP CONFIGURATION OF EUT

See test photographs attached in Appendix 1 for the actual connections between EUT and support equipment.

### 6.2 SUPPORT EQUIPMENT

No.	Equipment	Model No.	Serial No.	FCC ID	Trade Name	Data Cable	Power Cord
1	Notebook PC	2672	998W21C	DoC	IBM	N/A	N/A

**Remark:**

- 1. All the equipment/cables were placed in the worst-case configuration to maximize the emission during the test.*
- 2. Grounding was established in accordance with the manufacturer's requirements and conditions for the intended use.*



## 7. FCC PART 15.247 REQUIREMENTS

### 7.1 PEAK POWER

#### LIMIT

The maximum peak output power of the intentional radiator shall not exceed the following:

1. According to §15.247(a)(1), Frequency hopping systems shall have hopping channel carrier frequencies separated by a minimum of 25 kHz or the 20 dB bandwidth of the hopping channel, whichever is greater. Alternatively, frequency hopping systems operating in the 2400-2483.5 MHz band may have hopping channel carrier frequencies that are separated by 25 kHz or two-thirds of the 20 dB bandwidth of the hopping channel, whichever is greater, provided the systems operate with an output power no greater than 125 mW.
2. According to §15.247(b)(3), for systems using digital modulation in the bands of 902-928 MHz, 2400-2483.5 MHz, and 5725-5850 MHz: 1 Watt.
3. According to §15.247(b)(4), the conducted output power limit specified in paragraph (b) of this section is based on the use of antennas with directional gains that do not exceed 6 dBi. Except as shown in paragraph (c) of this section, if transmitting antennas of directional gain greater than 6 dBi are used, the conducted output power from the intentional radiator shall be reduced below the stated values in paragraphs (b)(1), (b)(2), and (b)(3) of this section, as appropriate, by the amount in dB that the directional gain of the antenna exceeds 6 dBi.

#### Test Configuration

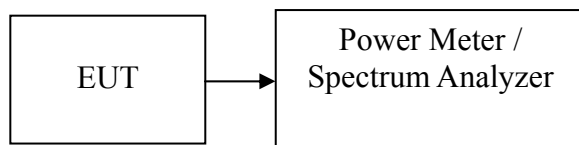

#### TEST PROCEDURE

The transmitter output is connected to the Power Meter.



**TEST RESULTS**

*No non-compliance noted*

**Test Data**

**1M**

Channel	Frequency (MHz)	Reading Power (dBm)	Factor (dB)	Output Power (dBm)	Output Power (mW)	Limit (mW)	Result
Low	2402	0.73	1.00	1.73	1.49	125	PASS
Mid	2441	1.20	1.00	2.20	1.66		PASS
High	2480	1.61	1.00	2.61	1.82		PASS

**3M**

Channel	Frequency (MHz)	Reading Power (dBm)	Factor (dB)	Output Power (dBm)	Output Power (mW)	Limit (mW)	Result
Low	2402	0.33	1.00	1.33	1.36	125	PASS
Mid	2441	0.72	1.00	1.72	1.49		PASS
High	2480	1.03	1.00	2.03	1.60		PASS

## 7.2 BAND EDGES MEASUREMENT

### LIMIT

According to §15.247(d), in any 100 kHz bandwidth outside the frequency bands in which the spread spectrum intentional radiator is operating, the radio frequency power that is produced by the intentional radiator shall be at least 20 dB below that in the 100 kHz bandwidth within the band that contains the highest level of the desired power, based on either an RF conducted or a radiated measurement, provided the transmitter demonstrates compliance with the peak conducted power limits. In addition, radiated emissions which fall in the restricted bands, as defined in §15.205(a), must also comply with the radiated emission limits specified in 15.209(a) (see Section 15.205(c)).

### Test Configuration

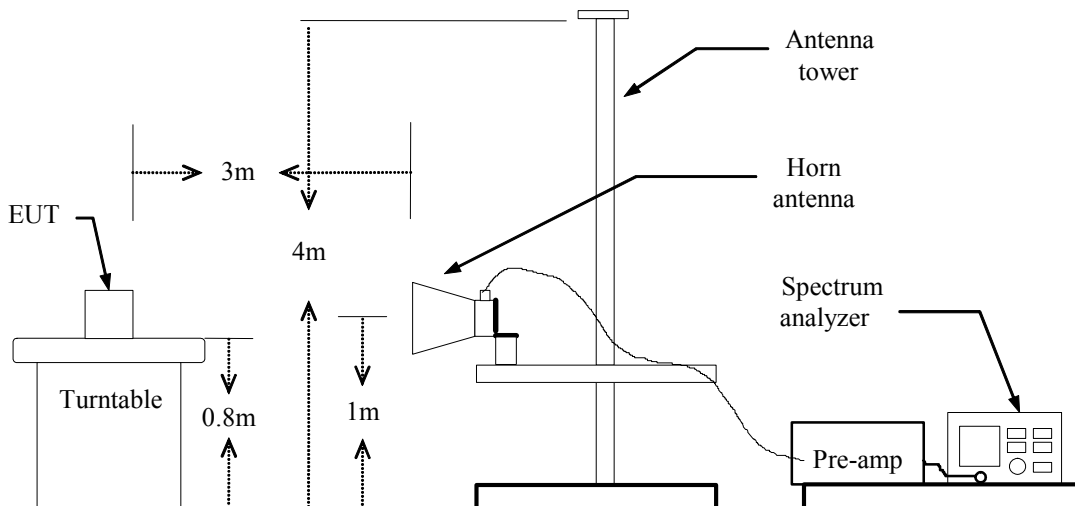

### TEST PROCEDURE

1. The EUT is placed on a turntable, which is 0.8m above the ground plane.
2. The turntable shall be rotated for 360 degrees to determine the position of maximum emission level.
3. EUT is set 3m away from the receiving antenna, which is varied from 1m to 4m to find out the highest emission.
4. Set the spectrum analyzer in the following setting in order to capture the lower and upper band-edges of the emission:
  - (a) PEAK: RBW=VBW=1MHz / Sweep=AUTO
  - (b) AVERAGE: RBW=1MHz / VBW=10Hz / Sweep=AUTO
5. Repeat the procedures until all the PEAK and AVERAGE versus POLARIZATION are measured.



**TEST RESULTS**

**1M**

**CH LOW**

Freq. (MHz)	Ant. Pol H/V	Peak	AV	Ant. / CL	Actual Fs		Peak	AV	Peak	AV
		Reading	Reading	CF	Peak (dBuV/m)	AV (dBuV/m)	Limit (dBuV/m)	Limit (dBuV/m)	Margin (dB)	Margin (dB)
		(dBuV)	(dBuV)	(dB)						
2390.00	V	46.92	34.88	0.73	47.65	35.61	74	54	-26.35	-18.39
2390.00	H	47.95	34.96	0.73	48.68	35.69	74	54	-25.32	-18.31

**CH HIGH**

Freq. (MHz)	Ant. Pol H/V	Peak	AV	Ant. / CL	Actual Fs		Peak	AV	Peak	AV
		Reading	Reading	CF	Peak (dBuV/m)	AV (dBuV/m)	Limit (dBuV/m)	Limit (dBuV/m)	Margin (dB)	Margin (dB)
		(dBuV)	(dBuV)	(dB)						
2483.50	V	49.25	35.95	0.73	49.98	36.68	74	54	-24.02	-17.32
2483.50	H	51.51	37.06	0.73	52.24	37.79	74	54	-21.76	-16.21

Refer to attach spectrum analyzer data chart.



### Band Edges (CH Low)

Detector mode: Peak

Polarity: Vertical

Agilent

R T

Marker

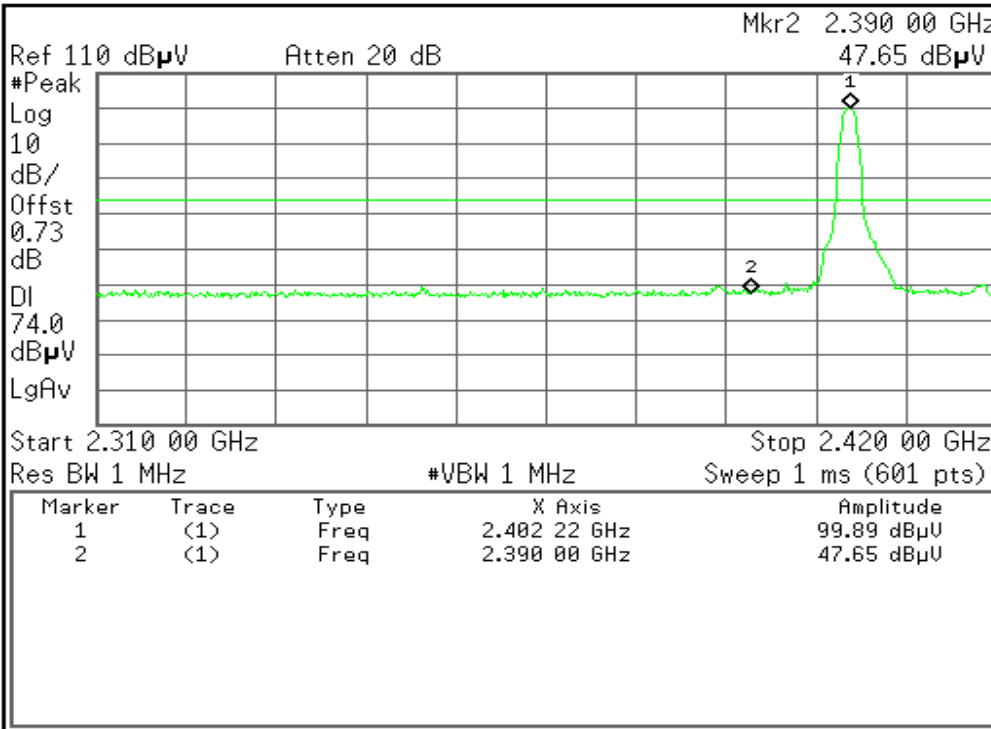

Mkr2 2.390 00 GHz  
47.65 dBµV

Select Marker  
1 2 3 4

Normal

Delta

Delta Pair  
(Tracking Ref)  
Ref ▲

Span Pair  
Span Center

Off

More  
1 of 2

Copyright 2000-2009 Agilent Technologies

Detector mode: Average

Polarity: Vertical

Agilent

R T

Marker

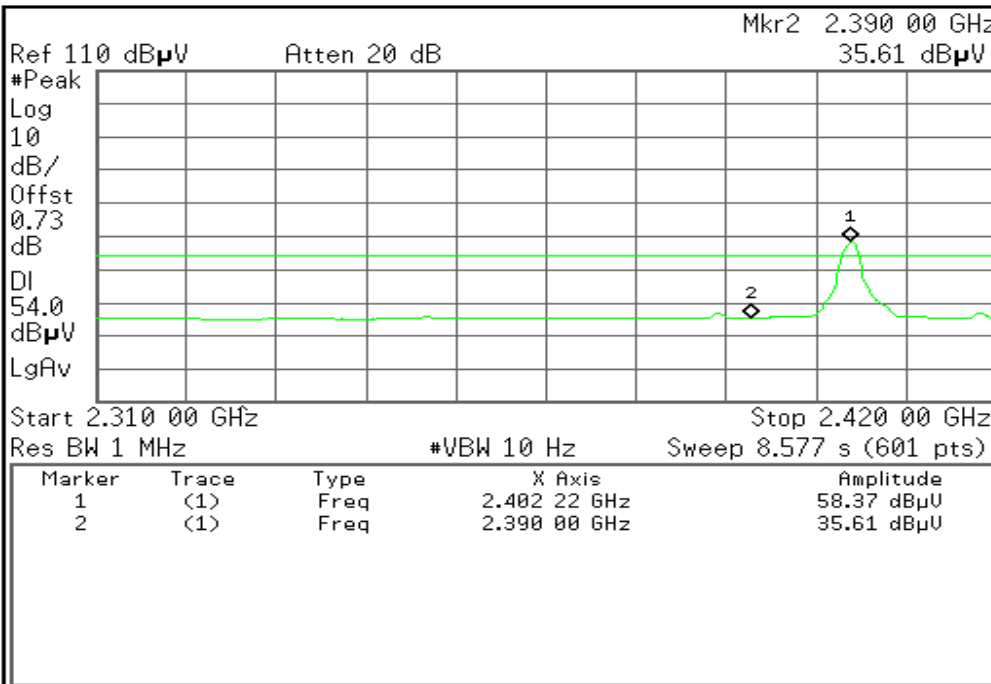

Mkr2 2.390 00 GHz  
35.61 dBµV

Select Marker  
1 2 3 4

Normal

Delta

Delta Pair  
(Tracking Ref)  
Ref ▲

Span Pair  
Span Center

Off

More  
1 of 2

Copyright 2000-2009 Agilent Technologies





Detector mode: Peak

Polarity: Horizontal

Agilent

R T

Marker

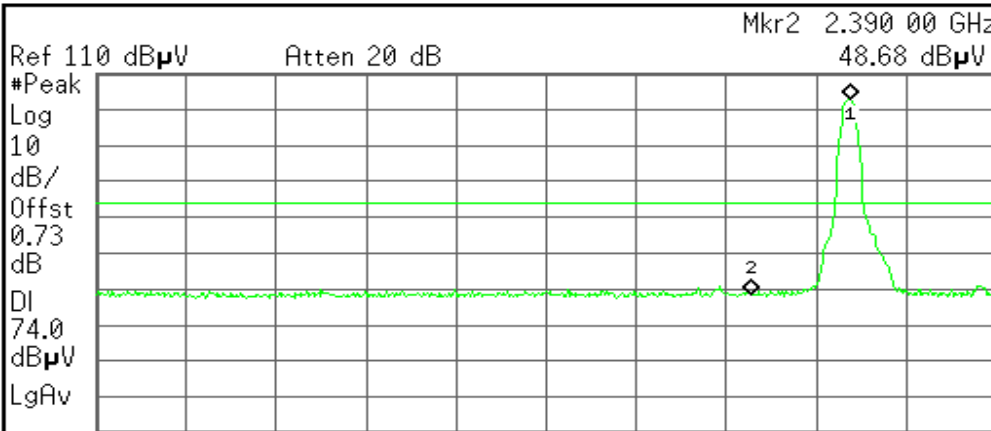

Select Marker  
1 2 3 4

Normal

Delta

Delta Pair  
(Tracking Ref)  
Ref ▲

Span Pair  
Span Center

Off

More  
1 of 2

Marker	Trace	Type	X Axis	Amplitude
1	(1)	Freq	2.402 22 GHz	102.64 dBµU
2	(1)	Freq	2.390 00 GHz	48.68 dBµU

Copyright 2000-2009 Agilent Technologies

Detector mode: Average

Polarity: Horizontal

Agilent

R T

Marker

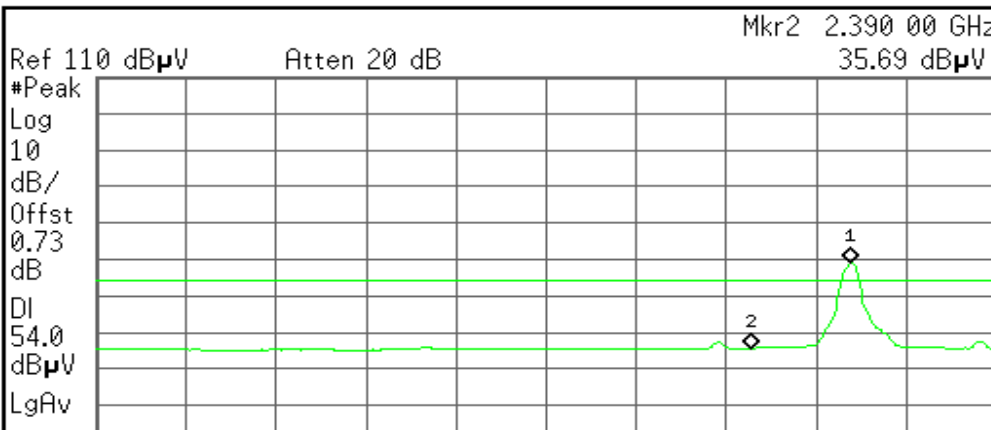

Select Marker  
1 2 3 4

Normal

Delta

Delta Pair  
(Tracking Ref)  
Ref ▲

Span Pair  
Span Center

Off

More  
1 of 2

Marker	Trace	Type	X Axis	Amplitude
1	(1)	Freq	2.402 22 GHz	59.01 dBµU
2	(1)	Freq	2.390 00 GHz	35.69 dBµU

Copyright 2000-2009 Agilent Technologies



### Band Edges (CH High)

Detector mode: Peak

Polarity: Vertical

Agilent

R T

Marker

Ref 110 dB $\mu$ V Atten 20 dB Mkr2 2.483 50 GHz 49.98 dB $\mu$ V

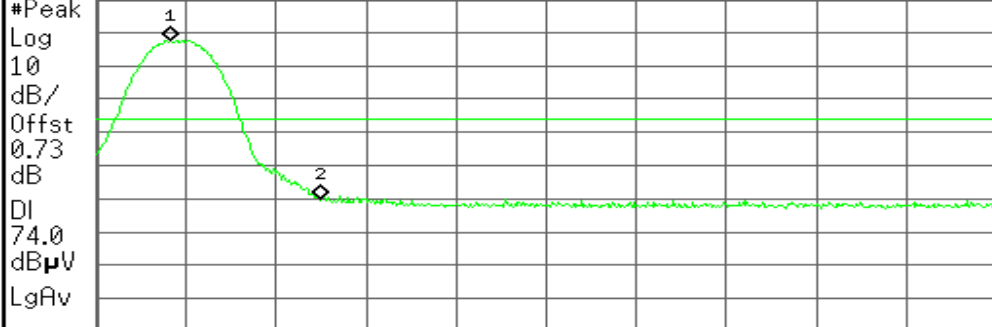

Start 2.478 00 GHz Stop 2.500 00 GHz #Res BW 1 MHz #VBW 1 MHz Sweep 1 ms (601 pts)

Marker	Trace	Type	X Axis	Amplitude
1	(1)	Freq	2.479 83 GHz	97.48 dB $\mu$ V
2	(1)	Freq	2.483 50 GHz	49.98 dB $\mu$ V

Select Marker 1 2 3 4

Normal

Delta

Delta Pair (Tracking Ref) Ref  $\Delta$

Span Pair Span Center

Off

More 1 of 2

Copyright 2000-2009 Agilent Technologies

Detector mode: Average

Polarity: Vertical

Agilent

R T

Marker

Ref 110 dB $\mu$ V Atten 20 dB Mkr2 2.483 50 GHz 36.68 dB $\mu$ V

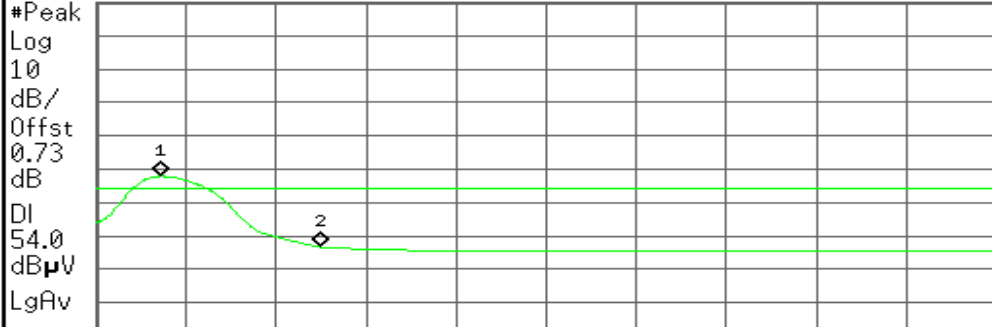

Start 2.478 00 GHz Stop 2.500 00 GHz #Res BW 1 MHz #VBW 10 Hz Sweep 1.715 s (601 pts)

Marker	Trace	Type	X Axis	Amplitude
1	(1)	Freq	2.479 58 GHz	57.86 dB $\mu$ V
2	(1)	Freq	2.483 50 GHz	36.68 dB $\mu$ V

Select Marker 1 2 3 4

Normal

Delta

Delta Pair (Tracking Ref) Ref  $\Delta$

Span Pair Span Center

Off

More 1 of 2

Copyright 2000-2009 Agilent Technologies



Detector mode: Peak

Polarity: Horizontal

Agilent

R T

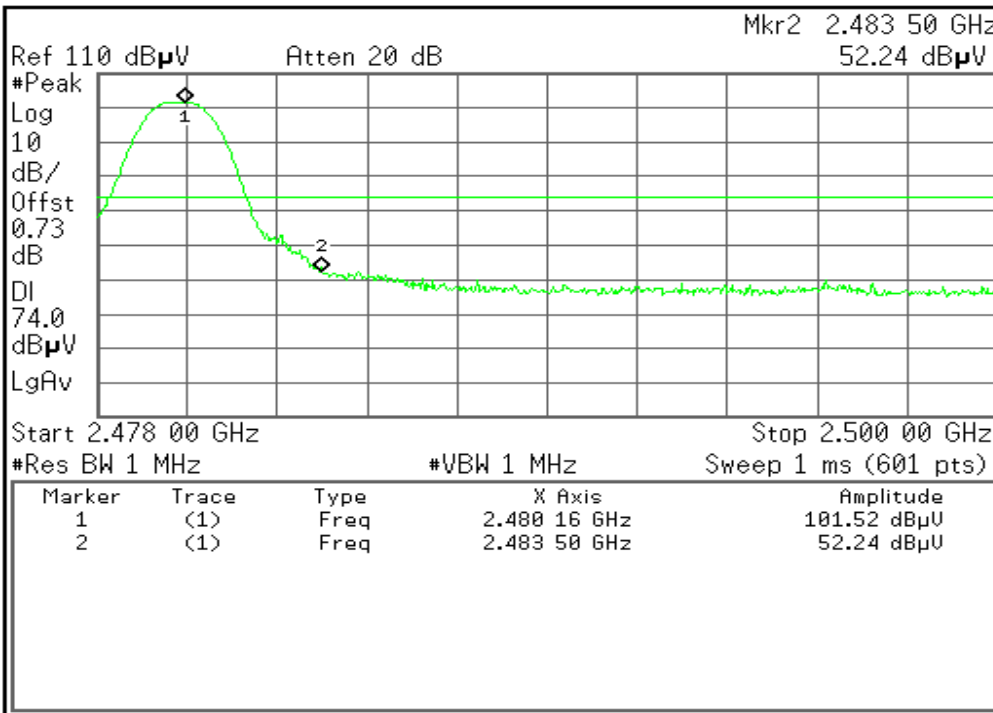

**Marker**

Select Marker  
1 2 3 4

Normal

Delta

Delta Pair  
(Tracking Ref)  
Ref  $\Delta$

Span Pair  
Span Center

Off

More  
1 of 2

Copyright 2000-2009 Agilent Technologies

Detector mode: Average

Polarity: Horizontal

Agilent

R T

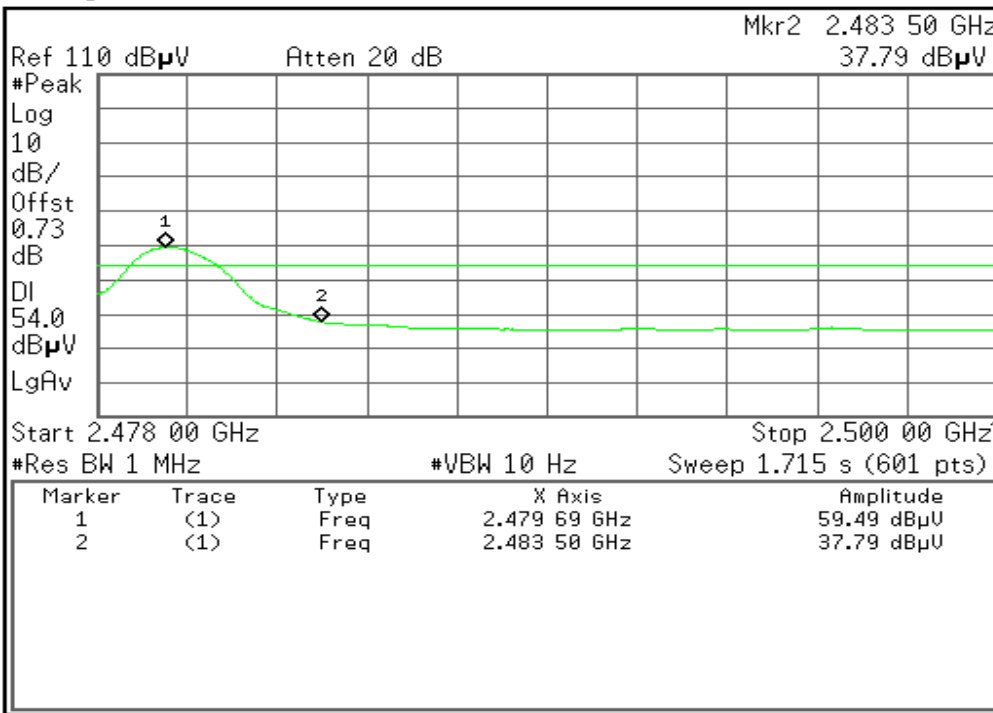

**Marker**

Select Marker  
1 2 3 4

Normal

Delta

Delta Pair  
(Tracking Ref)  
Ref  $\Delta$

Span Pair  
Span Center

Off

More  
1 of 2

Copyright 2000-2009 Agilent Technologies



**3M**

**CH LOW**

Freq. (MHz)	Ant. Pol H/V	Peak	AV	Ant. / CL	Actual Fs		Peak	AV	Peak	AV
		Reading (dBuV)	Reading (dBuV)	CF (dB)	Peak (dBuV/m)	AV (dBuV/m)	Limit (dBuV/m)	Limit (dBuV/m)	Margin (dB)	Margin (dB)
2390.00	V	46.58	34.71	0.73	47.31	35.44	74	54	-26.69	-18.56
2390.00	H	46.38	34.85	0.73	47.11	35.58	74	54	-26.89	-18.42

**CH HIGH**

Freq. (MHz)	Ant. Pol H/V	Peak	AV	Ant. / CL	Actual Fs		Peak	AV	Peak	AV
		Reading (dBuV)	Reading (dBuV)	CF (dB)	Peak (dBuV/m)	AV (dBuV/m)	Limit (dBuV/m)	Limit (dBuV/m)	Margin (dB)	Margin (dB)
2483.50	V	50.84	37.68	0.73	51.57	38.41	74	54	-22.43	-15.59
2483.50	H	55.82	41.97	0.73	56.55	42.70	74	54	-17.45	-11.30

Refer to attach spectrum analyzer data chart.



Band Edges (CH Low)

Detector mode: Peak

Polarity: Vertical

Agilent

R T

Marker

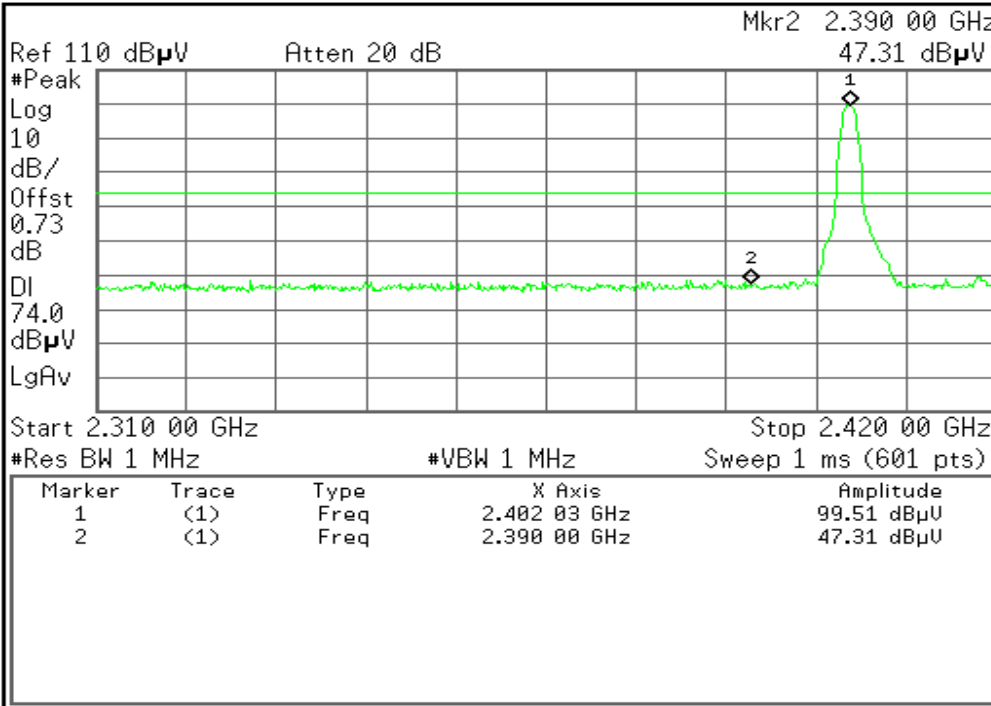

Select Marker  
1 2 3 4

Normal

Delta

Delta Pair  
(Tracking Ref)  
Ref  $\Delta$

Span Pair  
Span Center

Off

More  
1 of 2

Copyright 2000-2009 Agilent Technologies

Detector mode: Average

Polarity: Vertical

Agilent

R T

Marker

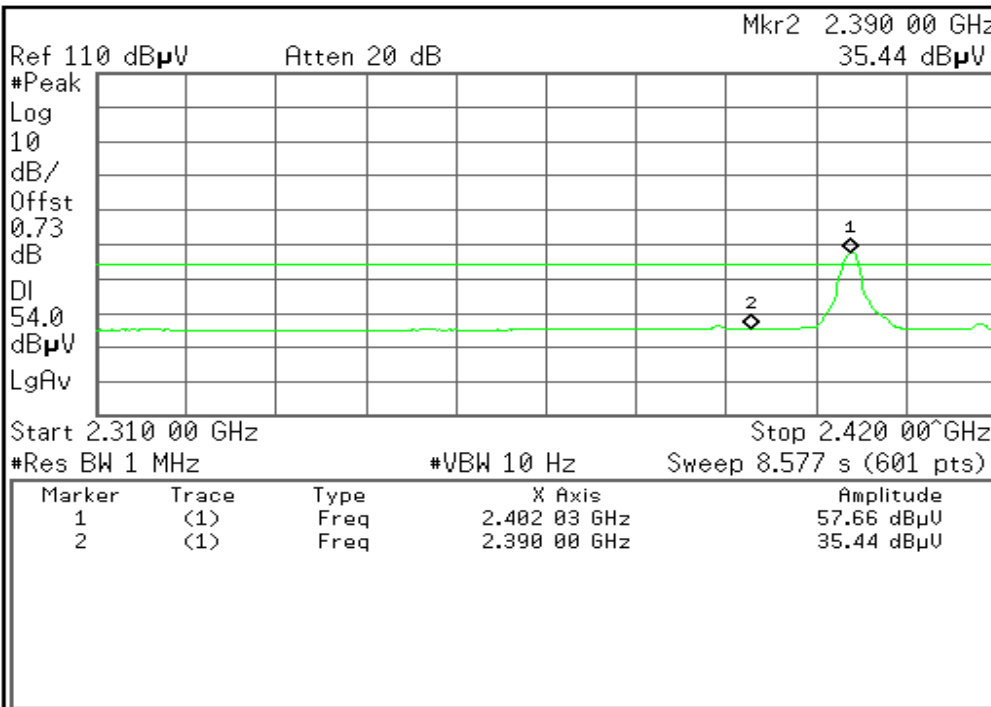

Select Marker  
1 2 3 4

Normal

Delta

Delta Pair  
(Tracking Ref)  
Ref  $\Delta$

Span Pair  
Span Center

Off

More  
1 of 2

Copyright 2000-2009 Agilent Technologies



Detector mode: Peak

Polarity: Horizontal

Agilent

R T

Marker

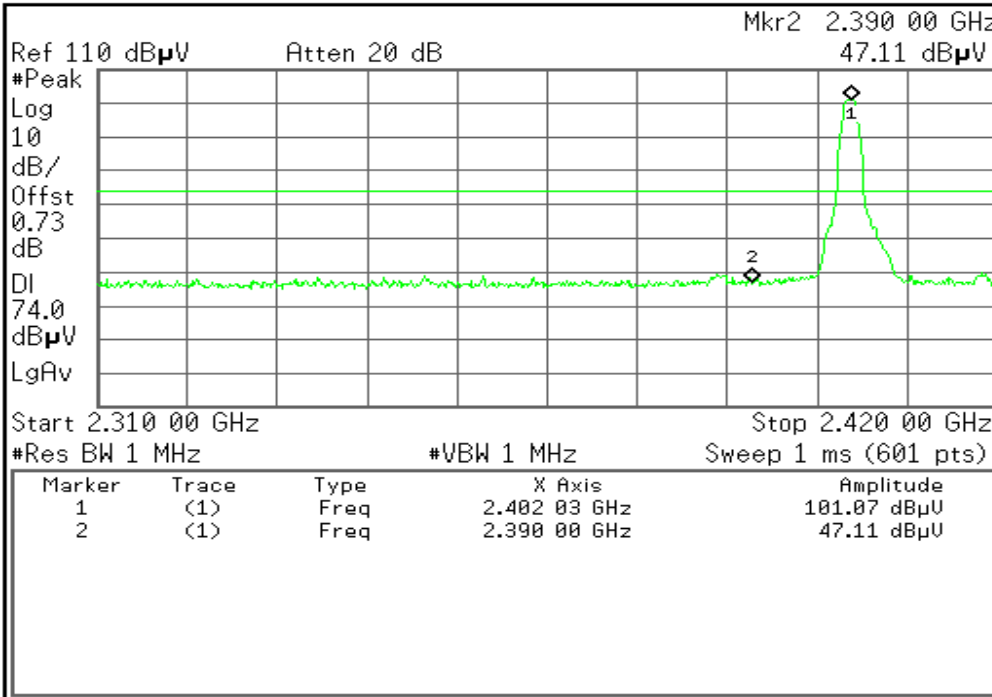

Select Marker  
1 2 3 4

Normal

Delta

Delta Pair  
(Tracking Ref)  
Ref ▲

Span Pair  
Span Center

Off

More  
1 of 2

Copyright 2000-2009 Agilent Technologies

Detector mode: Average

Polarity: Horizontal

Agilent

R T

Marker

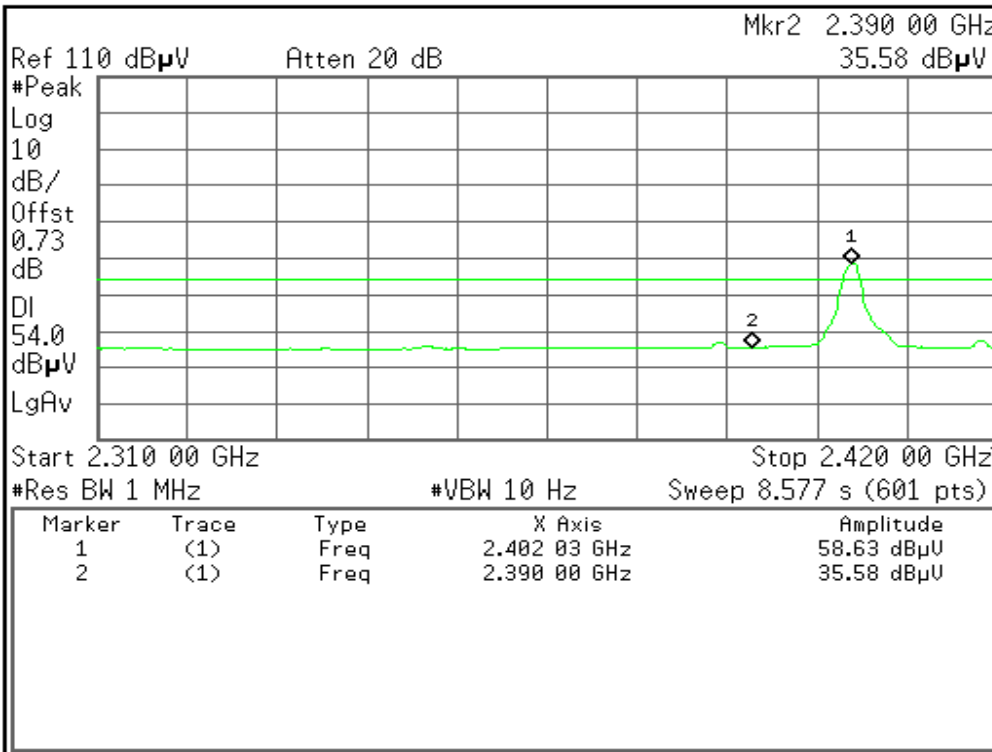

Select Marker  
1 2 3 4

Normal

Delta

Delta Pair  
(Tracking Ref)  
Ref ▲

Span Pair  
Span Center

Off

More  
1 of 2

Copyright 2000-2009 Agilent Technologies



Band Edges (CH High)

Detector mode: Peak

Polarity: Vertical

Agilent

R T

Marker

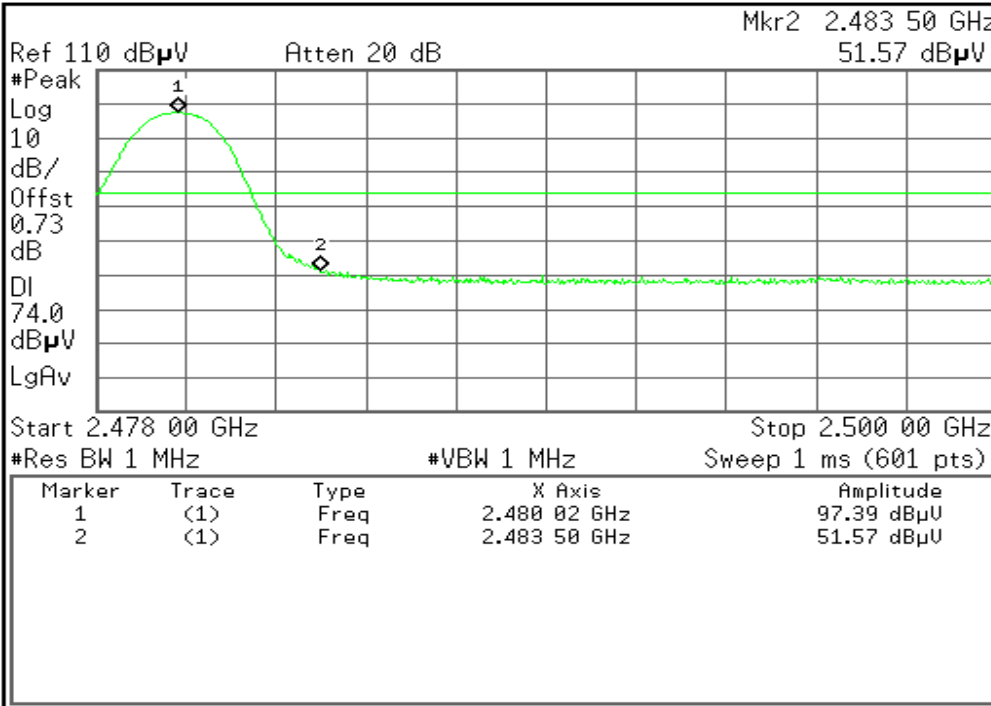

Select Marker  
1 2 3 4

Normal

Delta

Delta Pair  
(Tracking Ref)  
Ref  $\Delta$

Span Pair  
Span Center

Off

More  
1 of 2

Copyright 2000-2009 Agilent Technologies

Detector mode: Average

Polarity: Vertical

Agilent

R T

Marker

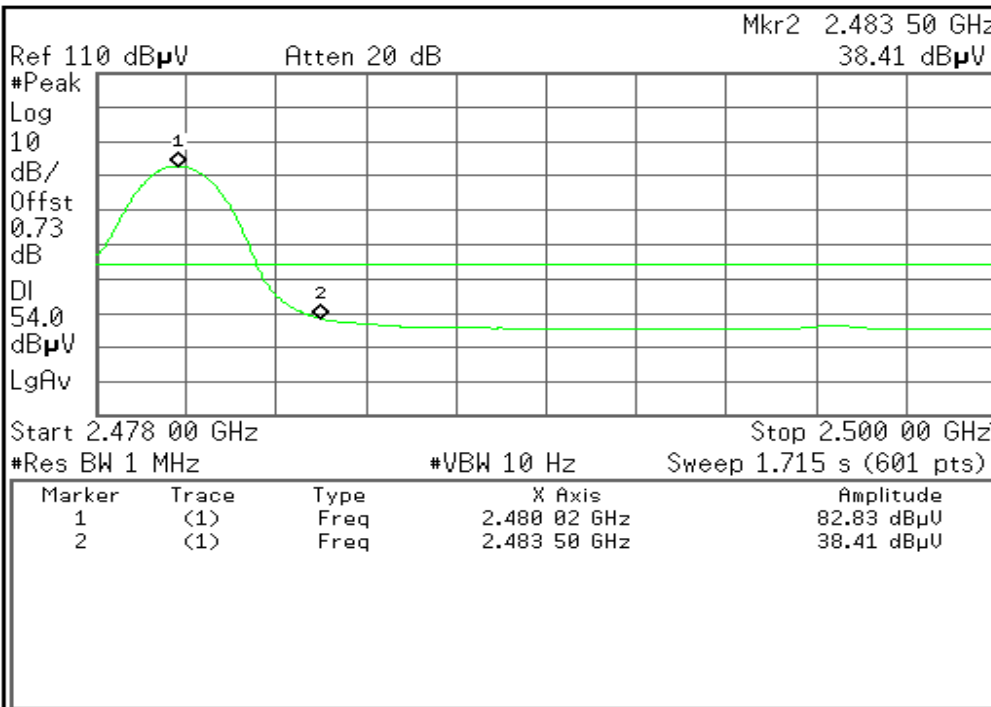

Select Marker  
1 2 3 4

Normal

Delta

Delta Pair  
(Tracking Ref)  
Ref  $\Delta$

Span Pair  
Span Center

Off

More  
1 of 2

Copyright 2000-2009 Agilent Technologies



Detector mode: Peak

Polarity: Horizontal

Agilent

R T

Marker

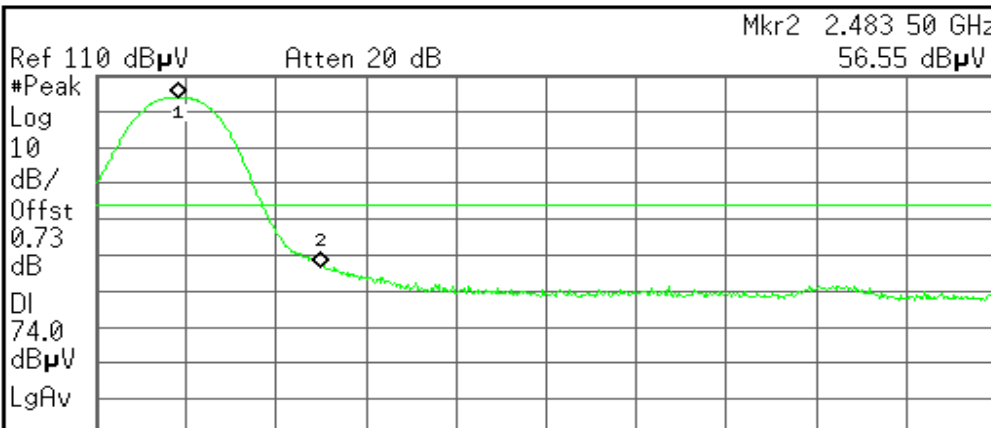

Start 2.478 00 GHz    Stop 2.500 00 GHz  
#Res BW 1 MHz    #VBW 1 MHz    Sweep 1 ms (601 pts)

Marker	Trace	Type	X Axis	Amplitude
1	(1)	Freq	2.480 02 GHz	103.94 dB $\mu$ V
2	(1)	Freq	2.483 50 GHz	56.55 dB $\mu$ V

Select Marker  
1 2 3 4

Normal

Delta

Delta Pair  
(Tracking Ref)  
Ref  $\Delta$

Span Pair  
Span Center

Off

More  
1 of 2

Copyright 2000-2009 Agilent Technologies

Detector mode: Average

Polarity: Horizontal

Agilent

R T

Marker

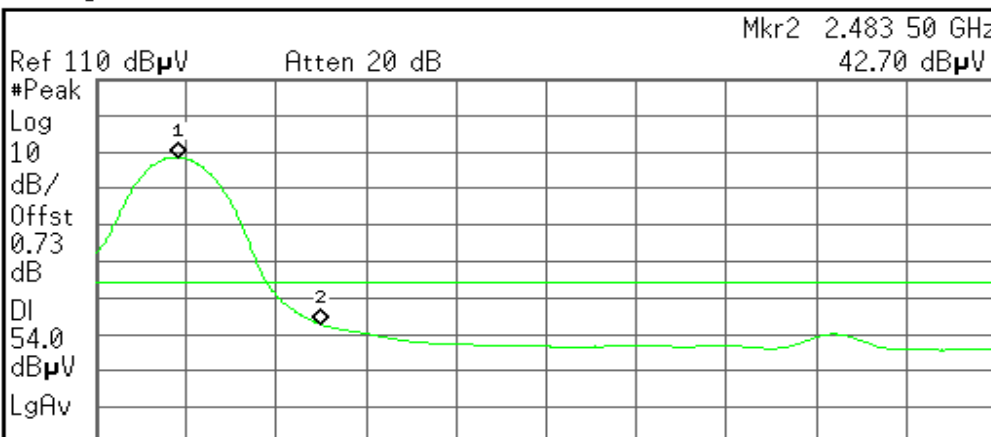

Start 2.478 00 GHz    Stop 2.500 00 GHz  
#Res BW 1 MHz    #VBW 10 Hz    Sweep 1.715 s (601 pts)

Marker	Trace	Type	X Axis	Amplitude
1	(1)	Freq	2.480 02 GHz	88.56 dB $\mu$ V
2	(1)	Freq	2.483 50 GHz	42.70 dB $\mu$ V

Select Marker  
1 2 3 4

Normal

Delta

Delta Pair  
(Tracking Ref)  
Ref  $\Delta$

Span Pair  
Span Center

Off

More  
1 of 2

Copyright 2000-2009 Agilent Technologies



### 7.3 FREQUENCY SEPARATION

#### LIMIT

According to §15.247(a)(1), Frequency hopping systems shall have hopping channel carrier frequencies separated by a minimum of 25 kHz or the 20 dB bandwidth of the hopping channel, whichever is greater. Alternatively, frequency hopping systems operating in the 2400-2483.5 MHz band may have hopping channel carrier frequencies that are separated by 25 kHz or two-thirds of the 20 dB bandwidth of the hopping channel, whichever is greater, provided the systems operate with an output power no greater than 125 mW.

#### Test Configuration

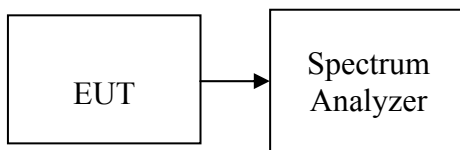

#### TEST PROCEDURE

1. Place the EUT on the table and set it in transmitting mode.
2. Remove the antenna from the EUT and then connect a low loss RF cable from the antenna port to the spectrum analyzer.
3. Set center frequency of spectrum analyzer = middle of hopping channel.
4. Set the spectrum analyzer as RBW = 100kHz, VBW = 100kHz, Span = 3MHz, Sweep = auto.
5. Max hold, mark 2 peaks of hopping channel and record the 2 peaks frequency.

#### TEST RESULTS

*No non-compliance noted*

#### Test Data

1M

Channel Separation	20dB Bandwidth	Result
(MHz)	(kHz)	
1.000	919.788	Pass



**Test Plot**

**Measurement of Channel Separation**

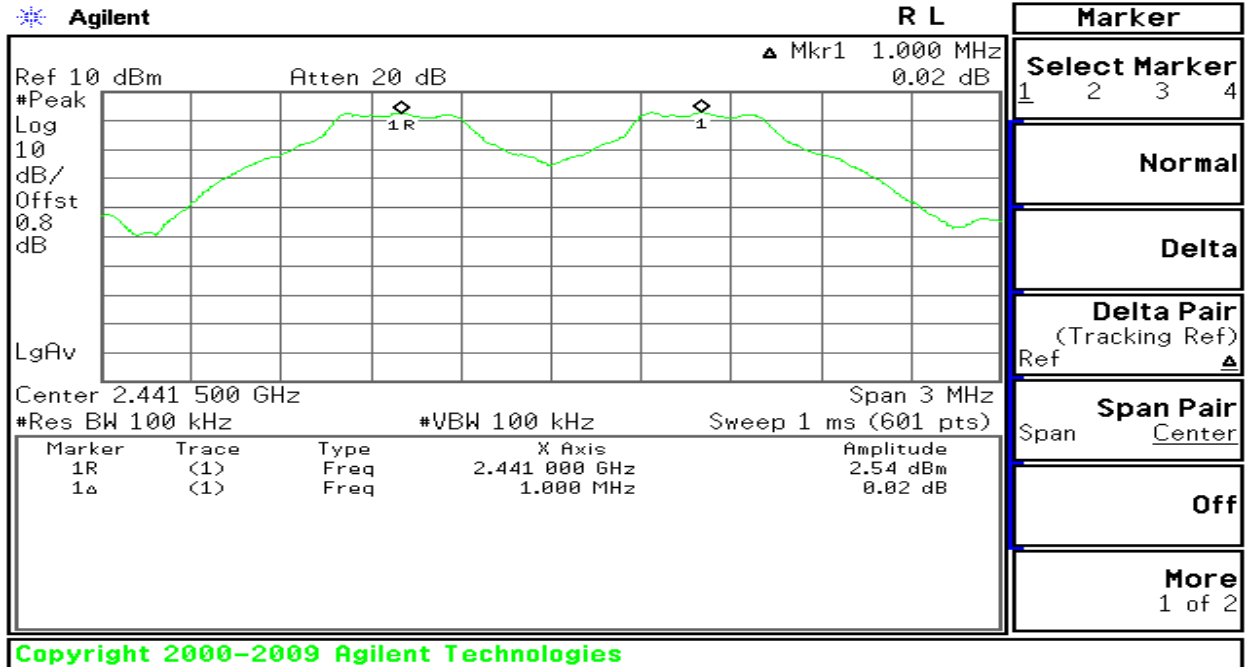

Copyright 2000-2009 Agilent Technologies

**Measurement of 20dB Bandwidth**

**LOW**

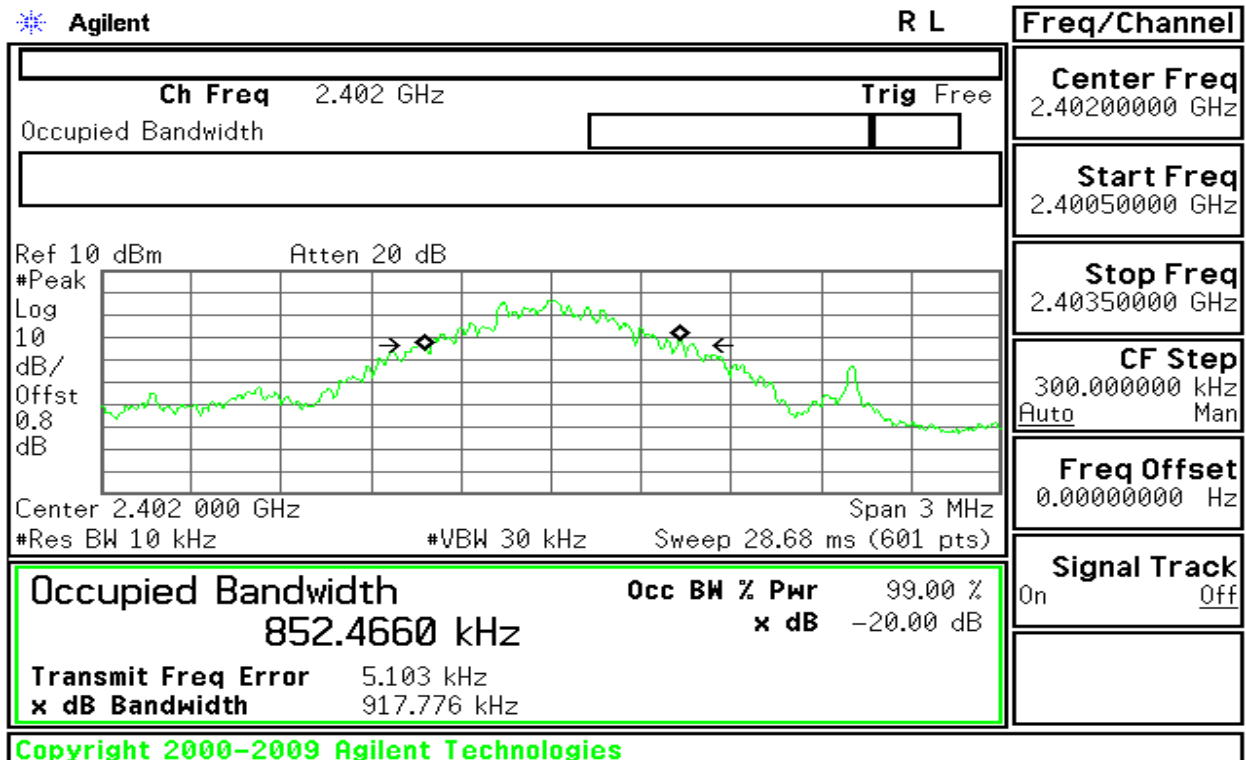

Copyright 2000-2009 Agilent Technologies



**MIDDLE:**

**Agilent** R T

<b>Ch Freq</b> 2.441 GHz	<b>Trig</b> Free	<b>Freq/Channel</b>
Occupied Bandwidth		<b>Center Freq</b> 2.44100000 GHz
		<b>Start Freq</b> 2.43950000 GHz
		<b>Stop Freq</b> 2.44250000 GHz
		<b>CF Step</b> 300.000000 kHz Auto Man
		<b>Freq Offset</b> 0.00000000 Hz
		<b>Signal Track</b> On Off

Ref 10 dBm      Atten 20 dB

#Peak

Log

10

dB/

Offst

0.8

dB

Center 2.441 000 GHz      Span 3 MHz

#Res BW 10 kHz      #VBW 30 kHz      Sweep 28.68 ms (601 pts)

<b>Occupied Bandwidth</b>	<b>Occ BW % Pwr</b> 99.00 %
856.5662 kHz	<b>x dB</b> -20.00 dB
<b>Transmit Freq Error</b> 875.413 Hz	
<b>x dB Bandwidth</b> 919.508 kHz	

Copyright 2000-2009 Agilent Technologies

**HIGH**

**Agilent** R L

<b>Ch Freq</b> 2.48 GHz	<b>Trig</b> Free	<b>Freq/Channel</b>
Occupied Bandwidth		<b>Center Freq</b> 2.48000000 GHz
		<b>Start Freq</b> 2.47850000 GHz
		<b>Stop Freq</b> 2.48150000 GHz
		<b>CF Step</b> 300.000000 kHz Auto Man
		<b>Freq Offset</b> 0.00000000 Hz
		<b>Signal Track</b> On Off

Ref 10 dBm      Atten 20 dB

#Peak

Log

10

dB/

Offst

0.8

dB

Center 2.480 000 GHz      Span 3 MHz

#Res BW 10 kHz      #VBW 30 kHz      Sweep 28.68 ms (601 pts)

<b>Occupied Bandwidth</b>	<b>Occ BW % Pwr</b> 99.00 %
855.8623 kHz	<b>x dB</b> -20.00 dB
<b>Transmit Freq Error</b> 483.218 Hz	
<b>x dB Bandwidth</b> 919.788 kHz	

Copyright 2000-2009 Agilent Technologies



3M

Channel Separation	20dB Bandwith	two-thirds of the 20 dB bandwidth	Result
(MHz)	(kHz)	(kHz)	
1.000	1285.00	856.67	Pass

Test Plot

Measurement of Channel Separation

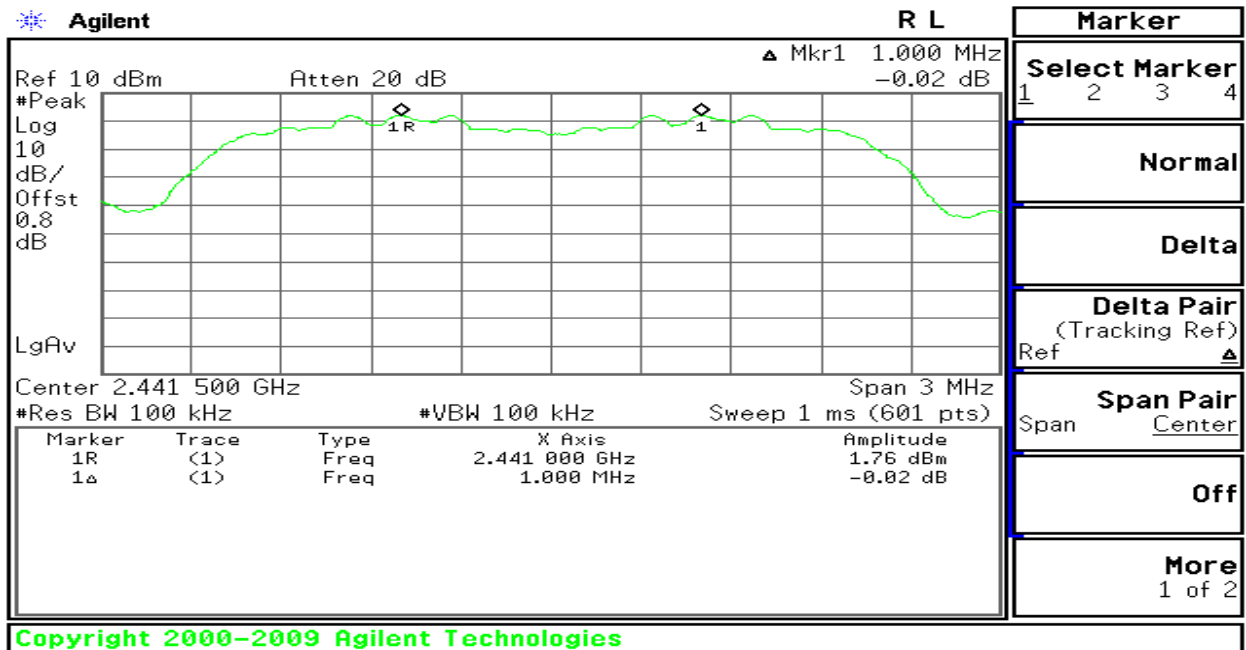



### Measurement of 20dB Bandwidth

#### LOW

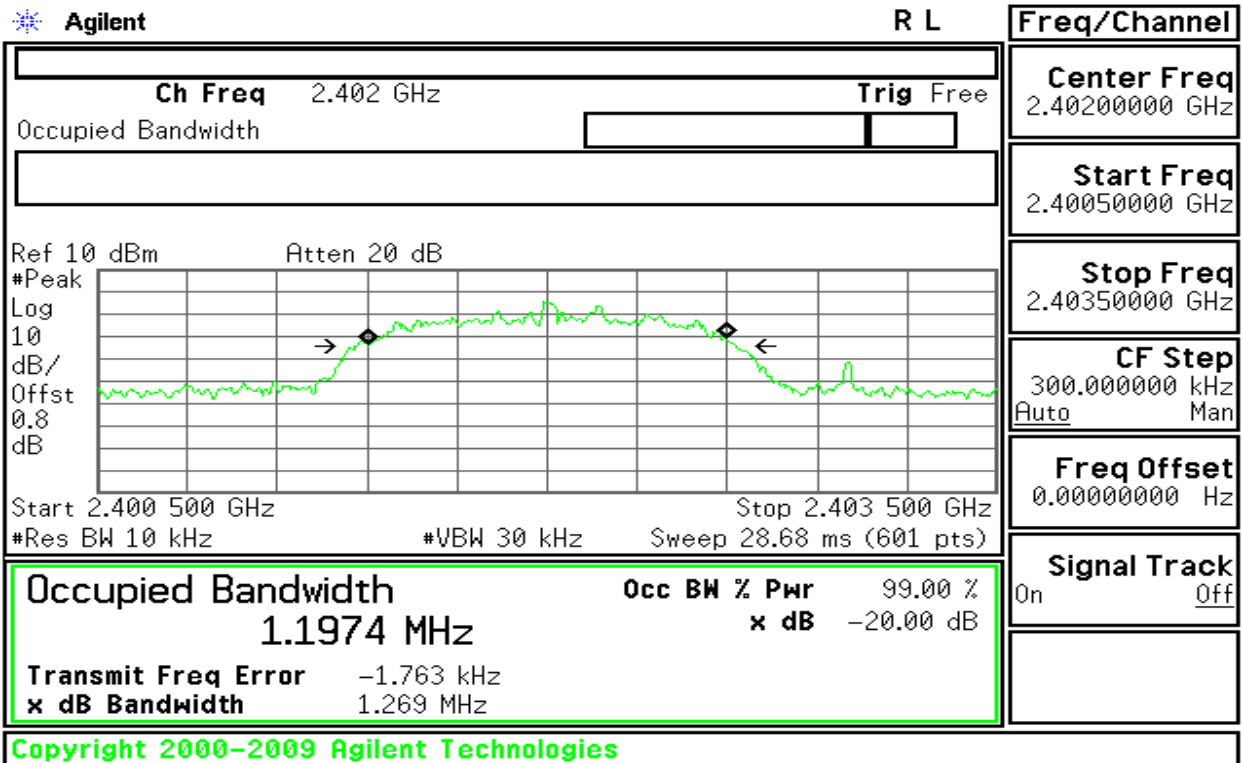

#### MIDDLE:

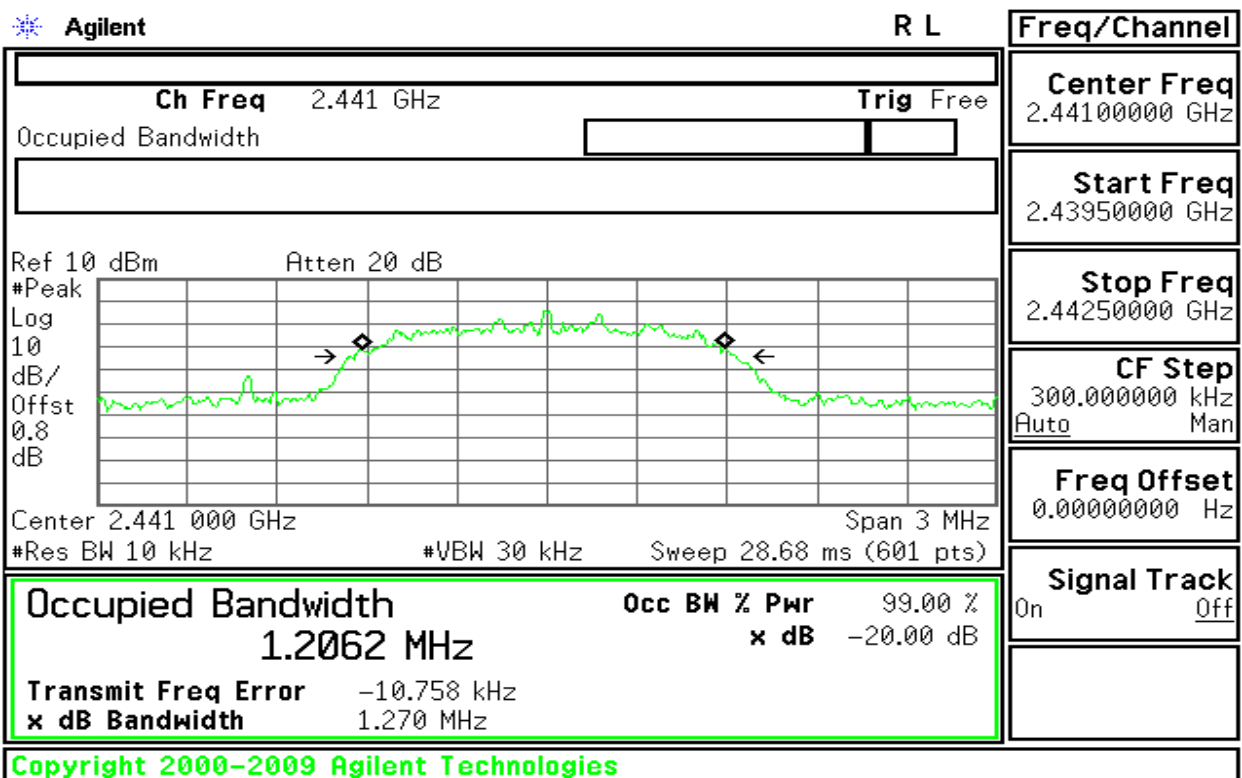



**HIGH**

Agilent

R L

Freq/Channel

<b>Ch Freq</b> 2.48 GHz	<b>Trig</b> Free
Occupied Bandwidth	

<b>Center Freq</b> 2.48000000 GHz
--------------------------------------

<b>Start Freq</b> 2.47850000 GHz
-------------------------------------

<b>Stop Freq</b> 2.48150000 GHz
------------------------------------

<b>CF Step</b> 300.000000 kHz Auto Man
--

<b>Freq Offset</b> 0.00000000 Hz
-------------------------------------

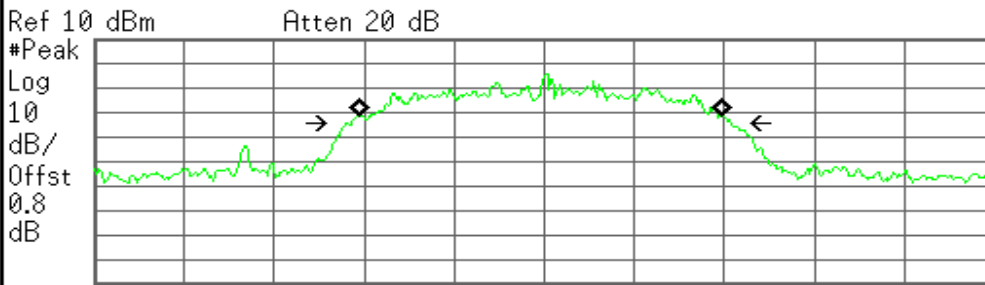

Center 2.480 000 GHz      Span 3 MHz

#Res BW 10 kHz      #VBW 30 kHz      Sweep 28.68 ms (601 pts)

<b>Signal Track</b> On Off
-------------------------------

<b>Occupied Bandwidth</b> 1.2051 MHz	<b>Occ BW % Pwr</b> 99.00 %
<b>Transmit Freq Error</b> -11.537 kHz	<b>x dB</b> -20.00 dB
<b>x dB Bandwidth</b> 1.285 MHz	

Copyright 2000-2009 Agilent Technologies



## 7.4 NUMBER OF HOPPING FREQUENCY

### LIMIT

According to §15.247(a)(1)(ii), Frequency hopping systems operating in the 2400MHz-2483.5 MHz bands shall use at least 75 hopping frequencies.

### Test Configuration

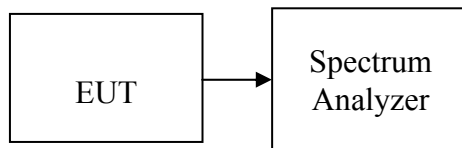

### TEST PROCEDURE

1. Place the EUT on the table and set it in transmitting mode.
2. Remove the antenna from the EUT and then connect a low loss RF cable from the antenna port to the spectrum analyzer.
3. Set spectrum analyzer Start=2400MHz, Stop = 2441.5MHz, Sweep = auto and Start=2441.5MHz, Stop = 2483.5MHz, Sweep = auto.
4. Set the spectrum analyzer as RBW, VBW=100kHz.
5. Max hold, view and count how many channel in the band.

### TEST RESULTS

*No non-compliance noted*

### Test Data

#### 1M

Result (No. of CH)	Limit (No. of CH)	Result
79	>75	PASS



**Test Plot**

**Channel Number**

**2.4 GHz – 2.4415 GHz**

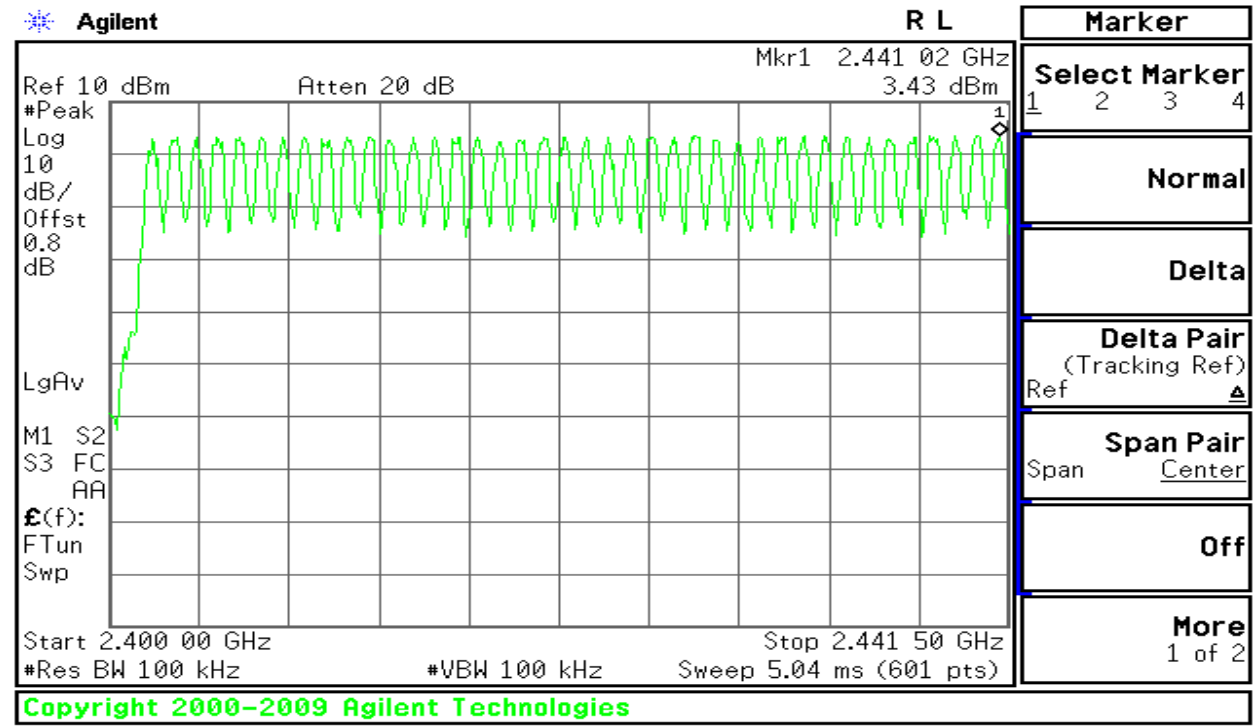

**2.4415 GHz – 2.4835 GHz**

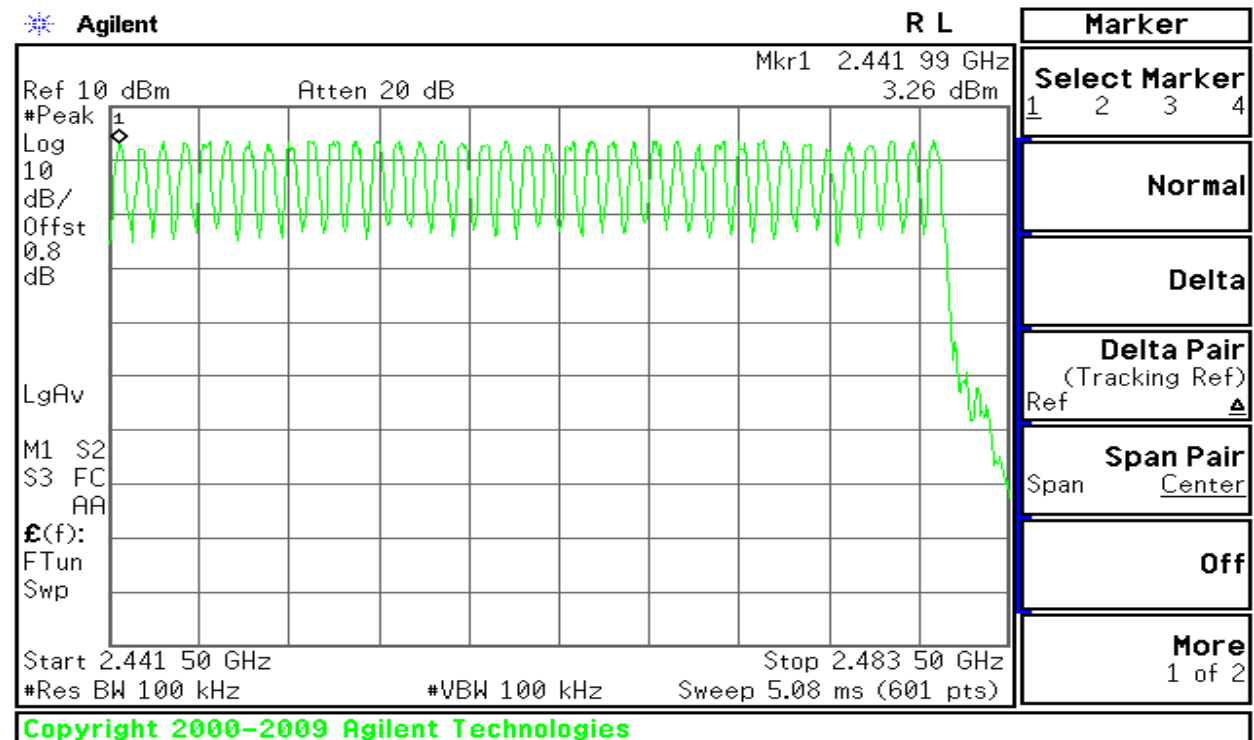





3M

Result (No. of CH)	Limit (No. of CH)	Result
79	>75	PASS

Test Plot

Channel Number

2.4 GHz – 2.4415 GHz

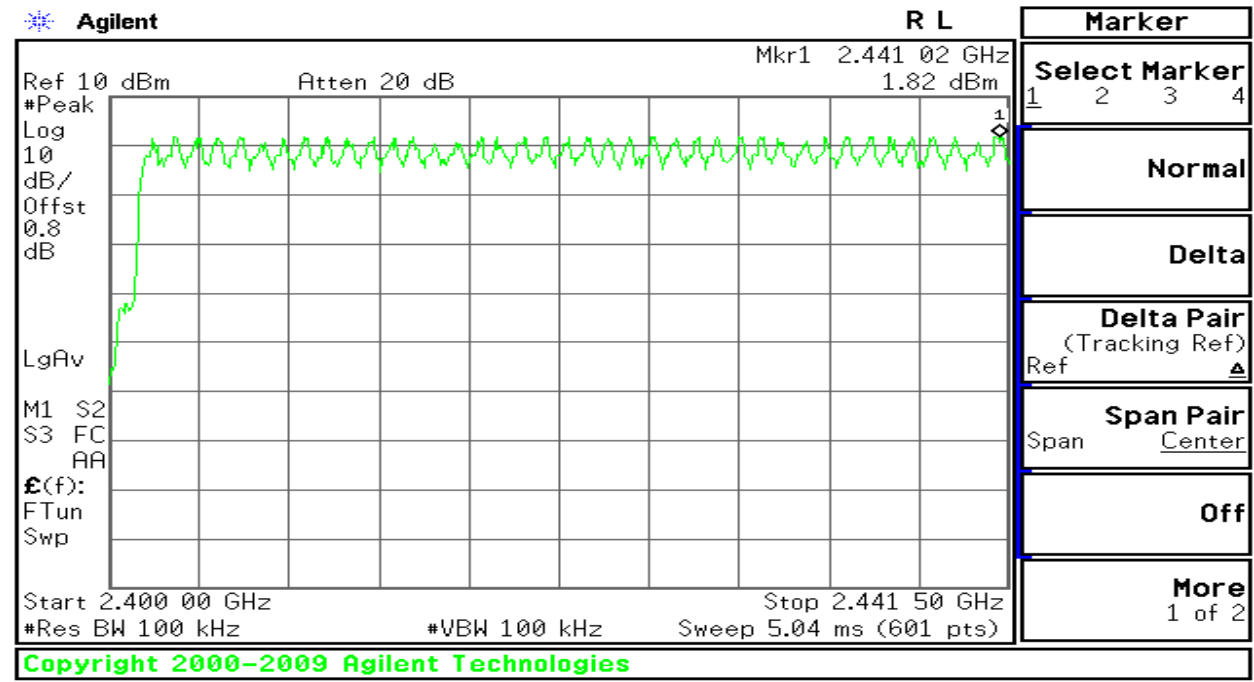

2.4415 GHz – 2.4835 GHz

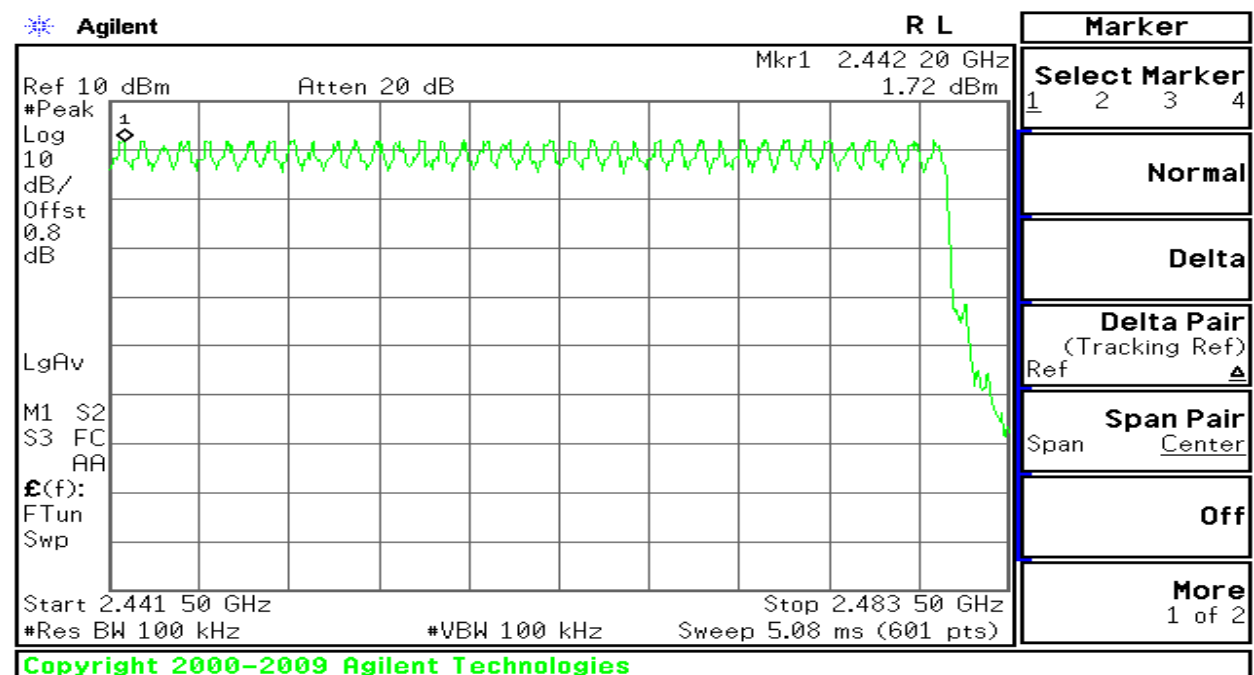



## 7.5 TIME OF OCCUPANCY (DWELL TIME)

### LIMIT

According to §15.247(a)(1)(iii), Frequency hopping systems operating in the 2400MHz-2483.5 MHz bands. The average time of occupancy on any channels shall not greater than 0.4 s within a period 0.4 s multiplied by the number of hopping channels employed.

### Test Configuration

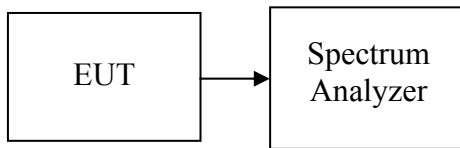

### TEST PROCEDURE

1. Place the EUT on the table and set it in transmitting mode.
2. Remove the antenna from the EUT and then connect a low loss RF cable from the antenna port to the spectrum analyzer.
3. Set center frequency of spectrum analyzer = operating frequency.
4. Set the spectrum analyzer as RBW, VBW=1MHz, Span = 0Hz, Sweep = auto.
5. Repeat above procedures until all frequency measured were complete.



**TEST RESULTS**

*No non-compliance noted*

**1M**

**Test Data**

**DH 1**

$0.393 * (1600/2)/79 * 31.6 = 125.76 \text{ (ms)}$

Pulse Time (ms)	Total of Dwell (ms)	Period Time (s)	Limit (ms)	Result
0.393	125.76	31.60	400.00	PASS

**DH 3**

$1.65 * (1600/4)/79 * 31.6 = 264.00 \text{ (ms)}$

Pulse Time (ms)	Total of Dwell (ms)	Period Time (s)	Limit (ms)	Result
1.65	264.00	31.60	400.00	PASS

**DH 5**

$2.907 * (1600/6)/79 * 31.6 = 319.77 \text{ (ms)}$

Pulse Time (ms)	Total of Dwell (ms)	Period Time (s)	Limit (ms)	Result
2.907	319.77	31.60	400.00	PASS



Test Plot

DH 1

Agilent

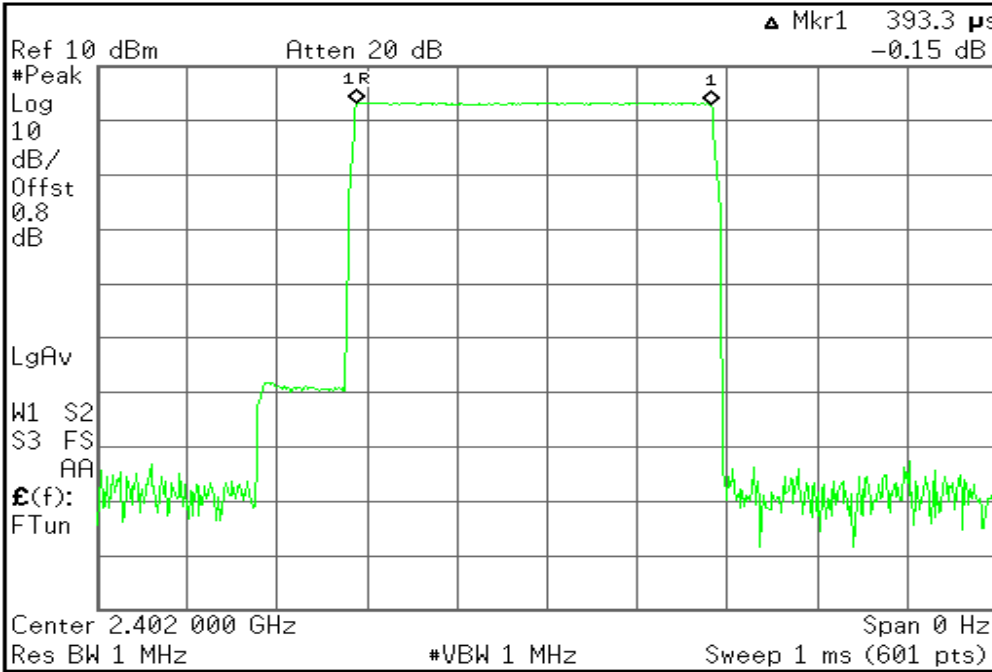

R L

Marker

Select Marker	1	2	3	4
---------------	---	---	---	---

Normal

Delta

Delta Pair (Tracking Ref) Ref ▲

Span Pair Span Center

Off

More 1 of 2

Copyright 2000-2009 Agilent Technologies

DH 3

Agilent

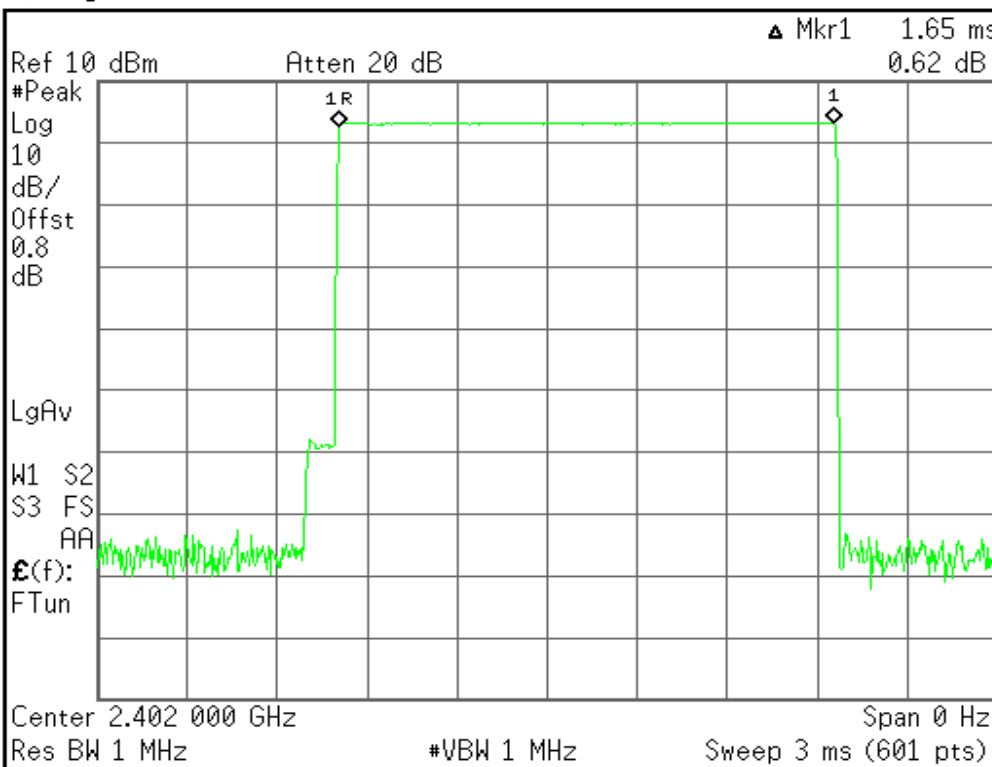

R L

Marker

Select Marker	1	2	3	4
---------------	---	---	---	---

Normal

Delta

Delta Pair (Tracking Ref) Ref ▲

Span Pair Span Center

Off

More 1 of 2

Copyright 2000-2009 Agilent Technologies



DH 5

Agilent

R L

Marker

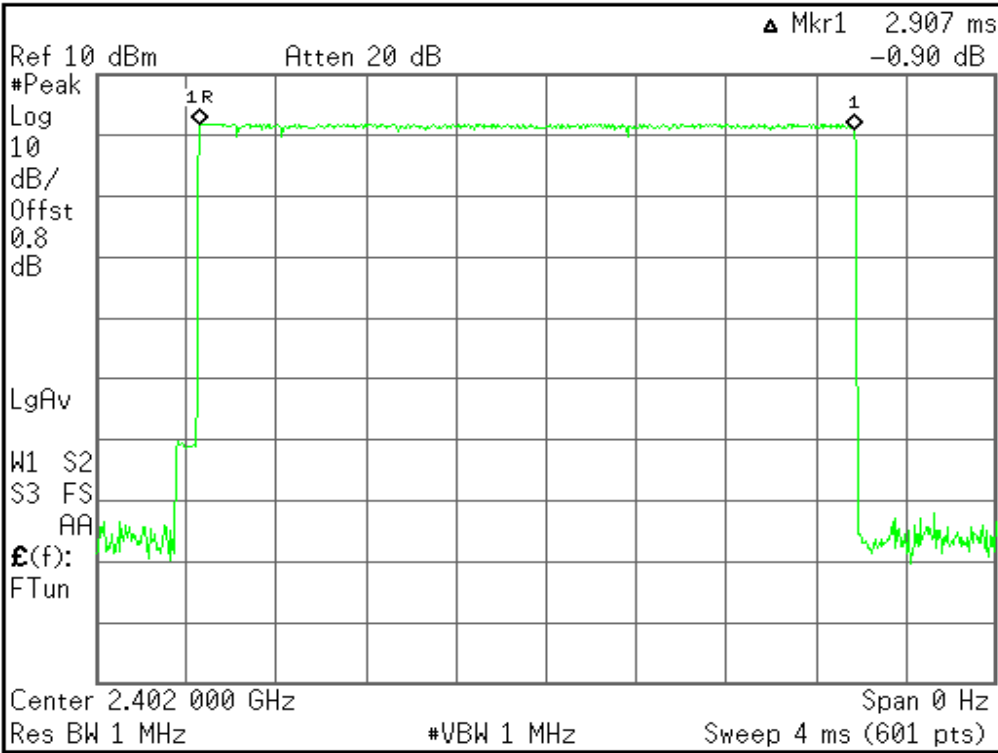

Select Marker			
1	2	3	4
Normal			
Delta			
Delta Pair (Tracking Ref)			
Ref	▲		
Span Pair			
Span	Center		
Off			
More			
1 of 2			

Copyright 2000-2009 Agilent Technologies



**3M**

**Test Data**

**DH 1**

$0.393 * (1600/2)/79 * 31.6 = 125.76 \text{ (ms)}$

<b>Pulse Time (ms)</b>	<b>Total of Dwell (ms)</b>	<b>Period Time (s)</b>	<b>Limit (ms)</b>	<b>Result</b>
0.393	125.76	31.60	400.00	PASS

**DH 3**

$1.65 * (1600/4)/79 * 31.6 = 264.00 \text{ (ms)}$

<b>Pulse Time (ms)</b>	<b>Total of Dwell (ms)</b>	<b>Period Time (s)</b>	<b>Limit (ms)</b>	<b>Result</b>
1.65	264.00	31.60	400.00	PASS

**DH 5**

$2.907 * (1600/6)/79 * 31.6 = 319.77 \text{ (ms)}$

<b>Pulse Time (ms)</b>	<b>Total of Dwell (ms)</b>	<b>Period Time (s)</b>	<b>Limit (ms)</b>	<b>Result</b>
2.907	319.77	31.60	400.00	PASS



### Test Plot

### DH 1

Agilent

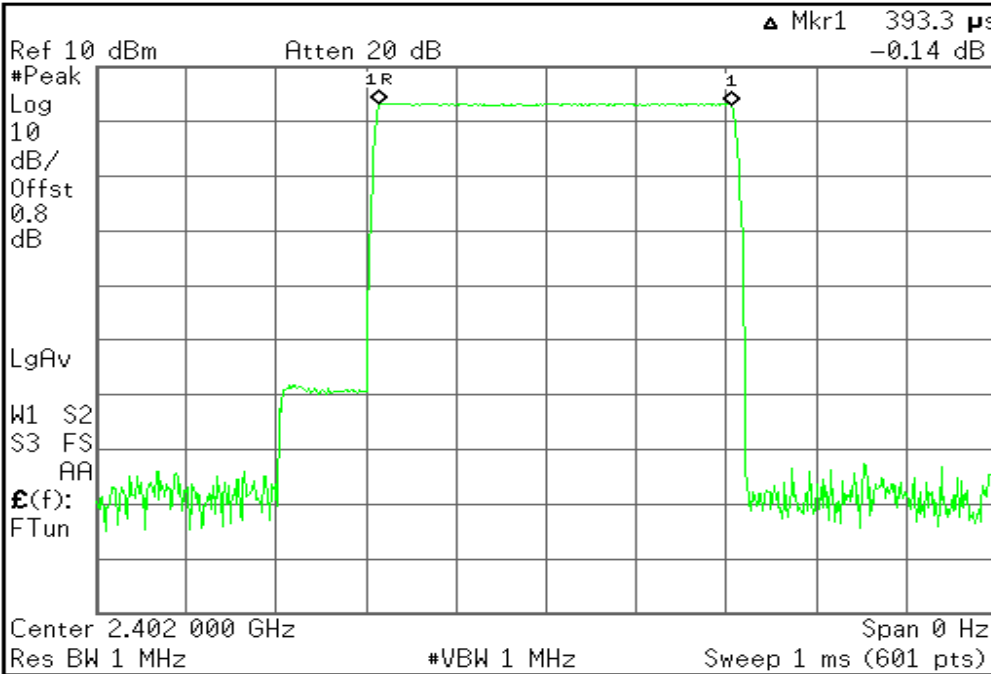

Marker				
Select Marker	1	2	3	4
Normal				
Delta				
Delta Pair (Tracking Ref)				$\Delta$
Span Pair	Span	Center		
Off				
More				1 of 2

Copyright 2000-2009 Agilent Technologies

### DH 3

Agilent

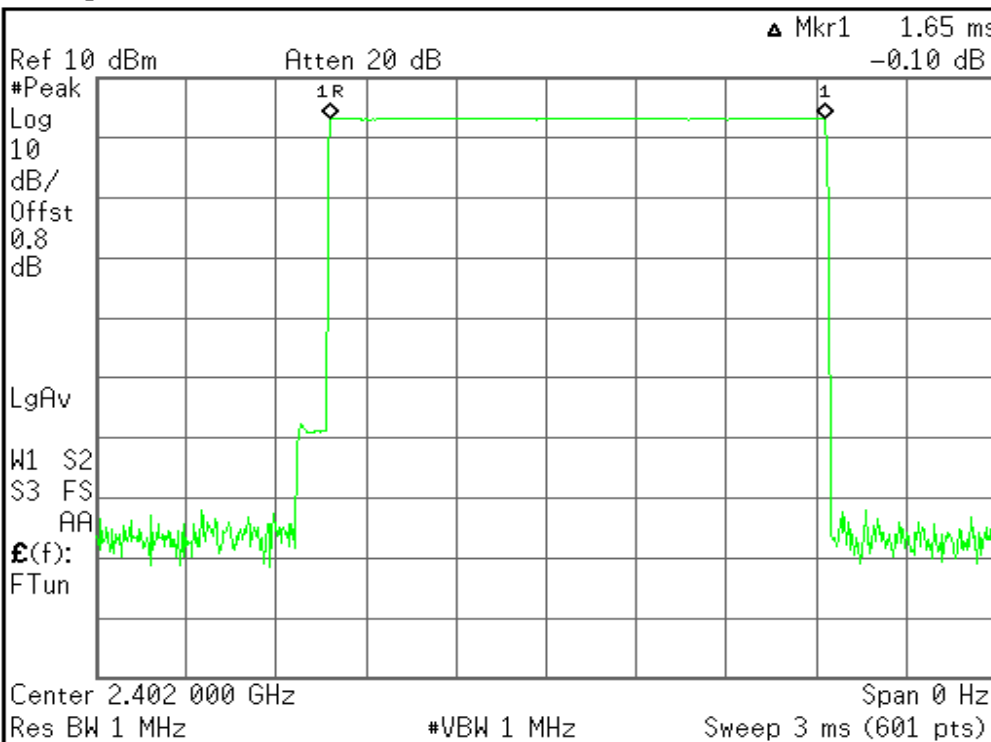

Marker				
Select Marker	1	2	3	4
Normal				
Delta				
Delta Pair (Tracking Ref)				$\Delta$
Span Pair	Span	Center		
Off				
More				1 of 2

Copyright 2000-2009 Agilent Technologies



DH 5

Agilent

R L

Marker			
Select Marker			
1	2	3	4
Normal			
Delta			
Delta Pair (Tracking Ref)			
Ref	▲		
Span Pair			
Span	Center		
Off			
More			
1 of 2			

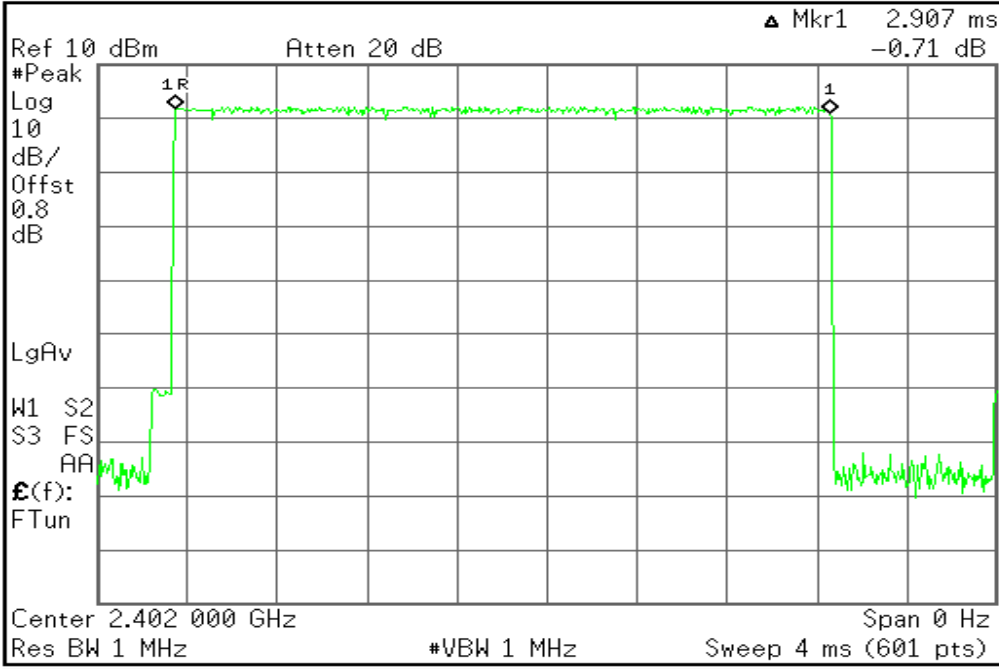

Copyright 2000-2009 Agilent Technologies





### 7.6 RADIO FREQUENCY EXPOSURE

#### LIMIT

Systems operating under the provisions of this section shall be operated in a manner that ensures that the public is not exposed to radio frequency energy levels in excess of the Commission's guidelines. See §15.247(b)(4) and §1.1307(b)(1) of this chapter.

#### EUT Specification

<b>EUT</b>	Bluetooth headset
<b>Frequency band (Operating)</b>	<input type="checkbox"/> WLAN: 2.412GHz ~ 2.462GHz <input type="checkbox"/> WLAN: 5.18GHz ~ 5.32GHz / 5.50GHz ~ 5.70GHz <input type="checkbox"/> WLAN: 5.745GHz ~ 5.825GHz <input checked="" type="checkbox"/> Others: <u>Bluetooth: 2.402GHz ~ 2.480GHz</u>
<b>Device category</b>	<input checked="" type="checkbox"/> Portable (<20cm separation) <input type="checkbox"/> Mobile (>20cm separation) <input type="checkbox"/> Others
<b>Exposure classification</b>	<input type="checkbox"/> Occupational/Controlled exposure ( $S = 5mW/cm^2$ ) <input checked="" type="checkbox"/> General Population/Uncontrolled exposure ( $S=1mW/cm^2$ )
<b>Antenna diversity</b>	<input checked="" type="checkbox"/> Single antenna <input type="checkbox"/> Multiple antennas <input type="checkbox"/> Tx diversity <input type="checkbox"/> Rx diversity <input type="checkbox"/> Tx/Rx diversity
<b>Max. output power</b>	2.61dBm (1.824)
<b>Antenna gain (Max)</b>	-0.25dBi (Numeric gain: 0.944)
<b>Evaluation applied</b>	<input type="checkbox"/> MPE Evaluation <input type="checkbox"/> SAR Evaluation <input checked="" type="checkbox"/> N/A

#### **Remark:**

1. The maximum output power is 2.61dBm (1.824mW) at 2480MHz (with 0.944numeric antenna gain.)
2. DTS device is not subject to routine RF evaluation; MPE estimate is used to justify the compliance.
3. For mobile or fixed location transmitters, no SAR consideration applied. The minimum separation generally be used is at least 20 cm, even if the calculations indicate that the MPE distance would be lesser.

#### TEST RESULTS

Non-compliance.



## 7.7 SPURIOUS EMISSIONS

### Conducted Measurement

#### LIMIT

In any 100 kHz bandwidth outside the frequency band in which the spread spectrum or digitally modulated intentional radiator is operating, the radio frequency power that is produced by the intentional radiator shall be at least 20 dB below that in the 100 kHz bandwidth within the band that contains the highest level of the desired power, based on either an RF conducted or a radiated measurement. Attenuation below the general limits specified in Section 15.209(a) is not required. In addition, radiated emissions which fall in the restricted bands, as defined in Section 15.205(a), must also comply with the radiated emission limits specified in Section 15.209(a) (see Section 15.205(c)).

#### Test Configuration

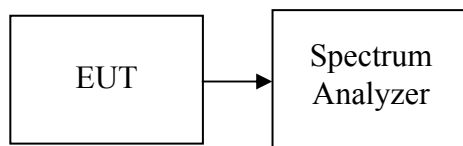

#### TEST PROCEDURE

Conducted RF measurements of the transmitter output were made to confirm that the EUT antenna port conducted emissions meet the specified limit and to identify any spurious signals that require further investigation or measurements on the radiated emissions site.

The transmitter output is connected to the spectrum analyzer. The resolution bandwidth is set to 100 KHz. The video bandwidth is set to 100 KHz.

Measurements are made over the 30MHz to 26GHz range with the transmitter set to the lowest, middle, and highest channels.

#### TEST RESULTS

*No non-compliance noted*



**Test Plot**

**1M**

**CH Low**

**30MHz ~ 2.9GHz**

Agilent

R L

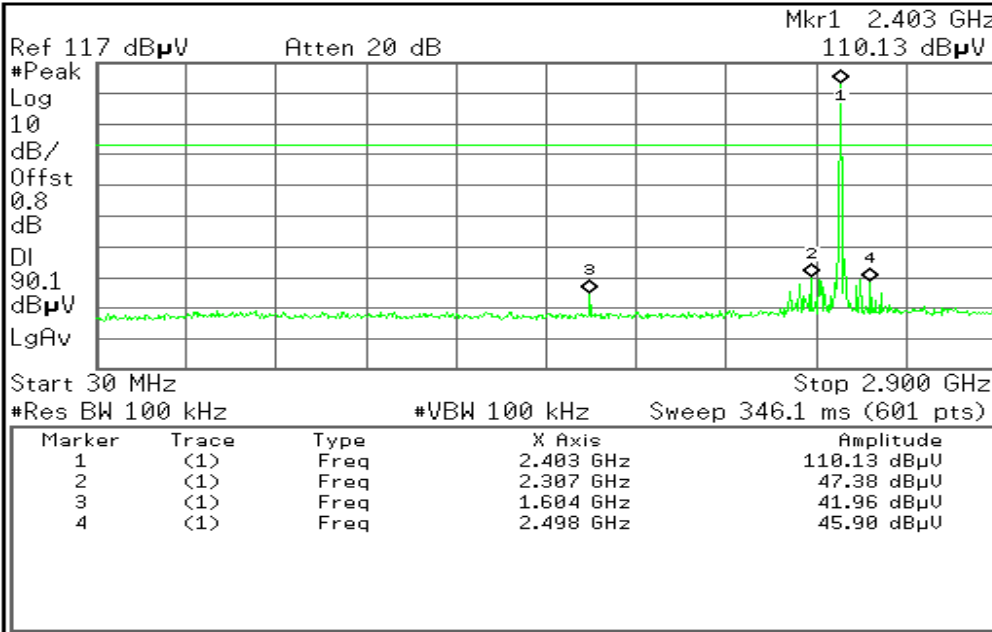

**Marker**

Select Marker 1 2 3 4

Normal

Delta

Delta Pair (Tracking Ref) Ref ▲

Span Pair Span Center

Off

More 1 of 2

Copyright 2000-2009 Agilent Technologies

**2.9GHz ~ 26.5GHz**

Agilent

R L

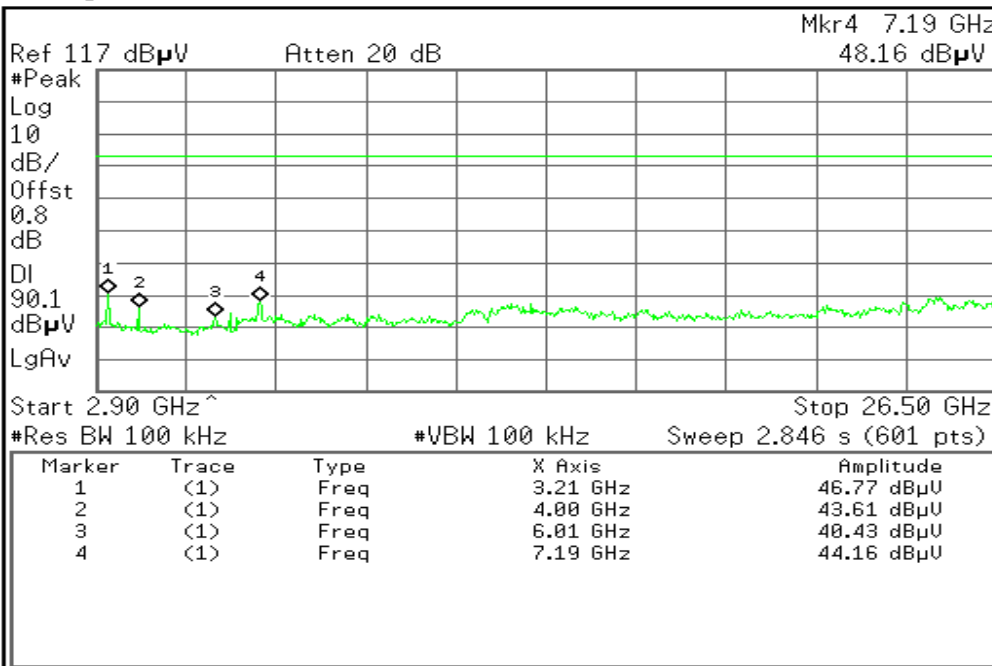

**Marker**

Select Marker 1 2 3 4

Normal

Delta

Delta Pair (Tracking Ref) Ref ▲

Span Pair Span Center

Off

More 1 of 2

Copyright 2000-2009 Agilent Technologies



**CH Mid**

**30MHz ~ 2.9GHz**

Agilent

R L

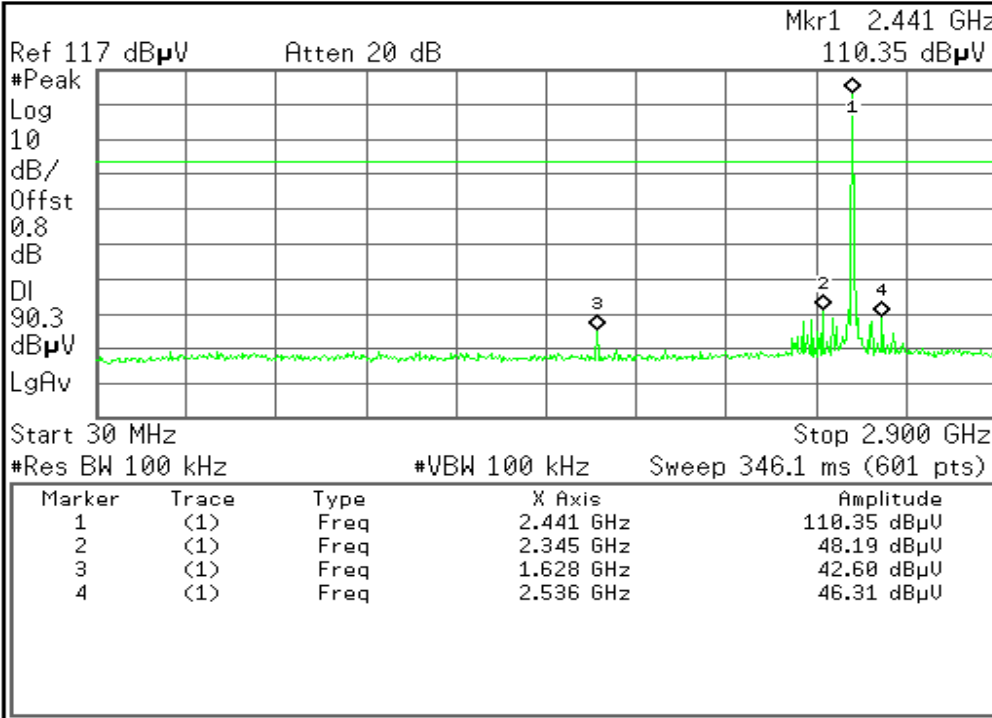

**Marker**

Select Marker  
1 2 3 4

Normal

Delta

Delta Pair  
(Tracking Ref)  
Ref ▲

Span Pair  
Span Center

Off

More  
1 of 2

Copyright 2000-2009 Agilent Technologies

**2.9GHz ~ 26.5GHz**

Agilent

R L

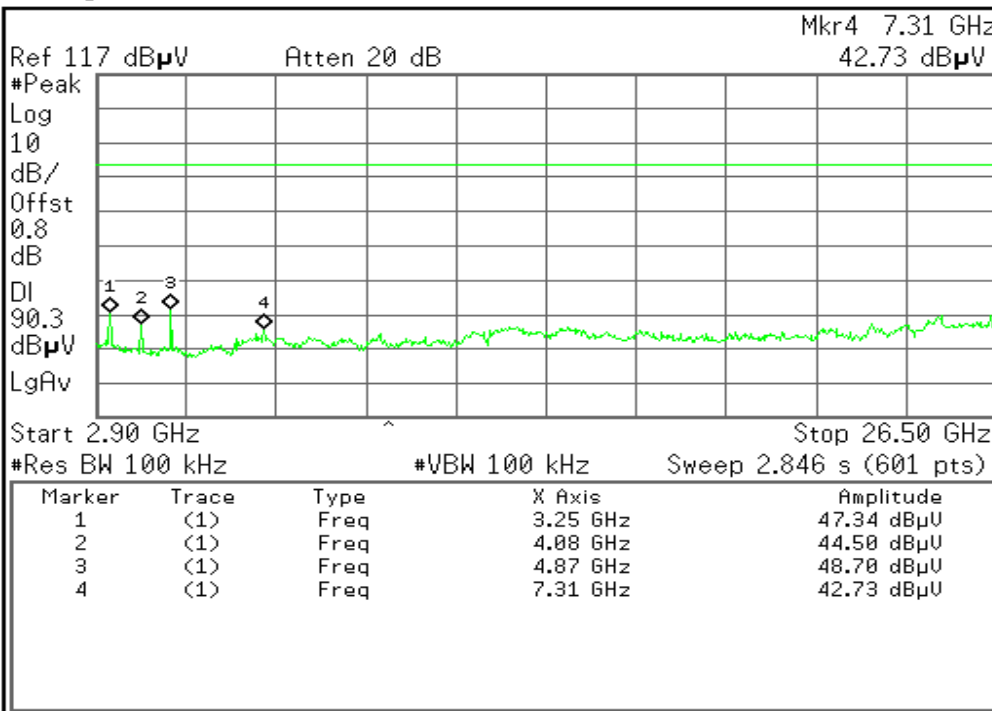

**Marker**

Select Marker  
1 2 3 4

Normal

Delta

Delta Pair  
(Tracking Ref)  
Ref ▲

Span Pair  
Span Center

Off

More  
1 of 2

Copyright 2000-2009 Agilent Technologies



**CH High**

**30MHz ~ 2.9GHz**

Agilent

R L

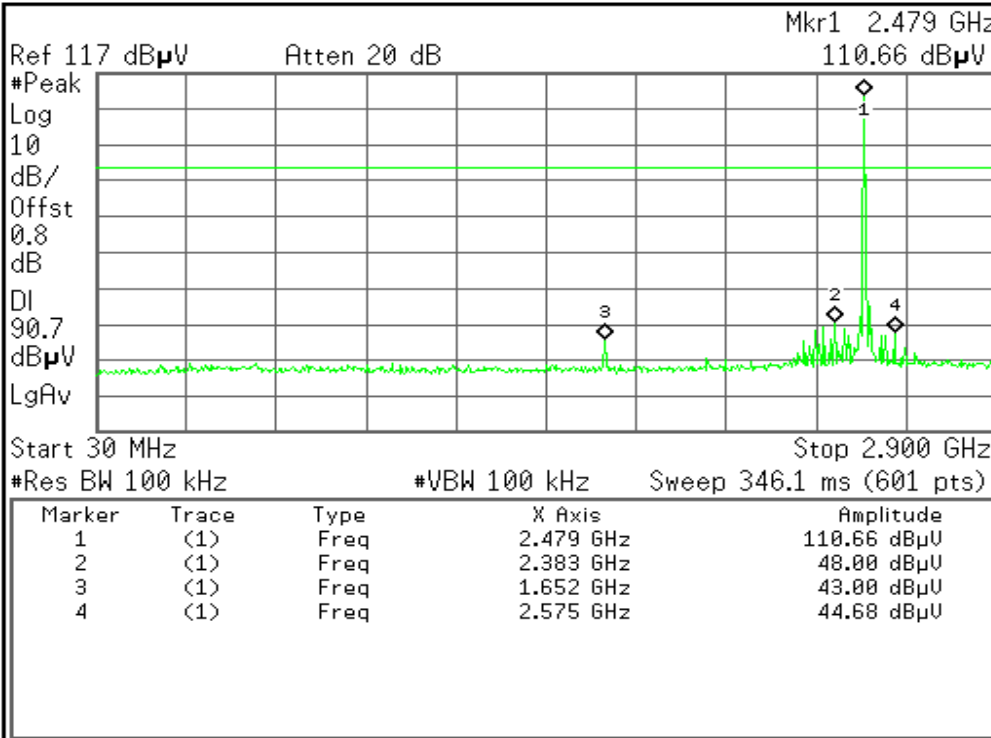

**Marker**

Select Marker 1 2 3 4

Normal

Delta

Delta Pair (Tracking Ref) Ref  $\Delta$

Span Pair Center

Off

More 1 of 2

Copyright 2000-2009 Agilent Technologies

**2.9GHz ~ 26.5GHz**

Agilent

R L

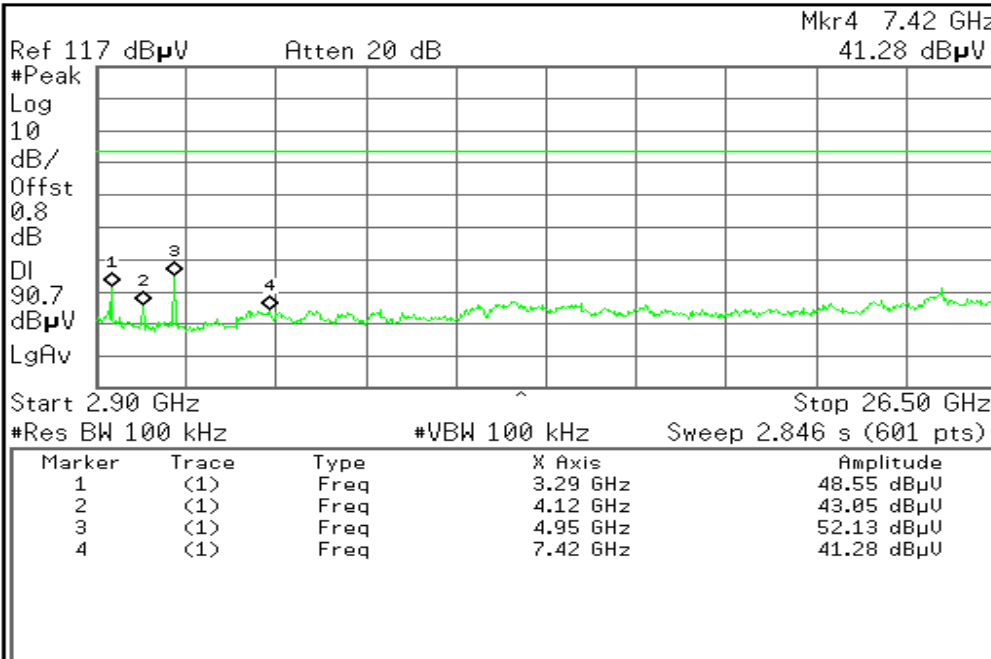

**Marker**

Select Marker 1 2 3 4

Normal

Delta

Delta Pair (Tracking Ref) Ref  $\Delta$

Span Pair Center

Off

More 1 of 2

Copyright 2000-2009 Agilent Technologies



**3M**

**CH Low**

**30MHz ~ 2.9GHz**

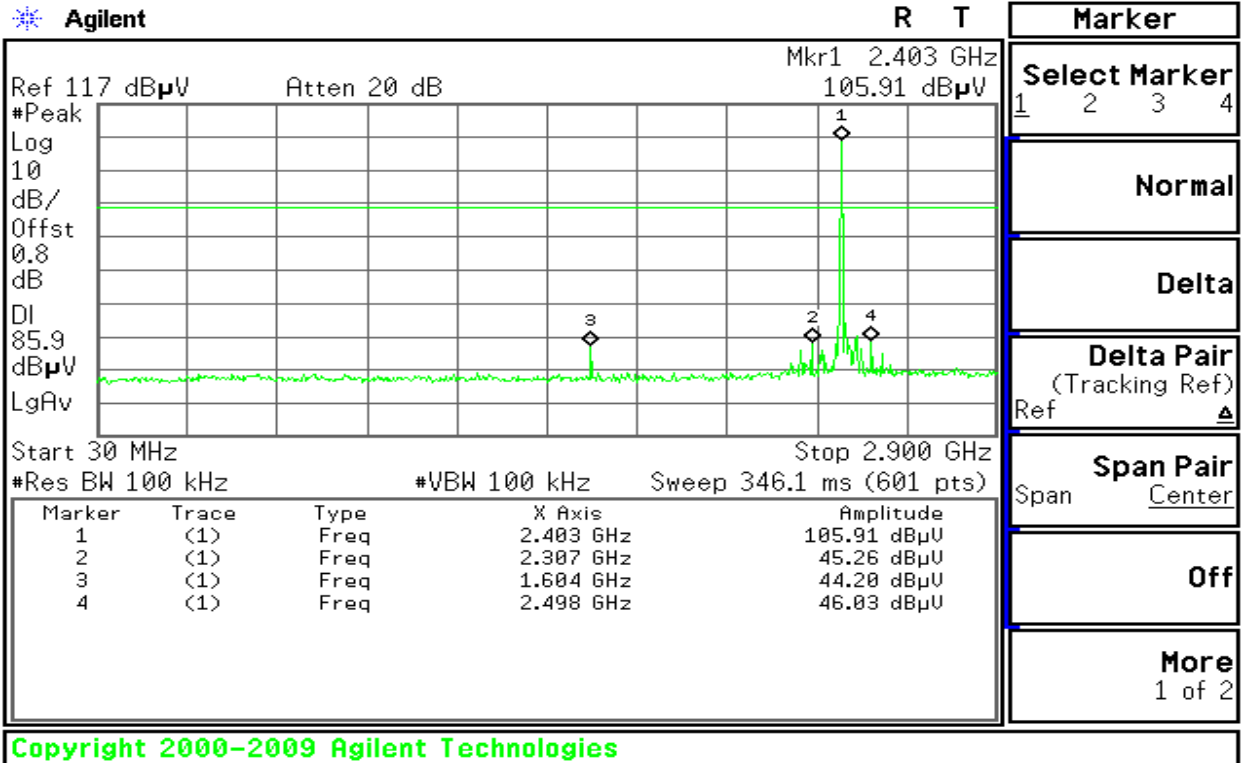

**2.9GHz ~ 26.5GHz**

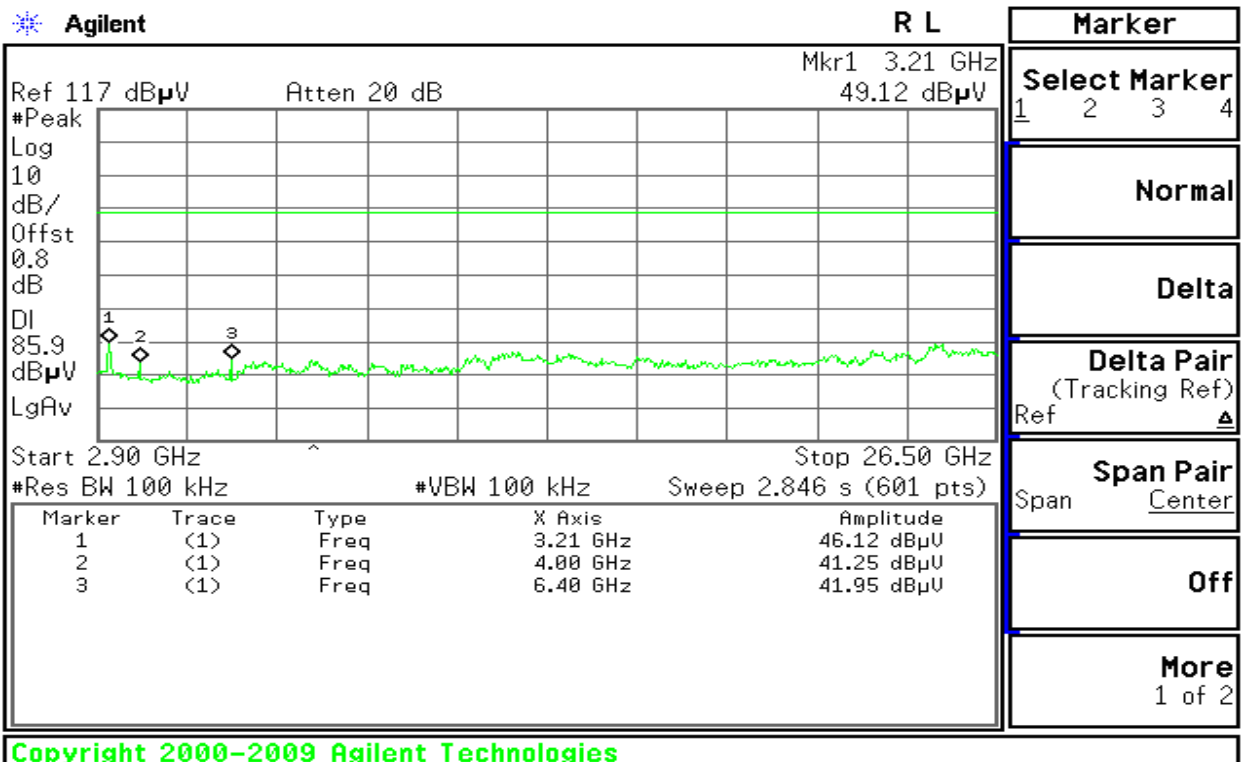



### CH Mid

### 30MHz ~ 2.9GHz

Agilent

R L

Marker

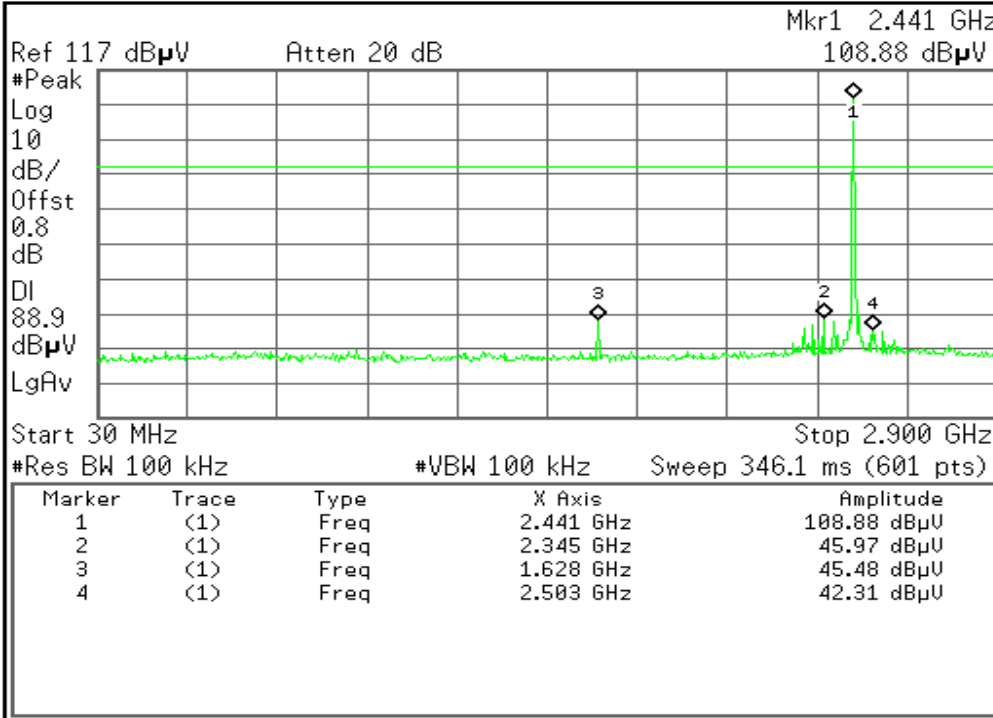

Select Marker  
1 2 3 4

Normal

Delta

Delta Pair  
(Tracking Ref)  
Ref ▲

Span Pair  
Span Center

Off

More  
1 of 2

Copyright 2000-2009 Agilent Technologies

### 2.9GHz ~ 26.5GHz

Agilent

R L

Marker

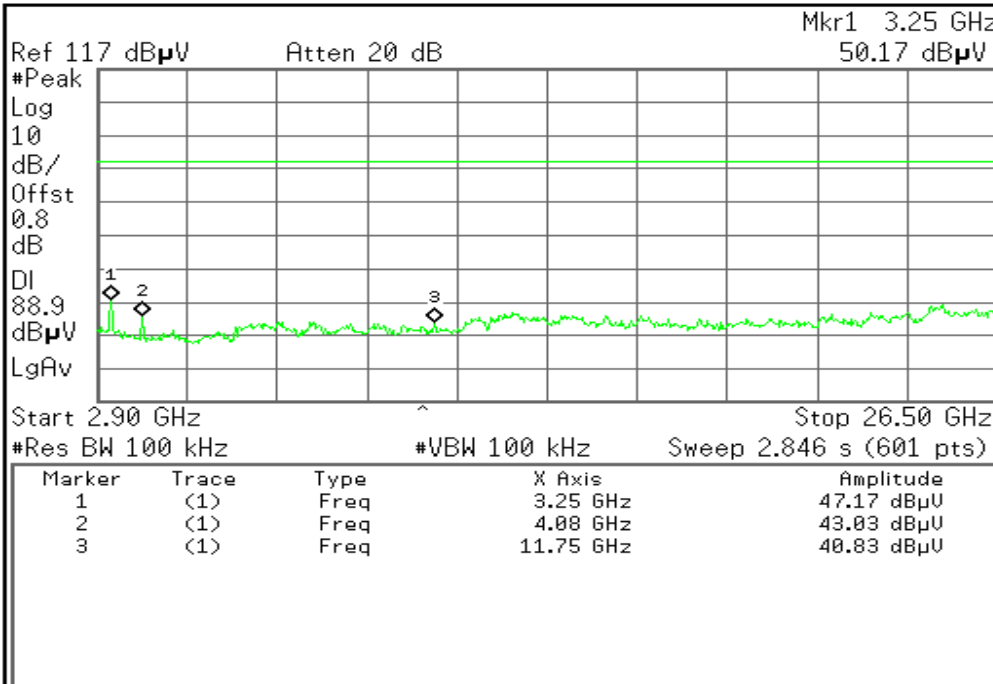

Select Marker  
1 2 3 4

Normal

Delta

Delta Pair  
(Tracking Ref)  
Ref ▲

Span Pair  
Span Center

Off

More  
1 of 2

Copyright 2000-2009 Agilent Technologies



**CH High**

**30MHz ~ 2.9GHz**

Agilent

R L

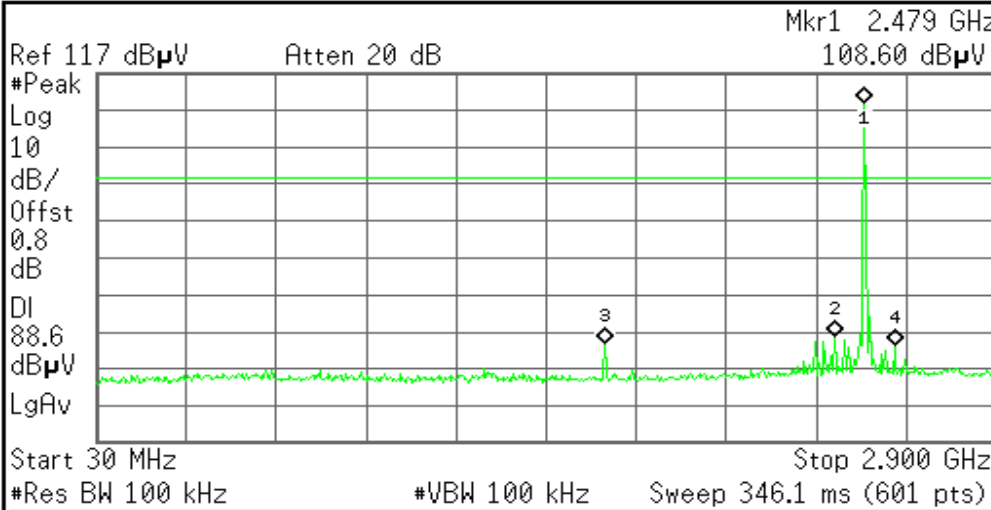

Marker	Trace	Type	X Axis	Amplitude
1	(1)	Freq	2.479 GHz	108.60 dBµU
2	(1)	Freq	2.383 GHz	45.73 dBµU
3	(1)	Freq	1.652 GHz	42.30 dBµU
4	(1)	Freq	2.575 GHz	43.50 dBµU

**Marker**

Select Marker  
1 2 3 4

Normal

Delta

Delta Pair  
(Tracking Ref)  
Ref ▲

Span Pair  
Span Center

Off

More  
1 of 2

Copyright 2000-2009 Agilent Technologies

**2.9GHz ~ 26.5GHz**

Agilent

R L

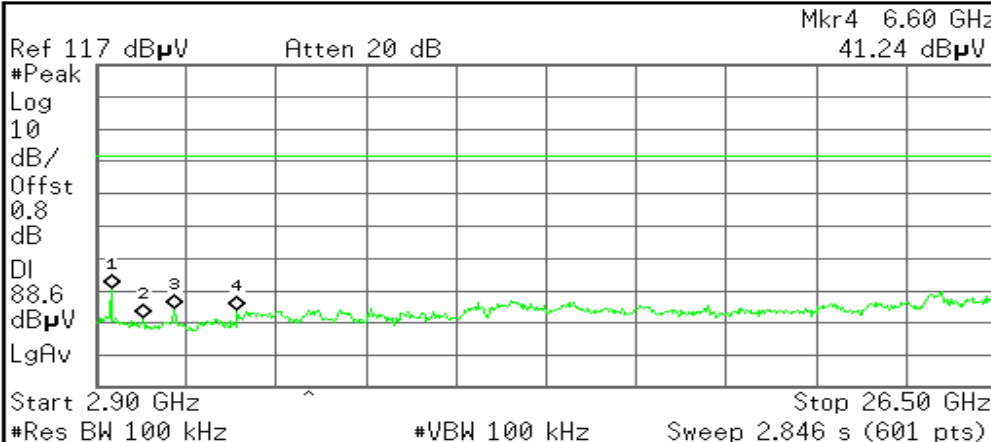

Marker	Trace	Type	X Axis	Amplitude
1	(1)	Freq	3.29 GHz	47.96 dBµU
2	(1)	Freq	4.12 GHz	38.46 dBµU
3	(1)	Freq	4.95 GHz	41.52 dBµU
4	(1)	Freq	6.60 GHz	41.24 dBµU

**Marker**

Select Marker  
1 2 3 4

Normal

Delta

Delta Pair  
(Tracking Ref)  
Ref ▲

Span Pair  
Span Center

Off

More  
1 of 2

Copyright 2000-2009 Agilent Technologies





### 7.8 Radiated Emissions

#### LIMIT

1. Except as provided elsewhere in this Subpart, the emissions from an intentional radiator shall not exceed the field strength levels specified in the following table:

Frequency (MHz)	Field Strength (mV/m)	Measurement Distance (m)
30-88	100*	3
88-216	150*	3
216-960	200*	3
Above 960	500	3

*Remark: Except as provided in paragraph (g), fundamental emissions from intentional radiators operating under this Section shall not be located in the frequency bands 54-72 MHz, 76-88 MHz, 174-216 MHz or 470-806 MHz. However, operation within these frequency bands is permitted under other sections of this Part, e.g., Sections 15.231 and 15.241.*

2. In the above emission table, the tighter limit applies at the band edges.

Frequency (Hz)	Field Strength ( $\mu\text{V}/\text{m}$ at 3-meter)	Field Strength ( $\text{dB}\mu\text{V}/\text{m}$ at 3-meter)
30-88	100	40
88-216	150	43.5
216-960	200	46
Above 960	500	54

### Test Configuration

#### Below 30MHz

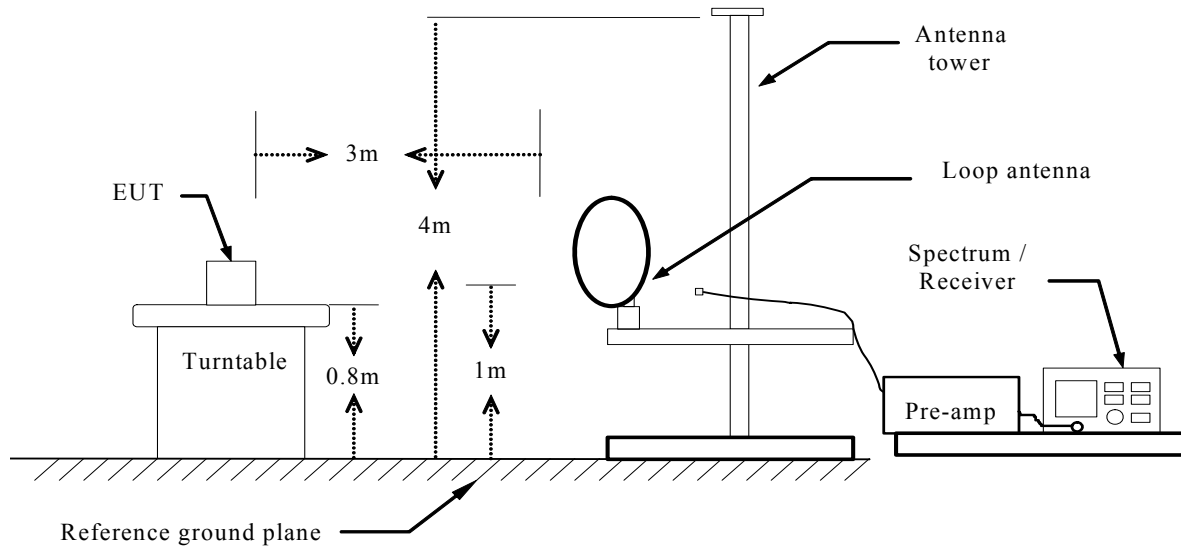

#### Below 1 GHz

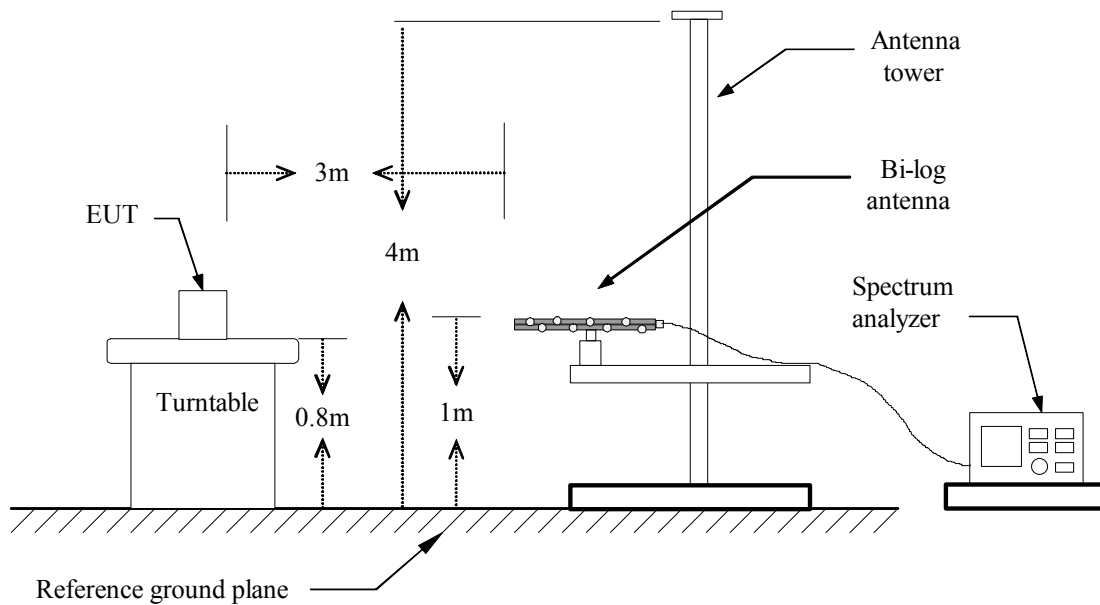

## Above 1 GHz

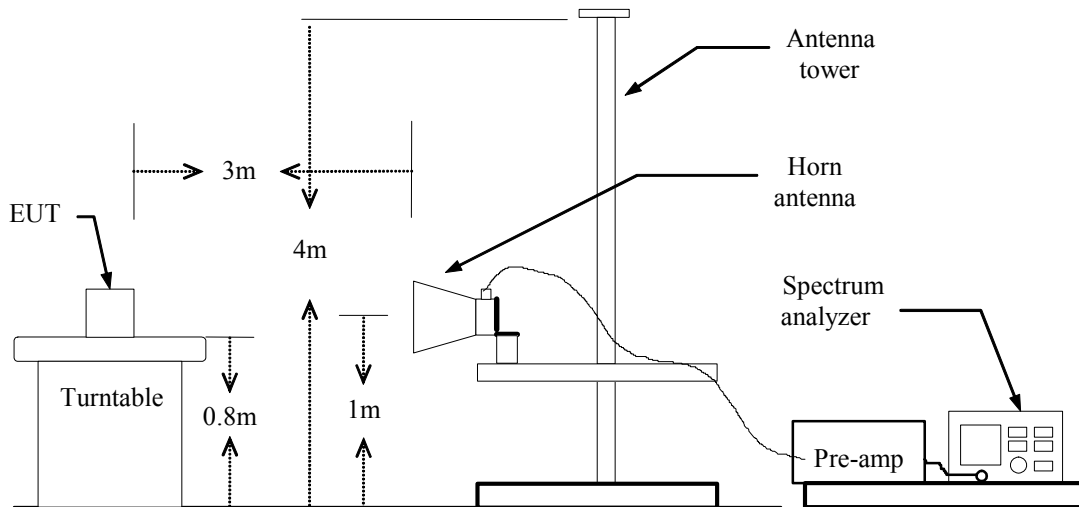

## TEST PROCEDURE

1. The EUT is placed on a turntable, which is 0.8m above ground plane.
2. The turntable shall be rotated for 360 degrees to determine the position of maximum emission level.
3. EUT is set 3m away from the receiving antenna, which is varied from 1m to 4m to find out the highest emissions.
4. Maximum procedure was performed on the six highest emissions to ensure EUT compliance.
5. And also, each emission was to be maximized by changing the polarization of receiving antenna both horizontal and vertical.
6. Set the spectrum analyzer in the following setting as:

Below 1GHz:

RBW=100kHz / VBW=300kHz / Sweep=AUTO

Above 1GHz:

(a) PEAK: RBW=VBW=1MHz / Sweep=AUTO

(b) AVERAGE: RBW=1MHz / VBW=10Hz / Sweep=AUTO

7. Repeat above procedures until the measurements for all frequencies are complete.



### TEST RESULTS

#### Below 1 GHz

Operation Mode: Normal Link

Test Date: March 5, 2010

Temperature: 24°C

Tested by: jeff

Humidity: 50 % RH

Polarity: Ver. / Hor.

Freq.	Ant.Pol.	Detector	Reading	Factor	Actual FS	Limit 3m	Safe Margin
(MHz)	H/V	Mode	(dBuV)	(dB)	(dBuV/m)	(dBuV/m)	(dB)
		(PK/QP)					
30.50	V	Peak	30.22	2.33	32.55	40.00	-7.45
120.90	V	Peak	28.36	-4.44	23.92	43.50	-19.48
530.66	V	Peak	28.64	2.35	30.99	46.00	-15.01
559.52	V	Peak	29.20	2.76	31.96	46.00	-14.04
747.79	V	Peak	27.17	5.75	32.92	46.00	-13.08
828.86	V	Peak	27.44	7.30	34.74	46.00	-11.26
31.08	H	Peak	25.12	1.95	27.07	40.00	-12.93
120.90	H	Peak	29.40	-4.44	24.96	43.50	-18.54
153.91	H	Peak	29.17	-5.11	24.06	43.50	-19.44
553.86	H	Peak	34.40	2.39	36.79	46.00	-9.21
574.95	H	Peak	32.69	2.98	35.67	46.00	-10.33
733.47	H	Peak	29.08	5.63	34.71	46.00	-11.29

Notes:

1. Measuring frequencies from 9 KHz to the 1GHz, No emission found between lowest internal used/generated frequency to 30 MHz.
2. Radiated emissions measured in frequency range from 9 KHz to 1000MHz were made with an instrument using Peak detector mode.
3. Data of measurement within this frequency range shown " --- " in the table above means the reading of emissions are attenuated more than 20dB below the permissible limits or the field strength is too small to be measured.
4. The IF bandwidth of SPA between 30MHz to 1GHz was 100kHz.



**Above 1 GHz**

**1M**

**Operation Mode:** TX/ CH Low

**Test Date:** March 5, 2010

**Temperature:** 24°C

**Tested by:** jeff

**Humidity:** 50 % RH

**Polarity:** Ver. / Hor.

Freq. (MHz)	Ant. Pol H/V	Peak Reading (dBuV)	AV Reading (dBuV)	Ant. / CL CF (dB)	Actual Fs		Peak Limit (dBuV/m)	AV Limit (dBuV/m)	Margin (dB)	Remark
					Peak	AV				
					(dBuV/m)	(dBuV/m)				
1603.33	V	41.36	30.11	0.78	42.14	30.89	74	54	-23.11	Avg
4800.00	V	40.85	29.35	12.35	53.20	41.70	74	54	-12.30	Avg
7222.34	V	29.48	20.59	19.41	48.89	40.00	74	54	-14.00	Avg
1603.33	H	42.86	32.16	0.78	43.64	32.94	74	54	-21.06	Avg
4800.00	H	45.31	33.08	12.35	57.66	45.43	74	54	-8.57	Avg
7223.66	H	33.76	23.69	19.41	53.17	43.10	74	54	-10.90	Avg

**Remark:**

1. Measuring frequencies from 1 GHz to the 10th harmonic of highest fundamental frequency.
2. Measurements above show only up to 6 maximum emissions noted, or would be lesser if no specific emissions from the EUT are recorded (ie: margin>20dB from the applicable limit) and considered that's already beyond the background noise floor.
3. Radiated emissions measured in frequency above 1000MHz were made with an instrument using Peak detector mode and average detector mode of the emission shown in Actual FS column.
4. Spectrum setting:
  - a. Peak Setting 1GHz to 10th harmonics of fundamental, RBW = 1MHz, VBW = 1MHz, Sweep time = Auto.
  - b. AV Setting 1GHz to 10th harmonics of fundamental, RBW = 1MHz, VBW = 10Hz, Sweep time = Auto.



Operation Mode: TX/ CH Mid

Test Date: March 5, 2010

Temperature: 24°C

Tested by: jeff

Humidity: 50 % RH

Polarity: Ver. / Hor.

Freq. (MHz)	Ant. Pol H/V	Peak Reading (dBuV)	AV Reading (dBuV)	Ant. / CL CF (dB)	Actual Fs		Peak Limit (dBuV/m)	AV Limit (dBuV/m)	Margin (dB)	Remark
					Peak	AV				
					(dBuV/m)	(dBuV/m)				
1626.67	V	40.65	29.23	0.87	41.52	30.10	74	54	-23.90	Avg
4884.67	V	42.33	30.45	12.42	54.75	42.87	74	54	-11.13	Avg
7320.34	V	35.82	24.77	19.35	55.17	44.12	74	54	-9.88	Avg
1626.67	H	41.69	30.47	0.87	42.56	31.34	74	54	-22.66	Avg
4884.67	H	40.52	28.76	12.42	52.94	41.18	74	54	-12.82	Avg
7321.66	H	34.65	23.80	19.35	54.00	43.15	74	54	-10.85	Avg

**Remark:**

1. Measuring frequencies from 1 GHz to the 10th harmonic of highest fundamental frequency.
2. Measurements above show only up to 6 maximum emissions noted, or would be lesser if no specific emissions from the EUT are recorded (ie: margin > 20dB from the applicable limit) and considered that's already beyond the background noise floor.
3. Radiated emissions measured in frequency above 1000MHz were made with an instrument using Peak detector mode and average detector mode of the emission shown in Actual FS column.
4. Spectrum setting:
  - a. Peak Setting 1GHz to 10th harmonics of fundamental, RBW = 1MHz, VBW = 1MHz, Sweep time = Auto.
  - b. AV Setting 1GHz to 10th harmonics of fundamental, RBW = 1MHz, VBW = 10Hz, Sweep time = Auto.



Operation Mode: TX/ CH High

Test Date: March 5, 2010

Temperature: 24°C

Tested by: jeff

Humidity: 50 % RH

Polarity: Ver. / Hor.

Freq. (MHz)	Ant. Pol H/V	Peak	AV	Ant. / CL	Actual Fs		Peak	AV	Margin	Remark
		Reading	Reading	CF	Peak	AV	Limit	Limit	(dB)	
		(dBuV)	(dBuV)	(dB)						
1653.33	V	41.42	28.76	1.01	42.43	29.77	74	54	-24.23	Avg
4959.32	V	40.33	26.34	12.50	52.83	38.84	74	54	-15.16	Avg
7459.67	V	34.02	22.75	19.43	53.45	42.18	74	54	-11.82	Avg
1653.33	H	40.96	30.11	1.01	41.97	31.12	74	54	-22.88	Avg
4958.67	H	38.05	25.72	12.49	50.54	38.21	74	54	-15.79	Avg
7383.50	H	35.63	23.06	19.31	58.69	42.37	74	54	-11.63	Avg

**Remark:**

1. Measuring frequencies from 1 GHz to the 10th harmonic of highest fundamental frequency.
2. Measurements above show only up to 6 maximum emissions noted, or would be lesser if no specific emissions from the EUT are recorded (ie: margin > 20dB from the applicable limit) and considered that's already beyond the background noise floor.
3. Radiated emissions measured in frequency above 1000MHz were made with an instrument using Peak detector mode and average detector mode of the emission shown in Actual FS column.
4. Spectrum setting:
  - a. Peak Setting 1GHz to 10th harmonics of fundamental, RBW = 1MHz, VBW = 1MHz, Sweep time = Auto.
  - b. AV Setting 1GHz to 10th harmonics of fundamental, RBW = 1MHz, VBW = 10Hz, Sweep time = Auto.



**3M**

**Operation Mode:** TX/ CH Low

**Test Date:** March 5, 2010

**Temperature:** 24°C

**Tested by:** jeff

**Humidity:** 50 % RH

**Polarity:** Ver. / Hor.

Freq. (MHz)	Ant. Pol H/V	Peak Reading (dBuV)	AV Reading (dBuV)	Ant. / CL CF (dB)	Actual Fs		Peak Limit (dBuV/m)	AV Limit (dBuV/m)	Margin (dB)	Remark
					Peak	AV				
					(dBuV/m)	(dBuV/m)				
1603.33	V	40.88	29.89	0.78	41.66	30.67	74	54	-23.33	Avg
4800.00	V	40.67	29.02	12.35	53.02	41.37	74	54	-12.63	Avg
7222.34	V	33.23	23.41	19.41	52.64	42.82	74	54	-11.18	Avg
1603.33	H	42.50	31.75	0.78	43.28	32.53	74	54	-21.47	Avg
4800.00	H	43.12	31.08	12.35	57.66	43.43	74	54	-10.57	Avg
7223.66	H	33.89	23.71	19.41	54.17	43.12	74	54	-10.88	Avg

**Remark:**

1. Measuring frequencies from 1 GHz to the 10th harmonic of highest fundamental frequency.
2. Measurements above show only up to 6 maximum emissions noted, or would be lesser if no specific emissions from the EUT are recorded (ie: margin > 20dB from the applicable limit) and considered that's already beyond the background noise floor.
3. Radiated emissions measured in frequency above 1000MHz were made with an instrument using Peak detector mode and average detector mode of the emission shown in Actual FS column.
4. Spectrum setting:
  - a. Peak Setting 1GHz to 10th harmonics of fundamental, RBW = 1MHz, VBW = 1MHz, Sweep time = Auto.
  - b. AV Setting 1GHz to 10th harmonics of fundamental, RBW = 1MHz, VBW = 10Hz, Sweep time = Auto.





Operation Mode: TX/ CH Mid

Test Date: March 5, 2010

Temperature: 24°C

Tested by: jeff

Humidity: 50 % RH

Polarity: Ver. / Hor.

Freq. (MHz)	Ant. Pol H/V	Peak	AV	Ant. / CL	Actual Fs		Peak	AV	Margin	Remark
		Reading	Reading	CF	Peak	AV	Limit	Limit	(dB)	
		(dBuV)	(dBuV)	(dB)	(dBuV/m)	(dBuV/m)	(dBuV/m)	(dBuV/m)		
1626.67	V	40.18	28.77	0.87	41.05	29.64	74	54	-24.36	Avg
4884.67	V	41.65	29.85	12.42	54.07	42.27	74	54	-11.73	Avg
7320.34	V	35.24	24.41	19.35	54.59	43.76	74	54	-10.24	Avg
1626.67	H	41.03	29.50	0.87	41.90	30.37	74	54	-23.63	Avg
4884.67	H	40.21	28.31	12.42	52.63	40.73	74	54	-13.27	Avg
7321.66	H	34.47	23.24	19.35	53.82	42.59	74	54	-11.41	Avg

**Remark:**

1. Measuring frequencies from 1 GHz to the 10th harmonic of highest fundamental frequency.
2. Measurements above show only up to 6 maximum emissions noted, or would be lesser if no specific emissions from the EUT are recorded (ie: margin > 20dB from the applicable limit) and considered that's already beyond the background noise floor.
3. Radiated emissions measured in frequency above 1000MHz were made with an instrument using Peak detector mode and average detector mode of the emission shown in Actual FS column.
4. Spectrum setting:
  - a. Peak Setting 1GHz to 10th harmonics of fundamental, RBW = 1MHz, VBW = 1MHz, Sweep time = Auto.
  - b. AV Setting 1GHz to 10th harmonics of fundamental, RBW = 1MHz, VBW = 10Hz, Sweep time = Auto.



Operation Mode: TX/ CH High

Test Date: March 5, 2010

Temperature: 24°C

Tested by: jeff

Humidity: 50 % RH

Polarity: Ver. / Hor.

Freq. (MHz)	Ant. Pol H/V	Peak Reading (dBuV)	AV Reading (dBuV)	Ant. / CL CF (dB)	Actual Fs		Peak Limit (dBuV/m)	AV Limit (dBuV/m)	Margin (dB)	Remark
					Peak	AV				
					(dBuV/m)	(dBuV/m)				
1653.33	V	41.01	28.53	1.01	42.02	29.54	74	54	-24.46	Avg
4959.32	V	39.75	26.11	12.50	52.25	38.61	74	54	-15.39	Avg
7459.67	V	33.84	22.47	19.43	53.27	41.90	74	54	-12.10	Avg
1653.33	H	40.50	29.37	1.01	41.51	30.38	74	54	-23.62	Avg
4958.67	H	37.92	25.44	12.49	50.41	37.93	74	54	-16.07	Avg
7383.50	H	35.32	22.85	19.31	54.63	42.16	74	54	-11.84	Avg

**Remark:**

1. Measuring frequencies from 1 GHz to the 10th harmonic of highest fundamental frequency.
2. Measurements above show only up to 6 maximum emissions noted, or would be lesser if no specific emissions from the EUT are recorded (ie: margin > 20dB from the applicable limit) and considered that's already beyond the background noise floor.
3. Radiated emissions measured in frequency above 1000MHz were made with an instrument using Peak detector mode and average detector mode of the emission shown in Actual FS column.
4. Spectrum setting:
  - a. Peak Setting 1GHz to 10th harmonics of fundamental, RBW = 1MHz, VBW = 1MHz, Sweep time = Auto.
  - b. AV Setting 1GHz to 10th harmonics of fundamental, RBW = 1MHz, VBW = 10Hz, Sweep time = Auto.

## 7.9 POWERLINE CONDUCTED EMISSIONS

### LIMIT

For an intentional radiator which is designed to be connected to the public utility (AC) power line, the radio frequency voltage that is conducted back onto the AC power line on any frequency or frequencies within the band 150 kHz to 30 MHz shall not exceed 250 microvolts (The limit decreases linearly with the logarithm of the frequency in the range 0.15 MHz to 0.50 MHz). The limits at specific frequency range is listed as follows:

Frequency Range (MHz)	Limits (dB $\mu$ V)	
	Quasi-peak	Average
0.15 to 0.50	66 to 56	56 to 46
0.50 to 5	56	46
5 to 30	60	50

Compliance with this provision shall be based on the measurement of the radio frequency voltage between each power line (LINE and NEUTRAL) and ground at the power terminals.

### Test Configuration

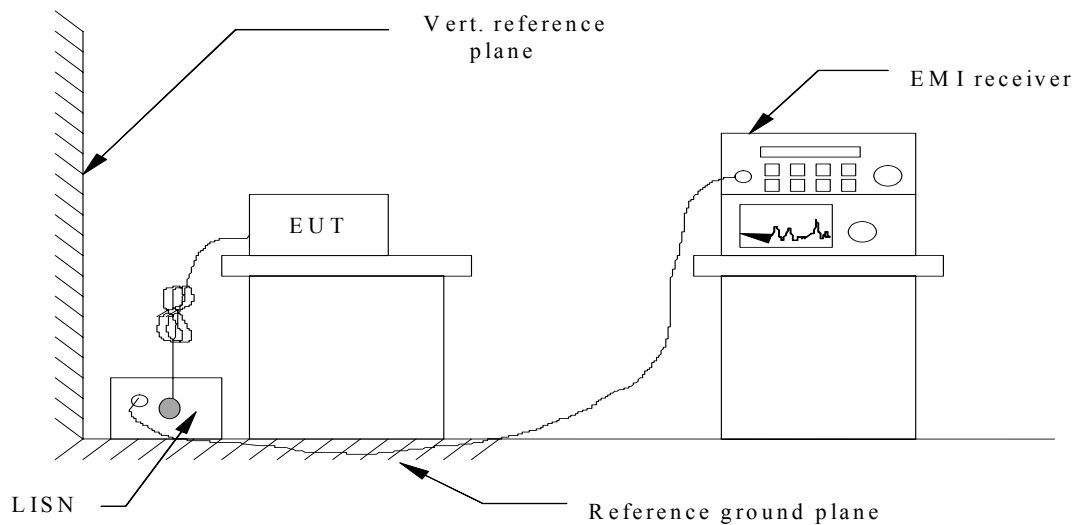

See test photographs attached in Appendix 1 for the actual connections between EUT and support equipment.

### TEST PROCEDURE

1. The EUT was placed on a table, which is 0.8m above ground plane.
2. Maximum procedure was performed on the six highest emissions to ensure EUT compliance.
3. Repeat above procedures until all frequency measured were complete.



### TEST RESULTS

The initial step in collecting conducted data is a spectrum analyzer peak scan of the measurement range. Significant peaks are then marked as shown on the following data page, and these signals are then quasi-peaked.

#### Test Data

Model: Voyager PRO UC v2

Test Mode: Charging mode(AC Mode)

Temperature: 24°C

Humidity: 50% RH

Tested by: jeff

Test Results: Pass

Freq. (MHz)	Q.P. Raw reading (dBuV)	AVG Raw reading (dBuV)	Correction factor(dB)	Q.P. Amptd. (dBuV)	AVG Amptd. (dBuV)	Q.P. Limit (dBuV)	AVG Limit (dBuV)	Q.P. Margin (dB)	AVG Margin (dB)	Line/Neutral
0.198	20.14	14.14	10.11	30.25	24.25	64.63	54.63	-34.38	-30.38	Line
0.265	19.24	17.46	10.21	29.45	27.67	62.72	52.72	-33.27	-25.05	Line
0.335	22.11	19.29	10.32	32.43	29.61	60.71	50.71	-28.28	-21.10	Line
0.672	18.67	13.95	10.92	29.59	24.87	56.00	46.00	-26.41	-21.13	Line
2.064	14.67	5.43	11.09	25.76	16.52	56.00	46.00	-30.24	-29.48	Line
8.576	17.98	2.46	11.20	29.18	13.66	60.00	50.00	-30.82	-36.34	Line
0.202	21.58	11.40	10.18	31.76	21.58	64.52	54.52	-32.76	-32.94	Neutral
0.265	14.98	11.75	10.17	25.15	21.92	62.72	52.72	-37.57	-30.80	Neutral
0.331	15.26	9.07	10.15	25.41	19.22	60.82	50.82	-35.41	-31.60	Neutral
0.539	9.15	1.02	10.14	19.29	11.16	56.00	46.00	-36.71	-34.84	Neutral
2.144	9.39	2.67	10.60	19.99	13.27	56.00	46.00	-36.01	-32.73	Neutral
8.400	16.01	1.50	11.12	27.13	12.62	60.00	50.00	-32.87	-37.38	Neutral

#### Remark:

1. The measuring frequencies range between 0.15 MHz and 30 MHz.
2. The emissions measured in the frequency range between 0.15 MHz and 30MHz were made with an instrument using Quasi-peak detector and Average detector.
3. “---” denotes the emission level was or more than 2dB below the Average limit, and no re-check was made.
4. The IF bandwidth of SPA between 0.15MHz and 30MHz was 10KHz. The IF bandwidth of Test Receiver between 0.15MHz and 30MHz was 9kHz.

#### Note:

Freq. = Emission frequency in KHz

Factor (dB) = cable loss + Insertion loss of LISN+ Insertion loss of TRANSIENT LIMITER (The TRANSIENT LIMITER included 10 dB ATTENUATION)

Amptd dBuV = Uncorrected Analyzer/Receiver reading + cable loss + Insertion loss of LISN+ Insertion loss of TRANSIENT LIMITER,

if it > 0.5 dB

Limit dBuV = Limit stated in standard

Margin dB = Reading in reference to limit



### Calculation Formula

$$\text{Margin (dB)} = \text{Amptd (dBuV)} - \text{Limit (dBuV)}$$

### Test Plot

#### Conducted emissions (Line 1)

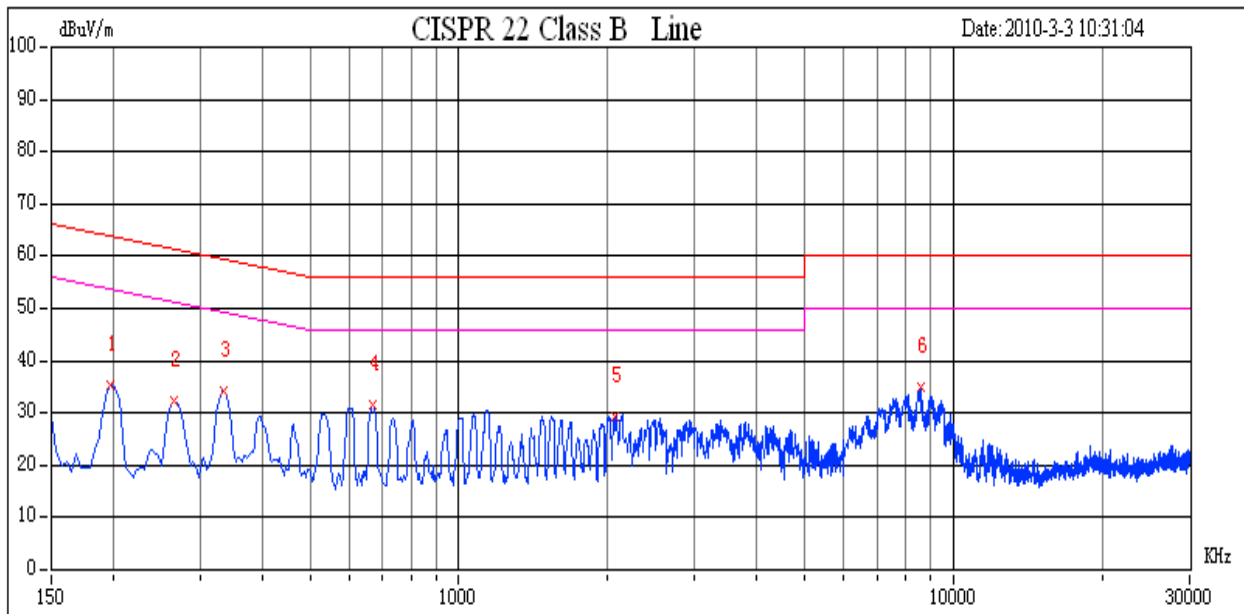

### Test Plot

#### Conducted emissions (Line 2)

