



Test report No:
2210113R-RF-US-P06V02

FCC & ISED TEST REPORT

Product Name	Bluetooth headset
Trademark	Plantronics
Model and /or type reference	VFOCUS2
FCC ID	AL8-VFOCUS2A
IC	457A-VFOCUS2A
Applicant's name / address	Plantronics, Inc. 345 Encinal Street, Santa Cruz, CA95060 USA
Test method requested, standard	FCC CFR Title 47 Part 15 Subpart C Section 15.247 ANSI C63.10: 2013 KD558074 D01 15.247 Meas Guidance v05r02 RSS-Gen Issue 5 RSS-247 Issue 2
Verdict Summary	IN COMPLIANCE
Tested by (name / position & signature)	Adma Lu/Project Engineer
Approved by (name / position & signature)	Jack Zhang/Supervisor
Date of issue	2022-01-24
Report Version	V1.0
Report template No	Template_FCC 15.247-RF-V1.0

INDEX

	page
General conditions	4
Environmental conditions	4
Possible test case verdicts	5
Abbreviations.....	5
Document History.....	6
Remarks and Comments	6
Used Equipment.....	7
Uncertainty	9
1 General Information	10
1.1 General Description of the Item(s).....	10
1.2 Antenna Information	11
1.3 Channel List.....	12
2 Description of Test Setup.....	13
2.1 Operating mode(s) used for tests	13
2.2 Auxiliary equipment / Test software for the EUT	13
2.3 Test Configuration / Block diagram used for tests.....	14
2.4 Testing process	15
3 Verdict summary section.....	16
3.1 Standards	16
3.2 Deviation(s) from the Standard(s) / Test Specification(s).....	16
3.3 Overview of results	17
3.4 Test Facility.....	18
4 Test Results	19
4.1 AC Power Line Conducted Emission.....	19
4.1.1 Limit	19
4.1.2 Test Setup	19
4.1.3 Test Procedure	19
4.1.4 Test Data	20
4.2 Emissions in restricted frequency bands	22
4.2.1 Limit	22
4.2.2 Test Setup	24
4.2.3 Test Procedure	25
4.2.4 Test Data	26
4.3 Emissions in non-restricted frequency band	40

4.3.1	Limit	40
4.3.2	Test Setup	40
4.3.3	Test Procedure	40
4.3.4	Test Data	41
4.4	Duty cycle	43
4.4.1	Limit	43
4.4.2	Test Setup	43
4.4.3	Test Procedure	43
4.4.4	Test Data	44
4.5	Band Edge	45
4.5.1	Limit	45
4.5.2	Test Setup	45
4.5.3	Test Procedure	45
4.5.4	Test Data	46
4.6	DTS Bandwidth	62
4.6.1	Limit	62
4.6.2	Test Setup	62
4.6.3	Test Procedure	62
4.6.4	Test Data	63
4.7	Fundamental emission output power	64
4.7.1	Limit	64
4.7.2	Test Setup	64
4.7.3	Test Procedure	65
4.7.4	Test Data	66
4.8	Power Density	67
4.8.1	Limit:	67
4.8.2	Test Setup	67
4.8.3	Test Procedure	67
4.8.4	Test Data	68
4.9	Antenna Requirement	69
4.9.1	Limit:	69
4.9.2	Antenna Connector Construction:	69
5	Test setup photo and EUT Photo	70

COMPETENCES AND GUARANTEES

DEKRA is a testing laboratory competent to carry out the tests described in this report.

In order to assure the traceability to other national and international laboratories, DEKRA has a calibration and maintenance program for its measurement equipment.

DEKRA guarantees the reliability of the data presented in this report, which is the result of the measurements and the tests performed to the item under test on the date and under the conditions stated in the report and it is based on the knowledge and technical facilities available at DEKRA at the time of performance of the test.

DEKRA is liable to the client for the maintenance of the confidentiality of all information related to the item under test and the results of the test.

The results presented in this Test Report apply only to the particular item under test established in this document.

IMPORTANT: No parts of this report may be reproduced or quoted out of context, in any form or by any means, except in full, without the previous written permission of DEKRA.

GENERAL CONDITIONS

Test Location	No. 99, Hongye Road, Suzhou Industrial Park Suzhou, 215006, P.R. China
Date(receive sample)	Jan. 05, 2022
Date (start test)	Jan. 07, 2022
Date (finish test)	Jan. 20, 2022

1. This report is only referred to the item that has undergone the test.
2. This report does not constitute or imply on its own an approval of the product by the Certification Bodies or Competent Authorities.
3. This document is only valid if complete; no partial reproduction can be made without previous written permission of DEKRA.
4. This test report cannot be used partially or in full for publicity and/or promotional purposes without previous written permission of DEKRA.

ENVIRONMENTAL CONDITIONS

The climatic conditions during the tests are within the limits specified by the manufacturer for the operation of the EUT and the test equipment. The climatic conditions during the tests were within the following limits:

Ambient temperature	15 °C – 35 °C
Relative Humidity air	30% - 60%

If explicitly required in the basic standard or applied product / product family standard the climatic values are recorded and documented separately in this test report.

POSSIBLE TEST CASE VERDICTS

Test case does not apply to test object	N/A
Test object does meet requirement	P (Pass) / PASS
Test object does not meet requirement	F (Fail) / FAIL
Not measured	N/M

ABBREVIATIONS

For the purposes of the present document, the following abbreviations apply:

EUT	: Equipment Under Test
QP	: Quasi-Peak
CAV	: CISPR Average
AV	: Average
CDN	: Coupling Decoupling Network
SAC	: Semi-Anechoic Chamber
OATS	: Open Area Test Site
BW	: Bandwidth
AM	: Amplitude Modulation
PM	: Pulse Modulation
HCP	: Horizontal Coupling Plane
VCP	: Vertical Coupling Plane
U_N	: Nominal voltage
T_x	: Transmitter
R_x	: Receiver
N/A	: Not Applicable
N/M	: Not Measured

DOCUMENT HISTORY

Report No.	Version	Description	Issued Date
2210113R-RF-US-P06V02	V1.0	Initial issue of report.	2022-01-24

REMARKS AND COMMENTS

1. The equipment under test (EUT) does meet the essential requirements of the stated standard(s)/test(s).
2. These test results on a sample of the device are for the purpose of demonstrating Compliance with Part 15 Subpart C Paragraph 15.247, RSS-Gen Issue 5, RSS-247 Issue 2.
3. The measurement result is considered in conformance with the requirement if it is within the prescribed limit, It is not necessary to account the uncertainty associated with the measurement result.
4. The test results presented in this report relate only to the object tested.
5. The test report shall not be reproduced without the written approval of DEKRA Testing and Certification (Suzhou) Co., Ltd.
6. This report will not be used for social proof function in China market.
7. DEKRA declines any responsibility with the following test data provided by customer that may affect the validity of result:
 - Chapter 1.1 General Description of the Item(s);
 - Chapter 1.2 Antenna Information;
 - Chapter 1.3 Channel List.

USED EQUIPMENT

AC Power Line Conducted Emission / TR1

Instrument	Manufacturer	Model No.	Serial No.	Cal. Date	Next Cal. Date
EMI Test Receiver	R&S	ESCI	100906	2021.04.28	2022.04.27
Two-Line V-Network	R&S	ENV216	101044	2021.03.20	2022.03.19
50ohm Termination	SHX	TF2	7081403	2021.09.04	2022.09.03
50ohm Coaxial Switch	Anritsu	MP59B	6200464462	N/A	N/A
Temperature/Humidity Meter	RTS	RTS-8S	TR1-TH	2021.07.09	2022.07.08
Dekra test software	Dekra	-	-	-	-

Emissions in non-restricted frequency bands/ Occupied Bandwidth/ Fundamental emission output power/ Power Spectral Density/Band Edge/ TR8

Instrument	Manufacturer	Model No.	Serial No.	Cal. Date	Next Cal. Date
Spectrum Analyzer	Agilent	N9010A	MY48030494	2021.07.11	2022.07.10
EXA Spectrum Analyzer	Keysight	N9010A	MY55370495	2021.03.20	2022.03.19
MXA Signal Analyzer	Keysight	N9020A	MY56060147	2021.07.11	2022.07.10
4TX MIMO Power Sensor	Keysight	X8750A	MY59400102	2021.02.11	2022.02.10
Temperature/Humidity Meter	RTS	RTS-8S	RF08	2021.07.09	2022.07.08

Radiated Emission(30MHz-1GHz) / AC3

Instrument	Manufacturer	Model No.	Serial No.	Cal. Date	Next Cal. Date
EMI Test Receiver	R&S	ESCI	100176	2021.08.15	2022.08.14
Loop Antenna	R&S	HFH2-Z2	833799/003	2021.03.04	2022.03.03
Bilog Antenna	Teseq GmbH	CBL6112D	27613	2021.08.23	2022.08.22
Coaxial Cable	Huber+Suhner	RG 214	AC3-C	2021.03.31	2022.03.30
Temperature/Humidity Meter	RTS	RTS-8S	AC3-TH	2021.07.09	2022.07.08
Dekra test software	Dekra	-	-	-	-

Radiated Emission(1GHz-40GHz) / AC5

Instrument	Manufacturer	Model No.	Serial No.	Cal. Date	Next Cal. Date
EXA Spectrum Analyzer	Keysight	N9010A	MY55370495	2021.03.20	2022.03.19
Amplifier	Keleto	LNPA	SK20190225	2021.04.16	2022.04.15
Preamplifier	EMCI	EMC184045SE	980263	2021.05.22	2022.05.21
DRG Horn Antenna	ETS-Lindgren	3117	00167055	2021.08.23	2022.08.22
Broad-Band Horn Antenna	Schwarzbeck	BBHA9170	294	2021.04.14	2023.04.13
Coaxial Cable	Huber+Suhner	SUCOFLEX 106	AC5-C2	2021.03.31	2022.03.30
Coaxial Cable	ROSENBERGER	LA1-C011- 2000/3000	AC5-40G	2021.03.20	2022.03.19
High-Pass Filter	Wainwright	WHKX3.0/18G- 12SS	AC5&AC6	2021.06.08	2022.06.07
Temperature/Humidity Meter	RTS	RTS-8S	AC5-TH	2021.07.09	2022.07.08
Dekra test software	Dekra	-	-	-	-

UNCERTAINTY

Uncertainties have been calculated according to the DEKRA internal document. The reported expanded uncertainties are based on a standard uncertainty multiplied by a coverage factor of $k=2$, providing a level of confidence of approximately 95%. The Uncertainties is complice with standard required as below.

Test item	Uncertainty
AC Power Line Conducted Emission	9kHz~150kHz: 2.80dB 150kHz~30MHz: 2.40dB
Peak Power Output	± 1.27 dB
Radiated Emission(30MHz~1GHz)	Horizontal: 30MHz~200MHz: 3.50 dB 300MHz~1GHz: 3.60 dB Vertical: 30MHz~200MHz: 3.60 dB 300MHz~1GHz: 3.50 dB
Radiated Emission(1GHz~26.5GHz)	Horizontal: 1GHz~18GHz: 5.00 dB Vertical: 1GHz~18GHz: 4.80 dB
RF antenna conducted test	± 1.27 dB
Radiated Emission Band Edge	± 3.9 dB
DTS Bandwidth	± 150 Hz
Occupied Bandwidth	± 1 kHz
Power Density	± 1.27 dB

1 GENERAL INFORMATION

1.1 General Description of the Item(s)

Product Name	Bluetooth headset
Model No.	VFOCUS2
FCC ID	AL8-VFOCUS2A
IC	457A-VFOCUS2A
Manufacturer	Plantronics, Inc.
Manufacturer Address	345 Encinal Street, Santa Cruz, CA95060 USA

Wireless specification.....	Bluetooth 5.0					
Operating frequency range(s)	2400~2483.5MHz					
Type of Modulation.....	GFSK					
PHYs	<input checked="" type="checkbox"/>	LE 1M	<input checked="" type="checkbox"/>	LE 2M	<input type="checkbox"/>	LE Coded S=2/8
Data Rate	<input checked="" type="checkbox"/>	1Mbit/s	<input checked="" type="checkbox"/>	2Mbit/s	<input type="checkbox"/>	500/125 Kbit/s
Number of channel.....	40					

Rated power supply	Voltage and Frequency					
	<input type="checkbox"/>	AC: 220 – 240 V, 50/60 Hz				
	<input type="checkbox"/>	AC: 110 – 130 Vac, 50/60 Hz				
	<input checked="" type="checkbox"/>	DC: 3.3~4.2 V				
	<input type="checkbox"/>	Adapter: Input: 100-240V,50/60H, 0.3A Output:5V,2A ,10W				
Mounting position	<input type="checkbox"/>	Table top equipment				
	<input type="checkbox"/>	Wall/Ceiling mounted equipment				
	<input type="checkbox"/>	Floor standing equipment				
	<input checked="" type="checkbox"/>	Head-mounted equipment				
	<input type="checkbox"/>	Other: Watch				

1.2 Antenna Information

Antenna model / type number	N/A		
Antenna serial number	N/A		
Antenna Delivery	<input checked="" type="checkbox"/>	1TX + 1RX	
	<input type="checkbox"/>	2TX + 2RX	
	<input type="checkbox"/>	Others:.....	
Antenna technology	<input checked="" type="checkbox"/>	SISO	
	<input type="checkbox"/>	MIMO	<input type="checkbox"/> CDD
			<input type="checkbox"/> Beam-forming
Antenna Type	<input type="checkbox"/>	External	<input type="checkbox"/> Dipole
			<input type="checkbox"/> Sectorized
	<input checked="" type="checkbox"/>	Internal	<input type="checkbox"/> PIFA
			<input checked="" type="checkbox"/> PCB
			<input type="checkbox"/> Dipole
			<input type="checkbox"/> Others.....
Antenna Gain	3.59dBi		

1.3 Channel List

Bluetooth Working Frequency of Each Channel:							
Channel	Frequency	Channel	Frequency	Channel	Frequency	Channel	Frequency
00	2402 MHz	01	2404 MHz	02	2406 MHz	03	2408 MHz
04	2410 MHz	05	2412 MHz	06	2414 MHz	07	2416 MHz
08	2418 MHz	09	2420 MHz	10	2422 MHz	11	2424 MHz
12	2426 MHz	13	2428 MHz	14	2430 MHz	15	2432 MHz
16	2434 MHz	17	2436 MHz	18	2438 MHz	19	2440 MHz
20	2442 MHz	21	2444 MHz	22	2446 MHz	23	2448 MHz
24	2450 MHz	25	2452 MHz	26	2454 MHz	27	2456 MHz
28	2458 MHz	29	2460 MHz	30	2462 MHz	31	2464 MHz
32	2466 MHz	33	2468 MHz	34	2470 MHz	35	2472 MHz
36	2474 MHz	37	2476 MHz	38	2478 MHz	39	2480 MHz

Note: The general description of the Item(s), antenna information and channel list in clause 1 are provided and confirmed by the client.

2 DESCRIPTION OF TEST SETUP

2.1 Operating mode(s) used for tests

During the tests the following operating mode(s) has(have) been used.

Test Mode For Bluetooth	Mode1: Transmit by LE_1Mbps
	Mode2: Transmit by LE_2Mbps

2.2 Auxiliary equipment / Test software for the EUT

Auxiliary equipment	Type / Version	Manufacturer	Supplied by
Notebook	2526	Think Pad	N/A
Software	Type / Version	Manufacturer	Supplied by
BlueTest3	N/A	N/A	N/A

2.3 Test Configuration / Block diagram used for tests

Test setup Diagram- AC Line Conducted Emission Test

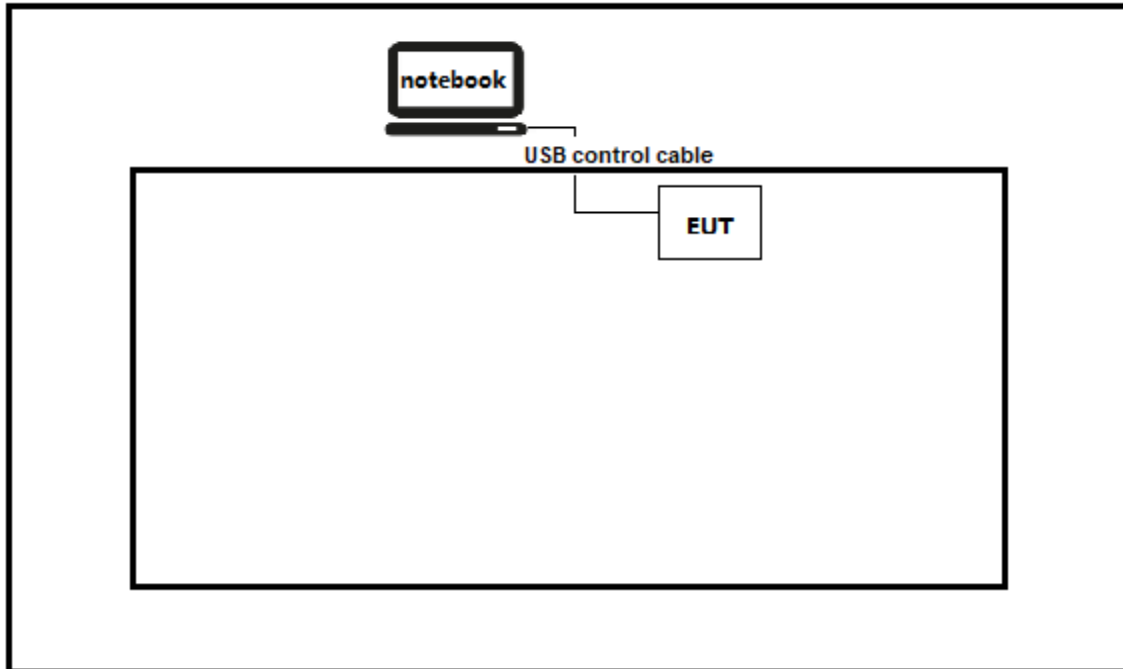

Test setup Diagram- Radiated Emission

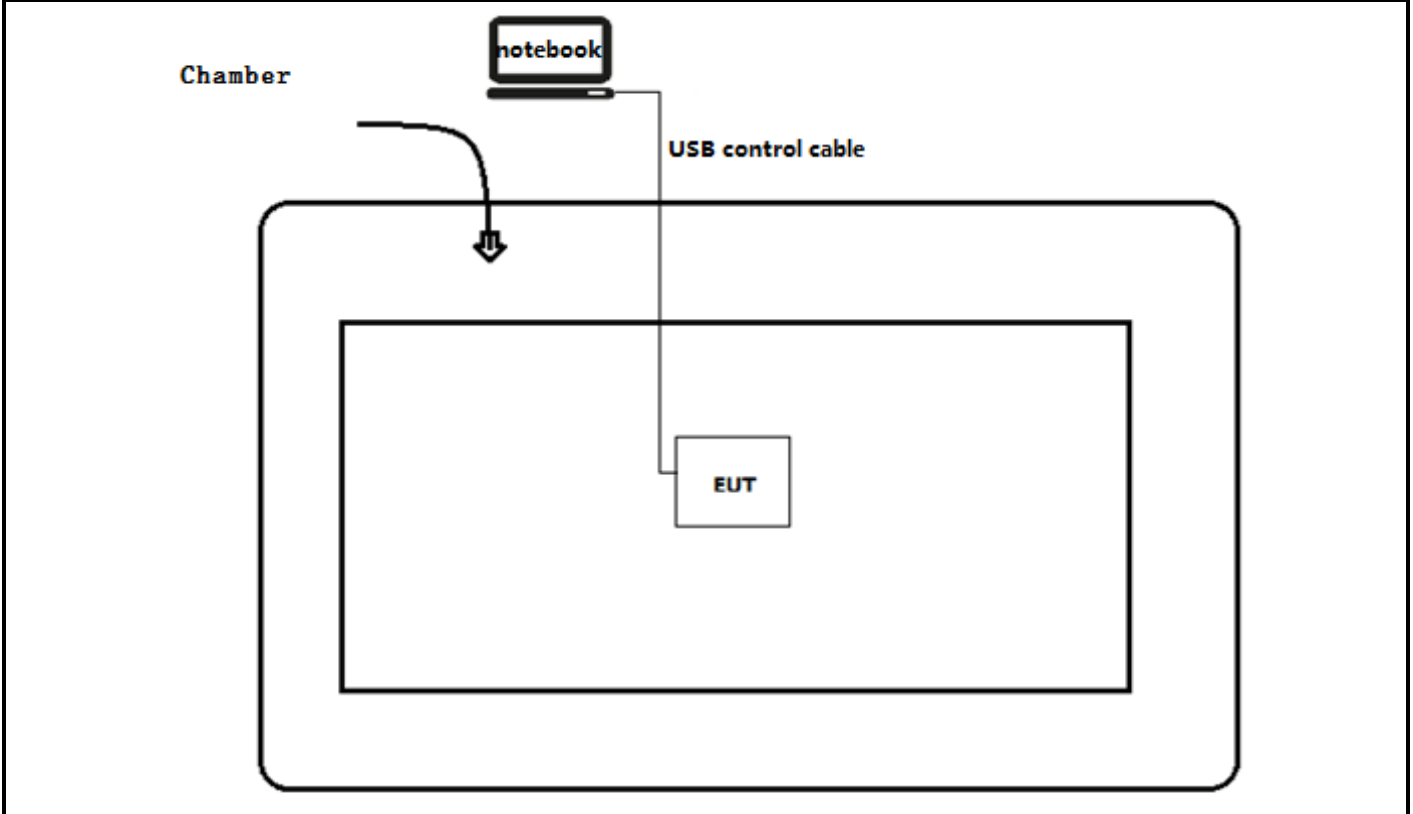

2.4 Testing process

1	Setup the EUT as shown in Section 2.4.
2	Run the software "BlueTest3" on the notebook computer.
3	Commands to configure the test mode, test channel, test power and data rate.
4	Verify that the EUT works properly.

3 VERDICT SUMMARY SECTION

This chapter presents an overview of standards and results. Refer to the next chapters for details of measured test results and applied test levels.

3.1 Standards

Standard	Year	Description
FCC CFR Title 47 Part 15 Subpart C Section 15.247	2021	Operation within the bands 902–928 MHz, 2400–2483.5 MHz, and 5725–5850 MHz.
ANSI C63.10	2013	American National Standard of Procedures for Compliance Testing of Unlicensed Wireless Devices
KDB558074 D01 v05r02	2019	Guidance for performing compliance measurements on Digital Transmission System (DTS) operating under section 15.247
RSS-Gen Issue 5 Amendment 2	2021	General Requirements for Compliance of Radio Apparatus
RSS-247 Issue 2	2017	Digital Transmission Systems (DTSs), Frequency Hopping Systems (FHSs) and Licence-Exempt Local Area Network (LE-LAN) Devices

3.2 Deviation(s) from the Standard(s) / Test Specification(s)

The following deviation(s) was / were made from the published requirements of the listed standards: N/A.

(Please define the deviations from the standard(s) if applicable)

3.3 Overview of results

For FCC

Requirement – Test case	Basic standard(s)	Verdict	Remark
AC Power Line Conducted Emission	FCC 15.207	PASS	---
Emissions in restricted frequency bands	FCC 15.247(b)(3)	PASS	---
Duty cycle	ANSI C63.10:2013	PASS	---
Emissions in non-restricted frequency bands	FCC 15.247(d), FCC 15.209	PASS	---
Band Edge	FCC 15.247(d)	PASS	---
Fundamental emission output power	FCC 15.247(d), FCC 15.209	PASS	---
DTS Bandwidth	FCC 15.247(a)(2)	PASS	---
Power Spectral Density	FCC 15.247(e)	PASS	---
Antenna Requirement	FCC 15.203	PASS	---

For ISED

Requirement – Test case	Basic standard(s)	Verdict	Remark
AC Power Line Conducted Emission	RSS-Gen Issue 5 Section 8.8	PASS	---
Emissions in restricted frequency bands	RSS-Gen Issue 5 Section 8.9	PASS	---
Duty cycle	ANSI C63.10:2013	PASS	---
Emissions in non-restricted frequency bands	RSS-247 Issue 2 Section 5.5	PASS	---
Band Edge	RSS-Gen Issue 5 Section 8.10	PASS	---
Fundamental emission output power	RSS-247 Issue 2 Section 5.4(d)	PASS	---
DTS Bandwidth	RSS-Gen Issue 5 Section 6.7	PASS	---
Power Spectral Density	RSS-247 Issue 2 Section 5.2(b)	PASS	---
Antenna Requirement	RSS-Gen Issue 5 Section 6.8	PASS	---

3.4 Test Facility

USA : **FCC Designation Number: CN1199**

CA : **ISED CAB identifier: CN0040**

4 TEST RESULTS

4.1 AC Power Line Conducted Emission

VERDICT: PASS

4.1.1 Limit

Standard		
FCC Part 15 Subpart C Paragraph 15.207		
Frequency range [MHz]	Limit: QP [dB(μV) ¹⁾	Limit: AV [dB(μV) ¹⁾
0,15 - 0,50	66 - 56 ²⁾	56 - 46 ²⁾
0,50 - 5,0	56	46
5,0 - 30	60	50

¹⁾ At the transition frequency, the lower limit applies.

²⁾ The limit decreases linearly with the logarithm of the frequency.

NOTE 1: The exclusion band for transmitters shall be considered for transmitters operating at frequencies below 30 MHz.

NOTE 2: Where the AC output port is directly connected (or via a circuit breaker) to the AC power input port of the EUT the AC power output port need not to be tested.

4.1.2 Test Setup

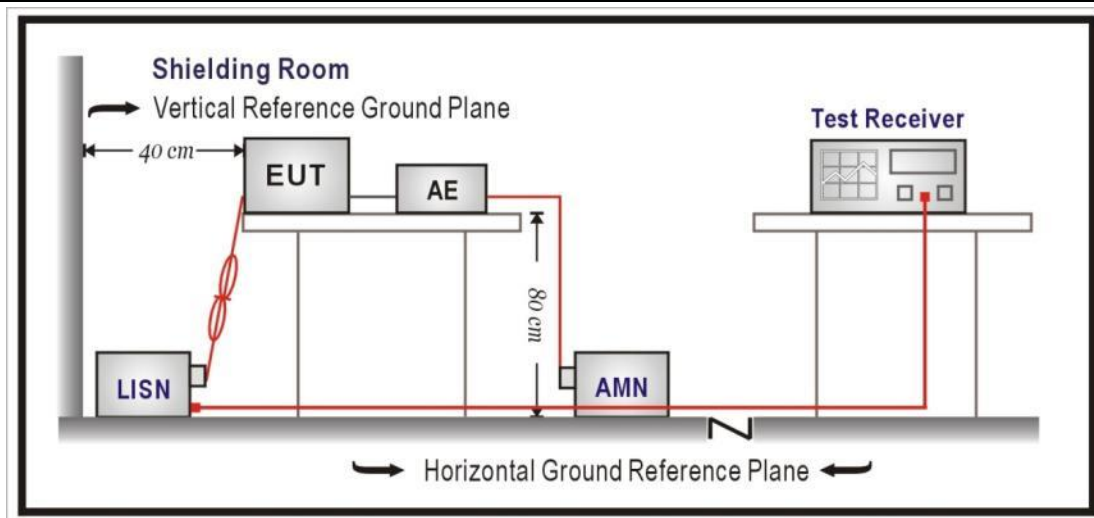

4.1.3 Test Procedure

	References Rule	Chapter	Item
<input checked="" type="checkbox"/>	ANSI C63.10-2013	6.2	Standard test method for ac power-line conducted emissions from unlicensed wireless devices

4.1.4 Test Data

Profile: 2210113R	Page No.: 25
Engineer: Tim.Cao	
Site: TR1	Time: 2022/01/19 - 16:10
Limit: FCC_Part15.107_CE_AC Power_ClassB	Margin: 0
Probe: ENV216_101190(0.009-30MHz)	Polarity: Line
EUT: Bluetooth headset	Power: AC 120V/60Hz
Note: Mode 1:Transmit at 2402MHz by BLE	

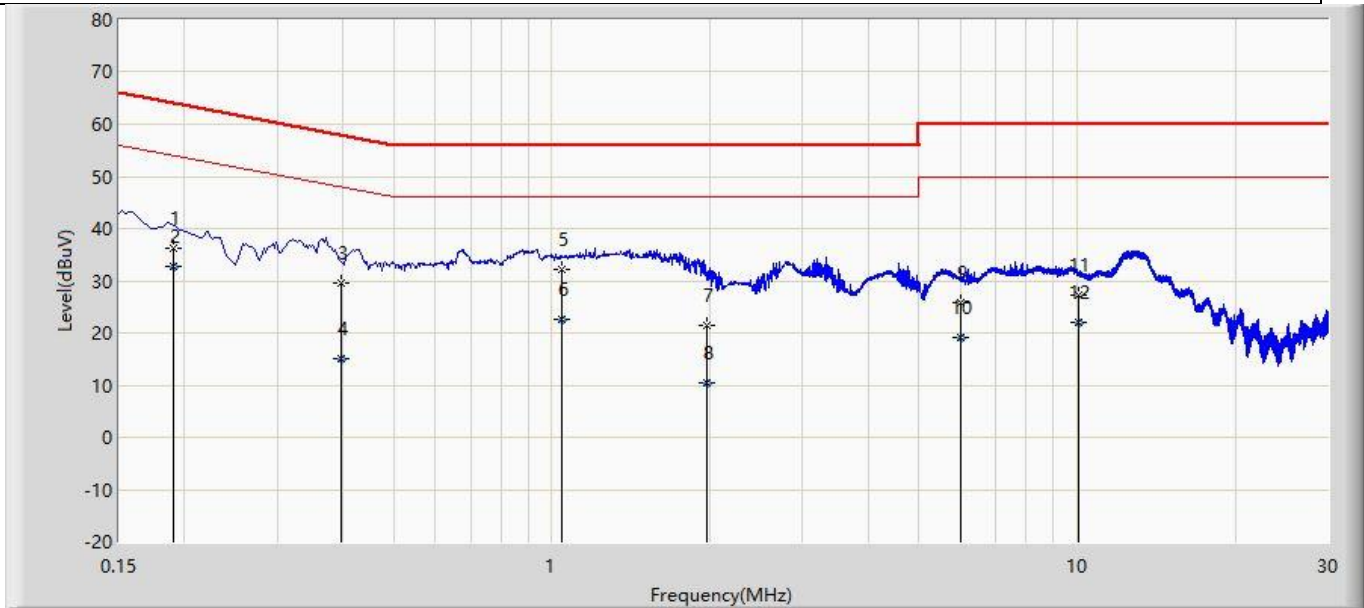

No	Mark	Frequency (MHz)	Measure Level (dBuV)	Reading Level (dBuV)	Over Limit (dB)	Limit (dBuV)	Factor (dB)	Type
1		0.191	36.100	26.515	-27.915	64.015	9.585	QP
2	*	0.191	32.627	23.042	-21.388	54.015	9.585	AV
3		0.398	29.512	19.901	-28.393	57.905	9.612	QP
4		0.398	14.964	5.352	-32.942	47.905	9.612	AV
5		1.041	32.250	22.601	-23.750	56.000	9.650	QP
6		1.041	22.666	13.016	-23.334	46.000	9.650	AV
7		1.970	21.510	11.835	-34.490	56.000	9.675	QP
8		1.970	10.540	0.865	-35.460	46.000	9.675	AV
9		6.013	25.909	16.047	-34.091	60.000	9.861	QP
10		6.013	19.135	9.274	-30.865	50.000	9.861	AV
11		10.084	27.351	17.338	-32.649	60.000	10.012	QP
12		10.084	21.971	11.958	-28.029	50.000	10.012	AV

Profile: 2210113R	Page No.: 26
Engineer: Tim.Cao	
Site: TR1	Time: 2022/01/19 - 16:11
Limit: FCC_Part15.107_CE_AC Power_ClassB	Margin: 0
Probe: ENV216_101190(0.009-30MHz)	Polarity: Line
EUT: Bluetooth headset	Power: AC 120V/60Hz
Note: Mode 1:Transmit at 2402MHz by BLE	

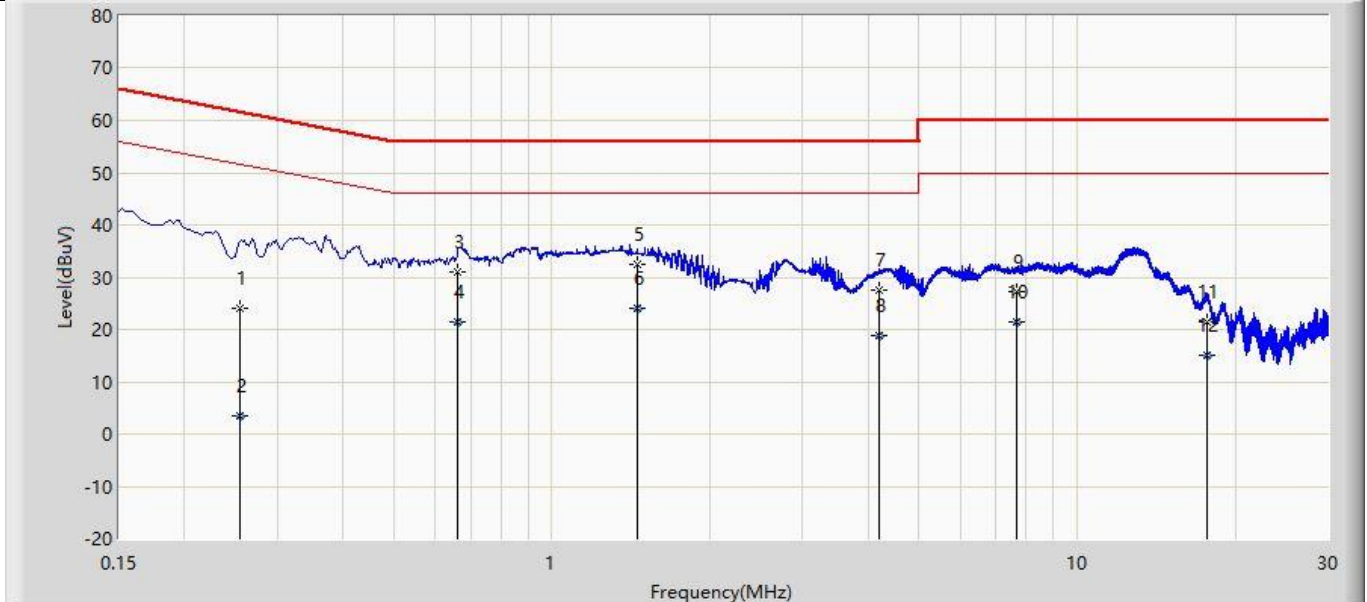

No	Mark	Frequency (MHz)	Measure Level (dBuV)	Reading Level (dBuV)	Over Limit (dB)	Limit (dBuV)	Factor (dB)	Type
1		0.254	23.976	14.382	-37.666	61.642	9.594	QP
2		0.254	3.558	-6.036	-48.084	51.642	9.594	AV
3		0.663	30.922	21.287	-25.078	56.000	9.636	QP
4		0.663	21.367	11.731	-24.633	46.000	9.636	AV
5		1.457	32.606	22.944	-23.394	56.000	9.661	QP
6	*	1.457	23.952	14.291	-22.048	46.000	9.661	AV
7		4.205	27.442	17.662	-28.558	56.000	9.780	QP
8		4.205	18.867	9.087	-27.133	46.000	9.780	AV
9		7.670	27.234	17.301	-32.766	60.000	9.932	QP
10		7.670	21.485	11.552	-28.515	50.000	9.932	AV
11		17.608	21.401	11.216	-38.599	60.000	10.185	QP
12		17.608	14.951	4.766	-35.049	50.000	10.185	AV

4.2 Emissions in restricted frequency bands	VERDICT: PASS
--	----------------------

4.2.1 Limit			
Standard		FCC Part 15 Subpart C Paragraph 15.209	
Restricted Bands of operationfor FCC			
Frequency (MHz)	Frequency (MHz)	Frequency (MHz)	Frequency (GHz)
0.090 – 0.110	16.42 – 16.423	399.9 – 410	4.5 – 5.15
0.495 – 0.505	16.69475 – 16.69525	608 – 614	5.35 – 5.46
2.1735 – 2.1905	16.80425 – 16.80475	960 – 1240	7.25 – 7.75
4.125 – 4.128	25.5 – 25.67	1300 – 1427	8.025 – 8.5
4.17725 – 4.17775	37.5 – 38.25	1435 – 1626.5	9.0 – 9.2
4.20725 – 4.20775	73 – 74.6	1645.5 – 1646.5	9.3 – 9.5
6.215 – 6.218	74.8 – 75.2	1660 – 1710	10.6 – 12.7
6.26775 – 6.26825	108 – 121.94	1718.8 – 1722.2	13.25 – 13.4
6.31175 – 6.31225	123 – 138	2200 – 2300	14.47 – 14.5
8.291 – 8.294	149.9 – 150.05	2310 – 2390	15.35 – 16.2
8.362 – 8.366	156.52475 – 156.52525	2483.5 – 2500	17.7 – 21.4
8.37625 – 8.38675	156.7 – 156.9	2690 – 2900	22.01 – 23.12
8.81425 – 8.81475	162.0125 – 167.17	3260 – 3267	23.6 – 24.0
12.29 – 12.293	167.72 – 173.2	3332 – 3339	31.2 – 31.8
12.51975 – 12.52025	240 – 285	3345.8 – 3358	36.43 – 36.5
12.57675 – 12.57725	322 – 335.4	3600 – 4400	
13.36 – 13.41			
Restricted Bands of operationfor IC			
0.090 - 0.110	13.36 - 13.41	960 - 1427	9.0 - 9.2
0.495 - 0.505	16.42 - 16.423	1435 - 1626.5	9.3 - 9.5
2.1735 - 2.1905	16.69475 - 16.69525	1645.5 - 1646.5	10.6 - 12.7
3.020 - 3.026	16.80425 - 16.80475	1660 - 1710	13.25 - 13.4
4.125 - 4.128	25.5 - 25.67	1718.8 - 1722.2	14.47 - 14.5
4.17725 - 4.17775	37.5 - 38.25	2200 - 2300	15.35 - 16.2
4.20725 - 4.20775	73 - 74.6	2310 - 2390	17.7 - 21.4
5.677 - 5.683	74.8 - 75.2	2483.5 - 2500	22.01 - 23.12
6.215 - 6.218	108 - 138	2655 - 2900	23.6 - 24.0
6.26775 - 6.26825	149.9 - 150.05	3260 - 3267	31.2 - 31.8
6.31175 - 6.31225	156.52475 - 156.52525	3332 - 3339	36.43 - 36.5
8.291 - 8.294	156.7 - 156.9	3345.8 - 3358	Above 38.6
8.362 - 8.366	162.0125 - 167.17	3500 - 4400	
8.37625 - 8.38675	167.72 - 173.2	4500 - 5150	
8.41425 - 8.41475	240 - 285	5350 - 5460	
12.29 - 12.293	322 - 335.4	7250 - 7750	
12.51975 - 12.52025	399.9 - 410	8025 - 8500	
12.57675 - 12.57725	608 - 614	--	

Restricted Band Emissions Limit			
Frequency (MHz)	Field strength ($\mu\text{V/m}$)	Field strength ($\text{dB}\mu\text{V/m}$)	Measurement distance (m)
0.009 - 0.49	2400/F(kHz)	48.5 – 13.8	300 _(Note 1)
0.49 - 1.705	24000/F(kHz)	33.8 - 23	30 _(Note 1)
1.705 - 30	30	29.5	30 _(Note 1)
30 -88	100	40	3 _(Note 2)
88-216	150	43.5	3 _(Note 2)
216 - 960	200	46	3 _(Note 2)
Above 960	500	54	3 _(Note 2)

Note 1: At frequencies below 30 MHz, measurements may be performed at a distance closer than that specified in the regulations; however, an attempt should be made to avoid making measurements in the near field. Pending the development of an appropriate measurement procedure for measurements performed below 30 MHz, when performing measurements at a closer distance than specified, the results shall be extrapolated to the specified distance by either making measurements at a minimum of two distances on at least one radial to determine the proper extrapolation factor or by using the square of an inverse linear distance extrapolation factor (40 dB/decade).

Note 2: At frequencies at or above 30 MHz, measurements may be performed at a distance other than what is specified provided: measurements are not made in the near field except where it can be shown that near field measurements are appropriate due to the characteristics of the device; and it can be demonstrated that the signal levels needed to be measured at the distance employed can be detected by the measurement equipment.

Measurements shall not be performed at a distance greater than 30 meters unless it can be further demonstrated that measurements at a distance of 30 meters or less are impractical. When performing measurements at a distance other than that specified, the results shall be extrapolated to the specified distance using an extrapolation factor of 20 dB/decade (inverse linear-distance for field strength measurements; inverse-linear-distance-squared for power density measurements).

4.2.2 Test Setup

Below 30MHz Test Setup:

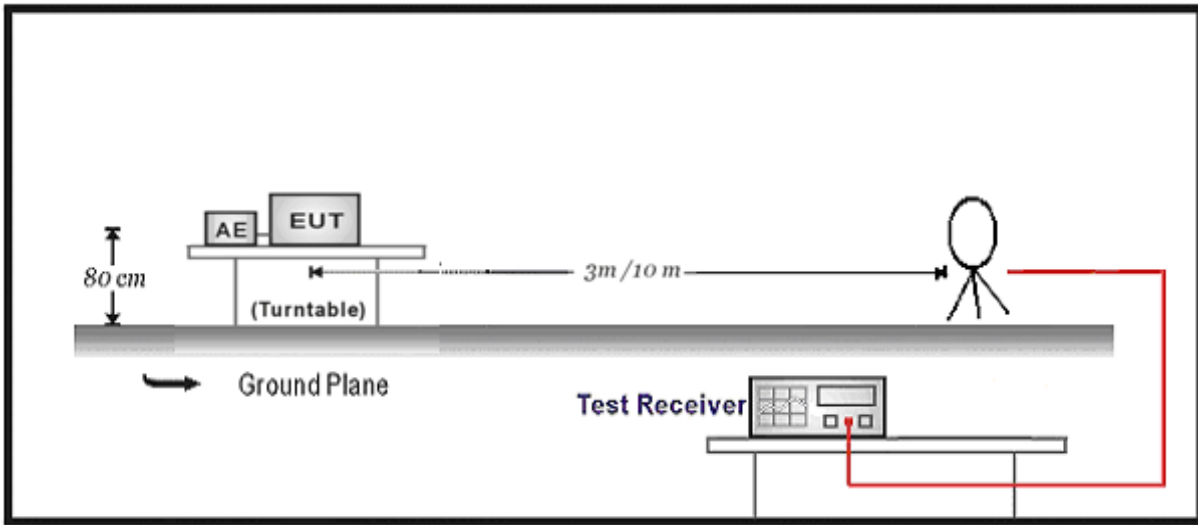

30MHz-1GHz Test Setup:

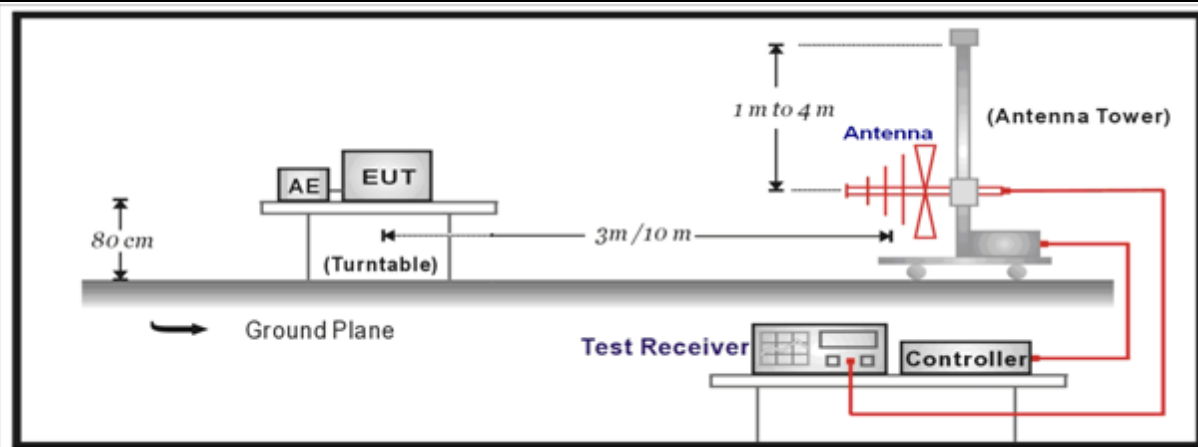

Above 1GHz Test Setup:

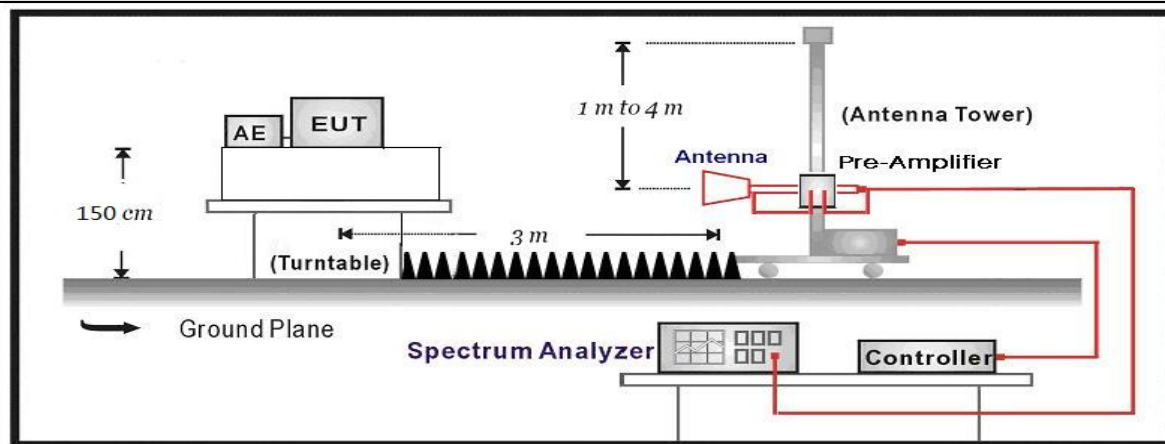

4.2.3 Test Procedure			
	References Rule	Chapter	Description
<input checked="" type="checkbox"/>	ANSI C63.10	11.12	Emissions in restricted frequency bands
	<input checked="" type="checkbox"/> ANSI C63.10	11.12.1	Radiated emission measurements
	<input checked="" type="checkbox"/> ANSI C63.10	11.12.2.7	Radiated spurious emission test
	<input checked="" type="checkbox"/> ANSI C63.10	6.4	Radiated emissions from unlicensed wireless devices below 30 MHz
	<input checked="" type="checkbox"/> ANSI C63.10	6.5	Radiated emissions from unlicensed wireless devices in the frequency range of 30 MHz to 1000 MHz
	<input checked="" type="checkbox"/> ANSI C63.10	6.6	Radiated emissions from unlicensed wireless devices above 1 GHz

4.2.4 Test Data

Profile: 2210113R	Page No.: 139
Engineer: Juliuszhou	
Site: AC5	Time: 2022/01/19 - 14:04
Limit: FCC_Part15.209_RE(3m)	Margin: 0
Probe: Horn_3117_00123988_(1-18GHz)	Polarity: Horizontal
EUT: BLUETOOTH HEADSET	Power: AC 120V/60Hz
Note: Mode 1:Transmit at 2402MHz by ble	

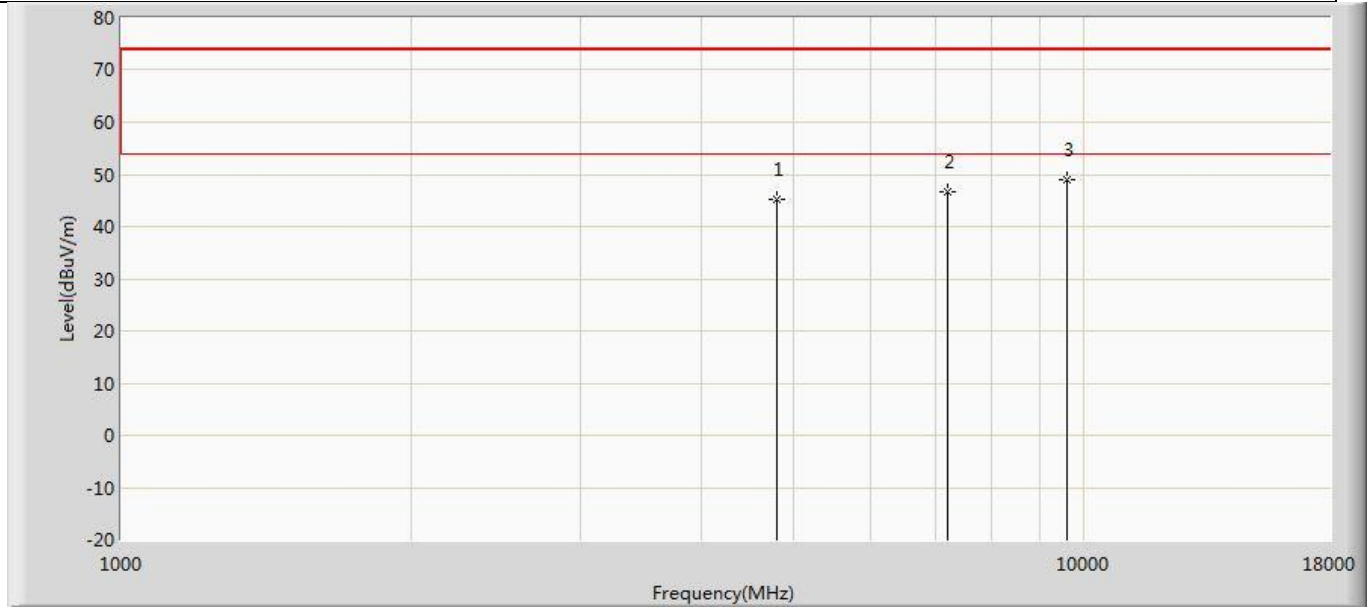

No	Mark	Frequency (MHz)	Measure Level (dBuV/m)	Reading Level (dBuV)	Over Limit (dB)	Limit (dBuV/m)	Factor (dB)	Type
1		4804.000	45.235	51.377	-28.765	74.000	-6.143	PK
2		7206.000	46.621	48.943	-27.379	74.000	-2.322	PK
3	*	9608.000	49.093	46.642	-24.907	74.000	2.451	PK

Profile: 2210113R	Page No.: 140
Engineer: Juliuszhou	
Site: AC5	Time: 2022/01/19 - 14:04
Limit: FCC_Part15.209_RE(3m)	Margin: 0
Probe: Horn_3117_00123988_(1-18GHz)	Polarity: Vertical
EUT: BLUETOOTH HEADSET	Power: AC 120V/60Hz
Note: Mode 1:Transmit at 2402MHz by ble	

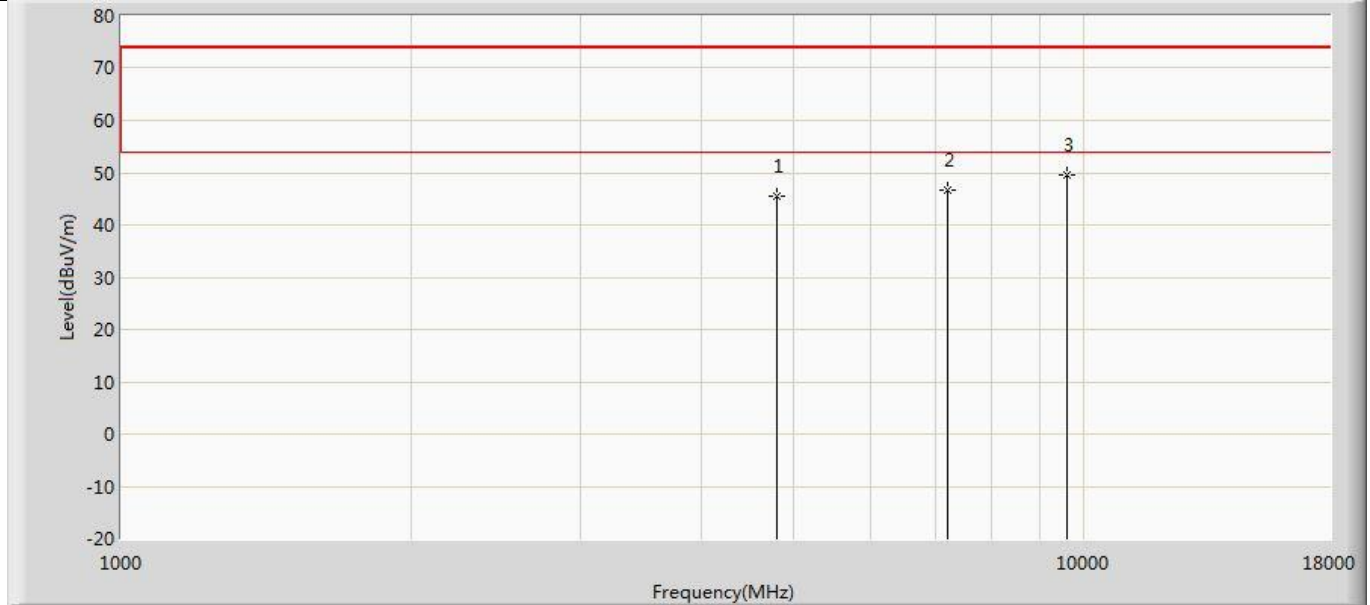

No	Mark	Frequency (MHz)	Measure Level (dBuV/m)	Reading Level (dBuV)	Over Limit (dB)	Limit (dBuV/m)	Factor (dB)	Type
1		4804.000	45.443	51.585	-28.557	74.000	-6.143	PK
2		7206.000	46.808	49.130	-27.192	74.000	-2.322	PK
3	*	9608.000	49.436	46.985	-24.564	74.000	2.451	PK

Profile: 2210113R	Page No.: 141
Engineer: Juliuszhou	
Site: AC5	Time: 2022/01/19 - 14:04
Limit: FCC_Part15.209_RE(3m)	Margin: 0
Probe: Horn_3117_00123988_(1-18GHz)	Polarity: Horizontal
EUT: BLUETOOTH HEADSET	Power: AC 120V/60Hz
Note: Mode 1:Transmit at 2440MHz by ble	

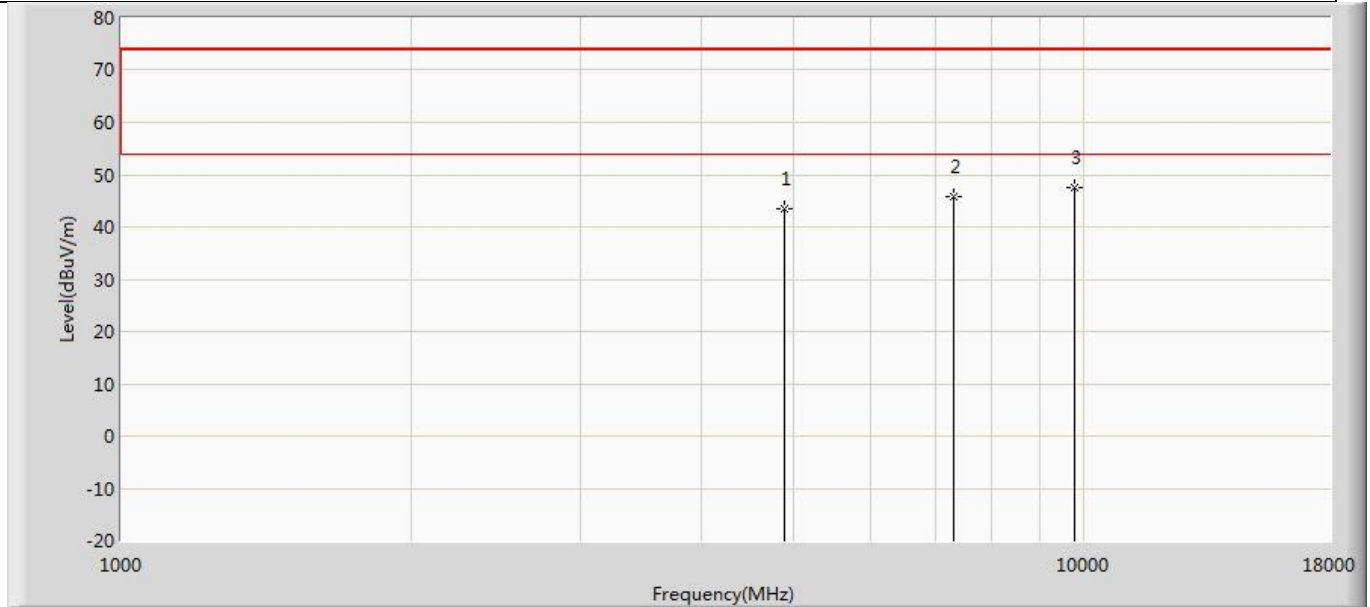

No	Mark	Frequency (MHz)	Measure Level (dBuV/m)	Reading Level (dBuV)	Over Limit (dB)	Limit (dBuV/m)	Factor (dB)	Type
1		4880.000	43.344	49.069	-30.656	74.000	-5.725	PK
2		7320.000	45.765	47.869	-28.235	74.000	-2.103	PK
3	*	9760.000	47.578	46.344	-26.422	74.000	1.234	PK

Profile: 2210113R	Page No.: 142
Engineer: Juliuszhou	
Site: AC5	Time: 2022/01/19 - 14:04
Limit: FCC_Part15.209_RE(3m)	Margin: 0
Probe: Horn_3117_00123988_(1-18GHz)	Polarity: Vertical
EUT: BLUETOOTH HEADSET	Power: AC 120V/60Hz
Note: Mode 1:Transmit at 2440MHz by ble	

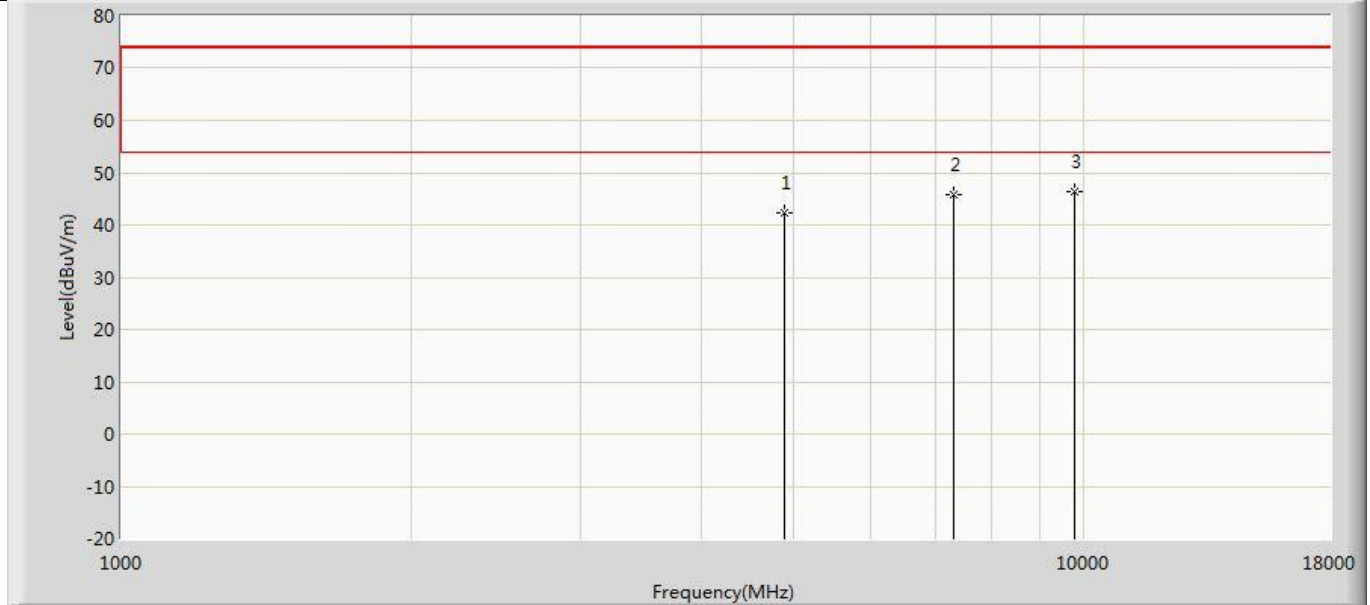

No	Mark	Frequency (MHz)	Measure Level (dBuV/m)	Reading Level (dBuV)	Over Limit (dB)	Limit (dBuV/m)	Factor (dB)	Type
1		4880.000	42.458	48.183	-31.542	74.000	-5.725	PK
2		7320.000	45.896	48.000	-28.104	74.000	-2.103	PK
3	*	9760.000	46.425	45.191	-27.575	74.000	1.234	PK

Profile: 2210113R	Page No.: 143
Engineer: Juliuszhou	
Site: AC5	Time: 2022/01/19 - 14:04
Limit: FCC_Part15.209_RE(3m)	Margin: 0
Probe: Horn_3117_00123988_(1-18GHz)	Polarity: Horizontal
EUT: BLUETOOTH HEADSET	Power: AC 120V/60Hz
Note: Mode 1:Transmit at 2480MHz by BLE	

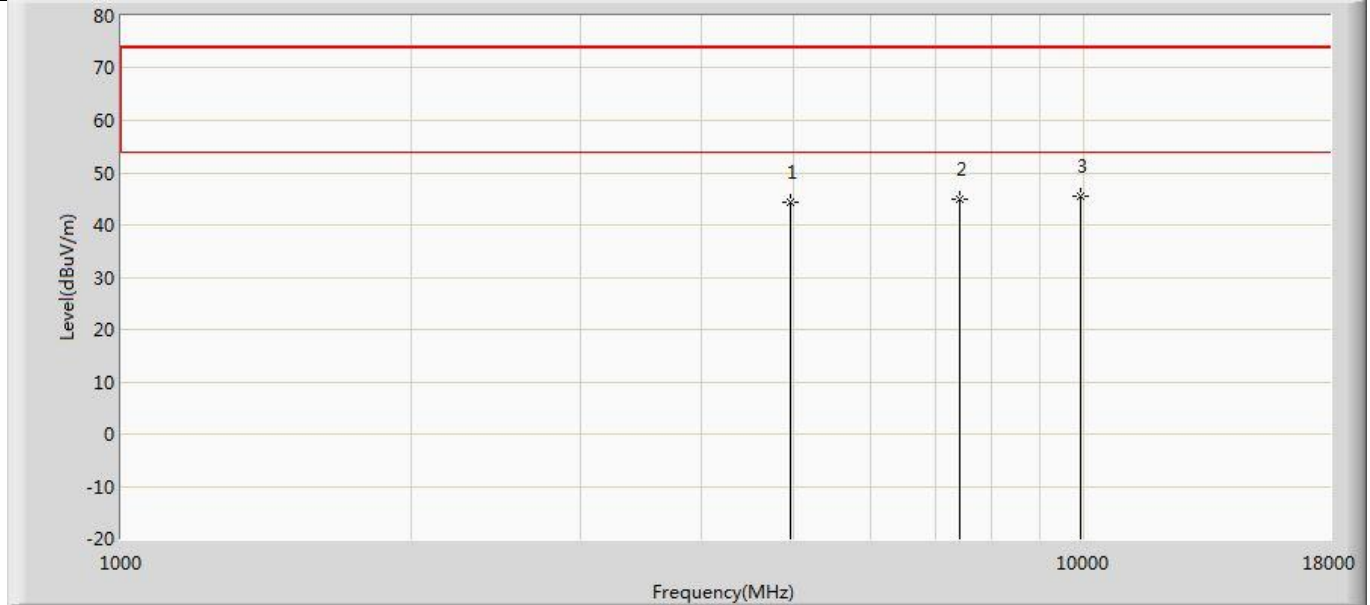

No	Mark	Frequency (MHz)	Measure Level (dBuV/m)	Reading Level (dBuV)	Over Limit (dB)	Limit (dBuV/m)	Factor (dB)	Type
1		4960.000	44.376	49.742	-29.624	74.000	-5.365	PK
2		7440.000	44.918	47.781	-29.082	74.000	-2.863	PK
3	*	9920.000	45.462	44.546	-28.538	74.000	0.916	PK

Profile: 2210113R	Page No.: 144
Engineer: Juliuszhou	
Site: AC5	Time: 2022/01/19 - 14:04
Limit: FCC_Part15.209_RE(3m)	Margin: 0
Probe: Horn_3117_00123988_(1-18GHz)	Polarity: Vertical
EUT: BLUETOOTH HEADSET	Power: AC 120V/60Hz
Note: Mode 1:Transmit at 2480MHz by BLE	

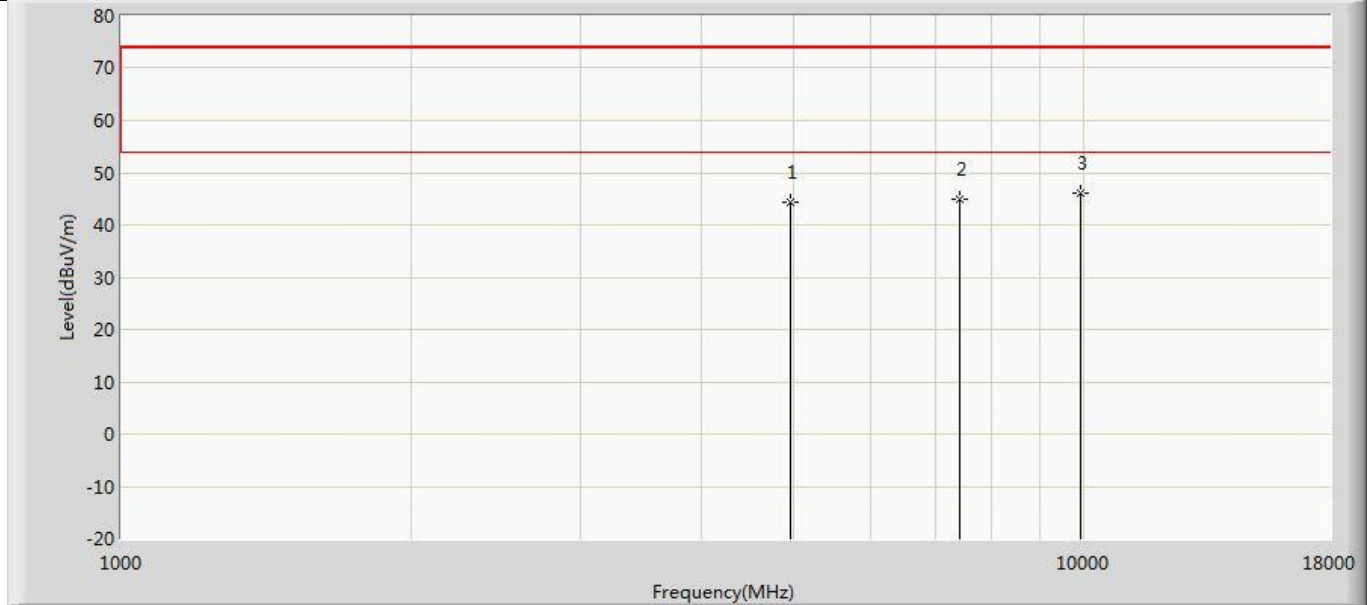

No	Mark	Frequency (MHz)	Measure Level (dBuV/m)	Reading Level (dBuV)	Over Limit (dB)	Limit (dBuV/m)	Factor (dB)	Type
1		4960.000	44.355	49.721	-29.645	74.000	-5.365	PK
2		7440.000	44.787	47.650	-29.213	74.000	-2.863	PK
3	*	9920.000	46.070	45.154	-27.930	74.000	0.916	PK

Profile: 2210113R	Page No.: 1
Engineer: Juliuszhou	
Site: AC5	Time: 2022/01/19 - 18:17
Limit: FCC_Part15.209_RE(3m)	Margin: 0
Probe: Horn_3117_00123988_(1-18GHz)	Polarity: Horizontal
EUT: BLUETOOTH HEADSET	Power: AC 120V/60Hz
Note: Mode 2:Transmit at 2402MHz by 2LE	

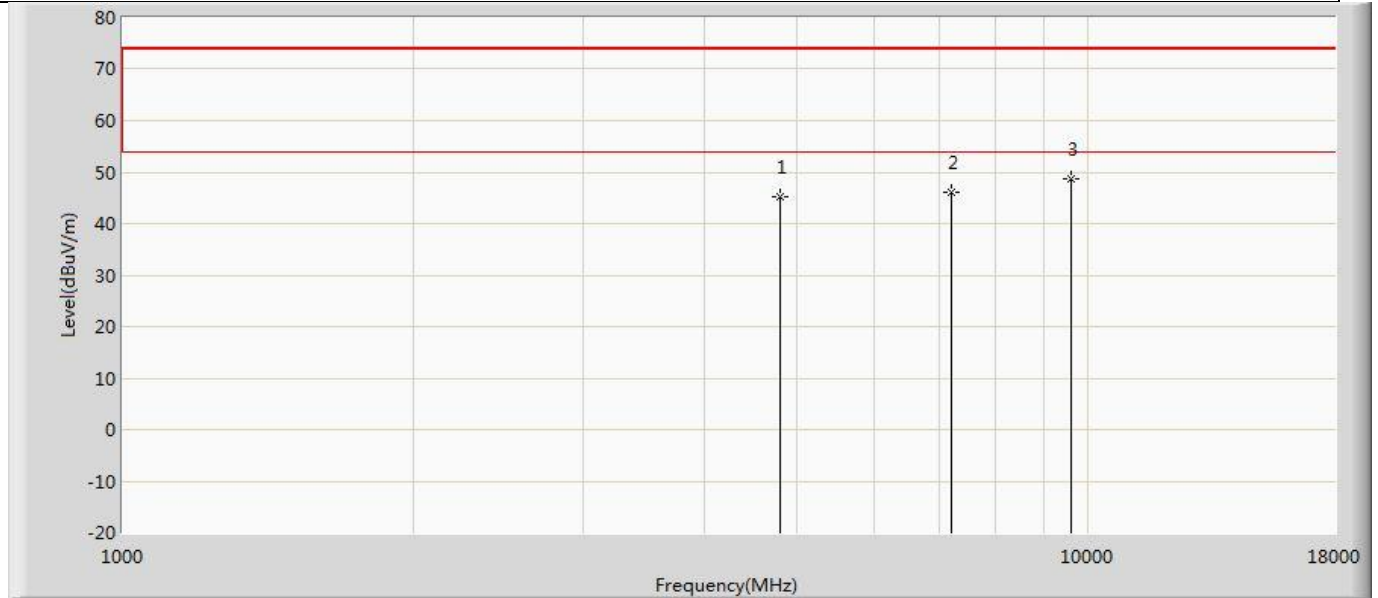

No	Mark	Frequency (MHz)	Measure Level (dBuV/m)	Reading Level (dBuV)	Over Limit (dB)	Limit (dBuV/m)	Factor (dB)	Type
1		4804.000	45.085	51.227	-28.915	74.000	-6.143	PK
2		7206.000	46.039	48.361	-27.961	74.000	-2.322	PK
3	*	9608.000	48.755	46.304	-25.245	74.000	2.451	PK

Profile: 2210113R	Page No.: 2
Engineer: Juliuszhou	
Site: AC5	Time: 2022/01/19 - 18:17
Limit: FCC_Part15.209_RE(3m)	Margin: 0
Probe: Horn_3117_00123988_(1-18GHz)	Polarity: Vertical
EUT: BLUETOOTH HEADSET	Power: AC 120V/60Hz
Note: Mode 2:Transmit at 2402MHz by 2LE	

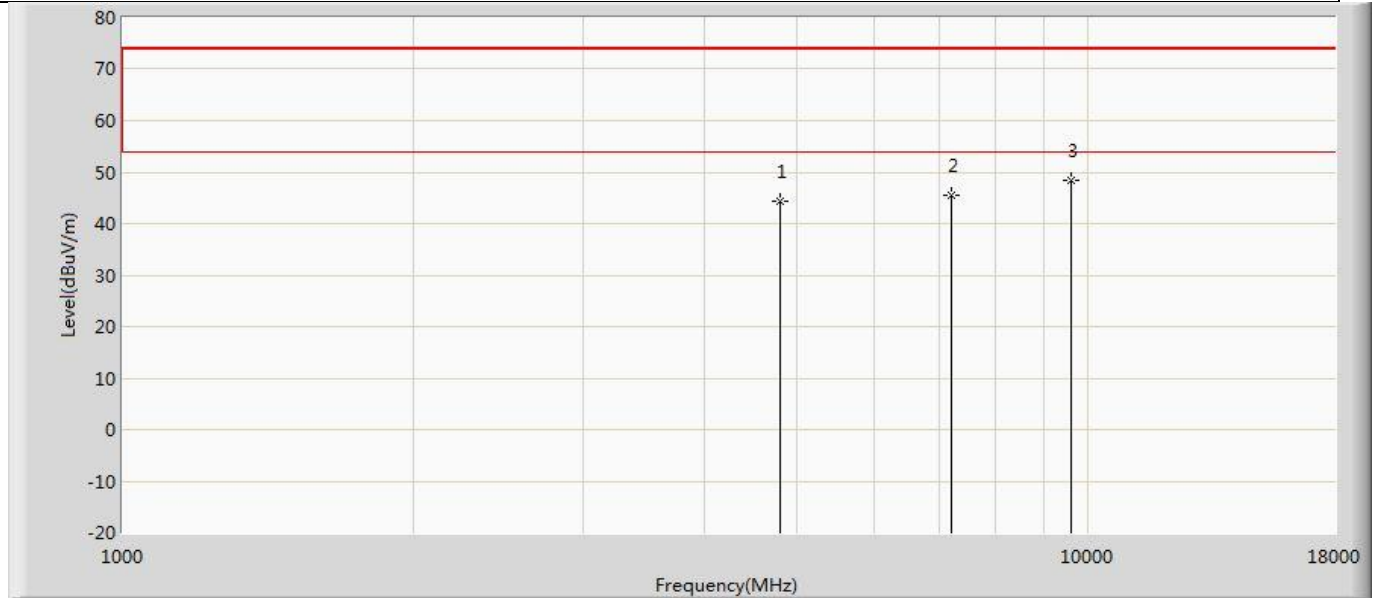

No	Mark	Frequency (MHz)	Measure Level (dBuV/m)	Reading Level (dBuV)	Over Limit (dB)	Limit (dBuV/m)	Factor (dB)	Type
1		4804.000	44.399	50.541	-29.601	74.000	-6.143	PK
2		7206.000	45.553	47.875	-28.447	74.000	-2.322	PK
3	*	9608.000	48.469	46.018	-25.531	74.000	2.451	PK

Profile: 2210113R	Page No.: 3
Engineer: Juliuszhou	
Site: AC5	Time: 2022/01/19 - 18:17
Limit: FCC_Part15.209_RE(3m)	Margin: 0
Probe: Horn_3117_00123988_(1-18GHz)	Polarity: Horizontal
EUT: BLUETOOTH HEADSET	Power: AC 120V/60Hz
Note: Mode 2:Transmit at 2440MHz by 2LE	

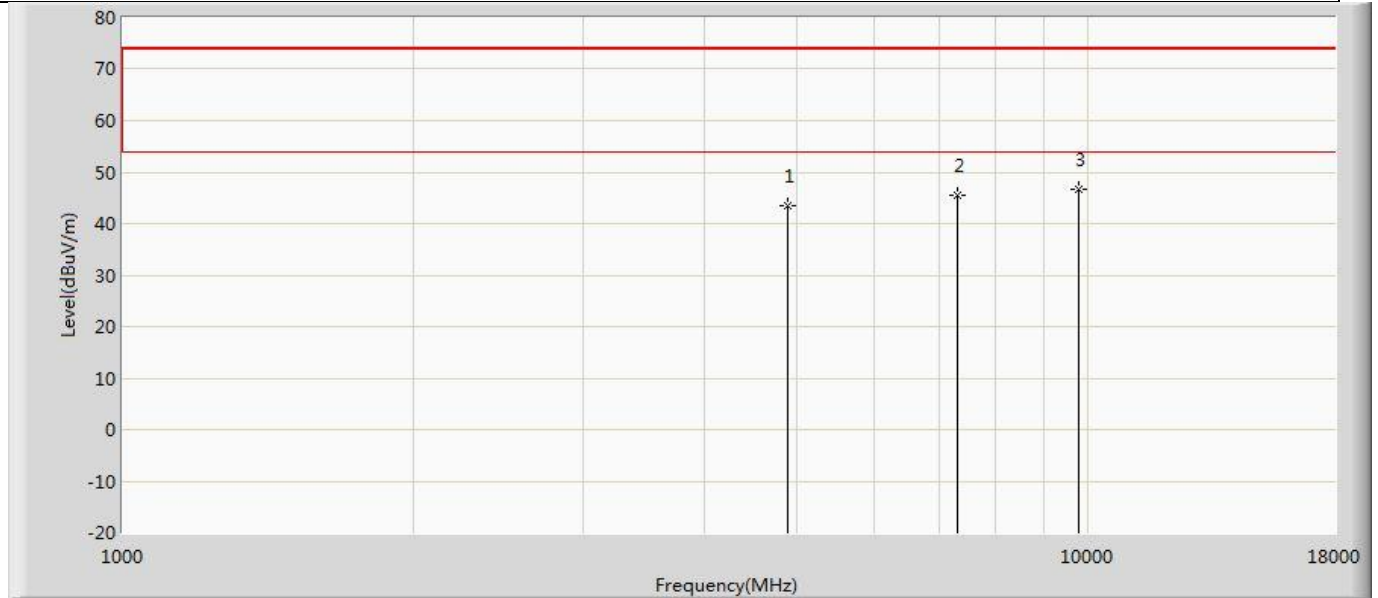

No	Mark	Frequency (MHz)	Measure Level (dBuV/m)	Reading Level (dBuV)	Over Limit (dB)	Limit (dBuV/m)	Factor (dB)	Type
1		4880.000	43.416	49.141	-30.584	74.000	-5.725	PK
2		7320.000	45.409	47.513	-28.591	74.000	-2.103	PK
3	*	9760.000	46.610	45.376	-27.390	74.000	1.234	PK

Profile: 2210113R	Page No.: 4
Engineer: Juliuszhou	
Site: AC5	Time: 2022/01/19 - 18:17
Limit: FCC_Part15.209_RE(3m)	Margin: 0
Probe: Horn_3117_00123988_(1-18GHz)	Polarity: Vertical
EUT: BLUETOOTH HEADSET	Power: AC 120V/60Hz
Note: Mode 2:Transmit at 2440MHz by 2LE	

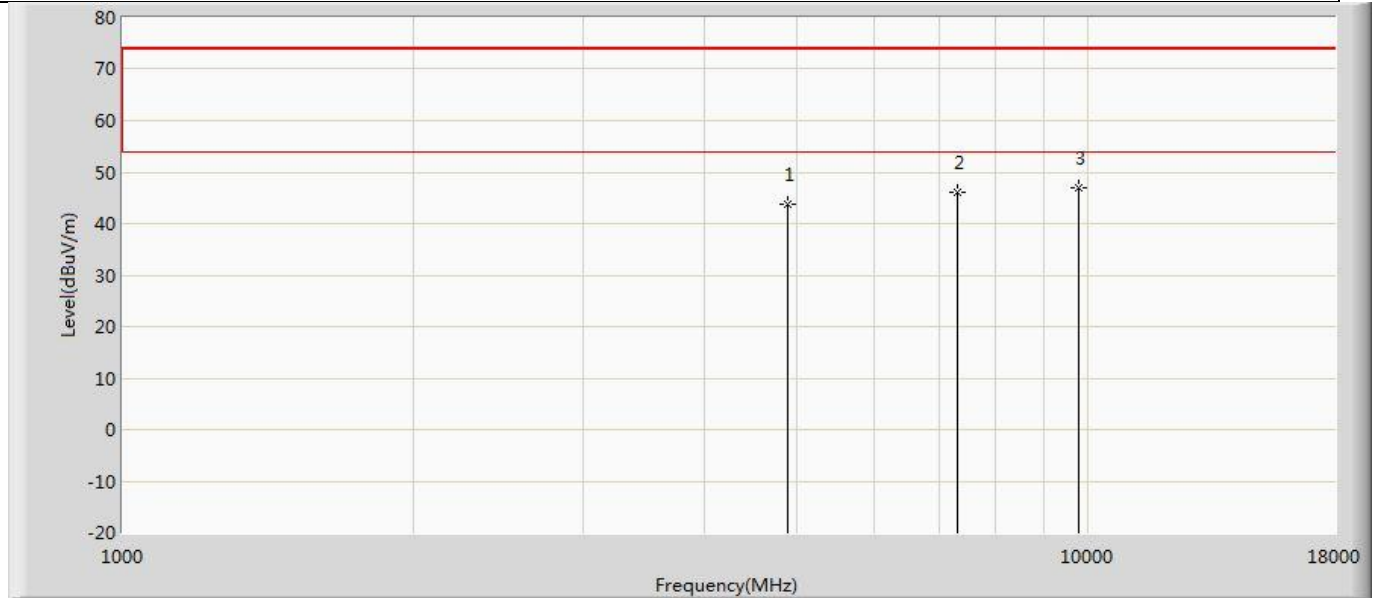

No	Mark	Frequency (MHz)	Measure Level (dBuV/m)	Reading Level (dBuV)	Over Limit (dB)	Limit (dBuV/m)	Factor (dB)	Type
1		4880.000	43.665	49.390	-30.335	74.000	-5.725	PK
2		7320.000	46.047	48.151	-27.953	74.000	-2.103	PK
3	*	9760.000	46.906	45.672	-27.094	74.000	1.234	PK

Profile: 2210113R	Page No.: 5
Engineer: Juliuszhou	
Site: AC5	Time: 2022/01/19 - 18:17
Limit: FCC_Part15.209_RE(3m)	Margin: 0
Probe: Horn_3117_00123988_(1-18GHz)	Polarity: Horizontal
EUT: BLUETOOTH HEADSET	Power: AC 120V/60Hz
Note: Mode 2:Transmit at 2480MHz by 2LE	

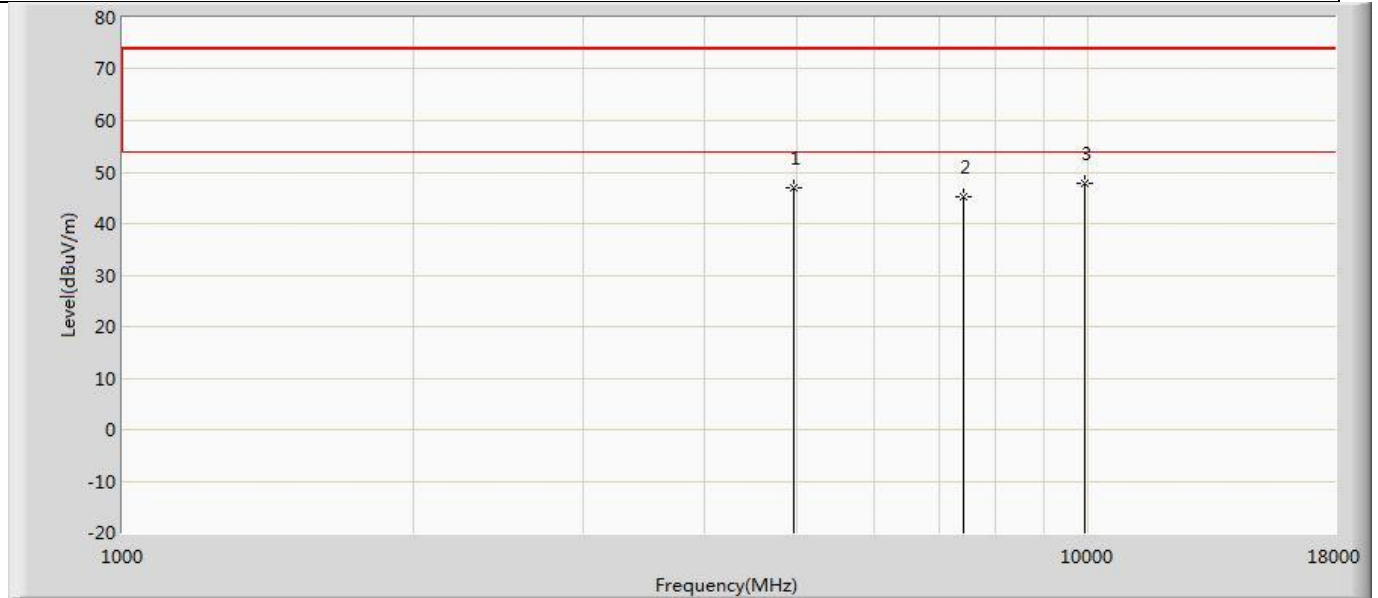

No	Mark	Frequency (MHz)	Measure Level (dBuV/m)	Reading Level (dBuV)	Over Limit (dB)	Limit (dBuV/m)	Factor (dB)	Type
1		4960.000	46.912	52.278	-27.088	74.000	-5.365	PK
2		7440.000	45.324	48.187	-28.676	74.000	-2.863	PK
3	*	9920.000	47.722	46.806	-26.278	74.000	0.916	PK

Profile: 2210113R	Page No.: 6
Engineer: Juliuszhou	
Site: AC5	Time: 2022/01/19 - 18:17
Limit: FCC_Part15.209_RE(3m)	Margin: 0
Probe: Horn_3117_00123988_(1-18GHz)	Polarity: Vertical
EUT: BLUETOOTH HEADSET	Power: AC 120V/60Hz
Note: Mode 2:Transmit at 2480MHz by 2LE	

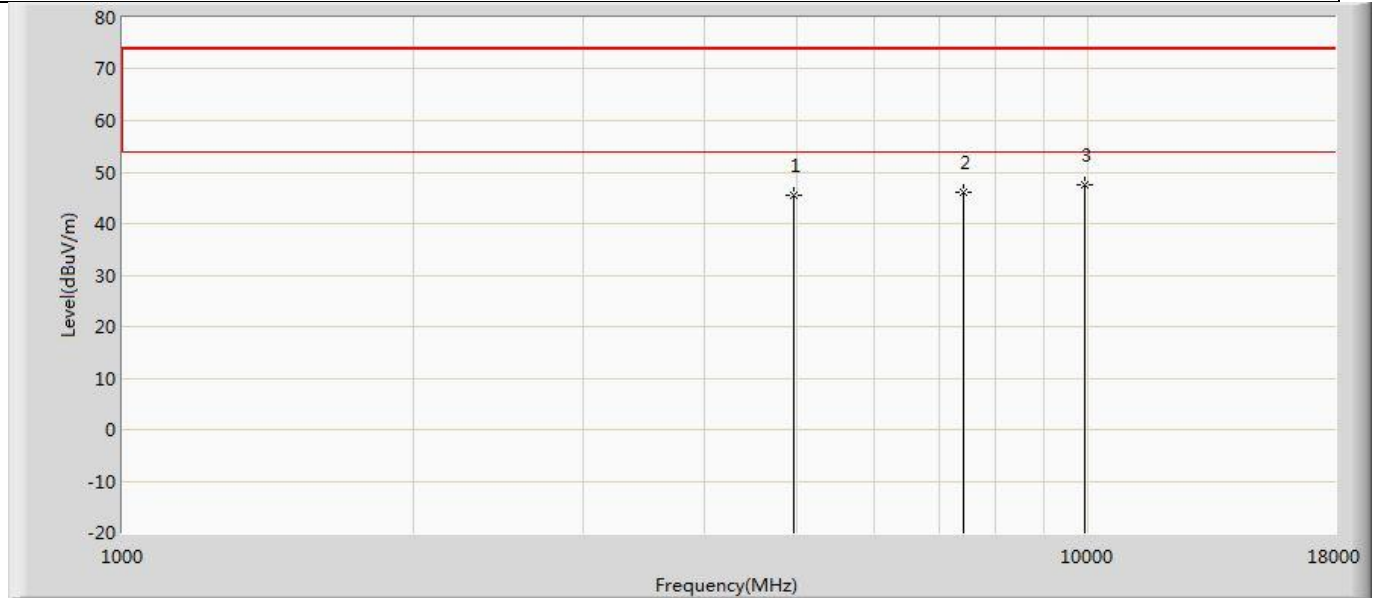

No	Mark	Frequency (MHz)	Measure Level (dBuV/m)	Reading Level (dBuV)	Over Limit (dB)	Limit (dBuV/m)	Factor (dB)	Type
1		4960.000	45.459	50.825	-28.541	74.000	-5.365	PK
2		7440.000	46.136	48.999	-27.864	74.000	-2.863	PK
3	*	9920.000	47.498	46.582	-26.502	74.000	0.916	PK

Note:

1. Measured Level = Reading Level + Factor.
2. The test frequency range, 9kHz~30MHz, worst case are at least 20dB below the limits, therefore no data appear in the report.
3. The test frequency range, 18GHz~26GHz test result on peak is lower than average limit, all is the noise base, therefore no data appear in the report.
4. This limit applies for using average detector, if the test result on peak is lower than average limit, then average measurement needn't be performed.
5. As the radiated emission was performed, so conducted emission was not tested.

The worst case of Radiated Emission below 1GHz:

Profile: 2210113R	Page No.: 37
Engineer: Carlos shen	
Site: AC2	Time: 2022/01/19 - 04:02
Limit: FCC_Part15.209_RE(3m)	Margin: 0
Probe: AC2_3M(30-1000M)	Polarity: Horizontal
EUT: Bluetooth headset	Power: AC 120V/60Hz
Note: Mode1 : Transmit at 2402MHz by BLE	

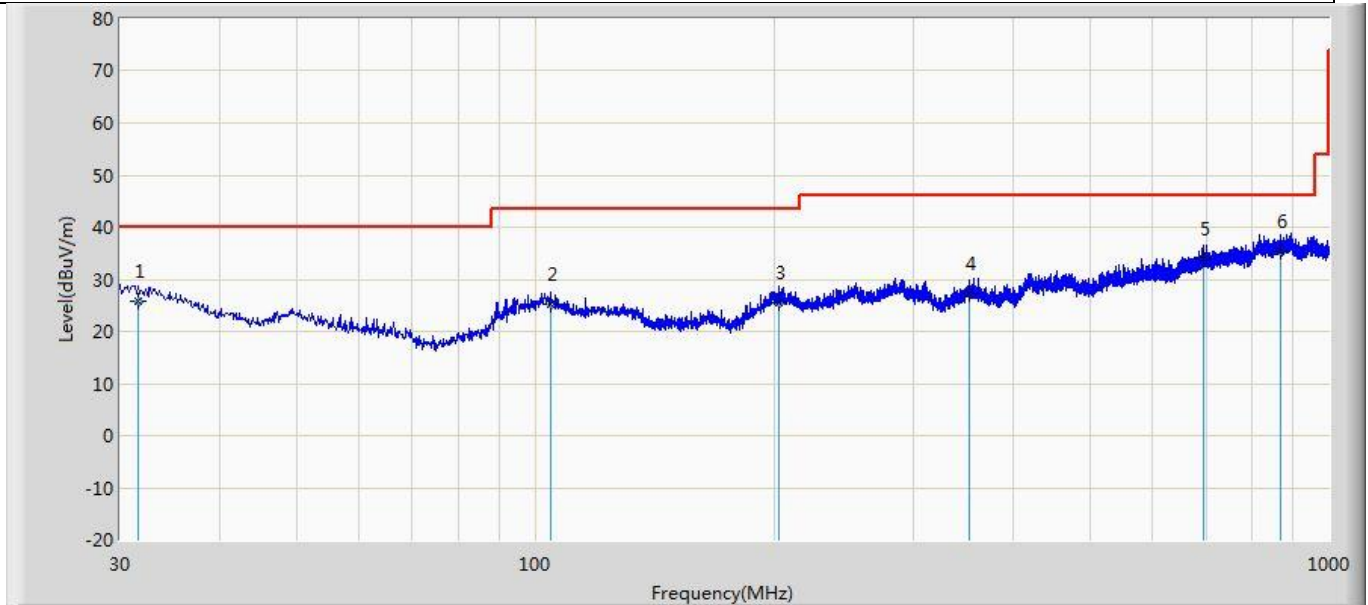

No	Mark	Frequency (MHz)	Measure Level (dBuV/m)	Reading Level (dBuV)	Over Limit (dB)	Limit (dBuV/m)	Probe (dB/m)	Cable (dB)	Amp (dB)	Ant Pos (cm)	Table Pos (deg)	Type
1		31.576	25.770	2.310	-14.230	40.000	17.149	6.311	0.000	100	222	QP
2		104.448	25.244	3.012	-18.256	43.500	15.478	6.754	0.000	200	130	QP
3		202.539	25.565	2.140	-17.935	43.500	16.247	7.178	0.000	100	254	QP
4		351.555	27.275	2.325	-18.725	46.000	17.260	7.690	0.000	100	19	QP
5		694.450	34.032	3.500	-11.968	46.000	21.902	8.630	0.000	100	86	QP
6	*	870.626	35.331	2.420	-10.669	46.000	23.895	9.016	0.000	100	107	QP

Note:

1. All Readings below 1GHz are Quasi-Peak, above are performed with peak and/or average measurements as necessary.
2. " * ", means this data is the worst emission level.
3. Measurement Level = Reading Level + Factor(Probe+Cable-Amp)

Profile: 2210113R	Page No.: 38
Engineer: Carlos shen	
Site: AC2	Time: 2022/01/19 - 04:03
Limit: FCC_Part15.209_RE(3m)	Margin: 0
Probe: AC2_3M(30-1000M)	Polarity: Vertical
EUT: Bluetooth headset	Power: AC 120V/60Hz
Note: Mode1 : Transmit at 2402MHz by BLE	

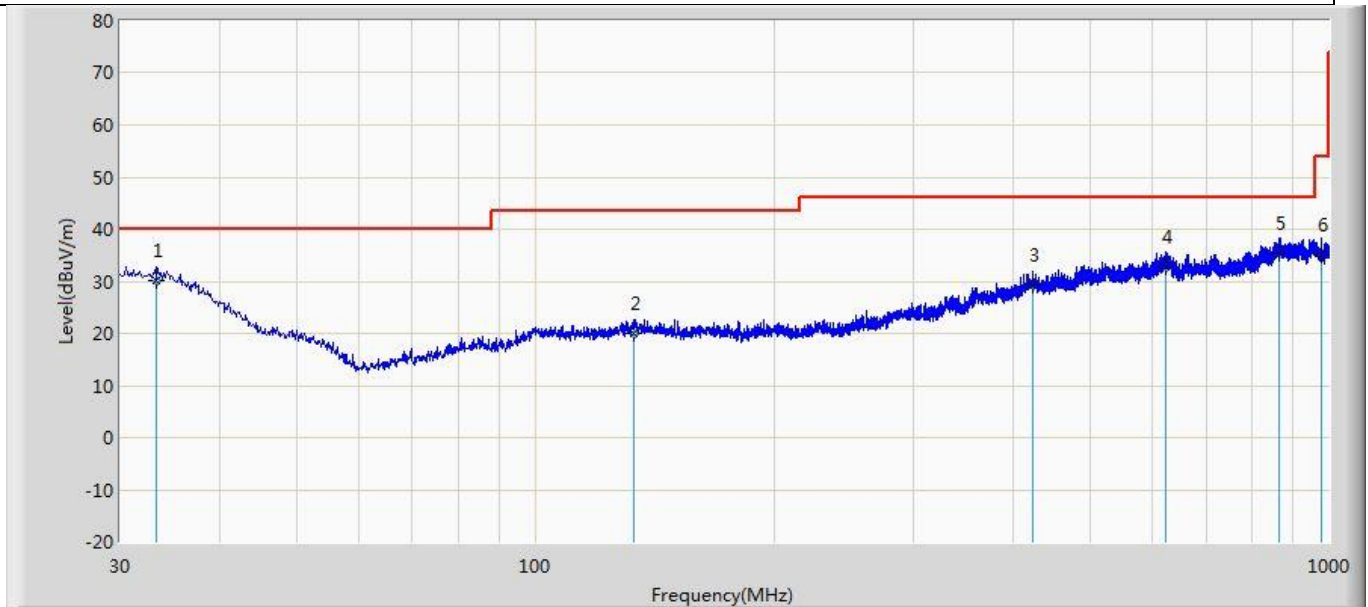

No	Mark	Frequency (MHz)	Measure Level (dBuV/m)	Reading Level (dBuV)	Over Limit (dB)	Limit (dBuV/m)	Probe (dB/m)	Cable (dB)	Amp (dB)	Ant Pos (cm)	Table Pos (deg)	Type
1	*	33.274	30.139	3.102	-9.861	40.000	20.712	6.324	0.000	100	14	QP
2		132.941	20.069	2.421	-23.431	43.500	10.754	6.894	0.000	100	325	QP
3		423.092	29.280	2.100	-16.720	46.000	19.281	7.899	0.000	200	143	QP
4		623.516	32.624	2.010	-13.376	46.000	22.186	8.427	0.000	100	241	QP
5		864.806	35.329	2.536	-10.671	46.000	23.786	9.007	0.000	100	56	QP
6		977.205	34.937	3.012	-19.063	54.000	22.659	9.266	0.000	100	267	QP

Note:

1. All Readings below 1GHz are Quasi-Peak, above are performed with peak and/or average measurements as necessary.
2. " * ", means this data is the worst emission level.
3. Measurement Level = Reading Level + Factor(Probe+Cable-Amp)

4.3 Emissions in non-restricted frequency band	VERDICT: PASS
---	----------------------

4.3.1 Limit	
Standard	FCC Part 15 Subpart C Paragraph 15.247(d)
RF Output power (Detection methods)	Limit(dB)
RF Output power(Average detector)	30dBc(Note1)
RF Output power(PK detector)	20dBc(Note2)
<p>Note 1: If maximum conducted (average) output power was used to demonstrate compliance as described in 9.2, then the peak power in any 100 kHz bandwidth outside of the authorized frequency band shall be attenuated by at least 30 dB relative to the maximum in-band peak PSD level in 100 kHz (i.e., 30 dBc).</p> <p>Note 2: If the maximum peak conducted output power procedure was used, then the peak output power measured in any 100 kHz bandwidth outside of the authorized frequency band shall be attenuated by at least 20 dB relative to the maximum in-band peak PSD level in 100 kHz (i.e., 20 dBc).</p>	

4.3.2 Test Setup

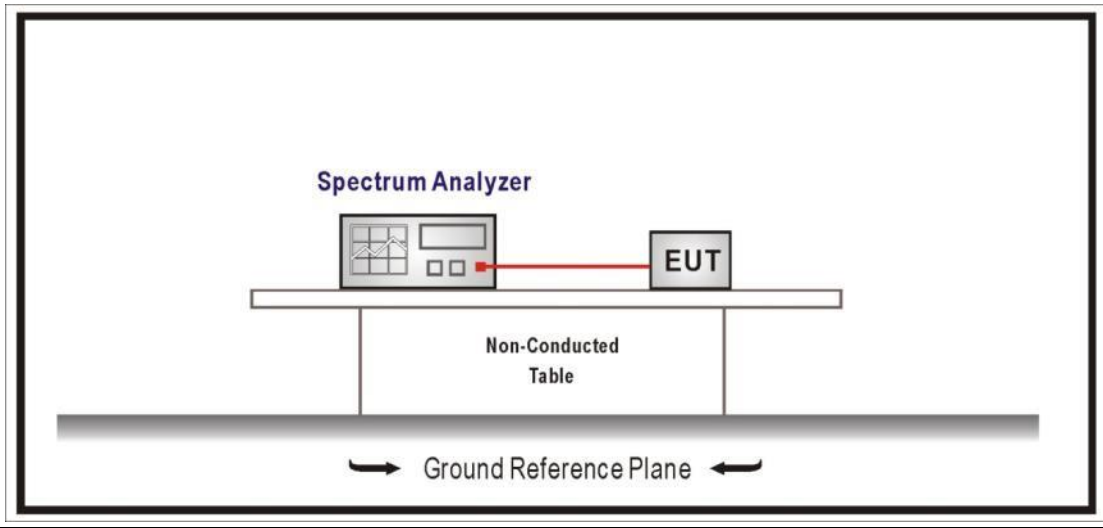

4.3.3 Test Procedure

References Rule	Chapter	Description
<input checked="" type="checkbox"/> ANSI C63.10	11.11	Emissions in non-restricted frequency bands
<input checked="" type="checkbox"/> ANSI C63.10	11.11.1	General
<input checked="" type="checkbox"/> ANSI C63.10	11.11.2	Reference level measurement
<input checked="" type="checkbox"/> ANSI C63.10	11.11.3	Emission level measurement

4.3.4 Test Data

Mode	Channel	Test Frequency (MHz)	Maximum In-Band PSD[a] (dBm/100kHz)	Frequency (MHz)	Out-Band PSD[b] (dBm/100kHz)	[a]-[b] (dB)	Limit (dB)	Result
1	00	2402	4.359	2393.945	-51.648	56.007	≥20	Pass
	39	2480	4.209	2500	-63.314	67.523	≥20	Pass
2	00	2402	4.348	2400	-27.328	31.676	≥20	Pass
	39	2480	4.155	2500	-64.960	69.115	≥20	Pass

Note: The worst case of emissions in non-restricted frequency bands as below:

Mode 2 CH00(2402MHz)

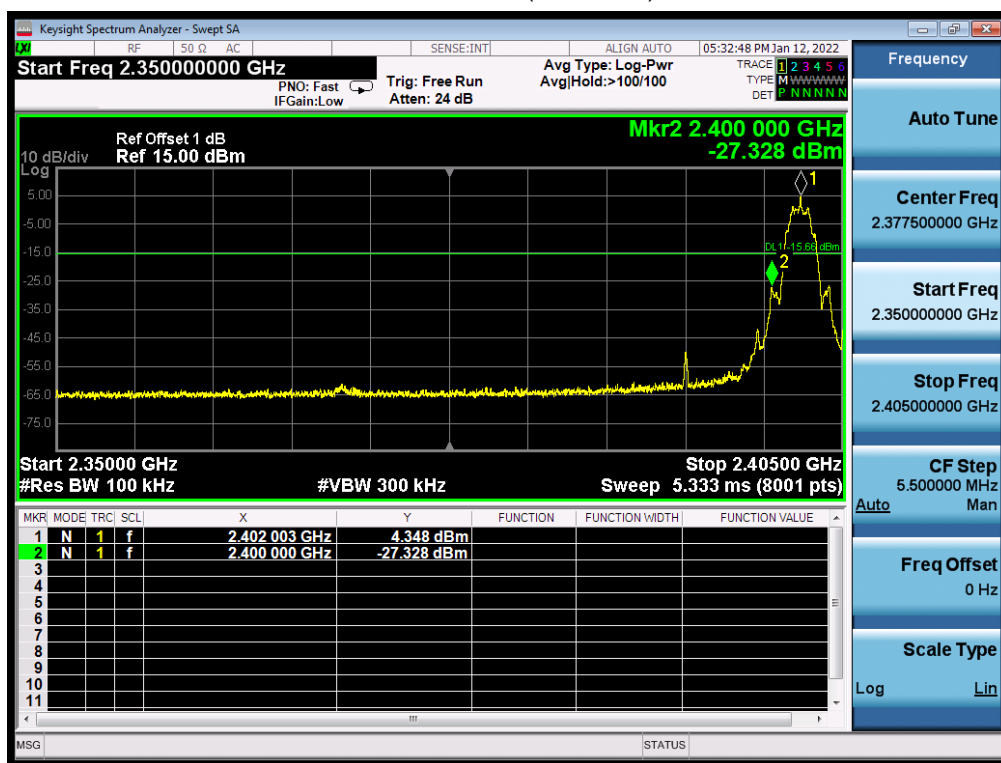

The data of entire corresponding spectrum:

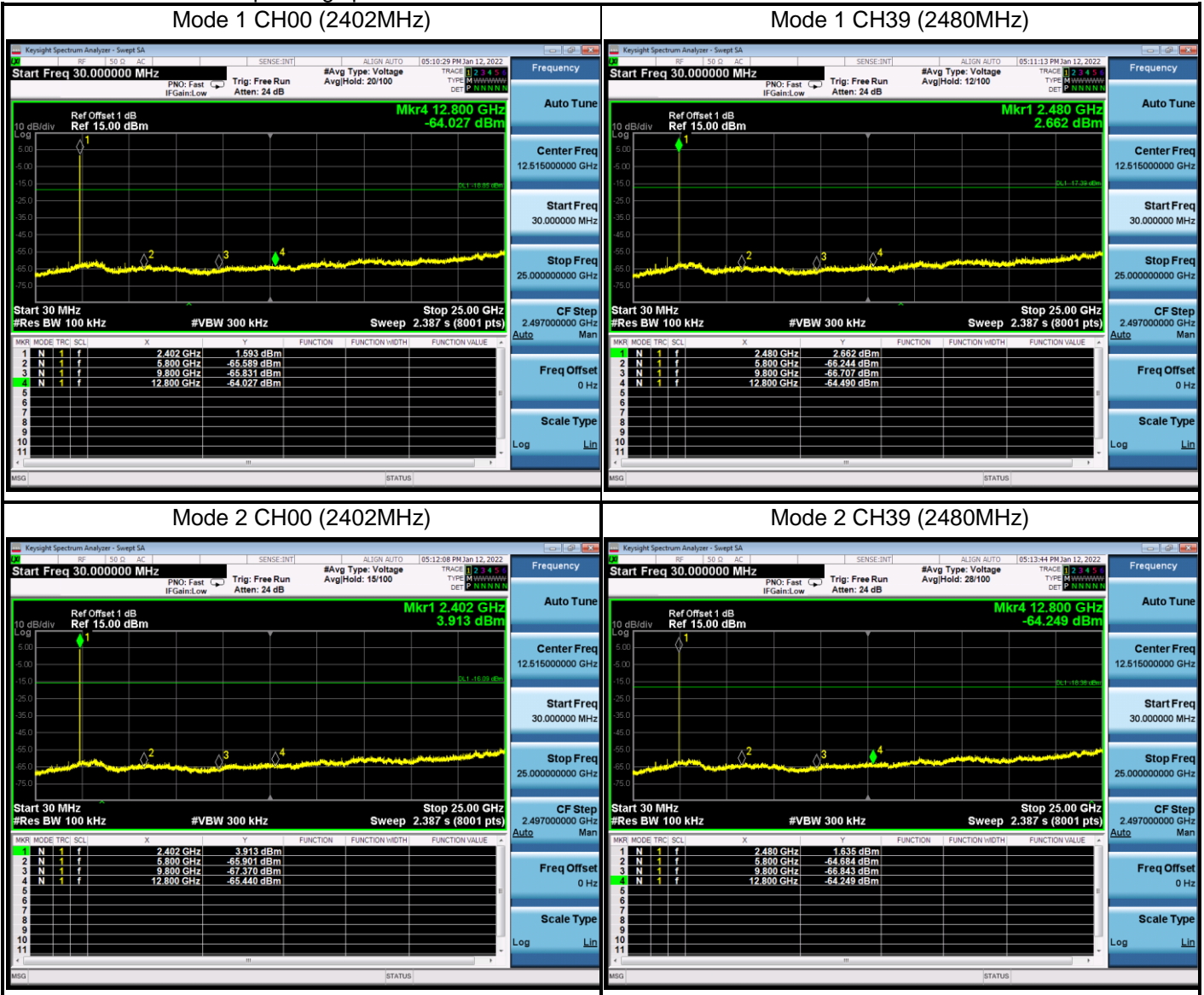

4.4 Duty cycle	VERDICT: PASS
-----------------------	----------------------

4.4.1 Limit
N/A

4.4.2 Test Setup

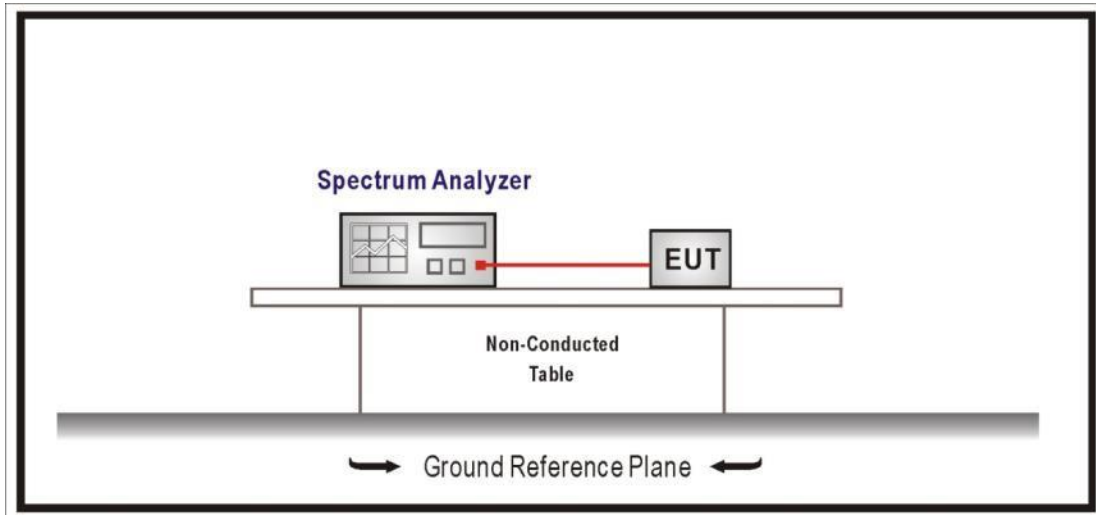

4.4.3 Test Procedure

References Rule	Chapter	Description
<input checked="" type="checkbox"/> ANSI C63.10	11.6	Duty cycle (D), transmission duration (T), and maximum power control level

4.4.4 Test Data

Test Mode	Tx On (us)	Tx Off (us)	VBW (kHz)	Tx On + Tx Off (us)	Duty Cycle (%)
Mode 1	0.38	0.244	3	0.624	60.9
Mode 1	0.198	0.426	5	0.624	31.7

Note 1: T means the minimum transmission duration over which the transmitter is on and is transmitting at its maximum power control level for the tested mode of operation.

Note 2: According to KDB 558074, when test for Radiated Emission Band Edge and Radiated Emission, for average detector set: $VBW \geq 1/T$ will be used.

Mode 1 CH19 2440MHz

Mode 2 CH19 2440MHz

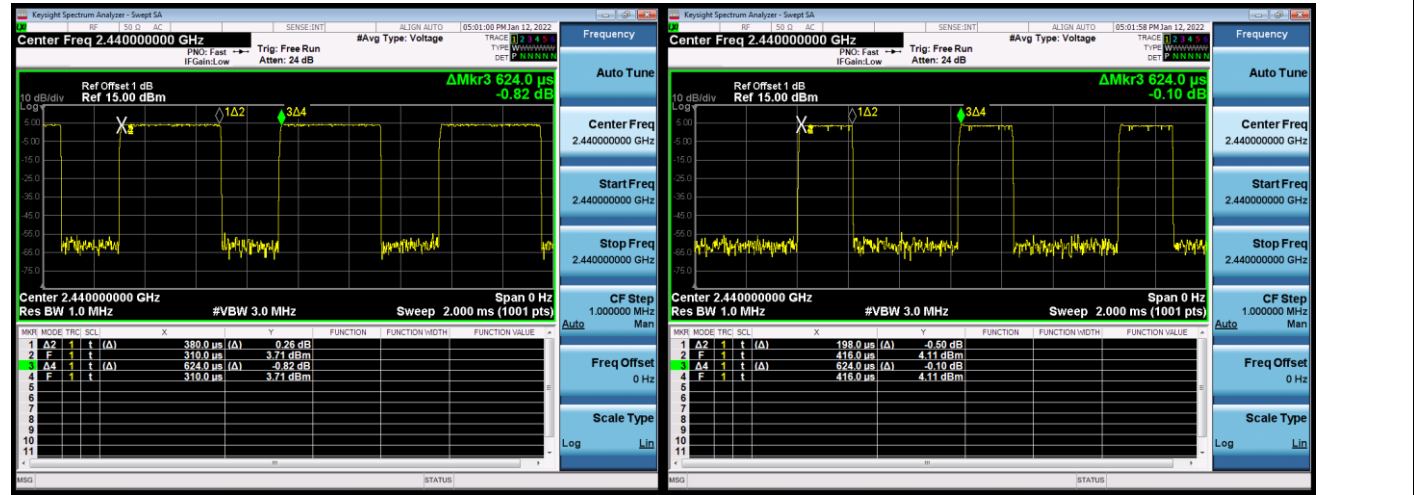

4.5 Band Edge	VERDICT: PASS
----------------------	----------------------

4.5.1 Limit

Standard		FCC Part 15 Subpart C Paragraph 15.247(d) ,15.209		
Frequency bands (MHz)	Detector	Limit (dBμV/m)	RBW (MHz)	Distance (m)
2310-2390	PK	74	1	3
2483.5-2500	AV	54	1	3

Note: The field strength of emissions appearing within these frequency bands shall not exceed the limits.

4.5.2 Test Setup

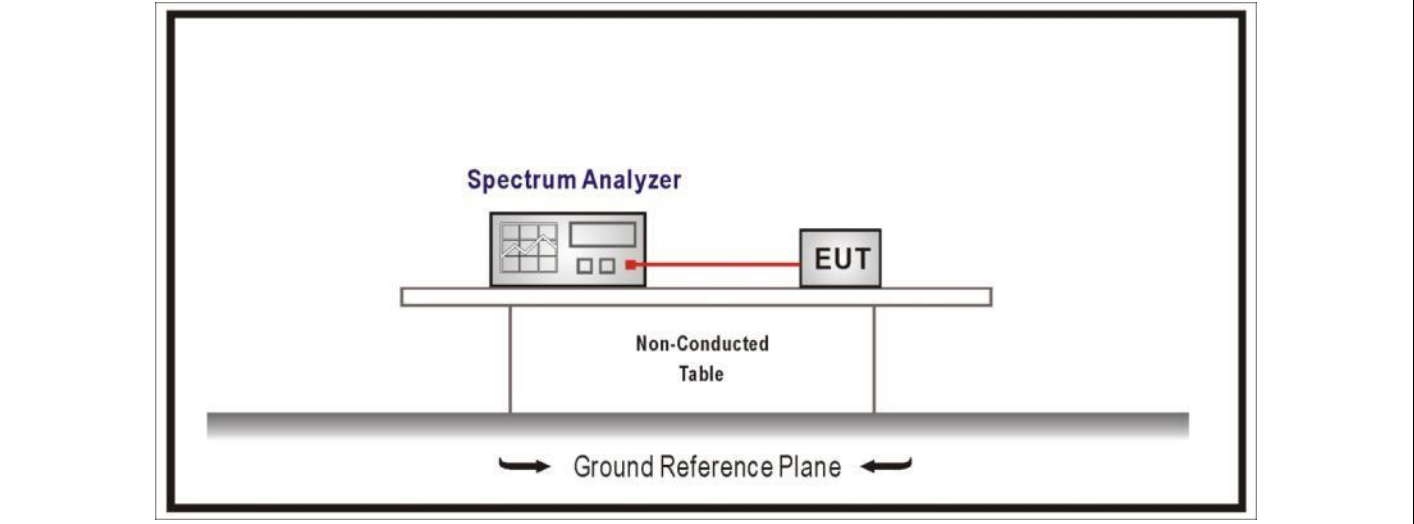

4.5.3 Test Procedure

	References Rule	Chapter	Description
<input checked="" type="checkbox"/>	ANSI C63.10	6.10	Band-edge testing
	<input checked="" type="checkbox"/> ANSI C63.10	6.10.5	Restricted-band band-edge measurements
	<input type="checkbox"/> ANSI C63.10	6.10.6	Marker-delta method
<input checked="" type="checkbox"/>	ANSI C63.10	11.12	Emissions in restricted frequency bands
	<input checked="" type="checkbox"/> ANSI C63.10	11.12.2	Antenna-port conducted measurements
	<input type="checkbox"/> ANSI C63.10	11.12.2.3	Quasi-peak measurement procedure
	<input checked="" type="checkbox"/> ANSI C63.10	11.12.2.4	Peak power measurement procedure
	<input checked="" type="checkbox"/> ANSI C63.10	11.12.2.5	Average power measurement procedures

4.5.4 Test Data

Profile: 2210113R	Page No.: 1
Engineer: Juliuszhou	
Site: AC5	Time: 2022/01/18 - 00:39
Limit: FCC_Part15.209_RE(3m)	Margin: 0
Probe: Horn_3117_00123988_(1-18GHz)	Polarity: Vertical
EUT: Bluetooth headset	Power: AC 120V/60Hz
Note: Mode 1:Transmit at 2402MHz by LE_1Mbps	

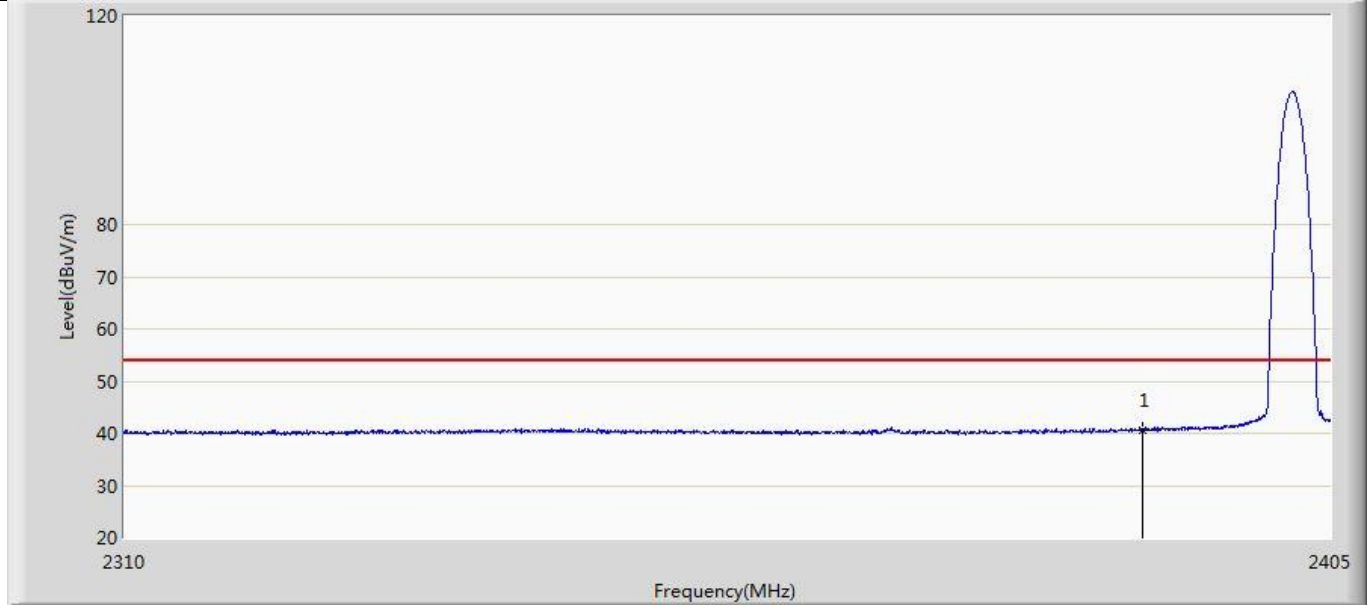

No	Mark	Frequency (MHz)	Measure Level (dBuV/m)	Reading Level (dBuV)	Over Limit (dB)	Limit (dBuV/m)	Factor (dB)	Type
1	*	2390.000	40.622	5.163	-13.378	54.000	35.459	AV

Profile: 2210113R	Page No.: 2
Engineer: Juliuszhou	
Site: AC5	Time: 2022/01/18 - 20:16
Limit: FCC_Part15.209_RE(3m)	Margin: 0
Probe: Horn_3117_00123988_(1-18GHz)	Polarity: Vertical
EUT: Bluetooth headset	Power: AC 120V/60Hz
Note: Mode 1:Transmit at 2402MHz by LE_1Mbps	

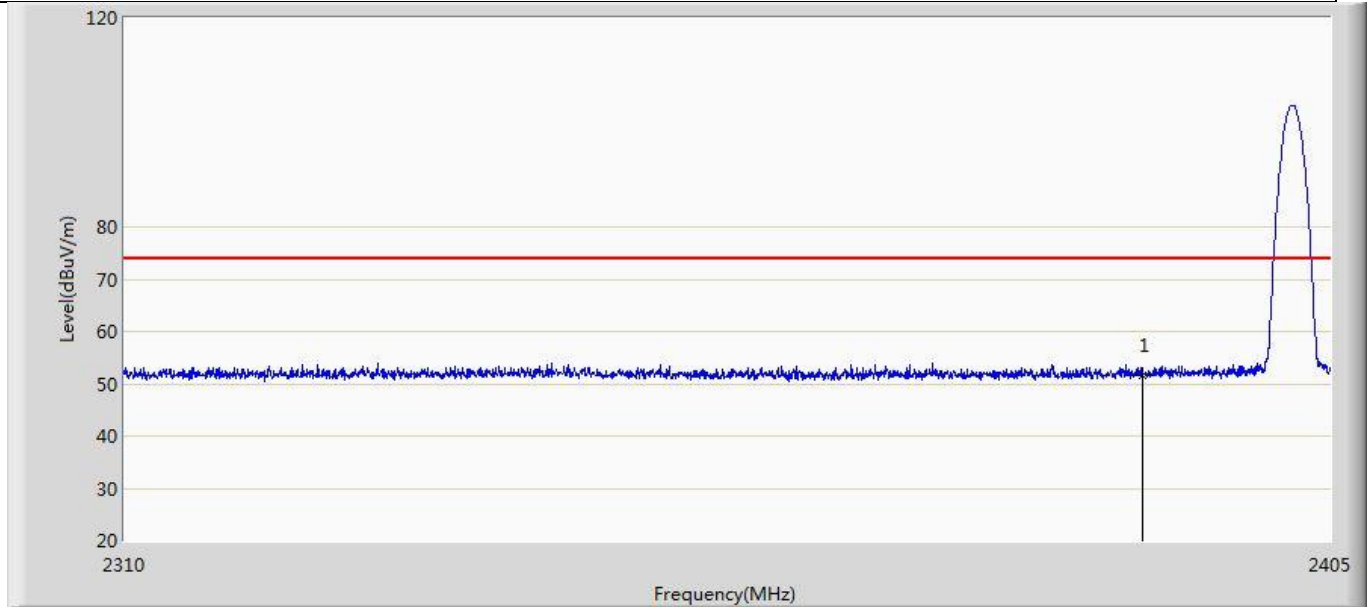

No	Mark	Frequency (MHz)	Measure Level (dBuV/m)	Reading Level (dBuV)	Over Limit (dB)	Limit (dBuV/m)	Factor (dB)	Type
1	*	2390.000	51.527	16.068	-22.473	74.000	35.459	PK

Profile: 2210113R	Page No.: 3
Engineer: Juliuszhou	
Site: AC5	Time: 2022/01/18 - 20:20
Limit: FCC_Part15.209_RE(3m)	Margin: 0
Probe: Horn_3117_00123988_(1-18GHz)	Polarity: Horizontal
EUT: Bluetooth headset	Power: AC 120V/60Hz
Note: Mode 1:Transmit at 2402MHz by LE_1Mbps	

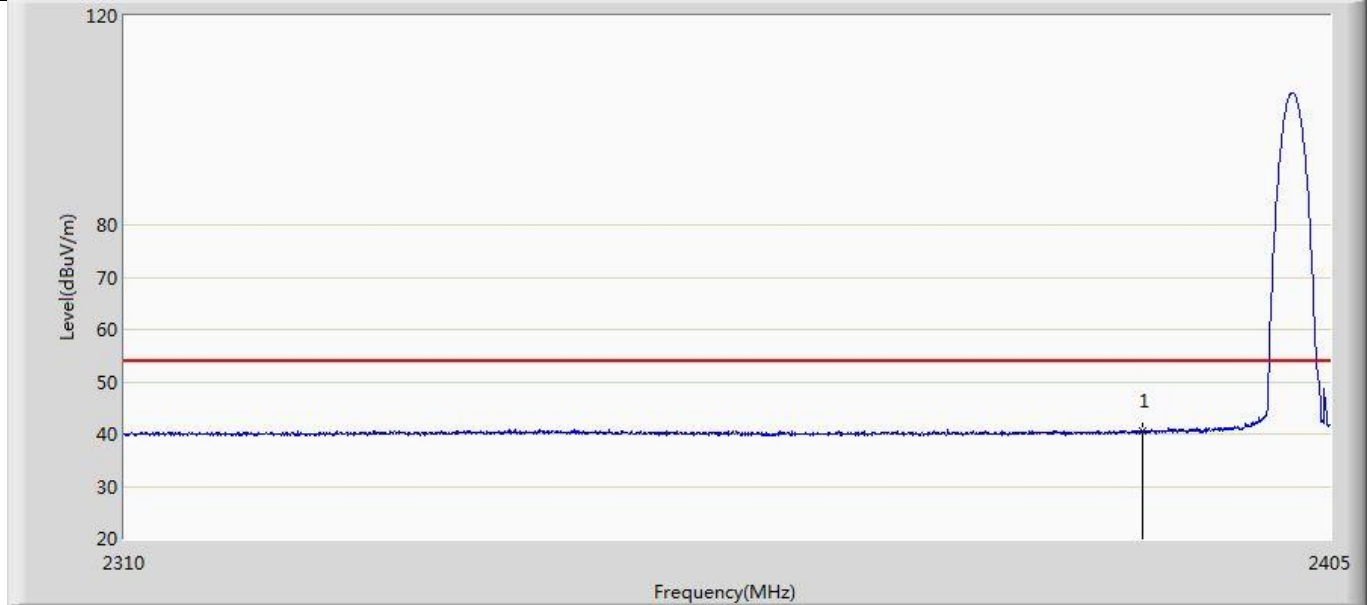

No	Mark	Frequency (MHz)	Measure Level (dBuV/m)	Reading Level (dBuV)	Over Limit (dB)	Limit (dBuV/m)	Factor (dB)	Type
1	*	2390.000	40.464	5.005	-13.536	54.000	35.459	AV

Profile: 2210113R	Page No.: 4
Engineer: Juliuszhou	
Site: AC5	Time: 2022/01/18 - 20:21
Limit: FCC_Part15.209_RE(3m)	Margin: 0
Probe: Horn_3117_00123988_(1-18GHz)	Polarity: Horizontal
EUT: Bluetooth headset	Power: AC 120V/60Hz
Note: Mode 1:Transmit at 2402MHz by LE_1Mbps	

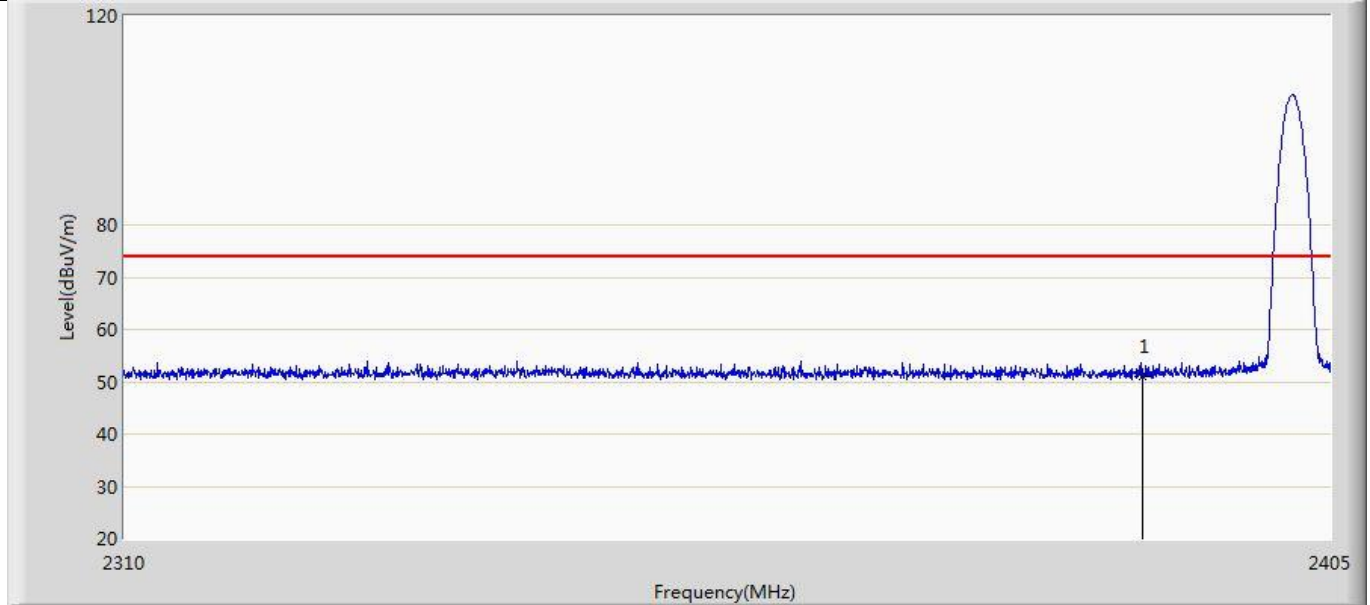

No	Mark	Frequency (MHz)	Measure Level (dBuV/m)	Reading Level (dBuV)	Over Limit (dB)	Limit (dBuV/m)	Factor (dB)	Type
1	*	2390.000	50.939	15.480	-23.061	74.000	35.459	PK

Profile: 2210113R	Page No.: 5
Engineer: Juliuszhou	
Site: AC5	Time: 2022/01/18 - 20:22
Limit: FCC_Part15.209_RE(3m)	Margin: 0
Probe: Horn_3117_00123988_(1-18GHz)	Polarity: Vertical
EUT: Bluetooth headset	Power: AC 120V/60Hz
Note: Mode 2:Transmit at 2402MHz by LE_2Mbps	

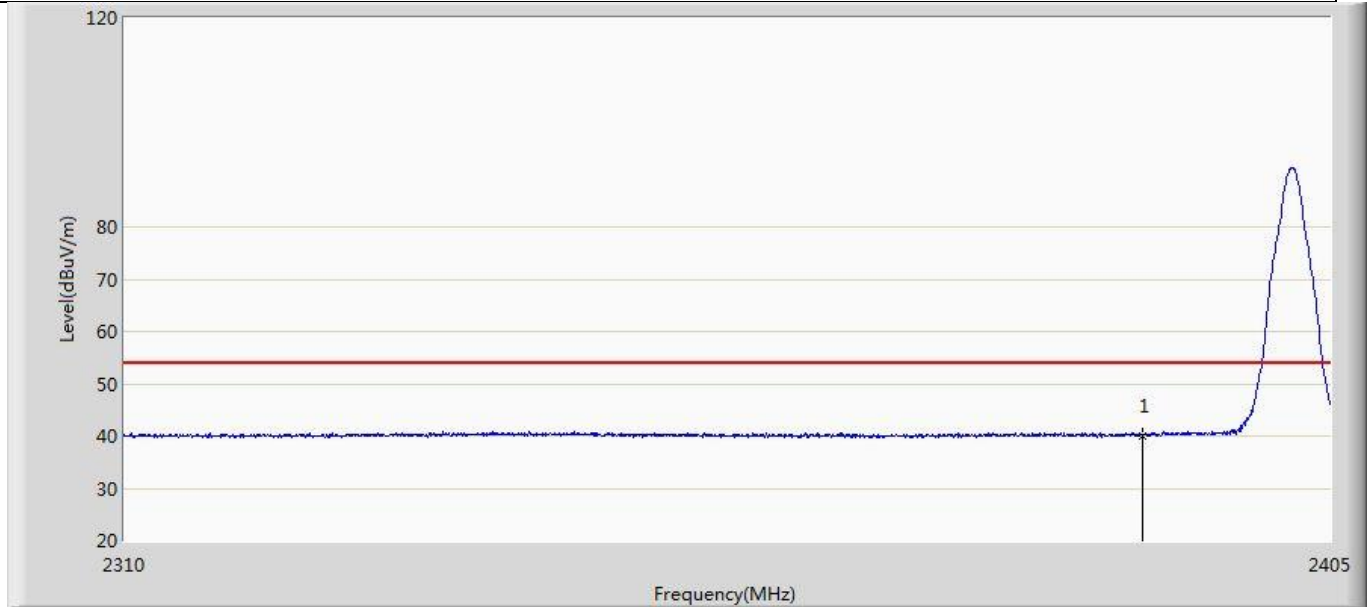

No	Mark	Frequency (MHz)	Measure Level (dBuV/m)	Reading Level (dBuV)	Over Limit (dB)	Limit (dBuV/m)	Factor (dB)	Type
1	*	2390.000	40.088	4.629	-13.912	54.000	35.459	AV

Profile: 2210113R	Page No.: 6
Engineer: Juliuszhou	
Site: AC5	Time: 2022/01/18 - 20:23
Limit: FCC_Part15.209_RE(3m)	Margin: 0
Probe: Horn_3117_00123988_(1-18GHz)	Polarity: Vertical
EUT: Bluetooth headset	Power: AC 120V/60Hz
Note: Mode 2:Transmit at 2402MHz by LE_2Mbps	

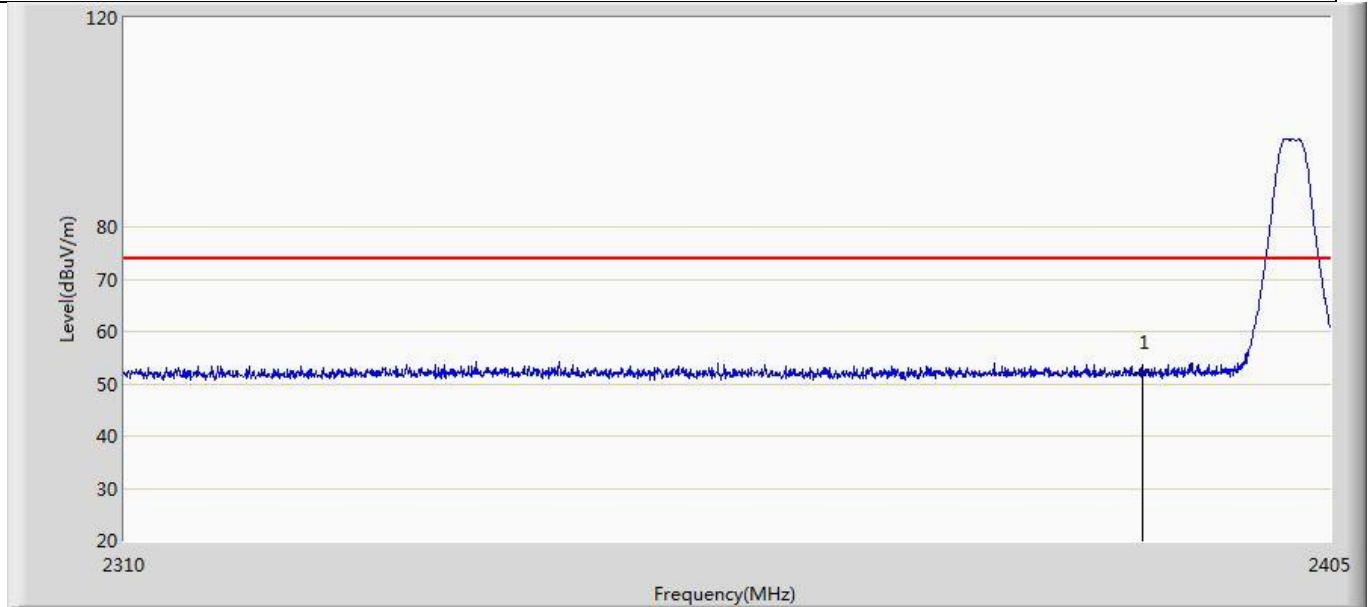

No	Mark	Frequency (MHz)	Measure Level (dBuV/m)	Reading Level (dBuV)	Over Limit (dB)	Limit (dBuV/m)	Factor (dB)	Type
1	*	2390.000	52.178	16.719	-21.822	74.000	35.459	PK

Profile: 2210113R	Page No.: 7
Engineer: Juliuszhou	
Site: AC5	Time: 2022/01/18 - 20:25
Limit: FCC_Part15.209_RE(3m)	Margin: 0
Probe: Horn_3117_00123988_(1-18GHz)	Polarity: Horizontal
EUT: Bluetooth headset	Power: AC 120V/60Hz
Note: Mode 2:Transmit at 2402MHz by LE_2Mbps	

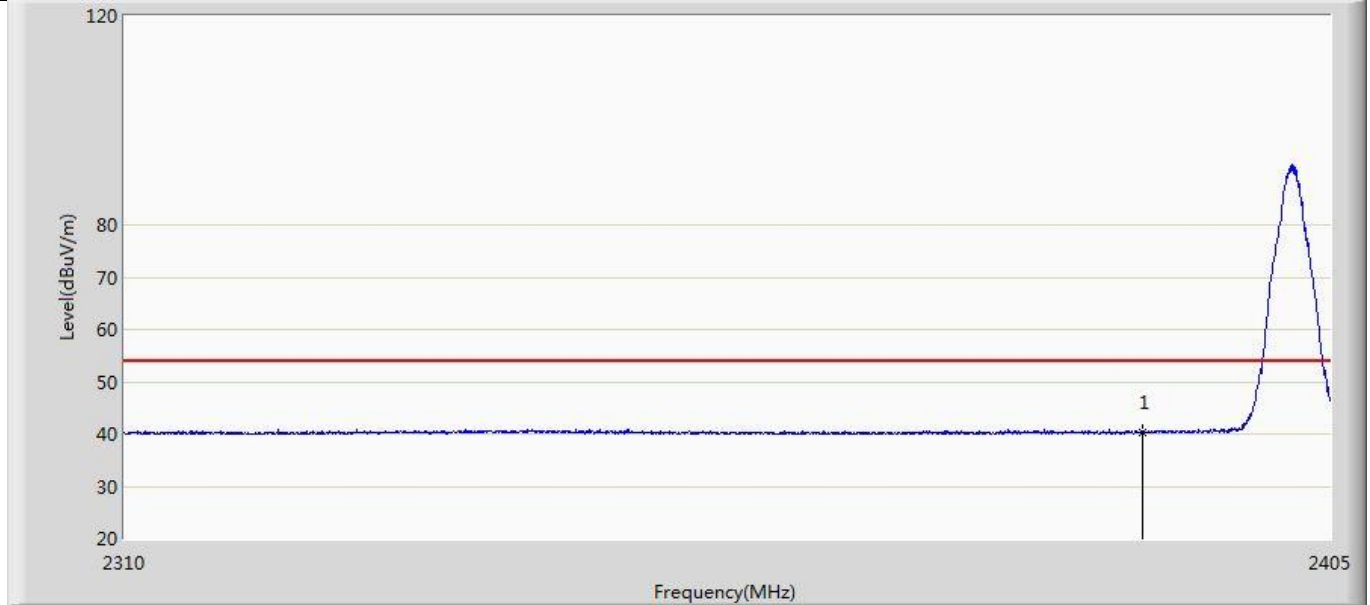

No	Mark	Frequency (MHz)	Measure Level (dBuV/m)	Reading Level (dBuV)	Over Limit (dB)	Limit (dBuV/m)	Factor (dB)	Type
1	*	2390.000	40.323	4.864	-13.677	54.000	35.459	AV

Profile: 2210113R	Page No.: 8
Engineer: Juliuszhou	
Site: AC5	Time: 2022/01/18 - 20:26
Limit: FCC_Part15.209_RE(3m)	Margin: 0
Probe: Horn_3117_00123988_(1-18GHz)	Polarity: Horizontal
EUT: Bluetooth headset	Power: AC 120V/60Hz
Note: Mode 2:Transmit at 2402MHz by LE_2Mbps	

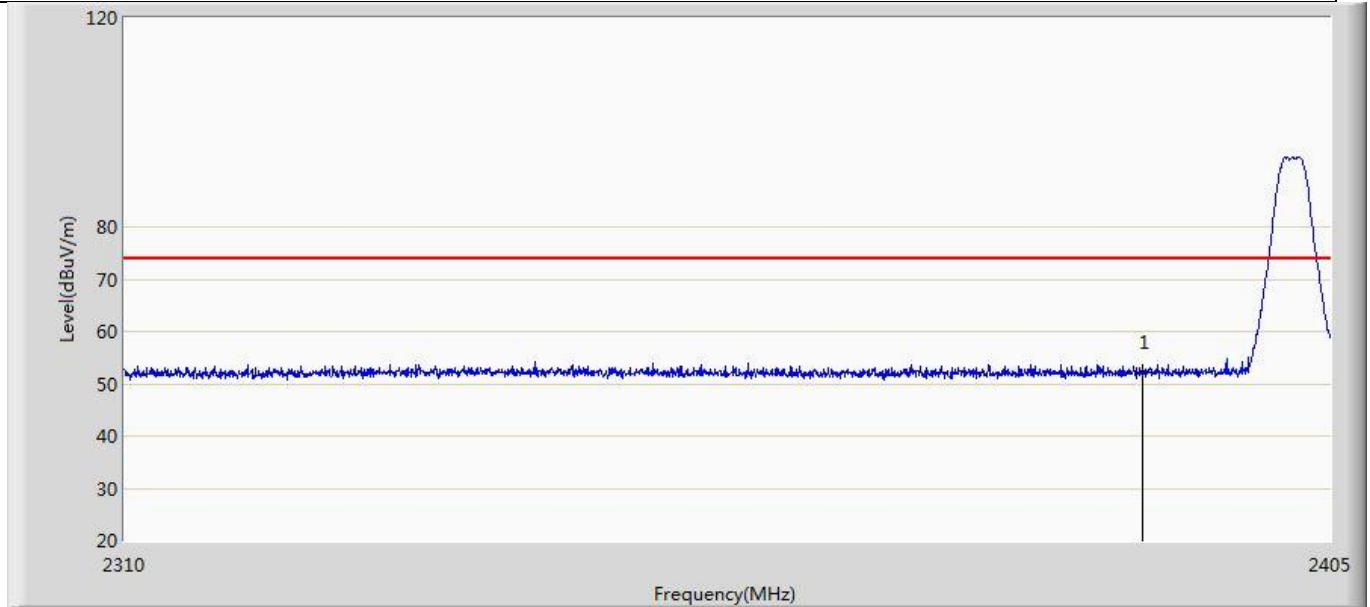

No	Mark	Frequency (MHz)	Measure Level (dBuV/m)	Reading Level (dBuV)	Over Limit (dB)	Limit (dBuV/m)	Factor (dB)	Type
1	*	2390.000	52.217	16.758	-21.783	74.000	35.459	PK

Profile: 2210113R	Page No.: 9
Engineer: Juliuszhou	
Site: AC5	Time: 2022/01/18 - 20:39
Limit: FCC_Part15.209_RE(3m)	Margin: 0
Probe: Horn_3117_00123988_(1-18GHz)	Polarity: Vertical
EUT: Bluetooth headset	Power: AC 120V/60Hz
Note: Mode 1:Transmit at 2480MHz by LE_1Mbps	

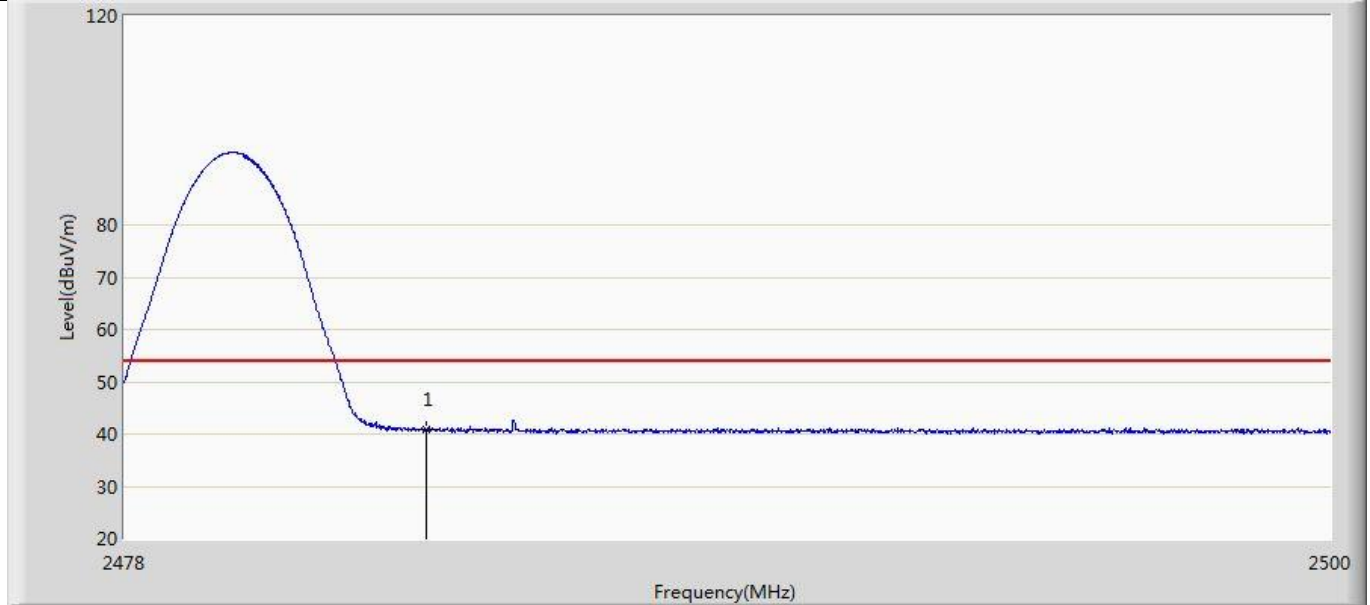

No	Mark	Frequency (MHz)	Measure Level (dBuV/m)	Reading Level (dBuV)	Over Limit (dB)	Limit (dBuV/m)	Factor (dB)	Type
1	*	2483.500	40.818	5.143	-13.182	54.000	35.675	AV

Profile: 2210113R	Page No.: 10
Engineer: Juliuszhou	
Site: AC5	Time: 2022/01/18 - 20:41
Limit: FCC_Part15.209_RE(3m)	Margin: 0
Probe: Horn_3117_00123988_(1-18GHz)	Polarity: Vertical
EUT: Bluetooth headset	Power: AC 120V/60Hz
Note: Mode 1:Transmit at 2480MHz by LE_1Mbps	

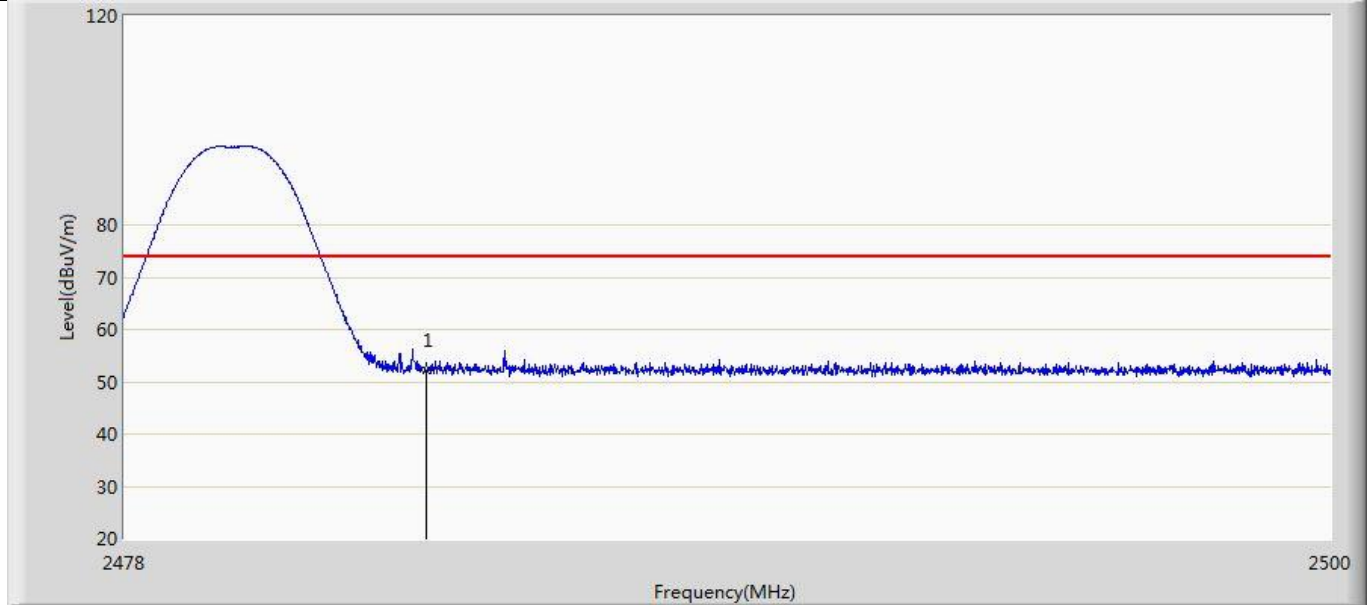

No	Mark	Frequency (MHz)	Measure Level (dBuV/m)	Reading Level (dBuV)	Over Limit (dB)	Limit (dBuV/m)	Factor (dB)	Type
1	*	2483.500	52.215	16.540	-21.785	74.000	35.675	PK

Profile: 2210113R	Page No.: 11
Engineer: Juliuszhou	
Site: AC5	Time: 2022/01/18 - 20:42
Limit: FCC_Part15.209_RE(3m)	Margin: 0
Probe: Horn_3117_00123988_(1-18GHz)	Polarity: Horizontal
EUT: Bluetooth headset	Power: AC 120V/60Hz
Note: Mode 1:Transmit at 2480MHz by LE_1Mbps	

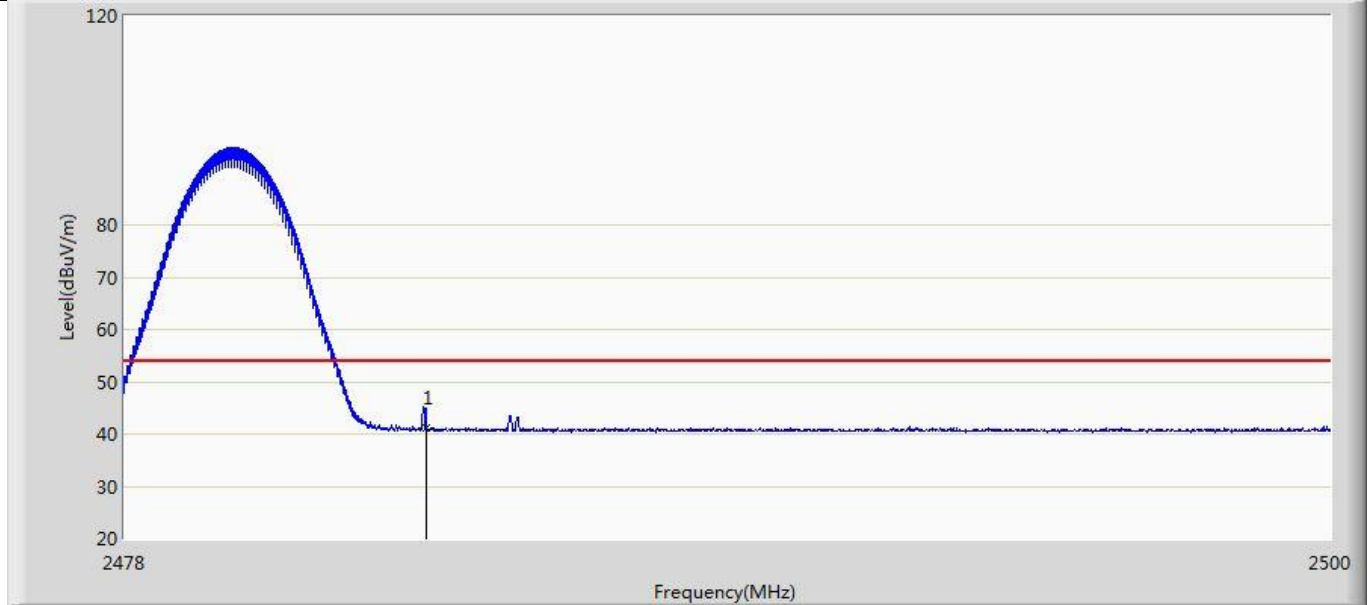

No	Mark	Frequency (MHz)	Measure Level (dBuV/m)	Reading Level (dBuV)	Over Limit (dB)	Limit (dBuV/m)	Factor (dB)	Type
1	*	2483.500	41.070	5.395	-12.930	54.000	35.675	AV

Profile: 2210113R	Page No.: 12
Engineer: Juliuszhou	
Site: AC5	Time: 2022/01/18 - 20:43
Limit: FCC_Part15.209_RE(3m)	Margin: 0
Probe: Horn_3117_00123988_(1-18GHz)	Polarity: Horizontal
EUT: Bluetooth headset	Power: AC 120V/60Hz
Note: Mode 1:Transmit at 2480MHz by LE_1Mbps	

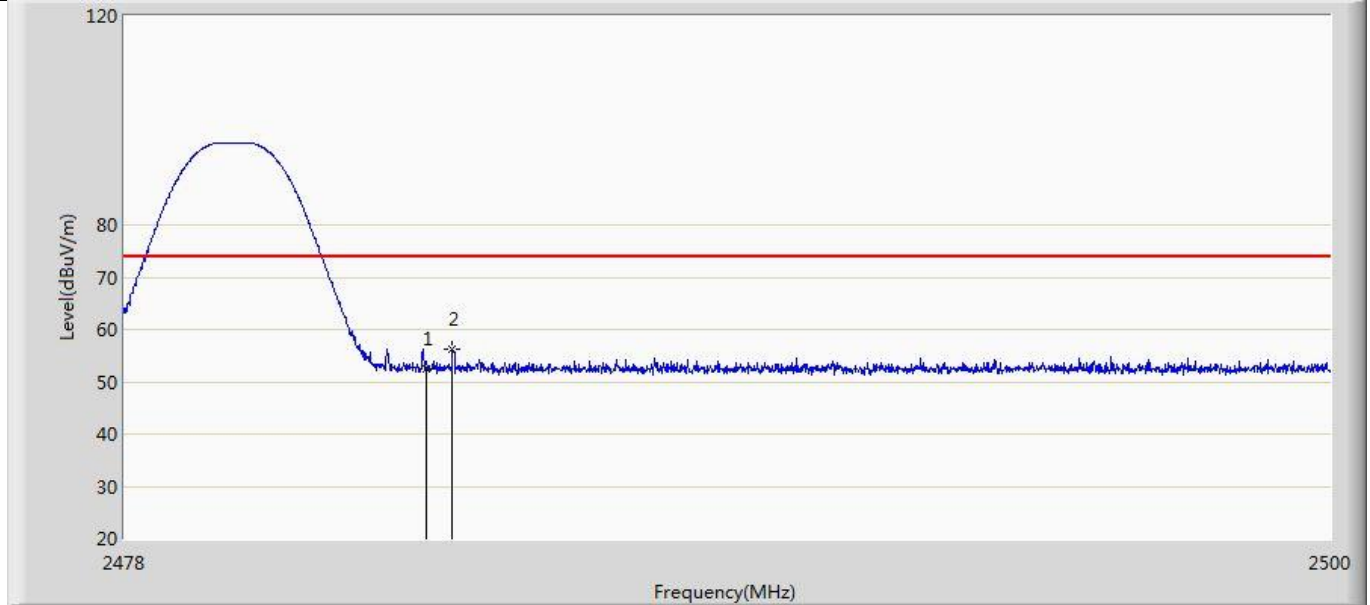

No	Mark	Frequency (MHz)	Measure Level (dBuV/m)	Reading Level (dBuV)	Over Limit (dB)	Limit (dBuV/m)	Factor (dB)	Type
1		2483.500	52.522	16.847	-21.478	74.000	35.675	PK
2	*	2483.973	56.344	20.668	-17.656	74.000	35.676	PK

Profile: 2210113R	Page No.: 13
Engineer: Juliuszhou	
Site: AC5	Time: 2022/01/18 - 20:44
Limit: FCC_Part15.209_RE(3m)	Margin: 0
Probe: Horn_3117_00123988_(1-18GHz)	Polarity: Vertical
EUT: Bluetooth headset	Power: AC 120V/60Hz
Note: Mode 2:Transmit at 2480MHz by LE_2Mbps	

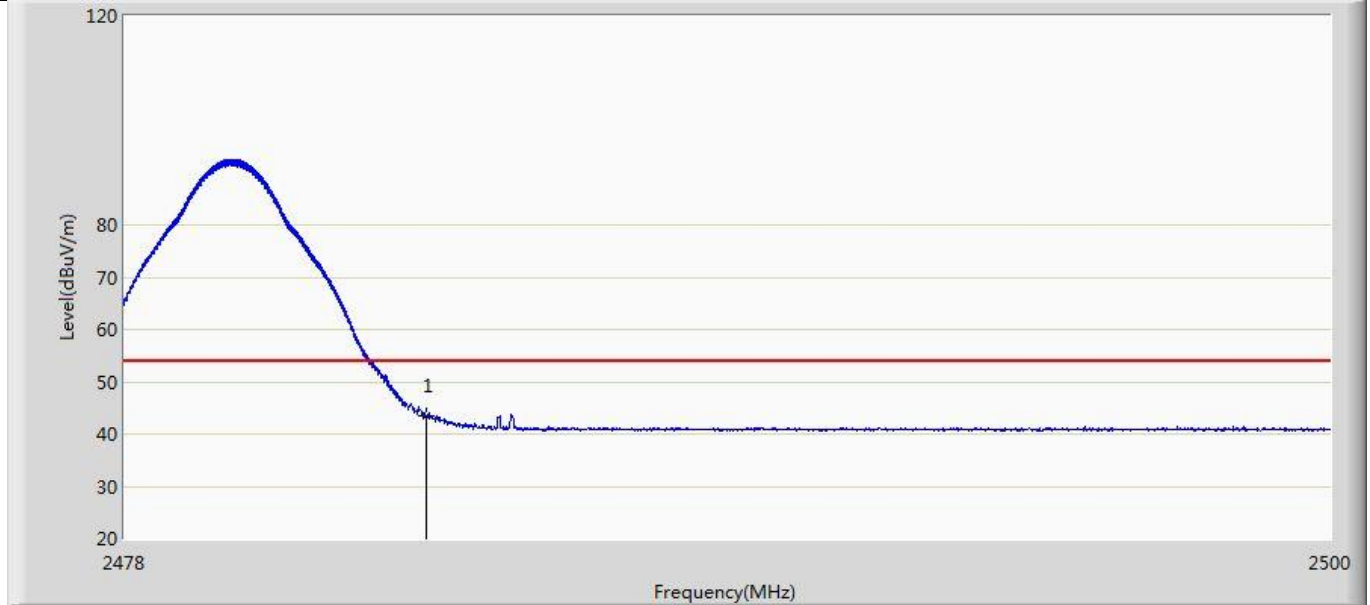

No	Mark	Frequency (MHz)	Measure Level (dBuV/m)	Reading Level (dBuV)	Over Limit (dB)	Limit (dBuV/m)	Factor (dB)	Type
1	*	2483.500	43.590	7.915	-10.410	54.000	35.675	AV

Profile: 2210113R	Page No.: 14
Engineer: Juliuszhou	
Site: AC5	Time: 2022/01/18 - 20:45
Limit: FCC_Part15.209_RE(3m)	Margin: 0
Probe: Horn_3117_00123988_(1-18GHz)	Polarity: Vertical
EUT: Bluetooth headset	Power: AC 120V/60Hz
Note: Mode 2:Transmit at 2480MHz by LE_2Mbps	

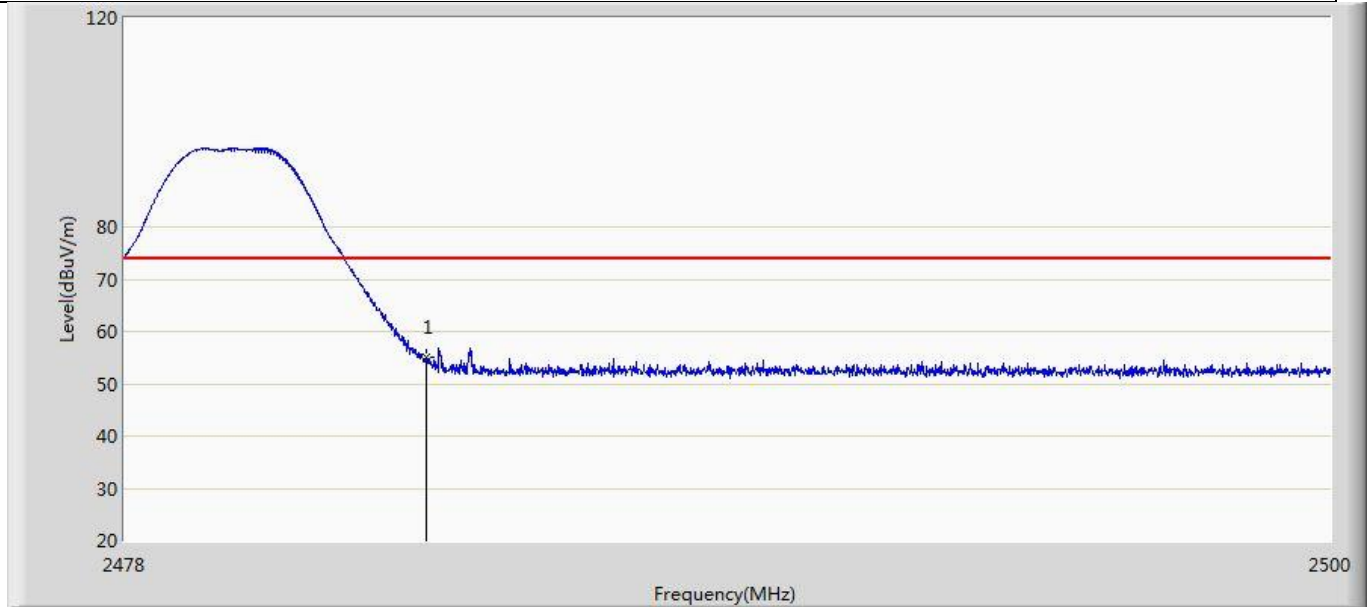

No	Mark	Frequency (MHz)	Measure Level (dBuV/m)	Reading Level (dBuV)	Over Limit (dB)	Limit (dBuV/m)	Factor (dB)	Type
1	*	2483.500	55.096	19.421	-18.904	74.000	35.675	PK

Profile: 2210113R	Page No.: 15
Engineer: Juliuszhou	
Site: AC5	Time: 2022/01/18 - 20:46
Limit: FCC_Part15.209_RE(3m)	Margin: 0
Probe: Horn_3117_00123988_(1-18GHz)	Polarity: Horizontal
EUT: Bluetooth headset	Power: AC 120V/60Hz
Note: Mode 2:Transmit at 2480MHz by LE_2Mbps	

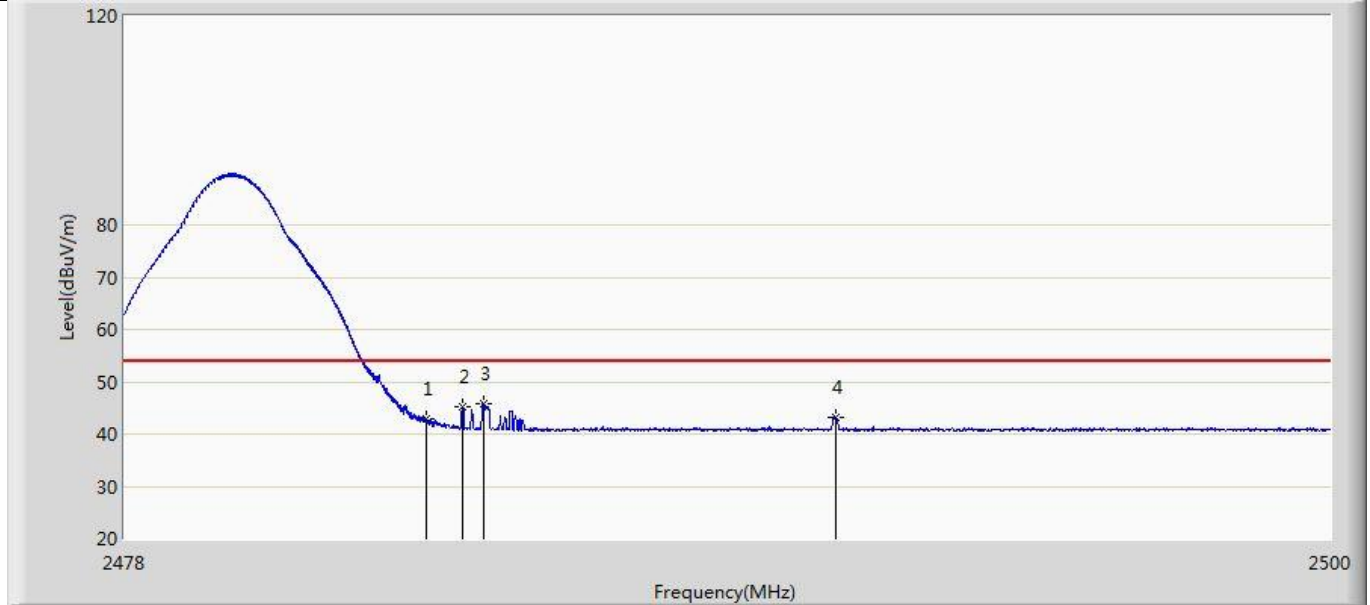

No	Mark	Frequency (MHz)	Measure Level (dBuV/m)	Reading Level (dBuV)	Over Limit (dB)	Limit (dBuV/m)	Factor (dB)	Type
1		2483.500	42.885	7.210	-11.115	54.000	35.675	AV
2		2484.149	45.254	9.578	-8.746	54.000	35.676	AV
3	*	2484.545	45.783	10.106	-8.217	54.000	35.678	AV
4		2490.969	43.253	7.564	-10.747	54.000	35.689	AV

Profile: 2210113R	Page No.: 16
Engineer: Juliuszhou	
Site: AC5	Time: 2022/01/18 - 20:47
Limit: FCC_Part15.209_RE(3m)	Margin: 0
Probe: Horn_3117_00123988_(1-18GHz)	Polarity: Horizontal
EUT: Bluetooth headset	Power: AC 120V/60Hz
Note: Mode 2:Transmit at 2480MHz by LE_2Mbps	

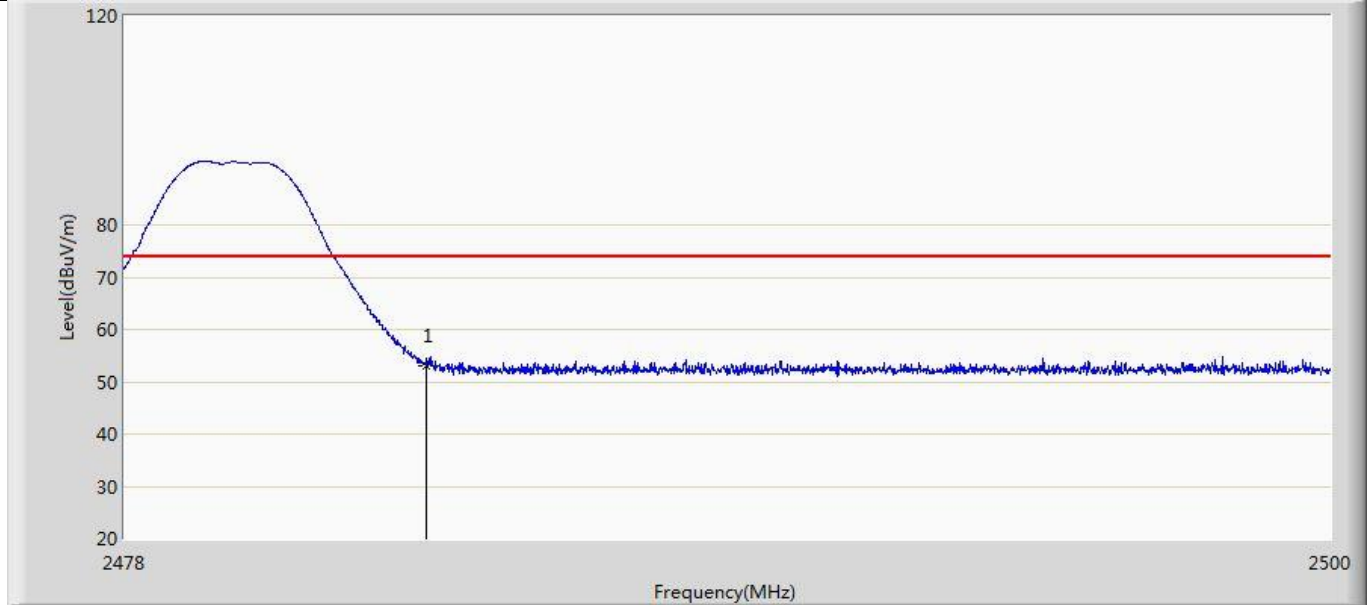

No	Mark	Frequency (MHz)	Measure Level (dBuV/m)	Reading Level (dBuV)	Over Limit (dB)	Limit (dBuV/m)	Factor (dB)	Type
1	*	2483.500	53.155	17.480	-20.845	74.000	35.675	PK

4.6 DTS Bandwidth	VERDICT: PASS
--------------------------	----------------------

4.6.1 Limit

Standard	FCC Part 15 Subpart C Paragraph 15.247 (a)(2)
Systems using digital modulation techniques operate in the 2400-2483.5 MHz. The minimum 6 dB bandwidth shall be at least 500 kHz	

4.6.2 Test Setup

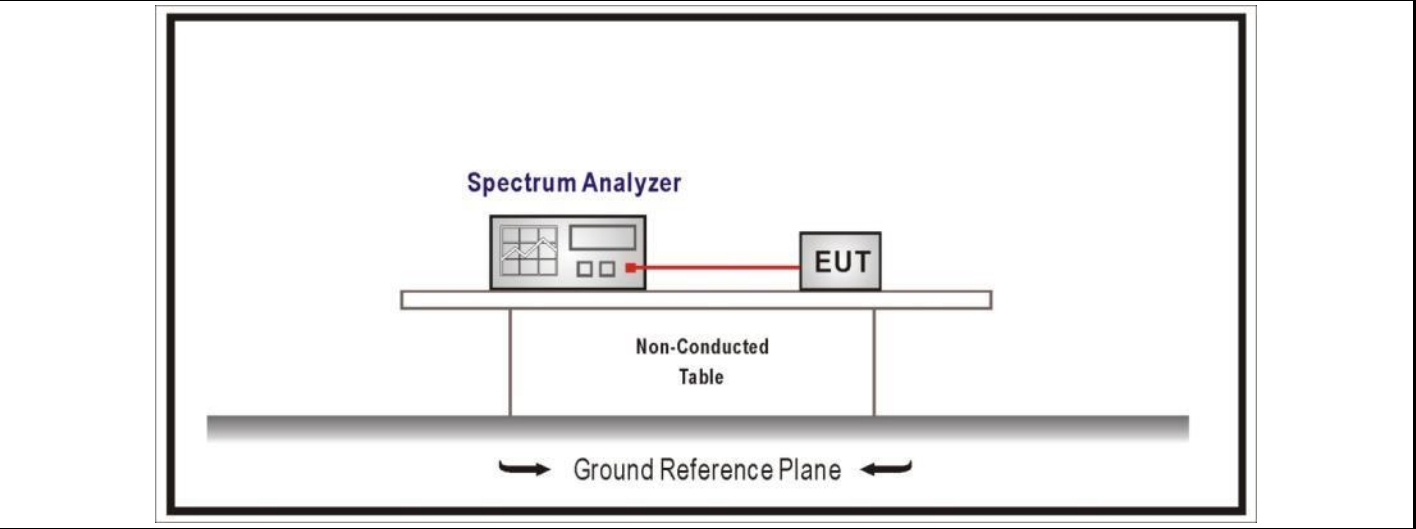

4.6.3 Test Procedure

	Reference Rule	Chapter	Description
<input checked="" type="checkbox"/>	ANSI C63.10	11.8	DTS bandwidth
<input type="checkbox"/>	ANSI C63.10	11.8.1	Option 1
<input checked="" type="checkbox"/>	ANSI C63.10	11.8.2	Option 2

4.6.4 Test Data						
Mode	CH.	Test Freq. (MHz)	99% Occupied Bandwidth (MHz)	6dB Occupied Bandwidth (kHz)	Limit (kHz)	Result
1	00	2402	1.0401	724.6	>500	Pass
	19	2440	1.0403	710.5	>500	Pass
	39	2480	1.0408	710.0	>500	Pass
2	00	2402	2.0593	1260	>500	Pass
	19	2440	2.0537	1209	>500	Pass
	39	2480	2.0479	1194	>500	Pass

Note : The worst case of Occupied Bandwidth as below:

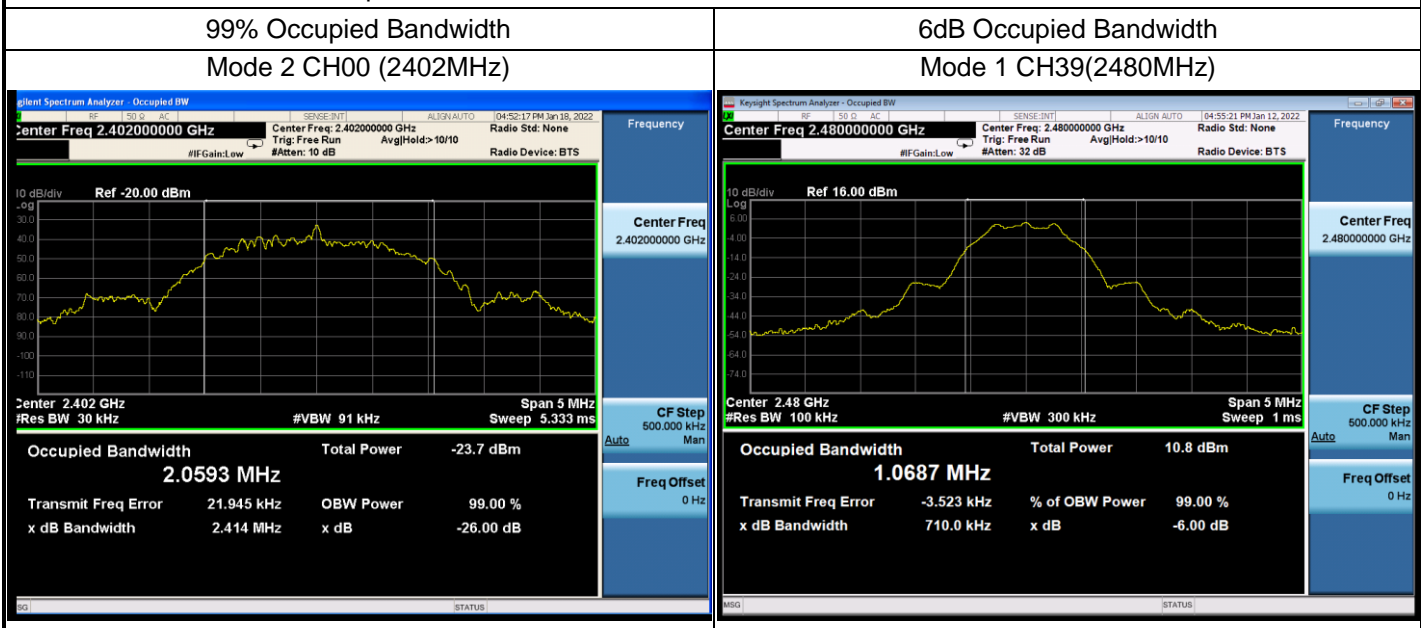

4.7 Fundamental emission output power	VERDICT: PASS
--	----------------------

4.7.1 Limit		
Standard	FCC Part 15 Subpart C Paragraph 15.247 (b)(3)	
<input checked="" type="checkbox"/>	GTX < 6dBi	Pout ≤ 30dBm
<input type="checkbox"/>	GTX > 6dBi	
<input type="checkbox"/>	Non-Fix point-point	Pout ≤ 30 - (GTX - 6)
<input type="checkbox"/>	Fix point-point	Pout ≤ 30 - [(GTX - 6)]/3
<input type="checkbox"/>	Point-to-multipoint	Pout ≤ 30 - (GTX - 6)
<input type="checkbox"/>	Overlap Beams	Pout ≤ 30 - [(GTX - 6)]/3
<input type="checkbox"/>	Aggregate power transmitted simultaneously on all beams	Pout ≤ 30 - [(GTX - 6)]/3
<input type="checkbox"/>	single directional beam	Pout ≤ 30 - [(GTX - 6)]/3 + 8dB
Note 1 : GTX directional gain of transmitting antennas. Note 2 : Pout is maximum peak conducted output power .		

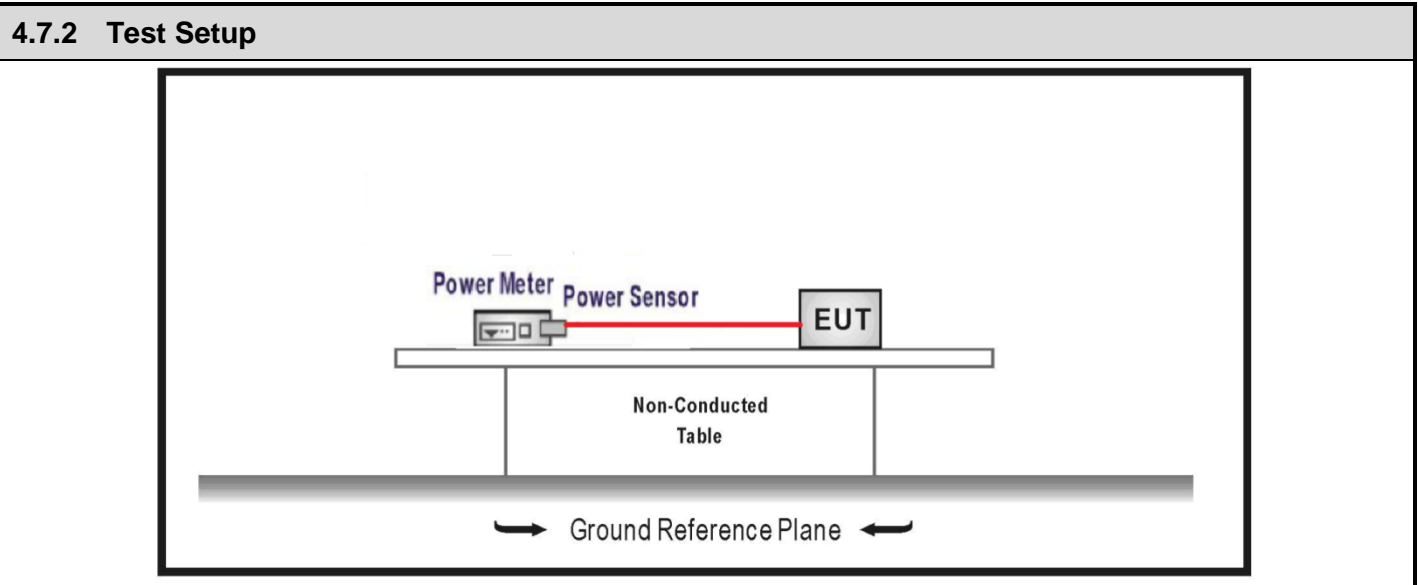

4.7.3 Test Procedure				
	References Rule		Chapter	Description
<input checked="" type="checkbox"/>	ANSI C63.10		11.9	Fundamental emission output power
<input checked="" type="checkbox"/>	ANSI C63.10		11.9.1	Maximum peak conducted output power
	<input type="checkbox"/>	ANSI C63.10	11.9.1.1	RBW \geq DTS bandwidth
	<input type="checkbox"/>	ANSI C63.10	11.9.1.2	Integrated band power method
	<input checked="" type="checkbox"/>	ANSI C63.10	11.9.1.3	PKPM1 Peak power meter method: The maximum peak conducted output power may be measured using a broadband peak RF power meter. The power meter shall have a video bandwidth that is greater than or equal to the DTS bandwidth and shall use a fast-responding diode detector.
<input type="checkbox"/>	ANSI C63.10		11.9.2	Maximum conducted (average) output power
	<input type="checkbox"/>	ANSI C63.10	11.9.2.2	Measurement using a spectrum analyzer (SA)
	<input type="checkbox"/>	ANSI C63.10	11.9.2.2.2	Method AVGSA-1(Duty cycle \geq 98%)
	<input type="checkbox"/>	ANSI C63.10	11.9.2.2.3	Method AVGSA-1A(Duty cycle \geq 98%)
	<input type="checkbox"/>	ANSI C63.10	11.9.2.2.4	Method AVGSA-2(Duty cycle \leq 98%)
	<input type="checkbox"/>	ANSI C63.10	11.9.2.2.5	Method AVGSA-2A(Duty cycle \leq 98%)
	<input type="checkbox"/>	ANSI C63.10	11.9.2.2.4	Method AVGSA-3
	<input type="checkbox"/>	ANSI C63.10	11.9.2.2.5	Method AVGSA-3A
	<input type="checkbox"/>	ANSI C63.10	11.9.2.3	Measurement using a power meter (PM)
	<input type="checkbox"/>	ANSI C63.10	11.9.2.3.1	Method AVGPM
	<input type="checkbox"/>	ANSI C63.10	11.9.2.3.2	Method AVGPM-G

4.7.4 Test Data

Mode	Channel	Test Frequency (MHz)	Conducted Power (dBm)	EIRP (dBm)	Conducted Power Limit (dBm)	EIRP Limit (dBm)	Result
Mode 1	00	2402	4.37	7.96	≤30	≤36	Pass
	19	2440	4.20	7.79	≤30	≤36	Pass
	39	2480	4.15	7.74	≤30	≤36	Pass
Mode 2	00	2402	4.32	7.91	≤30	≤36	Pass
	19	2440	4.21	7.80	≤30	≤36	Pass
	39	2480	4.16	7.75	≤30	≤36	Pass

4.8 Power Density	VERDICT: PASS
--------------------------	----------------------

4.8.1 Limit:	
Standard	FCC Part 15 Subpart C Paragraph 15.247 (b)(3)
Power Spectral Density $\leq 8\text{dBm}/3\text{kHz}$	

4.8.2 Test Setup

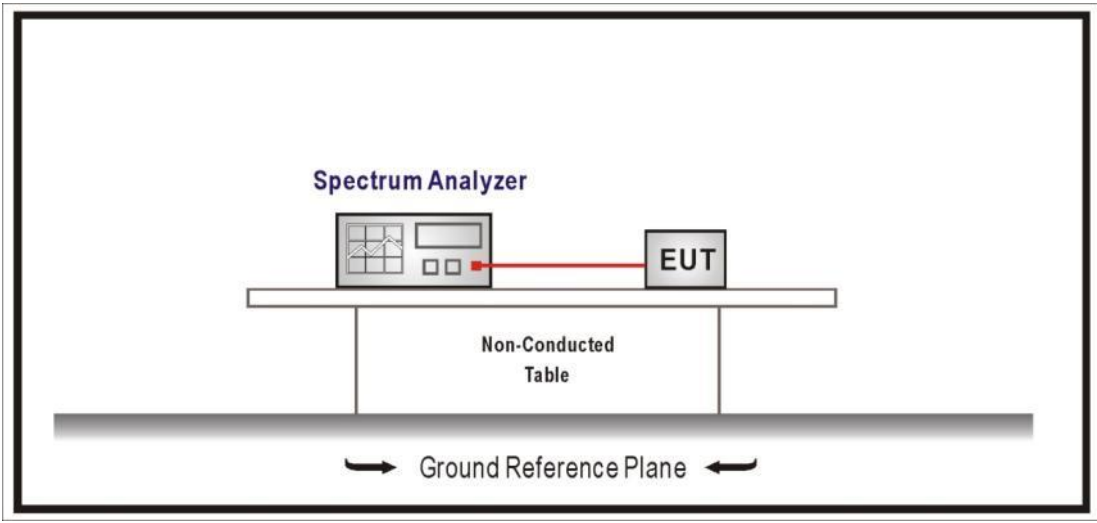

4.8.3 Test Procedure

	References Rule	Chapter	Description
<input checked="" type="checkbox"/>	ANSI C63.10	11.10	Maximum power spectral density level in the fundamental emission
<input type="checkbox"/>	ANSI C63.10	11.10.2	Method PKPSD (peak PSD)
<input type="checkbox"/>	ANSI C63.10	11.10.3	Method AVGPSD-1(Duty cycle $\geq 98\%$)
<input type="checkbox"/>	ANSI C63.10	11.10.4	Method AVGPSD-1A(Duty cycle $\geq 98\%$)
<input checked="" type="checkbox"/>	ANSI C63.10	11.10.5	Method AVGPSD-2(Duty cycle $< 98\%$)
<input type="checkbox"/>	ANSI C63.10	11.10.6	Method AVGPSD-2A(Duty cycle $< 98\%$)
<input type="checkbox"/>	ANSI C63.10	11.10.7	Method AVGPSD-3
<input type="checkbox"/>	ANSI C63.10	11.10.8	Method AVGPSD-3A

4.8.4 Test Data

Mode	Channel	Test Frequency (MHz)	Measurement PSD (dBm/3kHz)	Limit (dBm/3kHz)	Result
Mode 1	00	2402	-10.774	≤8	Pass
	19	2440	-10.856	≤8	Pass
	39	2480	-11.015	≤8	Pass
Mode 2	00	2402	-13.752	≤8	Pass
	19	2440	-13.739	≤8	Pass
	39	2480	-13.791	≤8	Pass

Note : The worst case of PSD as below:

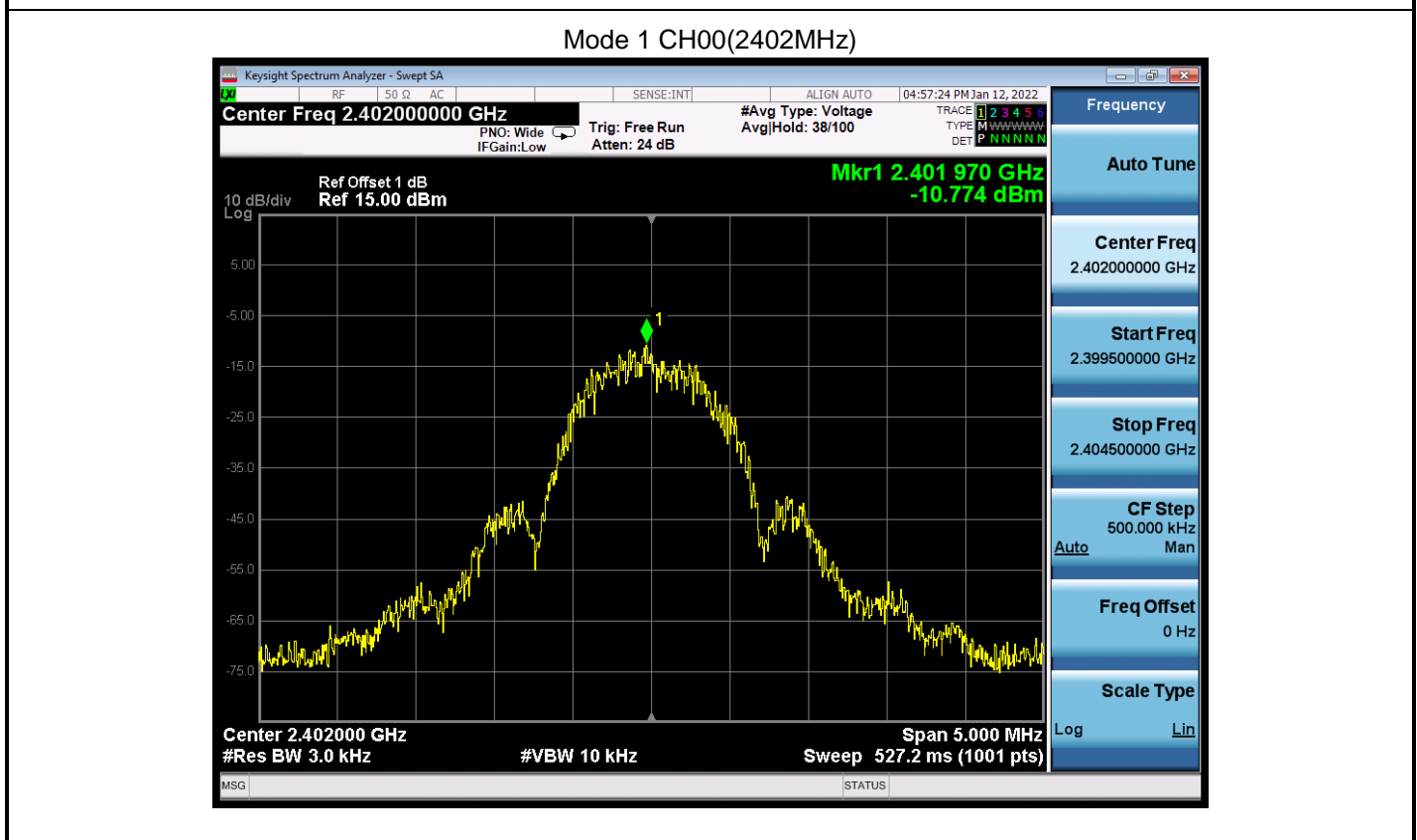

4.9 Antenna Requirement	VERDICT: PASS
--------------------------------	----------------------

4.9.1 Limit:	
Standard	FCC Part 15 Subpart C Paragraph 15.203
<p>An intentional radiator shall be designed to ensure that no antenna other than that furnished by the responsible party shall be used with the device. The use of a permanently attached antenna or of an antenna that uses a unique coupling to the intentional radiator shall be considered sufficient to comply with the provisions of this section. The manufacturer may design the unit so that a broken antenna can be replaced by the user, but the use of a standard antenna jack or electrical connector is prohibited. This requirement does not apply to carrier current devices or to devices operated under the provisions of §15.211, §15.213, §15.217, §15.219, or §15.221. Further, this requirement does not apply to intentional radiators that must be professionally installed, such as perimeter protection systems and some field disturbance sensors, or to other intentional radiators which, in accordance with §15.31(d), must be measured at the installation site. However, the installer shall be responsible for ensuring that the proper antenna is employed so that the limits in this part are not exceeded.</p>	

4.9.2 Antenna Connector Construction:	
<input checked="" type="checkbox"/>	The use of a permanently attached antenna
<input type="checkbox"/>	The antenna use of a unique coupling to the intentional radiator
<input type="checkbox"/>	The use of a nonstandard antenna jack or electrical connector
Please refer to the attached document "Internal Photograph" to show the antenna connector.	

5 TEST SETUP PHOTO AND EUT PHOTO

Remark: The test setup photo and EUT Photo please see appendix.

_____ The End _____