



SPORTON International Inc.

No. 52, Hwa Ya 1st Rd., Hwa Ya Technology Park, Kwei-Shan Hsiang, Tao Yuan Hsien, Taiwan, R.O.C.

Ph: 886-3-327-3456 / FAX: 886-3-327-0973 / www.sporton.com.tw

FCC RADIO TEST REPORT

Applicant's company	Plantronics, Inc.
Applicant Address	345 Encinal Street, Santa Cruz, CA 95060, USA.
FCC ID	AL8-RHX1
Manufacturer's company	Plantronics, Inc.
Manufacturer Address	345 Encinal Street, Santa Cruz, CA 95060, USA.

Product Name	Wireless Adaptor
Brand Name	plantronics®
Model No.	RIG 800HX
Test Rule	47 CFR FCC Part 15 Subpart C § 15.247
Test Freq. Range	2400~2483.5 MHz
Received Date	Jun. 30, 2016
Final Test Date	Aug. 14, 2016
Submission Type	Original Equipment

Statement

The test result in this report refers exclusively to the presented test model / sample.

Without written approval of SPORTON International Inc., the test report shall not be reproduced except in full.

The measurements and test results shown in this test report were made in accordance with the procedures and found in compliance with the limit given in **ANSI C63.10-2013**,

47 CFR FCC Part 15 Subpart C and **KDB558074 D01 v03r05**.

The test equipment used to perform the test is calibrated and traceable to NML/ROC.



Table of Contents

1. VERIFICATION OF COMPLIANCE	1
2. SUMMARY OF THE TEST RESULT	2
3. GENERAL INFORMATION	3
3.1. Product Details	3
3.2. Accessories	3
3.3. Table for Filed Antenna	3
3.4. Table for Carrier Frequencies	4
3.5. Table for Test Modes	4
3.6. Table for Testing Locations.....	5
3.7. Table for Supporting Units	5
3.8. Table for Parameters of Test Software Setting	7
3.9. EUT Operation during Test.....	7
3.10. Duty Cycle.....	7
3.11. Test Configurations.....	8
4. TEST RESULT	11
4.1. AC Power Line Conducted Emissions Measurement	11
4.2. Maximum Conducted Output Power Measurement.....	15
4.3. Power Spectral Density Measurement.....	17
4.4. 6dB Spectrum Bandwidth Measurement	21
4.5. Radiated Emissions Measurement.....	25
4.6. Emissions Measurement.....	35
4.7. Antenna Requirements	43
5. LIST OF MEASURING EQUIPMENTS	44
6. MEASUREMENT UNCERTAINTY	46
APPENDIX A. TEST PHOTOS	A1 ~ A4



History of This Test Report

REPORT NO.	VERSION	DESCRIPTION	ISSUED DATE
FR663037	Rev. 01	Initial issue of report	Oct. 07, 2016

1. VERIFICATION OF COMPLIANCE

Product Name : Wireless Adaptor
Brand Name : **plantronics**
Model No. : RIG 800HX
Applicant : Plantronics, Inc.
Test Rule Part(s) : 47 CFR FCC Part 15 Subpart C § 15.247

Sporton International as requested by the applicant to evaluate the EMC performance of the product sample received on Jun. 30, 2016 would like to declare that the tested sample has been evaluated and found to be in compliance with the tested rule parts. The data recorded as well as the test configuration specified is true and accurate for showing the sample's EMC nature.

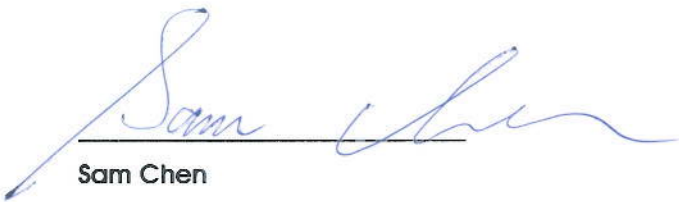

Sam Chen

SPORTON INTERNATIONAL INC.

2. SUMMARY OF THE TEST RESULT

Applied Standard: 47 CFR FCC Part 15 Subpart C			
Part	Rule Section	Description of Test	Result
4.1	15.207	AC Power Line Conducted Emissions	Complies
4.2	15.247(b)(3)	Maximum Conducted Output Power	Complies
4.3	15.247(e)	Power Spectral Density	Complies
4.4	15.247(a)(2)	6dB Spectrum Bandwidth	Complies
4.5	15.247(d)	Radiated Emissions	Complies
4.6	15.247(d)	Band Edge Emissions	Complies
4.7	15.203	Antenna Requirements	Complies

3. GENERAL INFORMATION

3.1. Product Details

Items	Description
Power Type	From host system
Modulation	Pi/4 DQPSK
Frequency Range	2400~2483.5 MHz
Channel spacing	2 MHz
Channel Number	38
Channel Bandwidth (99%)	1.95 MHz
Maximum Conducted Output Power	-0.18 dBm
Carrier Frequencies	Please refer to section 3.4
Antenna	Please refer to section 3.3

3.2. Accessories

N/A

3.3. Table for Filed Antenna

Ant.	Brand	Model Name	Antenna Type	Connector	Gain (dBi)
1	-	-	Printed Antenna	N/A	1.6
2	-	-	Printed Antenna	N/A	1.7

Note: The EUT has two Antennas.

The EUT supports the antenna with TX and RX diversity functions.

Both Ant. 1 and Ant. 2 support transmit and receive functions, but only one of them will be used at one time.

The Ant. 2 generated the worst case, so it was selected to test and record in the report.

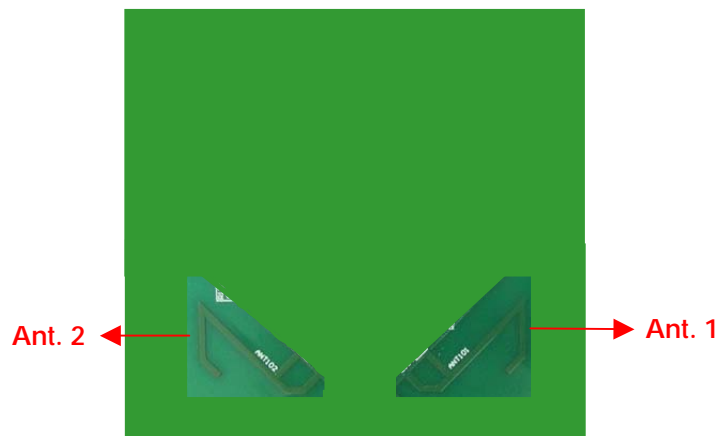

3.4. Table for Carrier Frequencies

Frequency Band	Channel No.	Frequency
2400~2483.5 MHz	1	2403.35 MHz
	2	2405.35 MHz
	:	:
	19	2439.35 MHz
	20	2441.35 MHz
	21	2443.35 MHz
	:	:
	37	2475.35 MHz
	38	2477.35 MHz

3.5. Table for Test Modes

Preliminary tests were performed in different data rate to find the worst radiated emission. The data rate shown in the table below is the worst-case rate with respect to the specific test item. The following table is a list of the test modes shown in this test report.

Test Items	Mode	Channel	Antenna
AC Power Line Conducted Emissions	Normal Link	-	-
Maximum Conducted Output Power	TX Mode	1/20/38	2
Power Spectral Density 6dB Spectrum Bandwidth	TX Mode	1/20/38	2
Radiated Emissions 9kHz~1GHz	Normal Link	-	-
Radiated Emissions 1GHz~10 th Harmonic	TX Mode	1/20/38	2
Band Edge Emissions	TX Mode	1/20/38	2

Note: The EUT can only be used at Z axis position.

The following test modes were performed for all tests:

For Conducted Emission test:

Mode 1. Normal Link- Place EUT in Z axis + NB

Mode 2. Normal Link- Place EUT in Z axis + XBOX

Mode 1 is the worst case, so it was selected to record in this test report

For Radiated Emission test <Below 1GHz>:

Mode 1. Normal Link- Place EUT in Z axis + NB

Mode 2. Normal Link- Place EUT in Z axis + XBOX

Mode 2 is the worst case, so it was selected to record in this test report

For Radiated Emission test <Above 1GHz>:

Mode 1. CTX - Place EUT in Z axis

3.6. Table for Testing Locations

Test Site Location				
Address:	No.8, Lane 724, Bo-ai St., Jhubei City, Hsinchu County 302, Taiwan, R.O.C.			
TEL:	886-3-656-9065			
FAX:	886-3-656-9085			
Test Site No.	Site Category	Location	FCC Designation No.	IC File No.
03CH01-CB	SAC	Hsin Chu	TW0006	IC 4086D
CO01-CB	Conduction	Hsin Chu	TW0006	IC 4086D
TH01-CB	OVEN Room	Hsin Chu	-	-

Open Area Test Site (OATS); Semi Anechoic Chamber (SAC).

3.7. Table for Supporting Units

For Test Site No: 03CH01-CB

For Radiated Emission test <Below 1GHz>

Support Unit	Brand	Model	FCC ID
Wireless Gaming headset	plantronics	RIG 800	AL8-RIG800
XBOX	Microsoft Corporation	1540	DoC
Wireless controller	Microsoft Corporation	NA	DoC
AP	Netgear	R7500	PY314300288
LCD TV	Sony	KLV-32U300A	DoC
Notebook	DELL	E4300	DoC

For Radiated Emission test <Above 1GHz>

Support Unit	Brand	Model	FCC ID
Notebook	DELL	E4300	DoC

For Test Site No: CO01-CB

Support Unit	Brand	Model	FCC ID
AP Router	Planex	GW-AP54SGX	KA220030603014-1
Notebook*2	DELL	E6430	DoC
Wireless Gaming headset	plantronics	RIG 800	AL8-RIG800
Mouse	Logitech	M-U0026	DoC
Earphone	e-Power	S90W	DoC

For Test Site No: TH01-CB

Support Unit	Brand	Model	FCC ID
--------------	-------	-------	--------

Support Unit	Brand	Model	FCC ID
Notebook	DELL	E4300	DoC

3.8. Table for Parameters of Test Software Setting

During testing, Channel and Power Controlling Software provided by the customer was used to control the operating channel as well as the output power level. The RF output power selection is for the setting of RF output power expected by the customer and is going to be fixed on the firmware of the final end product.

Test Software Version	VMITest v1.1.6.48		
Frequency	2403.35 MHz	2441.35 MHz	2477.35 MHz
Pi/4 DQPSK	0x08	0x08	0x08

3.9. EUT Operation during Test

The EUT was programmed to be in continuously transmitting mode.

3.10. Duty Cycle

On Time (ms)	On+Off Time (ms)	Duty Cycle (%)	Duty Factor (dB)	1/T Minimum VBW (kHz)
1.00	1.00	100.00	0.00	0.01

3.11. Test Configurations

3.11.1. AC Power Line Conduction Emissions Test Configuration

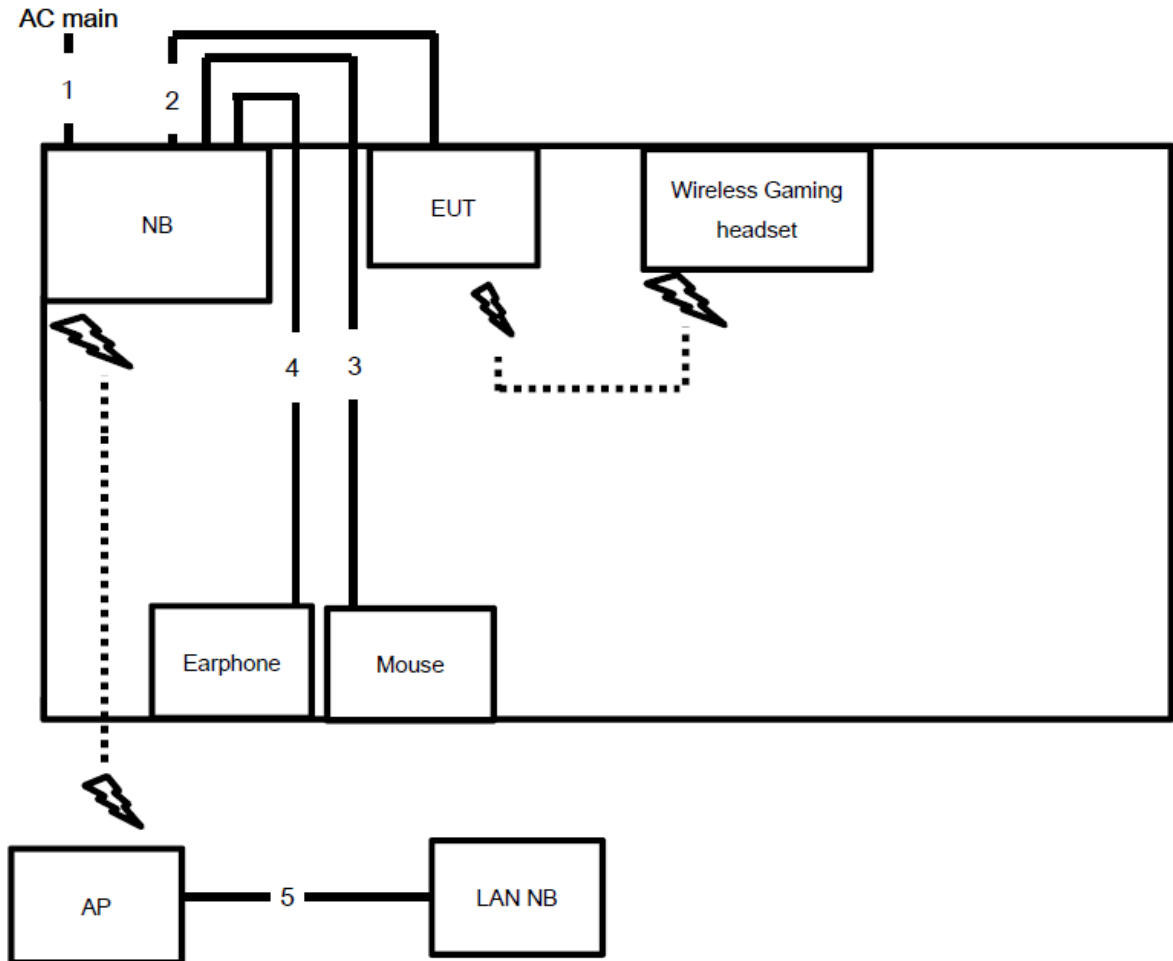

Item	Connection	Shielded	Length
1	Power cable	No	2.6m
2	USB cable	Yes	0.8m
3	USB cable	Yes	1.8m
4	Audio cable	No	1.4m
5	RJ-45 cable	No	1.5m

3.11.2. Radiation Emissions Test Configuration

Test Configuration: 30MHz~1GHz

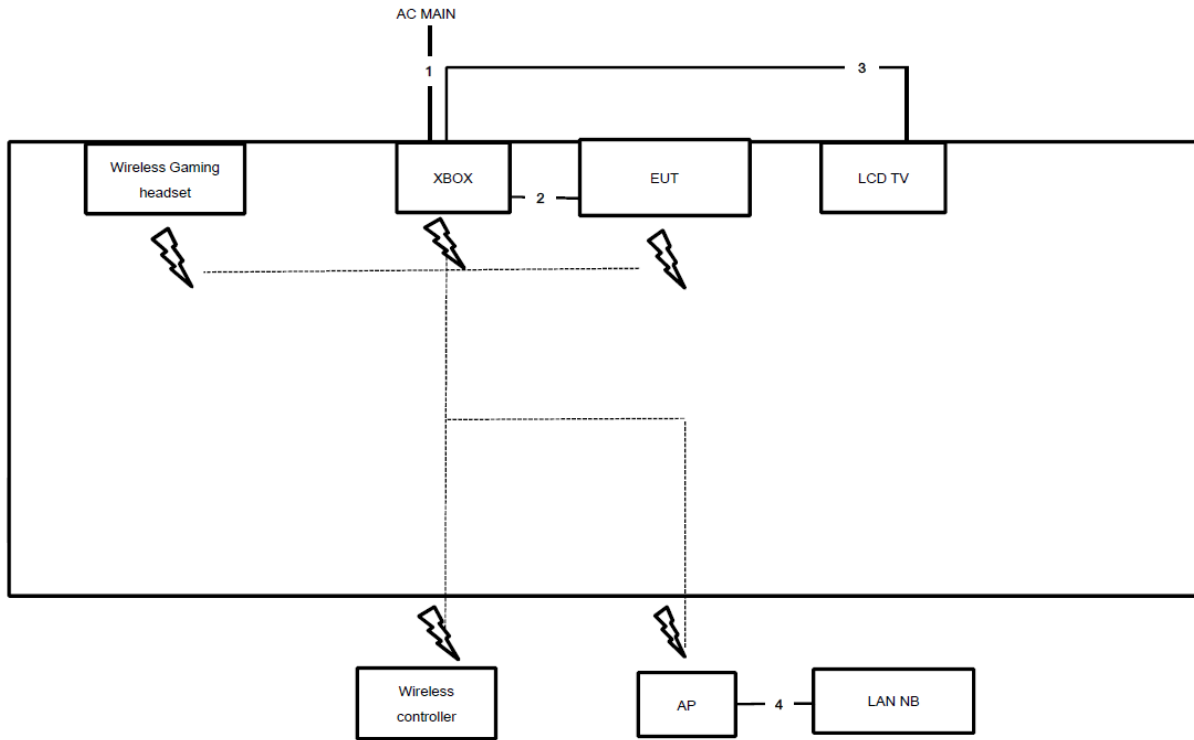

Item	Connection	Shielded	Length
1	Power cable	No	2.5m
2	USB cable	Yes	0.8m
3	HDMI cable	Yes	2m
4	RJ-45 cable	No	1.5m

Test Configuration: Above 1GHz

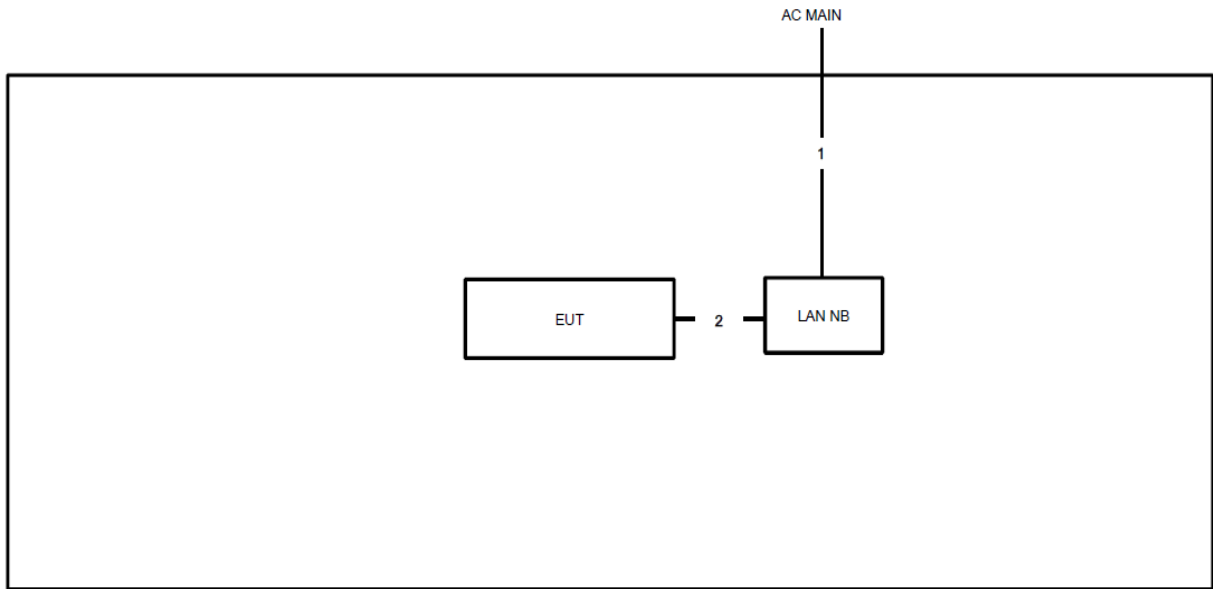

Item	Connection	Shielded	Length
1	Power cable	No	2.6m
2	USB cable	Yes	0.8m

4. TEST RESULT

4.1. AC Power Line Conducted Emissions Measurement

4.1.1. Limit

For a Low-power Radio-frequency Device which is designed to be connected to the AC power line, the radio frequency voltage that is conducted back onto the AC power line on any frequency or frequencies within the band 150 kHz to 30 MHz shall not exceed below limits table.

Frequency (MHz)	QP Limit (dBuV)	AV Limit (dBuV)
0.15~0.5	66~56	56~46
0.5~5	56	46
5~30	60	50

4.1.2. Measuring Instruments and Setting

Please refer to section 5 of equipments list in this report. The following table is the setting of the receiver.

Receiver Parameters	Setting
Attenuation	10 dB
Start Frequency	0.15 MHz
Stop Frequency	30 MHz
IF Bandwidth	9 kHz

4.1.3. Test Procedures

1. Configure the EUT according to ANSI C63.10. The EUT or host of EUT has to be placed 0.4 meter far from the conducting wall of the shielding room and at least 80 centimeters from any other grounded conducting surface.
2. Connect EUT or host of EUT to the power mains through a line impedance stabilization network (LISN).
3. All the support units are connected to the other LISNs. The LISN should provide 50uH/50ohms coupling impedance.
4. The frequency range from 150 kHz to 30 MHz was searched.
5. Set the test-receiver system to Peak Detect Function and Specified Bandwidth with Maximum Hold Mode.
6. The measurement has to be done between each power line and ground at the power terminal.

4.1.4. Test Setup Layout

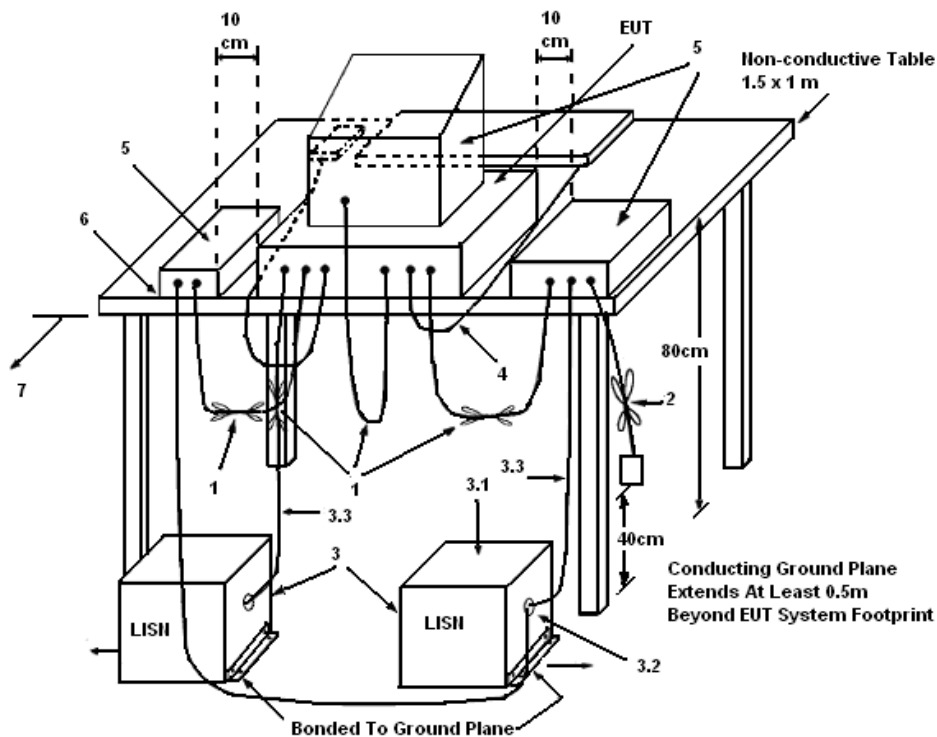

LEGEND:

- (1) Interconnecting cables that hang closer than 40 cm to the ground plane shall be folded back and forth in the center forming a bundle 30 to 40 cm long.
- (2) I/O cables that are not connected to a peripheral shall be bundled in the center. The end of the cable may be terminated, if required, using the correct terminating impedance. The overall length shall not exceed 1 m.
- (3) EUT connected to one LISN. Unused LISN measuring port connectors shall be terminated in 50 Ω. LISN can be placed on top of, or immediately beneath, reference ground plane.
- (3.1) All other equipment powered from additional LISN(s).
- (3.2) Multiple outlet strip can be used for multiple power cords of non-EUT equipment.
- (3.3) LISN at least 80 cm from nearest part of EUT chassis.
- (4) Cables of hand-operated devices, such as keyboards, mice, etc., shall be placed as for normal use.
- (5) Non-EUT components of EUT system being tested.
- (6) Rear of EUT, including peripherals, shall all be aligned and flush with rear of tabletop.
- (7) Rear of tabletop shall be 40 cm removed from a vertical conducting plane that is bonded to the ground plane.

4.1.5. Test Deviation

There is no deviation with the original standard.

4.1.6. EUT Operation during Test

The EUT was placed on the test table and programmed in normal function.

4.1.7. Results of AC Power Line Conducted Emissions Measurement

Temperature	25°C	Humidity	61%
Test Engineer	GN Hou	Phase	Line
Configuration	Normal Link	Test Mode	Mode 1

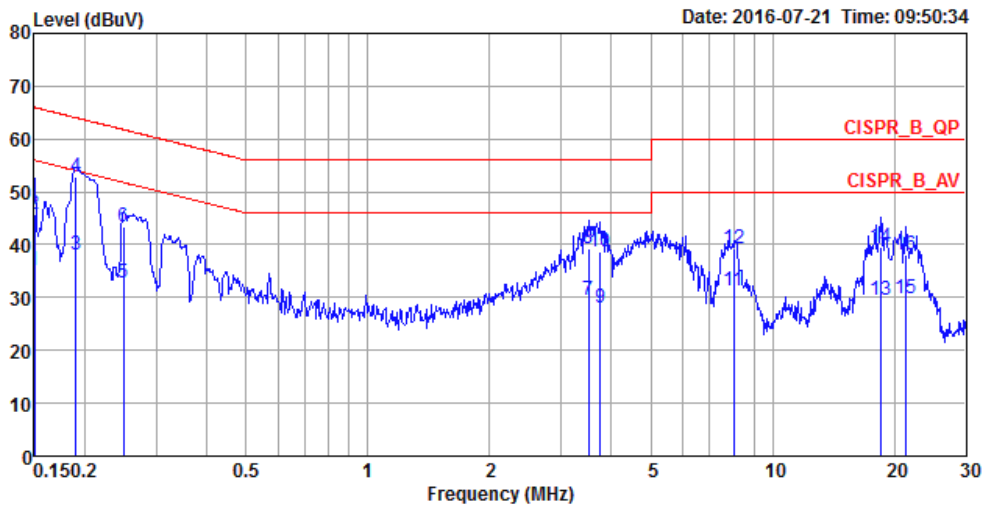

	Freq	Level	Over Limit	Limit Line	Read Level	LISN Factor	Cable Loss	Pol/Phase	Remark
	MHz	dBuV	dB	dBuV	dBuV	dB	dB		
1	0.1500	35.26	-20.74	56.00	25.08	10.02	0.16	LINE	Average
2	0.1500	45.76	-20.24	66.00	35.58	10.02	0.16	LINE	QP
3	0.1904	38.13	-15.89	54.02	28.02	9.92	0.19	LINE	Average
4	0.1904	52.75	-11.27	64.02	42.64	9.92	0.19	LINE	QP
5	0.2495	32.74	-19.04	51.78	22.69	9.92	0.13	LINE	Average
6	0.2495	43.26	-18.52	61.78	33.21	9.92	0.13	LINE	QP
7	3.5092	29.56	-16.44	46.00	19.50	9.98	0.08	LINE	Average
8	3.5092	39.14	-16.86	56.00	29.08	9.98	0.08	LINE	QP
9	3.7594	28.02	-17.98	46.00	17.94	9.99	0.09	LINE	Average
10	3.7594	38.64	-17.36	56.00	28.56	9.99	0.09	LINE	QP
11	8.0198	31.23	-18.77	50.00	20.99	10.10	0.14	LINE	Average
12	8.0198	39.29	-20.71	60.00	29.05	10.10	0.14	LINE	QP
13	18.5237	29.58	-20.42	50.00	19.06	10.29	0.23	LINE	Average
14	18.5237	39.50	-20.50	60.00	28.98	10.29	0.23	LINE	QP
15	21.2596	29.69	-20.31	50.00	19.10	10.34	0.25	LINE	Average
16	21.2596	38.18	-21.82	60.00	27.59	10.34	0.25	LINE	QP

Temperature	25°C	Humidity	61%
Test Engineer	GN Hou	Phase	Neutral
Configuration	Normal Link	Test Mode	Mode 1

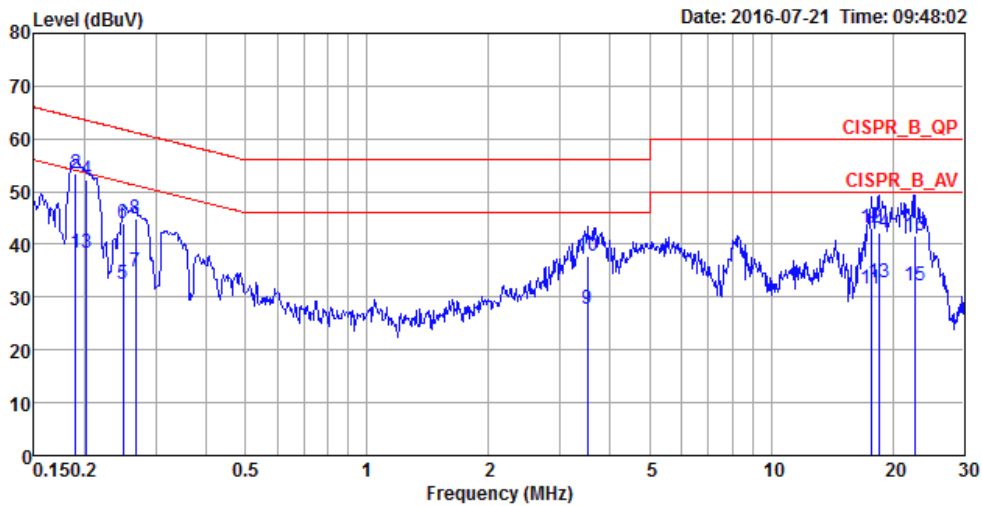

	Freq	Level	Over	Limit	Read	LISN	Cable		
	MHz	dBuV	Limit	Line	Level	Factor	Loss	Pol/Phase	Remark
			dB	dBuV	dBuV	dB	dB		
1	0.1904	38.48	-15.54	54.02	28.37	9.92	0.19	NEUTRAL	Average
2	0.1904	53.56	-10.46	64.02	43.45	9.92	0.19	NEUTRAL	QP
3	0.2018	38.25	-15.29	53.54	28.14	9.92	0.19	NEUTRAL	Average
4	0.2018	52.11	-11.43	63.54	42.00	9.92	0.19	NEUTRAL	QP
5	0.2495	32.51	-19.27	51.78	22.46	9.92	0.13	NEUTRAL	Average
6	0.2495	44.05	-17.73	61.78	34.00	9.92	0.13	NEUTRAL	QP
7	0.2672	34.98	-16.22	51.20	24.95	9.92	0.11	NEUTRAL	Average
8	0.2672	44.97	-16.23	61.20	34.94	9.92	0.11	NEUTRAL	QP
9	3.5092	27.66	-18.34	46.00	17.60	9.98	0.08	NEUTRAL	Average
10	3.5092	37.77	-18.23	56.00	27.71	9.98	0.08	NEUTRAL	QP
11	17.6611	31.49	-18.51	50.00	20.99	10.27	0.23	NEUTRAL	Average
12	17.6611	43.20	-16.80	60.00	32.70	10.27	0.23	NEUTRAL	QP
13	18.5237	32.71	-17.29	50.00	22.19	10.29	0.23	NEUTRAL	Average
14	18.5237	42.29	-17.71	60.00	31.77	10.29	0.23	NEUTRAL	QP
15	22.6551	32.04	-17.96	50.00	21.40	10.38	0.26	NEUTRAL	Average
16	22.6551	41.51	-18.49	60.00	30.87	10.38	0.26	NEUTRAL	QP

Note:

Level = Read Level + LISN Factor + Cable Loss.

4.2. Maximum Conducted Output Power Measurement

4.2.1. Limit

The limit for output power is 30dBm.

4.2.2. Measuring Instruments and Setting

Please refer to section 5 of equipments list in this report. The following table is the setting of the power meter.

Power Meter Parameter	Setting
Bandwidth	50MHz bandwidth is greater than the EUT emission bandwidth
Detector	Average

4.2.3. Test Procedures

1. Test procedures refer KDB558074 D01 v03r05 section 9.2.3.2.
2. This procedure provides an alternative for determining the RMS output power using a broadband RF average power meter with a thermocouple detector.

4.2.4. Test Setup Layout

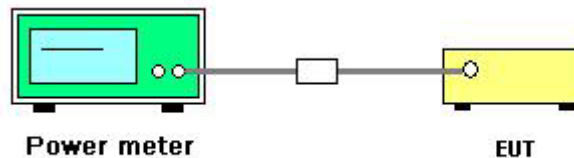

4.2.5. Test Deviation

There is no deviation with the original standard.

4.2.6. EUT Operation during Test

The EUT was programmed to be in continuously transmitting mode.

4.2.7. Test Result of Maximum Conducted Output Power

Temperature	20°C	Humidity	54%
Test Engineer	Serway Li	Test Date	Aug. 14, 2016

Channel	Frequency	Conducted Power (dBm)	Max. Limit (dBm)	Result
1	2403.35 MHz	-0.18	30.00	Complies
20	2441.35 MHz	-1.26	30.00	Complies
38	2477.35 MHz	-1.79	30.00	Complies

4.3. Power Spectral Density Measurement

4.3.1. Limit

For digitally modulated systems, the power spectral density conducted from the intentional radiator to the antenna shall not be greater than 8 dBm in any 3 kHz band during any time interval of continuous transmission.

4.3.2. Measuring Instruments and Setting

Please refer to section 5 of equipments list in this report. The following table is the setting of Spectrum Analyzer.

Spectrum Parameter	Setting
Attenuation	Auto
Span Frequency	5-30 % greater than the DTS channel bandwidth.
RBW	$3 \text{ kHz} \leq \text{RBW} \leq 100\text{kHz}$
VBW	$\geq 3 \times \text{RBW}$
Detector	Peak
Trace	Max Hold
Sweep Time	Auto couple

4.3.3. Test Procedures

1. Test was performed in accordance with KDB558074 D01 v03r05 for Performing Compliance Measurements on Digital Transmission Systems (DTS) - section 10.2 Method PKPSD (peak PSD).
2. Use this procedure when the maximum conducted output power in the fundamental emission is used to demonstrate compliance. The EUT must be configured to transmit continuously at full power over the measurement duration.
3. Ensure that the number of measurement points in the sweep $\geq 2 \times \text{span/RBW}$ (use of a greater number of measurement points than this minimum requirement is recommended).
4. Use the peak marker function to determine the maximum level in any 3 kHz band segment within the fundamental EBW.
5. The resulting PSD level must be $\leq 8 \text{ dBm}$.

4.3.4. Test Setup Layout

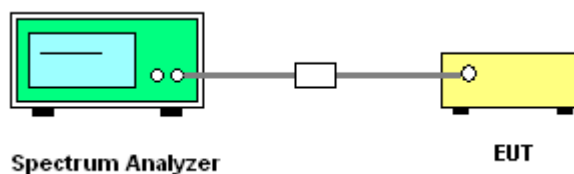

4.3.5. Test Deviation

There is no deviation with the original standard.

4.3.6. EUT Operation during Test

The EUT was programmed to be in continuously transmitting mode.

4.3.7. Test Result of Power Spectral Density

Temperature	20°C	Humidity	54%
Test Engineer	Serway Li		

Frequency	Power Density (dBm/3kHz)	Power Density Limit (dBm/3kHz)	Result
2403.35 MHz	-15.90	8.00	Complies
2441.35 MHz	-16.43	8.00	Complies
2477.35 MHz	-16.66	8.00	Complies

Note: All the test values were listed in the report.

For plots, only the channel with worse result was shown.

Power Density Plot / 2403.35 MHz

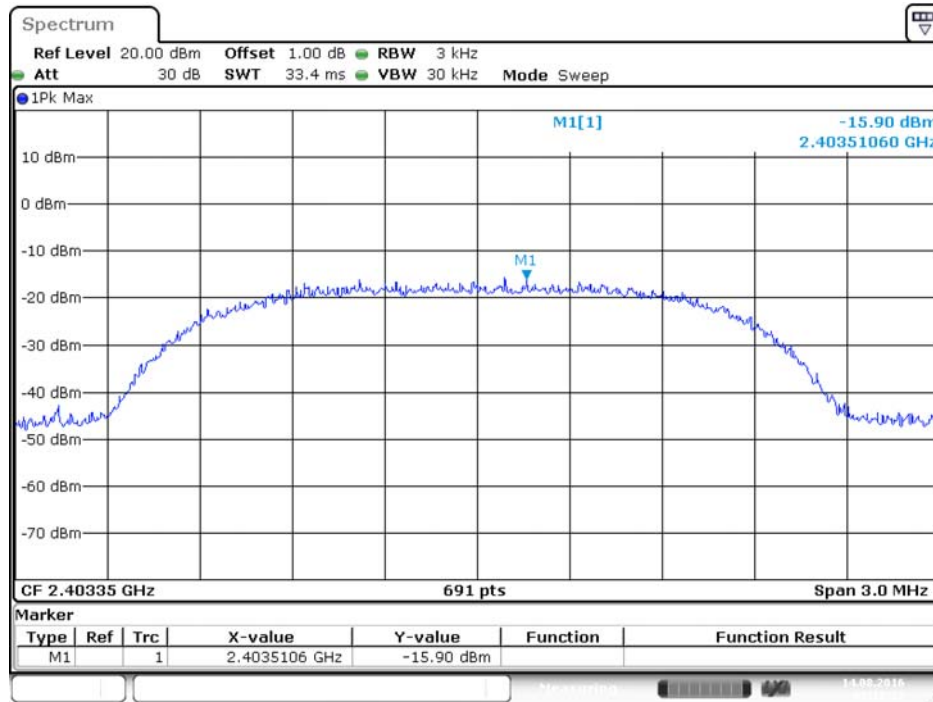

Date: 14.AUG.2016 03:12:37

4.4. 6dB Spectrum Bandwidth Measurement

4.4.1. Limit

For digital modulation systems, the minimum 6dB bandwidth shall be at least 500 kHz.

4.4.2. Measuring Instruments and Setting

Please refer to section 5 of equipments list in this report. The following table is the setting of the spectrum analyzer.

6dB Spectrum Bandwidth	
Spectrum Parameters	Setting
Attenuation	Auto
Span Frequency	> 6dB Bandwidth
RBW	100kHz
VBW	$\geq 3 \times \text{RBW}$
Detector	Peak
Trace	Max Hold
Sweep Time	Auto
99% Occupied Bandwidth	
Spectrum Parameters	Setting
Span	1.5 times to 5.0 times the OBW
RBW	1 % to 5 % of the OBW
VBW	$\geq 3 \times \text{RBW}$
Detector	Peak
Trace	Max Hold

4.4.3. Test Procedures

For Radiated 6dB Bandwidth Measurement:

1. The transmitter was radiated to the spectrum analyzer in peak hold mode.
2. Test was performed in accordance with KDB558074 D01 v03r05 for Performing Compliance Measurements on Digital Transmission Systems (DTS) - section 8.0 DTS bandwidth=> 8.1 Option 1.
3. Measured the spectrum width with power higher than 6dB below carrier.

4.4.4. Test Setup Layout

For Radiated 6dB Bandwidth Measurement:

This test setup layout is the same as that shown in section 4.5.4.

4.4.5. Test Deviation

There is no deviation with the original standard.

4.4.6. EUT Operation during Test

The EUT was programmed to be in continuously transmitting mode.

4.4.7. Test Result of 6dB Spectrum Bandwidth

Temperature	20°C	Humidity	54%
Test Engineer	Serway Li		

Channel	Frequency	6dB Bandwidth (MHz)	99% Occupied Bandwidth (MHz)	Min. Limit (kHz)	Test Result
1	2403.35 MHz	1.62	1.95	500.00	Complies
20	2441.35 MHz	1.63	1.95	500.00	Complies
38	2477.35 MHz	1.64	1.95	500.00	Complies

Note: All the test values were listed in the report.

For plots, only the channel with worse result was shown.

6 dB Bandwidth Plot / 2403.35 MHz

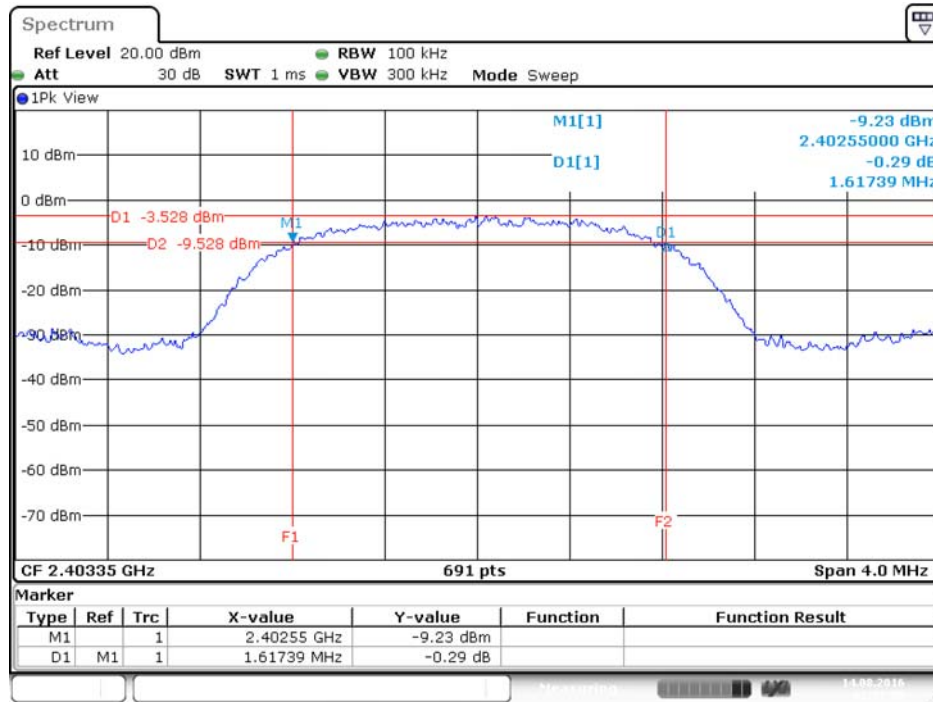

Date: 14.AUG.2016 02:57:50

99% Occupied Bandwidth Plot / 2441.35 MHz

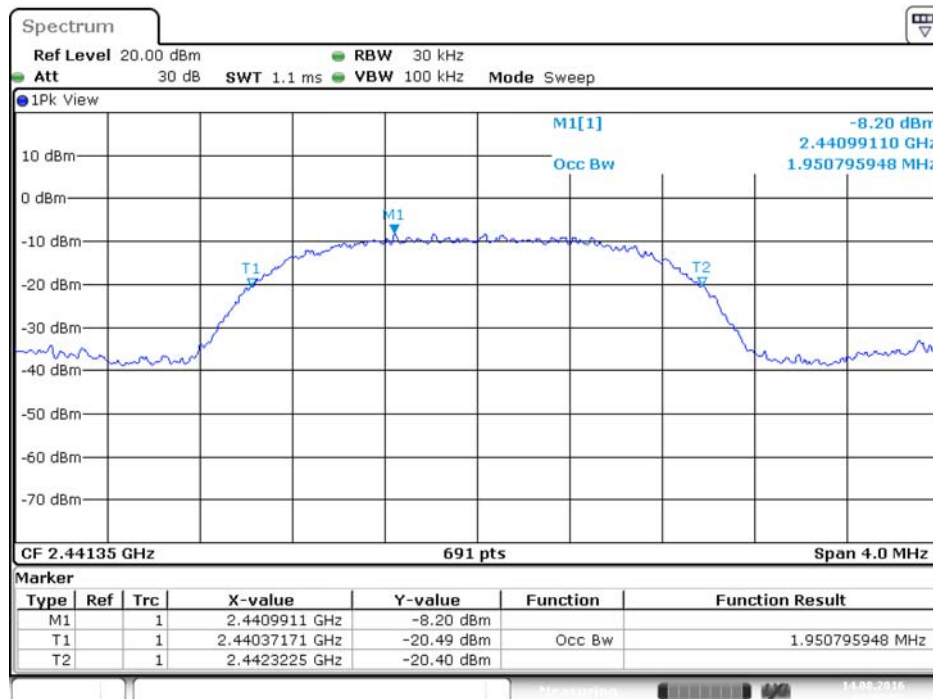

Date: 14.AUG.2016 03:07:53

4.5. Radiated Emissions Measurement

4.5.1. Limit

30dBc in any 100 kHz bandwidth outside the operating frequency band. In case the emission fall within the restricted band specified on 15.205(a), then the 15.209(a) limit in the table below has to be followed.

Frequencies (MHz)	Field Strength (micровolts/meter)	Measurement Distance (meters)
0.009~0.490	2400/F(kHz)	300
0.490~1.705	24000/F(kHz)	30
1.705~30.0	30	30
30~88	100	3
88~216	150	3
216~960	200	3
Above 960	500	3

4.5.2. Measuring Instruments and Setting

Please refer to section 5 of equipments list in this report. The following table is the setting of spectrum analyzer and receiver.

Spectrum Parameter	Setting
Attenuation	Auto
Start Frequency	1000 MHz
Stop Frequency	10th carrier harmonic
RBW / VBW (Emission in restricted band)	1MHz / 3MHz for Peak, 1MHz / 1/T for Average
RBW / VBW (Emission in non-restricted band)	100kHz / 300kHz for peak

Receiver Parameter	Setting
Attenuation	Auto
Start ~ Stop Frequency	9kHz~150kHz / RBW 200Hz for QP
Start ~ Stop Frequency	150kHz~30MHz / RBW 9kHz for QP
Start ~ Stop Frequency	30MHz~1000MHz / RBW 120kHz for QP

4.5.3. Test Procedures

1. Configure the EUT according to ANSI C63.10. The EUT was placed on the top of the turntable 1.5 meter above ground. The phase center of the receiving antenna mounted on the top of a height-variable antenna tower was placed 1m & 3m far away from the turntable.
2. Power on the EUT and all the supporting units. The turntable was rotated by 360 degrees to determine the position of the highest radiation.
3. The height of the broadband receiving antenna was varied between one meter and four meters above ground to find the maximum emissions field strength of both horizontal and vertical polarization.
4. For each suspected emissions, the antenna tower was scan (from 1 M to 4 M) and then the turntable was rotated (from 0 degree to 360 degrees) to find the maximum reading.
5. Set the test-receiver system to Peak or CISPR quasi-peak Detect Function with specified bandwidth under Maximum Hold Mode.
6. For emissions above 1GHz, use 1MHz VBW and 3MHz RBW for peak reading. Then 1MHz RBW and 1/T VBW for average reading in spectrum analyzer.
7. If the emissions level of the EUT in peak mode was 3 dB lower than the average limit specified, then testing will be stopped and peak values of EUT will be reported, otherwise, the emissions which do not have 3 dB margin will be repeated one by one using the quasi-peak method for below 1GHz.
8. For testing above 1GHz, the emissions level of the EUT in peak mode was lower than average limit (that means the emissions level in peak mode also complies with the limit in average mode), then testing will be stopped and peak values of EUT will be reported, otherwise, the emissions will be measured in average mode again and reported.
9. In case the emission is lower than 30MHz, loop antenna has to be used for measurement and the recorded data should be QP measured by receiver. High – Low scan is not required in this case.

4.5.4. Test Setup Layout

For Radiated Emissions: 9kHz ~30MHz

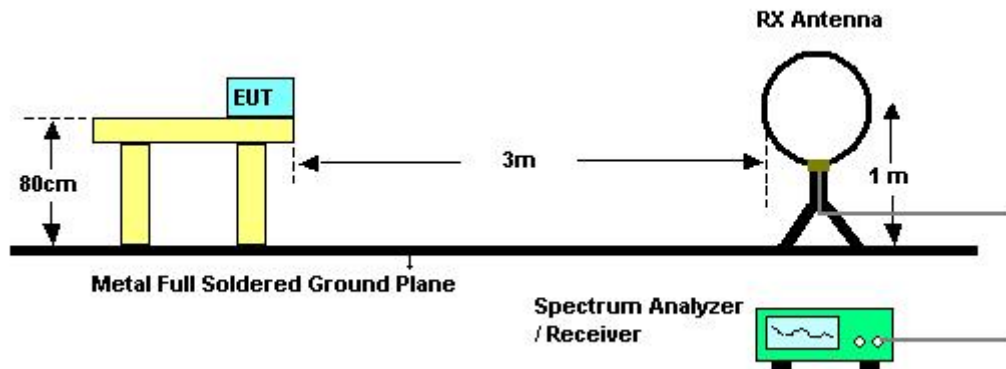

For Radiated Emissions: 30MHz~1GHz

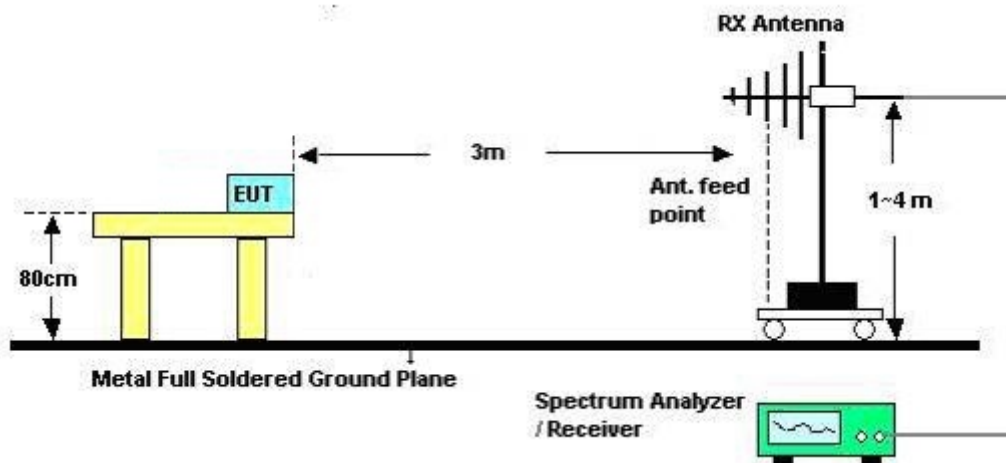

For Radiated Emissions: Above 1GHz

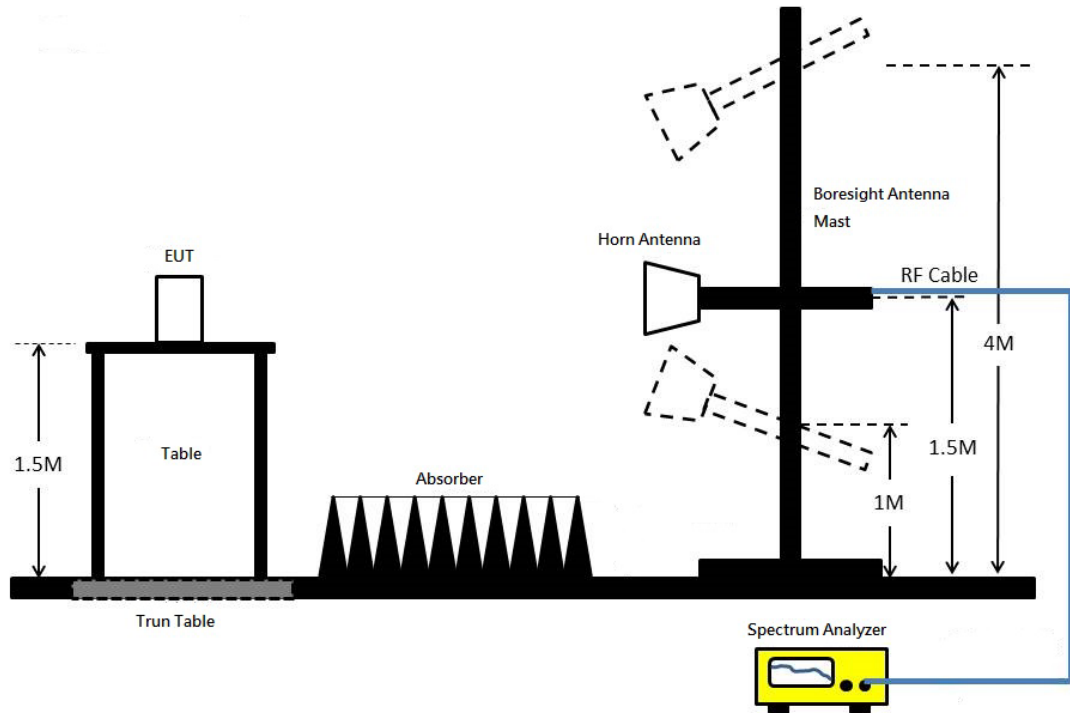

4.5.5. Test Deviation

There is no deviation with the original standard.

4.5.6. EUT Operation during Test

The EUT was programmed to be in continuously transmitting mode.

4.5.7. Results of Radiated Emissions (9kHz~30MHz)

Temperature	23.7°C	Humidity	52%
Test Engineer	John Tong & Zero Chen	Configurations	Normal Link
Test Date	Jul. 25, 2016	Test Mode	Mode 2

Freq. (MHz)	Level (dBuV)	Over Limit (Db)	Limit Line (dBuV)	Remark
-	-	-	-	See Note

Note:

The amplitude of spurious emissions that are attenuated by more than 20 Db below the permissible value has no need to be reported.

Distance extrapolation factor = $40 \log (\text{specific distance} / \text{test distance})$ (Db);

Limit line = specific limits (dBuV) + distance extrapolation factor.

4.5.8. Results of Radiated Emissions (30MHz~1GHz)

Temperature	23.7°C	Humidity	52%
Test Engineer	John Tong & Zero Chen	Configurations	Normal Link
Test Mode	Mode 2		

Horizontal

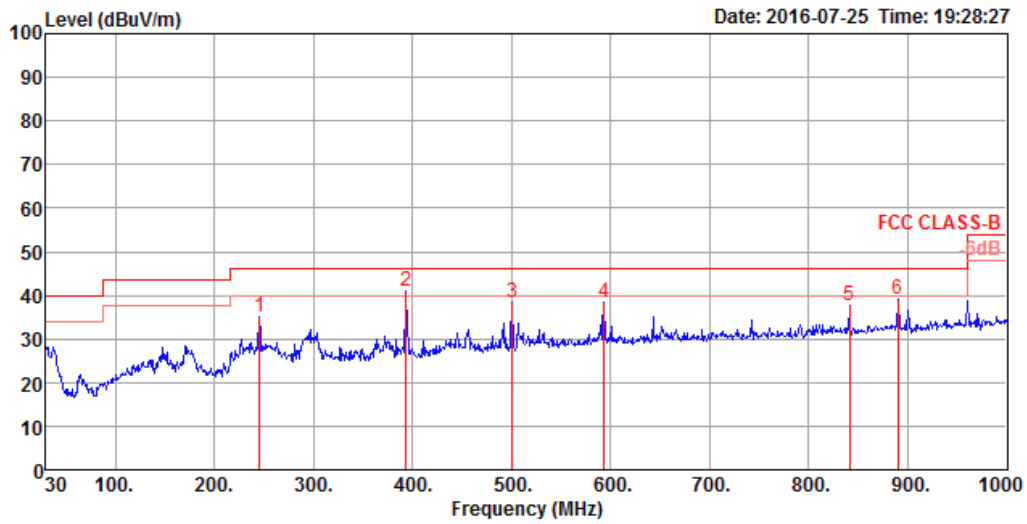

	Freq	Level	Limit	Over	Read	CableAntenna	Preamp	A/Pos	T/Pos	Remark	Pol/Phase
	MHz	dBuV/m	dBuV/m	dB	dBuV	dB	dB/m	dB	cm	deg	
1	245.34	34.87	46.00	-11.13	47.10	1.33	18.75	32.31	100	145 Peak	HORIZONTAL
2	393.75	40.99	46.00	-5.01	49.08	1.71	22.53	32.33	100	244 Peak	HORIZONTAL
3	500.45	38.39	46.00	-7.61	44.77	1.94	24.03	32.35	100	142 Peak	HORIZONTAL
4	593.57	38.24	46.00	-7.76	43.22	2.11	25.32	32.41	150	176 Peak	HORIZONTAL
5	840.92	37.54	46.00	-8.46	39.77	2.51	27.30	32.04	100	126 Peak	HORIZONTAL
6	890.39	38.98	46.00	-7.02	40.56	2.56	27.64	31.78	100	205 Peak	HORIZONTAL

Vertical

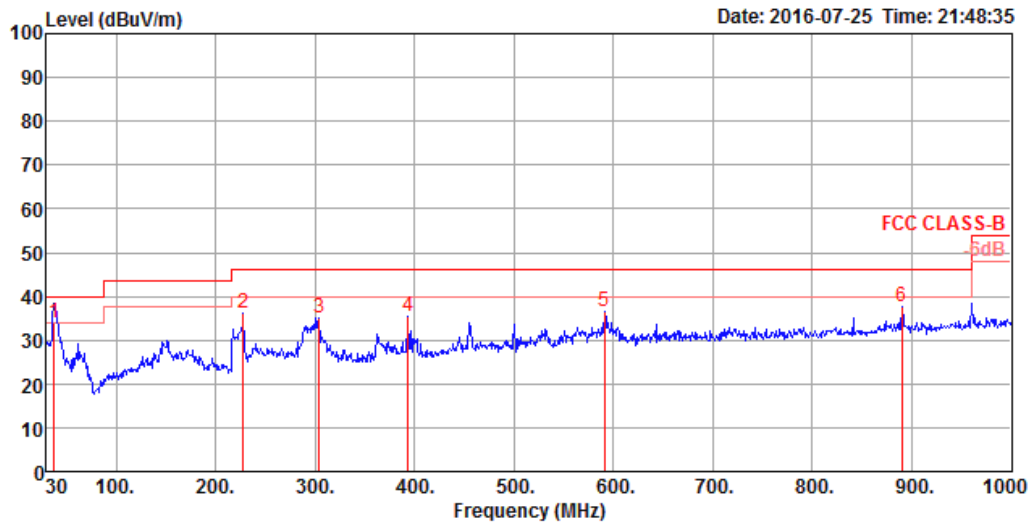

	Freq	Level	Limit Line	Over Limit	Read Level	CableAntenna Loss	Preamp Factor	A/Pos	T/Pos	Remark	Pol/Phase
	MHz	dBuV/m	dBuV/m	dB	dBuV	dB	dB/m	dB	cm	deg	
1	37.76	34.13	40.00	-5.87	44.49	0.53	21.51	32.40	100	116 QP	VERTICAL
2	227.88	36.07	46.00	-9.93	49.73	1.29	17.36	32.31	100	0 Peak	VERTICAL
3	304.51	35.15	46.00	-10.85	45.81	1.49	20.13	32.28	200	4 Peak	VERTICAL
4	393.75	35.60	46.00	-10.40	43.69	1.71	22.53	32.33	150	135 Peak	VERTICAL
5	590.66	36.62	46.00	-9.38	41.62	2.11	25.30	32.41	100	198 Peak	VERTICAL
6	890.39	37.56	46.00	-8.44	39.14	2.56	27.64	31.78	100	252 Peak	VERTICAL

Note:

The amplitude of spurious emissions that are attenuated by more than 20dB below the permissible value has no need to be reported.

Emission level (dBuV/m) = 20 log Emission level (uV/m).

Corrected Reading: Antenna Factor + Cable Loss + Read Level - Preamp Factor = Level.

4.5.9. Results for Radiated Emissions (1GHz~10th Harmonic)

Temperature	23.7°C	Humidity	52%
Test Engineer	John Tong & Zero Chen	Configurations	CH 1 / Ant. 2
Test Date	Jul. 21, 2016		

Horizontal

	Freq	Level	Limit Line	Over Limit	Read Level	Cable Loss	Antenna Factor	Preamp Factor	A/Pos	T/Pos	Remark	Pol/Phase
	MHz	dBuV/m	dBuV/m	dB	dBuV	dB	dB/m	dB	cm	deg		
1	4806.86	40.50	54.00	-13.50	33.93	7.22	31.10	31.75	290	260	Average	HORIZONTAL
2	4807.30	49.41	74.00	-24.59	42.84	7.22	31.10	31.75	290	260	Peak	HORIZONTAL

Vertical

	Freq	Level	Limit Line	Over Limit	Read Level	Cable Loss	Antenna Factor	Preamp Factor	A/Pos	T/Pos	Remark	Pol/Phase
	MHz	dBuV/m	dBuV/m	dB	dBuV	dB	dB/m	dB	cm	deg		
1	4806.66	38.86	54.00	-15.14	32.29	7.22	31.10	31.75	320	271	Average	VERTICAL
2	4807.18	48.14	74.00	-25.86	41.57	7.22	31.10	31.75	320	271	Peak	VERTICAL

Temperature	23.7°C	Humidity	52%
Test Engineer	John Tong & Zero Chen	Configurations	CH 20 / Ant. 2
Test Date	Jul. 21, 2016		

Horizontal

	Freq	Level	Limit Line	Over Limit	Read Level	Cable Loss	Antenna Factor	Preamp Factor	A/Pos	T/Pos	Remark	Pol/Phase
	MHz	dBuV/m	dBuV/m	dB	dBuV	dB	dB/m	dB	cm	deg		
1	4882.82	40.39	54.00	-13.61	33.68	7.19	31.23	31.71	311	259	Average	HORIZONTAL
2	4883.42	48.77	74.00	-25.23	42.06	7.19	31.23	31.71	311	259	Peak	HORIZONTAL

Vertical

	Freq	Level	Limit Line	Over Limit	Read Level	Cable Loss	Antenna Factor	Preamp Factor	A/Pos	T/Pos	Remark	Pol/Phase
	MHz	dBuV/m	dBuV/m	dB	dBuV	dB	dB/m	dB	cm	deg		
1	4882.46	48.57	74.00	-25.43	41.86	7.19	31.23	31.71	100	312	Peak	VERTICAL
2	4882.74	38.98	54.00	-15.02	32.27	7.19	31.23	31.71	100	312	Average	VERTICAL

Temperature	23.7°C	Humidity	52%
Test Engineer	John Tong & Zero Chen	Configurations	CH 38 / Ant. 2
Test Date	Jul. 21, 2016		

Horizontal

	Freq	Level	Limit Line	Over Limit	Read Level	Cable Loss	Antenna Factor	Preamp Factor	A/Pos	T/Pos	Remark	Pol/Phase
	MHz	dBuV/m	dBuV/m	dB	dBuV	dB	dB/m	dB	cm	deg		
1	4952.07	39.95	54.00	-14.05	33.14	7.18	31.31	31.68	312	258	Average	HORIZONTAL
2	4954.34	48.68	74.00	-25.32	41.85	7.17	31.34	31.68	312	258	Peak	HORIZONTAL

Vertical

	Freq	Level	Limit Line	Over Limit	Read Level	Cable Loss	Antenna Factor	Preamp Factor	A/Pos	T/Pos	Remark	Pol/Phase
	MHz	dBuV/m	dBuV/m	dB	dBuV	dB	dB/m	dB	cm	deg		
1	4954.54	40.07	54.00	-13.93	33.24	7.17	31.34	31.68	282	297	Average	VERTICAL
2	4955.06	48.78	74.00	-25.22	41.95	7.17	31.34	31.68	282	297	Peak	VERTICAL

Note:

The amplitude of spurious emissions that are attenuated by more than 20dB below the permissible value has no need to be reported.

Emission level (dBuV/m) = 20 log Emission level (uV/m).

Corrected Reading: Antenna Factor + Cable Loss + Read Level - Preamp Factor = Level.

4.6. Emissions Measurement

4.6.1. Limit

30dBc in any 100 kHz bandwidth outside the operating frequency band. In case the emission fall within the restricted band specified on 15.205(a), then the 15.209(a) limit in the table below has to be followed.

Frequencies (MHz)	Field Strength (micovolts/meter)	Measurement Distance (meters)
0.009~0.490	2400/F(kHz)	300
0.490~1.705	24000/F(kHz)	30
1.705~30.0	30	30
30~88	100	3
88~216	150	3
216~960	200	3
Above 960	500	3

4.6.2. Measuring Instruments and Setting

Please refer to section 5 of equipments list in this report. The following table is the setting of the spectrum analyzer.

Spectrum Parameter	Setting
Attenuation	Auto
Span Frequency	100 MHz
RBW / VBW (Emission in restricted band)	1MHz / 3MHz for Peak, 1MHz / 1/T for Average
RBW / VBW (30dBc in any 100 kHz bandwidth emission)	100 kHz / 300 kHz for Peak

4.6.3. Test Procedures

For Radiated band edges Measurement:

1. The test procedure is the same as section 4.5.3.

For Radiated Out of Band Emission Measurement:

1. Test was performed in accordance with KDB558074 D01 v03r05 for Performing Compliance Measurements on Digital Transmission Systems (DTS) Operating Under §15.247 section 11.0 Unwanted Emissions into Non-Restricted Frequency Bands Measurement Procedure.

4.6.4. Test Setup Layout

For Radiated band edges Measurement:

This test setup layout is the same as that shown in section 4.5.4.

For Radiated Out of Band Emission Measurement:

This test setup layout is the same as that shown in section 4.5.4.

4.6.5. Test Deviation

There is no deviation with the original standard.

4.6.6. EUT Operation during Test

The EUT was programmed to be in continuously transmitting mode.

4.6.7. Test Result of Band Edge and Fundamental Emissions

Temperature	23.7°C	Humidity	52%
Test Engineer	John Tong & Zero Chen	Configurations	CH 1, 20, 38 / Ant. 2

Channel 1

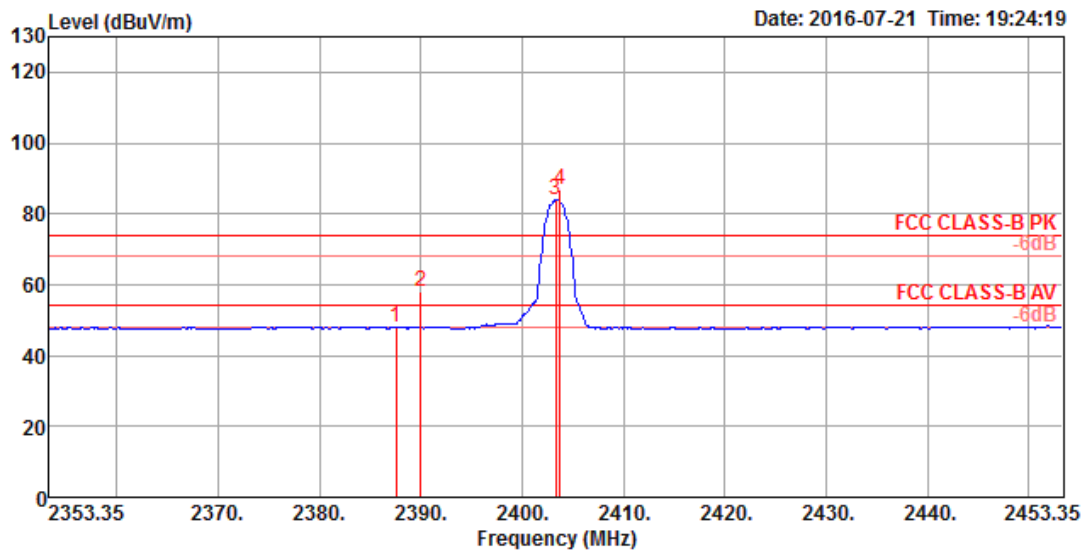

	Freq	Level	Limit Line	Over Limit	Read Level	Cable Loss	Antenna Factor	Preamp Factor	A/Pos	T/Pos	Remark	Pol/Phase
	MHz	dBuV/m	dBuV/m	dB	dBuV	dB	dB/m	dB	cm	deg		
1	2387.55	48.02	54.00	-5.98	16.64	4.33	27.05	0.00	156	62	Average	VERTICAL
2	2390.00	57.84	74.00	-16.16	26.46	4.33	27.05	0.00	156	62	Peak	VERTICAL
3	2403.35	83.93			52.51	4.34	27.08	0.00	156	62	Average	VERTICAL
4	2403.75	86.82			55.40	4.34	27.08	0.00	156	62	Peak	VERTICAL

Item 3, 4 are the fundamental frequency at 2403.35 MHz.

Channel 20

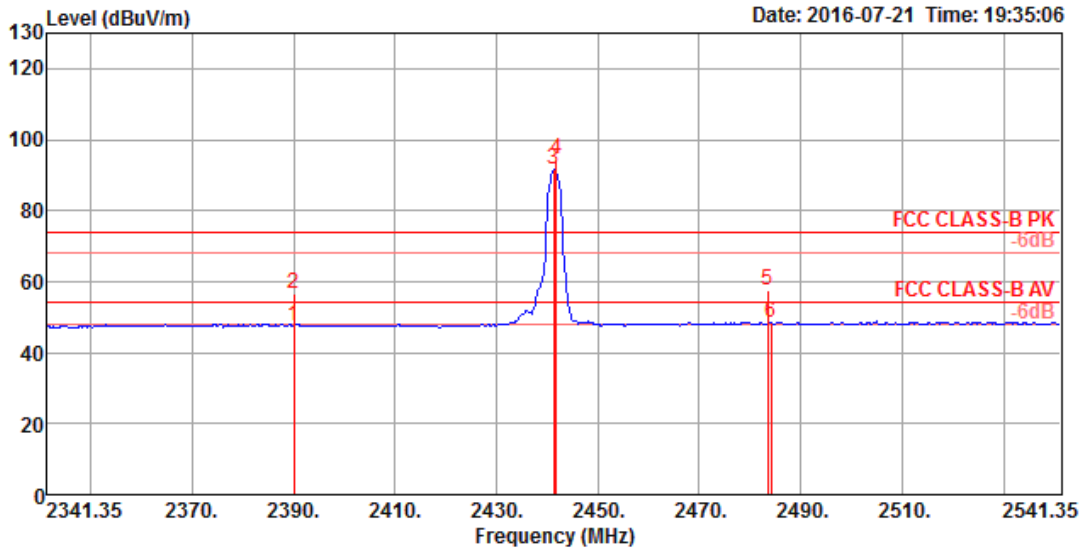

	Freq	Level	Limit Line	Over Limit	Read Level	CableAntenna Loss	Preamp Factor	A/Pos	T/Pos	Remark	Pol/Phase
	MHz	dBuV/m	dBuV/m	dB	dBuV	dB	dB/m	dB	cm	deg	
1	2390.00	47.72	54.00	-6.28	16.34	4.33	27.05	0.00	115	281 Average	HORIZONTAL
2	2390.00	56.76	74.00	-17.24	25.38	4.33	27.05	0.00	115	281 Peak	HORIZONTAL
3	2441.35	91.49			59.93	4.38	27.18	0.00	115	281 Average	HORIZONTAL
4	2441.75	94.53			62.97	4.38	27.18	0.00	115	281 Peak	HORIZONTAL
5	2483.50	57.61	74.00	-16.39	25.92	4.42	27.27	0.00	115	281 Peak	HORIZONTAL
6	2484.15	48.41	54.00	-5.59	16.72	4.42	27.27	0.00	115	281 Average	HORIZONTAL

Item 3, 4 are the fundamental frequency at 2441.35 MHz.

Channel 38

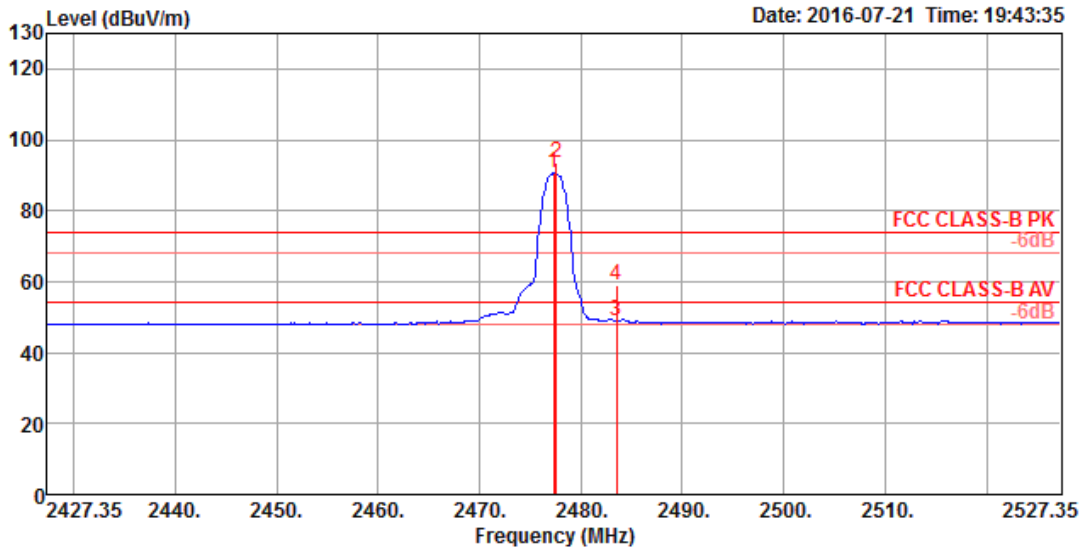

	Freq	Level	Limit Line	Over Limit	Read Level	CableAntenna Loss	Preamp Factor	A/Pos	T/Pos	Remark	Pol/Phase		
	MHz	dBuV/m	dBuV/m	dB	dBuV	dB	dB/m	dB	cm	deg			
1	0	2477.35	90.58		58.92	4.41	27.25	0.00	114	276	Average	HORIZONTAL	
2	0	2477.55	93.60		61.94	4.41	27.25	0.00	114	276	Peak	HORIZONTAL	
3	0	2483.50	48.91	54.00	-5.09	17.22	4.42	27.27	0.00	114	276	Average	HORIZONTAL
4	0	2483.50	59.11	74.00	-14.89	27.42	4.42	27.27	0.00	114	276	Peak	HORIZONTAL

Item 1, 2 are the fundamental frequency at 2477.35 MHz.

For Emission not in Restricted Band

Plot on Configuration / Reference Level

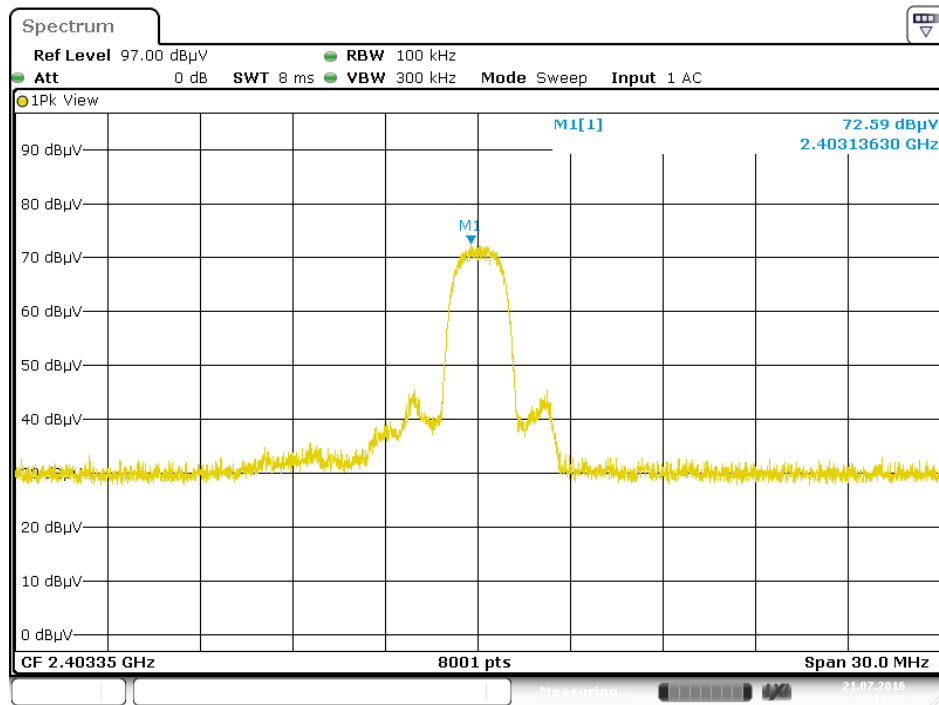

Plot on Configuration / CH 1 / 30MHz~2400MHz (down 30dBc)

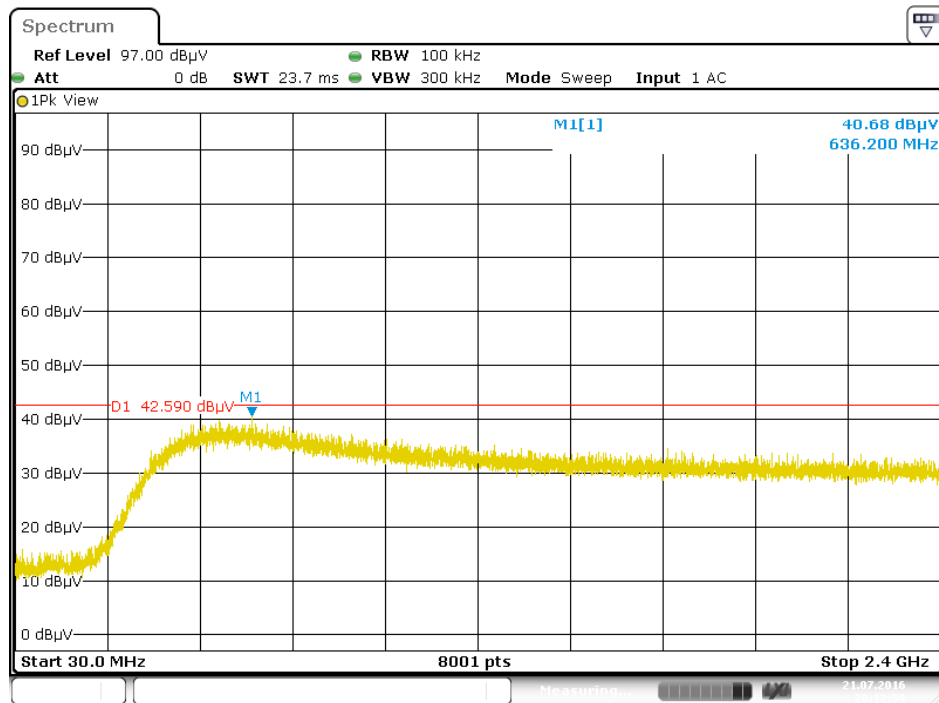

Plot on Configuration / CH 1 / 2483.5MHz~26500MHz (down 30dBc)

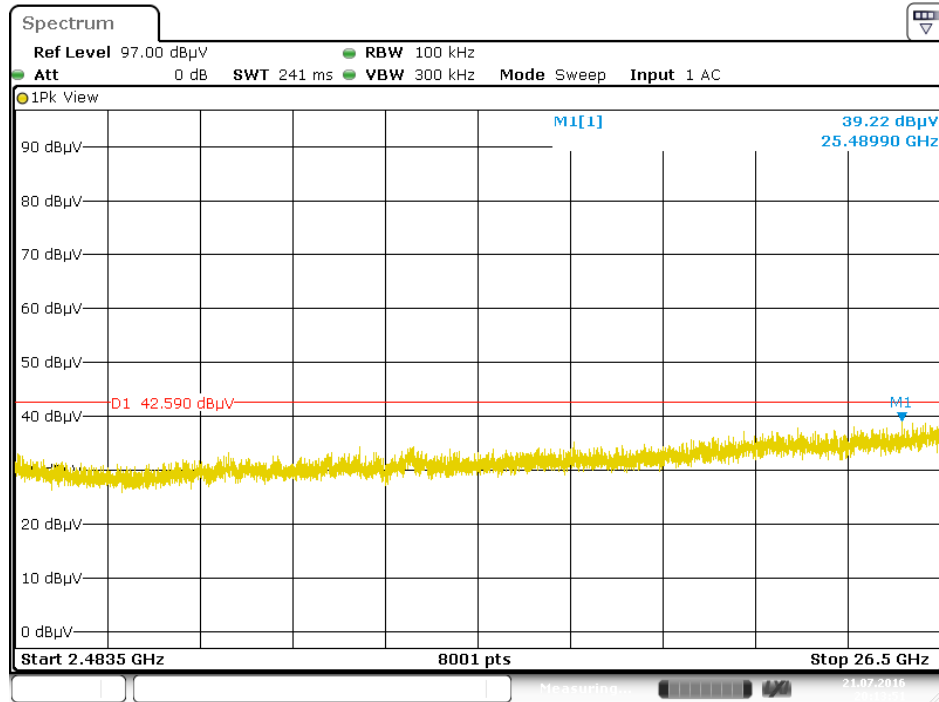

Plot on Configuration / CH 38 / 30MHz~2400MHz (down 30dBc)

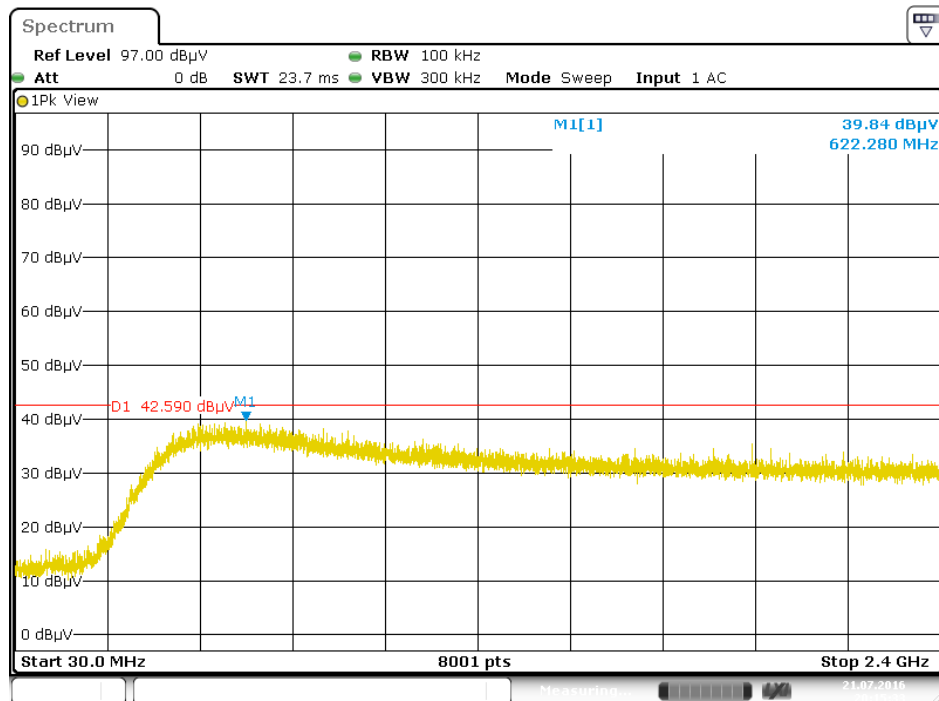

Plot on Configuration / CH 38 / 2483.5MHz~26500MHz (down 30dBc)

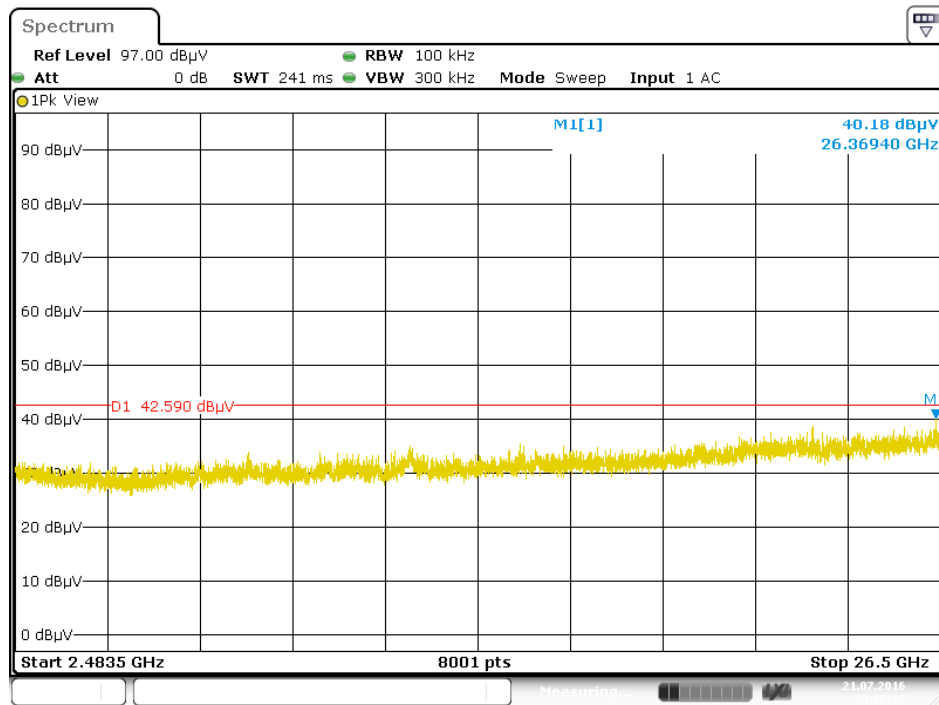

Date: 21.JUL.2016 20:16:12

4.7. Antenna Requirements

4.7.1. Limit

Except for special regulations, the Low-power Radio-frequency Devices must not be equipped with any jacket for installing an antenna with extension cable. An intentional radiator shall be designed to ensure that no antenna other than that furnished by the responsible party shall be used with the device. The use of a permanently attached antenna or of an antenna that uses a unique coupling to the intentional radiator shall be considered sufficient to comply with the provisions of this Section. The manufacturer may design the unit so that the user can replace a broken antenna, but the use of a standard antenna jack or electrical connector is prohibited. Further, this requirement does not apply to intentional radiators that must be professionally installed.

4.7.2. Antenna Connector Construction

Please refer to section 3.3 in this test report; antenna connector complied with the requirements.

5. LIST OF MEASURING EQUIPMENTS

Instrument	Manufacturer	Model No.	Serial No.	Characteristics	Calibration Date	Remark
EMI Receiver	Agilent	N9038A	My52260123	9kHz ~ 8.45GHz	Jan. 27, 2016	Conduction (CO01-CB)
LISN	F.C.C.	FCC-LISN-50-16-2	04083	150kHz ~ 100MHz	Dec. 08, 2015	Conduction (CO01-CB)
LISN	Schwarzbeck	NSLK 8127	8127647	9kHz ~ 30MHz	Dec. 23, 2015	Conduction (CO01-CB)
COND Cable	Woken	Cable	01	150kHz ~ 30MHz	May 24, 2016	Conduction (CO01-CB)
Software	Audix	E3	6.120210n	-	N.C.R.	Conduction (CO01-CB)
BILOG ANTENNA	TESEQ	CBL6112D	37880	20MHz ~ 2GHz	Sep. 03, 2015	Radiation (03CH01-CB)
Horn Antenna	EMCO	3115	00075790	750MHz ~ 18GHz	Oct. 22, 2015	Radiation (03CH01-CB)
Horn Antenna	SCHWARZBECK	BBHA 9170	BBHA9170507	15GHz ~ 40GHz	Mar. 01, 2016	Radiation (03CH01-CB)
Pre-Amplifier	Agilent	8447D	2944A10991	0.1MHz ~ 1.3GHz	Mar. 15, 2016	Radiation (03CH01-CB)
Pre-Amplifier	Agilent	8449B	3008A02310	1GHz ~ 26.5GHz	Jan. 18, 2016	Radiation (03CH01-CB)
Pre-Amplifier	WM	TF-130N-R1	923365	26GHz ~ 40GHz	Nov. 13, 2015	Radiation (03CH01-CB)
Spectrum Analyzer	R&S	FSP40	100056	9kHz ~ 40GHz	Oct. 27, 2015	Radiation (03CH01-CB)
EMI Test	R&S	ESCS	100355	9kHz ~ 2.75GHz	May 16, 2016	Radiation (03CH01-CB)
RF Cable-low	Woken	Low Cable-1	N/A	30 MHz ~ 1 GHz	Nov. 02, 2015	Radiation (03CH01-CB)
RF Cable-high	Woken	High Cable-16	N/A	1 GHz ~ 18 GHz	Nov. 02, 2015	Radiation (03CH01-CB)
RF Cable-high	Woken	High Cable-17	N/A	1 GHz ~ 18 GHz	Nov. 02, 2015	Radiation (03CH01-CB)
RF Cable-high	Woken	High Cable-40G-1	N/A	18GHz ~ 40 GHz	Nov. 02, 2015	Radiation (03CH01-CB)
RF Cable-high	Woken	High Cable-40G-2	N/A	18GHz ~ 40 GHz	Nov. 02, 2015	Radiation (03CH01-CB)
Loop Antenna	Teseq	HLA 6120	24155	9kHz - 30 MHz	Mar. 16, 2016*	Radiation (03CH01-CB)
Test Software	Audix	E3	6.2009-I0-7	N/A	N/A	Radiation (03CH01-CB)
Spectrum analyzer	R&S	FSV40	100979	9kHz~40GHz	Dec. 09, 2015	Conducted (TH01-CB)
Temp. and Humidity Chamber	Ten Billion	TTH-D3SP	TBN-931011	-30~100 degree	Jun. 03, 2016	Conducted (TH01-CB)
RF Cable-high	Woken	RG402	High Cable-6	1 GHz – 26.5 GHz	Nov. 02, 2015	Conducted (TH01-CB)
RF Cable-high	Woken	RG402	High Cable-7	1 GHz – 26.5 GHz	Nov. 02, 2015	Conducted (TH01-CB)
RF Cable-high	Woken	RG402	High Cable-8	1 GHz – 26.5 GHz	Nov. 02, 2015	Conducted (TH01-CB)
RF Cable-high	Woken	RG402	High Cable-9	1 GHz – 26.5 GHz	Nov. 02, 2015	Conducted (TH01-CB)

Instrument	Manufacturer	Model No.	Serial No.	Characteristics	Calibration Date	Remark
RF Cable-high	Woken	RG402	High Cable-10	1 GHz – 26.5 GHz	Nov. 02, 2015	Conducted (TH01-CB)
Power Sensor	Agilent	U2021XA	MY53410001	50MHz~18GHz	Nov. 02, 2015	Conducted (TH01-CB)

Note: Calibration Interval of instruments listed above is one year.

*Calibration Interval of instruments listed above is two years.

N.C.R. means Non-Calibration required.

6. MEASUREMENT UNCERTAINTY

Test Items	Uncertainty	Remark
Conducted Emission (150kHz ~ 30MHz)	3.2 dB	Confidence levels of 95%
Radiated Emission (30MHz ~ 1,000MHz)	3.6 dB	Confidence levels of 95%
Radiated Emission (1GHz ~ 18GHz)	3.7 dB	Confidence levels of 95%
Radiated Emission (18GHz ~ 40GHz)	3.5 dB	Confidence levels of 95%
Conducted Emission	1.7 dB	Confidence levels of 95%