

WARNING!

Use of a headset that covers both ears will impair your ability to hear other sounds. Use of such a headset while operating a motor vehicle or riding a bicycle may create a serious hazard to you and or others, and is prohibited by law in some regions.

WARRANTY

Limited Warranty

- This warranty covers defects in materials and workmanship of Mobile Products manufactured, sold or certified by Plantronics which were purchased and used in the United States.
- This warranty lasts for one year from the date of purchase of the Products.
- This warranty extends to you only if you are the end user with the original purchase receipt.
- We will, at our option, repair or replace the Products that do not conform to the warranty. We may use functionally equivalent reconditioned/ refurbished/ remanufactured/ pre-owned or new Products or parts.
- To obtain service in the U.S. contact Plantronics at (866) 363-BLUE (2583).
- THIS IS PLANTRONICS COMPLETE WARRANTY FOR THE PRODUCTS.
- This warranty gives you specific legal rights, and you may also have other rights which vary from state to state or province to province. Please contact your dealer or our service center for the full details of our limited warranty, including items not covered by this limited warranty.

© 2005 Plantronics, Inc. All rights reserved. Plantronics, the logo design, Pulsar and Sound Innovation are trademarks or registered trademarks of Plantronics, Inc. The Bluetooth name and the Bluetooth trademarks are owned by Bluetooth SIG, Inc, and are used by Plantronics, Inc. under license.
Printed in USA August 2005.
Part #69828-07

DRAFT

Changes:

1. Replace “590” with “P590”
2. Replace “590A” with “35BAA”
3. Add “Industry Canada” notice, Page 15

→ Ⓞ • • → USER GUIDE_

PULSAR™ 590 & 590A

STEREO BLUETOOTH® HEADSET



TABLE OF CONTENTS

Package Contents	2
Features	3
Charging	5
Powering	6
Indicator Lights	6
Pairing	7
Adjusting	9
In-flight & Other Uses	10
Headset Controls	11
Troubleshooting	13
Technical Assistance	14
Regulatory Notices	14

ONLINE PRODUCT REGISTRATION

Visit www.plantronics.com/productregistration to register your product online so we can provide you with the best possible service and technical support.

PACKAGE CONTENTS

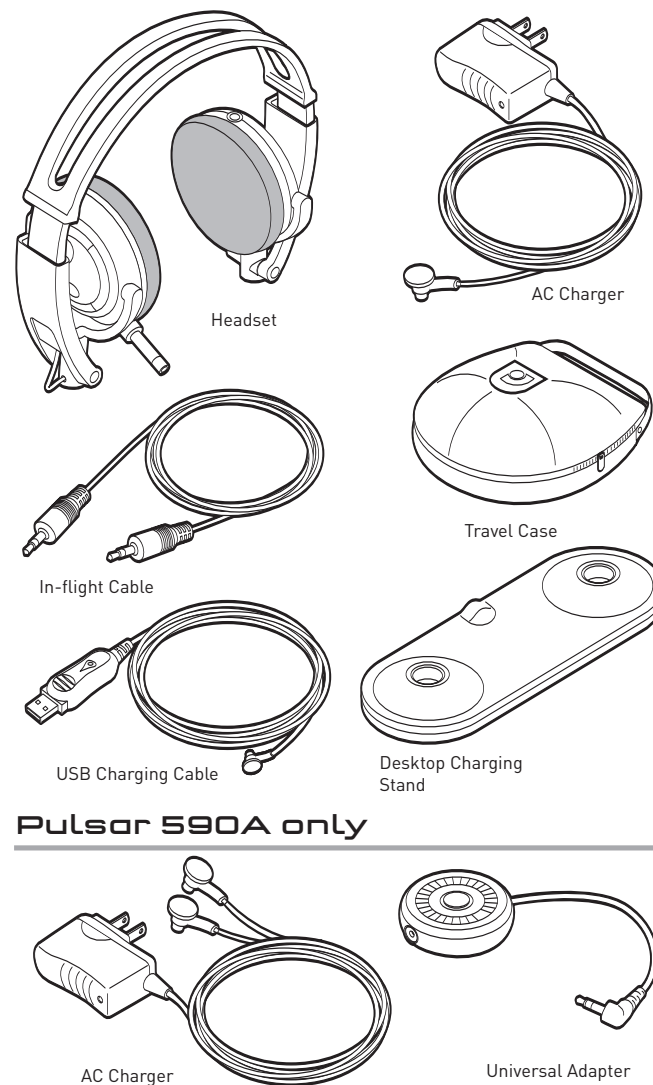

Pulsar 590A only

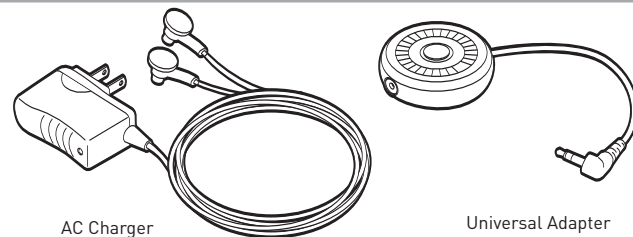

FEATURES

HEADSET

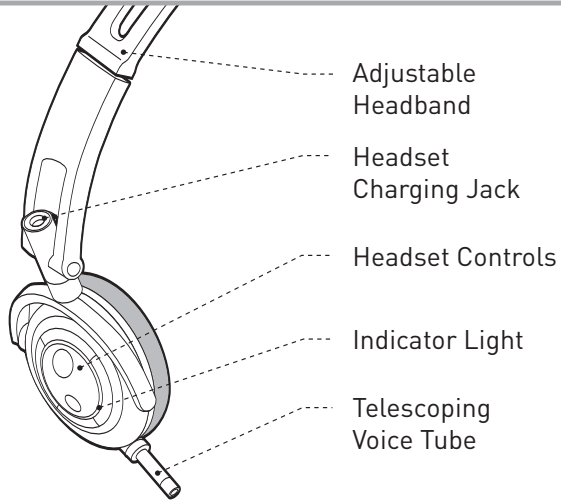

HEADSET CONTROLS

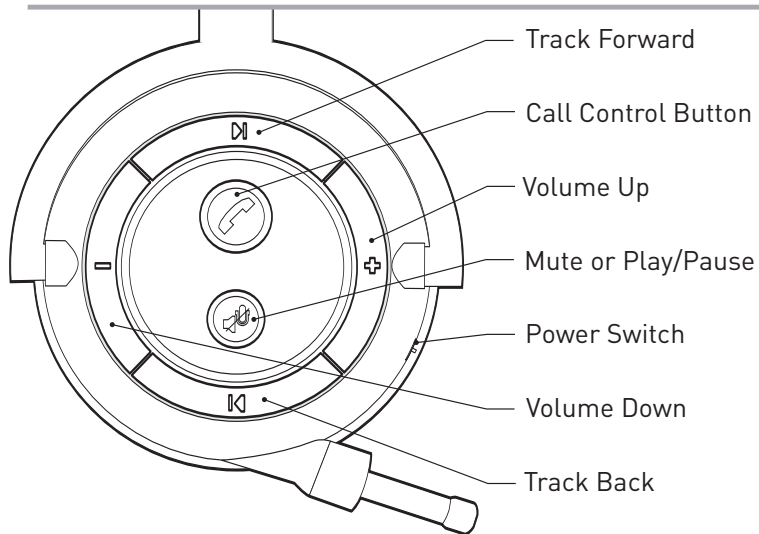

FEATURES

DESKTOP CHARGING STAND

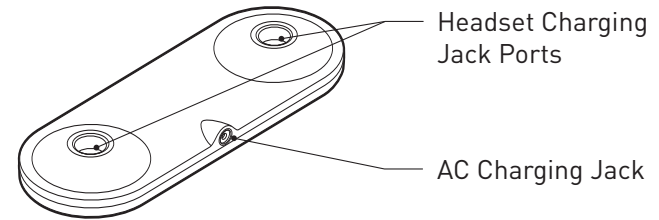

UNIVERSAL ADAPTER*

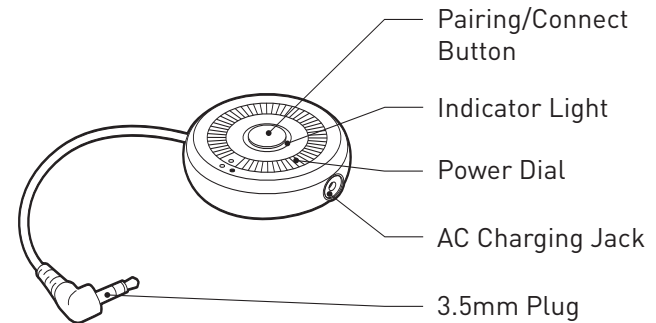

*Universal adapter included with Pulsar 590A only or sold separately.

CHARGING

Option A*



1. Connect AC charger to desktop charging stand.
2. Rotate earpieces under headband so pointing inward.
3. Place headset charging jacks into charging jack ports.

Option B*

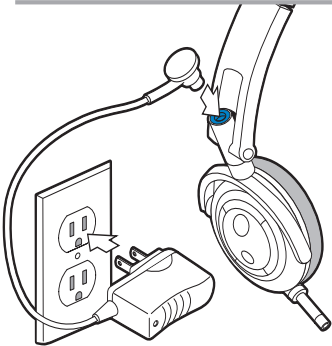

Option C*

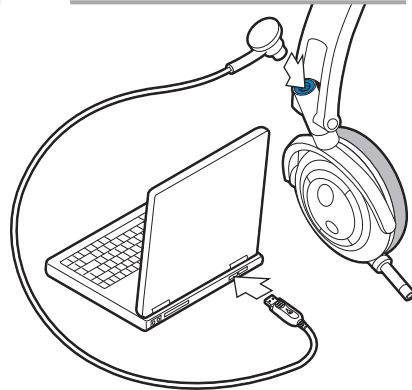

*Charge for 3 hours before first use. Headset indicator light will flash red when charging and turn solid blue when fully charged.

POWERING

Headset

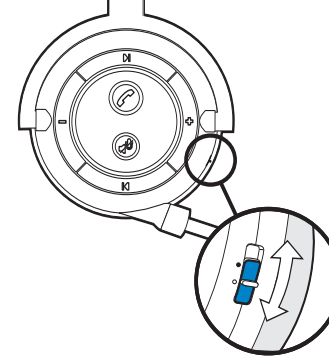

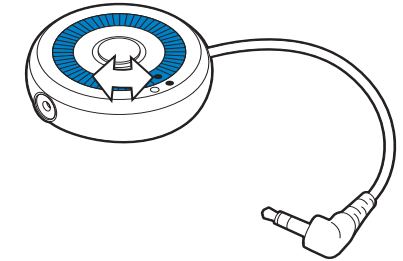

Slide power switch up/down to turn power on/off.

Universal Adapter



Rotate power dial counterclockwise/clockwise to turn power on/off.

INDICATOR LIGHTS

Condition	Indicator Light
Charging	Flashes red When fully charged light will turn blue
Power	Flashes red
Battery Indicators	<ul style="list-style-type: none"> • 3 red flashes for full charge  • 2 red flashes for half charge  • 1 red flash for low battery 
Pairing	Flashes red and blue
Streaming Audio/ Connected to Headset	Flashes blue

PAIRING

PAIRING WITH BLUETOOTH® DEVICE

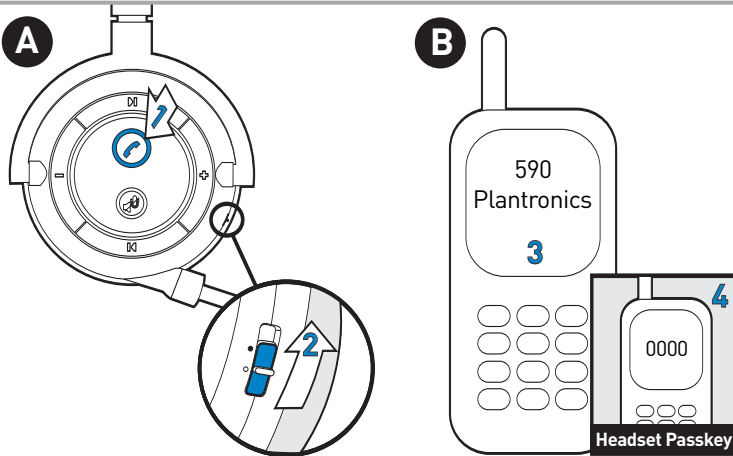

While pressing call control button, (1) power headset on. (2)

1. While headset indicator light is flashing red and blue, navigate to the Bluetooth® discovery screen on your device.
2. Place device in Discovery mode.
3. Select "590 Plantronics." (3)
4. When asked for passkey, enter 0000. (4)

PAIRING

PAIRING HEADSET WITH UNIVERSAL ADAPTER (PULSAR 590A ONLY)

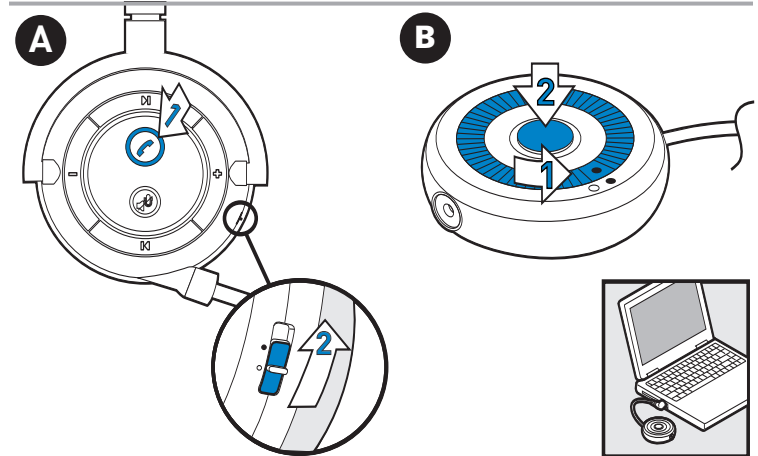

NOTE: The Pulsar headset is paired with the universal adapter at the factory. However, after powering on, if adapter and headset flash red, rather than blue, you may need to connect or pair them again. To reconnect, simply press the adapter pairing/connect button. To pair again, follow directions below.

While pressing call control button, (1) power headset on. (2)

- While headset is flashing red and blue:
1. Power adapter on.
 2. Press and hold the adapter pairing/connect button for 5-7 seconds until the adapter is flashing red and blue, then release the button.

Headset and adapter will flash blue when paired successfully.

ADJUSTING

1

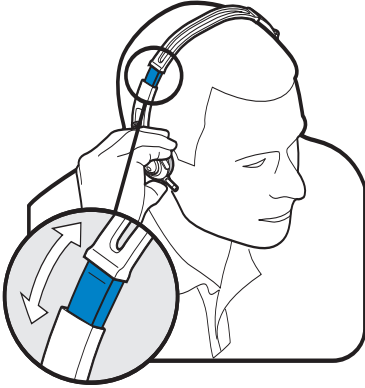

Position so that telescoping voice tube is on right ear. Adjust headband if desired.

2

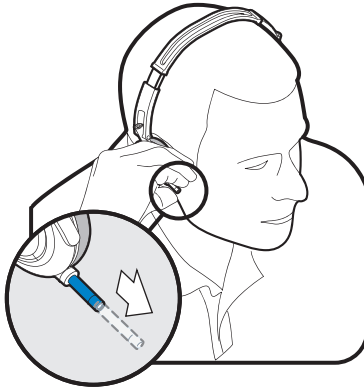

Point telescoping voice tube tip toward mouth and extend for optimal voice transmission.

IN-FLIGHT AND OTHER USES

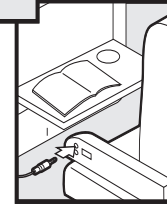
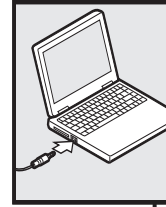

In-flight cable can be used with any 3.5mm audio jack to convert your wireless Pulsar 590 headset into wired headphones.

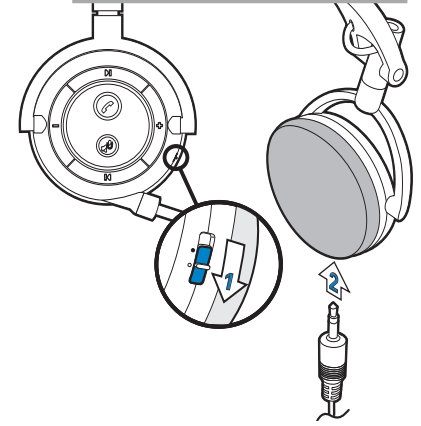

1. Power headset off. (1) In-flight cable will not operate when headset is powered on.
2. Insert in-flight cable into 3.5mm jack on left earpiece. (2)

Note: Telescoping voice tube is disabled when in-flight cable is in use.

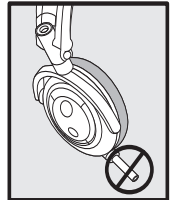

HEADSET CONTROLS

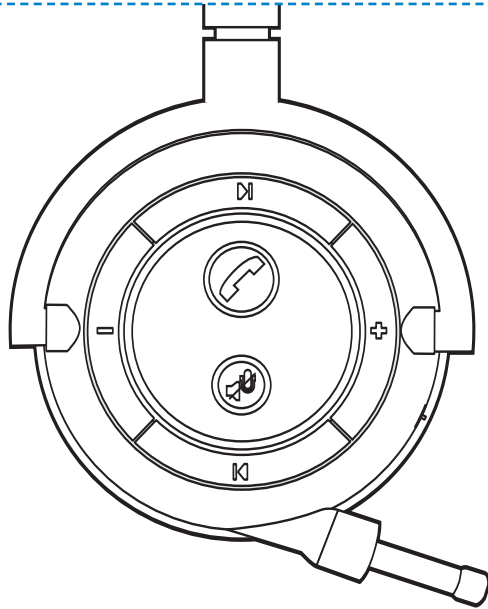

FEATURES

Key	Feature	Action	Tone
	Making / answering / ending calls	Short key press.	High tone.
	Switching a call from phone to headset	Short key press.	High tone.
	Switching a call from headset to phone	Long key press.	High tone followed by low tone.
	Power On / Off	Slide switch.	

HEADSET CONTROLS

FEATURES

Key	Feature	Action	Tone
	Track forward and back*	Short press to skip / go back to next / previous track.	High tone.
	Muting a call	Short press to mute / unmute telescoping voice tube or speakers.	Repeating low tone.
	Play and pause*	Short press to pause / resume audio.	High tone.
	Adjusting volume	Short press for incremental change. Hold for continuous change.	Mid tone for each adjustment. Double low tone at limit.

HANDS-FREE FEATURES

Features must be supported by host device or service provider.

	Activate last number redial	Double short key press.	High tone for each key press.
	Activate voice dial	Long key press.	High tone followed by low tone.
	Call reject	Long key press.	High tone followed by low tone.

*Only works with Bluetooth® Audio/Video Remote Control Profile (AVRCP); does not work when using universal adapter.

TROUBLESHOOTING

PULSAR 590 & 590A

Problem	Solution
My headset does not work with my phone.	See pages (7-8) "Pairing with Bluetooth Device."
Callers cannot hear me.	Headset is muted. Press the mute button on the headset to unmute the microphone.
Callers say my voice is too quiet.	Ensure that the telescoping voice tube is fully extended and point the tip toward the corner of your mouth. Ensure the end of the microphone is not blocked with dirt or debris.
I cannot hear caller/dial tone.	<ul style="list-style-type: none">•Headset is turned off. Check the power switch and slide up to ON.•Headset is out of range. Walk to within 30 feet (10 meters) of the phone and check the Bluetooth link.•Headset battery is dead. Charge your battery using the AC charger supplied.•Listening volume is too low. Press the Volume Up button to increase the sound heard in the headset.
Headset doesn't charge in the desktop charging stand.	Ensure that headset is completely inserted into the charging stand—if properly inserted, a red indicator light on the headset will slowly flash.
I cannot hear audio when using the inflight cable.	Headset must be turned off when using the in-flight cable.

PULSAR 590A ONLY

Problem	Solution
I cannot complete the pairing with my Bluetooth device.	Universal adapter must be turned off when pairing to another device.
I do not get a sound from my headset when using the universal adapter.	<ul style="list-style-type: none">•It may take up to 30 seconds for the devices to connect and audio to stream.•Press the connect button on the headset or adapter after 30 seconds if there is still no sound.•Check audio mute on the headset. Press the mute button on the headset to unmute.•Check pairing. See page (8) "Pairing with universal adapter."
Volume is too high / low when listening to audio, but fine when making a phone call.	Check the volume of the audio source device.

TECHNICAL ASSISTANCE

Plantronics Technical Assistance Center (TAC) is ready to assist you! Dial (866) 363-BLUE(2583), or visit the Support section of our website at www.plantronics.com.

REGULATORY NOTICES

FCC REQUIREMENTS PART 15

This device complies with Part 15 of the FCC Rules. Operation is subject to the following two conditions:

1. This device may not cause harmful interference, and
2. This device must accept any interference received, including interference that may cause undesired operation.

This equipment has been tested and found to comply with the limits for a Class B digital device, pursuant to Part 15 of the FCC Rules. These limits are designed to provide reasonable protection against harmful interference in a residential installation. This equipment generates, uses, and can radiate radio frequency energy and, if not installed and used in accordance with the instructions, may cause harmful interference to radio communications. However, there is no guarantee that interference will not occur in a particular installation. If this equipment does cause harmful interference to radio or television reception which can be determined by turning the radio or television off and on, the user is encouraged to try to correct interference by one or more of the following measures:

1. Reorient or relocate the receiving antenna.
2. Increase the separation between the equipment and receiver.
3. Connect the equipment into an outlet on another circuit.
4. Consult the dealer or an experienced radio/TV technician for help.

EXPOSURE TO RF RADIATION

This device and its antenna must not be collocated or operated in conjunction with any other antenna or transmitter. To comply with FCC RF exposure requirements, only use supplied antenna. Any unauthorized modification to the antenna or device could void the user's authority to operate this device.

INDUSTRY CANADA NOTICE

Notice: This equipment meets the applicable Industry Canada Terminal Equipment Technical Specifications. This is confirmed by the registration number. The abbreviation, IC, before the registration number signifies that registration was performed based on a Declaration of Conformity indicating that Industry Canada technical specifications were met. It does not imply that Industry Canada approved the equipment. The Industry Canada registration number is located in the bottom of the unit. Before installing this equipment, users should ensure that it is permissible to be connected to the facilities of the local telecommunications company. The equipment must also be installed using an acceptable method of connection. The customer should be aware that compliance with the above conditions may not prevent degradation of service in some situations. Repairs to certified equipment should be coordinated by a representative designated by the supplier. Any repairs or alterations made by user to this equipment, or equipment malfunctions, may give the telecommunications company cause to request the user disconnect the equipment. Users should ensure for their own protection that the electrical ground connections of the power utility, telephone lines and internal metallic water pipe system, if present, are connected together. This precaution may be particularly important in rural areas.

Caution: Users should not attempt to make such connection themselves, but should contact the appropriate electric inspection authority, or electrician, as appropriate.

RSS 210

This digital apparatus does not exceed the Class B limit for radio noise emissions from digital apparatus set out in the Radio Interference Regulations of Industry Canada. Operation is subject to the following two conditions:

1) this device may not cause interference, and 2) this device must accept any interference, including interference that may cause undesired operation of the device.