



No.10 Weiye Rd., Innovation park, Eco&Tec,  
Development Zone, Kunshan City, Jiangsu, China

Telephone: 86-512-57355888  
Fax: 86-512-57370818  
Mail: sgs.china@sgs.com

Report No.: CKSEM191100068701  
Rev : 01  
Page : 1 of 42

## FCC SAR TEST REPORT

**Application No:** CKSEM1911000687CR  
**Applicant:** Plantronics Inc  
**Manufacturer:** Plantronics Inc  
**Factory:** Acoustic Innovation (Huizhou) Co., Ltd.  
**Product Name:** USB and Bluetooth Speakerphone  
**Model No.(EUT):** CL5300-M USB-C  
**Series Model:** CL5300 USB-A, CL5300 USB-C, CL5300-M USB-A, CL5300-M USB-C  
**Trade Mark:** plantronics  
**FCC ID:** AL8-CL5300  
**Standards:** FCC 47CFR §2.1093  
**Date of Receipt:** 2019-11-12  
**Date of Test:** 2019-11-15 to 2019-11-15  
**Date of Issue:** 2019-12-18  
**Test conclusion:** PASS \*

\* In the configuration tested, the EUT detailed in this report complied with the standards specified above.

Authorized Signature:

Eric Lin

Laboratory Manager

The manufacturer should ensure that all products in series production are in conformity with the product sample detailed in this report.

If the product in this report is used in any configuration other than that detailed in the report, the manufacturer must ensure the new system complies with all relevant standards. Any mention of SGS International Electrical Approvals or testing done by SGS International Electrical Approvals in connection with, distribution or use of the product described in this report must be approved by SGS International Electrical Approvals in writing.



Unless otherwise agreed in writing, this document is issued by the Company subject to its General Conditions of Service printed overleaf, available on request or accessible at <http://www.sgs.com/en/Terms-and-Conditions.aspx> and, for electronic format documents, subject to Terms and Conditions for Electronic Documents at <http://www.sgs.com/en/Terms-and-Conditions/Terms-e-Document.aspx>. Attention is drawn to the limitation of liability, indemnification and jurisdiction issues defined therein. Any holder of this document is advised that information contained hereon reflects the Company's findings at the time of its intervention only and within the limits of Client's instructions, if any. The Company's sole responsibility is to its Client and this document does not exonerate parties to a transaction from exercising all their rights and obligations under the transaction documents. This document cannot be reproduced except in full, without prior written approval of the Company. Any unauthorized alteration, forgery or falsification of the content or appearance of this document is unlawful and offenders may be prosecuted to the fullest extent of the law. Unless otherwise stated the results shown in this test report refer only to the sample(s) tested and such sample(s) are retained for 30 days only.

Attention: To check the authenticity of testing /inspection report & certificate, please contact us at telephone: (86-755) 8307 1443, or email: [CN.Doccheck@sgs.com](mailto:CN.Doccheck@sgs.com)

No.10, Weiye Road, Innovation Park, Kunshan, Jiangsu, China 215300  
中国·江苏·昆山市留学生创业园伟业路10号 邮编 215300

t(86-512)57355888 f(86-512)57370818 www.sgs.com.cn  
t(86-512)57355888 f(86-512)57370818 sgs.china@sgs.com

## REVISION HISTORY

Revision Record				
Version	Chapter	Date	Modifier	Remark
01		2019-12-18		Original

## TEST SUMMARY

Frequency Band	Maximum Reported SAR(W/kg)
	Body
Bluetooth	0.05
SAR Limited(W/kg)	1.6

**Approved & Released by**

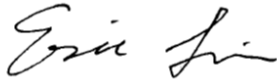

Eric Lin

SAR Manager

**Tested by**



Richard Kong

SAR Engineer

# CONTENTS

<b>1</b>	<b>GENERAL INFORMATION</b> .....	<b>6</b>
1.1	DETAILS OF CLIENT .....	6
1.2	TEST LOCATION.....	6
1.3	TEST FACILITY .....	7
1.4	GENERAL DESCRIPTION OF EUT .....	8
1.4.1	DUT Antenna Locations.....	9
1.5	TEST SPECIFICATION .....	11
1.6	RF EXPOSURE LIMITS .....	12
<b>2</b>	<b>LABORATORY ENVIRONMENT</b> .....	<b>13</b>
<b>3</b>	<b>SAR MEASUREMENTS SYSTEM CONFIGURATION</b> .....	<b>14</b>
3.1	THE SAR MEASUREMENT SYSTEM.....	14
3.2	ISOTROPIC E-FIELD PROBE EX3DV4 .....	15
3.3	DATA ACQUISITION ELECTRONICS (DAE) .....	16
3.4	SAM TWIN PHANTOM.....	16
3.5	ELI PHANTOM .....	17
3.6	DEVICE HOLDER FOR TRANSMITTERS.....	18
3.7	MEASUREMENT PROCEDURE .....	19
3.7.1	Scanning procedure .....	19
3.7.2	Data Storage.....	21
3.7.3	Data Evaluation by SEMCAD.....	21
<b>4</b>	<b>SAR MEASUREMENT VARIABILITY AND UNCERTAINTY</b> .....	<b>23</b>
4.1	SAR MEASUREMENT VARIABILITY .....	23
4.2	SAR MEASUREMENT UNCERTAINTY.....	23
<b>5</b>	<b>DESCRIPTION OF TEST POSITION</b> .....	<b>24</b>
5.1	THE BODY TEST POSITION .....	24
<b>6</b>	<b>SAR SYSTEM VERIFICATION PROCEDURE</b> .....	<b>25</b>
6.1	TISSUE SIMULATE LIQUID .....	25
6.1.1	Recipes for Tissue Simulate Liquid.....	25
6.1.2	Test Liquids Confirmation .....	26
6.1.3	Measurement for Tissue Simulate Liquid.....	27
6.2	SAR SYSTEM CHECK .....	28
6.2.1	Justification for Extended SAR Dipole Calibrations .....	29

6.2.2 Summary System Check Result(s) .....30

6.2.3 Detailed System Check Results .....30

**7 TEST CONFIGURATION .....31**

7.1.1 Bluetooth Test Configuration .....31

**8 TEST RESULT .....32**

**8.1 MEASUREMENT OF RF CONDUCTED POWER .....32**

8.1.1 Conducted Power Of BT .....32

**8.2 STAND-ALONE SAR TEST EVALUATION .....33**

**8.3 BODY TEST EXCLUSION THRESHOLDS .....34**

**8.4 MEASUREMENT OF SAR DATA .....35**

8.4.1 SAR Result Of Bluetooth.....35

**9 EQUIPMENT LIST .....36**

**10 CALIBRATION CERTIFICATE .....37**

**11 PHOTOGRAPHS .....37**

**APPENDIX A: DETAILED SYSTEM CHECK RESULTS .....38**

**APPENDIX B: DETAILED TEST RESULTS .....40**

**APPENDIX C: CALIBRATION CERTIFICATE .....42**

**APPENDIX D: PHOTOGRAPHS .....42**

# 1 General Information

## 1.1 Details of Client

Applicant:	Plantronics Inc
Address:	345 Encinal Street Santa Cruz California United States 95060
Manufacturer:	Plantronics Inc
Address:	345 Encinal Street Santa Cruz California United States 95060
Factory:	Acoustic Innovation (Huizhou) Co., Ltd.
Address:	Xiangshuihe Industrial Area, Dayawan Development District, Huizhou City Guangdong Province, CHIN

## 1.2 Test Location

Company: Compliance Certification Services Inc. Kun shan Laboratory  
 Address: No.10 Weiye Rd., Innovation park, Eco&Tec, Development Zone, Kunshan City, Jiangsu, China  
 Post code: 215300  
 Telephone: 86-512-57355888  
 Fax: 86-512-57370818  
 E-mail: [sgs.china@sgs.com](mailto:sgs.china@sgs.com)

### 1.3 Test Facility

The test facility is recognized, certified, or accredited by the following organizations:

- **CNAS (No. CNAS L4354)**

CNAS has accredited Compliance Certification Services (Kunshan) Inc. to ISO/IEC 17025:2017 General Requirements for the Competence of Testing and Calibration Laboratories (CNAS-CL01 Accreditation Criteria for the Competence of Testing and Calibration Laboratories) for the competence in the field of testing.

- **A2LA (Certificate No. 2541.01)**

Compliance Certification Services (Kunshan) Inc. is accredited by the American Association for Laboratory Accreditation (A2LA). Certificate No. 2541.01.

- **FCC –Designation Number: CN1172**

Compliance Certification Services Inc. has been recognized as an accredited testing laboratory.

Designation Number: CN1172. Test Firm Registration Number: 995260.

- **Industry Canada (IC) – IC Assigned Code: 2324E CAB ID: CN0072**

The 10m and 3m Semi-anechoic chamber of Compliance Certification Services (Kunshan) Inc. has been registered by Certification and Engineering Bureau of Industry Canada for radio equipment testing with Registration No.: 2324E-1 for 10m chamber, 2324E-2 for 3m chamber.

- **VCCI (Member No.: 1938)**

The 3m and 10m Semi-anechoic chamber and Shielded Room of Compliance Certification Services (Kunshan) Inc. has been registered in accordance with the Regulations for Voluntary Control Measures with Registration No.: R-1600, C-1707, T-1499, G-10216 respectively.

## 1.4 General Description of EUT

Device Type :	portable device		
Exposure Category:	uncontrolled environment / general population		
Product Name:	USB and Bluetooth Speakerphone		
Model No.(EUT):	CL5300-M USB-C		
Series Model:	CL5300 USB-A, CL5300 USB-C, CL5300-M USB-A, CL5300-M USB-C		
FCC ID:	AL8-CL5300		
Trade Mark:	plantronics		
Product Phase:	production unit		
SN:	EA2J8D		
Hardware Version:	Rev A		
Software Version:	V36		
Antenna Type:	Integral Antenna		
Device Operating Configurations :			
Modulation Mode:	BT: GFSK, $\pi$ /4DQPSK, 8DPSK		
Antenna Gain	-2.33dBi (Provided by the manufacturer)		
Device Class:	B		
Frequency Bands:	Band	Tx (MHz)	Rx (MHz)
	BT	2402~2480	2402~2480
Battery Information:	Model: VDL952246		
	Rated capacity: 1000mAh,3.7V		
	Manufacture: Chongqing VDL Electronics Co., Ltd		

Note1:

Model No.: CL5300 USB-A, CL5300 USB-C, CL5300-M USB-A, CL5300-M USB-C.

Only the model CL5300-M USB-C was tested, since the electrical circuit design, PCB layout, components used and internal wiring were identical for the above models, only difference as below table.

Production name	Trade name	Model No.	Description
USB and Bluetooth Speakerphone	Plantronics	CL5300 USB-A	Type A USB Without teams function
USB and Bluetooth Speakerphone	Plantronics	CL5300 USB-C	Type C USB Without teams function
USB and Bluetooth Speakerphone	Plantronics	CL5300-M USB-A	Type A USB With teams function
USB and Bluetooth Speakerphone	Plantronics	CL5300-M USB-C	Type C USB With teams function

Note2:

The antenna gain value is provided by the customer. The test lab will not be responsible for wrong test result due to incorrect information about antenna gain values.



1.4.1 DUT Antenna Locations(Unit: mm)

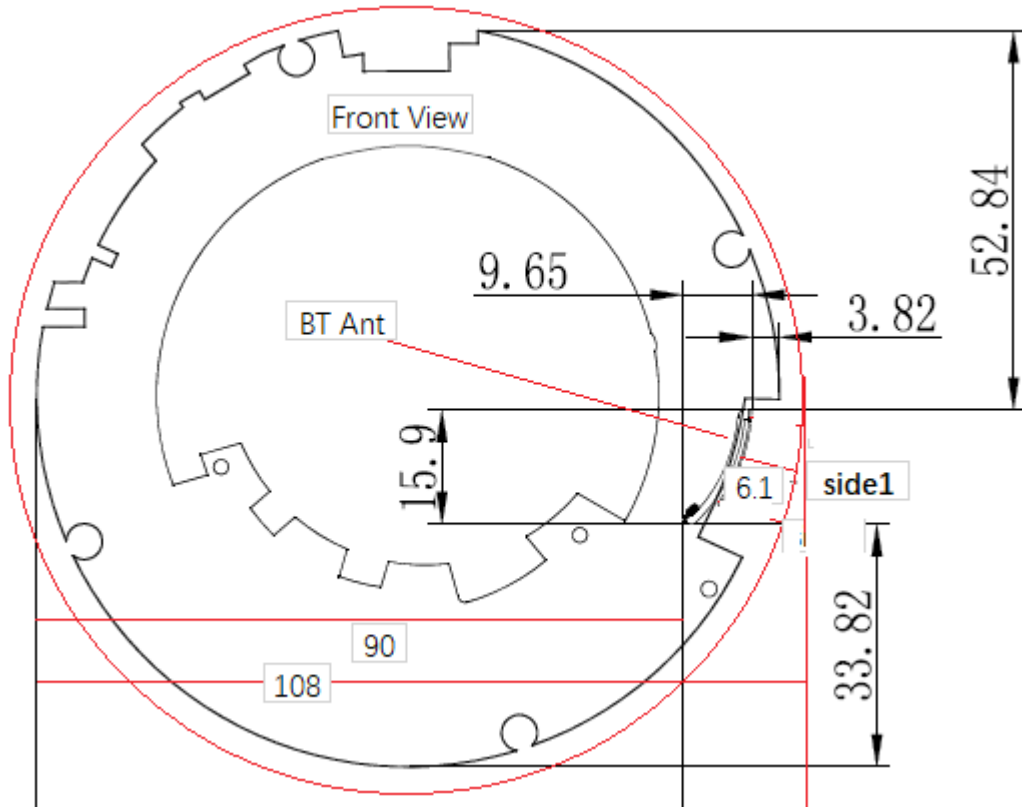
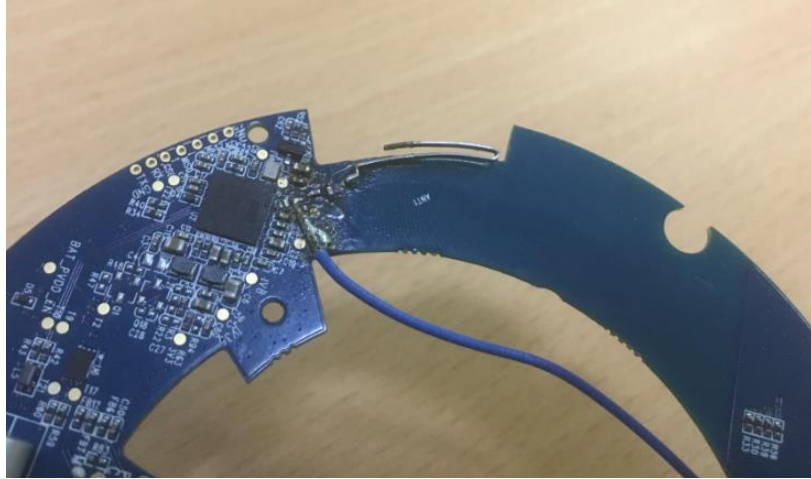

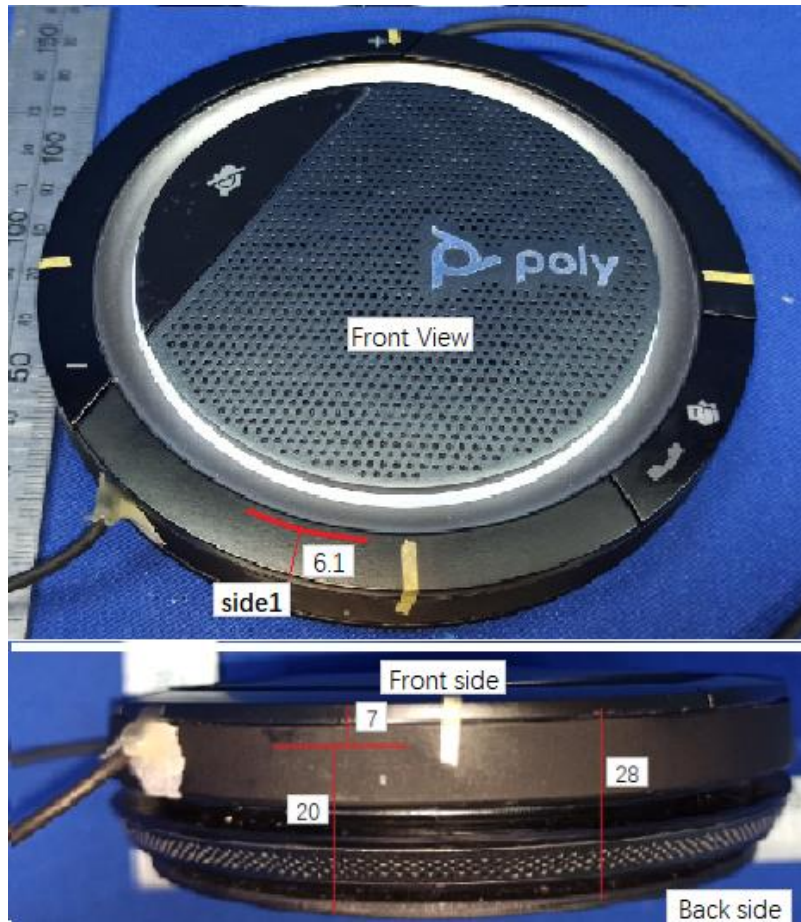

The test device is a USB and Bluetooth Speakerphone, and this device can be used by hand and close to body. The distance between the antenna and the curved surface is about 6.1mm, the distance between the antenna and the front side is about 7.0mm.

## 1.5 Test Specification

Identity	Document Title
FCC 47CFR §2.1093	Radiofrequency Radiation Exposure Evaluation: Portable Devices
ANSI/IEEE Std C95.1 – 1992	Safety Levels with Respect to Human Exposure to Radio Frequency Electromagnetic Fields, 3 kHz – 300 GHz.
IEEE 1528-2013	Recommended Practice for Determining the Peak Spatial-Average Specific Absorption Rate (SAR) in the Human Head from Wireless Communications Devices: Measurement Techniques
KDB447498 D01 General RF Exposure Guidance v06	Mobile and Portable Devices RF Exposure Procedures and Equipment Authorization Policies
KDB447498 D03 Supplement C Cross-Reference v01	OET Bulletin 65, Supplement C Cross-Reference
KDB 865664 D01 SAR Measurement 100 MHz to 6 GHz v01r04	SAR Measurement Requirements for 100 MHz to 6 GHz
KDB 865664 D02 RF Exposure Reporting v01r02	RF Exposure Compliance Reporting and Documentation Considerations

## 1.6 RF exposure limits

Human Exposure	Uncontrolled Environment General Population	Controlled Environment Occupational
<b>Spatial Peak SAR*</b> (Brain*Trunk)	<b>1.60 W/kg</b>	8.00 W/kg
<b>Spatial Average SAR**</b> (Whole Body)	0.08 W/kg	0.40 W/kg
<b>Spatial Peak SAR***</b> (Hands/Feet/Ankle/Wrist)	4.00 W/kg	20.00 W/kg

### Notes:

\* The Spatial Peak value of the SAR averaged over any 1 gram of tissue (defined as a tissue volume in the shape of a cube) and over the appropriate averaging time

\*\* The Spatial Average value of the SAR averaged over the whole body.

\*\*\* The Spatial Peak value of the SAR averaged over any 10 grams of tissue (defined as a tissue volume in the shape of a cube) and over the appropriate averaging time.

**Uncontrolled Environments** are defined as locations where there is the exposure of individuals who have no knowledge or control of their exposure.

**Controlled Environments** are defined as locations where there is exposure that may be incurred by persons who are aware of the potential for exposure, (i.e. as a result of employment or occupation.)

## 2 Laboratory Environment

Temperature	Min. = 18°C, Max. = 25 °C
Relative humidity	Min. = 30%, Max. = 70%
Ground system resistance	< 0.5 Ω
Ambient noise is checked and found very low and in compliance with requirement of standards. Reflection of surrounding objects is minimized and in compliance with requirement of standards.	

Table 2 : The Ambient Conditions

### 3 SAR Measurements System Configuration

#### 3.1 The SAR Measurement System

This SAR Measurement System uses a Computer-controlled 3-D stepper motor system (SPEAG DASY5 professional system). A E-field probe is used to determine the internal electric fields. The SAR can be obtained from the equation  $SAR = \sigma (|E|^2) / \rho$  where  $\sigma$  and  $\rho$  are the conductivity and mass density of the tissue-Simulate.

The DASY5 system for performing compliance tests consists of the following items:

A standard high precision 6-axis robot (Stabile RX family) with controller, teach pendant and software .An arm extension for accommodation the data acquisition electronics (DAE).

A dosimetric probe, i.e., an isotropic E-field probe optimized and calibrated for usage in tissue simulating liquid. The probe is equipped with an optical surface detector system.

A data acquisition electronics (DAE) which performs the signal amplification, signal multiplexing, AD-conversion, offset measurements, mechanical surface detection, collision detection, etc. The unit is battery powered with standard or rechargeable batteries. The signal is optically transmitted to the EOC.

The Electro-optical converter (EOC) performs the conversion between optical and electrical of the signals for the digital communication to DAE and for the analog signal from the optical surface detection. The EOC is connected to the measurement server.

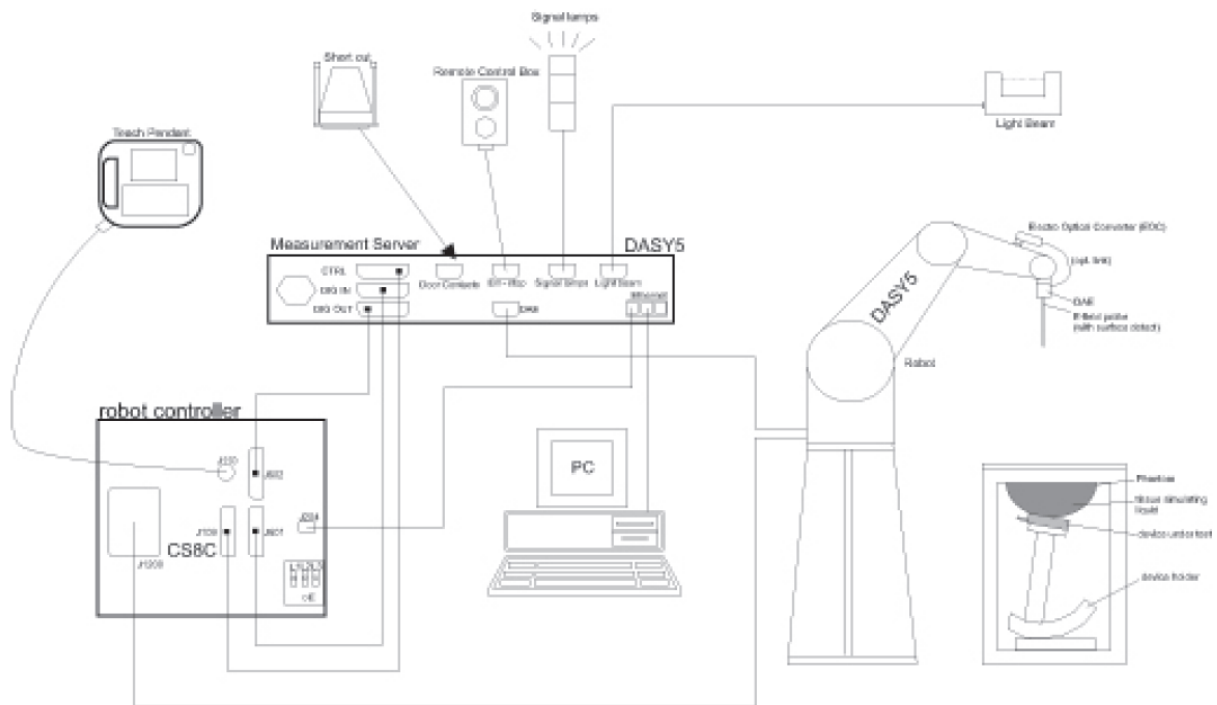

F-1. SAR Measurement System Configuration

- The function of the measurement server is to perform the time critical tasks such as signal filtering, control of the robot operation and fast movement interrupts.
- A probe alignment unit which improves the (absolute) accuracy of the probe positioning.
- A computer operating Windows 7.
- DASY5 software.
- Remote control with teach pendant and additional circuitry for robot safety such as warning lamps, etc.
- The SAM twin phantom enabling testing left-hand, right-hand and Body Worn usage.
- The device holder for handheld mobile phones.
- Tissue simulating liquid mixed according to the given recipes.
- Validation dipole kits allowing to validating the proper functioning of the system.

### 3.2 Isotropic E-field Probe EX3DV4

	Symmetrical design with triangular core Built-in shielding against static charges PEEK enclosure material (resistant to organic solvents, e.g., DGBE)
<b>Calibration</b>	ISO/IEC 17025 <a href="#">calibration service</a> available.
<b>Frequency</b>	10 MHz to > 6 GHz Linearity: $\pm 0.2$ dB (30 MHz to 6 GHz)
<b>Directivity</b>	$\pm 0.3$ dB in TSL (rotation around probe axis) $\pm 0.5$ dB in TSL (rotation normal to probe axis)
<b>Dynamic Range</b>	10 $\mu$ W/g to > 100 mW/g Linearity: $\pm 0.2$ dB (noise: typically < 1 $\mu$ W/g)
<b>Dimensions</b>	Overall length: 337 mm (Tip: 20 mm) Tip diameter: 2.5 mm (Body: 12 mm) Typical distance from probe tip to dipole centers: 1 mm
<b>Application</b>	High precision dosimetric measurements in any exposure scenario (e.g., very strong gradient fields); the only probe that enables compliance testing for frequencies up to 6 GHz with precision of better 30%.
<b>Compatibility</b>	DASY3, DASY4, DASY52 SAR and higher, EASY4/MRI

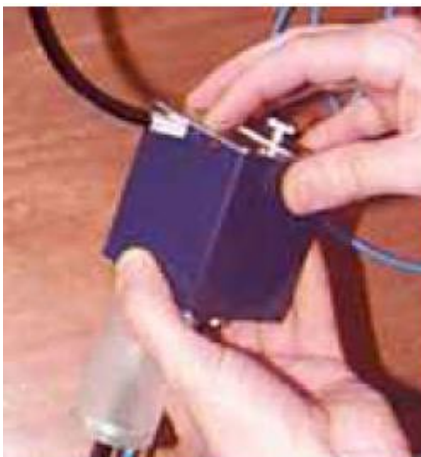

### 3.3 Data Acquisition Electronics (DAE)

<b>Model</b>	DAE4	
<b>Construction</b>	Signal amplifier, multiplexer, A/D converter and control logic. Serial optical link for communication with DASY4/5 embedded system (fully remote controlled). Two step probe touch detector for mechanical surface detection and emergency robot stop.	
<b>Measurement Range</b>	-100 to +300 mV (16 bit resolution and two range settings: 4mV,400mV)	
<b>Input Offset Voltage</b>	< 5 $\mu$ V (with auto zero)	
<b>Input Bias Current</b>	< 50 f A	
<b>Dimensions</b>	60 x 60 x 68 mm	

### 3.4 SAM Twin Phantom

<b>Material</b>	Vinylester, glass fiber reinforced (VE-GF)	
<b>Liquid Compatibility</b>	Compatible with all SPEAG tissue simulating liquids (incl. DGBE type)	
<b>Shell Thickness</b>	2 $\pm$ 0.2 mm (6 $\pm$ 0.2 mm at ear point)	
<b>Dimensions (incl. Wooden Support)</b>	Length: 1000 mm Width: 500 mm Height: adjustable feet	
<b>Filling Volume</b>	approx. 25 liters	
<b>Wooden Support</b>	SPEAG standard phantom table	

The shell corresponds to the specifications of the Specific Anthropomorphic Mannequin (SAM) phantom defined in IEEE 1528 and IEC 62209-1. It enables the dosimetric evaluation of left and right hand phone usage as well as body mounted usage at the flat phantom region. A cover prevents evaporation of the liquid. Reference markings on the phantom allow the complete setup of all predefined phantom positions and measurement grids by teaching three points with the robot.

Twin SAM V5.0 has the same shell geometry and is manufactured from the same material as Twin SAM V4.0, but has reinforced top structure.



### 3.5 ELI Phantom

<b>Material</b>	Vinylester, glass fiber reinforced (VE-GF)	
<b>Liquid Compatibility</b>	Compatible with all SPEAG tissue simulating liquids (incl. DGBE type)	
<b>Shell Thickness</b>	2.0 ± 0.2 mm (bottom plate)	
<b>Dimensions</b>	Major axis: 600 mm Minor axis: 400 mm	
<b>Filling Volume</b>	approx. 30 liters	
<b>Wooden Support</b>	SPEAG standard phantom table	

Phantom for compliance testing of handheld and body-mounted wireless devices in the frequency range of 30 MHz to 6 GHz. ELI is fully compatible with the IEC 62209-2 standard and all known tissue simulating liquids. ELI has been optimized regarding its performance and can be integrated into our standard phantom tables. A cover prevents evaporation of the liquid. Reference markings on the phantom allow installation of the complete setup, including all predefined phantom positions and measurement grids, by teaching three points. The phantom is compatible with all SPEAG dosimetric probes and dipoles.

ELI V5.0 has the same shell geometry and is manufactured from the same material as ELI4, but has reinforced top structure.

### 3.6 Device Holder for Transmitters



F-2. Device Holder for Transmitters

- The DASY device holder is designed to cope with different positions given in the standard. It has two scales for the device rotation (with respect to the body axis) and the device inclination (with respect to the line between the ear reference points). The rotation centres for both scales are the ear reference point (ERP). Thus the device needs no repositioning when changing the angles.
- The DASY device holder has been made out of low-loss POM material having the following dielectric parameters: relative permittivity  $\epsilon=3$  and loss tangent  $\delta=0.02$ . The amount of dielectric material has been reduced in the closest vicinity of the device, since measurements have suggested that the influence of the clamp on the test results could thus be lowered.

## 3.7 Measurement procedure

### 3.7.1 Scanning procedure

#### Step 1: Power reference measurement

The “reference” and “drift” measurements are located at the beginning and end of the batch process. They measure the field drift at one single point in the liquid over the complete procedure.

#### Step 2: Area scan

The SAR distribution at the exposed side of the head was measured at a distance of 4mm from the inner surface of the shell. The area covered the entire dimension of the head and the horizontal grid spacing was 15mm\*15mm or 12mm\*12mm or 10mm\*10mm. Based on the area scan data, the area of the maximum absorption was determined by spline interpolation.

#### Step 3: Zoom scan

Around this point, a volume of 30mm\*30mm\*30mm (fine resolution volume scan, zoom scan) was assessed by measuring 5x5x7 points ( $\leq 2\text{GHz}$ ) and 7x7x7 points ( $\geq 2\text{GHz}$ ). On this basis of this data set, the spatial peak SAR value was evaluated with the following procedure:

The data at the surface was extrapolated, since the centre of the dipoles is 2.0mm away from the tip of the probe and the distance between the surface and the lowest measuring point is 1.2mm. (This can be variable. Refer to the probe specification). The extrapolation was based on a least square algorithm. A polynomial of the fourth order was calculated through the points in z-axes. This polynomial was then used to evaluate the points between the surface and the probe tip. The maximum interpolated value was searched with a straight-forward algorithm. Around this maximum the SAR values averaged over the spatial volumes (1g or 10g) were computed using the 3D-Spline interpolation algorithm. The volume was integrated with the trapezoidal algorithm. One thousand points were interpolated to calculate the average. All neighbouring volumes were evaluated until no neighboring volume with a higher average value was found.

The area and zoom scan resolutions specified in the table below must be applied to the SAR measurements. Probe boundary effect error compensation is required for measurements with the probe tip closer than half a probe tip diameter to the phantom surface. Both the probe tip diameter and sensor offset distance must satisfy measurement protocols; to ensure probe boundary effect errors are minimized and the higher fields closest to the phantom surface can be correctly measured and extrapolated to the phantom surface for computing 1-g SAR. Tolerances of the post-processing algorithms must be verified by the test laboratory for the scan resolutions used in the SAR measurements, according to the reference distribution functions specified in IEEE Std. 1528-2003.

		$\leq 3$ GHz	$> 3$ GHz	
Maximum distance from closest measurement point (geometric center of probe sensors) to phantom surface		$5 \pm 1$ mm	$\frac{1}{2} \cdot \delta \cdot \ln(2) \pm 0.5$ mm	
Maximum probe angle from probe axis to phantom surface normal at the measurement location		$30^\circ \pm 1^\circ$	$20^\circ \pm 1^\circ$	
Maximum area scan spatial resolution: $\Delta x_{Area}$ , $\Delta y_{Area}$		$\leq 2$ GHz: $\leq 15$ mm 2 – 3 GHz: $\leq 12$ mm	3 – 4 GHz: $\leq 12$ mm 4 – 6 GHz: $\leq 10$ mm	
		When the x or y dimension of the test device, in the measurement plane orientation, is smaller than the above, the measurement resolution must be $\leq$ the corresponding x or y dimension of the test device with at least one measurement point on the test device.		
Maximum zoom scan spatial resolution: $\Delta x_{Zoom}$ , $\Delta y_{Zoom}$		$\leq 2$ GHz: $\leq 8$ mm 2 – 3 GHz: $\leq 5$ mm*	3 – 4 GHz: $\leq 5$ mm* 4 – 6 GHz: $\leq 4$ mm*	
Maximum zoom scan spatial resolution, normal to phantom surface	uniform grid: $\Delta z_{Zoom}(n)$	$\leq 5$ mm	3 – 4 GHz: $\leq 4$ mm 4 – 5 GHz: $\leq 3$ mm 5 – 6 GHz: $\leq 2$ mm	
	graded grid	$\Delta z_{Zoom}(1)$ : between 1 <sup>st</sup> two points closest to phantom surface	$\leq 4$ mm	3 – 4 GHz: $\leq 3$ mm 4 – 5 GHz: $\leq 2.5$ mm 5 – 6 GHz: $\leq 2$ mm
		$\Delta z_{Zoom}(n>1)$ : between subsequent points	$\leq 1.5 \cdot \Delta z_{Zoom}(n-1)$	
Minimum zoom scan volume	x, y, z	$\geq 30$ mm	3 – 4 GHz: $\geq 28$ mm 4 – 5 GHz: $\geq 25$ mm 5 – 6 GHz: $\geq 22$ mm	
<p>Note: <math>\delta</math> is the penetration depth of a plane-wave at normal incidence to the tissue medium; see draft standard IEEE P1528-2011 for details.</p> <p>* When zoom scan is required and the <i>reported</i> SAR from the <i>area scan based 1-g SAR estimation</i> procedures of KDB 447498 is <math>\leq 1.4</math> W/kg, <math>\leq 8</math> mm, <math>\leq 7</math> mm and <math>\leq 5</math> mm zoom scan resolution may be applied, respectively, for 2 GHz to 3 GHz, 3 GHz to 4 GHz and 4 GHz to 6 GHz.</p>				

#### Step 4: Power reference measurement (drift)

The Power Drift Measurement job measures the field at the same location as the most recent power reference measurement job within the same procedure, and with the same settings. The indicated drift is mainly the variation of the DUT's output power and should vary max.  $\pm 5\%$

### 3.7.2 Data Storage

The DASY software stores the acquired data from the data acquisition electronics as raw data (in microvolt readings from the probe sensors), together with all necessary software parameters for the data evaluation (probe calibration data, liquid parameters and device frequency and modulation data) in measurement files with the extension “.DAE3”. The software evaluates the desired unit and format for output each time the data is visualized or exported. This allows verification of the complete software setup even after the measurement and allows correction of incorrect parameter settings. For example, if a measurement has been performed with a wrong crest factor parameter in the device setup, the parameter can be corrected afterwards and the data can be re-evaluated. The measured data can be visualized or exported in different units or formats, depending on the selected probe type ([V/m], [A/m], [°C], [m W/g], [m W/cm²], [dBrel], etc.). Some of these units are not available in certain situations or show meaningless results, e.g., a SAR output in a lossless media will always be zero. Raw data can also be exported to perform the evaluation with other software packages.

### 3.7.3 Data Evaluation by SEMCAD

The SEMCAD software automatically executes the following procedures to calculate the field units from the microvolt readings at the probe connector. The parameters used in the evaluation are stored in the configuration modules of the software:

Probe parameters:	- Sensitivity	Normi, ai0, ai1, ai2
- Conversion factor	ConvFi	
- Diode compression point	Dcpi	
Device parameters:	- Frequency	f
- Crest factor	cf	
Media parameters:	- Conductivity	ε
- Density	ρ	

These parameters must be set correctly in the software. They can be found in the component documents or they can be imported into the software from the configuration files issued for the DASY components. In the direct measuring mode of the multimeter option, the parameters of the actual system setup are used. In the scan visualization and export modes, the parameters stored in the corresponding document files are used.

The first step of the evaluation is a linearization of the filtered input signal to account for the compression characteristics of the detector diode. The compensation depends on the input signal, the diode type and the DC-transmission factor from the diode to the evaluation electronics.

If the exciting field is pulsed, the crest factor of the signal must be known to correctly compensate for peak power.

The formula for each channel can be given as:

$$V_i = U_i + U_i^2 \cdot cf / dcpi$$

With  $V_i$  = compensated signal of channel  $i$  ( $i = x, y, z$ )

$U_i$  = input signal of channel  $i$  ( $i = x, y, z$ )

cf = crest factor of exciting field (DASY parameter)

dcpi = diode compression point (DASY parameter)

From the compensated input signals the primary field data for each channel can be evaluated:

E-field probes:

$$E_i = (V_i / Norm_i \cdot ConvF)^{1/2}$$

H-field probes:

$$H_i = (V_i)^{1/2} \cdot (a_{i0} + a_{i1}f + a_{i2}f^2) / f$$

With  $V_i$  = compensated signal of channel  $i$  ( $i = x, y, z$ )

Norm $i$  = sensor sensitivity of channel  $i$  ( $i = x, y, z$ )

[mV/(V/m)<sup>2</sup>] for E-field Probes

ConvF = sensitivity enhancement in solution

$a_{ij}$  = sensor sensitivity factors for H-field probes

$f$  = carrier frequency [GHz]

$E_i$  = electric field strength of channel  $i$  in V/m

$H_i$  = magnetic field strength of channel  $i$  in A/m

The RSS value of the field components gives the total field strength (Hermitian magnitude):

$$E_{tot} = (E_x^2 + E_y^2 + E_z^2)^{1/2}$$

The primary field data are used to calculate the derived field units.

$$SAR = (E_{tot}^2 \cdot \sigma) / (\epsilon \cdot 1000)$$

with SAR = local specific absorption rate in mW/g

$E_{tot}$  = total field strength in V/m

$\sigma$  = conductivity in [mho/m] or [Siemens/m]

$\epsilon$  = equivalent tissue density in g/cm<sup>3</sup>

Note that the density is normally set to 1 (or 1.06), to account for actual brain density rather than the density of the simulation liquid. The power flow density is calculated assuming the excitation field to be a free space field.

$$P_{pwe} = E_{tot}^2 / 3770 \text{ or } P_{pwe} = H_{tot}^2 \cdot 37.7$$

with  $P_{pwe}$  = equivalent power density of a plane wave in mW/cm<sup>2</sup>

$E_{tot}$  = total electric field strength in V/m

$H_{tot}$  = total magnetic field strength in A/m



## 4 SAR measurement variability and uncertainty

### 4.1 SAR measurement variability

Per KDB865664 D01 SAR measurement 100 MHz to 6 GHz v01r04, SAR measurement variability must be assessed for each frequency band, which is determined by the SAR probe calibration point and tissue-equivalent medium used for the device measurements. The additional measurements are repeated after the completion of all measurements requiring the same head or body tissue-equivalent medium in a frequency band. The test device should be returned to ambient conditions (normal room temperature) with the battery fully charged before it is re-mounted on the device holder for the repeated measurement(s) to minimize any unexpected variations in the repeated results.

1) Repeated measurement is not required when the original highest measured SAR is  $< 0.80$  W/kg; steps 2) through 4) do not apply.

2) When the original highest measured SAR is  $\geq 0.80$  W/kg, repeat that measurement once.

3) Perform a second repeated measurement only if the ratio of largest to smallest SAR for the original and first repeated measurements is  $> 1.20$  or when the original or repeated measurement is  $\geq 1.45$  W/kg ( $\sim 10\%$  from the 1-g SAR limit).

4) Perform a third repeated measurement only if the original, first or second repeated measurement is  $\geq 1.5$  W/kg and the ratio of largest to smallest SAR for the original, first and second repeated measurements is  $> 1.20$ .

The same procedures should be adapted for measurements according to extremity and occupational exposure limits by applying a factor of 2.5 for extremity exposure and a factor of 5 for occupational exposure to the corresponding SAR thresholds.

### 4.2 SAR measurement uncertainty

Per KDB865664 D01 SAR Measurement 100 MHz to 6 GHz, when the highest measured 1-g SAR within a frequency band is  $< 1.5$  W/kg, the extensive SAR measurement uncertainty analysis described in IEEE Std 1528-2013 is not required in SAR reports submitted for equipment approval. The equivalent ratio (1.5/1.6) is applied to extremity and occupational exposure conditions.

## 5 Description of Test Position

### 5.1 The Body Test Position

Per KDB inquiry, SAR can test the sides near the antenna, the surface of the device should be tested for SAR compliance with device touching the phantom. The SAR Exclusion Threshold in Kdb447498 D01 can be applied to determine SAR test exclusion for adjacent edge configurations. The closest distance from the antenna to an adjacent device surface is used to determine if SAR testing is required for the adjacent surfaces, with the adjacent surface positioned against the phantom and the surface containing the antenna positioned perpendicular to the phantom.



## 6 SAR System Verification Procedure

### 6.1 Tissue Simulate Liquid

#### 6.1.1 Recipes for Tissue Simulate Liquid

The following tables give the recipes for tissue simulating liquids to be used in different frequency bands:

Ingredients (% by weight)	Frequency (MHz)									
	450		835		915		1900		2450	
Tissue Type	Head	Body	Head	Body	Head	Body	Head	Body	Head	Body
Water	38.56	51.16	41.45	52.4	41.05	56.0	54.9	40.4	62.7	73.2
Salt (NaCl)	3.95	1.49	1.45	1.4	1.35	0.76	0.18	0.5	0.5	0.04
Sugar	56.32	46.78	56.0	45.0	56.5	41.76	0.0	58.0	0.0	0.0
HEC	0.98	0.52	1.0	1.0	1.0	1.21	0.0	1.0	0.0	0.0
Bactericide	0.19	0.05	0.1	0.1	0.1	0.27	0.0	0.1	0.0	0.0
Triton X-100	0.0	0.0	0.0	0.0	0.0	0.0	0.0	0.0	36.8	0.0
DGBE	0.0	0.0	0.0	0.0	0.0	0.0	44.92	0.0	0.0	26.7
Dielectric Constant	43.42	58.0	42.54	56.1	42.0	56.8	39.9	54.0	39.8	52.5
Conductivity (S/m)	0.85	0.83	0.91	0.95	1.0	1.07	1.42	1.45	1.88	1.78

HSL5GHz is composed of the following ingredients:  
 Water: 50-65%  
 Mineral oil: 10-30%  
 Emulsifiers: 8-25%  
 Sodium salt: 0-1.5%

MSL5GHz is composed of the following ingredients:  
 Water: 64-78%  
 Mineral oil: 11-18%  
 Emulsifiers: 9-15%  
 Sodium salt: 2-3%

Table 3 : Recipe of Tissue Simulate Liquid

## 6.1.2 Test Liquids Confirmation

### Simulated Tissue Liquid Parameter confirmation

The dielectric parameters were checked prior to assessment using the SPEAG DAK3.5 dielectric probe kit. The dielectric parameters measured are reported in each correspondent section.

### IEEE SCC-34/SC-2 P1528 RECOMMENDED TISSUE DIELECTRIC PARAMETERS

The head tissue dielectric parameters recommended by the IEEE SCC-34/SC-2 in P1528 have been incorporated in the following table. These head parameters are derived from planar layer models simulating the highest expected SAR for the dielectric properties and tissue thickness variations in a human head. Other head and body tissue parameters that have not been specified in P1528 are derived from the tissue dielectric parameters computed from the 4-Cole-Cole equations and extrapolated according to the head parameters specified in P1528

Target Frequency (MHz)	Head		Body	
	$\epsilon_r$	$\sigma$ (S/m)	$\epsilon_r$	$\sigma$ (S/m)
150	52.3	0.76	61.9	0.80
300	45.3	0.87	58.2	0.92
450	43.5	0.87	56.7	0.94
835	41.5	0.90	55.2	0.97
900	41.5	0.97	55.0	1.05
915	41.5	0.98	55.0	1.06
1450	40.5	1.20	54.0	1.30
1610	40.3	1.29	53.8	1.40
1800-2000	40.0	1.40	53.3	1.52
2450	39.2	1.80	52.7	1.95
3000	38.5	2.40	52.0	2.73
5800	35.3	5.27	48.2	6.00

( $\epsilon_r$  = relative permittivity,  $\sigma$  = conductivity and  $\rho = 1000 \text{ kg/m}^3$ )

### 6.1.3 Measurement for Tissue Simulate Liquid

The dielectric properties for this Tissue Simulate Liquids were measured by using the Agilent Model 85070E Dielectric Probe in conjunction with Agilent E5071C Network Analyzer (300 KHz-8500 MHz). The Conductivity ( $\sigma$ ) and Permittivity ( $\rho$ ) are listed in bellow table. For the SAR measurement given in this report. The temperature variation of the Tissue Simulate Liquids was  $22\pm 2^{\circ}\text{C}$ .

Tissue Type	Measured Frequency (MHz)	Target Tissue ( $\pm 5\%$ )		Measured Tissue		Liquid Temp. ( $^{\circ}\text{C}$ )	Measured Date
		$\epsilon_r$	$\sigma(\text{S/m})$	$\epsilon_r$	$\sigma(\text{S/m})$		
2450 Body	2450	52.70 (50.07~55.34)	1.95 (1.85~2.05)	52.325	1.995	22	2019/11/15

Table 4 : Measurement result of Tissue electric parameters

## 6.2 SAR System Check

The microwave circuit arrangement for system check is sketched in bellow figure. The daily system accuracy verification occurs within the flat section of the SAM phantom. A SAR measurement was performed to see if the measured SAR was within +/- 10% from the target SAR values. The tests were conducted on the same days as the measurement of the EUT. The obtained results from the system accuracy verification are displayed in the following table. During the tests, the ambient temperature of the laboratory was in the range  $22\pm 2^{\circ}\text{C}$ , the relative humidity was in the range 60% and the liquid depth above the ear reference points was above 15 cm in all the cases. It is seen that the system is operating within its specification, as the results are within acceptable tolerance of the reference values.

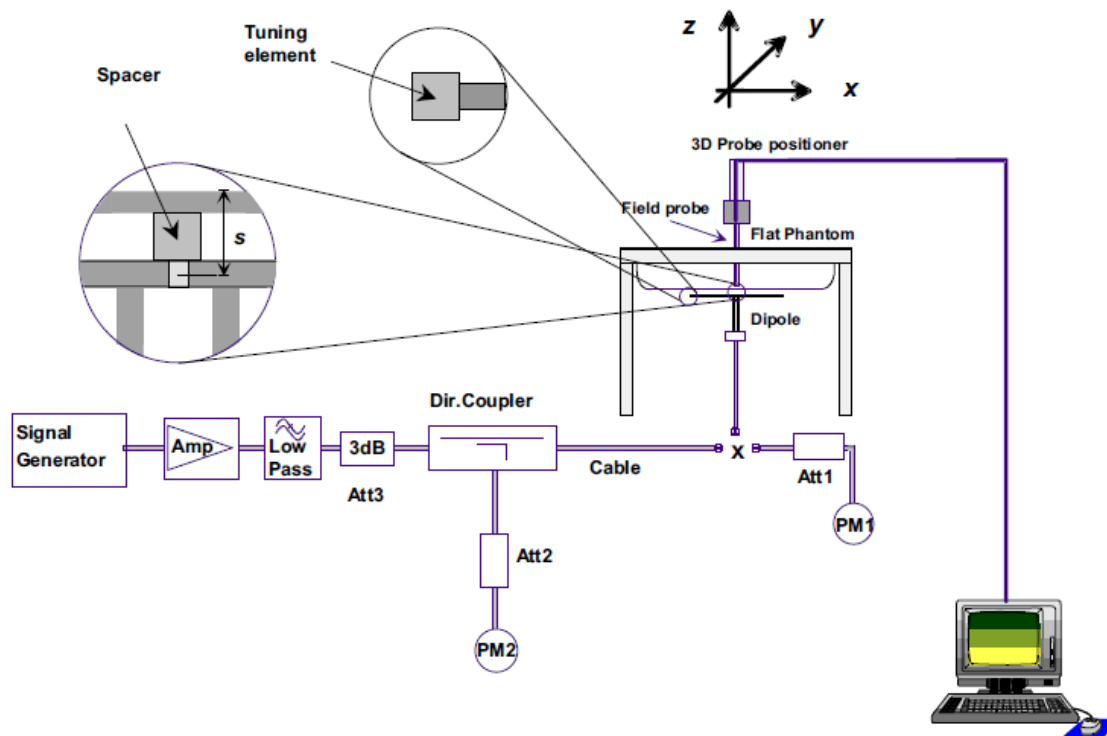

F-3. the microwave circuit arrangement used for SAR system verification

### 6.2.1 Justification for Extended SAR Dipole Calibrations

1) Referring to KDB865664 D01 requirements for dipole calibration, instead of the typical annual calibration recommended by measurement standards, longer calibration intervals of up to three years may be considered when it is demonstrated that the SAR target, impedance and return loss of a dipole have remain stable according to the following requirements. Each measured dipole is expected to evaluate with the following criteria at least on annual interval in Appendix C.

- a) There is no physical damage on the dipole;
- b) System check with specific dipole is within 10% of calibrated value;
- c) Return-loss is within 10% of calibrated measurement;
- d) Impedance is within  $5\Omega$  from the previous measurement.

2) Network analyzer probe calibration against air, distilled water and a shorting block performed before measuring liquid parameters.

### 6.2.2 Summary System Check Result(s)

Validation Kit	Measured SAR 250mW 1g (W/kg)	Measured SAR 250mW 10g (W/kg)	Measured SAR (normalized to 1W) 1g (W/kg)	Measured SAR (normalized to 1W) 10g (W/kg)	Target SAR (normalized to 1W) (±10%)	Target SAR (normalized to 1W) (±10%)	Liquid Temp. (°C)	Measured Date
					1-g(W/kg)	10-g(W/kg)		
D2450V2   Body	12.5	5.76	50	23.04	50.9 (45.81~55.99)	23.6 (21.24~25.96)	22	2019/11/15

Table 5 : SAR System Check Result

### 6.2.3 Detailed System Check Results

Please see the Appendix A

## 7 Test Configuration

### 7.1.1 Bluetooth Test Configuration

For the Bluetooth SAR tests, a communication link is set up with the test mode software for BT mode test. Bluetooth USES frequency hopping technology to divide the transmitted data into packets and transmit the packets respectively through 79 designated Bluetooth channels, 1MHz Bandwidth, frequency hops at 1600 hops/second per the Bluetooth standard. The Radio Frequency Channel Number (RFCN) is allocated to 0, 39 and 78 respectively in the case of 2402~2480 MHz during the test at each test frequency channel, the EUT is operated at the RF continuous emission mode.

#### 7.1.1.1 Duty cycle

Band	Mode	Duty cycle(100%)
Bluetooth	GFSK	76.86

Bluetooth duty cycle:  $2.89/3.76=76.86\%$

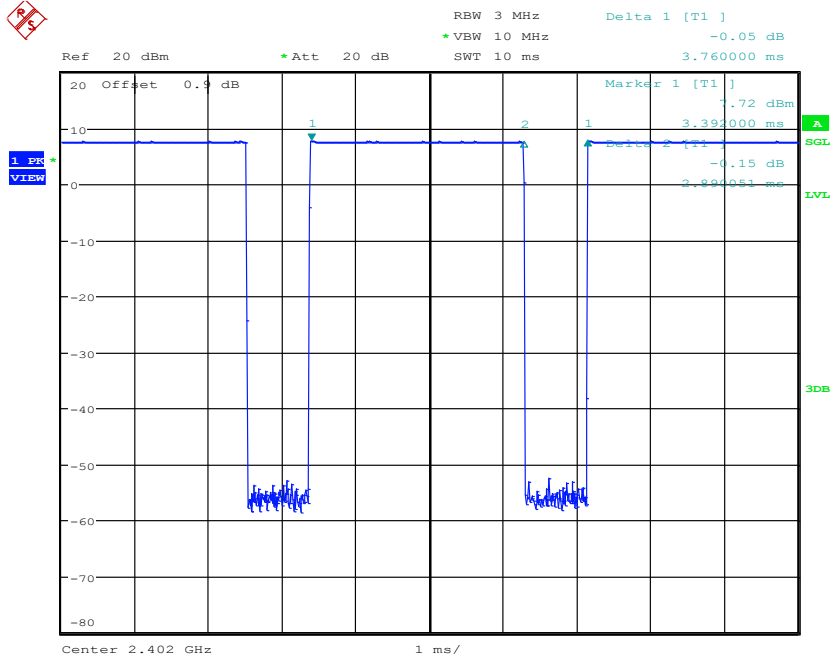

Date: 7.NOV.2019 10:27:22

## 8 Test Result

### 8.1 Measurement of RF Conducted Power

#### 8.1.1 Conducted Power Of BT

BT			Average Conducted Power(dBm)	Tune up (dBm)
Modulation	Channel	Frequency (MHz)		
GFSK	0	2402	7.5	9
	39	2441	8.56	9
	78	2480	<b>8.95</b>	9
$\pi/4$ DQPSK	0	2402	5.91	6.5
	39	2441	7.34	8
	78	2480	7.67	8
8DPSK	0	2402	5.91	6.5
	39	2441	7.31	8
	78	2480	7.73	8

BLE			Average Conducted Power(dBm)	Tune up (dBm)
Modulation	Channel	Frequency (MHz)		
GFSK	0	2402	-4.36	-3
	19	2440	-2.52	-2
	39	2480	-2.22	-2

Table 6: Conducted Power Of BT



## 8.2 Stand-alone SAR test evaluation

Unless specifically required by the published RF exposure KDB procedures, standalone 1-g head or body and 10-g extremity SAR evaluation for general population exposure conditions, by measurement or numerical simulation, is not required when the corresponding SAR Test Exclusion Threshold condition is satisfied. These test exclusion conditions are based on source-based time-averaged maximum conducted output power of the RF channel requiring evaluation, adjusted for tune-up tolerance, and the minimum test separation distance required for the exposure conditions.

Freq. Band	Frequency (GHz)	Position	Average Power		Test Separation (mm)	Calculate Value	Exclusion Threshold	Exclusion (Y/N)
			dBm	mW				
Bluetooth	2.48	Body	9	7.9	5	2.5	3	Y

The 1-g and 10-g SAR test exclusion thresholds for 100 MHz to 6 GHz at test separation distances  $\leq 50$  mm are determined by:

$[(\text{max. power of channel, including tune-up tolerance, mW}) / (\text{min. test separation distance, mm})] \cdot [\sqrt{f(\text{GHz})}] \leq 3.0$

for 1-g SAR and  $\leq 7.5$  for 10-g extremity SAR, where

- $f(\text{GHz})$  is the RF channel transmit frequency in GHz
- Power and distance are rounded to the nearest mW and mm before calculation
- The result is rounded to one decimal place for comparison

The test exclusions are applicable only when the minimum test separation distance is  $\leq 50$  mm and for transmission frequencies between 100 MHz and 6 GHz. When the minimum test separation distance is  $< 5$  mm, a distance of 5 mm is applied to determine SAR test exclusion.

SAR test is not required. Although exempt SAR, but the customer requires testing.

### 8.3 Body Test Exclusion Thresholds

The following SAR test exclusion Thresholds based on KDB 447498 D01 General RF Exposure Guidance v06) 4.3.1)

Freq. Band	Frequency (MHz)	Position	Max Power (dBm)	Max Power (mW)	Test Separation (mm)	Exclusion Threshold	Exclusion (Yes/No)
Bluetooth	2480	Front	9.0	7.9	7.0	1.8	Yes
	2480	Back	9.0	7.9	20.0	0.6	Yes
	2480	Side1	9.0	7.9	6.1	2.0	Yes

**Note:**

- Maximum power is the source-based time-average power and represents the maximum RF output power among production units
- Per KDB 447498 D01, for larger devices, the test separation distance of adjacent edge configuration is determined by the closest separation between the antenna and the user.
- Per KDB 447498 D01, standalone SAR test exclusion threshold is applied; If the distance of the antenna to the user is < 5mm, 5mm is used to determine SAR exclusion threshold
- Per KDB 447498 D01, the 1-g and 10-g SAR test exclusion thresholds for 100 MHz to 6 GHz at test separation distances ≤ 50 mm are determined by:  

$$[(\text{max. power of channel, including tune-up tolerance, mW}) / (\text{min. test separation distance, mm})] \cdot [\sqrt{f(\text{GHz})}] \leq 3.0$$
 for  
 1-g SAR and ≤ 7.5 for 10-g extremity SAR  
 f(GHz) is the RF channel transmit frequency in GHz  
 Power and distance are rounded to the nearest mW and mm before calculation  
 The result is rounded to one decimal place for comparison  
 For < 50 mm distance, we just calculate mW of the exclusion threshold value (3.0) to do compare.  
 This formula is  $[3.0] / [\sqrt{f(\text{GHz})}] \cdot [(\text{min. test separation distance, mm})] = \text{exclusion threshold of mW}$ .
- Per KDB 447498 D01, at 100 MHz to 6 GHz and for test separation distances > 50 mm, the SAR test exclusion threshold is determined according to the following
  - [Threshold at 50 mm in step 1) + (test separation distance - 50 mm) · (f(MHz)/150)] mW, at 100 MHz to 1500 MHz
  - [Threshold at 50 mm in step 1) + (test separation distance - 50 mm) · 10] mW at > 1500 MHz and ≤ 6 GHz
- When the minimum test separation distance is < 5 mm, a distance of 5 mm according to 5) in section 4.1 is applied to determine SAR test exclusion.
- SAR test is not required. Although exempt SAR, but the customer requires testing.

## 8.4 Measurement of SAR Data

### 8.4.1 SAR Result Of Bluetooth

Test position	Test mode	Test Ch./Freq.	Duty Cycle %	Duty Cycle Scaled factor	SAR (W/kg) 1-g	SAR (W/kg) 10-g	Power drift (dB)	Conducted power (dBm)	Tune up Limit (dBm)	Scaled factor	Scaled SAR 1-g (W/kg)	Liquid Temp.
Test data (Separate 0mm)												
Front side	GFSK	78/2480	76.86	1.301	0.009	0.00388	-0.03	8.95	9.00	1.012	0.012	22.0
Back side	GFSK	78/2480	76.86	1.301	0.005	0.00172	0.08	8.95	9.00	1.012	0.007	22.0
side 1	GFSK	78/2480	76.86	1.301	0.036	0.012	0.03	8.95	9.00	1.012	<b>0.047</b>	22.0

Table 7: SAR result of Bluetooth

Note:

- 1) The maximum Scaled SAR value is marked in bold. Graph Results refer to Appendix B
- 2) If the reported (scaled) SAR measured at the middle channel or highest output power channel for each test configuration is  $\leq 0.8$  W/kg then testing at the other channels is not required for such test configuration(s).

## 9 Equipment list

Test Platform	SPEAG DASY5 Professional					
Location	SGS-CCS Standards Technical Services Co., Ltd. Kunshan Branch					
Description	SAR Test System (Frequency range 300MHz-6GHz)					
Software Reference	DASY52 52.8.8(1222); SEMCAD X 14.6.10(7331)					
<b>Hardware Reference</b>						
Equipment	Manufacturer	Model	Serial Number	Calibration Date	Due date of calibration	
<input checked="" type="checkbox"/> P C	HP	Core(rm)3.16 G	CZCO48171H	N/A	N/A	
<input checked="" type="checkbox"/> Signal Generator	Agilent	E8257C	US37101915	2019/02/25	2020/02/24	
<input checked="" type="checkbox"/> S-Parameter Network Analyzer	Agilent	E5071B	MY42301382	2019/02/25	2020/02/24	
<input checked="" type="checkbox"/> Power sensor	Anritsu	E9327A	Us40441788	2019/02/25	2020/02/24	
<input checked="" type="checkbox"/> Power meter	Anritsu	E4416A	GB41292714	2019/02/25	2020/02/24	
<input checked="" type="checkbox"/> DAE	SPEAG	DAE4	1245	2019/05/21	2020/05/20	
<input checked="" type="checkbox"/> E-field PROBE	SPEAG	EX3DV4	3798	2019/05/24	2020/05/23	
<input checked="" type="checkbox"/> Dipole	SPEAG	D2450V2	817	2019/06/10	2022/06/09	
<input checked="" type="checkbox"/> Electro Thermometer	DTM	DTM3000	3030	2018/12/8	2019/12/7	
<input checked="" type="checkbox"/> Amplifier	Mini-circuits	ZVE-8G	110405	N/A	N/A	
<input checked="" type="checkbox"/> Amplifier	Mini-circuits	ZHL-42	QA1331003	N/A	N/A	
<input checked="" type="checkbox"/> 3db ATTENUATOR	MINI	MCL BW-S3W5	0533	N/A	N/A	
<input checked="" type="checkbox"/> DUMMY PROBE	SPEAG	DP_2	SPDP2001AA	N/A	N/A	
<input checked="" type="checkbox"/> Dual Directional Coupler	Woken	20W couple	DOM2BHW1A1	N/A	N/A	
<input checked="" type="checkbox"/> SAM PHANTOM (ELI4 v4.0)	SPEAG	QDOVA001BB	1102	N/A	N/A	
<input checked="" type="checkbox"/> Twin SAM Phantom	SPEAG	QD000P40CD	1609	N/A	N/A	
<input checked="" type="checkbox"/> ROBOT	SPEAG	TX60	F10/5E6AA1/A10 1	N/A	N/A	
<input checked="" type="checkbox"/> ROBOT KRC	SPEAG	CS8C	F10/5E6AA1/C10 1	N/A	N/A	
<input checked="" type="checkbox"/> LIQUID CALIBRATION KIT	ANTENNESS A	41/05 OCP9	00425167	N/A	N/A	

Note: All the equipments are within the valid period when the tests are performed.

All measurement facilities used to collect the measurement data are located at

No.10, Weiye Rd., Innovation Park, Eco & Tec. Development Part, Kunshan City, Jiangsu Province, China.

## 10 Calibration certificate

Please see the Appendix C

## 11 Photographs

Please see the Appendix D

## Appendix A: Detailed System Check Results

The plots are showing as followings.

Date: 2019/11/15

Test Laboratory: Compliance Certification Services Inc.

### System Performance Check-Body 2450MHz

**DUT: Dipole 2450 MHz; Type: D24500V2; Serial: 817**

Communication System: UID 0, CW; Frequency: 2450 MHz; Duty Cycle: 1:1  
 Medium parameters used:  $f = 2450 \text{ MHz}$ ;  $\sigma = 1.995 \text{ S/m}$ ;  $\epsilon_r = 52.325$ ;  $\rho = 1000 \text{ kg/m}^3$   
 Phantom section: Flat Section  
 Measurement Standard: DASYS (IEEE/IEC/ANSI C63.19-2007)

DASY5 Configuration:

- Probe: EX3DV4 - SN3798; ConvF(7.37, 7.37, 7.37); Calibrated: 2019/05/24;
- Sensor-Surface: 1.4mm (Mechanical Surface Detection)
- Electronics: DAE4 Sn1245; Calibrated: 2019/05/21
- Phantom: ELI v4.0; Type: QDOVA001BB; Serial: TP:1102
- Measurement SW: DASYS2, Version 52.8 (8); SEMCAD X Version 14.6.10 (7331)

**Body/Pin=250 mW, dist=10mm (EX-Probe)/Area Scan (9x10x1):** Measurement grid:  
 $dx=12\text{mm}$ ,  $dy=12\text{mm}$   
 Maximum value of SAR (measured) = 16.9 W/kg

**Body/Pin=250 mW, dist=10mm (EX-Probe)/Zoom Scan (7x7x7) (7x7x7)/Cube 0:**  
 Measurement grid:  $dx=5\text{mm}$ ,  $dy=5\text{mm}$ ,  $dz=5\text{mm}$   
 Reference Value = 97.33 V/m; Power Drift = -0.01 dB  
 Peak SAR (extrapolated) = 25.9 W/kg  
**SAR(1 g) = 12.5 W/kg; SAR(10 g) = 5.76 W/kg**  
 Maximum value of SAR (measured) = 19.3 W/kg

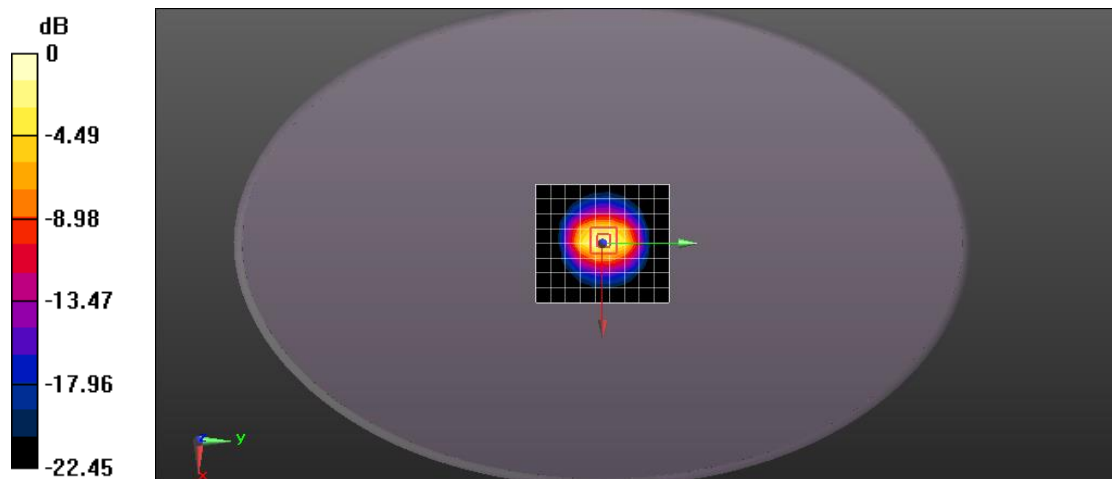

0 dB = 19.3 W/kg = 12.86 dBW/kg

## Appendix B: Detailed Test Results

The plots of worse case are showing as followings.



Date: 2019/11/15

Test Laboratory: Compliance Certification Services Inc.

**Bluetooth GFSK 802.11b 1Mbps Side2 Ch78 0mm**

**DUT: USB and Bluetooth Speakerphone; Type: CL5300-M USB-C; Serial: EA2J8D**

Communication System: UID 0, Bluetooth (0); Frequency: 2480 MHz; Duty Cycle: 1:1  
 Medium parameters used:  $f = 2480$  MHz;  $\sigma = 2.025$  S/m;  $\epsilon_r = 52.305$ ;  $\rho = 1000$  kg/m<sup>3</sup>  
 Phantom section: Flat Section  
 Measurement Standard: DASYS (IEEE/IEC/ANSI C63.19-2007)

DASY5 Configuration:

- Probe: EX3DV4 - SN3798; ConvF(7.37, 7.37, 7.37); Calibrated: 2019/05/24;
- Sensor-Surface: 1.4mm (Mechanical Surface Detection)
- Electronics: DAE4 Sn1245; Calibrated: 2019/05/21
- Phantom: ELI v4.0; Type: QDOVA001BB; Serial: TP:1102
- Measurement SW: DASYS2, Version 52.8 (8); SEMCAD X Version 14.6.10 (7331)

**Configuration/Body/Area Scan (5x8x1):** Measurement grid: dx=12mm, dy=12mm  
 Maximum value of SAR (measured) = 0.0583 W/kg

**Configuration/Body/Zoom Scan (7x7x7)/Cube 0:** Measurement grid: dx=5mm, dy=5mm, dz=5mm

Reference Value = 5.295 V/m; Power Drift = 0.03 dB

Peak SAR (extrapolated) = 0.105 W/kg

**SAR(1 g) = 0.036 W/kg; SAR(10 g) = 0.012 W/kg**

Maximum value of SAR (measured) = 0.0666 W/kg

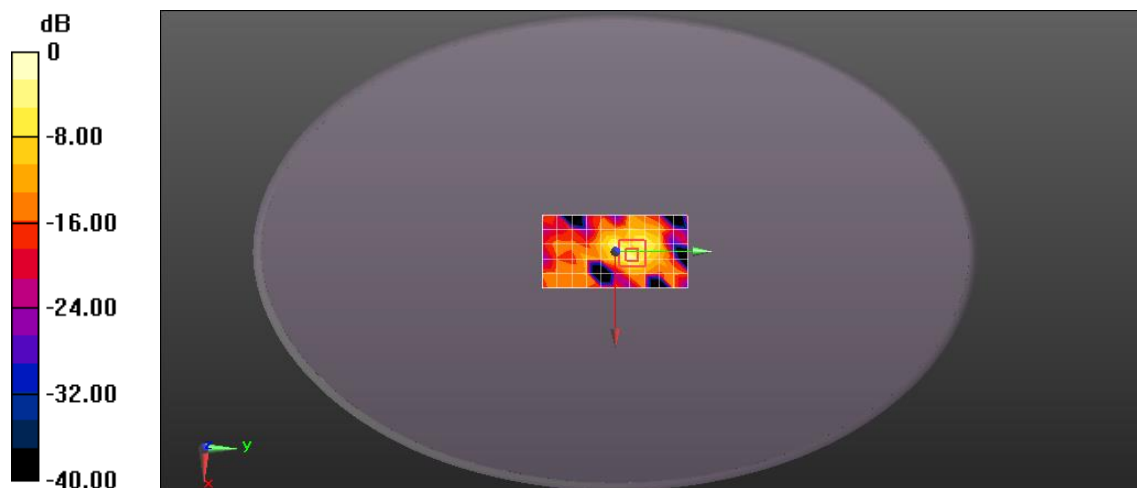

0 dB = 0.0432 W/kg = -13.65 dBW/kg

## Appendix C: Calibration certificate

## Appendix D: Photographs

---END---

---