

# SAR Test Report

Report No.: AGC01662180606FH01

**APPLICATION PURPOSE** : Original Equipment

**PRODUCT DESIGNATION** : Bluetooth Headset

**BRAND NAME** : PLANTRONICS

**MODEL NAME** : BG410S

**CLIENT** : Plantronics, Inc.

**DATE OF ISSUE** : Aug 03,2018

**STANDARD(S)** : IEEE Std. 1528:2013  
FCC 47CFR § 2.1093  
IEEE/ANSI C95.1:2005

**REPORT VERSION** : V1.0

## Attestation of Global Compliance(Shenzhen) Co., Ltd.

**CAUTION:**

This report shall not be reproduced except in full without the written permission of the test laboratory and shall not be quoted out of context.



The results shown in this test report refer only to the sample(s) tested unless otherwise stated and the sample(s) are retained for 30 days only. The document is issued by AGC, this document cannot be reproduced except in full with our prior written permission. The more details and the authenticity of the report will be confirmed at <http://www.agc-cert.com>.

### Report Revise Record

Report Version	Revise Time	Issued Date	Valid Version	Notes
V1.0	/	Aug 03,2018	Valid	Initial Release

The results shown in this test report refer only to the sample(s) tested unless otherwise stated and the sample(s) are retained for 30 days only. The document is issued by AGC, this document cannot be reproduced except in full with our prior written permission. The more details and the authenticity of the report will be confirmed at <http://www.agc-cert.com>.

## Test Report

Applicant Name	Plantronics, Inc.
Applicant Address	345 Encinal Street, Santa Cruz, CA, 95060, USA
Manufacturer Name	Plantronics, Inc.
Manufacturer Address	345 Encinal Street, Santa Cruz, CA, 95060, USA
Product Designation	Bluetooth Headset
Brand Name	PLANTRONICS
Model Name	BG410S
Different Description	N/A
EUT Voltage	DC3.7V by battery
Applicable Standard	IEEE Std. 1528:2013 FCC 47CFR § 2.1093 IEEE/ANSI C95.1:2005
Test Date	July 30,2018
Report Template	AGCRT-US-Bluetooth/SAR (2018-01-01)

Note: The results of testing in this report apply to the product/system which was tested only.



Tested By \_\_\_\_\_

Eric Zhou(Zhou Yongkang)

July 30,2018



Checked By \_\_\_\_\_

Angela Li(Li Jiao)

Aug 03,2018



Authorized By \_\_\_\_\_

Forrest Lei(Lei Yonggang)

Aug 03,2018

Authorized Officer

The results shown in this test report refer only to the sample(s) tested unless otherwise stated and the sample(s) are retained for 30 days only. The document is issued by AGC, this document cannot be reproduced except in full with our prior written permission. The more details and the authenticity of the report will be confirmed at <http://www.agc-cert.com>.



**TABLE OF CONTENTS**

<b>1. SUMMARY OF MAXIMUM SAR VALUE .....</b>	<b>5</b>
<b>2. GENERAL INFORMATION.....</b>	<b>6</b>
2.1. EUT DESCRIPTION.....	6
<b>3. SAR MEASUREMENT SYSTEM.....</b>	<b>7</b>
3.1. THE SATIMO SYSTEM USED FOR PERFORMING COMPLIANCE TESTS CONSISTS OF FOLLOWING ITEMS .....	7
3.2. COMOSAR E-FIELD PROBE .....	8
3.3. ROBOT.....	8
3.4. VIDEO POSITIONING SYSTEM .....	9
3.5. DEVICE HOLDER .....	9
3.6. SAM TWIN PHANTOM.....	10
<b>4. SAR MEASUREMENT PROCEDURE.....</b>	<b>11</b>
4.1. SPECIFIC ABSORPTION RATE (SAR).....	11
4.2. SAR MEASUREMENT PROCEDURE .....	12
4.3. RF EXPOSURE CONDITIONS .....	14
<b>5. TISSUE SIMULATING LIQUID.....</b>	<b>15</b>
5.1. THE COMPOSITION OF THE TISSUE SIMULATING LIQUID.....	15
5.2. TISSUE DIELECTRIC PARAMETERS FOR HEAD AND BODY PHANTOMS .....	15
5.3. TISSUE CALIBRATION RESULT .....	16
<b>6. SAR SYSTEM CHECK PROCEDURE .....</b>	<b>17</b>
6.1. SAR SYSTEM CHECK PROCEDURES .....	17
6.2. SAR SYSTEM CHECK.....	18
<b>7. EUT TEST POSITION .....</b>	<b>19</b>
7.1. BODY PART POSITION .....	19
<b>8. SAR EXPOSURE LIMITS .....</b>	<b>20</b>
<b>9. TEST FACILITY .....</b>	<b>21</b>
<b>10. TEST EQUIPMENT LIST .....</b>	<b>22</b>
<b>11. MEASUREMENT UNCERTAINTY .....</b>	<b>23</b>
<b>12. CONDUCTED POWER MEASUREMENT.....</b>	<b>26</b>
<b>13. TEST RESULTS.....</b>	<b>27</b>
13.1. SAR TEST RESULTS SUMMARY.....	27
<b>APPENDIX A. SAR SYSTEM CHECK DATA .....</b>	<b>29</b>
<b>APPENDIX B. SAR MEASUREMENT DATA.....</b>	<b>31</b>
<b>APPENDIX C. TEST SETUP PHOTOGRAPHS.....</b>	<b>35</b>
<b>APPENDIX D. CALIBRATION DATA .....</b>	<b>36</b>

The results shown in this test report refer only to the sample(s) tested unless otherwise stated and the sample(s) are retained for 30 days only. The document is issued by AGC, this document cannot be reproduced except in full with our prior written permission. The more details and the authenticity of the report will be confirmed at <http://www.agc-cert.com>.

## 1. SUMMARY OF MAXIMUM SAR VALUE

The maximum results of Specific Absorption Rate (SAR) found during testing for EUT are as follows:

Frequency Band	Highest Reported 1g-SAR(W/Kg)	SAR Test Limit (W/Kg)
	Head SAR (with 0mm separation)	
BT(BR/EDR)	0.180	1.6
BT(BLE)	0.030	
SAR Test Result	PASS	

This device is compliance with Specific Absorption Rate (SAR) for general population/uncontrolled exposure limits (1.6W/Kg) specified in IEEE Std. 1528:2013; FCC 47CFR § 2.1093; IEEE/ANSI C95.1:2005 and the following specific FCC Test Procedures:

- KDB 447498 D01 General RF Exposure Guidance v06
- KDB 865664 D01 SAR Measurement 100MHz to 6GHz v01r04

The results shown in this test report refer only to the sample(s) tested unless otherwise stated and the sample(s) are retained for 30 days only. The document is issued by AGC, this document cannot be reproduced except in full with our prior written permission. The more details and the authenticity of the report will be confirmed at <http://www.agc-cert.com>.

## 2. GENERAL INFORMATION

### 2.1. EUT Description

General Information	
Product Designation	Bluetooth Headset
Test Model	BG410S
Hardware Version	BG410S
Software Version	V1.0.0.16
Device Category	Portable
RF Exposure Environment	Uncontrolled
Antenna Type	Internal
Bluetooth	
Bluetooth Version	<input type="checkbox"/> V2.0 <input type="checkbox"/> V2.1 <input type="checkbox"/> V2.1+EDR <input type="checkbox"/> V3.0 <input type="checkbox"/> V3.0+HS <input type="checkbox"/> V4.0 <input checked="" type="checkbox"/> V5.0
Operation Frequency	2402~2480MHz
Type of modulation	<input checked="" type="checkbox"/> GFSK <input checked="" type="checkbox"/> II/4-DQPSK <input checked="" type="checkbox"/> 8-DPSK
Peak Output Power	BR/EDR:5.62dBm;BLE: 5.73dBm
Antenna Gain	2.0dBi
Battery Type (s) Tested:	DC 3.7V,182 mAh (by battery)

Note: The sample used for testing is end product.

Product	Type
	<input checked="" type="checkbox"/> Production unit <input type="checkbox"/> Identical Prototype

The results shown in this test report refer only to the sample(s) tested unless otherwise stated and the sample(s) are retained for 30 days only. The document is issued by AGC, this document cannot be reproduced except in full with our prior written permission. The more details and the authenticity of the report will be confirmed at <http://www.agc-cert.com>.



### 3. SAR MEASUREMENT SYSTEM

#### 3.1. The SATIMO system used for performing compliance tests consists of following items

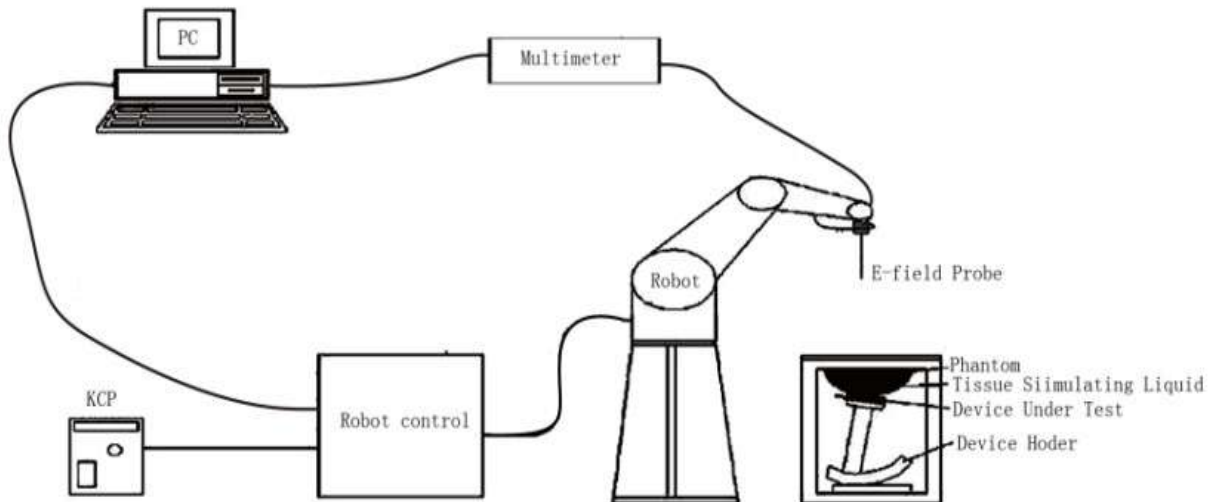

The COMOSAR system for performing compliance tests consists of the following items:

- The PC. It controls most of the bench devices and stores measurement data. A computer running WinXP and the Opensar software.
- The E-Field probe. The probe is a 3-axis system made of 3 distinct dipoles. Each dipole returns a voltage in function of the ambient electric field.
- The Keithley multimeter measures each probe dipole voltages.
- The SAM phantom simulates a human head. The measurement of the electric field is made inside the phantom.
- The liquids simulate the dielectric properties of the human head tissues.
- The network emulator controls the mobile phone under test.
- The validation dipoles are used to measure a reference SAR. They are used to periodically check the bench to make sure that there is no drift of the system characteristics over time.
- The phantom, the device holder and other accessories according to the targeted measurement.

The results shown in this test report refer only to the sample(s) tested unless otherwise stated and the sample(s) are retained for 30 days only. The document is issued by AGC, this document cannot be reproduced except in full with our prior written permission. The more details and the authenticity of the report will be confirmed at <http://www.agc-cert.com>.

### 3.2. COMOSAR E-Field Probe

The SAR measurement is conducted with the dosimetric probe manufactured by SATIMO. The probe is specially designed and calibrated for use in liquid with high permittivity. The dosimetric probe has special calibration in liquid at different frequency. SATIMO conducts the probe calibration in compliance with international and national standards (e.g. IEEE 1528 and relevant KDB files.) The calibration data are in Appendix D.

#### Isotropic E-Field Probe Specification

<b>Model</b>	SSE2	
<b>Manufacture</b>	MVG	
<b>Identification No.</b>	SN 08/16 EPGO282	
<b>Frequency</b>	0.7GHz-6GHz Linearity:±0.06dB(700MHz-6GHz)	
<b>Dynamic Range</b>	0.01W/Kg-100W/Kg Linearity:±0.06dB	
<b>Dimensions</b>	Overall length:330mm Length of individual dipoles:2mm Maximum external diameter:8mm Probe Tip external diameter:2.5mm Distance between dipoles/ probe extremity:1mm	
<b>Application</b>	High precision dosimetric measurements in any exposure scenario (e.g., very strong gradient fields). Only probe which enables compliance testing for frequencies up to 6 GHz with precision of better 30%.	

### 3.3. Robot

The COMOSAR system uses the KUKA robot from SATIMO SA (France).For the 6-axis controller COMOSAR system, the KUKA robot controller version from SATIMO is used.

The XL robot series have many features that are important for our application:

- High precision (repeatability 0.02 mm)
- High reliability (industrial design)
- Jerk-free straight movements
- Low ELF interference (the closed metallic construction shields against motor control fields)
- 6-axis controller



The results shown in this test report refer only to the sample(s) tested unless otherwise stated and the sample(s) are retained for 30 days only. The document is issued by AGC, this document cannot be reproduced except in full with our prior written permission. The more details and the authenticity of the report will be confirmed at <http://www.agc-cert.com>.



### 3.4. Video Positioning System

The video positioning system is used in OpenSAR to check the probe. Which is composed of a camera, LED, mirror and mechanical parts. The camera is piloted by the main computer with firewire link. During the process, the actual position of the probe tip with respect to the robot arm is measured, as well as the probe length and the horizontal probe offset. The software then corrects all movements, such that the robot coordinates are valid for the probe tip. The repeatability of this process is better than 0.1 mm. If a position has been taught with an aligned probe, the same position will be reached with another aligned probe within 0.1 mm, even if the other probe has different dimensions. During probe rotations, the probe tip will keep its actual position.

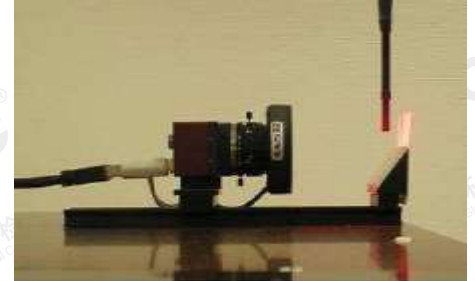

### 3.5. Device Holder

The COMOSAR device holder is designed to cope with different positions given in the standard. It has two scales for the device rotation (with respect to the body axis) and the device inclination (with respect to the line between the ear reference points). The rotation center for both scales is the ear reference point (EPR). Thus the device needs no repositioning when changing the angles. The COMOSAR device holder has been made out of low-loss POM material having the following dielectric parameters: relative permittivity  $\epsilon_r = 3$  and loss tangent  $\delta = 0.02$ . The amount of dielectric material has been reduced in the closest vicinity of the device, since measurements have suggested that the influence of the clamp on the test results could thus be lowered.

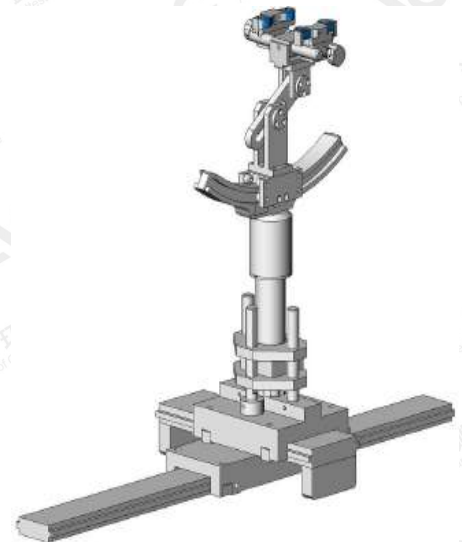

The results shown in this test report refer only to the sample(s) tested unless otherwise stated and the sample(s) are retained for 30 days only. The document is issued by AGC, this document cannot be reproduced except in full with our prior written permission. The more details and the authenticity of the report will be confirmed at <http://www.agc-cert.com>.

### 3.6. SAM Twin Phantom

The SAM twin phantom is a fiberglass shell phantom with 2mm shell thickness (except the ear region where shell thickness increases to 6mm). It has three measurement areas:

- Left head
- Right head
- Flat phantom



The bottom plate contains three pair of bolts for locking the device holder. The device holder positions are adjusted to the standard measurement positions in the three sections. A white cover is provided to tap the phantom during off-periods to prevent water evaporation and changes in the liquid parameters. On the phantom top, three reference markers are provided to identify the phantom position with respect to the robot.

The results shown in this test report refer only to the sample(s) tested unless otherwise stated and the sample(s) are retained for 30 days only. The document is issued by AGC, this document cannot be reproduced except in full with our prior written permission. The more details and the authenticity of the report will be confirmed at <http://www.agc-cert.com>.



## 4. SAR MEASUREMENT PROCEDURE

### 4.1. Specific Absorption Rate (SAR)

SAR is related to the rate at which energy is absorbed per unit mass in object exposed to a radio field. The SAR distribution in a biological body is complicated and is usually carried out by experimental techniques or numerical modeling. The standard recommends limits for two tiers of groups, occupational/controlled and occupational/uncontrolled, based on a person's awareness and ability to exercise control over his or her exposure. In general, occupational/controlled exposure limits are higher than the limits for general population/uncontrolled.

The SAR definition is the time derivative (rate) of the incremental energy (dW) absorbed by (dissipated in) an incremental mass (dm) contained in a volume element(dv) of given mass density (ρ). The equation description is as below:

$$SAR = \frac{d}{dt} \left( \frac{dW}{dm} \right) = \frac{d}{dt} \left( \frac{dW}{\rho dV} \right)$$

SAR is expressed in units of Watts per kilogram (W/Kg)

SAR can be obtained using either of the following equations:

$$SAR = \frac{\sigma E^2}{\rho}$$

$$SAR = c_h \left. \frac{dT}{dt} \right|_{t=0}$$

Where

SAR	is the specific absorption rate in watts per kilogram;
E	is the r.m.s. value of the electric field strength in the tissue in volts per meter;
σ	is the conductivity of the tissue in siemens per metre;
ρ	is the density of the tissue in kilograms per cubic metre;
C <sub>h</sub>	is the heat capacity of the tissue in joules per kilogram and Kelvin;
$\left. \frac{dT}{dt} \right _{t=0}$	is the initial time derivative of temperature in the tissue in kelvins per second

The results shown in this test report refer only to the sample(s) tested unless otherwise stated and the sample(s) are retained for 30 days only. The document is issued by AGC, this document cannot be reproduced except in full with our prior written permission. The more details and the authenticity of the report will be confirmed at <http://www.agc-cert.com>.



## 4.2. SAR Measurement Procedure

### Step 1: Power Reference Measurement

The Power Reference Measurement and Power Drift Measurement are for monitoring the power drift of the device under test in the batch process. The minimum distance of probe sensors to surface is 2.7mm This distance cannot be smaller than the distance of sensor calibration points to probe tip as defined in the probe properties,

### Step 2: Area Scan

The Area Scan is used as a fast scan in two dimensions to find the area of high field values, before doing a fine measurement around the hot spot. The sophisticated interpolation routines implemented in SATIMO software can find the maximum locations even in relatively coarse grids. When an Area Scan has measured all reachable points, it computes the field maximal found in the scanned area, within a range of the global maximum. The range (in db) is specified in the standards for compliance testing. For example, a 2db range is required in IEEE Standard 1528, whereby 3db is a requirement when compliance is assessed in accordance with the ARIB standard (Japan) If one Zoom Scan follows the Area Scan, then only the absolute maximum will be taken as reference. For cases where multiple maximum are detected, the number of Zoom Scan has to be increased accordingly.

Area Scan Parameters extracted from KDB 865664 D01 SAR Measurement 100MHz to 6GHz

	≤ 3 GHz	> 3 GHz
Maximum distance from closest measurement point (geometric center of probe sensors) to phantom surface	5 ± 1 mm	$\frac{1}{2} \cdot \delta \cdot \ln(2) \pm 0.5$ mm
Maximum probe angle from probe axis to phantom surface normal at the measurement location	30° ± 1°	20° ± 1°
Maximum area scan spatial resolution: $\Delta x_{Area}$ , $\Delta y_{Area}$	≤ 2 GHz: ≤ 15 mm 2 – 3 GHz: ≤ 12 mm	3 – 4 GHz: ≤ 12 mm 4 – 6 GHz: ≤ 10 mm
	When the x or y dimension of the test device, in the measurement plane orientation, is smaller than the above, the measurement resolution must be ≤ the corresponding x or y dimension of the test device with at least one measurement point on the test device.	

### Step 3: Zoom Scan

Zoom Scan are used to assess the peak spatial SAR value within a cubic average volume containing 1g and 10g of simulated tissue. The Zoom Scan measures points(refer to table below) within a cube whose base faces are centered on the maxima found in a preceding area scan job within the same procedure. When the measurement is done, the Zoom Scan evaluates the averaged SAR for 1g and 10g and displays these values next to the job's label.

The results shown in this test report refer only to the sample(s) tested unless otherwise stated and the sample(s) are retained for 30 days only. The document is issued by AGC, this document cannot be reproduced except in full with our prior written permission. The more details and the authenticity of the report will be confirmed at <http://www.agc-cert.com>.

Zoom Scan Parameters extracted from KDB865664 d01 SAR Measurement 100MHz to 6GHz

Maximum zoom scan spatial resolution: $\Delta x_{Zoom}$ , $\Delta y_{Zoom}$		$\leq 2$ GHz: $\leq 8$ mm 2 – 3 GHz: $\leq 5$ mm*	3 – 4 GHz: $\leq 5$ mm* 4 – 6 GHz: $\leq 4$ mm*
Maximum zoom scan spatial resolution, normal to phantom surface	uniform grid: $\Delta z_{Zoom}(n)$	$\leq 5$ mm	3 – 4 GHz: $\leq 4$ mm 4 – 5 GHz: $\leq 3$ mm 5 – 6 GHz: $\leq 2$ mm
	graded grid	$\Delta z_{Zoom}(1)$ : between 1 <sup>st</sup> two points closest to phantom surface	$\leq 4$ mm
		$\Delta z_{Zoom}(n>1)$ : between subsequent points	$\leq 1.5 \cdot \Delta z_{Zoom}(n-1)$
Minimum zoom scan volume	x, y, z	$\geq 30$ mm	3 – 4 GHz: $\geq 28$ mm 4 – 5 GHz: $\geq 25$ mm 5 – 6 GHz: $\geq 22$ mm
<p>Note: <math>\delta</math> is the penetration depth of a plane-wave at normal incidence to the tissue medium; see draft standard IEEE P1528-2011 for details.</p> <p>* When zoom scan is required and the <i>reported</i> SAR from the <i>area scan based 1-g SAR estimation</i> procedures of KDB 447498 is <math>\leq 1.4</math> W/kg, <math>\leq 8</math> mm, <math>\leq 7</math> mm and <math>\leq 5</math> mm zoom scan resolution may be applied, respectively, for 2 GHz to 3 GHz, 3 GHz to 4 GHz and 4 GHz to 6 GHz.</p>			

Step 4: Power Drift Measurement

The Power Drift Measurement measures the field at the same location as the most recent power reference measurement within the same procedure, and with the same settings. The Power Drift Measurement gives the field difference in dB from the reading conducted within the same settings. This allows a user to monitor the power drift of the device under test within a batch process. The measurement procedure is the same as Step 1.

The results shown in this test report refer only to the sample(s) tested unless otherwise stated and the sample(s) are retained for 30 days only. The document is issued by AGC, this document cannot be reproduced except in full with our prior written permission. The more details and the authenticity of the report will be confirmed at <http://www.agc-cert.com>.

### 4.3. RF Exposure Conditions

Test Configuration and setting:

The device is a bluetooth headset, and supports Bluetooth wireless technology.

For SAR testing, the device was controlled by software to test at reference fixed frequency points.

#### Antenna Location: (front view )

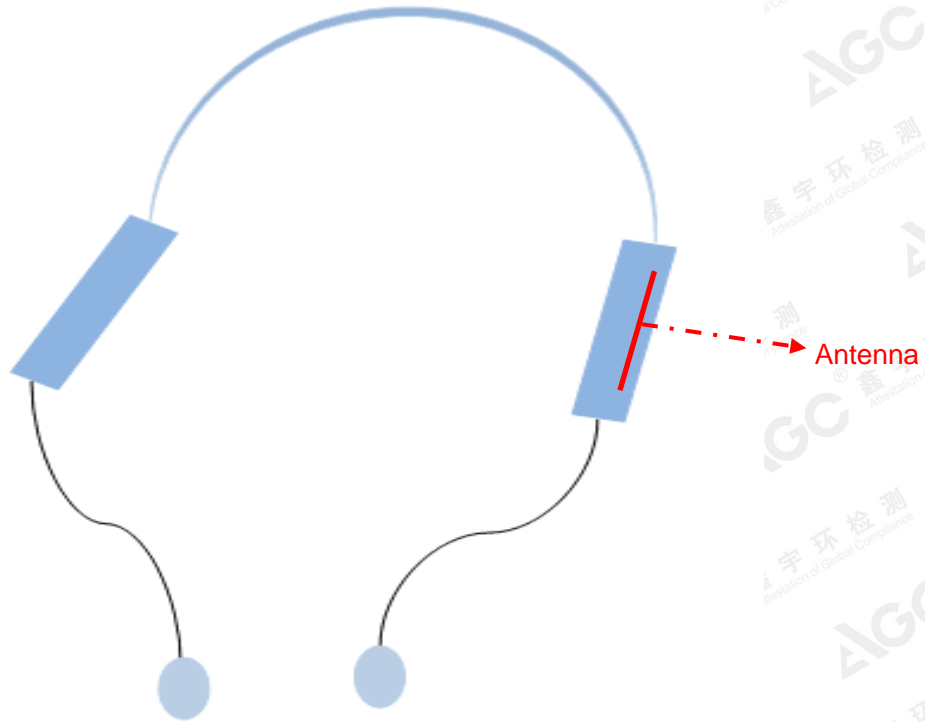

The results shown in this test report refer only to the sample(s) tested unless otherwise stated and the sample(s) are retained for 30 days only. The document is issued by AGC, this document cannot be reproduced except in full with our prior written permission. The more details and the authenticity of the report will be confirmed at <http://www.agc-cert.com>.



## 5. TISSUE SIMULATING LIQUID

For SAR measurement of the field distribution inside the phantom, the phantom must be filled with homogeneous tissue simulating liquid to a depth of at least 15cm. For head SAR testing the liquid height from the ear reference point (ERP) of the phantom to the liquid top surface is larger than 15cm For body SAR testing, the liquid height from the center of the flat phantom to the liquid top surface is larger than 15cm. The nominal dielectric values of the tissue simulating liquids in the phantom and the tolerance of 5% are listed in 5.2

### 5.1. The composition of the tissue simulating liquid

Ingredient (% Weight) Frequency (MHz)	Water	Nacl	Polysorbate 20	DGBE	1,2 Propanediol	Triton X-100
2450 Head	71.88	0.16	0.0	7.99	0.0	19.97

### 5.2. Tissue Dielectric Parameters for Head and Body Phantoms

The head tissue dielectric parameters recommended by the IEEE 1528 have been incorporated in the following table. These head parameters are derived from planar layer models simulating the highest expected SAR for the dielectric properties and tissue thickness variations in a human head. Other head and body tissue parameters that have not been specified in IEEE 1528 are derived from the tissue dielectric parameters computed from the 4-Cole-Cole equations described in Reference [12] and extrapolated according to the head parameters specified in IEEE 1528.

Target Frequency (MHz)	head		body	
	$\epsilon_r$	$\sigma$ (S/m)	$\epsilon_r$	$\sigma$ (S/m)
300	45.3	0.87	58.2	0.92
450	43.5	0.87	56.7	0.94
835	41.5	0.90	55.2	0.97
900	41.5	0.97	55.0	1.05
915	41.5	1.01	55.0	1.06
1450	40.5	1.20	54.0	1.30
1610	40.3	1.29	53.8	1.40
1800 – 2000	40.0	1.40	53.3	1.52
<b>2450</b>	<b>39.2</b>	<b>1.80</b>	52.7	1.95
3000	38.5	2.40	52.0	2.73

( $\epsilon_r$  = relative permittivity,  $\sigma$  = conductivity and  $\rho = 1000$  kg/m<sup>3</sup>)

The results shown in this test report refer only to the sample(s) tested unless otherwise stated and the sample(s) are retained for 30 days only. The document is issued by AGC, this document cannot be reproduced except in full with our prior written permission. The more details and the authenticity of the report will be confirmed at <http://www.agc-cert.com>.

### 5.3. Tissue Calibration Result

The dielectric parameters of the liquids were verified prior to the SAR evaluation using SATIMO Dielectric Probe Kit and R&S Network Analyzer ZVL6.

Tissue Stimulant Measurement for 2450MHz					
	Fr. (MHz)	Dielectric Parameters ( $\pm 5\%$ )		Tissue Temp [°C]	Test time
		$\epsilon_r$ 39.2(37.24-41.16)	$\delta$ [s/m]1.80(1.71-1.89)		
Head	2402	40.03	1.75	21.7	July 30,2018
	2441	39.60	1.79		
	2450	39.14	1.83		
	2480	38.72	1.85		

The results shown in this test report refer only to the sample(s) tested unless otherwise stated and the sample(s) are retained for 30 days only. The document is issued by AGC, this document cannot be reproduced except in full with our prior written permission. The more details and the authenticity of the report will be confirmed at <http://www.agc-cert.com>.



## 6. SAR SYSTEM CHECK PROCEDURE

### 6.1. SAR System Check Procedures

SAR system check is required to confirm measurement accuracy, according to the tissue dielectric media, probe calibration points and other system operating parameters required for measuring the SAR of a test device. The system verification must be performed for each frequency band and within the valid range of each probe calibration point required for testing the device. The same SAR probe(s) and tissue-equivalent media combinations used with each specific SAR system for system verification must be used for device testing. When multiple probe calibration points are required to cover substantially large transmission bands, independent system verifications are required for each probe calibration point. A system verification must be performed before each series of SAR measurements using the same probe calibration point and tissue-equivalent medium. Additional system verification should be considered according to the conditions of the tissue-equivalent medium and measured tissue dielectric parameters, typically every three to four days when the liquid parameters are remeasured or sooner when marginal liquid parameters are used at the beginning of a series of measurements.

Each SATIMO system is equipped with one or more system check kits. These units, together with the predefined measurement procedures within the SATIMO software, enable the user to conduct the system check and system validation. System kit includes a dipole, and dipole device holder.

The system check verifies that the system operates within its specifications. It's performed daily or before every SAR measurement. The system check uses normal SAR measurement in the flat section of the phantom with a matched dipole at a specified distance. The system check setup is shown as below.

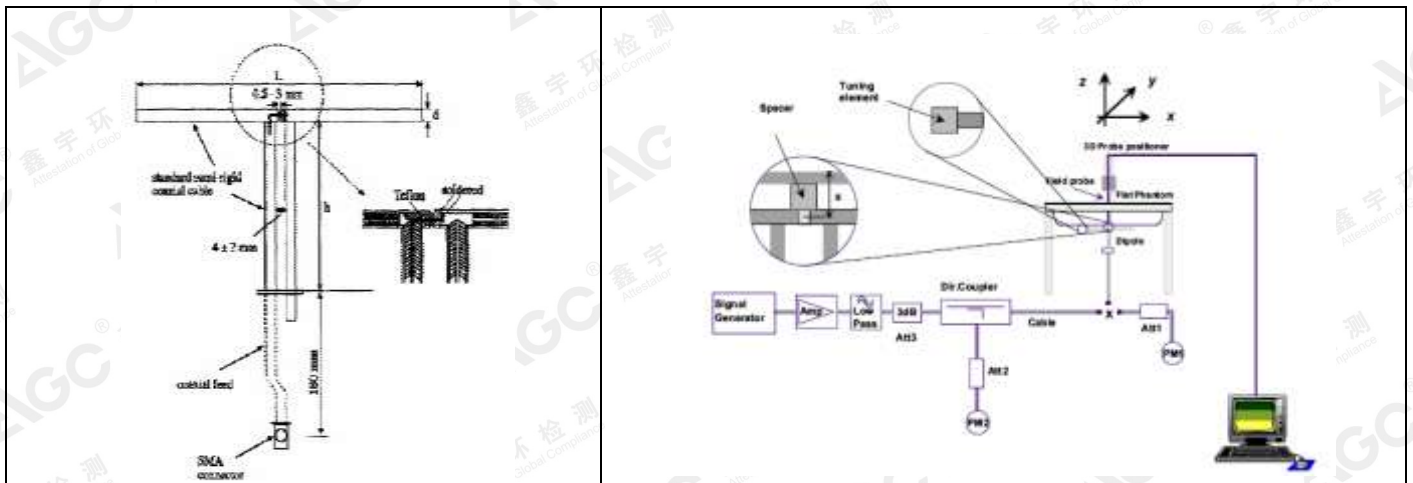

The results shown in this test report refer only to the sample(s) tested unless otherwise stated and the sample(s) are retained for 30 days only. The document is issued by AGC, this document cannot be reproduced except in full with our prior written permission. The more details and the authenticity of the report will be confirmed at <http://www.agc-cert.com>.



**6.2. SAR System Check**  
**6.2.1. Dipoles**

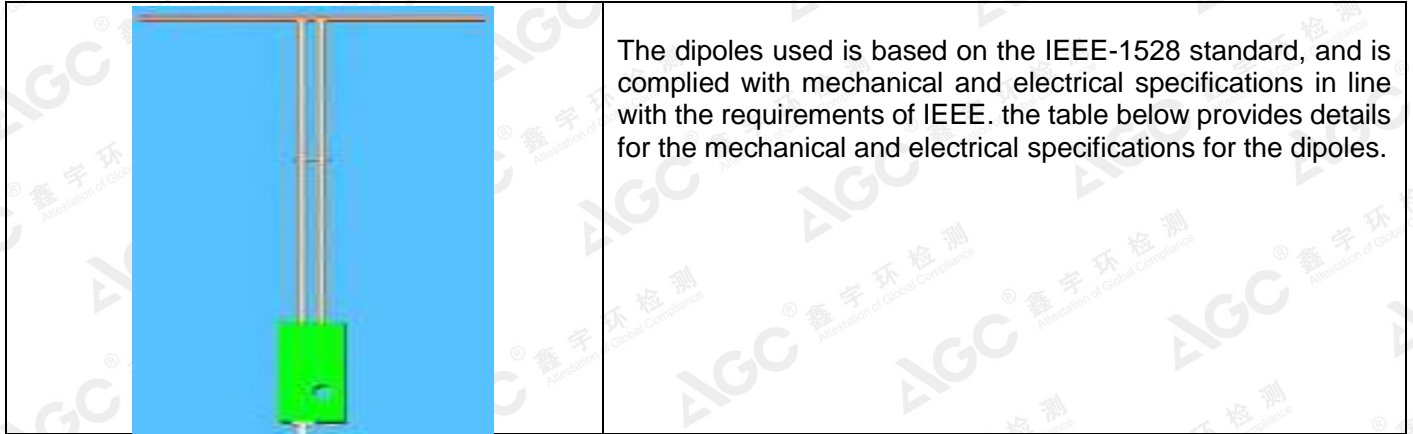

The dipoles used is based on the IEEE-1528 standard, and is complied with mechanical and electrical specifications in line with the requirements of IEEE. the table below provides details for the mechanical and electrical specifications for the dipoles.

Frequency	L (mm)	h (mm)	d (mm)
2450MHz	51.5	30.4	3.6

**6.2.2. System Check Result**

System Performance Check at 2450MHz for Head								
Validation Kit: SN 29/15DIP 2G450-393								
Frequency [MHz]	Target Value(W/Kg)		Reference Result (± 10%)		Tested Value(W/Kg)		Tissue Temp. [°C]	Test time
	1g	10g	1g	10g	1g	10g		
2450	54.53	24.30	49.077-59.983	21.87-26.730	53.91	23.30	21.7	July 30,2018

Note:

(1) We use a CW signal of 18dBm for system check, and then all SAR values are normalized to 1W forward power. The result must be within ±10% of target value.

The results shown in this test report refer only to the sample(s) tested unless otherwise stated and the sample(s) are retained for 30 days only. The document is issued by AGC, this document cannot be reproduced except in full with our prior written permission. The more details and the authenticity of the report will be confirmed at <http://www.agc-cert.com>.

## 7. EUT TEST POSITION

This EUT was tested in **Head SAR Front and Head SAR Back.**

### 7.1. Body Part Position

- (1) To position the EUT parallel to the phantom surface.
- (2) To adjust the EUT parallel to the flat phantom.
- (3) To adjust the distance between the EUT surface and the flat phantom to **0mm**

The SAR test procedure has been defined by FCC via KDB.

The results shown in this test report refer only to the sample(s) tested unless otherwise stated and the sample(s) are retained for 30 days only. The document is issued by AGC, this document cannot be reproduced except in full with our prior written permission. The more details and the authenticity of the report will be confirmed at <http://www.agc-cert.com>.



## 8. SAR EXPOSURE LIMITS

### Limits for General Population/Uncontrolled Exposure (W/kg)

Type Exposure	Uncontrolled Environment Limit (W/kg)
Spatial Peak SAR (1g cube tissue for brain or body)	1.60
Spatial Average SAR (Whole body)	0.08
Spatial Peak SAR (Limbs)	4.0

The results shown in this test report refer only to the sample(s) tested unless otherwise stated and the sample(s) are retained for 30 days only. The document is issued by AGC, this document cannot be reproduced except in full with our prior written permission. The more details and the authenticity of the report will be confirmed at <http://www.agc-cert.com>.

## 9. TEST FACILITY

<b>Test Site</b>	Attestation of Global Compliance (Shenzhen) Co., Ltd
<b>Location</b>	1-2F., Bldg.2, No.1-4, Chaxi Sanwei Technical Industrial Park, Gushu, Xixiang, Bao'an District B112-B113, Shenzhen 518012
<b>NVLAP Lab Code</b>	600153-0
<b>Designation Number</b>	CN5028
<b>Test Firm Registration Number</b>	682566
<b>Description</b>	Attestation of Global Compliance(Shenzhen) Co., Ltd is accredited by National Voluntary Laboratory Accreditation program, NVLAP Code 600153-0

The results shown in this test report refer only to the sample(s) tested unless otherwise stated and the sample(s) are retained for 30 days only. The document is issued by AGC, this document cannot be reproduced except in full with our prior written permission. The more details and the authenticity of the report will be confirmed at <http://www.agc-cert.com>.



## 10. TEST EQUIPMENT LIST

Equipment description	Manufacturer/ Model	Identification No.	Current calibration date	Next calibration date
SAR Probe	MVG	SN 08/16 EPGO282	Aug. 08,2017	Aug. 07,2018
Phantom	SATIMO	SN_4511_SAM90	Validated. No cal required.	Validated. No cal required.
Liquid	SATIMO	-	Validated. No cal required.	Validated. No cal required.
Multimeter	Keithley 2000	1188656	Mar. 01,2018	Feb. 28,2019
Dipole	SATIMO SID2450	SN29/15 DIP 2G450-393	July 05,2016	July 04,2019
Signal Generator	Agilent-E4438C	US41461365	Mar. 01,2018	Feb. 28,2019
Vector Analyzer	Agilent / E4440A	US41421290	Mar. 01,2018	Feb. 28,2019
Network Analyzer	Rhode & Schwarz ZVL6	SN100132	Mar. 01,2018	Feb. 28,2019
Attenuator	Warison /WATT-6SR1211	N/A	N/A	N/A
Attenuator	Mini-circuits / VAT-10+	N/A	N/A	N/A
Amplifier	EM30180	SN060552	Mar. 01,2018	Feb. 28,2019
Directional Couple	Werlatone/ C5571-10	SN99463	June 12,2018	June 11,2019
Directional Couple	Werlatone/ C6026-10	SN99482	June 12,2018	June 11,2019
Power Sensor	NRP-Z21	1137.6000.02	Oct. 12,2017	Oct. 11,2018
Power Sensor	NRP-Z23	US38261498	Mar. 01,2018	Feb. 28,2019
Power Viewer	R&S	V2.3.1.0	N/A	N/A

Note: Per KDB 865664 Dipole SAR Validation, AGC Lab has adopted 3 years calibration intervals. On annual basis, every measurement dipole has been evaluated and is in compliance with the following criteria:

1. There is no physical damage on the dipole;
2. System validation with specific dipole is within 10% of calibrated value;
3. Return-loss is within 20% of calibrated measurement;
4. Impedance is within 5Ω of calibrated measurement.

The results shown in this test report refer only to the sample(s) tested unless otherwise stated and the sample(s) are retained for 30 days only. The document is issued by AGC, this document cannot be reproduced except in full with our prior written permission. The more details and the authenticity of the report will be confirmed at <http://www.agc-cert.com>.

## 11. MEASUREMENT UNCERTAINTY

Measurement uncertainty for Dipole averaged over 1 gram / 10 gram.									
a	b	c	d	e f(d,k)	f	g	h cx/e	i cxg/e	k
Uncertainty Component	Sec.	Tol (± %)	Prob. Dist.	Div.	Ci (1g)	Ci (10g)	1g Ui (±%)	10g Ui (±%)	vi
<b>Measurement System</b>									
Probe calibration	E.2.1	5.831	N	1	1	1	5.83	5.83	∞
Axial Isotropy	E.2.2	0.695	R	$\sqrt{3}$	$\sqrt{0.5}$	$\sqrt{0.5}$	0.28	0.28	∞
Hemispherical Isotropy	E.2.2	1.045	R	$\sqrt{3}$	$\sqrt{0.5}$	$\sqrt{0.5}$	0.43	0.43	∞
Boundary effect	E.2.3	1.0	R	$\sqrt{3}$	1	1	0.58	0.58	∞
Linearity	E.2.4	0.685	R	$\sqrt{3}$	1	1	0.40	0.40	∞
System detection limits	E.2.4	1.0	R	$\sqrt{3}$	1	1	0.58	0.58	∞
Modulation response	E.2.5	3.0	R	$\sqrt{3}$	1	1	1.73	1.73	∞
Readout Electronics	E.2.6	0.021	N	1	1	1	0.021	0.021	∞
Response Time	E.2.7	0	R	$\sqrt{3}$	1	1	0	0	∞
Integration Time	E.2.8	1.4	R	$\sqrt{3}$	1	1	0.81	0.81	∞
RF ambient conditions-Noise	E.6.1	3.0	R	$\sqrt{3}$	1	1	1.73	1.73	∞
RF ambient conditions-reflections	E.6.1	3.0	R	$\sqrt{3}$	1	1	1.73	1.73	∞
Probe positioner mechanical tolerance	E.6.2	1.4	R	$\sqrt{3}$	1	1	0.81	0.81	∞
Probe positioning with respect to phantom shell	E.6.3	1.4	R	$\sqrt{3}$	1	1	0.81	0.81	∞
Extrapolation, interpolation, and integrations algorithms for max. SAR evaluation	E.5	2.3	R	$\sqrt{3}$	1	1	1.33	1.33	∞
<b>Test sample Related</b>									
Test sample positioning	E.4.2	2.6	N	1	1	1	2.6	2.6	∞
Device holder uncertainty	E.4.1	3	N	1	1	1	3	3	∞
Output power variation—SAR drift measurement	E.2.9	5	R	$\sqrt{3}$	1	1	2.89	2.89	∞
SAR scaling	E.6.5	5	R	$\sqrt{3}$	1	1	2.89	2.89	∞
<b>Phantom and tissue parameters</b>									
Phantom shell uncertainty—shape, thickness, and permittivity	E.3.1	4	R	$\sqrt{3}$	1	1	2.31	2.31	∞
Uncertainty in SAR correction for deviations in permittivity and conductivity	E.3.2	1.9	N	1	1	0.84	1.90	1.60	∞
Liquid conductivity measurement	E.3.3	4	N	1	0.78	0.71	3.12	2.84	M
Liquid permittivity measurement	E.3.3	5	N	1	0.23	0.26	1.15	1.30	M
Liquid conductivity—temperature uncertainty	E.3.4	2.5	R	$\sqrt{3}$	0.78	0.71	1.13	1.02	∞
Liquid permittivity—temperature uncertainty	E.3.4	2.5	R	$\sqrt{3}$	0.23	0.26	0.33	0.38	∞
Combined Standard Uncertainty			RSS				9.79	9.59	
Expanded Uncertainty (95% Confidence interval)			K=2				19.58	19.18	

The results shown in this report refer only to the sample(s) tested unless otherwise stated and the sample(s) are retained for 30 days only. The document is issued by AGC, this document cannot be reproduced except in full with our prior written permission. The more details and the authenticity of the report will be confirmed at <http://www.agc-cert.com>.



System check uncertainty for Dipole averaged over 1 gram / 10 gram.									
a	b	c	d	e f(d,k)	f	g	h cxf/e	i cxg/e	k
Uncertainty Component	Sec.	Tol (±%)	Prob. Dist.	Div.	Ci (1g)	Ci (10g)	1g Ui (±%)	10g Ui (±%)	vi
<b>Measurement System</b>									
Probe calibration drift	E.2.1.3	0.5	N	1	1	1	0.50	0.50	∞
Axial Isotropy	E.2.2	0.695	R	$\sqrt{3}$	0	0	0.00	0.00	∞
Hemispherical Isotropy	E.2.2	1.045	R	$\sqrt{3}$	0	0	0.00	0.00	∞
Boundary effect	E.2.3	1.0	R	$\sqrt{3}$	0	0	0.00	0.00	∞
Linearity	E.2.4	0.685	R	$\sqrt{3}$	0	0	0.00	0.00	∞
System detection limits	E.2.4	1.0	R	$\sqrt{3}$	0	0	0.00	0.00	∞
Modulation response	E.2.5	3.0	R	$\sqrt{3}$	0	0	0.00	0.00	∞
Readout Electronics	E.2.6	0.021	N	1	0	0	0.00	0.00	∞
Response Time	E.2.7	0	R	$\sqrt{3}$	0	0	0.00	0.00	∞
Integration Time	E.2.8	1.4	R	$\sqrt{3}$	0	0	0.00	0.00	∞
RF ambient conditions-Noise	E.6.1	3.0	R	$\sqrt{3}$	0	0	0.00	0.00	∞
RF ambient conditions-reflections	E.6.1	3.0	R	$\sqrt{3}$	0	0	0.00	0.00	∞
Probe positioner mechanical tolerance	E.6.2	1.4	R	$\sqrt{3}$	1	1	0.81	0.81	∞
Probe positioning with respect to phantom shell	E.6.3	1.4	R	$\sqrt{3}$	1	1	0.81	0.81	∞
Extrapolation, interpolation, and integrations algorithms for max. SAR evaluation	E.5	2.3	R	$\sqrt{3}$	0	0	0.00	0.00	∞
<b>System check source (dipole)</b>									
Deviation of experimental dipoles	E.6.4	2	N	1	1	1	2	2	∞
Input power and SAR drift measurement	8,6.6.4	5	R	$\sqrt{3}$	1	1	2.89	2.89	∞
Dipole axis to liquid distance	8,E.6.6	2	R	$\sqrt{3}$	1	1	1.15	1.15	∞
<b>Phantom and tissue parameters</b>									
Phantom shell uncertainty—shape, thickness, and permittivity	E.3.1	4	R	$\sqrt{3}$	1	1	2.31	2.31	∞
Uncertainty in SAR correction for deviations in permittivity and conductivity	E.3.2	1.9	N	1	1	0.84	1.90	1.60	∞
Liquid conductivity measurement	E.3.3	4	N	1	0.78	0.71	3.12	2.84	M
Liquid permittivity measurement	E.3.3	5	N	1	0.23	0.26	1.15	1.30	M
Liquid conductivity—temperature uncertainty	E.3.4	2.5	R	$\sqrt{3}$	0.78	0.71	1.13	1.02	∞
Liquid permittivity—temperature uncertainty	E.3.4	2.5	R	$\sqrt{3}$	0.23	0.26	0.33	0.38	∞
Combined Standard Uncertainty				RSS			5.564	5.205	
Expanded Uncertainty (95% Confidence interval)				K=2			11.128	10.410	

The results shown in this test report refer only to the sample(s) tested unless otherwise stated and the sample(s) are retained for 30 days only. The document is issued by AGC, this document cannot be reproduced except in full with our prior written permission. The more details and the authenticity of the report will be confirmed at <http://www.agc-cert.com>.

System Validation uncertainty for Dipole averaged over 1 gram / 10 gram.									
a	b	c	d	e f(d,k)	f	g	h cxf/e	i cxg/e	k
Uncertainty Component	Sec.	Tol (±%)	Prob. Dist.	Div.	Ci (1g)	Ci (10g)	1g Ui (±%)	10g Ui (±%)	vi
<b>Measurement System</b>									
Probe calibration	E.2.1	5.831	N	1	1	1	5.83	5.83	∞
Axial Isotropy	E.2.2	0.695	R	$\sqrt{3}$	1	1	0.40	0.40	∞
Hemispherical Isotropy	E.2.2	1.045	R	$\sqrt{3}$	0	0	0.00	0.00	∞
Boundary effect	E.2.3	1.0	R	$\sqrt{3}$	1	1	0.58	0.58	∞
Linearity	E.2.4	0.685	R	$\sqrt{3}$	1	1	0.40	0.40	∞
System detection limits	E.2.4	1.0	R	$\sqrt{3}$	1	1	0.58	0.58	∞
Modulation response	E.2.5	3.0	R	$\sqrt{3}$	0	0	0.00	0.00	∞
Readout Electronics	E.2.6	0.021	N	1	1	1	0.021	0.021	∞
Response Time	E.2.7	0.0	R	$\sqrt{3}$	0	0	0.00	0.00	∞
Integration Time	E.2.8	1.4	R	$\sqrt{3}$	0	0	0.00	0.00	∞
RF ambient conditions-Noise	E.6.1	3.0	R	$\sqrt{3}$	1	1	1.73	1.73	∞
RF ambient conditions-reflections	E.6.1	3.0	R	$\sqrt{3}$	1	1	1.73	1.73	∞
Probe positioner mechanical tolerance	E.6.2	1.4	R	$\sqrt{3}$	1	1	0.81	0.81	∞
Probe positioning with respect to phantom shell	E.6.3	1.4	R	$\sqrt{3}$	1	1	0.81	0.81	∞
Extrapolation, interpolation, and integrations algorithms for max. SAR evaluation	E.5	2.3	R	$\sqrt{3}$	1	1	1.33	1.33	∞
<b>System check source (dipole)</b>									
Deviation of experimental dipole from numerical dipole	E.6.4	5.0	N	1	1	1	5.00	5.00	∞
Input power and SAR drift measurement	8,6.6.4	5.0	R	$\sqrt{3}$	1	1	2.89	2.89	∞
Dipole axis to liquid distance	8,E.6.6	2.0	R	$\sqrt{3}$	1	1	1.15	1.15	∞
<b>Phantom and tissue parameters</b>									
Phantom shell uncertainty—shape, thickness, and permittivity	E.3.1	4.0	R	$\sqrt{3}$	1	1	2.31	2.31	∞
Uncertainty in SAR correction for deviations in permittivity and conductivity	E.3.2	1.9	N	1	1	0.84	1.90	1.60	∞
Liquid conductivity measurement	E.3.3	4.0	N	1	0.78	0.71	3.12	2.84	M
Liquid permittivity measurement	E.3.3	5.0	N	1	0.23	0.26	1.15	1.30	M
Liquid conductivity—temperature uncertainty	E.3.4	2.5	R	$\sqrt{3}$	0.78	0.71	1.13	1.02	∞
Liquid permittivity—temperature uncertainty	E.3.4	2.5	R	$\sqrt{3}$	0.23	0.26	0.33	0.38	∞
Combined Standard Uncertainty				RSS			9.718	9.517	
Expanded Uncertainty (95% Confidence interval)				K=2			19.437	19.035	

The results shown in this test report refer only to the sample(s) tested unless otherwise stated and the sample(s) are retained for 30 days only. The document is issued by AGC, this document cannot be reproduced except in full with our prior written permission. The more details and the authenticity of the report will be confirmed at <http://www.agc-cert.com>.



## 12. CONDUCTED POWER MEASUREMENT

### Bluetooth\_V5.0(BR/EDR)

Modulation	Channel	Frequency(MHz)	Peak Output Power (dBm)
GFSK	0	2402	3.27
	39	2441	5.49
	78	2480	<b>5.62</b>
π/4-DQPSK	0	2402	3.89
	39	2441	4.94
	78	2480	5.08
8-DPSK	0	2402	3.89
	39	2441	4.93
	78	2480	5.09

### Bluetooth\_V5.0(BLE)

Modulation	Channel	Frequency(MHz)	Peak Output Power (dBm)
GFSK	0	2402	4.47
	19	2440	5.40
	39	2480	<b>5.73</b>

The results shown in this test report refer only to the sample(s) tested unless otherwise stated and the sample(s) are retained for 30 days only. The document is issued by AGC, this document cannot be reproduced except in full with our prior written permission. The more details and the authenticity of the report will be confirmed at <http://www.agc-cert.com>.

## 13. TEST RESULTS

### 13.1. SAR Test Results Summary

#### 13.1.1. Test position and configuration

1. The EUT is a model of Bluetooth headset.
2. According to FCC PAG, Lab use the head liquid with a separation of 0mm at flat phantom to test;
3. For SAR testing, the device was controlled by software to test at reference fixed frequency points.

#### 13.1.2. Operation Mode

1. Per KDB 447498 D01 v06 ,for each exposure position, if the highest 1-g SAR is  $\leq 0.8$  W/kg, testing for low and high channel is optional.
2. Per KDB 865664 D01 v01r04,for each frequency band, if the measured SAR is  $\geq 0.8$ W/Kg, testing for repeated SAR measurement is required , that the highest measured SAR is only to be tested. When the SAR results are near the limit, the following procedures are required for each device to verify these types of SAR measurement related variation concerns by repeating the highest measured SAR configuration in each frequency band.
  - (1) When the original highest measured SAR is  $\geq 0.8$ W/Kg, repeat that measurement once.
  - (2) Perform a second repeated measurement only if the ratio of largest to smallest SAR for the original and first repeated measurements is  $>1.20$  or when the original or repeated measurement is  $\geq 1.45$  W/Kg.
  - (3) Perform a third repeated measurement only if the original, first and second repeated measurement is  $\geq 1.5$  W/Kg and ratio of largest to smallest SAR for the original, first and second measurement is  $\geq 1.20$ .
3. Maximum Scaling SAR in order to calculate the Maximum SAR values to test under the standard Peak Power, Calculation method is as follows:  
Maximum Scaling SAR =tested SAR (Max.)  $\times$  [maximum turn-up power (mw)/ maximum measurement output power(mw) ]

The results shown in this test report refer only to the sample(s) tested unless otherwise stated and the sample(s) are retained for 30 days only. The document is issued by AGC, this document cannot be reproduced except in full with our prior written permission. The more details and the authenticity of the report will be confirmed at <http://www.agc-cert.com>.



**13.1.3. Test Result**

SAR MEASUREMENT									
Depth of Liquid (cm):>15					Relative Humidity (%): 49.7				
Product: Bluetooth Headset									
Test Mode: BR/EDR									
Position	Mode	Ch.	Fr. (MHz)	Power Drift (<math>\leq \pm 5\%</math>)	SAR (1g) (W/kg)	Max. Tune-up Power (dBm)	Meas. output Power (dBm)	Scaled SAR (W/Kg)	Limit W/kg
Head SAR Front	1DH5	78	2480	0.15	<b>0.150</b>	6.0	5.62	0.164	1.6
Head SAR Front	2DH5	78	2480	-0.13	0.146	6.0	5.08	<b>0.180</b>	1.6
Head SAR Front	3DH5	78	2480	0.02	0.139	6.0	5.09	0.171	1.6
Head SAR Back	1DH5	78	2480	-0.18	0.027	6.0	5.62	0.029	1.6

Note:

- (1) When the 1-g Reported SAR is  $\leq 0.8$  W/kg, testing for low and high channel is optional. Refer to KDB 447498.
- (2) The test separation of all above table is 0mm.

SAR MEASUREMENT									
Depth of Liquid (cm):>15					Relative Humidity (%): 49.7				
Product: Bluetooth Headset									
Test Mode: BLE									
Position	Mode	Ch.	Fr. (MHz)	Power Drift (<math>\leq \pm 5\%</math>)	SAR (1g) (W/kg)	Max. Tune-up Power (dBm)	Meas. output Power (dBm)	Scaled SAR (W/Kg)	Limit W/kg
Head SAR Front	GFSK	39	2480	-0.01	0.028	6.0	5.73	<b>0.030</b>	1.6
Head SAR Back	GFSK	39	2480	0.03	0.005	6.0	5.73	0.005	1.6

Note:

- (1) When the 1-g Reported SAR is  $\leq 0.8$  W/kg, testing for low and high channel is optional. Refer to KDB 447498.
- (2) The test separation of all above table is 0mm.

The results shown in this test report refer only to the sample(s) tested unless otherwise stated and the sample(s) are retained for 30 days only. The document is issued by AGC, this document cannot be reproduced except in full with our prior written permission. The more details and the authenticity of the report will be confirmed at <http://www.agc-cert.com>.

**APPENDIX A. SAR SYSTEM CHECK DATA**

Test Laboratory: AGC Lab

Date: July 30,2018

System Check Head 2450 MHz

DUT: Dipole 2450 MHz Type: SID 2450

Communication System CW; Communication System Band: D2450 (2450.0 MHz); Duty Cycle: 1:1; Conv.F=2.52

Frequency: 2450 MHz; Medium parameters used:  $f = 2450$  MHz;  $\sigma = 1.83$  mho/m;  $\epsilon_r = 39.14$ ;  $\rho = 1000$  kg/m<sup>3</sup> ;

Phantom section: Flat Section; Input Power=18dBm

Ambient temperature (°C):22.2, Liquid temperature (°C): 21.7

SATIMO Configuration

Probe: SSE2; Calibrated: Aug. 08,2017; Serial No.: SN 08/16 EPGO282

Sensor-Surface: 4mm (Mechanical Surface Detection)

Phantom: SAM twin phantom

Measurement SW: OpenSAR V4\_02\_32

Configuration/System Check 2450MHz Head/Area Scan: Measurement grid: dx=8mm, dy=8mm

Configuration/System Check 2450MHz Head/Zoom Scan: Measurement grid: dx=5mm,dy=5mm, dz=5mm

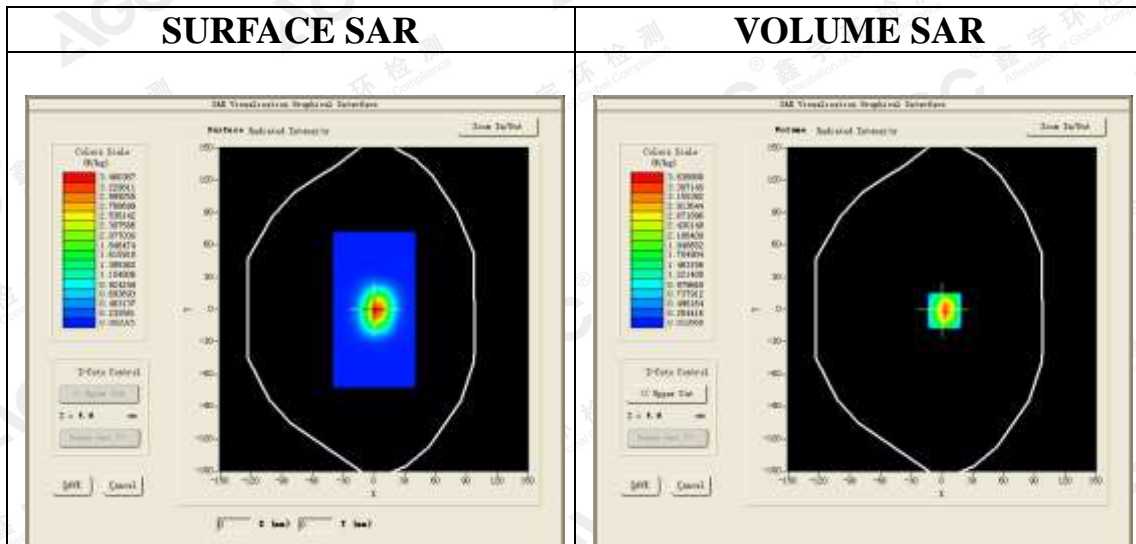

Maximum location: X=1.00, Y=-1.00

SAR Peak: 6.48 W/kg

SAR 10g (W/Kg)	1.470125
SAR 1g (W/Kg)	3.401243

The results shown in this test report refer only to the sample(s) tested unless otherwise stated and the sample(s) are retained for 30 days only. The document is issued by AGC, this document cannot be reproduced except in full with our prior written permission. The more details and the authenticity of the report will be confirmed at <http://www.agc-cert.com>.



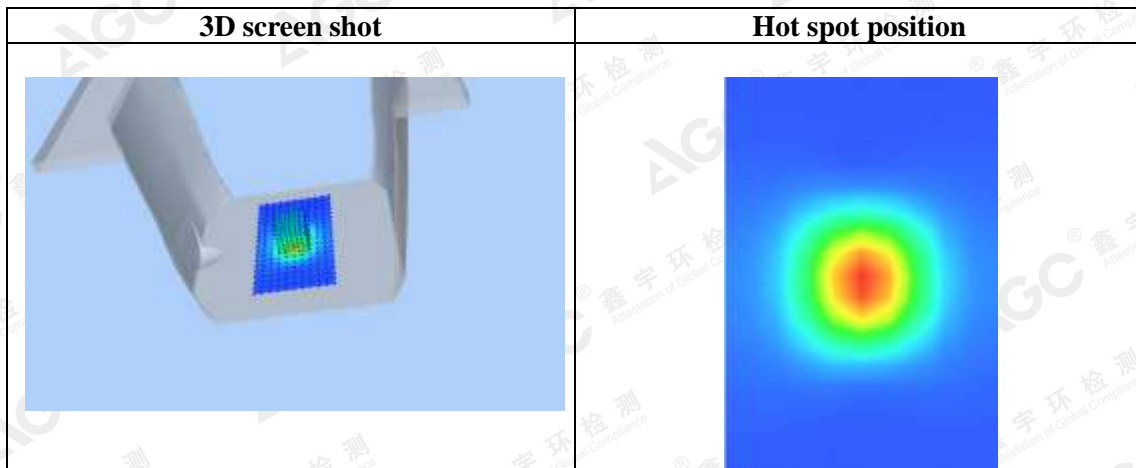
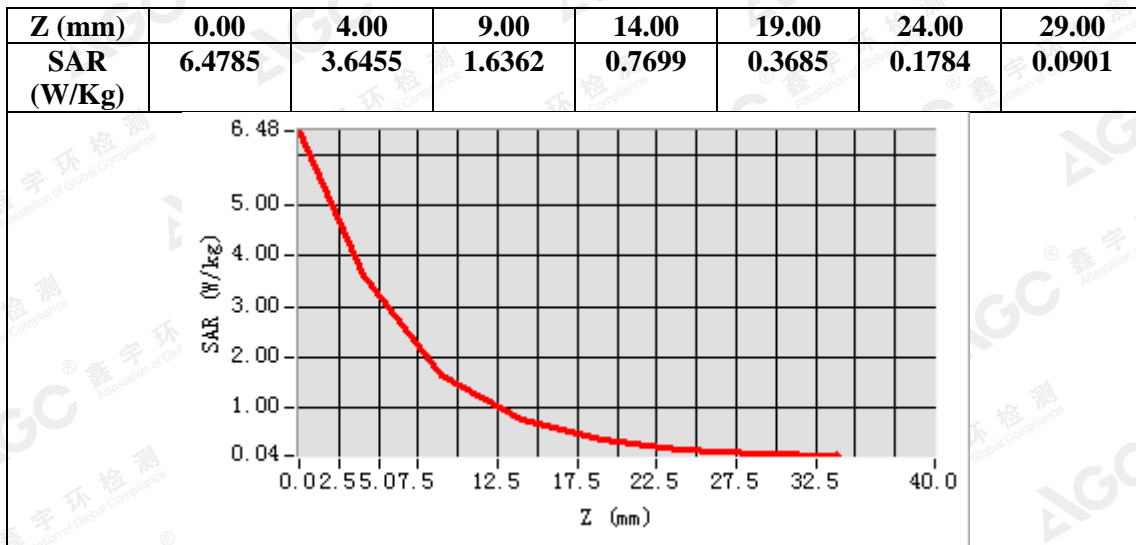

The results shown in this test report refer only to the sample(s) tested unless otherwise stated and the sample(s) are retained for 30 days only. The document is issued by AGC, this document cannot be reproduced except in full with our prior written permission. The more details and the authenticity of the report will be confirmed at <http://www.agc-cert.com>.

**APPENDIX B. SAR MEASUREMENT DATA**

Test Laboratory: AGC Lab  
BT(BR/EDR) High-Head SAR-Front (1DH5)  
DUT: Bluetooth Headset; Type: BG410S

Date: July 30,2018

Communication System: BT(BR/EDR); Communication System Band: Bluetooth; Duty Cycle: 1:1.28; Conv.F=2.52;  
Frequency: 2480 MHz; Medium parameters used:  $f = 2450$  MHz;  $\sigma = 1.85$  mho/m;  $\epsilon_r = 38.72$ ;  $\rho = 1000$  kg/m<sup>3</sup> ;  
Phantom section: Flat Section  
Ambient temperature (°C):22.2, Liquid temperature (°C): 21.7

SATIMO Configuration:

Probe: SSE2; Calibrated: Aug. 08,2017; Serial No.: SN 08/16 EPGO282  
Sensor-Surface: 4mm (Mechanical Surface Detection)  
Phantom: SAM twin phantom  
Measurement SW: OpenSAR V4\_02\_32

Configuration/Bluetooth High- Head SAR - Front /Area Scan: Measurement grid: dx=8mm, dy=8mm  
Configuration/Bluetooth High- Head SAR - Front /Zoom Scan: Measurement grid: dx=5mm,dy=5mm, dz=5mm;

Area Scan	surf_sam_plan.txt, h= 5.00 mm
ZoomScan	7x7x7,dx=5mm dy=5mm dz=5mm
Phantom	Validation plane
Device Position	Head SAR-Front
Band	Bluetooth
Channels	High
Signal	Crest factor: 1.28

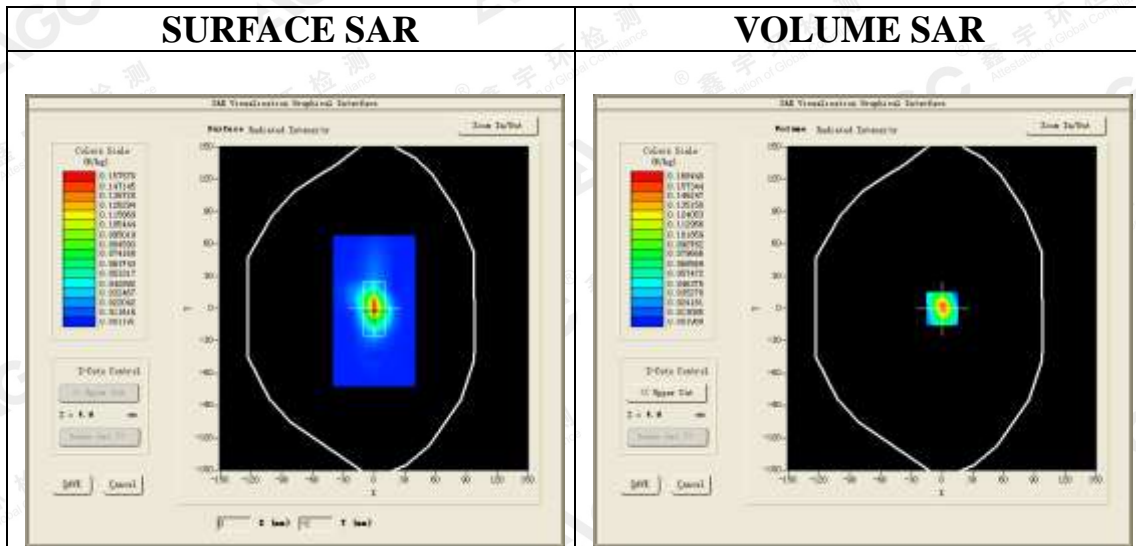

Maximum location: X=0.00, Y=0.00  
SAR Peak: 0.32 W/kg

SAR 10g (W/Kg)	0.056735
SAR 1g (W/Kg)	0.150074

The results shown in this test report refer only to the sample(s) tested unless otherwise stated and the sample(s) are retained for 30 days only. The document is issued by AGC, this document cannot be reproduced except in full with our prior written permission. The more details and the authenticity of the report will be confirmed at <http://www.agc-cert.com>.



Z (mm)	0.00	4.00	9.00	14.00	19.00	24.00	29.00
SAR (W/Kg)	0.3163	0.1684	0.0681	0.0296	0.0136	0.0069	0.0042

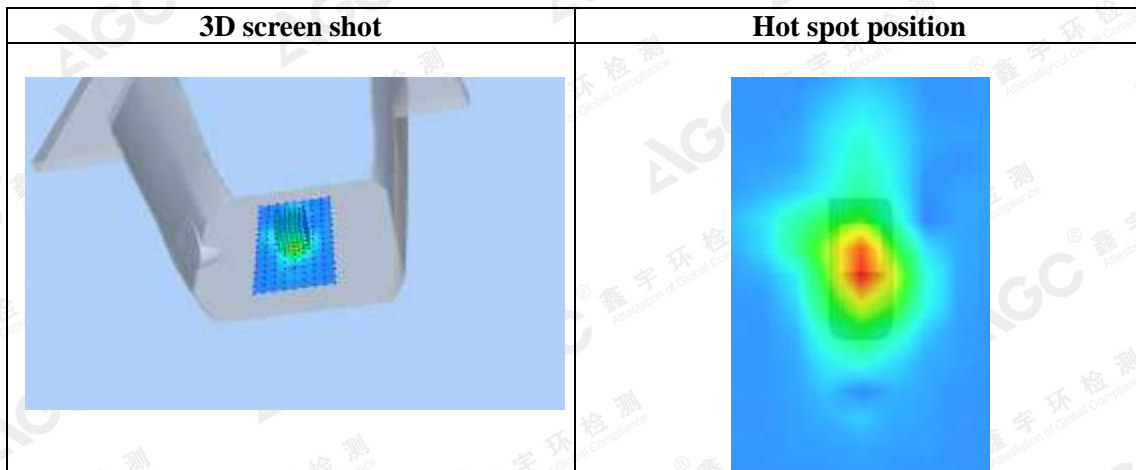
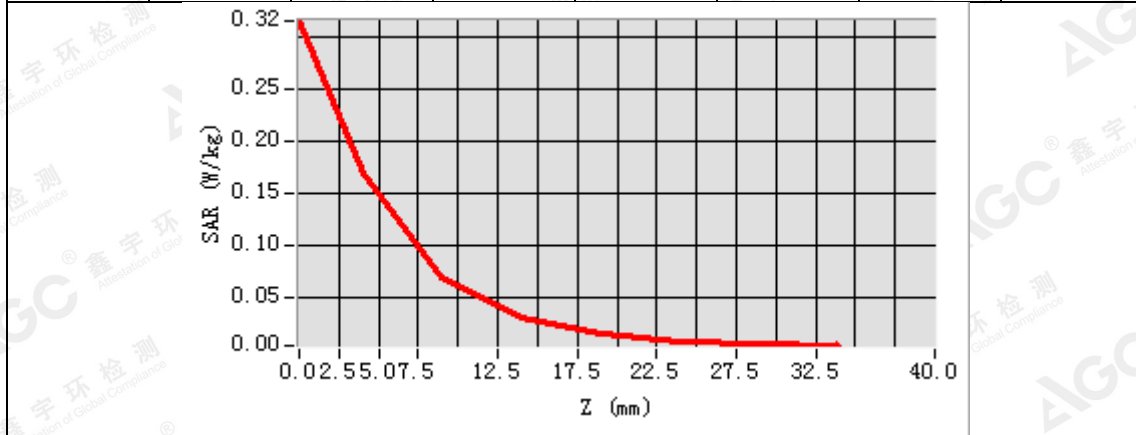

The results shown in this test report refer only to the sample(s) tested unless otherwise stated and the sample(s) are retained for 30 days only. The document is issued by AGC, this document cannot be reproduced except in full with our prior written permission. The more details and the authenticity of the report will be confirmed at <http://www.agc-cert.com>.

**Test Laboratory: AGC Lab**  
**BT(BLE) High-Head SAR-Front (GFSK)**  
**DUT: Bluetooth Headset; Type: BG410S**

**Date: July 30,2018**

Communication System: BT(BLE); Communication System Band: Bluetooth; Duty Cycle: 1:1.28; Conv.F=2.52;  
Frequency: 2480 MHz; Medium parameters used:  $f = 2450$  MHz;  $\sigma = 1.85$  mho/m;  $\epsilon_r = 38.72$ ;  $\rho = 1000$  kg/m<sup>3</sup> ;  
Phantom section: Flat Section  
Ambient temperature (°C):22.2, Liquid temperature (°C): 21.7

**SATIMO Configuration:**

Probe: SSE2; Calibrated: Aug. 08,2017; Serial No.: SN 08/16 EPGO282  
Sensor-Surface: 4mm (Mechanical Surface Detection)  
Phantom: SAM twin phantom  
Measurement SW: OpenSAR V4\_02\_32

**Configuration/Bluetooth High- Head SAR - Front /Area Scan:** Measurement grid: dx=8mm, dy=8mm  
**Configuration/Bluetooth High- Head SAR - Front /Zoom Scan:** Measurement grid: dx=5mm,dy=5mm, dz=5mm;

<b>Area Scan</b>	surf_sam_plan.txt, h= 5.00 mm
<b>ZoomScan</b>	7x7x7,dx=5mm dy=5mm dz=5mm
<b>Phantom</b>	Validation plane
<b>Device Position</b>	Head SAR-Front
<b>Band</b>	2.4MHz
<b>Channels</b>	High
<b>Signal</b>	Crest factor: 1.28

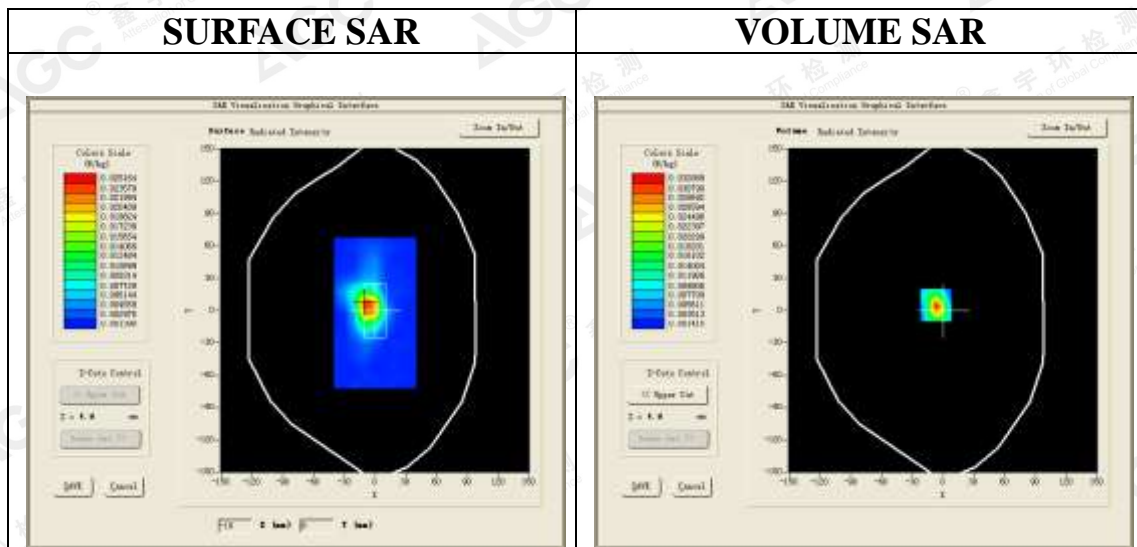

**Maximum location: X=-7.00, Y=5.00**  
**SAR Peak: 0.06 W/kg**

<b>SAR 10g (W/Kg)</b>	0.011449
<b>SAR 1g (W/Kg)</b>	0.028217

The results shown in this test report refer only to the sample(s) tested unless otherwise stated and the sample(s) are retained for 30 days only. The document is issued by AGC, this document cannot be reproduced except in full with our prior written permission. The more details and the authenticity of the report will be confirmed at <http://www.agc-cert.com>.



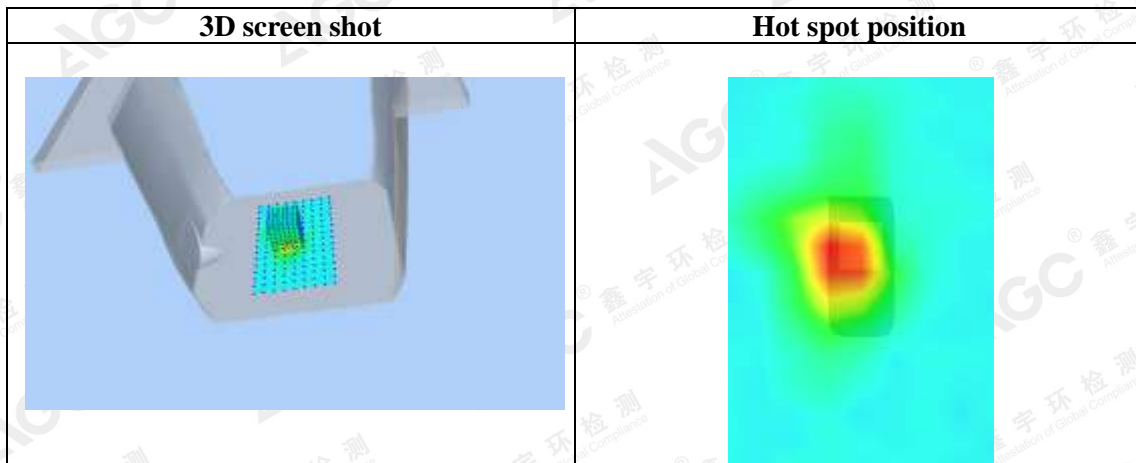
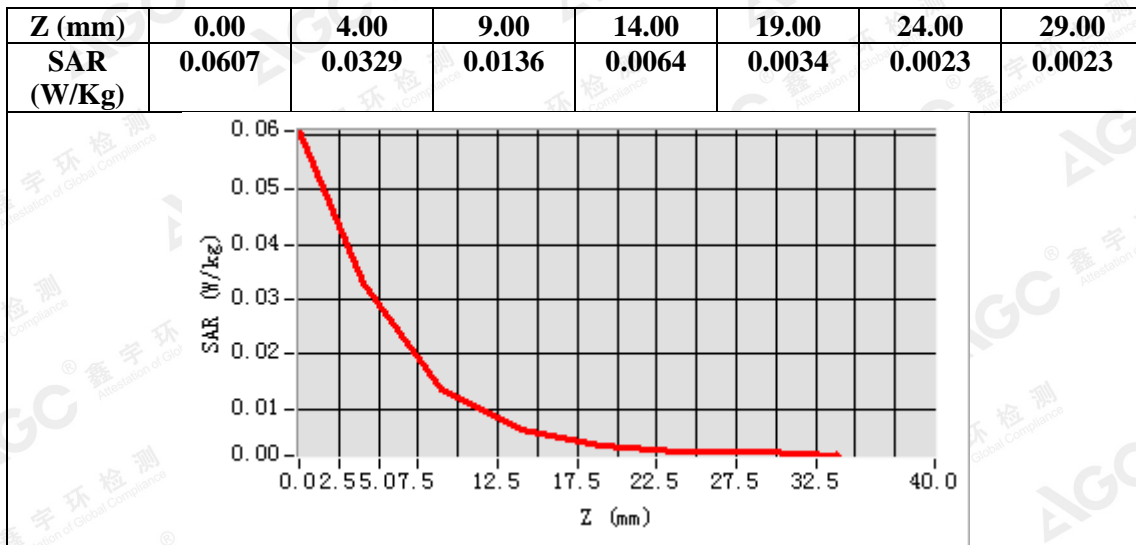

The results shown in this test report refer only to the sample(s) tested unless otherwise stated and the sample(s) are retained for 30 days only. The document is issued by AGC, this document cannot be reproduced except in full with our prior written permission. The more details and the authenticity of the report will be confirmed at <http://www.agc-cert.com>.

## APPENDIX C. TEST SETUP PHOTOGRAPHS

Refer to Attached files.

The results shown in this test report refer only to the sample(s) tested unless otherwise stated and the sample(s) are retained for 30 days only. The document is issued by AGC, this document cannot be reproduced except in full with our prior written permission. The more details and the authenticity of the report will be confirmed at <http://www.agc-cert.com>.



## APPENDIX D. CALIBRATION DATA

Refer to Attached files.

The results shown in this test report refer only to the sample(s) tested unless otherwise stated and the sample(s) are retained for 30 days only. The document is issued by AGC, this document cannot be reproduced except in full with our prior written permission. The more details and the authenticity of the report will be confirmed at <http://www.agc-cert.com>.