



Altec Lansing BackBeat™ 903/906
Getting Started

Package Contents and Features

⚠ Please refer to the separate For Your Safety guide for important product safety information prior to use of the product.

For a detailed User Guide, including troubleshooting tips, please visit www.alteclansing.com/backbeat9xx.

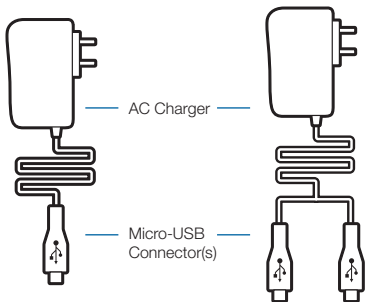

[BackBeat 903]

[BackBeat 906]

Left Earpiece—Phone Controls

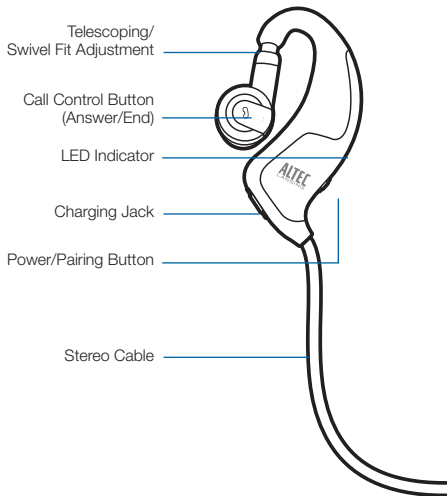

Package Contents and Features

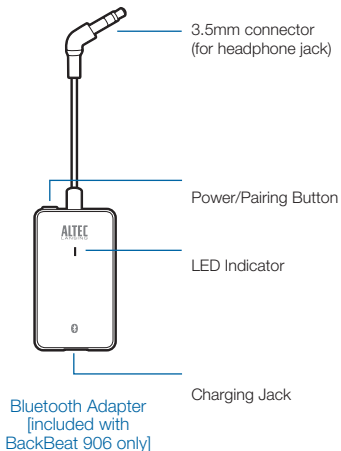
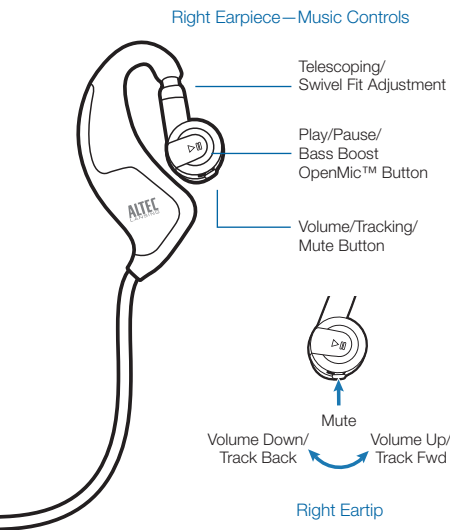

Charging Your Headphones or Bluetooth Adapter

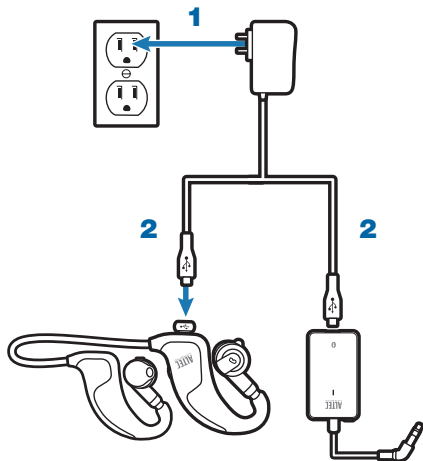

[BackBeat 906 shown]

- 1** Plug the AC charger into a power outlet.
- 2** Connect the charger cable to the headphones or Bluetooth adapter.
- 3** Charge each for at least 1 hour before first time use, or 3 hours to fully charge.
The LED indicator glows red while charging.

⚠WARNING Do not use your headphones or Bluetooth adapter while they are connected to the charger.

CHARGING TIME

3 hours
Full charge



1 hour
Minimum charge
before first use



Pairing Your Headphones and Phone/Device

1 Turn on your phone's or device's Bluetooth® feature.

2 With the headphones off, press and hold the Power/Pairing button until the LED indicator flashes blue and red.

3 Use the phone or device menu to search for the Bluetooth headphones and select **9xxBackBeat**.

See your phone's or device's user guide for more information.

4 If prompted, enter **0000** for the PIN code/passkey.

Pairing is successful when the LED indicator flashes blue.

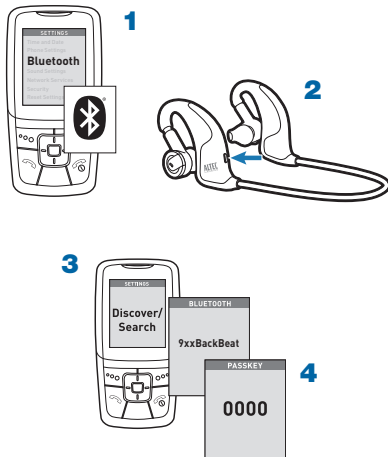

Pairing Your Headphones and Bluetooth Adapter [BackBeat 906 only]

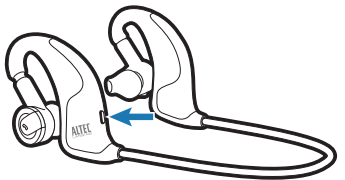

1

1 With the headphones off, press and hold the Power/Pairing button until the LED Indicator flashes blue and red.

2 With the adapter off, press and hold the Power/Pairing button until the LED Indicator flashes blue and red.

3 The headphones and adapter will both rapidly flash blue when paired successfully. Both are now ready for use.

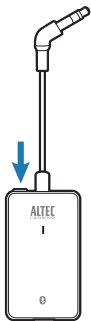

2

Adjusting the Fit

For optimal sound performance and a secure, comfortable fit, the headphones should be adjusted to rest gently in your ear and around the back of your neck.

- 1** Drape the stereo cable behind your neck.
- 2** Guide one earpiece behind your ear and secure the eartip inside your ear using the telescoping/swivel adjustments.
- 3** Repeat step 2 with the other earpiece and continue to adjust the fit in either ear until both eartips rest comfortably and securely in your ears.

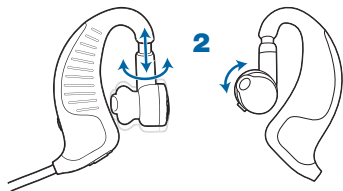
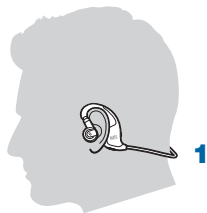

Headphones Phone Controls and Indicators

	Action	Indicator Light	Tone
Turn on the headphones	Press and hold the power/pairing button for 2 seconds.	Glows blue for 2 seconds, then turns off.	Four rising tones
Turn off the headphones	Press and hold the power/pairing button for 4 seconds.	Glows red for 4 seconds, then turns off.	Four falling tones
Answer/end a call	Tap the call control button.	Three blue flashes (repeating) while phone is ringing. Blue flash every 2 seconds while on a call.	Three low tones (repeating) while phone is ringing. Single low tone when call connects or when disconnects.
Make a call	Enter the number on your phone and press send.	Blue flash every 2 seconds while call is in progress.	Brief tones, then ringing
Reject a call	Press and hold the call control button for 2 seconds.	None	Single long low tone
Check battery power	With headphones powered on, tap the power/pairing button. The indicator flashes red to show the charge level.	Red flashes: 1 2 3	Battery level: None More than 2/3 full 1/3 - 2/3 full Less than 1/3 full

Headphones Phone Controls and Indicators

	Action	Indicator Light	Tone
Mute/unmute the call (call in progress)	Press in the volume/tracking/mute button.	None	Low and high tone to mute, then a single low tone every minute. High and low tone to unmute.
Adjust the call volume (call in progress)	Tap the volume/tracking/mute button forward (+) or backward (-).	None	Brief low tone (2 low tones when volume limit is reached)

⚠WARNING Do not use headphones at high volumes for an extended period of time. Doing so can cause hearing loss. Always listen at moderate levels. See www.alteclansing.com/headphonesafety for more information on headphones and hearing.

Headphones Music Controls and Indicators

	Action	Indicator Light	Tone
Play music	Tap the play/pause button.	None	None
Pause-to-hear	Tap the play/pause button when music is playing.	None	None
Move forward or back one track	Press and hold the volume/tracking/mute button forward or backwards for each track.	None	Single low tone for each track change
Answer a call while listening to music	Tap the call control button. Music will pause during call.	Three blue flashes (repeating) while phone is ringing. Blue flash every 2 seconds while on a call.	Three low tones (repeating) while phone is ringing. Single low tone when call connects or when disconnects.

Headphones Music Controls and Indicators

	Action	Indicator Light	Tone
Reject a call while listening to music	Press and hold the call control button for 2 seconds.	None	Single long low tone
Adjust the volume of music	Tap the volume/tracking/mute button forward or backward.	None	Brief low tone (2 low tones when volume limit is reached)

NOTE To wirelessly stream stereo music or audio from a device to your headphones, your Bluetooth device must support the Bluetooth Advanced Audio Distribution Profile (A2DP) profile. If your Bluetooth device also supports the Audio/Video Remote Control Profile (AVRCP), you can use your headphones to control music playback. If your device does not support the AVRCP profile, then you must use the controls on your device to control music playback.

WARRANTY BY PLANTRONICS AND ALTEC LANSING

Plantronics and Altec Lansing offer a one (1) year warranty to all Plantronics and Altec Lansing co-branded products (hereinafter "Products").

Limited Warranty. Plantronics/Altec Lansing warrants that the Products are free from defects in materials and workmanship, with its obligations under this warranty being limited (save in the case of sole gross negligence causing death or personal injury) to repair or replacement at its own expense provided a claim is made within the warranty period applicable to the Product.

Post replacement. Plantronics/Altec Lansing will provide replaced products with a minimum 6-month warranty or the remainder of the original product's warranty (12 months minus the time passed between the purchase date and the date the product failed), whichever is greater.

WHAT DOES THIS WARRANTY NOT COVER? DAMAGE CAUSED BY, OR PERFORMANCE PROBLEMS RESULTING FROM, USING THIS PRODUCT WITH A NON-PLANTRONICS/ NON-ALTEC LANSING AMPLIFIER, ADAPTER, SWITCHER AND/OR CONNECTOR CABLE, ACCIDENT, ABUSE, MISUSE, OR AN ACT OF GOD (SUCH AS A FLOOD) ARE NOT COVERED. IMPLIED WARRANTIES, INCLUDING THOSE OF MERCHANTABILITY, FITNESS FOR A PARTICULAR PURPOSE AND NON-INFRINGEMENT SHALL (A) HAVE NO DURATION GREATER THAN 1 YEAR FROM THE DATE OF PURCHASE, (B) TERMINATE AUTOMATICALLY AT THE END OF THAT PERIOD, AND (C) TO THE EXTENT PERMITTED BY LAW, BE EXCLUDED. CONSEQUENTIAL AND INCIDENTAL DAMAGES, INCLUDING WITHOUT LIMITATION, LOSS OF PROPERTY AND THOSE ARISING FROM BREACH OF ANY EXPRESS OR IMPLIED WARRANTY, ARE NOT THE RESPONSIBILITY OF PLANTRONICS, AND TO THE EXTENT PERMITTED BY LAW, ARE EXCLUDED.

This warranty also does not cover Products that are modified or repaired by someone not authorised by Plantronics or without Plantronics' / Altec Lansing' approval or that are subjected by the customer to misuse or unusual physical or electrical stress.

Products that have: (a) serial numbers or date tags that have been removed, altered or obliterated; (b) board serial numbers that do not match each other, or board serial numbers that do not match the housing; or (c) nonconforming or non-Plantronics/ non-Altec Lansing housings or parts. Any of these voids the warranty. Consumable spares and accessories (unless they are found to be non-functional or broken upon purchase of product), such as:

1. Cases and case parts
2. Modular Plugs

3. Cradles
4. Headbands
5. Lanyards
6. Pouches
7. Voice Tubes
8. Decorative Finishes
9. Switches
10. Eartips, Eartip Kits, Ear Cushions, Ear Loops and Ear Budeez™
11. Chargers
12. Ipod adapters
13. 3.5/2.5 converters
14. Remote controls
15. Cables

No Other Warranties. Except as set forth above, and in the printed warranty which accompanies the Products, Plantronics/ Altec Lansing grant no other warranties, express or implied, by statute or otherwise, regarding the Products, their fitness for any purpose, their quality, their marketability or otherwise.

Warranty by Distributor. The Distributor shall pass on to its customers a similar warranty to Plantronics'/ Altec Lansing' standard limited warranty for the Products, as set forth above, including all limitations set forth therein, and taking into account any national mandatory law. The Distributor shall in writing advise Plantronics/ Altec Lansing of any national mandatory law that will affect the warranty provided under the terms of this agreement to the customer.

Distributor Responsible for Warranty to Its Customers. The Distributor shall take all appropriate actions and do whatsoever is necessary to notify and inform its customers that the Distributor and not Plantronics/ Altec Lansing is solely responsible for performing all warranty obligations in accordance with this Section.

Support of Warranty. The Distributor shall assume and diligently perform all warranty obligations with respect to the Products in accordance with the terms of Plantronics'/ Altec Lansing' standard limited warranty for the Products as set forth in the

printed warranty terms accompanying the Products and set forth in this section and shall indemnify, hold harmless and defend Plantronics/ Altec Lansing from and against all actions, claims, demands, deeds, costs, attorneys' fees and damage made or brought against Plantronics/ Altec Lansing by any customer of the Distributor for breach of warranty.

Plantronics Not Responsible for Distributor's Warranty. For the avoidance of doubt Plantronics/ Altec Lansing shall have no liability whatsoever to the Distributor's customers whose sole remedy shall be as provided by the Distributor under this section. In no event shall Plantronics be liable for the cost of procurement of substitute goods by the Distributor or its customer, or for any special consequential or incidental damages for breach of warranty or any other course.

Limitation of Liability. Plantronics'/ Altec Lansing liability under the terms of the above warranty is limited to replacement of product units found to be defective in materials or workmanship. Plantronics/ Altec Lansing shall have no liability other than as provided under warranty to distributor, whose sole remedy shall be as provided by Plantronics/ Altec Lansing under this section. In no event shall Plantronics/ Altec Lansing be liable for the cost of procurement of substitute goods by distributor or for any special, consequential, reliance or incidental damages, however caused, or under any theory of liability, even if Plantronics/ Altec Lansing has been advised of the possibility of such damages. These limitations will apply notwithstanding the failure of essential purpose of any limited remedy.

How To Get Warranty Service: To get this covered product repaired or replaced, you must contact Altec Lansing during the warranty period by email (csupport@alteclansing.com). You must include in your email, your name, address, email address, telephone number, date of purchase and a complete description of the problem you are experiencing. In the United States, you may alternatively contact Altec Lansing by telephone at 1-800-ALTEC88 – please be prepared to provide the same information. If the problem appears to be related to a defect in material or workmanship, Altec Lansing will provide you a return authorization and instructions for return shipment. Return shipments shall be at the customer's expense, and the return must be accompanied by the original proof of purchase. You should insure the shipment as appropriate because you are responsible for the product until it arrives at Altec Lansing.



www.alteclansing.com

HEADQUARTERS 535 Rte. 6 & 209, Milford, PA 18337-0277 • 800-ALTEC-88. 570-296-4434. • Fax 570-296-6887

Patents pending.

©2008 Plantronics, Inc. All rights reserved. ALTEC, ALTEC LANSING, the Altec Lansing logo, BackBeat and OpenMic are trademarks or registered trademarks of Altec Lansing, a division of Plantronics, Inc. Plantronics, the logo design, QuickPair, and Sound Innovation are trademarks or registered trademarks of Plantronics, Inc. The Bluetooth® word mark and logos are owned by the Bluetooth SIG, Inc. and any use of such marks by Plantronics, Inc. is under license. All other trademarks appearing herein are the property of their respective owners.

80628-01 (10/08)



N10687

Z109

