



FCC TEST REPORT

REPORT NO.: RF971208A02

MODEL NO.: BackBeat 903

RECEIVED: Oct. 27, 2008

TESTED: Oct. 27 ~ Dec. 10, 2008

ISSUED: Dec. 15, 2008

APPLICANT: Plantronics, Inc.

ADDRESS: 345 Encinal Street, Santa Cruz, CA, 95060, USA

ISSUED BY: Bureau Veritas Consumer Products Services (H.K.)
Ltd., Taoyuan Branch

LAB LOCATION: No. 47, 14th Ling, Chia Pau Tsuen, Lin Kou Hsiang
244, Taipei Hsien, Taiwan

This test report consists of 76 pages in total. It may be duplicated completely for legal use with the approval of the applicant. It should not be reproduced except in full, without the written approval of our laboratory. The client should not use it to claim product endorsement by TAF or any government agencies. The test results in the report only apply to the tested sample.





A D T

TABLE OF CONTENTS

1.	CERTIFICATION	4
2.	SUMMARY OF TEST RESULTS	5
2.1	MEASUREMENT UNCERTAINTY	6
3.	GENERAL INFORMATION	7
3.1	GENERAL DESCRIPTION OF EUT	7
3.2	DESCRIPTION OF TEST MODES	8
3.2.1	CONFIGURATION OF SYSTEM UNDER TEST	9
3.2.2	TEST MODE APPLICABILITY AND TESTED CHANNEL DETAIL	10
3.2.3	GENERAL DESCRIPTION OF APPLIED STANDARDS	12
3.2.4	DESCRIPTION OF SUPPORT UNITS	12
4.	TEST TYPES AND RESULTS	13
4.1	CONDUCTED EMISSION MEASUREMENT	13
4.1.1	LIMITS OF CONDUCTED EMISSION MEASUREMENT	13
4.1.2	TEST INSTRUMENTS	14
4.1.3	TEST PROCEDURES	15
4.1.4	DEVIATION FROM TEST STANDARD	15
4.1.5	TEST SETUP	15
4.1.6	EUT OPERATING CONDITIONS	16
4.1.7	TEST RESULTS (1)	17
4.1.7	TEST RESULTS (2)	19
4.2	RADIATED EMISSION MEASUREMENT	21
4.2.1	LIMITS OF RADIATED EMISSION MEASUREMENT	21
4.2.2	TEST INSTRUMENTS	22
4.2.3	TEST PROCEDURES	23
4.2.4	DEVIATION FROM TEST STANDARD	23
4.2.5	TEST SETUP	24
4.2.6	EUT OPERATING CONDITIONS	25
4.2.7	TEST RESULTS	26
4.3	NUMBER OF HOPPING FREQUENCY USED	35
4.3.1	LIMIT OF HOPPING FREQUENCY USED	35
4.3.2	TEST INSTRUMENTS	35
4.3.3	TEST PROCEDURES	35
4.3.4	DEVIATION FROM TEST STANDARD	36
4.3.5	TEST SETUP	36
4.3.6	TEST RESULTS	36
4.4	DWELL TIME ON EACH CHANNEL	39
4.4.1	LIMIT OF DWELL TIME USED	39
4.4.2	TEST INSTRUMENTS	39
4.4.3	TEST PROCEDURES	39
4.4.4	DEVIATION FROM TEST STANDARD	39
4.4.5	TEST SETUP	40
4.4.6	TEST RESULTS	40
4.5	CHANNEL BANDWIDTH	48



4.5.1	LIMITS OF CHANNEL BANDWIDTH	48
4.5.2	TEST INSTRUMENTS	48
4.5.3	TEST PROCEDURE	48
4.5.4	DEVIATION FROM TEST STANDARD	49
4.5.5	TEST SETUP	49
4.5.6	EUT OPERATING CONDITION	49
4.5.7	TEST RESULTS	50
4.6	HOPPING CHANNEL SEPARATION	54
4.6.1	LIMIT OF HOPPING CHANNEL SEPARATION	54
4.6.2	TEST INSTRUMENTS	54
4.6.3	TEST PROCEDURES	54
4.6.4	DEVIATION FROM TEST STANDARD	55
4.6.5	TEST SETUP	55
4.6.6	TEST RESULTS	55
4.7	MAXIMUM PEAK OUTPUT POWER	60
4.7.1	LIMITS OF MAXIMUM PEAK OUTPUT POWER MEASUREMENT	60
4.7.2	TEST INSTRUMENTS	60
4.7.3	TEST PROCEDURES	60
4.7.4	DEVIATION FROM TEST STANDARD	60
4.7.5	TEST SETUP	61
4.7.6	EUT OPERATING CONDITION	61
4.7.7	TEST RESULTS	61
4.8	BAND EDGES MEASUREMENT	66
4.8.1	LIMITS OF BAND EDGES MEASUREMENT	66
4.8.2	TEST INSTRUMENTS	66
4.8.3	TEST PROCEDURE	66
4.8.4	DEVIATION FROM TEST STANDARD	66
4.8.5	EUT OPERATING CONDITION	66
4.8.6	TEST RESULTS	67
4.9	ANTENNA REQUIREMENT	73
4.9.1	STANDARD APPLICABLE	73
4.9.2	ANTENNA CONNECTED CONSTRUCTION	73
5.	PHOTOGRAPHS OF THE TEST CONFIGURATION	74
6.	INFORMATION ON THE TESTING LABORATORIES	75
7.	APPENDIX A – MODIFICATIONS RECORDERS FOR ENGINEERING CHANGES TO THE EUT BY THE LAB	76



A D T

1. CERTIFICATION

PRODUCT: Bluetooth Headset
BRAND NAME: Altec Lansing
MODEL NO.: BackBeat 903
APPLICANT: Plantronics, Inc.
TESTED: Oct. 27 ~ Dec. 10, 2008
TEST SAMPLE: ENGINEERING SAMPLE
STANDARDS: FCC Part 15, Subpart C (Section 15.247),
ANSI C63.4-2003

The above equipment has been tested by **Bureau Veritas Consumer Products Services (H.K.) Ltd., Taoyuan Branch**, and found compliance with the requirement of the above standards. The test record, data evaluation & Equipment Under Test (EUT) configurations represented herein are true and accurate accounts of the measurements of the sample's EMC characteristics under the conditions specified in this report.

PREPARED BY : Celia Chen , **DATE:** Dec. 15, 2008
(Celia Chen / Specialist)

TECHNICAL ACCEPTANCE : Jamison Chan , **DATE:** Dec. 15, 2008
Responsible for RF (Jamison Chan / Supervisor)

APPROVED BY : Ken Liu , **DATE:** Dec. 15, 2008
(Ken Liu / Deputy Manager)

2. SUMMARY OF TEST RESULTS

The EUT has been tested according to the following specifications:

APPLIED STANDARD: FCC Part 15, Subpart C			
STANDARD SECTION	TEST TYPE AND LIMIT	RESULT	REMARK
15.207	AC Power Conducted Emission	PASS	Meet the requirement of limit. Minimum passing margin is -11.93dB at 0.580MHz.
15.247(a)(1)(iii)	Number of Hopping Frequency Used Spec.: At least 15 channels	PASS	Meet the requirement of limit.
15.247(a)(1)(iii)	Dwell Time on Each Channel Spec. : Max. 0.4 second within 31.6 second	PASS	Meet the requirement of limit.
15.247(a)(1)	1. Hopping Channel Separation Spec. : Min. 25 kHz or 20 dB bandwidth, whichever is greater (see Note) 2. Spectrum Bandwidth of a Frequency Hopping Sequence Spread Spectrum System	PASS	Meet the requirement of limit.
15.247(b)	Maximum Peak Output Power Spec.: max. 21dBm (see Note)	PASS	Meet the requirement of limit.
15.247(d)	Transmitter Radiated Emissions Spec.: Table 15.209	PASS	Meet the requirement of limit. Minimum passing margin is -7.42dB at 2483.500MHz.
15.247(d)	Band Edge Measurement	PASS	Meet the requirement of limit.

NOTE: If The Frequency Hopping System operating in 2400-2483.5MHz band and the output power less than 125mW. The hopping channel carrier frequencies separated by a minimum of 25kHz or two-thirds of the 20dB bandwidth of hopping channel whichever is greater.

2.1 MEASUREMENT UNCERTAINTY

Where relevant, the following measurement uncertainty levels have been estimated for tests performed on the EUT as specified in CISPR 16-4-2:

This uncertainty represents an expanded uncertainty expressed at approximately the 95% confidence level using a coverage factor of $k=2$.

MEASUREMENT	FREQUENCY	UNCERTAINTY
Conducted emissions	9kHz ~ 30MHz	2.44 dB
Radiated emissions	30MHz ~ 1GHz	3.72 dB
	1GHz ~ 40GHz	2.89 dB



3. GENERAL INFORMATION

3.1 GENERAL DESCRIPTION OF EUT

PRODUCT	Bluetooth Headset
MODEL NO.	BackBeat 903
FCC ID	AL8-BB903
POWER SUPPLY	3.7Vdc from battery, 5Vdc from adapter
MODULATION TYPE	GFSK, $\pi/4$ -DQPSK, 8DPSK
RADIO TECHNOLOGY	FHSS
TRANSFER RATE	1/2/3Mbps
OPERATING FREQUENCY	2402 ~ 2480MHz
NUMBER OF CHANNEL	79
OUTPUT POWER	2.099 mW
ANTENNA TYPE	Chip antenna with -2.01dBi gain
I/O PORTS	USB port
DATA CABLE	Shielded USB cable (1.2m)
ASSOCIATED DEVICES	Refer to note 2 below

NOTE:

1. The EUT is a Bluetooth Headset.
2. The EUT was power supplied from the following power adapters (for charging function only) or battery:

Item	Brand Name	Model No.	Rating
Battery	-	-	3.7Vdc
Adapter1	PLANTRONICS	SSA-3W-05 050035F (Part No.: 77394-06)	AC I/P: 100-240V, 50/60Hz, 0.2A DC O/P: 5.0V, 350mA Non-shielded DC (1.8m), AC 2-pin
Adapter2	PLANTRONICS	SSA-3W-05 050018F (Part No.: 77394-04)	AC I/P: 100-240V, 50/60Hz, 0.2A DC O/P: 5.0V, 180mA Non-shielded DC (1.8m), AC 2-pin

※The EUT could not transmit or receive under charging mode.

After pre-tested above two adapters, the **Adapter 1** was the worst case, therefore, only its test data was recorded in this report.

3. For more detailed features description, please refer to the manufacturer's specifications or User's Manual.

3.2 DESCRIPTION OF TEST MODES

79 channels are provided to this EUT:

CHANNEL	FREQ. (MHz)	CHANNEL	FREQ. (MHz)	CHANNEL	FREQ. (MHz)	CHANNEL	FREQ. (MHz)
0	2402	20	2422	40	2442	60	2462
1	2403	21	2423	41	2443	61	2463
2	2404	22	2424	42	2444	62	2464
3	2405	23	2425	43	2445	63	2465
4	2406	24	2426	44	2446	64	2466
5	2407	25	2427	45	2447	65	2467
6	2408	26	2428	46	2448	66	2468
7	2409	27	2429	47	2449	67	2469
8	2410	28	2430	48	2450	68	2470
9	2411	29	2431	49	2451	69	2471
10	2412	30	2432	50	2452	70	2472
11	2413	31	2433	51	2453	71	2473
12	2414	32	2434	52	2454	72	2474
13	2415	33	2435	53	2455	73	2475
14	2416	34	2436	54	2456	74	2476
15	2417	35	2437	55	2457	75	2477
16	2418	36	2438	56	2458	76	2478
17	2419	37	2439	57	2459	77	2479
18	2420	38	2440	58	2460	78	2480
19	2421	39	2441	59	2461		

3.2.1 CONFIGURATION OF SYSTEM UNDER TEST

FOR MODE A:

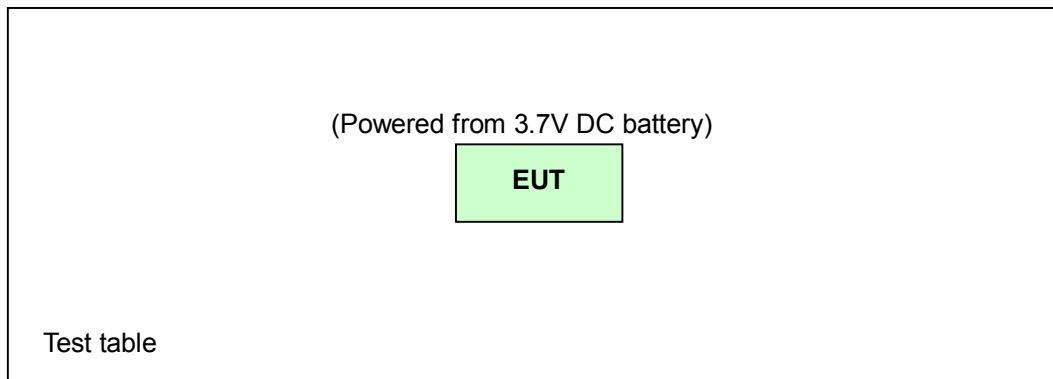

FOR MODE B:

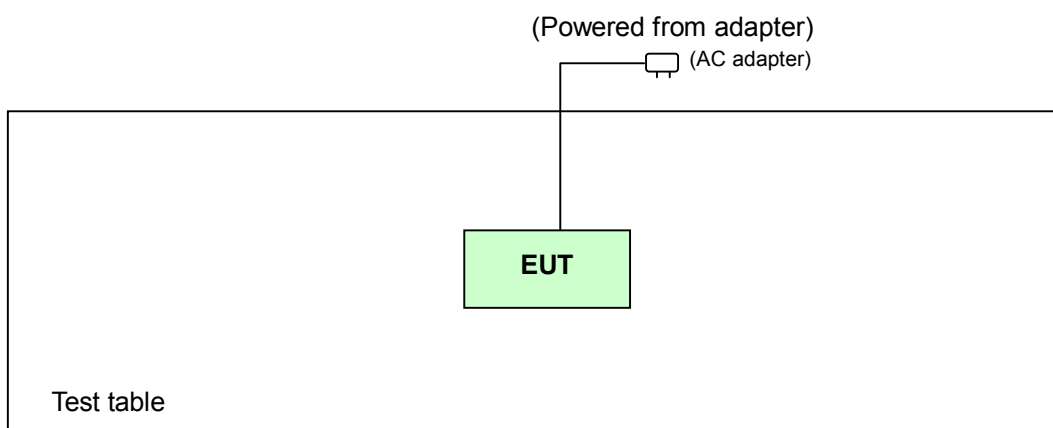

FOR MODE C:

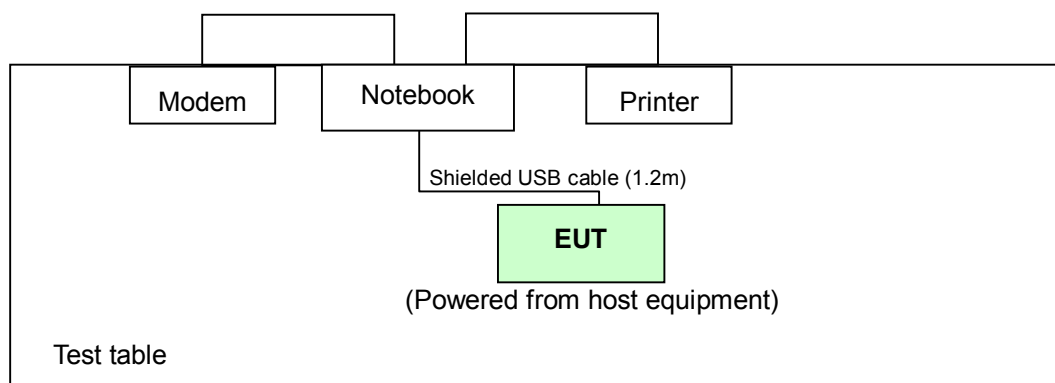

3.2.2 TEST MODE APPLICABILITY AND TESTED CHANNEL DETAIL

EUT CONFIGURE MODE	Applicable to				Description
	PLC	RE<1G	RE≥1G	APCM	
A	Note	√	√	√	Operating Mode (EUT only)
B	√	√	-	-	Charging Mode (EUT with adapter)
C	√	√	-	-	Charging Mode (EUT with Notebook)

Where **PLC**: Power Line Conducted Emission

RE<1G: Radiated Emission below 1GHz

RE≥1G: Radiated Emission above 1GHz

APCM: Antenna Port Conducted Measurement

NOTE: No need to concern of Conducted Emission due to the EUT is powered by battery.

POWER LINE CONDUCTED EMISSION TEST:

- Pre-Scan has been conducted to determine the worst-case mode from all possible combinations between available modulations and packet types.
- Following channel(s) was (were) selected for the final test as listed below.

EUT CONFIGURE MODE	AVAILABLE CHANNEL	TESTED CHANNEL	MODULATION TECHNOLOGY	MODULATION TYPE	PACKET TYPE	DATE RATE
B	-	-	-	-	-	-
C	-	-	-	-	-	-

RADIATED EMISSION TEST (BELOW 1 GHz):

- Pre-Scan has been conducted to determine the worst-case mode from all possible combinations between available modulations, data rates, packet types data rate, XYZ axis and antenna ports (if EUT with antenna diversity architecture).
- Following channel(s) was (were) selected for the final test as listed below.

EUT CONFIGURE MODE	AVAILABLE CHANNEL	TESTED CHANNEL	MODULATION TECHNOLOGY	MODULATION TYPE	PACKET TYPE	DATE RATE	AXIS
A	0 to 78	0	FHSS	8DPSK	DH5	3	X
B	-	-	-	-	-	-	-
C	-	-	-	-	-	-	-

RADIATED EMISSION TEST (ABOVE 1 GHz):

- Pre-Scan has been conducted to determine the worst-case mode from all possible combinations between available modulations, data rates, packet types data rate, XYZ axis and antenna ports (if EUT with antenna diversity architecture).
- Following channel(s) was (were) selected for the final test as listed below.

EUT CONFIGURE MODE	AVAILABLE CHANNEL	TESTED CHANNEL	MODULATION TECHNOLOGY	MODULATION TYPE	PACKET TYPE	DATE RATE	AXIS
A	0 to 78	0, 39, 78	FHSS	GFSK	DH5	1	X
A	0 to 78	0, 39, 78	FHSS	8DPSK	DH5	3	X

BANDEDGE MEASUREMENT:

- Pre-Scan has been conducted to determine the worst-case mode from all possible combinations between available modulations and packet types of the antenna and antenna ports (if EUT with antenna diversity architecture).
- Following channel(s) was (were) selected for the final test as listed below.

EUT CONFIGURE MODE	AVAILABLE CHANNEL	TESTED CHANNEL	MODULATION TECHNOLOGY	MODULATION TYPE	PACKET TYPE	DATE RATE
A	0 to 78	0, 78	FHSS	GFSK	DH5	1
A	0 to 78	0, 78	FHSS	8DPSK	DH5	3

ANTENNA PORT CONDUCTED MEASUREMENT:

- Pre-Scan has been conducted to determine the worst-case mode from all possible combinations between available modulations and packet types of the antenna and antenna ports (if EUT with antenna diversity architecture).
- Following channel(s) was (were) selected for the final test as listed below.

EUT CONFIGURE MODE	AVAILABLE CHANNEL	TESTED CHANNEL	MODULATION TECHNOLOGY	MODULATION TYPE	PACKET TYPE	DATE RATE
A	0 to 78	0, 39, 78	FHSS	GFSK	DH5	1
A	0 to 78	0, 39, 78	FHSS	8DPSK	DH5	3

3.2.3 GENERAL DESCRIPTION OF APPLIED STANDARDS

The EUT is a RF Product. According to the specifications of the manufacturer, it must comply with the requirements of the following standards:

FCC Part 15, Subpart C. (15.247)

ANSI C63.4- 2003

All test items have been performed and recorded as per the above standards.

3.2.4 DESCRIPTION OF SUPPORT UNITS

The EUT has been tested as an independent unit together with other necessary accessories or support units. The following support units or accessories were used to form a representative test configuration during the tests.

NO.	PRODUCT	BRAND	MODEL NO.	SERIAL NO.	FCC ID
1	NOTEBOOK COMPUTER	DELL	PP05L	20375526736	FCC DoC Approved
2	MODEM	ACEEX	1414	980020520	IFAXDM1414
3	PRINTER	EPSON	LQ-300+	DCGY017054	FCC DoC Approved

NO.	SIGNAL CABLE DESCRIPTION OF THE ABOVE SUPPORT UNITS
1	N/A
2	1.2 m braid shielded wire, terminated with DB25 and DB9 connector via metallic frame, w/o core.
3	1.8m braid shielded wire, terminated with DB25 and Centronics connector via metallic frame, w/o core

NOTE: All power cords of the above support units are non shielded (1.8m).

4. TEST TYPES AND RESULTS

4.1 CONDUCTED EMISSION MEASUREMENT

4.1.1 LIMITS OF CONDUCTED EMISSION MEASUREMENT

FREQUENCY OF EMISSION (MHz)	CONDUCTED LIMIT (dB μ V)	
	Quasi-peak	Average
0.15 ~ 0.5	66 to 56	56 to 46
0.5 ~ 5	56	46
5 ~ 30	60	50

- NOTE:**
1. The lower limit shall apply at the transition frequencies.
 2. The limit decreases in line with the logarithm of the frequency in the range of 0.15 to 0.50 MHz.
 3. All emanations from a class A/B digital device or system, including any network of conductors and apparatus connected thereto, shall not exceed the level of field strengths specified above.

4.1.2 TEST INSTRUMENTS

DESCRIPTION & MANUFACTURER	MODEL NO.	SERIAL NO.	CALIBRATED DATE	CALIBRATED UNTIL
ROHDE & SCHWARZ Test Receiver	ESCS 30	838251/021	Dec. 20, 2007	Dec. 19, 2008
ROHDE & SCHWARZ Artificial Mains Network (for EUT)	ESH3-Z5	100218	Nov. 26, 2008	Nov. 25, 2009
LISN With Adapter (for EUT)	AD10	C10Ada-001	Nov. 26, 2008	Nov. 25, 2009
ROHDE & SCHWARZ Artificial Mains Network (for peripherals)	ESH3-Z5	100219	Nov. 20, 2008	Nov. 19, 2009
ROHDE & SCHWARZ Artificial Mains Network (for peripherals)	ESH3-Z5	100220	Nov. 05, 2008	Nov. 04, 2009
Software	ADT_Cond_V7.3.6	NA	NA	NA
Software	ADT_ISN_V7.3.6	NA	NA	NA
RF cable (JYEBAO)	5D-FB	Cable-C10.01	Feb. 27, 2008	Feb. 26, 2009
SUHNER Terminator (For ROHDE & SCHWARZ LISN)	65BNC-5001	E1-010773	Feb. 14, 2008	Feb. 13, 2009

- NOTE:**
1. The calibration interval of the above test instruments is 12 months and the calibrations are traceable to NML/ROC and NIST/USA.
 2. The test was performed in Shielded Room No. 10.
 3. The VCCI Site Registration No. C-1852.

4.1.3 TEST PROCEDURES

- a. The EUT was placed 0.4 meters from the conducting wall of the shielded room with EUT being connected to the power mains through a line impedance stabilization network (LISN). Other support units were connected to the power mains through another LISN. The two LISNs provide 50 ohm/ 50uH of coupling impedance for the measuring instrument.
- b. Both lines of the power mains connected to the EUT were checked for maximum conducted interference.
- c. The frequency range from 150kHz to 30MHz was searched. Emission levels under (Limit - 20dB) were not recorded.

4.1.4 DEVIATION FROM TEST STANDARD

No deviation

4.1.5 TEST SETUP

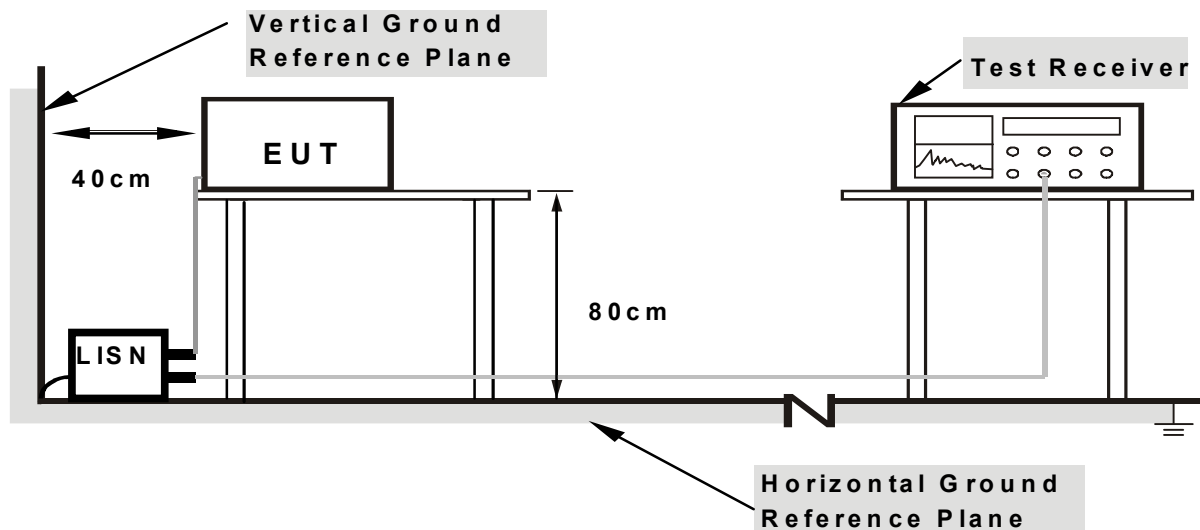

- Note:**
1. Support units were connected to second LISN.
 2. Both of LISNs (AMN) are 80 cm from EUT and at least 80 cm from other units and other metal planes support units.

For the actual test configuration, please refer to the related item – Photographs of the Test Configuration.

4.1.6 EUT OPERATING CONDITIONS

For Mode B

- a. Connected the EUT with AC adapter placed on testing table.
- b. Set the EUT under charging condition.

For Mode C

- a. Connected the EUT to Notebook via USB cable.
- b. Turned on the power of all equipment.
- c. Notebook ran a test program to enable all functions.
- d. Set the EUT under charging condition.
- e. Steps d-e were repeated.

4.1.7 TEST RESULTS (1)

TEST MODE	B	6dB BANDWIDTH	9 kHz
INPUT POWER	120Vac, 60 Hz	PHASE	Line 1
ENVIRONMENTAL CONDITIONS	22deg. C, 67% RH, 999hPa	TESTED BY: Jun Wu	

No	Freq. [MHz]	Corr. Factor (dB)	Reading Value		Emission Level		Limit		Margin	
			[dB (uV)]		[dB (uV)]		[dB (uV)]		(dB)	
			Q.P.	AV.	Q.P.	AV.	Q.P.	AV.	Q.P.	AV.
1	0.209	0.22	45.04	-	45.26	-	63.26	53.26	-18.00	-
2	0.314	0.22	45.13	-	45.35	-	59.86	49.86	-14.51	-
3	0.474	0.22	44.09	-	44.31	-	56.44	46.44	-12.13	-
4	0.525	0.22	43.66	-	43.88	-	56.00	46.00	-12.12	-
5	0.580	0.23	43.84	-	44.07	-	56.00	46.00	-11.93	-
6	29.559	1.69	25.21	-	26.90	-	60.00	50.00	-33.10	-

- REMARKS:**
1. Q.P. and AV. are abbreviations of quasi-peak and average individually.
 2. "-": The Quasi-peak reading value also meets average limit and measurement with the average detector is unnecessary.
 3. The emission levels of other frequencies were very low against the limit.
 4. Margin value = Emission level - Limit value
 5. Correction factor = Insertion loss + Cable loss
 6. Emission Level = Correction Factor + Reading Value.

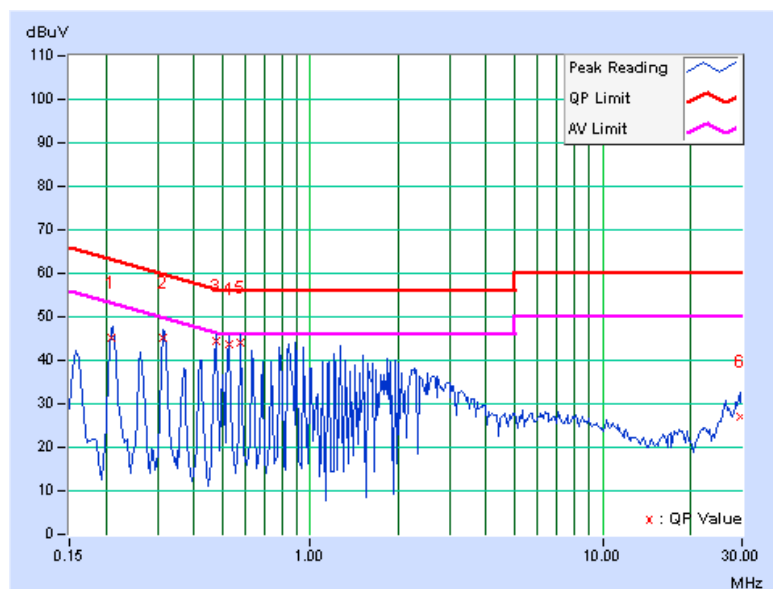



A D T

TEST MODE	B	6dB BANDWIDTH	9 kHz
INPUT POWER	120Vac, 60 Hz	PHASE	Line 2
ENVIRONMENTAL CONDITIONS	22deg. C, 67% RH, 999hPa	TESTED BY: Jun Wu	

No	Freq. [MHz]	Corr. Factor (dB)	Reading Value		Emission Level		Limit		Margin	
			[dB (uV)]		[dB (uV)]		[dB (uV)]		(dB)	
	Q.P.	AV.	Q.P.	AV.	Q.P.	AV.	Q.P.	AV.	Q.P.	AV.
1	0.213	0.19	39.30	-	39.49	-	63.11	53.11	-23.62	-
2	0.318	0.20	39.52	-	39.72	-	59.76	49.76	-20.04	-
3	0.529	0.20	36.98	-	37.18	-	56.00	46.00	-18.82	-
4	0.584	0.21	37.05	-	37.26	-	56.00	46.00	-18.74	-
5	1.582	0.24	34.17	-	34.41	-	56.00	46.00	-21.59	-
6	29.645	1.30	22.38	-	23.68	-	60.00	50.00	-36.32	-

- REMARKS:**
1. Q.P. and AV. are abbreviations of quasi-peak and average individually.
 2. "-": The Quasi-peak reading value also meets average limit and measurement with the average detector is unnecessary.
 3. The emission levels of other frequencies were very low against the limit.
 4. Margin value = Emission level - Limit value
 5. Correction factor = Insertion loss + Cable loss
 6. Emission Level = Correction Factor + Reading Value.

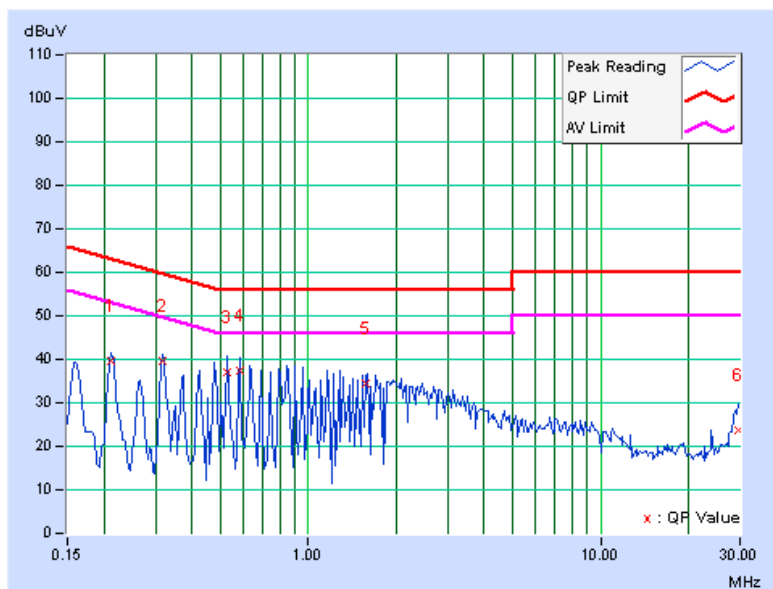



A D T

4.1.7 TEST RESULTS (2)

TEST MODE	C	6dB BANDWIDTH	9 kHz
INPUT POWER (SYSTEM)	120Vac, 60 Hz	PHASE	Line 1
ENVIRONMENTAL CONDITIONS	22deg. C, 67% RH, 999hPa	TESTED BY: Jun Wu	

No	Freq. [MHz]	Corr. Factor (dB)	Reading Value		Emission Level		Limit		Margin	
			[dB (uV)]		[dB (uV)]		[dB (uV)]		(dB)	
			Q.P.	AV.	Q.P.	AV.	Q.P.	AV.	Q.P.	AV.
1	0.181	0.20	48.64	-	48.84	-	64.43	54.43	-15.59	-
2	0.232	0.22	38.83	-	39.05	-	62.38	52.38	-23.33	-
3	3.148	0.33	30.14	-	30.47	-	56.00	46.00	-25.53	-
4	3.938	0.36	30.66	-	31.02	-	56.00	46.00	-24.98	-
5	19.070	1.34	24.11	-	25.45	-	60.00	50.00	-34.55	-
6	22.586	1.46	24.97	-	26.43	-	60.00	50.00	-33.57	-

- REMARKS:**
1. Q.P. and AV. are abbreviations of quasi-peak and average individually.
 2. "-": The Quasi-peak reading value also meets average limit and measurement with the average detector is unnecessary.
 3. The emission levels of other frequencies were very low against the limit.
 4. Margin value = Emission level - Limit value
 5. Correction factor = Insertion loss + Cable loss
 6. Emission Level = Correction Factor + Reading Value.

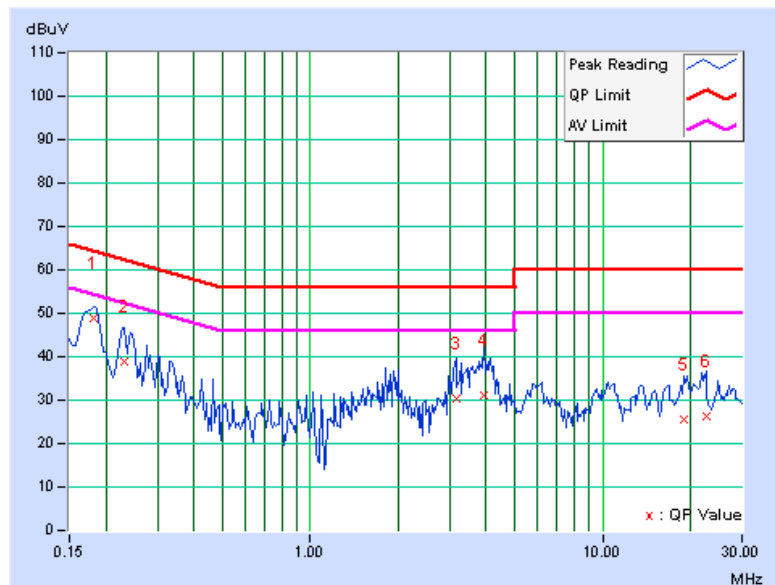

TEST MODE	C	6dB BANDWIDTH	9 kHz
INPUT POWER (SYSTEM)	120Vac, 60 Hz	PHASE	Line 2
ENVIRONMENTAL CONDITIONS	22deg. C, 67% RH, 999hPa	TESTED BY: Jun Wu	

No	Freq. [MHz]	Corr. Factor (dB)	Reading Value		Emission Level		Limit		Margin	
			[dB (uV)]		[dB (uV)]		[dB (uV)]		(dB)	
			Q.P.	AV.	Q.P.	AV.	Q.P.	AV.	Q.P.	AV.
1	0.185	0.18	46.56	-	46.74	-	64.25	54.25	-17.52	-
2	0.244	0.19	39.96	-	40.15	-	61.97	51.97	-21.82	-
3	3.293	0.29	25.89	-	26.18	-	56.00	46.00	-29.82	-
4	3.867	0.31	33.39	-	33.70	-	56.00	46.00	-22.30	-
5	5.863	0.41	25.03	-	25.44	-	60.00	50.00	-34.56	-
6	21.504	1.08	25.02	-	26.10	-	60.00	50.00	-33.90	-

- REMARKS:**
1. Q.P. and AV. are abbreviations of quasi-peak and average individually.
 2. "-": The Quasi-peak reading value also meets average limit and measurement with the average detector is unnecessary.
 3. The emission levels of other frequencies were very low against the limit.
 4. Margin value = Emission level - Limit value
 5. Correction factor = Insertion loss + Cable loss
 6. Emission Level = Correction Factor + Reading Value.

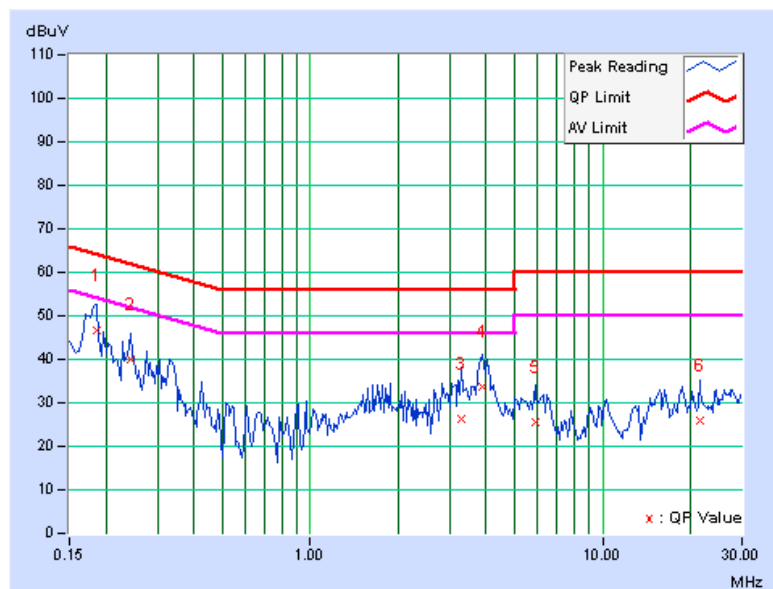

4.2 RADIATED EMISSION MEASUREMENT

4.2.1 LIMITS OF RADIATED EMISSION MEASUREMENT

Emissions radiated outside of the specified bands, shall be according to the general radiated limits in 15.209 as following:

FREQUENCIES (MHz)	FIELD STRENGTH (microvolts/meter)	MEASUREMENT DISTANCE (meters)
0.009 ~ 0.490	2400/F(kHz)	300
0.490 ~ 1.705	24000/F(kHz)	30
1.705 ~ 30.0	30	30
30 ~ 88	100	3
88 ~ 216	150	3
216 ~ 960	200	3
Above 960	500	3

NOTE:

1. The lower limit shall apply at the transition frequencies.
2. Emission level (dBuV/m) = 20 log Emission level (uV/m).
3. As shown in 15.35(b), for frequencies above 1000MHz, the field strength limits are based on average detector, however, the peak field strength of any emission shall not exceed the maximum permitted average limits, specified above by more than 20dB under any condition of modulation.



4.2.2 TEST INSTRUMENTS

DESCRIPTION & MANUFACTURER	MODEL NO.	SERIAL NO.	CALIBRATED DATE	CALIBRATED UNTIL
HP Preamplifier	8447D	2432A03504	May 09, 2008	May 08, 2009
HP Preamplifier	8449B	3008A01924	Sep. 03, 2008	Sep. 02, 2009
HP Preamplifier	8449B	3008A01292	Aug. 06, 2008	Aug. 05, 2009
ROHDE & SCHWARZ TEST RECEIVER	ESI7	836697/012	Dec. 04, 2008	Dec. 03, 2009
Schwarzbeck Antenna	VULB 9168	137	May 02, 2008	May 01, 2009
Schwarzbeck Antenna	VHBA 9123	480	Apr. 23, 2008	Apr. 22, 2009
EMCO Horn Antenna	3115	6714	Oct. 17, 2008	Oct. 16, 2009
EMCO Horn Antenna	3115	9312-4192	Apr. 21, 2008	Apr. 20, 2009
ADT. Turn Table	TT100	0306	NA	NA
ADT. Tower	AT100	0306	NA	NA
Software	ADT_Radiated_V 7.6.15.9.2	NA	NA	NA
SUHNER RF cable	SF104-26.5	CABLE-CH6-17m -01	Aug. 22, 2008	Aug. 21, 2009
ROHDE & SCHWARZ Spectrum Analyzer	FSP 40	100035	Mar. 26, 2008	Mar. 25, 2009

- NOTE:**
1. The calibration interval of the above test instruments is 12 months. And the calibrations are traceable to NML/ROC and NIST/USA.
 2. The horn antenna and HP preamplifier (model: 8449B) are used only for the measurement of emission frequency above 1GHz if tested.
 3. The test was performed in Chamber No. 6.
 4. The Industry Canada Reference No. IC 3789-6.
 5. The FCC Site Registration No. is 447212.

4.2.3 TEST PROCEDURES

- a. The EUT was placed on the top of a rotating table 0.8 meters above the ground at a 3 meter semi-anechoic chamber. The table was rotated 360 degrees to determine the position of the highest radiation.
- b. The EUT was set 3 meters away from the interference-receiving antenna, which was mounted on the top of a variable-height antenna tower.
- c. The antenna is a broadband antenna, and its height is varied from one meter to four meters above the ground to determine the maximum value of the field strength. Both horizontal and vertical polarizations of the antenna are set to make the measurement.
- d. For each suspected emission, the EUT was arranged to its worst case and then the antenna was tuned to heights from 1 meter to 4 meters and the rotatable table was turned from 0 degrees to 360 degrees to find the maximum reading.
- e. The test-receiver system was set to Peak Detect Function and Specified Bandwidth with Maximum Hold Mode.
- f. If the emission level of the EUT in peak mode was lower than the limit specified, then testing could be stopped and the peak values of the EUT would be reported. Otherwise the emissions would be re-tested one by one using peak, quasi-peak or average method as specified and then reported in a data sheet.

NOTE:

1. The resolution bandwidth of test receiver/spectrum analyzer is 120kHz for Quasi-peak detection at frequency below 1GHz.
2. The resolution bandwidth is 1MHz and video bandwidth of test receiver/spectrum analyzer is 3MHz for Peak detection at frequency above 1GHz. The resolution bandwidth of test receiver/spectrum analyzer is 1 MHz for Average detection (AV) at frequency above 1GHz.

4.2.4 DEVIATION FROM TEST STANDARD

No deviation

4.2.5 TEST SETUP

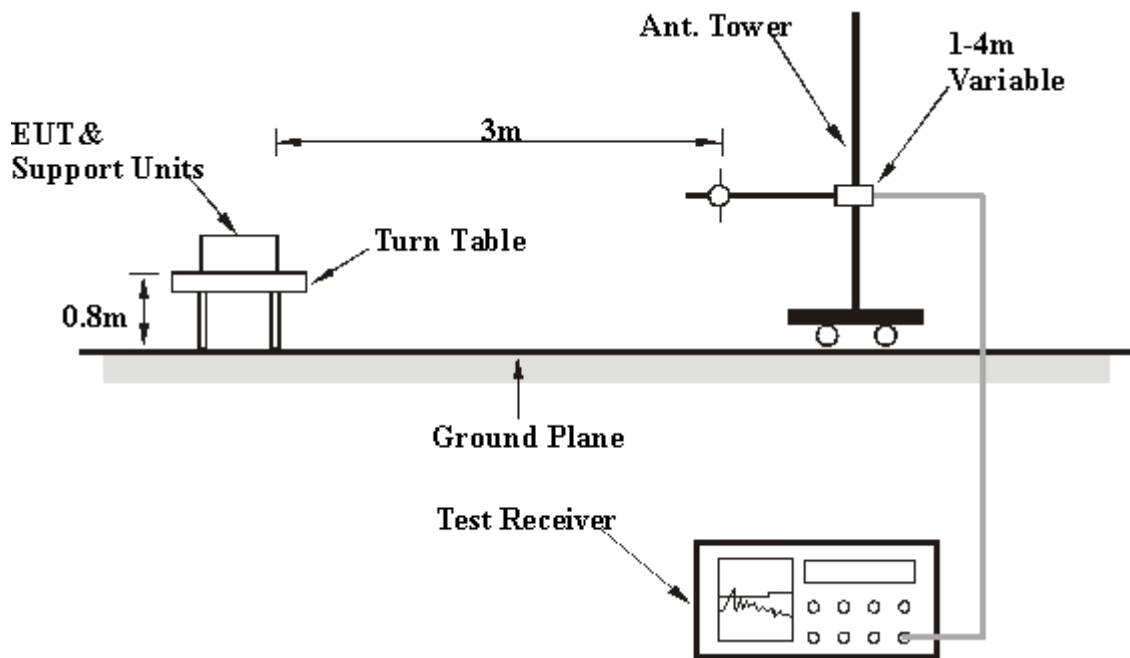

For the actual test configuration, please refer to the related item – Photographs of the Test Configuration.

4.2.6 EUT OPERATING CONDITIONS

For Mode A

- a. Set the EUT under transmission/receiving condition continuously at specific channel frequency.

For Mode B

- a. Connected the EUT with AC adapter placed on testing table.
- b. Set the EUT under charging condition.

For Mode C

- a. Connected the EUT to Notebook via USB cable.
- b. Turned on the power of all equipment.
- c. Notebook ran a test program to enable all functions.
- d. Set the EUT under charging condition.
- e. Steps d-e were repeated.



A D T

4.2.7 TEST RESULTS

RADIATED WORST CASE DATA: FOR 8DPSK (BELOW 1GHz)

TEST MODE	A		
MODULATION TYPE	8DPSK	CHANNEL	0
INPUT POWER	3.7Vdc	FREQUENCY RANGE	Below 1000MHz
ENVIRONMENTAL CONDITIONS	25deg. C, 78% RH, 1007hPa	DETECTOR FUNCTION	Quasi-Peak
TESTED BY	Chad Lee		

ANTENNA POLARITY & TEST DISTANCE: HORIZONTAL AT 3 M

No.	Freq. (MHz)	Emission Level (dBuV/m)	Limit (dBuV/m)	Margin (dB)	Antenna Height (m)	Table Angle (Degree)	Raw Value (dBuV)	Correction Factor (dB/m)
1	278.818	27.54 QP	46.00	-18.46	1.22 H	55	11.88	15.66
2	296.313	31.87 QP	46.00	-14.13	1.32 H	226	15.95	15.92
3	780.341	28.21 QP	46.00	-17.79	1.00 H	238	1.68	26.53
4	807.555	28.48 QP	46.00	-17.52	1.00 H	127	1.34	27.15
5	836.713	28.26 QP	46.00	-17.74	1.43 H	205	0.74	27.52
6	852.265	27.86 QP	46.00	-18.14	1.00 H	10	0.13	27.73

ANTENNA POLARITY & TEST DISTANCE: VERTICAL AT 3 M

No.	Freq. (MHz)	Emission Level (dBuV/m)	Limit (dBuV/m)	Margin (dB)	Antenna Height (m)	Table Angle (Degree)	Raw Value (dBuV)	Correction Factor (dB/m)
1	774.509	24.28 QP	46.00	-21.72	1.12 V	130	-2.10	26.38
2	792.004	25.28 QP	46.00	-20.72	1.00 V	100	-1.56	26.84
3	832.826	26.09 QP	46.00	-19.91	1.08 V	94	-1.38	27.47
4	858.096	25.79 QP	46.00	-20.21	1.00 V	304	-2.02	27.81
5	896.974	26.59 QP	46.00	-19.41	1.13 V	109	-1.77	28.36
6	931.964	27.02 QP	46.00	-18.98	1.00 V	64	-1.81	28.83

- REMARKS:**
1. Emission level (dBuV/m) = Raw Value (dBuV) + Correction Factor (dB/m).
 2. Correction Factor (dB/m) = Antenna Factor (dB/m) + Cable Factor (dB).
 3. The other emission levels were very low against the limit.
 4. Margin value = Emission level – Limit value.



A D T

TEST MODE	B	FREQUENCY RANGE	Below 1000MHz
INPUT POWER	120Vac, 60 Hz	DETECTOR FUNCTION	Quasi-Peak
ENVIRONMENTAL CONDITIONS	25deg. C, 78% RH, 1007hPa	TESTED BY: Chad Lee	

ANTENNA POLARITY & TEST DISTANCE: HORIZONTAL AT 3 M

No.	Freq. (MHz)	Emission Level (dBuV/m)	Limit (dBuV/m)	Margin (dB)	Antenna Height (m)	Table Angle (Degree)	Raw Value (dBuV)	Correction Factor (dB/m)
1	41.663	26.38 QP	40.00	-13.62	1.00 H	121	11.29	15.09
2	271.042	27.79 QP	46.00	-18.21	1.00 H	31	12.24	15.55
3	570.401	24.55 QP	46.00	-21.45	1.00 H	181	1.71	22.85
4	609.279	26.61 QP	46.00	-19.39	1.00 H	169	2.96	23.65
5	652.044	25.69 QP	46.00	-20.31	1.00 H	172	1.67	24.02
6	663.707	24.97 QP	46.00	-21.03	1.00 H	175	0.82	24.15

ANTENNA POLARITY & TEST DISTANCE: VERTICAL AT 3 M

No.	Freq. (MHz)	Emission Level (dBuV/m)	Limit (dBuV/m)	Margin (dB)	Antenna Height (m)	Table Angle (Degree)	Raw Value (dBuV)	Correction Factor (dB/m)
1	224.389	27.45 QP	46.00	-18.55	1.00 V	145	14.06	13.39
2	237.996	24.29 QP	46.00	-21.71	1.02 V	58	9.93	14.36
3	576.232	24.95 QP	46.00	-21.05	1.00 V	349	1.96	22.99
4	768.677	24.64 QP	46.00	-21.36	1.04 V	70	-1.59	26.23
5	813.387	24.88 QP	46.00	-21.12	1.08 V	163	-2.34	27.22
6	844.489	25.14 QP	46.00	-20.86	1.00 V	154	-2.48	27.62

- REMARKS:**
1. Emission level (dBuV/m) = Raw Value (dBuV) + Correction Factor (dB/m).
 2. Correction Factor (dB/m) = Antenna Factor (dB/m) + Cable Factor (dB).
 3. The other emission levels were very low against the limit.
 4. Margin value = Emission level – Limit value.



A D T

TEST MODE	C	FREQUENCY RANGE	Below 1000MHz
INPUT POWER (SYSTEM)	120Vac, 60 Hz	DETECTOR FUNCTION	Quasi-Peak
ENVIRONMENTAL CONDITIONS	25deg. C, 78% RH, 1007hPa	TESTED BY: Chad Lee	

ANTENNA POLARITY & TEST DISTANCE: HORIZONTAL AT 3 M

No.	Freq. (MHz)	Emission Level (dBuV/m)	Limit (dBuV/m)	Margin (dB)	Antenna Height (m)	Table Angle (Degree)	Raw Value (dBuV)	Correction Factor (dB/m)
1	572.345	25.17 QP	46.00	-20.83	1.22 H	262	2.27	22.90
2	618.998	25.37 QP	46.00	-20.63	1.00 H	262	1.63	23.73
3	630.661	25.02 QP	46.00	-20.98	1.00 H	271	1.19	23.83
4	673.427	25.71 QP	46.00	-20.29	1.00 H	274	1.45	24.26
5	751.182	24.17 QP	46.00	-21.83	1.14 H	271	-1.60	25.77
6	780.341	27.55 QP	46.00	-18.45	1.00 H	274	1.01	26.53

ANTENNA POLARITY & TEST DISTANCE: VERTICAL AT 3 M

No.	Freq. (MHz)	Emission Level (dBuV/m)	Limit (dBuV/m)	Margin (dB)	Antenna Height (m)	Table Angle (Degree)	Raw Value (dBuV)	Correction Factor (dB/m)
1	203.006	29.04 QP	43.50	-14.46	1.23 V	103	17.18	11.86
2	245.772	24.61 QP	46.00	-21.39	1.00 V	271	9.70	14.91
3	572.345	24.06 QP	46.00	-21.94	1.03 V	259	1.16	22.90
4	622.886	24.45 QP	46.00	-21.55	1.00 V	49	0.68	23.77
5	743.407	24.22 QP	46.00	-21.78	1.46 V	226	-1.36	25.58
6	768.677	24.40 QP	46.00	-21.60	1.00 V	70	-1.83	26.23

- REMARKS:**
1. Emission level (dBuV/m) = Raw Value (dBuV) + Correction Factor (dB/m).
 2. Correction Factor (dB/m) = Antenna Factor (dB/m) + Cable Factor (dB).
 3. The other emission levels were very low against the limit.
 4. Margin value = Emission level – Limit value.

RADIATED DATA: FOR GFSK (ABOVE 1GHz)

TEST MODE	A		
MODULATION TYPE	GFSK	CHANNEL	0
INPUT POWER	3.7Vdc	FREQUENCY RANGE	1 ~ 25GHz
ENVIRONMENTAL CONDITIONS	25 deg. C, 78% RH, 1007hPa	DETECTOR FUNCTION	Peak (PK) Average (AV)
TESTED BY	Chad Lee		

ANTENNA POLARITY & TEST DISTANCE: HORIZONTAL AT 3 M

No.	Freq. (MHz)	Emission Level (dBuV/m)	Limit (dBuV/m)	Margin (dB)	Antenna Height (m)	Table Angle (Degree)	Raw Value (dBuV)	Correction Factor (dB/m)
1	1602.000	46.46 PK	74.00	-27.54	1.00 H	117	15.19	31.27
2	1602.000	42.80 AV	54.00	-11.20	1.00 H	117	11.53	31.27
3	2390.000	57.25 PK	74.00	-16.75	1.04 H	249	23.95	33.30
4	2390.000	27.15 AV	54.00	-26.85	1.04 H	249	-6.15	33.30
5	*2402.000	104.62 PK			1.04 H	249	71.27	33.35
6	*2402.000	74.52 AV			1.04 H	249	41.17	33.35
7	4804.000	53.65 PK	74.00	-20.35	1.00 H	153	13.26	40.39
8	4804.000	23.55 AV	54.00	-30.45	1.00 H	153	-16.84	40.39

ANTENNA POLARITY & TEST DISTANCE: VERTICAL AT 3 M

No.	Freq. (MHz)	Emission Level (dBuV/m)	Limit (dBuV/m)	Margin (dB)	Antenna Height (m)	Table Angle (Degree)	Raw Value (dBuV)	Correction Factor (dB/m)
1	1602.000	42.12 PK	74.00	-31.88	1.00 V	236	10.85	31.27
2	1602.000	33.45 AV	54.00	-20.55	1.00 V	236	2.18	31.27
3	2390.000	56.58 PK	74.00	-17.42	1.03 V	280	23.28	33.30
4	2390.000	26.48 AV	54.00	-27.52	1.03 V	280	-6.82	33.30
5	*2402.000	93.62 PK			1.03 V	280	60.27	33.35
6	*2402.000	63.52 AV			1.03 V	280	30.17	33.35
7	4804.000	55.68 PK	74.00	-18.32	1.00 V	23	15.29	40.39
8	4804.000	25.58 AV	54.00	-28.42	1.00 V	23	-14.81	40.39

- REMARKS:**
1. Emission level (dBuV/m) = Raw Value (dBuV) + Correction Factor (dB/m).
 2. Correction Factor (dB/m) = Antenna Factor (dB/m) + Cable Factor (dB).
 3. The other emission levels were very low against the limit.
 4. Margin value = Emission level – Limit value.
 5. The DH5 packet was the worse case duty cycle for a transmit dwell time on a channel, based upon bluetooth theory the transmitter is on $0.625 * 5$ per 296.25 ms per channel. Therefore, the duty cycle be equal to: $20\log(3.125/100) = -30.1$ dB.
 6. Average value = peak reading + $20\log(\text{duty cycle})$.



A D T

TEST MODE	A		
MODULATION TYPE	GFSK	CHANNEL	39
INPUT POWER	3.7Vdc	FREQUENCY RANGE	1 ~ 25GHz
ENVIRONMENTAL CONDITIONS	25 deg. C, 78% RH, 1007hPa	DETECTOR FUNCTION	Peak (PK) Average (AV)
TESTED BY	Chad Lee		

ANTENNA POLARITY & TEST DISTANCE: HORIZONTAL AT 3 M

No.	Freq. (MHz)	Emission Level (dBuV/m)	Limit (dBuV/m)	Margin (dB)	Antenna Height (m)	Table Angle (Degree)	Raw Value (dBuV)	Correction Factor (dB/m)
1	1626.000	45.84 PK	74.00	-28.16	1.00 H	273	14.55	31.29
2	1626.000	41.11 AV	54.00	-12.89	1.00 H	273	9.82	31.29
3	*2441.000	104.76 PK			1.03 H	248	71.23	33.53
4	*2441.000	74.66 AV			1.03 H	248	41.13	33.53
5	4882.000	52.48 PK	74.00	-21.52	1.00 H	124	11.91	40.57
6	4882.000	22.38 AV	54.00	-31.62	1.00 H	124	-18.19	40.57

ANTENNA POLARITY & TEST DISTANCE: VERTICAL AT 3 M

No.	Freq. (MHz)	Emission Level (dBuV/m)	Limit (dBuV/m)	Margin (dB)	Antenna Height (m)	Table Angle (Degree)	Raw Value (dBuV)	Correction Factor (dB/m)
1	1626.000	42.73 PK	74.00	-31.27	1.08 V	232	11.44	31.29
2	1626.000	33.77 AV	54.00	-20.23	1.08 V	232	2.48	31.29
3	*2441.000	95.51 PK			1.00 V	279	61.98	33.53
4	*2441.000	65.41 AV			1.00 V	279	31.88	33.53
5	4882.000	57.41 PK	74.00	-16.59	1.00 V	100	16.84	40.57
6	4882.000	27.31 AV	54.00	-26.69	1.00 V	100	-13.26	40.57

- REMARKS:**
1. Emission level (dBuV/m) = Raw Value (dBuV) + Correction Factor (dB/m).
 2. Correction Factor (dB/m) = Antenna Factor (dB/m) + Cable Factor (dB).
 3. The other emission levels were very low against the limit.
 4. Margin value = Emission level – Limit value.
 5. The DH5 packet was the worse case duty cycle for a transmit dwell time on a channel, based upon bluetooth theory the transmitter is on 0.625 * 5 per 296.25 ms per channel. Therefore, the duty cycle be equal to: $20\log(3.125/100) = -30.1$ dB.
 6. Average value = peak reading + $20\log(\text{duty cycle})$.



A D T

TEST MODE	A		
MODULATION TYPE	GFSK	CHANNEL	78
INPUT POWER	3.7Vdc	FREQUENCY RANGE	1 ~ 25GHz
ENVIRONMENTAL CONDITIONS	25 deg. C, 78% RH, 1007hPa	DETECTOR FUNCTION	Peak (PK) Average (AV)
TESTED BY	Chad Lee		

ANTENNA POLARITY & TEST DISTANCE: HORIZONTAL AT 3 M

No.	Freq. (MHz)	Emission Level (dBuV/m)	Limit (dBuV/m)	Margin (dB)	Antenna Height (m)	Table Angle (Degree)	Raw Value (dBuV)	Correction Factor (dB/m)
1	1652.000	47.60 PK	74.00	-26.40	1.00 H	277	16.29	31.31
2	1652.000	44.20 AV	54.00	-9.80	1.00 H	277	12.89	31.31
3	*2480.000	103.13 PK			1.00 H	250	69.43	33.70
4	*2480.000	73.03 AV			1.00 H	250	39.33	33.70
5	2483.500	65.90 PK	74.00	-8.10	1.00 H	250	32.18	33.72
6	2483.500	35.80 AV	54.00	-18.20	1.00 H	250	2.08	33.72
7	4960.000	54.89 PK	74.00	-19.11	1.00 H	199	14.13	40.76
8	4960.000	24.79 AV	54.00	-29.21	1.00 H	199	-15.97	40.76

ANTENNA POLARITY & TEST DISTANCE: VERTICAL AT 3 M

No.	Freq. (MHz)	Emission Level (dBuV/m)	Limit (dBuV/m)	Margin (dB)	Antenna Height (m)	Table Angle (Degree)	Raw Value (dBuV)	Correction Factor (dB/m)
1	1652.000	42.74 PK	74.00	-31.26	1.00 V	235	11.43	31.31
2	1652.000	35.08 AV	54.00	-18.92	1.00 V	235	3.77	31.31
3	*2480.000	95.12 PK			1.00 V	279	61.42	33.70
4	*2480.000	65.02 AV			1.00 V	279	31.32	33.70
5	2483.500	59.65 PK	74.00	-14.35	1.00 V	279	25.93	33.72
6	2483.500	29.55 AV	54.00	-24.45	1.00 V	279	-4.17	33.72
7	4960.000	55.47 PK	74.00	-18.53	1.00 V	102	14.71	40.76
8	4960.000	25.37 AV	54.00	-28.63	1.00 V	102	-15.39	40.76

- REMARKS:**
1. Emission level (dBuV/m) = Raw Value (dBuV) + Correction Factor (dB/m).
 2. Correction Factor (dB/m) = Antenna Factor (dB/m) + Cable Factor (dB).
 3. The other emission levels were very low against the limit.
 4. Margin value = Emission level – Limit value.
 5. The DH5 packet was the worse case duty cycle for a transmit dwell time on a channel, based upon bluetooth theory the transmitter is on 0.625 * 5 per 296.25 ms per channel. Therefore, the duty cycle be equal to: $20\log(3.125/100) = -30.1$ dB.
 6. Average value = peak reading + $20\log(\text{duty cycle})$.



A D T

RADIATED DATA: FOR 8DPSK (ABOVE 1GHz)

TEST MODE	A		
MODULATION TYPE	8DPSK	CHANNEL	0
INPUT POWER	3.7Vdc	FREQUENCY RANGE	1 ~ 25GHz
ENVIRONMENTAL CONDITIONS	25 deg. C, 78% RH, 1007hPa	DETECTOR FUNCTION	Peak (PK) Average (AV)
TESTED BY	Chad Lee		

ANTENNA POLARITY & TEST DISTANCE: HORIZONTAL AT 3 M

No.	Freq. (MHz)	Emission Level (dBuV/m)	Limit (dBuV/m)	Margin (dB)	Antenna Height (m)	Table Angle (Degree)	Raw Value (dBuV)	Correction Factor (dB/m)
1	1602.000	45.48 PK	74.00	-28.52	1.00 H	12	14.21	31.27
2	1602.000	41.16 AV	54.00	-12.84	1.00 H	12	9.89	31.27
3	2390.000	55.58 PK	74.00	-18.42	1.05 H	249	22.28	33.30
4	2390.000	25.48 AV	54.00	-28.52	1.05 H	249	-7.82	33.30
5	*2402.000	106.21 PK			1.05 H	249	72.86	33.35
6	*2402.000	76.11 AV			1.05 H	249	42.76	33.35
7	4804.000	48.15 PK	74.00	-25.85	1.00 H	15	7.76	40.39
8	4804.000	18.05 AV	54.00	-35.95	1.00 H	15	-22.34	40.39

ANTENNA POLARITY & TEST DISTANCE: VERTICAL AT 3 M

No.	Freq. (MHz)	Emission Level (dBuV/m)	Limit (dBuV/m)	Margin (dB)	Antenna Height (m)	Table Angle (Degree)	Raw Value (dBuV)	Correction Factor (dB/m)
1	1602.000	41.78 PK	74.00	-32.22	1.00 V	232	10.51	31.27
2	1602.000	30.25 AV	54.00	-23.75	1.00 V	232	-1.02	31.27
3	2390.000	56.55 PK	74.00	-17.45	1.05 V	280	23.25	33.30
4	2390.000	26.45 AV	54.00	-27.55	1.05 V	280	-6.85	33.30
5	*2402.000	94.60 PK			1.05 V	280	61.25	33.35
6	*2402.000	64.50 AV			1.05 V	280	31.15	33.35
7	4804.000	53.44 PK	74.00	-20.56	1.00 V	5	13.05	40.39
8	4804.000	23.34 AV	54.00	-30.66	1.00 V	5	-17.05	40.39

- REMARKS:**
1. Emission level (dBuV/m) = Raw Value (dBuV) + Correction Factor (dB/m).
 2. Correction Factor (dB/m) = Antenna Factor (dB/m) + Cable Factor (dB).
 3. The other emission levels were very low against the limit.
 4. Margin value = Emission level – Limit value.
 5. The DH5 packet was the worse case duty cycle for a transmit dwell time on a channel, based upon bluetooth theory the transmitter is on 0.625 * 5 per 296.25 ms per channel. Therefore, the duty cycle be equal to: $20\log(3.125/100) = -30.1$ dB.
 6. Average value = peak reading + $20\log(\text{duty cycle})$.



A D T

TEST MODE	A		
MODULATION TYPE	8DPSK	CHANNEL	39
INPUT POWER	3.7Vdc	FREQUENCY RANGE	1 ~ 25GHz
ENVIRONMENTAL CONDITIONS	25 deg. C, 78% RH, 1007hPa	DETECTOR FUNCTION	Peak (PK) Average (AV)
TESTED BY	Chad Lee		

ANTENNA POLARITY & TEST DISTANCE: HORIZONTAL AT 3 M

No.	Freq. (MHz)	Emission Level (dBuV/m)	Limit (dBuV/m)	Margin (dB)	Antenna Height (m)	Table Angle (Degree)	Raw Value (dBuV)	Correction Factor (dB/m)
1	1626.000	43.86 PK	74.00	-30.14	1.03 H	68	12.57	31.29
2	1626.000	38.46 AV	54.00	-15.54	1.03 H	68	7.17	31.29
3	*2441.000	104.73 PK			1.05 H	249	71.20	33.53
4	*2441.000	74.63 AV			1.05 H	249	41.10	33.53
5	4882.000	47.16 PK	74.00	-26.84	1.00 H	5	6.59	40.57
6	4882.000	17.06 AV	54.00	-36.94	1.00 H	5	-23.51	40.57

ANTENNA POLARITY & TEST DISTANCE: VERTICAL AT 3 M

No.	Freq. (MHz)	Emission Level (dBuV/m)	Limit (dBuV/m)	Margin (dB)	Antenna Height (m)	Table Angle (Degree)	Raw Value (dBuV)	Correction Factor (dB/m)
1	1626.000	39.73 PK	74.00	-34.27	1.06 V	192	8.44	31.29
2	1626.000	28.10 AV	54.00	-25.90	1.06 V	192	-3.19	31.29
3	*2441.000	91.91 PK			1.00 V	307	58.38	33.53
4	*2441.000	61.81 AV			1.00 V	307	28.28	33.53
5	4882.000	52.19 PK	74.00	-21.81	1.00 V	102	11.62	40.57
6	4882.000	22.09 AV	54.00	-31.91	1.00 V	102	-18.48	40.57

- REMARKS:**
1. Emission level (dBuV/m) = Raw Value (dBuV) + Correction Factor (dB/m).
 2. Correction Factor (dB/m) = Antenna Factor (dB/m) + Cable Factor (dB).
 3. The other emission levels were very low against the limit.
 4. Margin value = Emission level – Limit value.
 5. The DH5 packet was the worse case duty cycle for a transmit dwell time on a channel, based upon bluetooth theory the transmitter is on 0.625 * 5 per 296.25 ms per channel. Therefore, the duty cycle be equal to: $20\log(3.125/100) = -30.1$ dB.
 6. Average value = peak reading + $20\log(\text{duty cycle})$.



A D T

TEST MODE	A		
MODULATION TYPE	8DPSK	CHANNEL	78
INPUT POWER	3.7Vdc	FREQUENCY RANGE	1 ~ 25GHz
ENVIRONMENTAL CONDITIONS	25 deg. C, 78% RH, 1007hPa	DETECTOR FUNCTION	Peak (PK) Average (AV)
TESTED BY	Chad Lee		

ANTENNA POLARITY & TEST DISTANCE: HORIZONTAL AT 3 M

No.	Freq. (MHz)	Emission Level (dBuV/m)	Limit (dBuV/m)	Margin (dB)	Antenna Height (m)	Table Angle (Degree)	Raw Value (dBuV)	Correction Factor (dB/m)
1	1652.000	44.35 PK	74.00	-29.65	1.00 H	275	13.04	31.31
2	1652.000	40.30 AV	54.00	-13.70	1.00 H	275	8.99	31.31
3	*2480.000	103.31 PK			1.04 H	295	69.61	33.70
4	*2480.000	73.21 AV			1.04 H	295	39.51	33.70
5	2483.500	66.58 PK	74.00	-7.42	1.04 H	295	32.86	33.72
6	2483.500	36.48 AV	54.00	-17.52	1.04 H	295	2.76	33.72
7	4960.000	49.50 PK	74.00	-24.50	1.00 H	198	8.74	40.76
8	4960.000	19.40 AV	54.00	-34.60	1.00 H	198	-21.36	40.76

ANTENNA POLARITY & TEST DISTANCE: VERTICAL AT 3 M

No.	Freq. (MHz)	Emission Level (dBuV/m)	Limit (dBuV/m)	Margin (dB)	Antenna Height (m)	Table Angle (Degree)	Raw Value (dBuV)	Correction Factor (dB/m)
1	1652.000	41.87 PK	74.00	-32.13	1.06 V	184	10.56	31.31
2	1652.000	33.78 AV	54.00	-20.22	1.06 V	184	2.47	31.31
3	*2480.000	94.35 PK			1.00 V	279	60.65	33.70
4	*2480.000	64.25 AV			1.00 V	279	30.55	33.70
5	2483.500	59.99 PK	74.00	-14.01	1.00 V	279	26.27	33.72
6	2483.500	29.89 AV	54.00	-24.11	1.00 V	279	-3.83	33.72
7	4960.000	53.26 PK	74.00	-20.74	1.00 V	79	12.50	40.76
8	4960.000	23.16 AV	54.00	-30.84	1.00 V	79	-17.60	40.76

- REMARKS:**
1. Emission level (dBuV/m) = Raw Value (dBuV) + Correction Factor (dB/m).
 2. Correction Factor (dB/m) = Antenna Factor (dB/m) + Cable Factor (dB).
 3. The other emission levels were very low against the limit.
 4. Margin value = Emission level – Limit value.
 5. The DH5 packet was the worse case duty cycle for a transmit dwell time on a channel, based upon bluetooth theory the transmitter is on 0.625 * 5 per 296.25 ms per channel. Therefore, the duty cycle be equal to: $20\log(3.125/100) = -30.1$ dB.
 6. Average value = peak reading + $20\log(\text{duty cycle})$.



4.3 NUMBER OF HOPPING FREQUENCY USED

4.3.1 LIMIT OF HOPPING FREQUENCY USED

At least 15 channels frequencies, and should be equally spaced.

4.3.2 TEST INSTRUMENTS

DESCRIPTION & MANUFACTURER	MODEL NO.	SERIAL NO.	CALIBRATED DATE	CALIBRATED UNTIL
SPECTRUM ANALYZER	FSP 40	100035	Mar. 26, 2008	Mar. 25, 2009

NOTE: The calibration interval of the above test instruments is 12 months and the calibrations are traceable to NML/ROC and NIST/USA.

4.3.3 TEST PROCEDURES

- a. Check the calibration of the measuring instrument (SA) using either an internal calibrator or a known signal from an external generator.
- b. Turn on the EUT and connect its antenna terminal to measurement via a low loss cable. Then set it to any one measured frequency within its operating range and make sure the instrument is operated in its linear range.
- c. Set the SA on MaxHold Mode, and then keep the EUT in hopping mode. Record all the signals from each channel until each one has been recorded.
- d. Set the SA on View mode and then plot the result on SA screen.
- e. Repeat above procedures until all frequencies measured were complete.

4.3.4 DEVIATION FROM TEST STANDARD

No deviation.

4.3.5 TEST SETUP

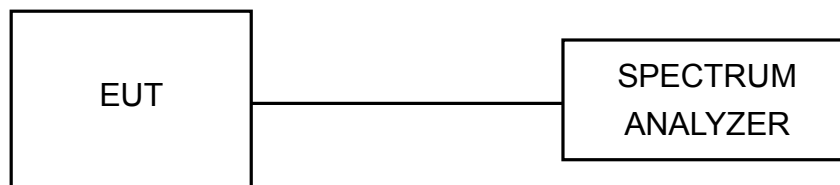

4.3.6 TEST RESULTS

There are 79 hopping frequencies in the hopping mode. Please refer to next two pages for the test result. On the plots, it shows that the hopping frequencies are equally spaced.



A D T

Mode A: FOR GFSK

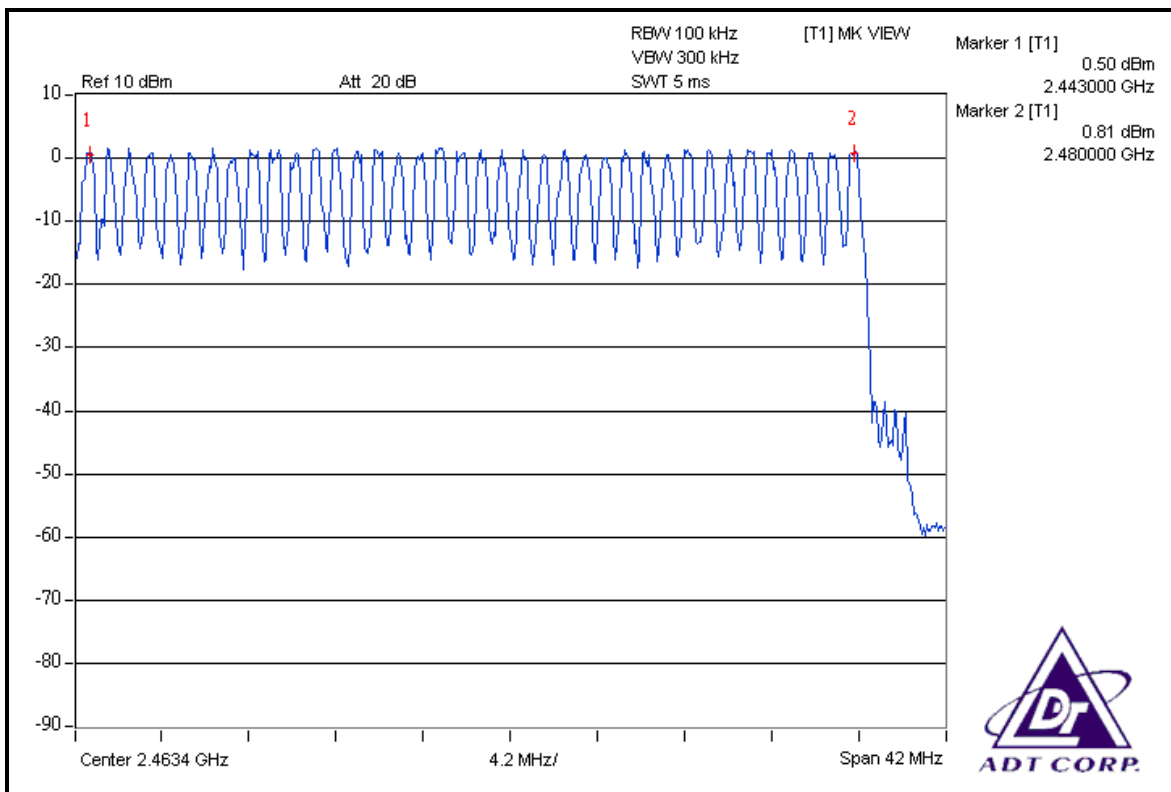
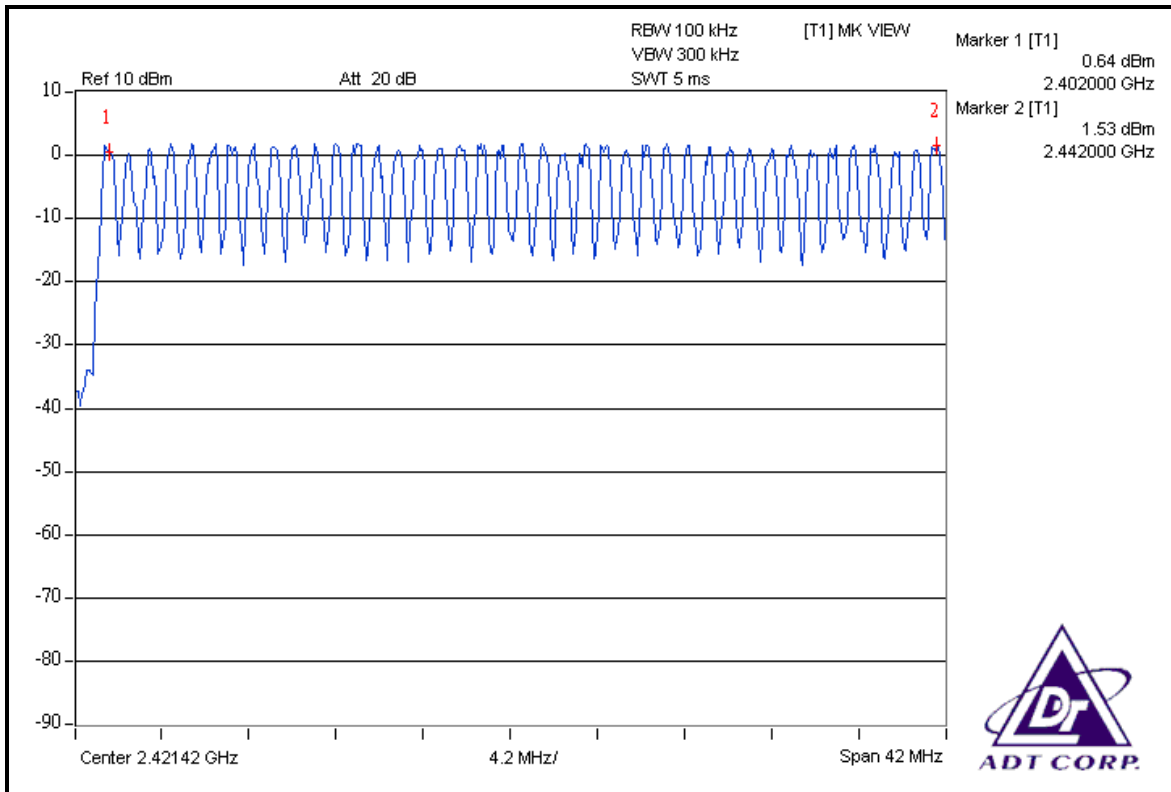



A D T

Mode A: FOR 8DPSK

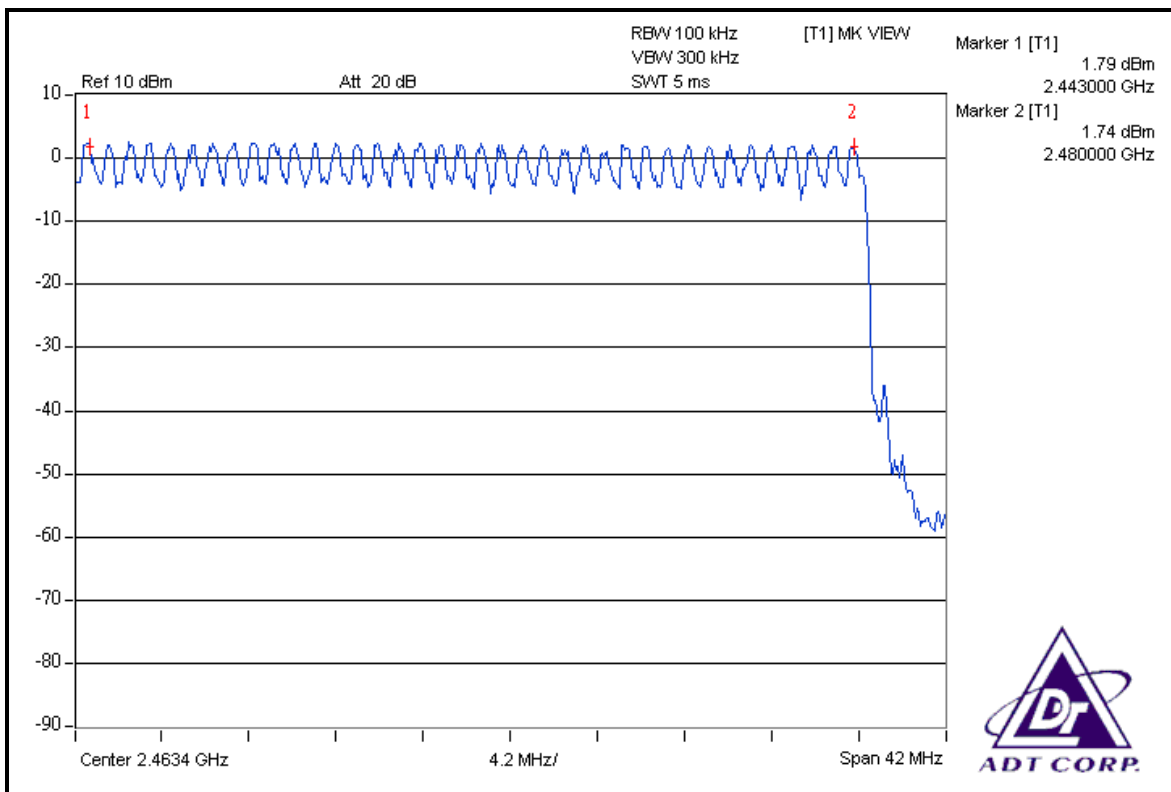
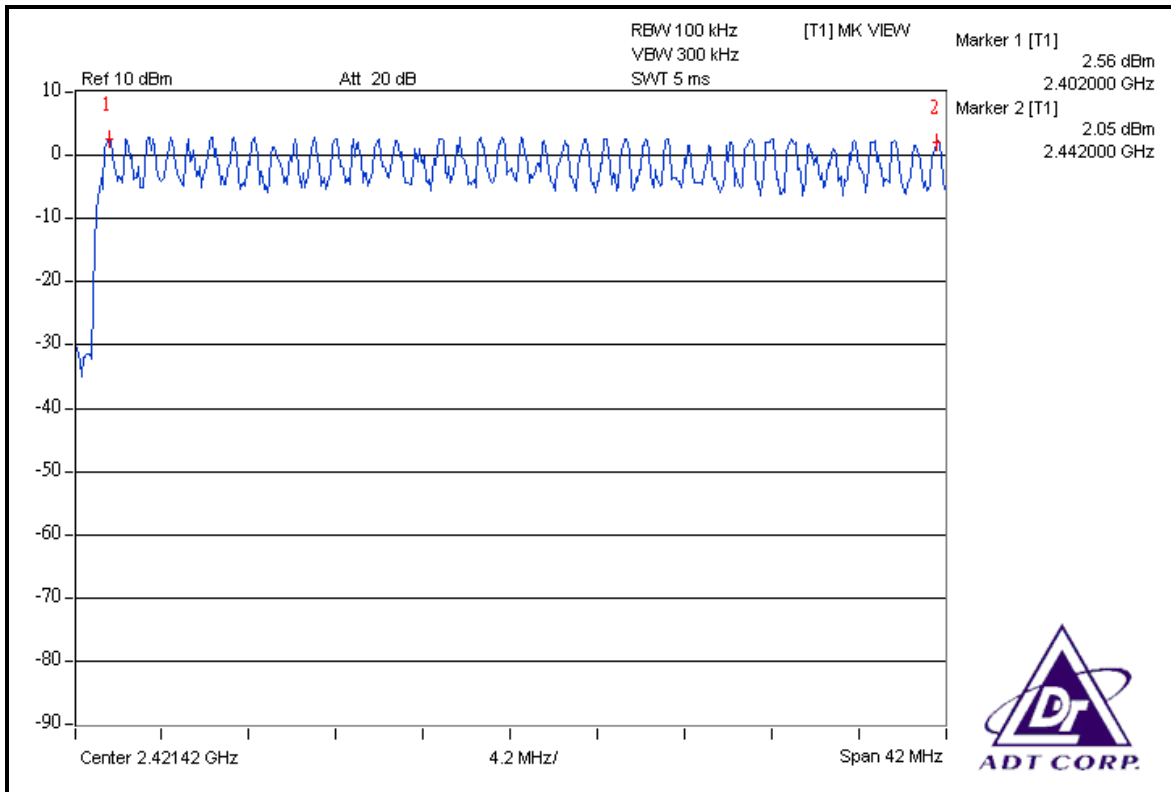

4.4 DWELL TIME ON EACH CHANNEL

4.4.1 LIMIT OF DWELL TIME USED

The average time of occupancy on any channel shall not be greater than 0.4 seconds within a period of 0.4 seconds multiplied by the number of hopping channels employed.

4.4.2 TEST INSTRUMENTS

DESCRIPTION & MANUFACTURER	MODEL NO.	SERIAL NO.	CALIBRATED DATE	CALIBRATED UNTIL
SPECTRUM ANALYZER	FSP 40	100035	Mar. 26, 2008	Mar. 25, 2009

NOTE: The calibration interval of the above test instruments is 12 months and the calibrations are traceable to NML/ROC and NIST/USA.

4.4.3 TEST PROCEDURES

- a. Check the calibration of the measuring instrument (SA) using either an internal calibrator or a known signal from an external generator.
- b. Turn on the EUT and connect its antenna terminal to measurement via a low loss cable. Then set it to any one measured frequency within its operating range and make sure the instrument is operated in its linear range.
- c. Adjust the center frequency of SA on any frequency be measured and set SA to zero span mode. And then, set RBW and VBW of spectrum analyzer to proper value.
- d. Measure the time duration of one transmission on the measured frequency. And then plot the result with time difference of this time duration.
- e. Repeat above procedures until all different time-slot modes have been completed.

4.4.4 DEVIATION FROM TEST STANDARD

No deviation.

4.4.5 TEST SETUP

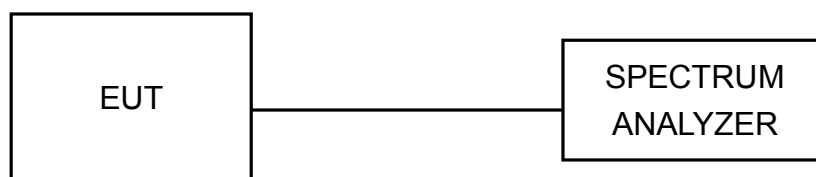

4.4.6 TEST RESULTS

Mode A: FOR GFSK

Mode	Number of transmission in a 31.6 (79Hopping*0.4)	Length of transmission time (msec)	Result (msec)	Limit (msec)
DH1	51 (times / 5 sec) *6.32=322.32 times	0.480	154.7136	400
DH3	25 (times / 5 sec) *6.32=158.00 times	1.716	271.1280	400
DH5	17 (times / 5 sec) *6.32=107.44 times	3.010	323.3944	400

NOTE: Test plots of the transmitting time slot are shown on next 3 pages.



A D T

DH1

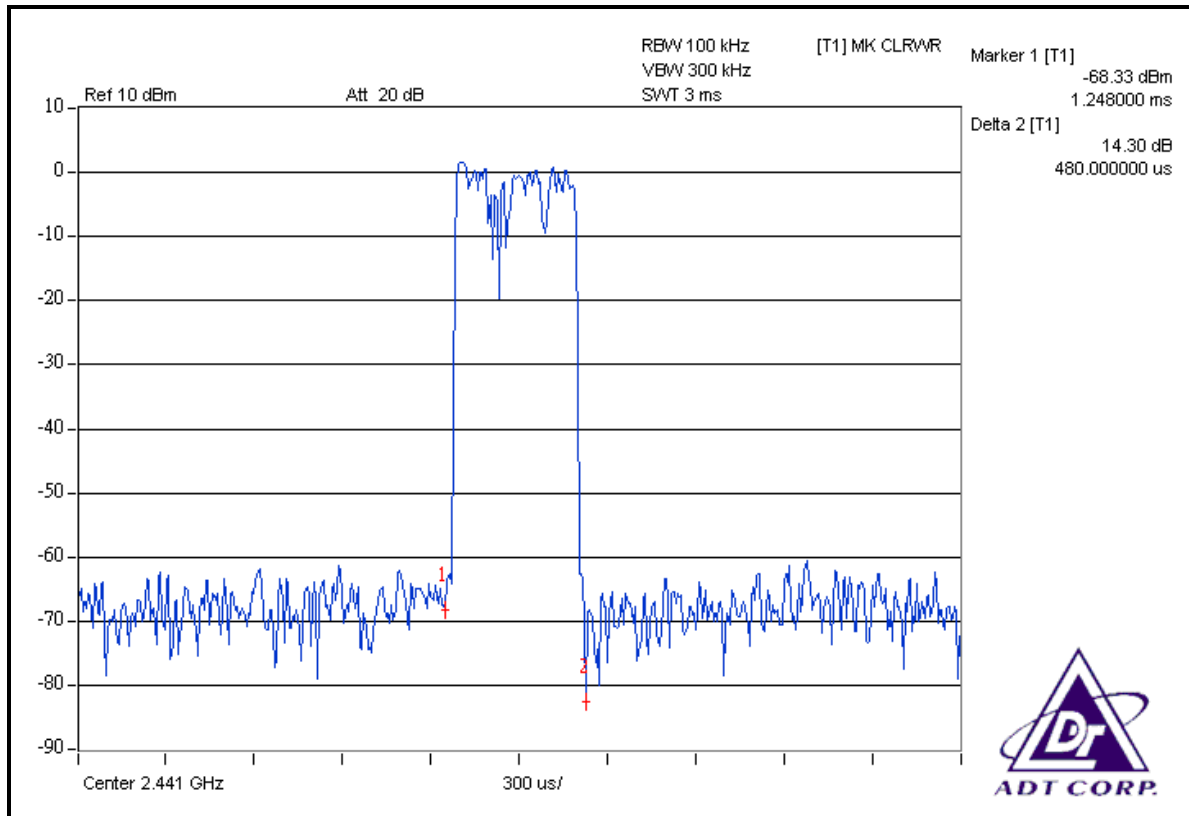
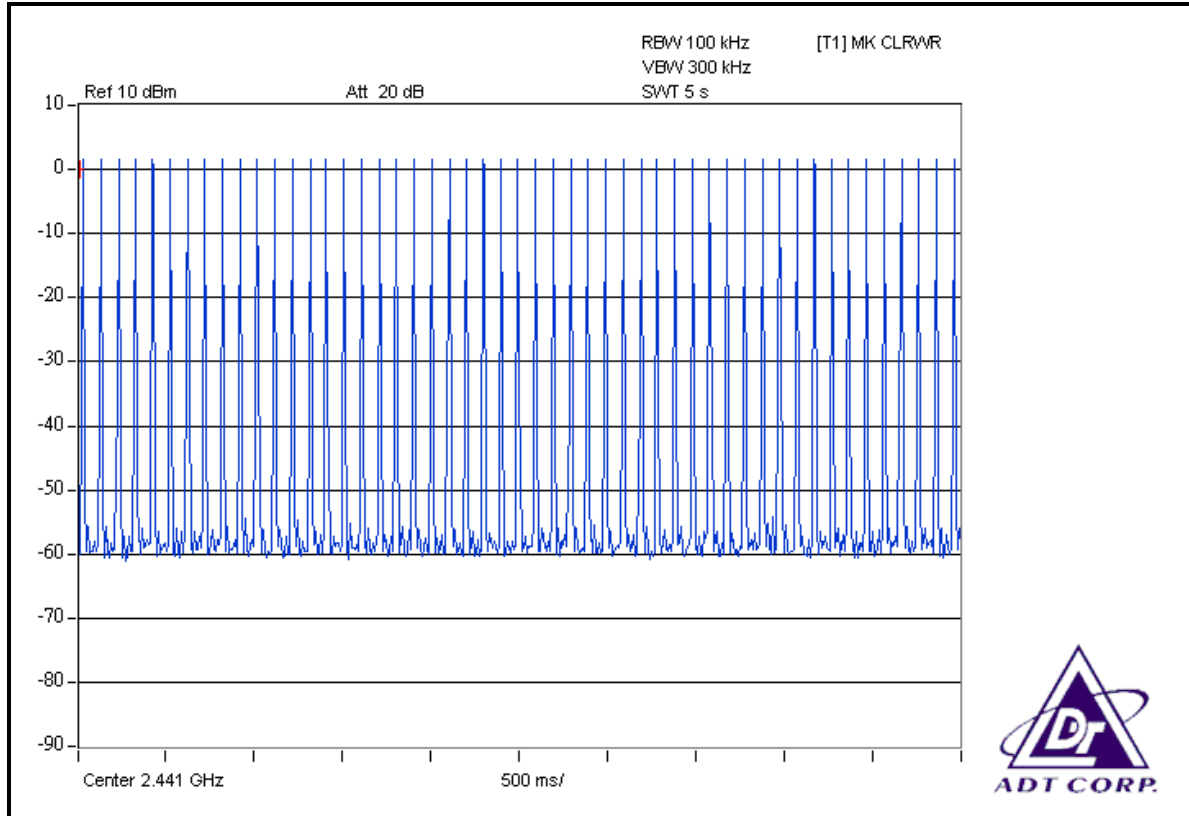



A D T

DH3

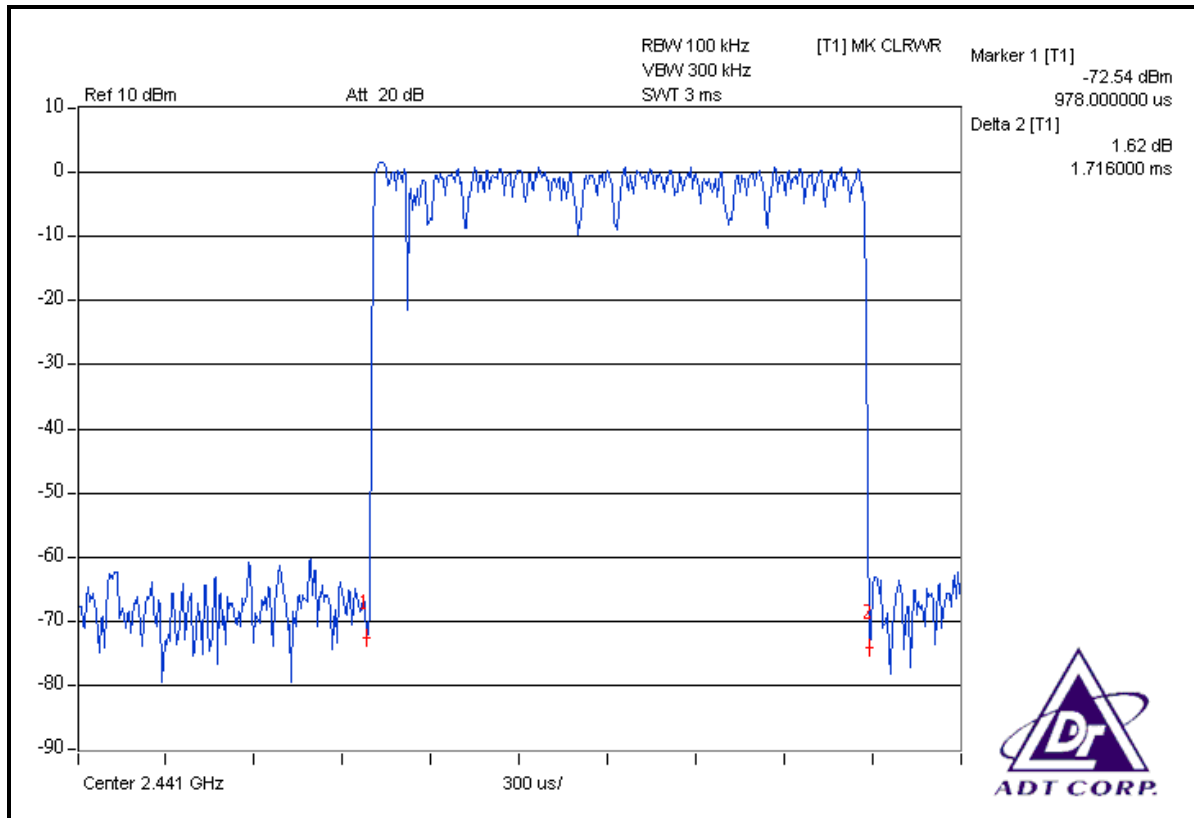
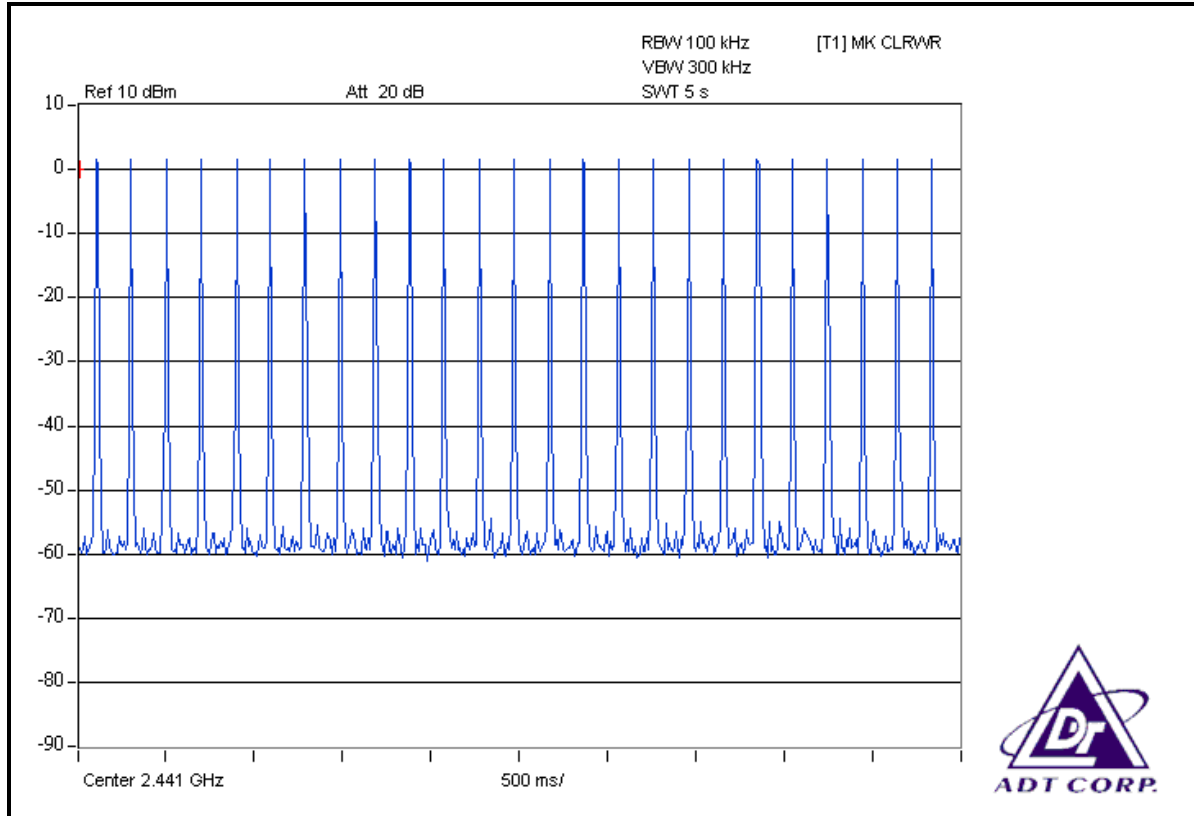



A D T

DH5

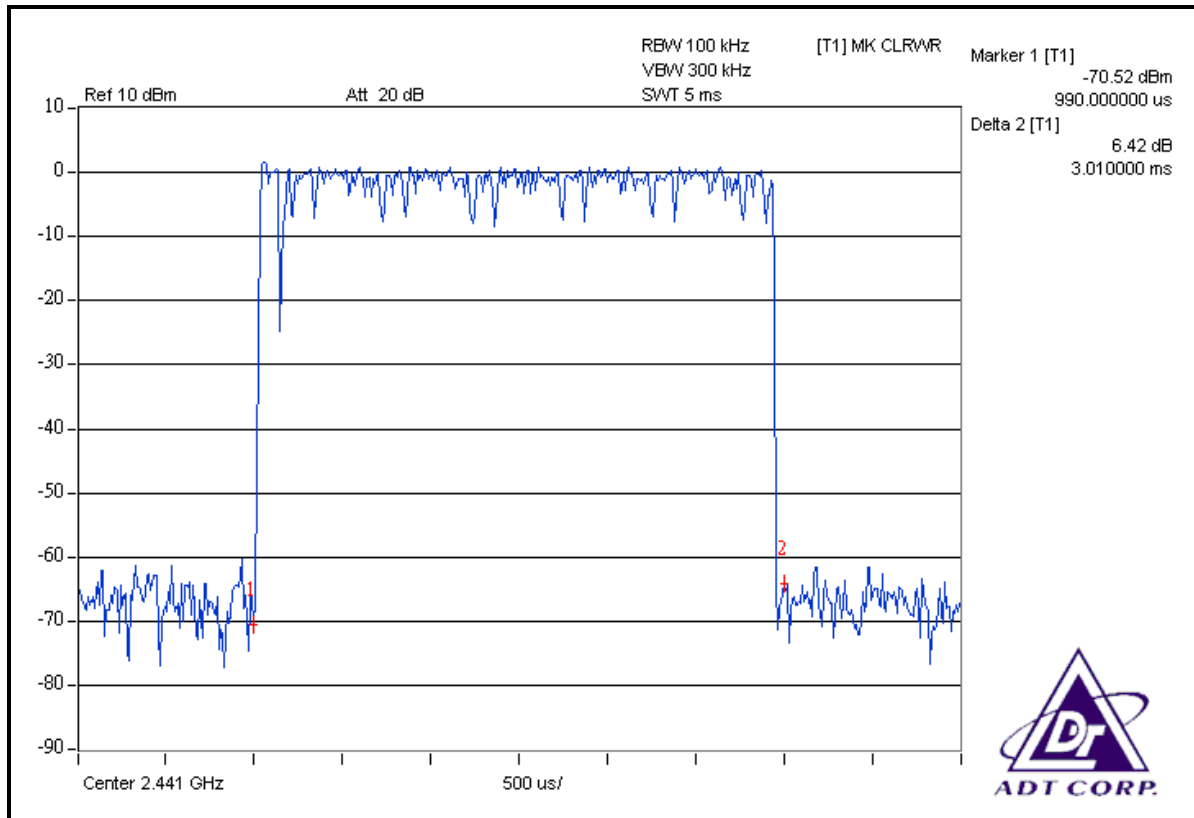
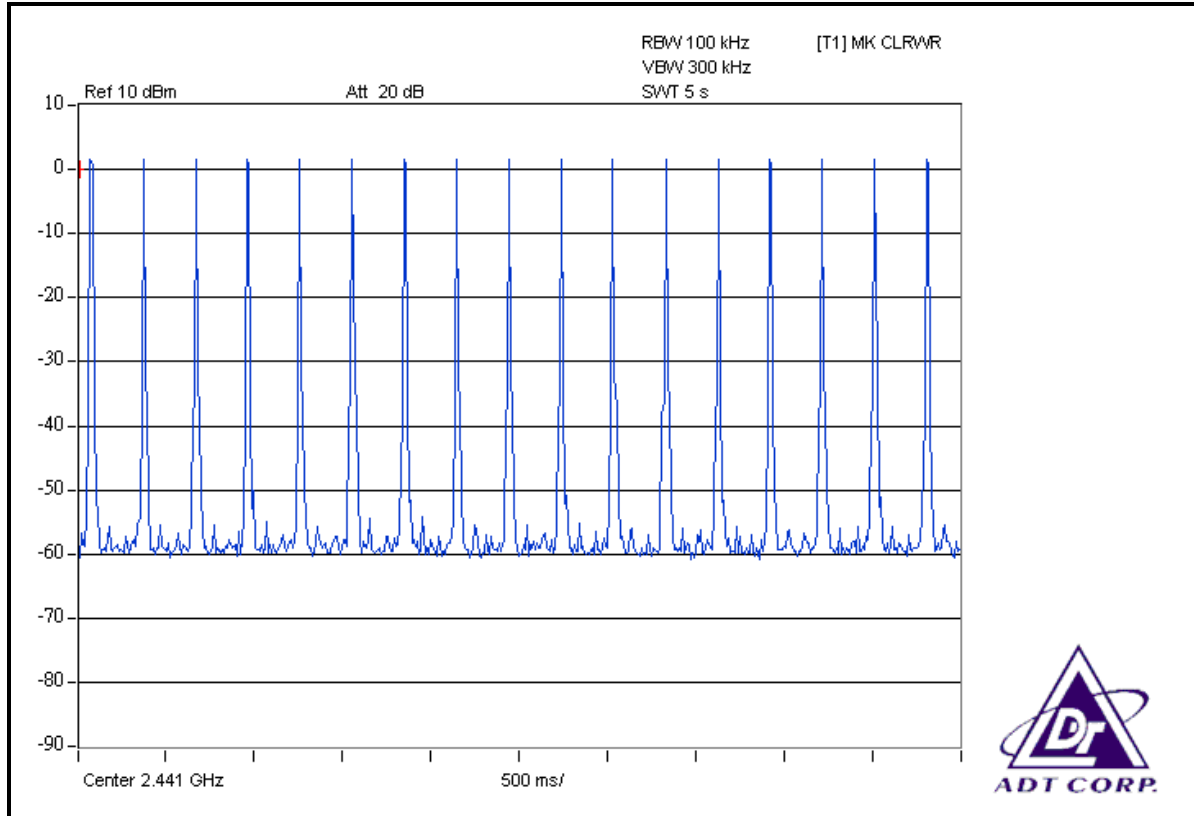



A D T

Mode A: FOR 8DPSK

Mode	Number of transmission in a 31.6 (79Hopping*0.4)	Length of transmission time (msec)	Result (msec)	Limit (msec)
DH1	50 (times / 5 sec) *6.32=316.00times	0.468	147.8880	400
DH3	25 (times / 5 sec) *6.32=158.00 times	1.740	274.9200	400
DH5	17 (times / 5 sec) *6.32=107.44 times	2.970	319.0968	400

NOTE: Test plots of the transmitting time slot are shown on next 3 pages.



A D T

DH1

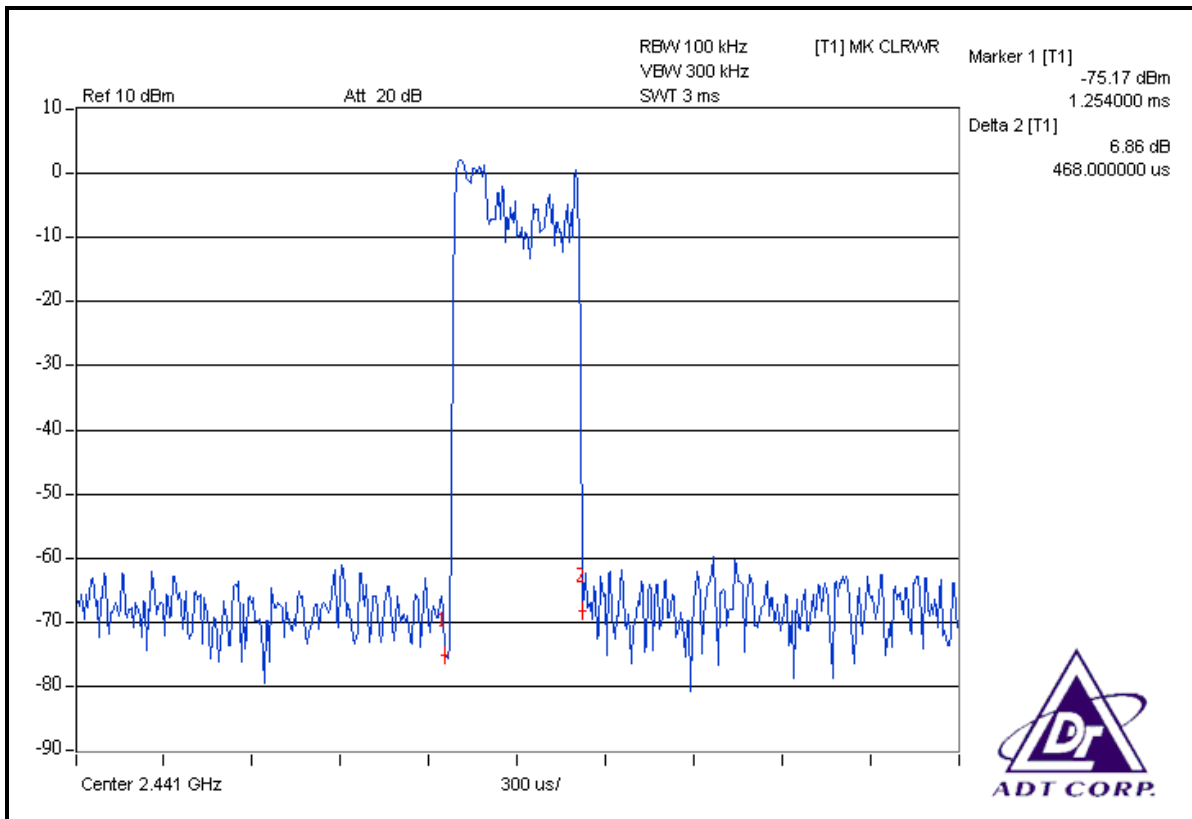
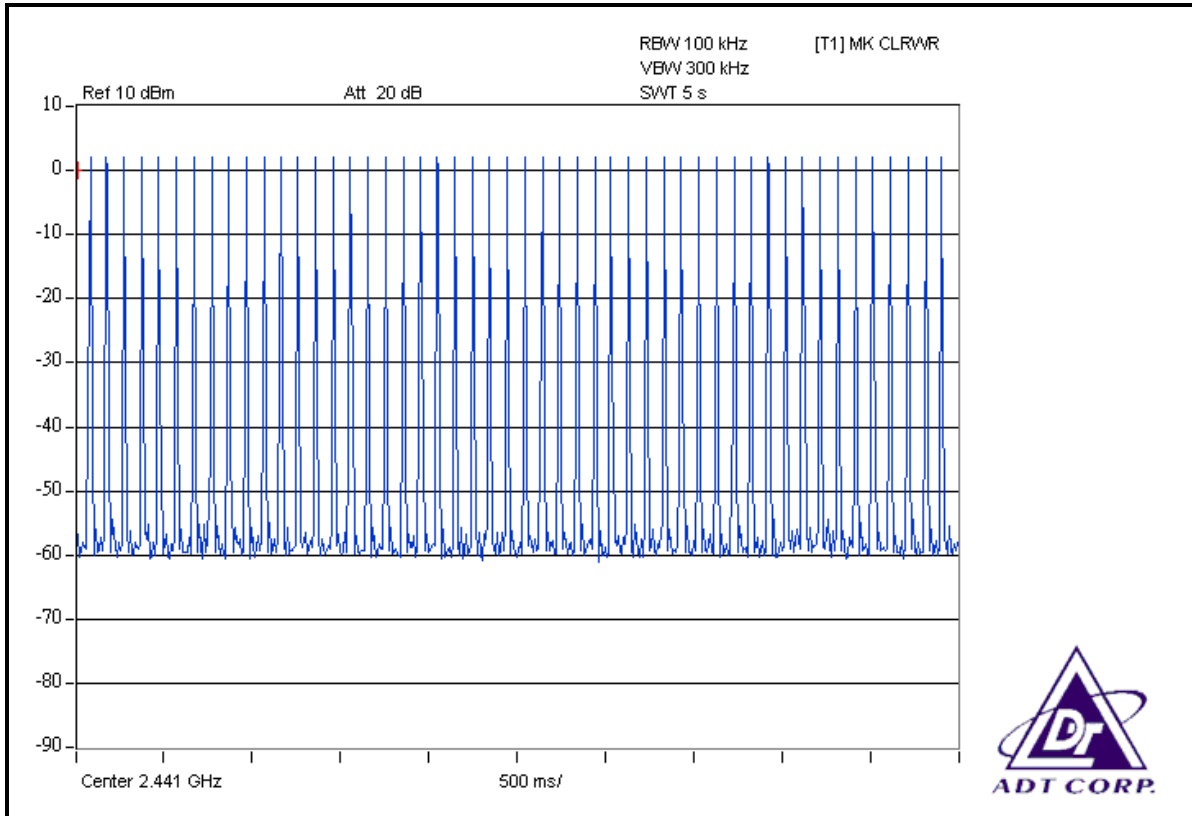



A D T

DH3

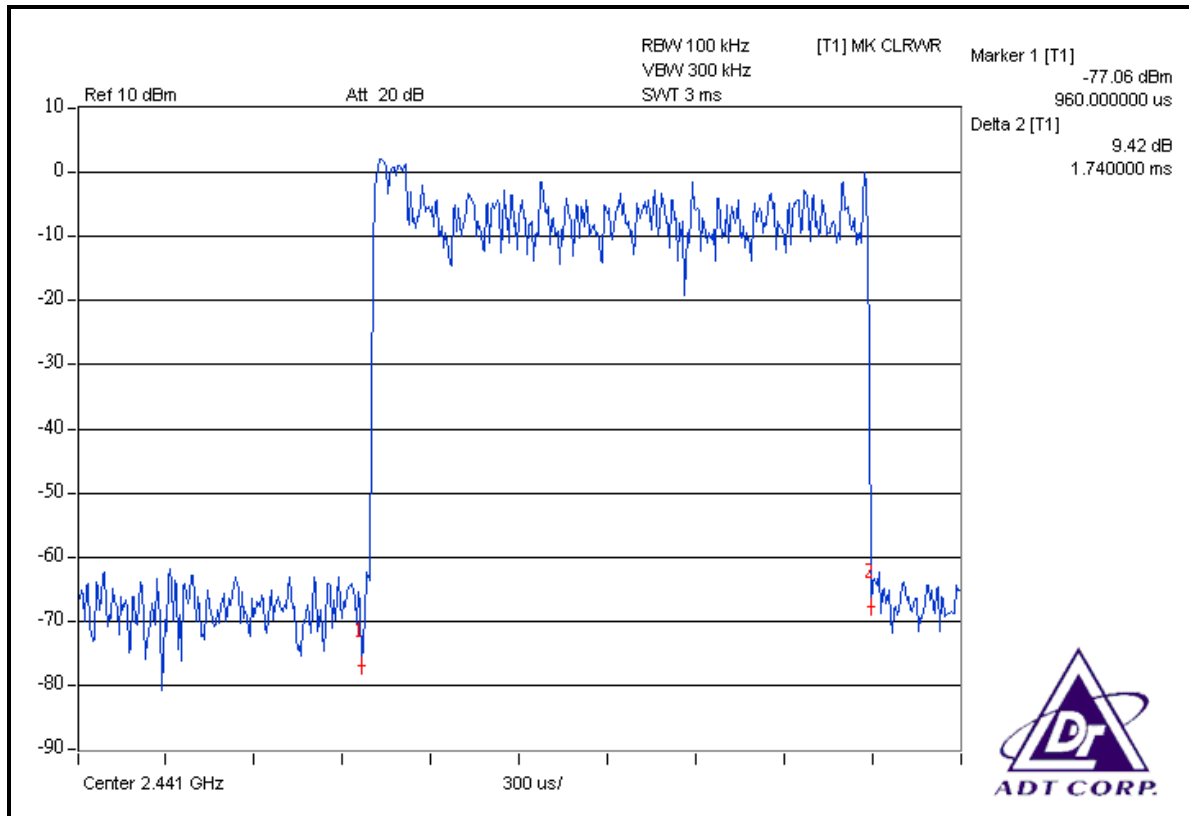
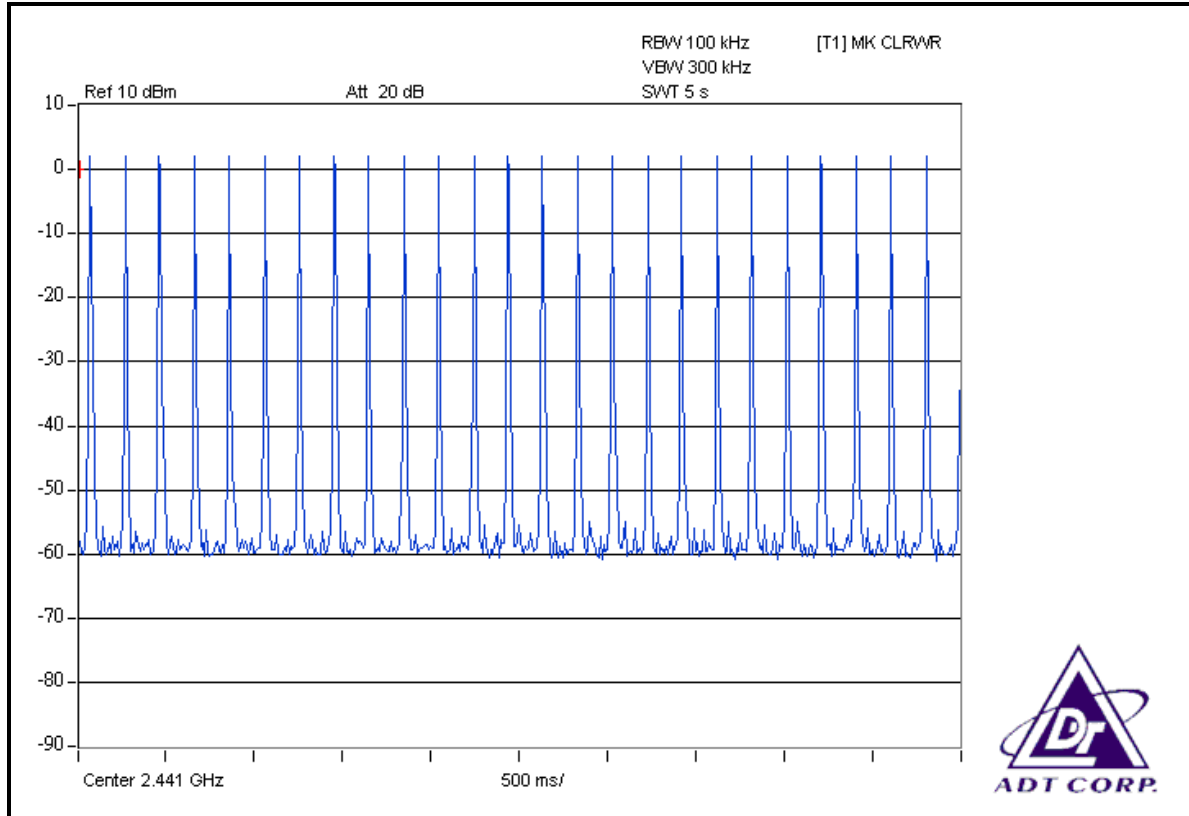



A D T

DH5

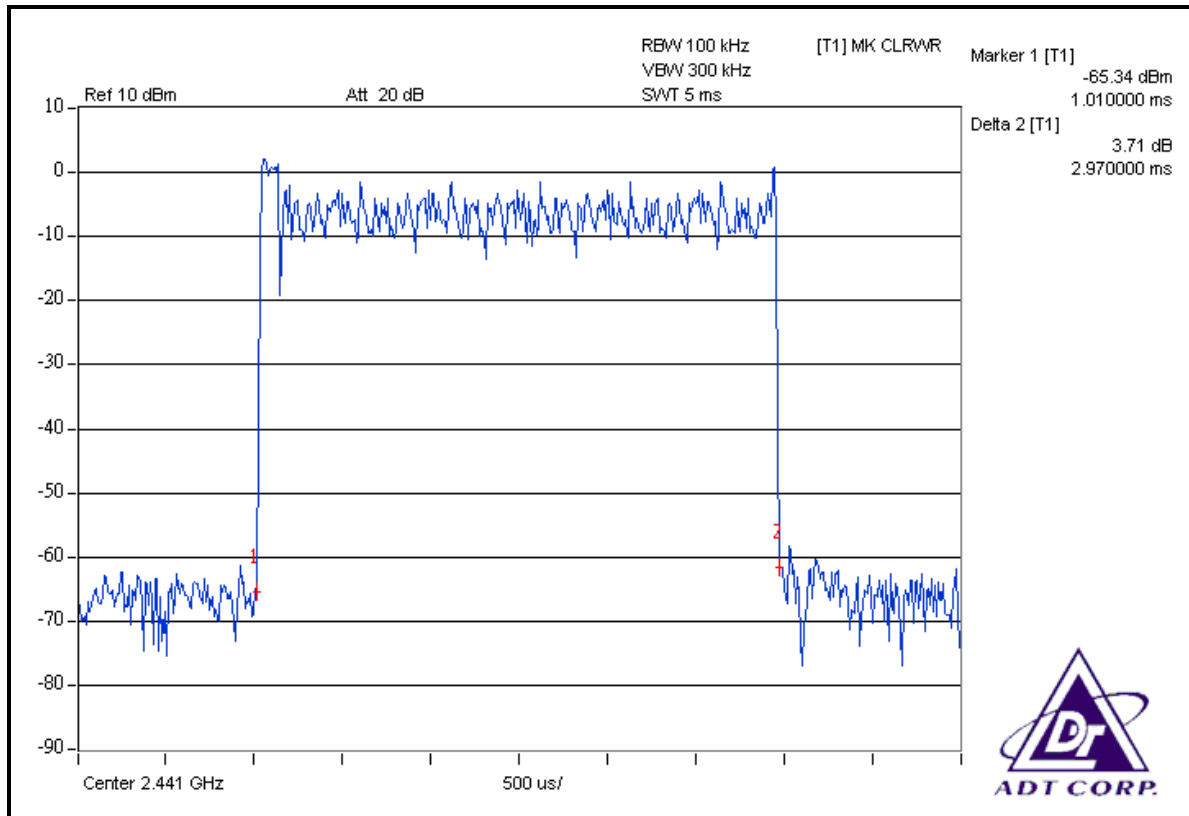
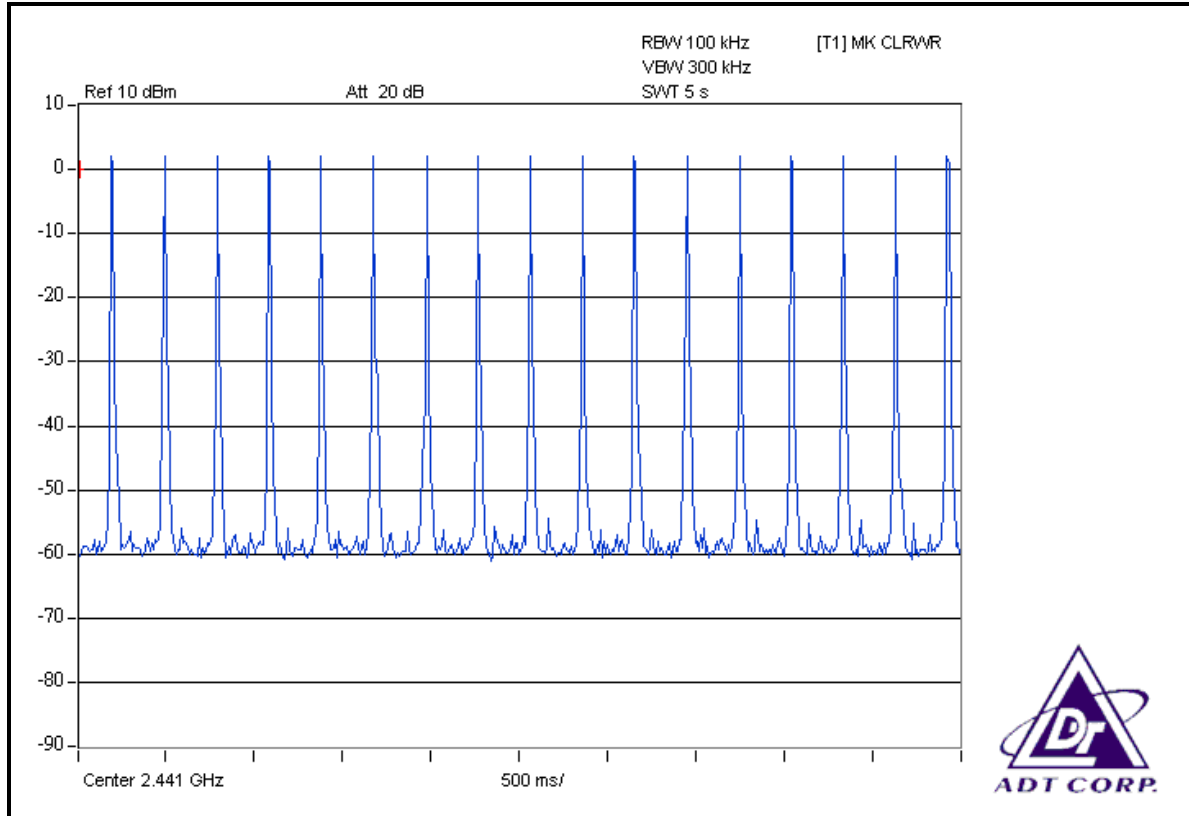

4.5 CHANNEL BANDWIDTH

4.5.1 LIMITS OF CHANNEL BANDWIDTH

For frequency hopping system operating in the 2400-2483.5MHz, If the 20dB bandwidth of hopping channel is greater than 25kHz, two-thirds 20dB bandwidth of hopping channel shall be a minimum limit for the hopping channel separation.

4.5.2 TEST INSTRUMENTS

DESCRIPTION & MANUFACTURER	MODEL NO.	SERIAL NO.	CALIBRATED DATE	CALIBRATED UNTIL
SPECTRUM ANALYZER	FSP 40	100035	Mar. 26, 2008	Mar. 25, 2009

NOTE: The calibration interval of the above test instruments is 12 months and the calibrations are traceable to NML/ROC and NIST/USA.

4.5.3 TEST PROCEDURE

- a. Check the calibration of the measuring instrument using either an internal calibrator or a known signal from an external generator.
- b. Turn on the EUT and connect it to measurement instrument. Then set it to any one convenient frequency within its operating range. Set a reference level on the measuring instrument equal to the highest peak value.
- c. Measure the frequency difference of two frequencies that were attenuated 20dB from the reference level. Record the frequency difference as the emission bandwidth.
- d. Repeat above procedures until all frequencies measured were complete.

4.5.4 DEVIATION FROM TEST STANDARD

No deviation.

4.5.5 TEST SETUP

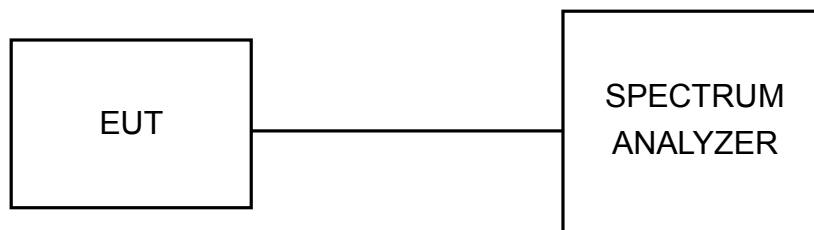

4.5.6 EUT OPERATING CONDITION

The software provided by client enabled the EUT to transmit and receive data at lowest, middle and highest channel frequencies individually.



A D T

4.5.7 TEST RESULTS

FOR GFSK

TEST MODE	A		
MODULATION TYPE	GFSK	CHANNEL	0, 39, 78
INPUT POWER	3.7Vdc	ENVIRONMENTAL CONDITIONS	25deg. C, 74% RH, 1007hPa
TESTED BY	Jun Wu		

CHANNEL	CHANNEL FREQUENCY (MHz)	20dB BANDWIDTH (MHz)
0	2402	0.834
39	2441	0.839
78	2480	0.843

CH 0

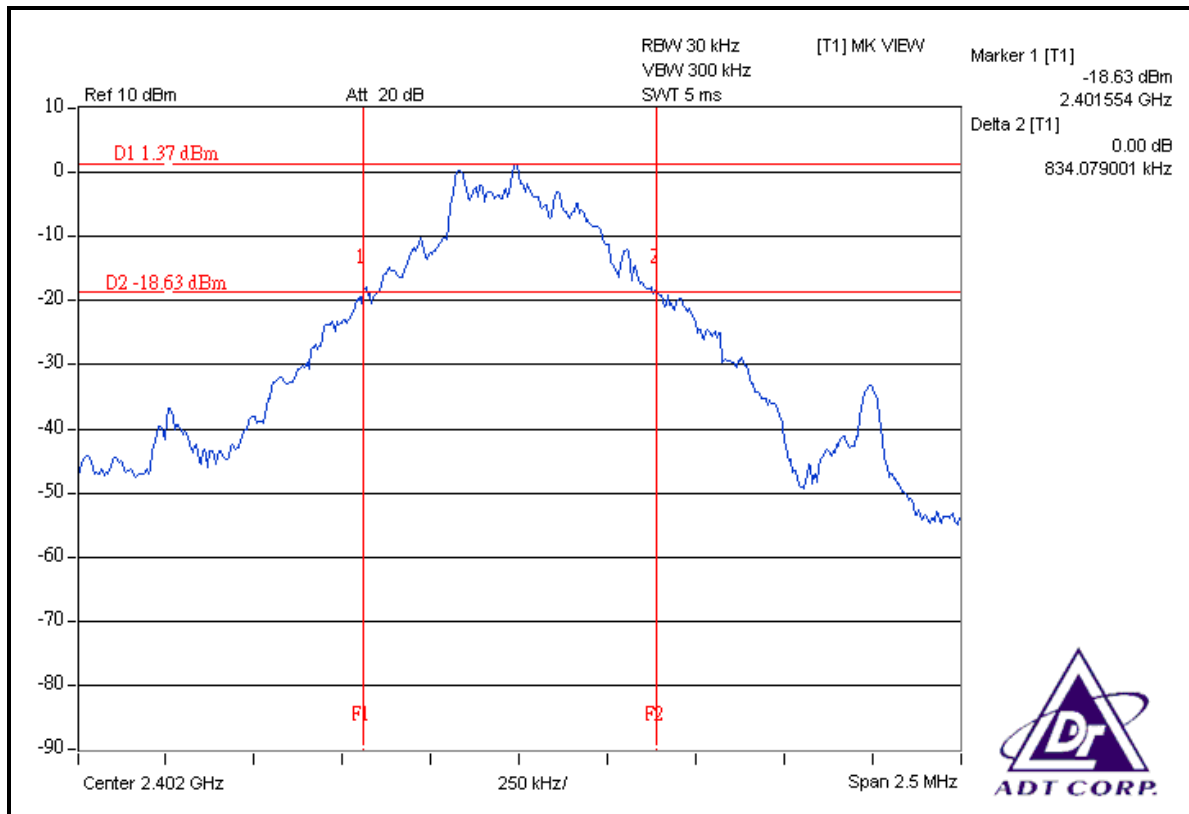



A D T

CH 39



CH 78

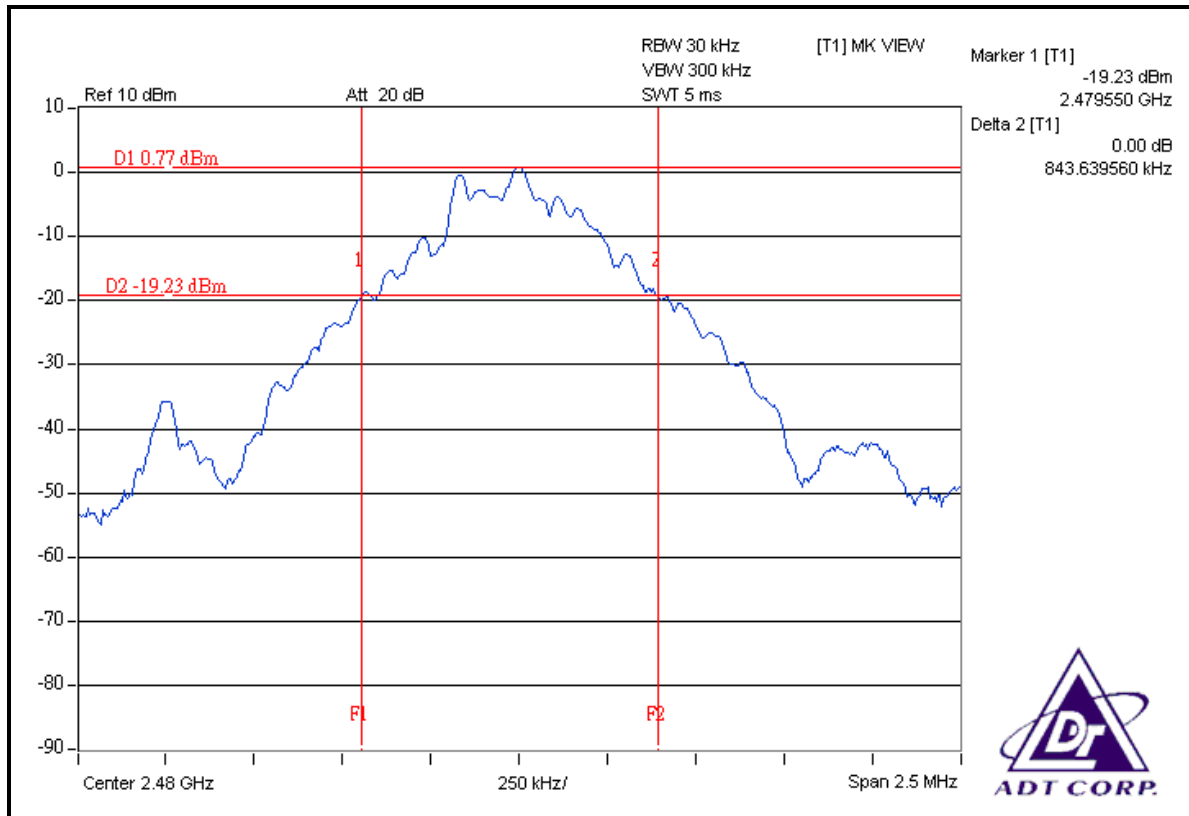



A D T

FOR 8DPSK

TEST MODE	A		
MODULATION TYPE	8DPSK	CHANNEL	0, 39, 78
INPUT POWER	3.7Vdc	ENVIRONMENTAL CONDITIONS	25deg. C, 74% RH, 1007hPa
TESTED BY	Jun Wu		

CHANNEL	CHANNEL FREQUENCY (MHz)	20dB BANDWIDTH (MHz)
0	2402	1.217
39	2441	1.223
78	2480	1.212

CH 0





A D T

CH 39

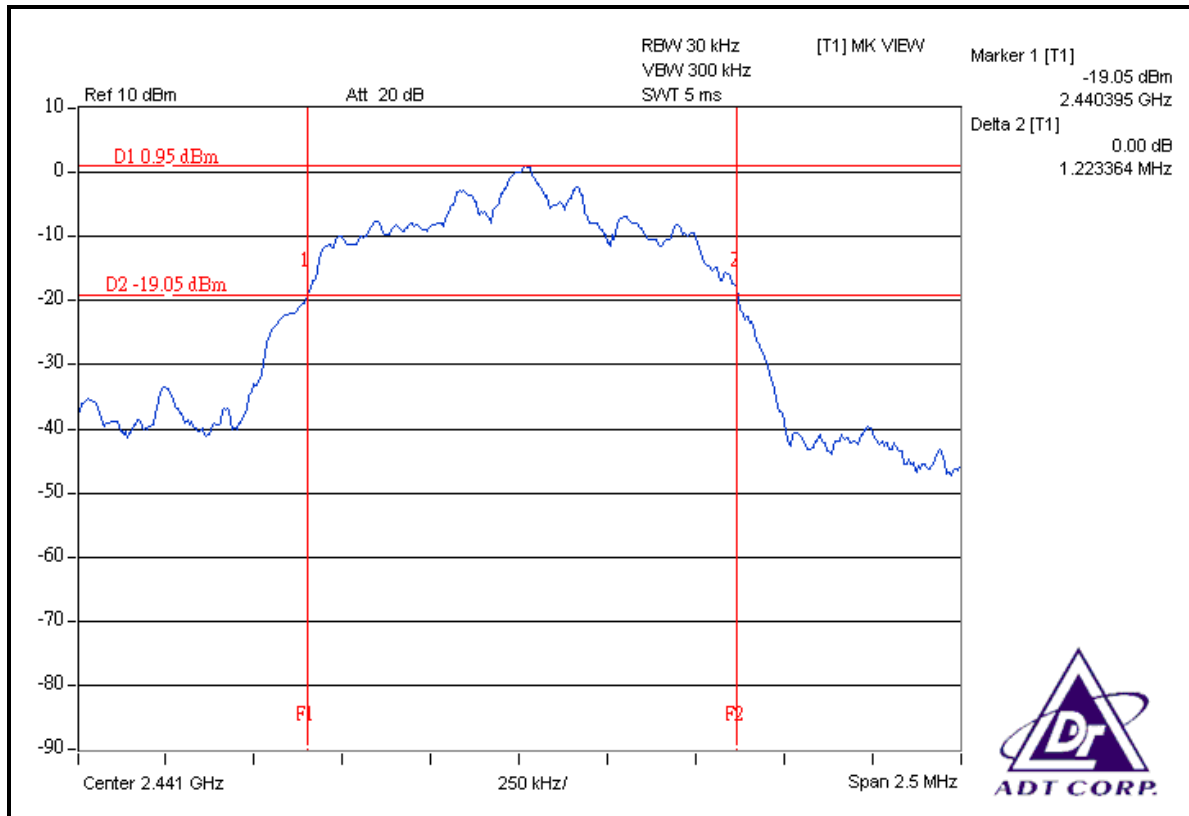

CH 78

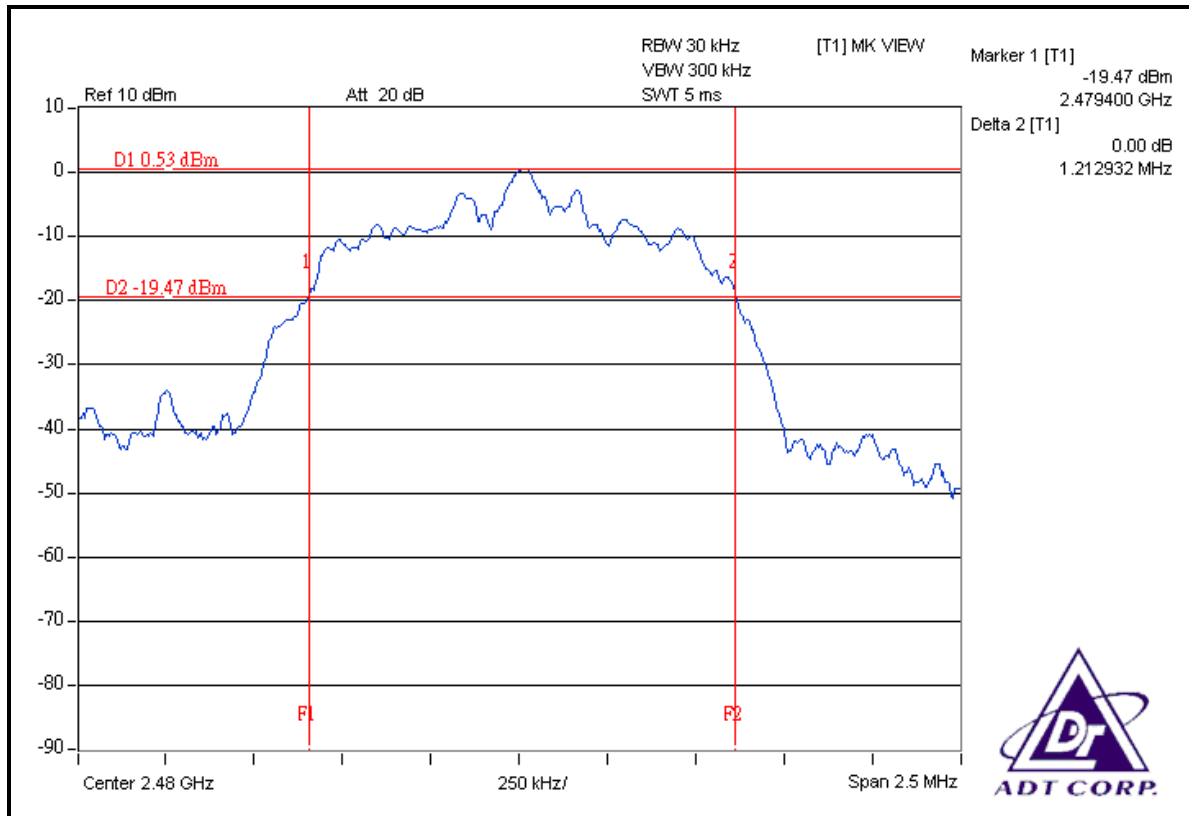

4.6 HOPPING CHANNEL SEPARATION

4.6.1 LIMIT OF HOPPING CHANNEL SEPARATION

At least 25kHz or two-third of 20dB hopping channel bandwidth (whichever is greater).

4.6.2 TEST INSTRUMENTS

DESCRIPTION & MANUFACTURER	MODEL NO.	SERIAL NO.	CALIBRATED DATE	CALIBRATED UNTIL
SPECTRUM ANALYZER	FSP 40	100035	Mar. 26, 2008	Mar. 25, 2009

NOTE: The calibration interval of the above test instruments is 12 months and the calibrations are traceable to NML/ROC and NIST/USA.

4.6.3 TEST PROCEDURES

1. Check the calibration of the measuring instrument using either an internal calibrator or a known signal from an external generator.
2. Turn on the EUT and connect it to measurement instrument. Then set it to any one convenient frequency within its operating range.
3. By using the MaxHold function record the separation of two adjacent channels.
4. Measure the frequency difference of these two adjacent channels by SA MARK function. And then plot the result on SA screen.
5. Repeat above procedures until all frequencies measured were complete.

4.6.4 DEVIATION FROM TEST STANDARD

No deviation.

4.6.5 TEST SETUP

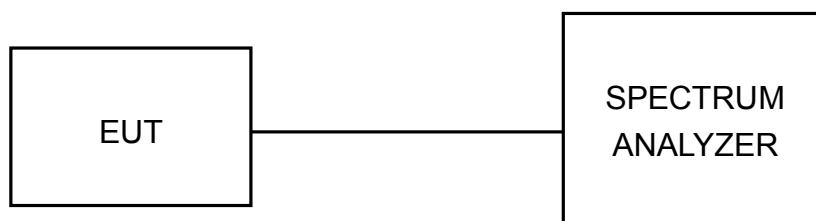

4.6.6 TEST RESULTS

FOR GFSK

TEST MODE	A		
MODULATION TYPE	GFSK	CHANNEL	0, 39, 78
INPUT POWER	3.7Vdc	ENVIRONMENTAL CONDITIONS	25deg. C, 74% RH, 1007hPa
TESTED BY	Jun Wu		

CHANNEL	FREQUENCY (MHz)	ADJACENT CHANNEL SEPARATION (MHz)	20dB BANDWIDTH (MHz)	MINIMUM LIMIT (MHz)	PASS / FAIL
0	2402	1.003	0.834	0.556	PASS
39	2441	1.002	0.839	0.559	PASS
78	2480	1.005	0.843	0.562	PASS

NOTE: The minimum limit is two-third 20dB bandwidth. Test results please refer to following three plots.



A D T

CH 0

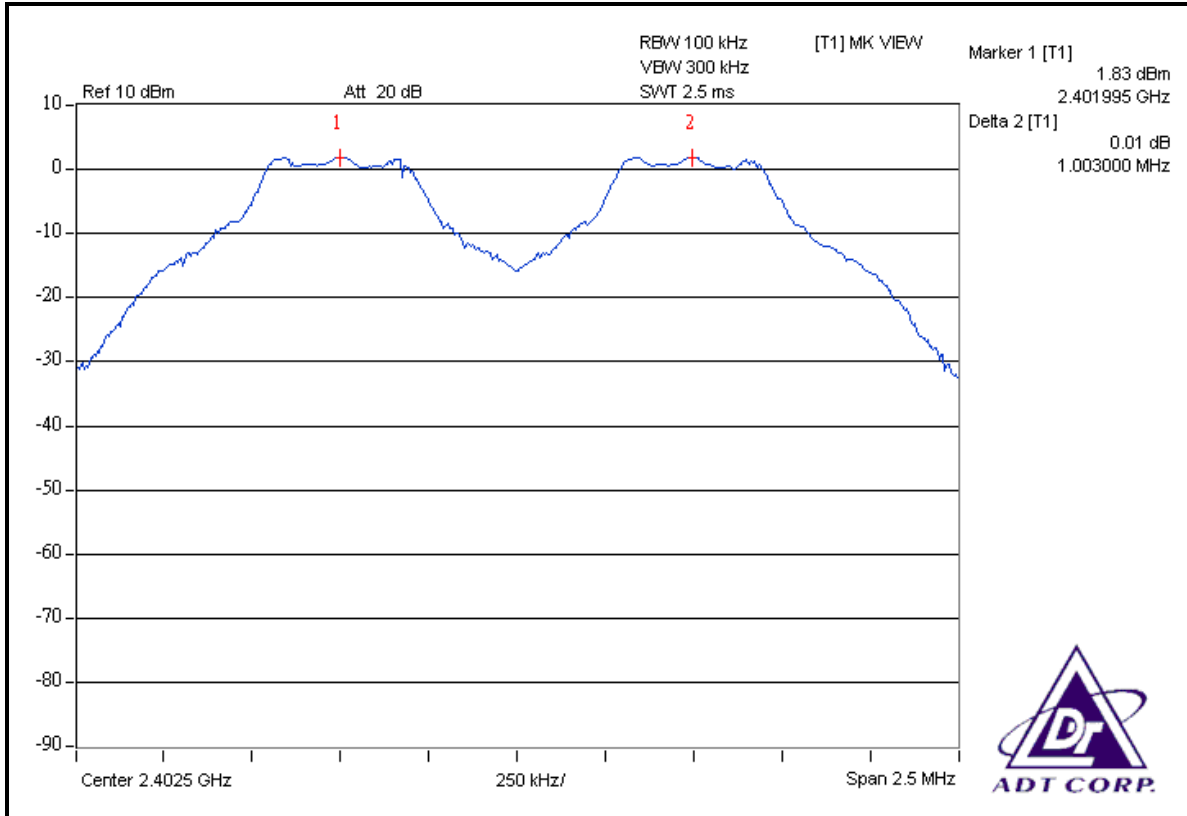

CH 39

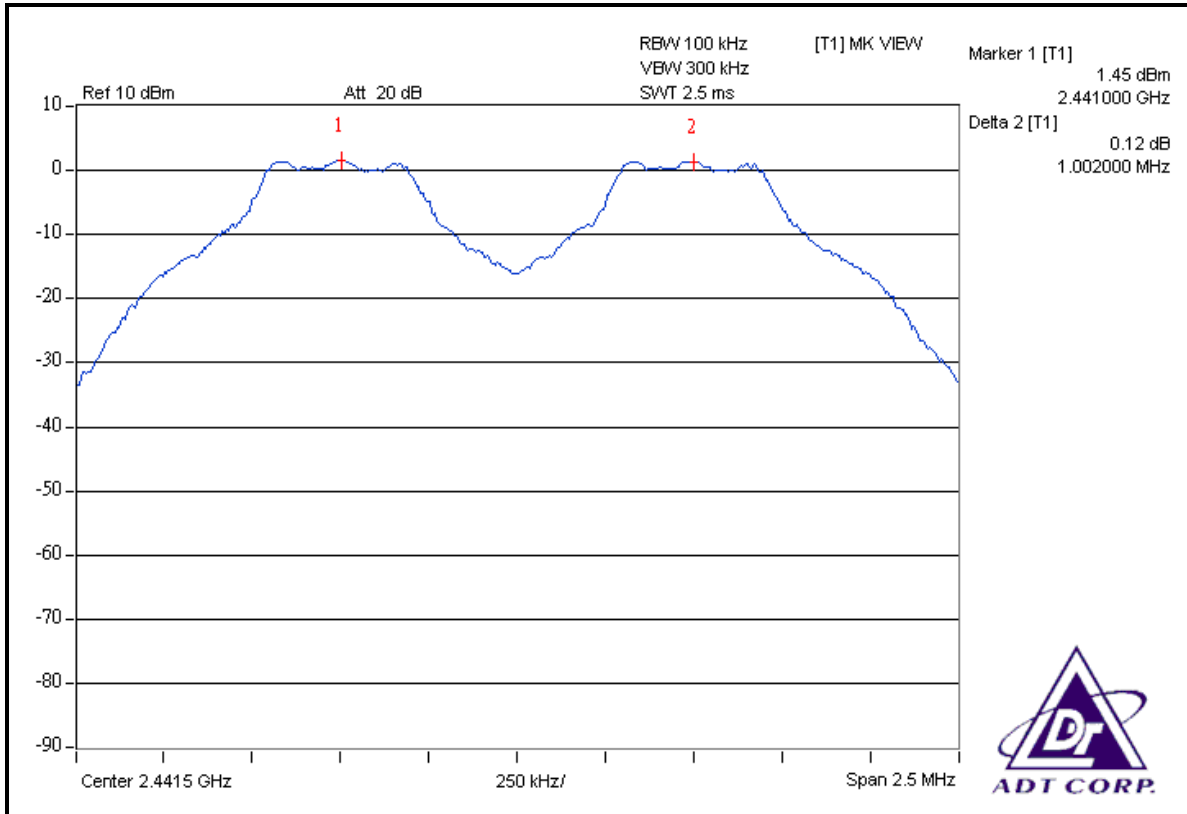



A D T

CH 78

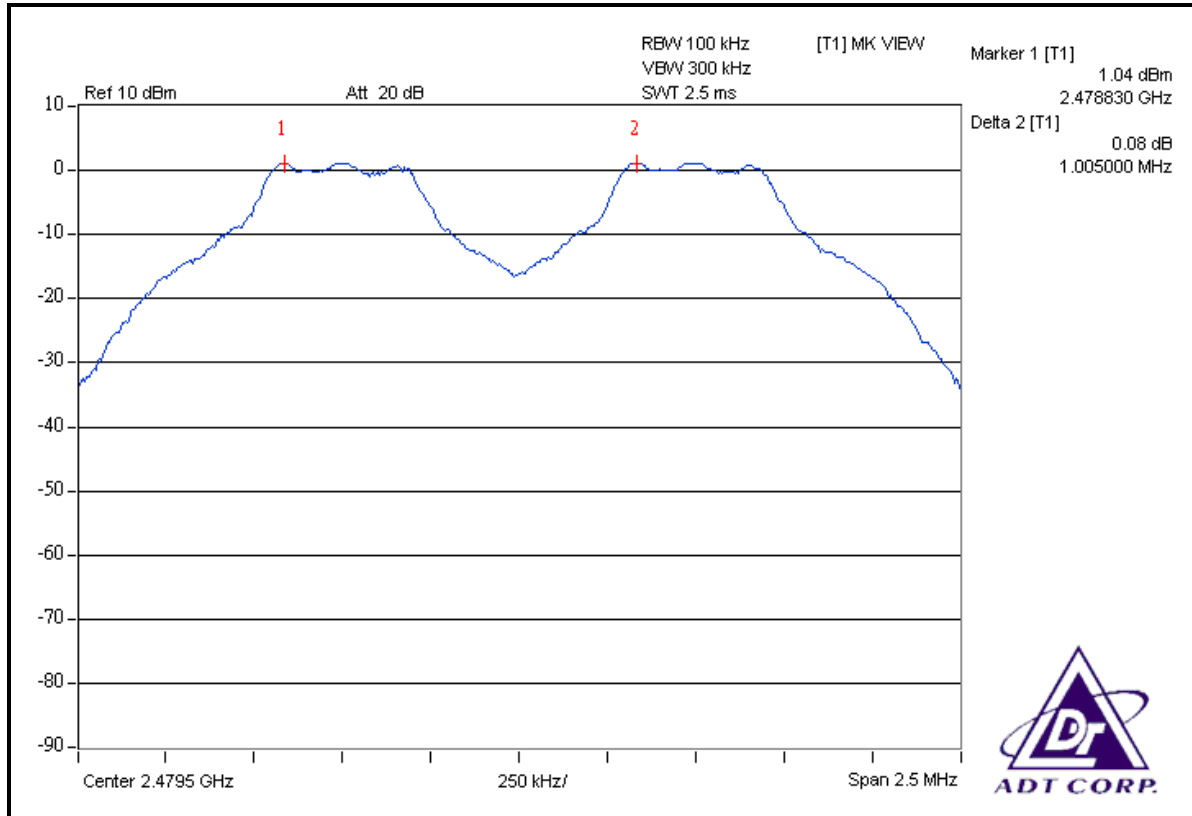



A D T

FOR 8DPSK

TEST MODE	A		
MODULATION TYPE	8DPSK	CHANNEL	0, 39, 78
INPUT POWER	3.7Vdc	ENVIRONMENTAL CONDITIONS	25deg. C, 74% RH, 1007hPa
TESTED BY	Jun Wu		

CHANNEL	FREQUENCY (MHz)	ADJACENT CHANNEL SEPARATION (MHz)	20dB BANDWIDTH (MHz)	MINIMUM LIMIT (MHz)	PASS / FAIL
0	2402	1.006	1.217	0.811	PASS
39	2441	1.000	1.223	0.815	PASS
78	2480	1.002	1.212	0.808	PASS

NOTE: The minimum limit is two-third 20dB bandwidth. Test results please refer to following three plots.

CH 0

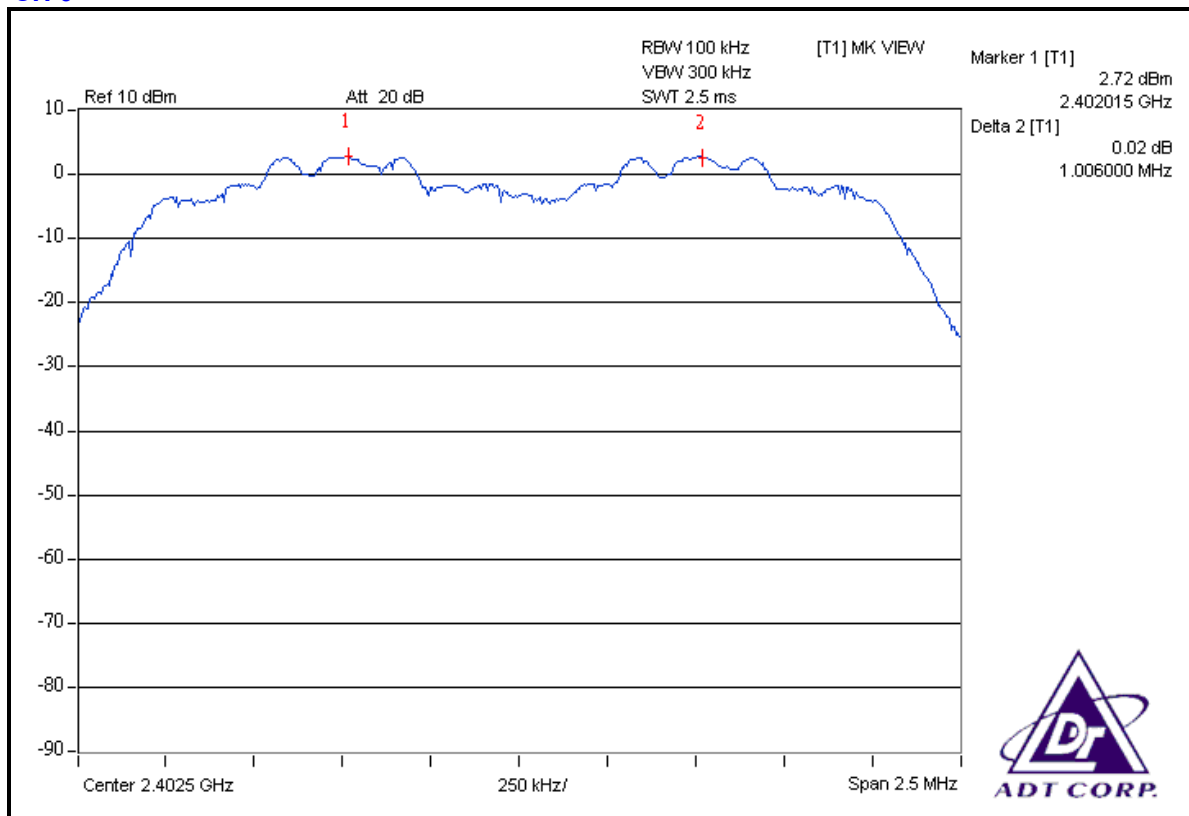



A D T

CH 39

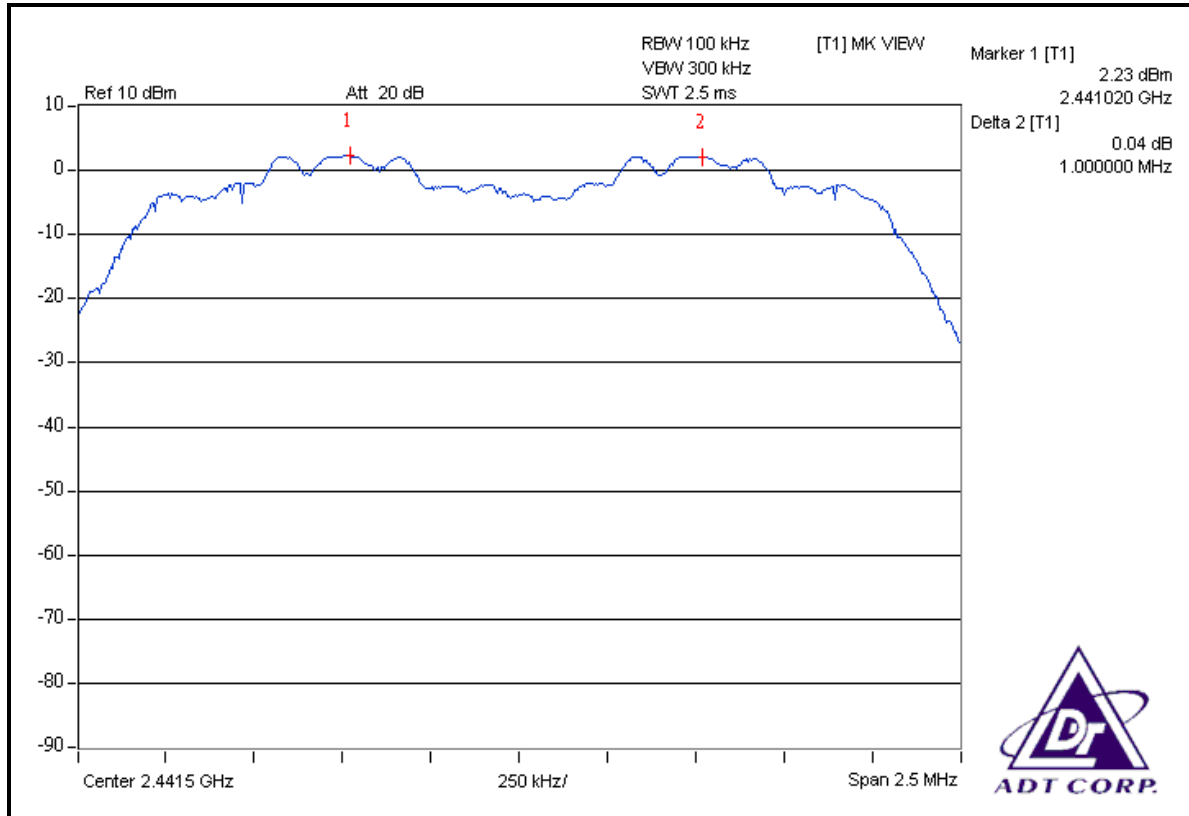

CH 78

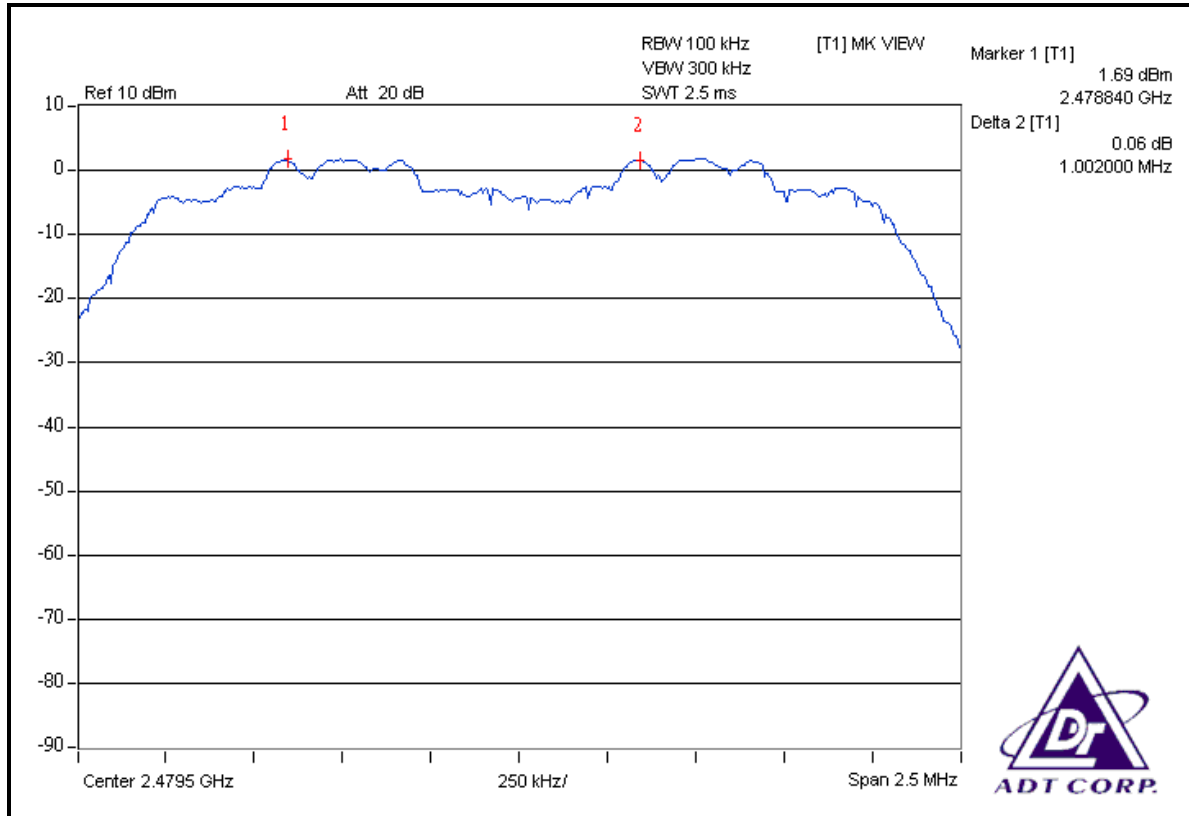



4.7 MAXIMUM PEAK OUTPUT POWER

4.7.1 LIMITS OF MAXIMUM PEAK OUTPUT POWER MEASUREMENT

The Maximum Peak Output Power Measurement is 125mW.

4.7.2 TEST INSTRUMENTS

DESCRIPTION & MANUFACTURER	MODEL NO.	SERIAL NO.	CALIBRATED DATE	CALIBRATED UNTIL
SPECTRUM ANALYZER	FSP 40	100035	Mar. 26, 2008	Mar. 25, 2009

NOTE: The calibration interval of the above test instruments is 12 months and the calibrations are traceable to NML/ROC and NIST/USA.

4.7.3 TEST PROCEDURES

- a. Check the calibration of the measuring instrument using either an internal calibrator or a known signal from an external generator.
- b. Turn on the EUT and connect it to measurement instrument. Then set it to any one convenient frequency within its operating range. Set a reference level on the measuring instrument equal to the highest peak value.
- c. The center frequency of the spectrum analyzer is set to the fundamental frequency and using 3MHz RBW and 10 MHz VBW.
- d. Measure the captured power within the band and recording the plot.
- e. Repeat above procedures until all frequencies required were complete.

4.7.4 DEVIATION FROM TEST STANDARD

No deviation



4.7.5 TEST SETUP

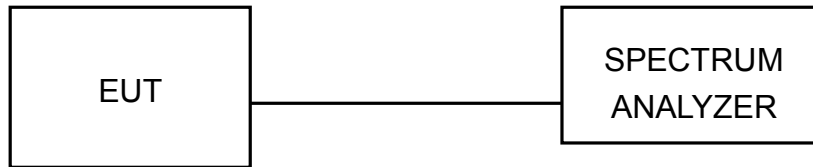

For the actual test configuration, please refer to the related Item – Photographs of the Test Configuration.

4.7.6 EUT OPERATING CONDITION

The software provided by client enabled the EUT to transmit and receive data at lowest, middle and highest channel frequencies individually.

4.7.7 TEST RESULTS

FOR GFSK

TEST MODE	A		
MODULATION TYPE	GFSK	CHANNEL	0, 39, 78
INPUT POWER	3.7Vdc	ENVIRONMENTAL CONDITIONS	25deg. C, 74% RH, 1007hPa
TESTED BY	Jun Wu		

CHANNEL	CHANNEL FREQUENCY (MHz)	PEAK POWER OUTPUT (dBm)	PEAK POWER OUTPUT (mW)	PEAK POWER LIMIT (mW)	PASS/FAIL
0	2402	1.52	1.419	125	PASS
39	2441	1.15	1.303	125	PASS
78	2480	0.81	1.205	125	PASS



A D T

CH 0

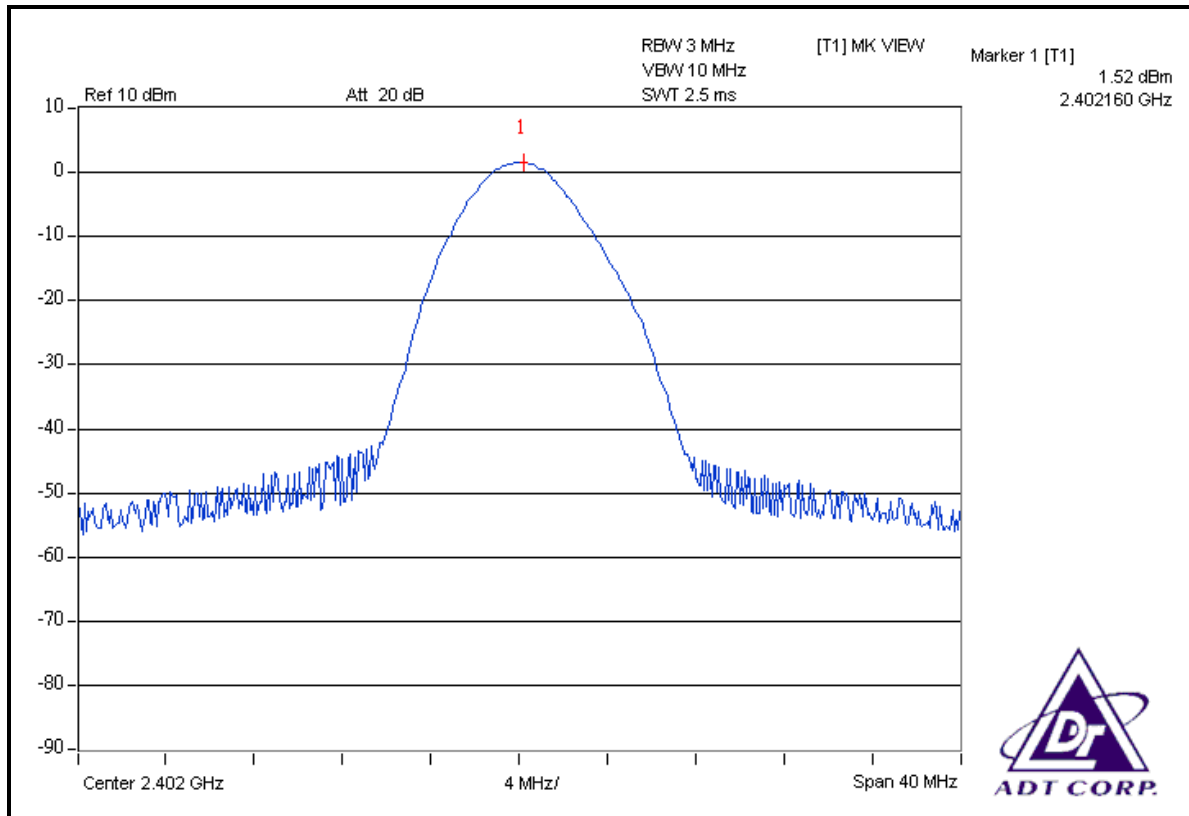

CH 39

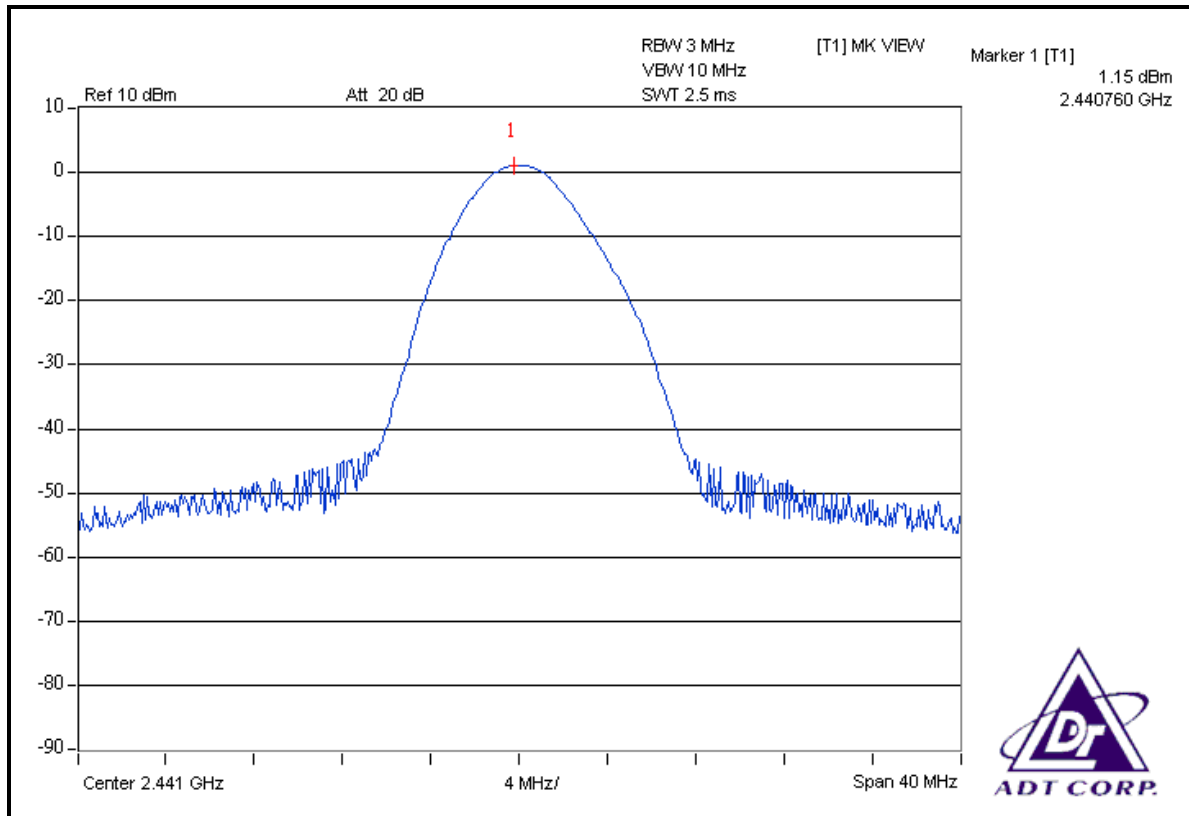



A D T

FOR 8DPSK

TEST MODE	A		
MODULATION TYPE	8DPSK	CHANNEL	0, 39, 78
INPUT POWER	3.7Vdc	ENVIRONMENTAL CONDITIONS	25deg. C, 74% RH, 1007hPa
TESTED BY	Jun Wu		

CHANNEL	CHANNEL FREQUENCY (MHz)	PEAK POWER OUTPUT (dBm)	PEAK POWER OUTPUT (mW)	PEAK POWER LIMIT (mW)	PASS/FAIL
0	2402	3.22	2.099	125	PASS
39	2441	2.77	1.892	125	PASS
78	2480	2.31	1.702	125	PASS

CH 0

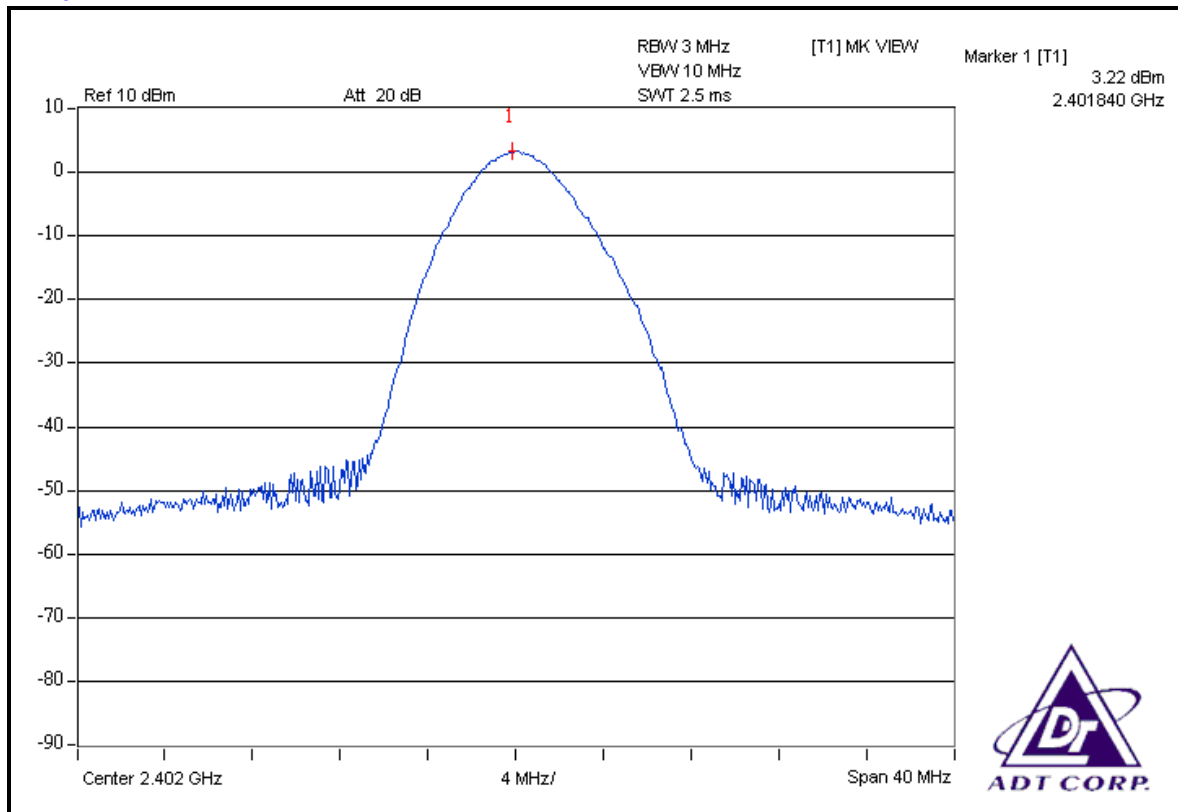



A D T

CH 39

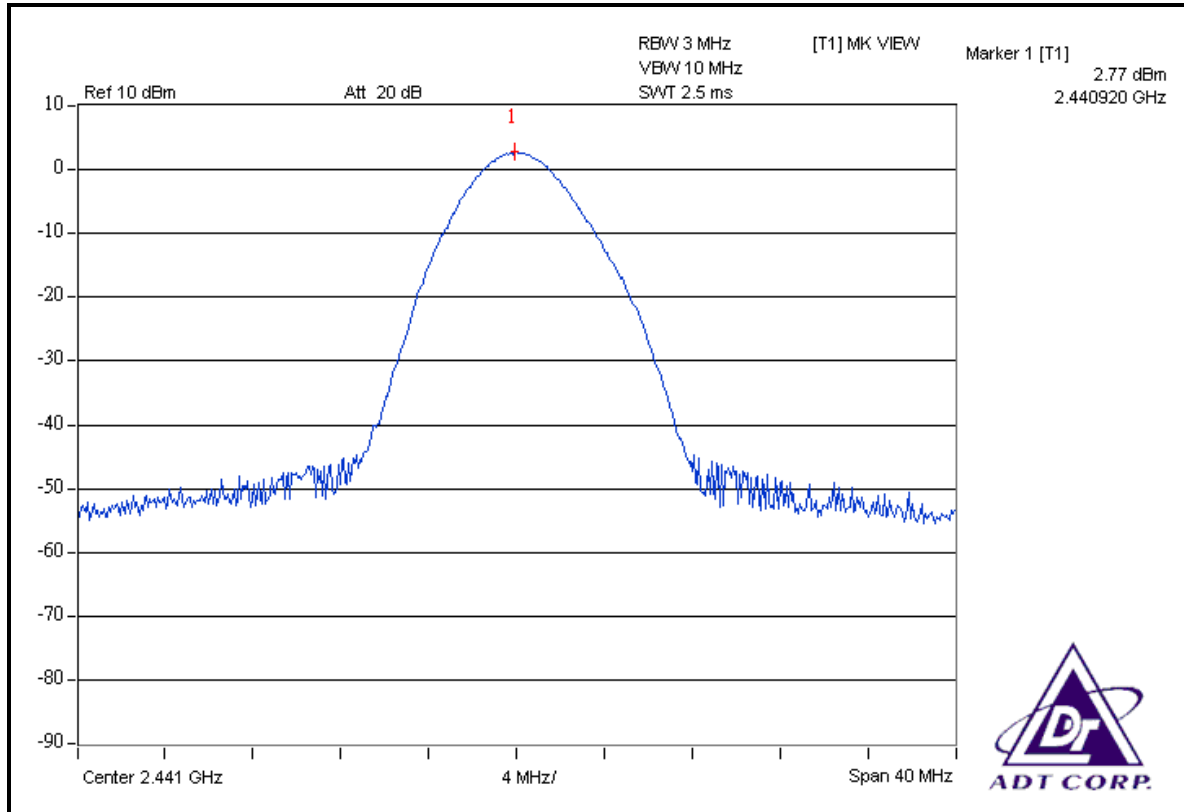

CH 78

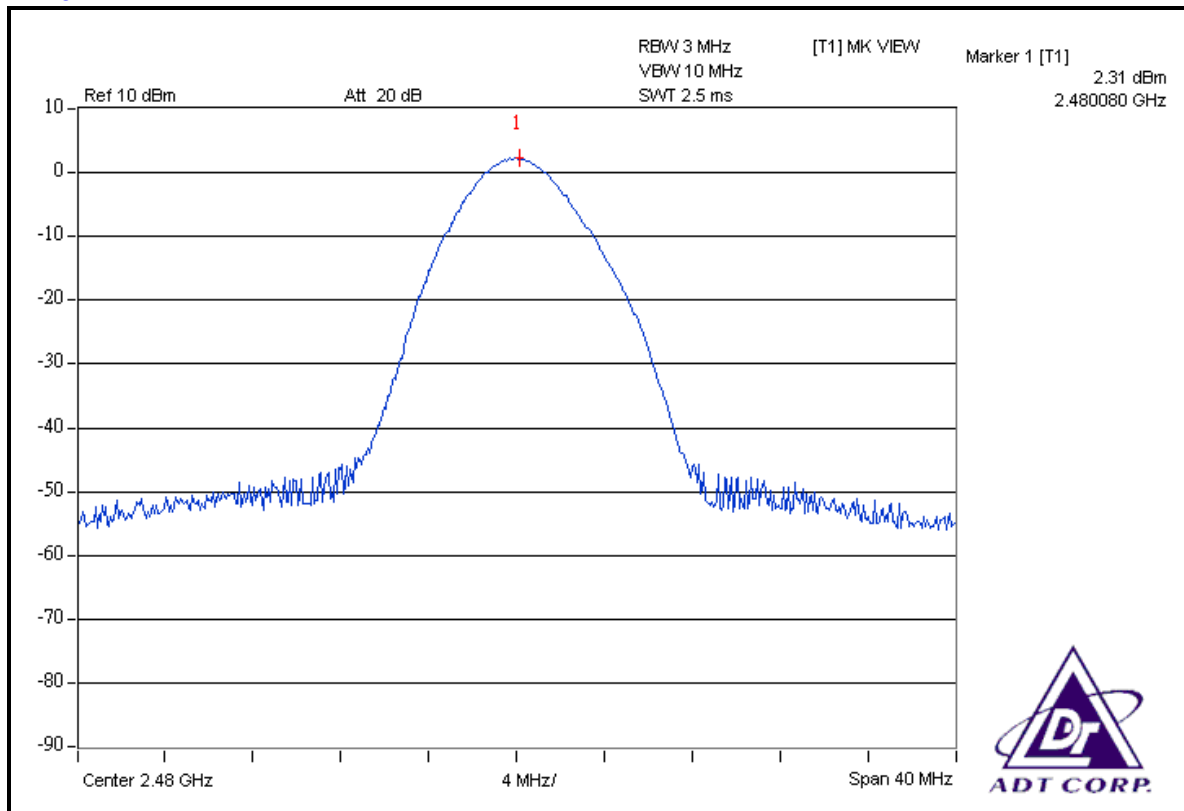

4.8 BAND EDGES MEASUREMENT

4.8.1 LIMITS OF BAND EDGES MEASUREMENT

Below -20dB of the highest emission level of operating band (in 100KHz RBW).

4.8.2 TEST INSTRUMENTS

DESCRIPTION & MANUFACTURER	MODEL NO.	SERIAL NO.	CALIBRATED DATE	CALIBRATED UNTIL
SPECTRUM ANALYZER	FSP 40	100035	Mar. 26, 2008	Mar. 25, 2009

NOTE: The calibration interval of the above test instruments is 12 months and the calibrations are traceable to NML/ROC and NIST/USA.

4.8.3 TEST PROCEDURE

The transmitter output was connected to the spectrum analyzer via a low lose cable. Set both RBW and VBW of spectrum analyzer to 100 kHz and 300 kHz with suitable frequency span including 100 MHz bandwidth from band edge. The band edges was measured and recorded.

The spectrum plots are attached on the following pages.

4.8.4 DEVIATION FROM TEST STANDARD

No deviation.

4.8.5 EUT OPERATING CONDITION

The software provided by client enabled the EUT to transmit and receive data at lowest, middle and highest channel frequencies individually.

4.8.6 TEST RESULTS

The spectrum plots are attached on the following 8 images. D1 line indicates the highest level, D2 line indicates the 20dB offset below D1. It shows compliance with the requirement in part 15.247(d).

Mode A: FOR GFSK

NOTE 1:

The band edge emission plot on the next page shows 59.64dBc between carrier maximum power and local maximum emission in restrict band (2.3504GHz). The emission of carrier strength list in the test result of channel 0 at the item 4.2.7 is 104.62dBuV/m (Peak), so the maximum field strength in restrict band is $104.62 - 59.64 = 44.98$ dBuV/m, which is under 74 dBuV/m limit.

Average value = $44.98 - 30.10 = 14.88$ dBuV/m, which is under 54dBuV/m limit.

*The DH5 packet was the worse case duty cycle for a transmit dwell time on a channel, based upon bluetooth theory the transmitter is on $0.625 * 5$ per 296.25 ms per channel. Therefore, the duty cycle be equal to: $20\log(3.125/100) = -30.1$ dB.

Average value = peak reading -30.10 .

NOTE 2:

The band edge emission plot on the next second page shows 58.94dBc between carrier maximum power and local maximum emission in restrict band (2.4838GHz). The emission of carrier strength list in the test result of channel 78 at the item 4.2.7 is 103.13dBuV/m (Peak), so the maximum field strength in restrict band is $103.13 - 58.94 = 44.19$ dBuV/m, which is under 74 dBuV/m limit.

Average value = $44.19 - 30.10 = 14.09$ dBuV/m, which is under 54dBuV/m limit.

*The DH5 packet was the worse case duty cycle for a transmit dwell time on a channel, based upon bluetooth theory the transmitter is on $0.625 * 5$ per 296.25 ms per channel. Therefore, the duty cycle be equal to: $20\log(3.125/100) = -30.1$ dB.

Average value = peak reading -30.10 .



A D T

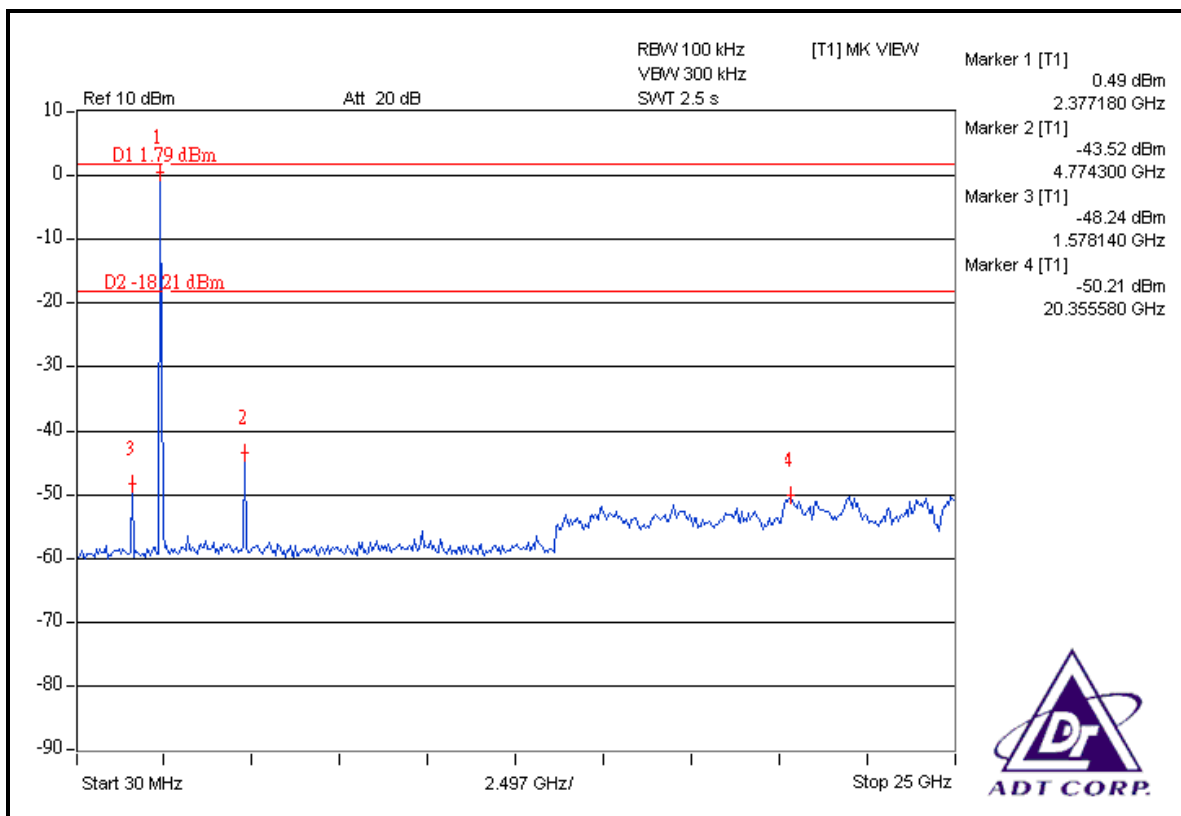
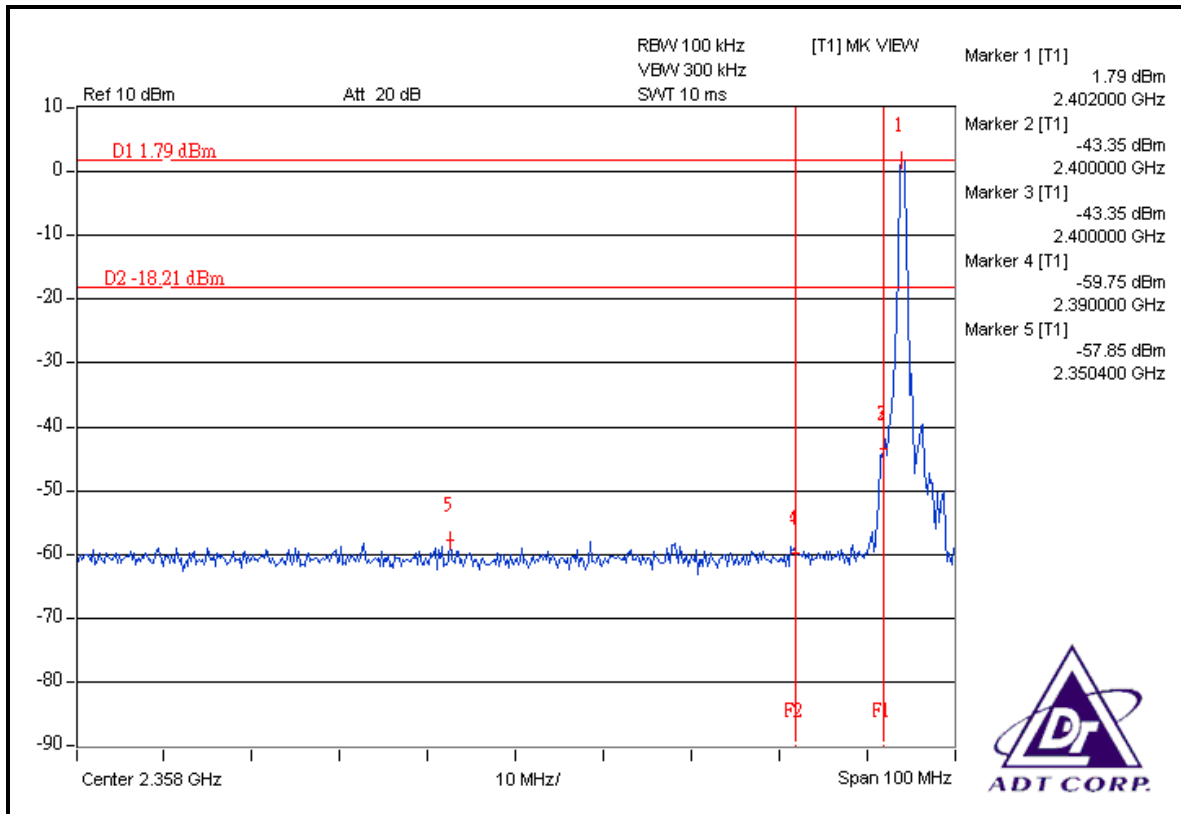



A D T

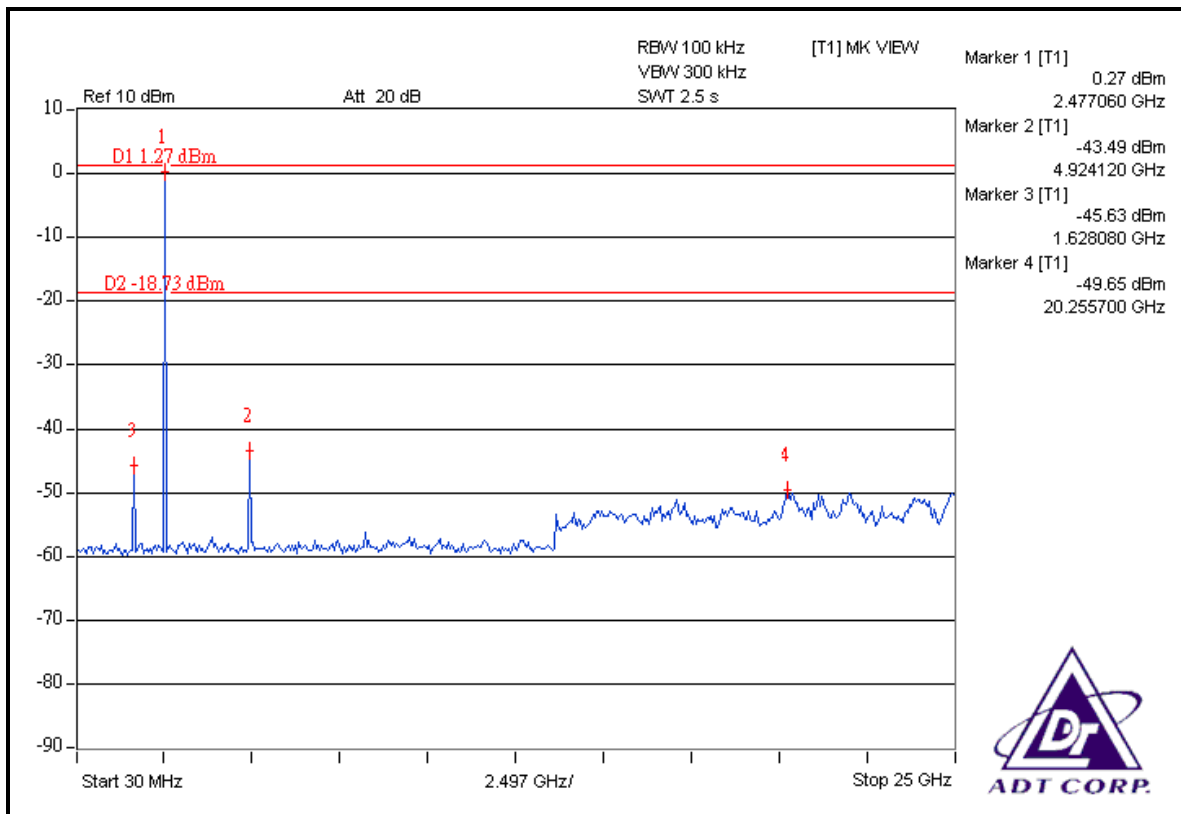
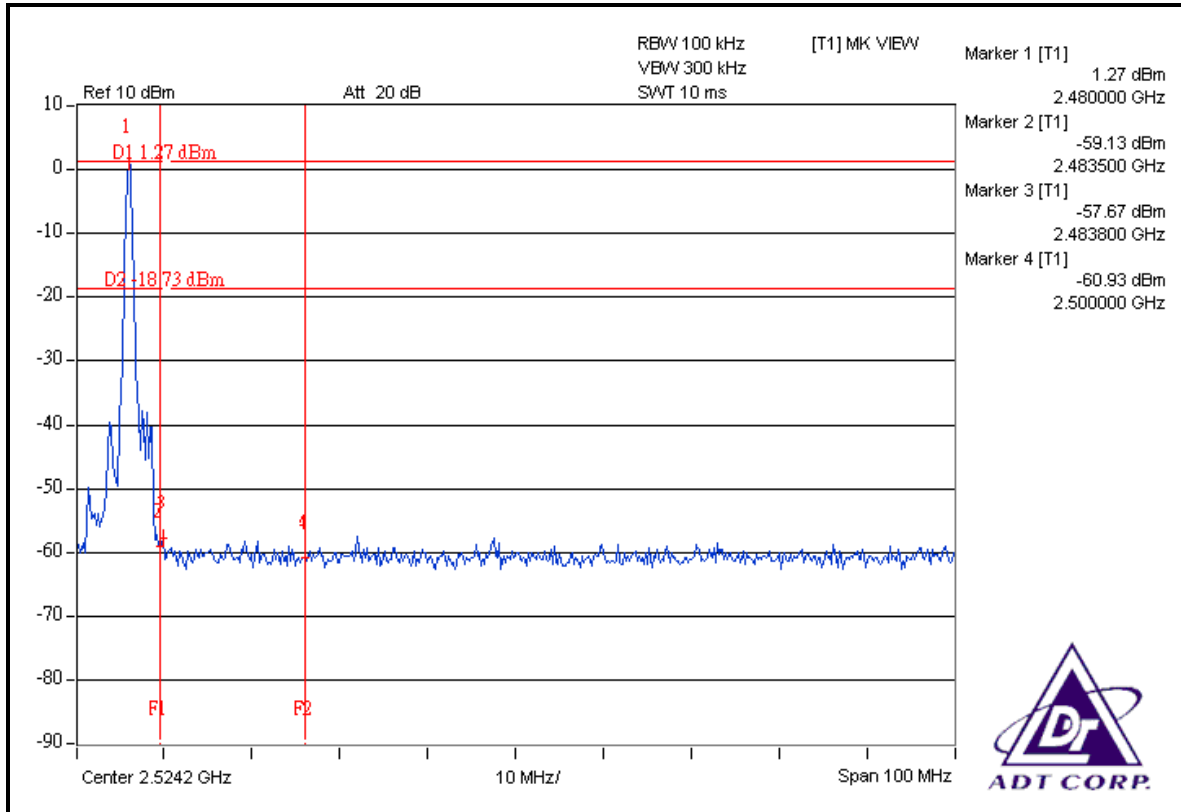

Mode A: FOR 8DPSK

NOTE 1:

The band edge emission plot on the next page shows 60.86dBc between carrier maximum power and local maximum emission in restrict band (2.3766GHz). The emission of carrier strength list in the test result of channel 0 at the item 4.2.7 is 106.21dBuV/m (Peak), so the maximum field strength in restrict band is $106.21 - 60.86 = 45.35$ dBuV/m, which is under 74 dBuV/m limit.

Average value = $45.35 - 30.10 = 15.25$ dBuV/m, which is under 54dBuV/m limit.

*The DH5 packet was the worse case duty cycle for a transmit dwell time on a channel, based upon bluetooth theory the transmitter is on $0.625 * 5$ per 296.25 ms per channel. Therefore, the duty cycle be equal to: $20\log(3.125/100) = -30.1$ dB.

Average value = peak reading -30.10 .

NOTE 2:

The band edge emission plot on the next second page shows 57.49dBc between carrier maximum power and local maximum emission in restrict band (2.4835GHz). The emission of carrier strength list in the test result of channel 78 at the item 4.2.7 is 103.31dBuV/m (Peak), so the maximum field strength in restrict band is $103.31 - 57.49 = 45.82$ dBuV/m, which is under 74 dBuV/m limit.

Average value = $45.82 - 30.10 = 15.72$ dBuV/m, which is under 54dBuV/m limit.

*The DH5 packet was the worse case duty cycle for a transmit dwell time on a channel, based upon bluetooth theory the transmitter is on $0.625 * 5$ per 296.25 ms per channel. Therefore, the duty cycle be equal to: $20\log(3.125/100) = -30.1$ dB.

Average value = peak reading -30.10 .



A D T

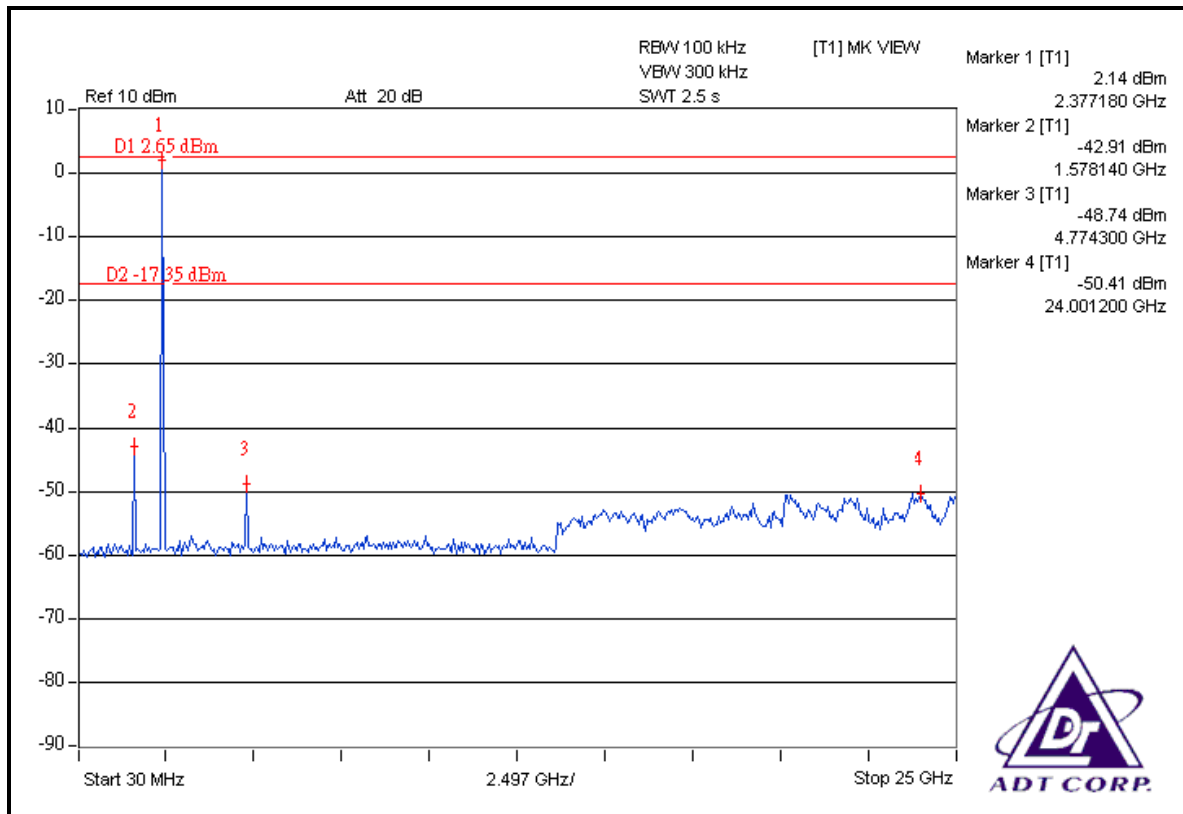
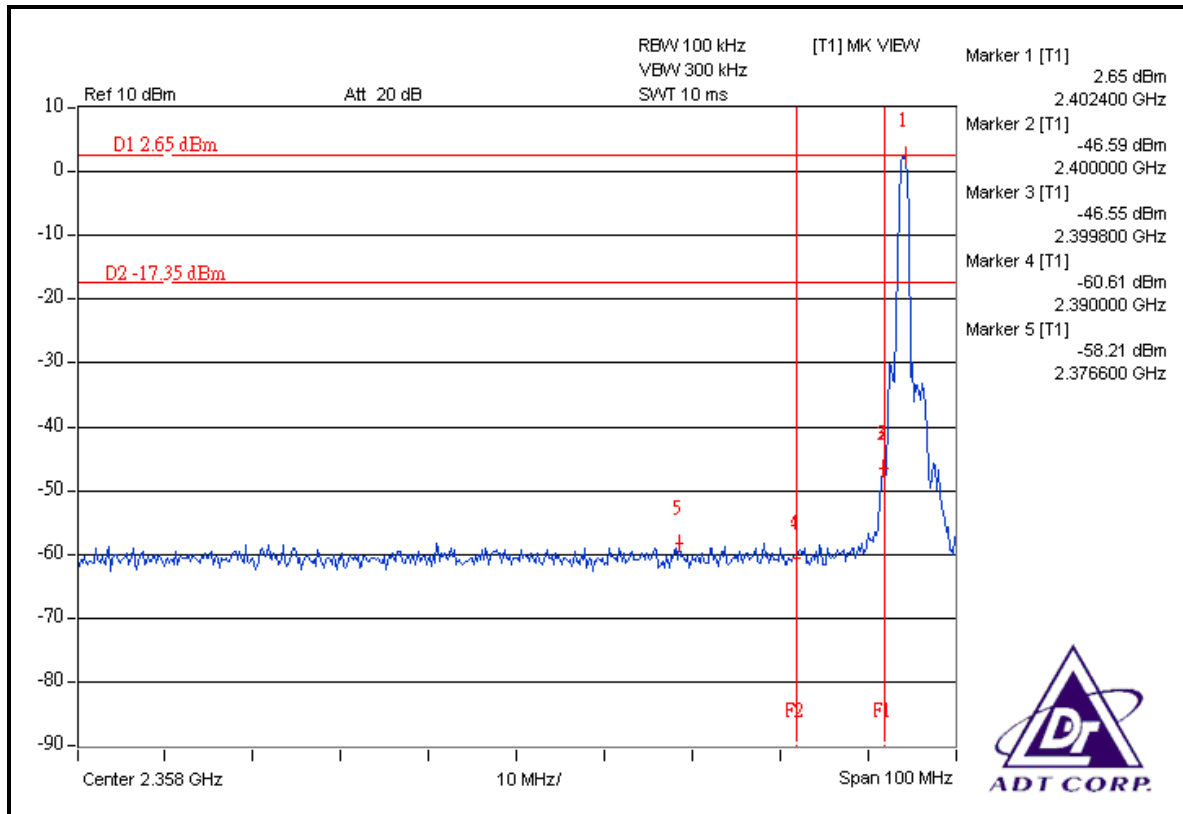



A D T

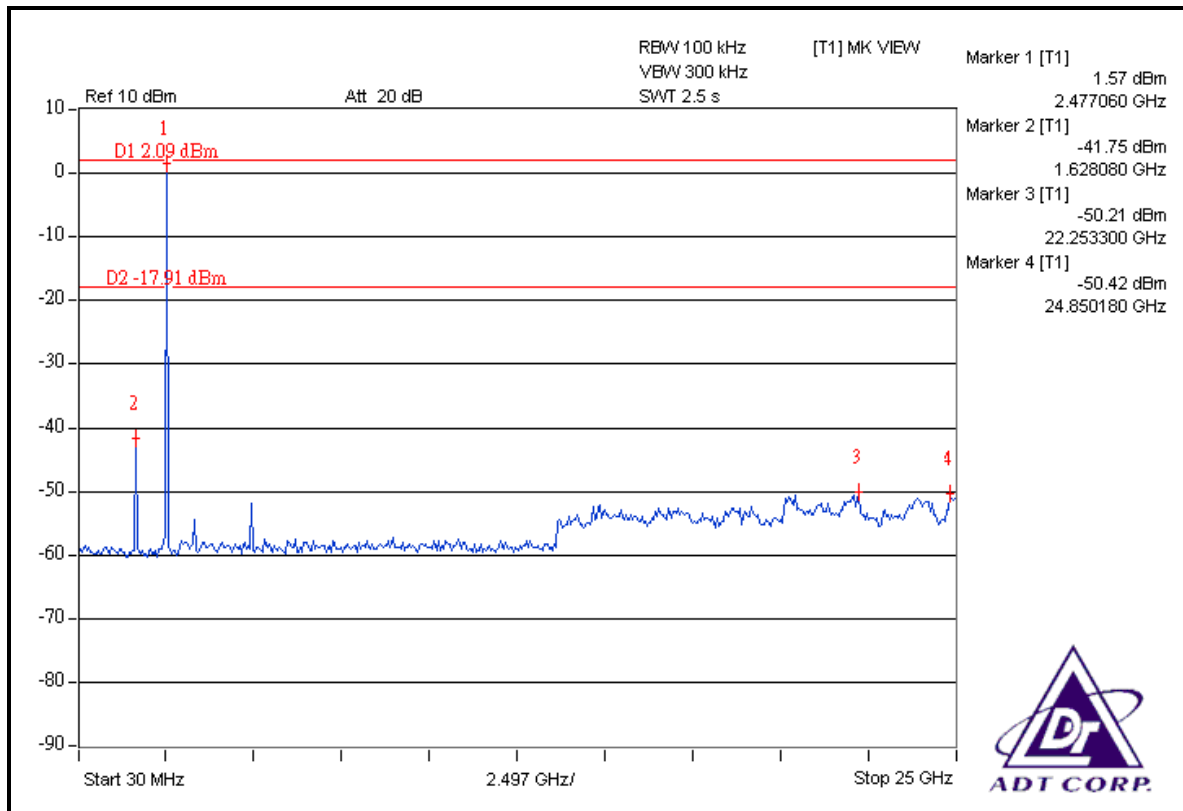
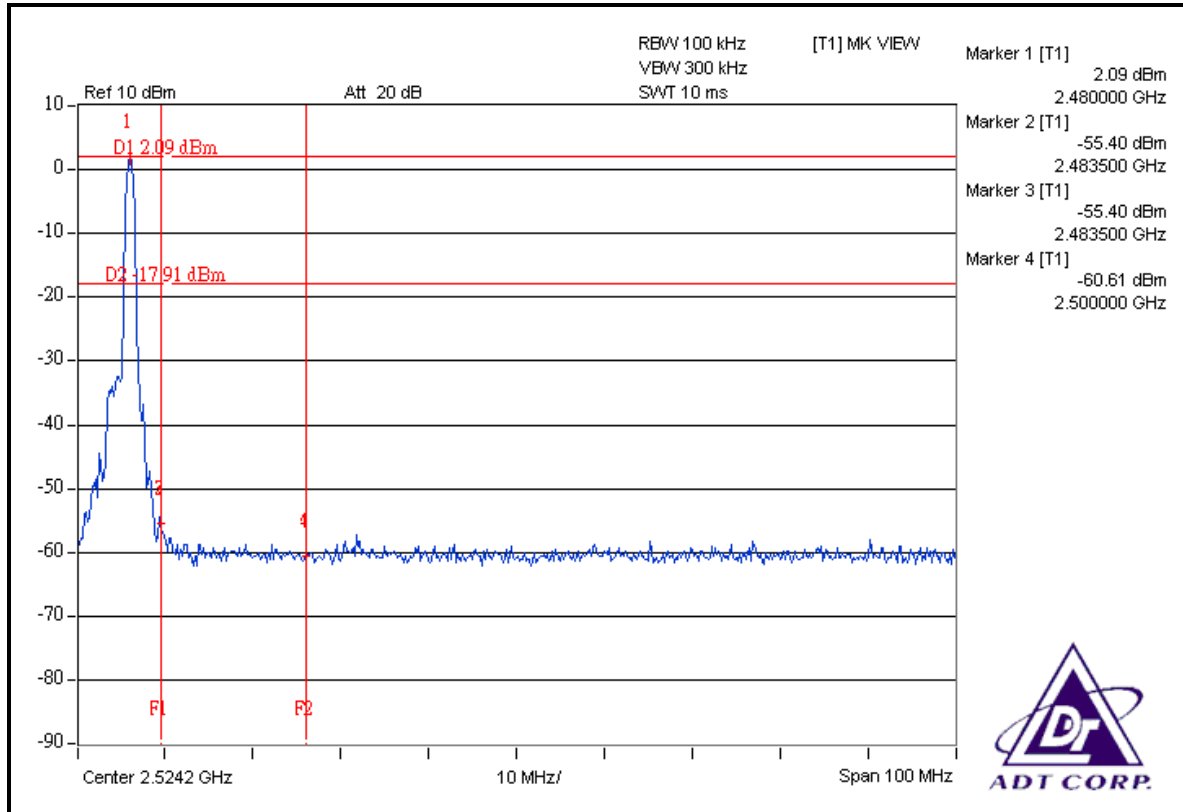

4.9 ANTENNA REQUIREMENT

4.9.1 STANDARD APPLICABLE

For intentional device, according to FCC 47 CFR Section 15.203, an intentional radiator shall be designed to ensure that no antenna other than that furnished by the responsible party shall be used with the device.

And according to FCC 47 CFR Section 15.247 (b), if transmitting antennas of directional gain greater than 6 dBi are used, the power shall be reduced by the amount in dB that the directional gain of the antenna exceeds 6 dBi.

4.9.2 ANTENNA CONNECTED CONSTRUCTION

The antenna used in this product is Chip antenna without antenna connector. The maximum gain of this antenna is -2.01dBi.

5. PHOTOGRAPHS OF THE TEST CONFIGURATION

Please refer to the attached file (Test Setup Photo).



6. INFORMATION ON THE TESTING LABORATORIES

We, Bureau Veritas Consumer Products Services (H.K.) Ltd., Taoyuan Branch, were founded in 1988 to provide our best service in EMC, Radio, Telecom and Safety consultation. Our laboratories are accredited and approved by the following approval agencies according to ISO/IEC 17025.

USA	FCC, NVLAP
Germany	TUV Rheinland
Japan	VCCI
Norway	NEMKO
Canada	INDUSTRY CANADA, CSA
R.O.C.	TAF, BSMI, NCC
Netherlands	Telefication
Singapore	GOST-ASIA(MOU)
Russia	CERTIS(MOU)

Copies of accreditation certificates of our laboratories obtained from approval agencies can be downloaded from our web site: www.adt.com.tw/index.5/phtml.
If you have any comments, please feel free to contact us at the following:

Linko EMC/RF Lab:

Tel: 886-2-26052180

Fax: 886-2-26051924

Hsin Chu EMC/RF Lab:

Tel: 886-3-5935343

Fax: 886-3-5935342

Hwa Ya EMC/RF/Safety Telecom Lab:

Tel: 886-3-3183232

Fax: 886-3-3185050

Web Site: www.adt.com.tw

The address and road map of all our labs can be found in our web site also.

7. APPENDIX A – MODIFICATIONS RECORDERS FOR ENGINEERING CHANGES TO THE EUT BY THE LAB

No any modifications are made to the EUT by the lab during the test.

---END---