



Test report No:
2190330R-HP-US-P01V01

SAR TEST REPORT

Product	Bluetooth headset
Model and /or type reference	B825
Trademark	Plantronics
FCC ID	AL8-B25
IC	457A-B25
Applicant's name / address	Plantronics, Inc. 345 Encinal Street, Santa Cruz, CA95060 USA
Test method requested, standard	FCC KDB Publication 248227 D01v02r02 FCC KDB Publication 447498 D01v06 FCC KDB Publication 865664 D01v01r04 IEEE Std. 1528-2013 FCC 47CFR §2.1093 ANSI C95.1-2005 RSS 102: Issue 5
Maximum SAR	Standalone 1g SAR 0.112 W/kg;
Verdict Summary	IN COMPLIANCE
Tested by (name / position & signature)	Scott Shen/Project Engineer <i>Scott Shen</i>
Approved by (name / position & signature)	Jack Zhang/ Supervisor <i>Jack Zhang</i>
Date of issue	2021-10-19
Report version	V1.0
Report template No	Template_FCC IC SAR-RF-V1.0
FCC Designation Number	CN1199
ISED CAB identifier	CN0040

INDEX

	Page
Competences and Guarantees	4
General conditions	4
Environmental conditions	5
Possible test case verdicts	5
Document History	6
REMARKS AND COMMENTS	6
1 General Information	7
1.1 General Description of the Item(s)	7
1.2 Antenna Information	8
2 SAR Measurement System	9
2.1 DASY5 System Description.....	9
2.1.1. Applications.....	9
2.1.2. Area Scans.....	10
2.1.3. Zoom Scan (Cube Scan Averaging)	10
2.1.4. Uncertainty of Inter-/Extrapolation and Averaging	11
2.2 DASY5 E-Field Probe.....	12
2.3 Boundary Detection Unit and Probe Mounting Device.....	13
2.4 DATA Acquisition Electronics (DAE) and Measurement Server	13
2.5 Robot.....	14
2.6 Light Beam Unit.....	14
2.7 Device Holder	15
2.8 SAM Twin Phantom.....	15
3 Tissue Simulating Liquid	16
3.1 The composition of the tissue simulating liquid.....	16
3.2 Tissue Calibration Result	17
3.3 Tissue Dielectric Parameters for Head and Body Phantoms.....	20
4 SAR Measurement Procedure	21
4.1 SAR System Validation	21
4.1.1. Validation Dipoles	21
4.1.2. Validation Result	22
4.1.3. Dipole Calibration Data	23

4.2	SAR Measurement Procedure	25
5	SAR Exposure Limits	26
6	Test Equipment List.....	27
7	Measurement Uncertainty	28
8	Power Test Results	30
9	SAR Test Results	32
9.1	Standalone SAR.....	32
9.2	Test position and configuration	34
	Appendix A. SAR Validation Data	35
	Appendix B. SAR Test Data	36
	Appendix C. Probe Calibration Data.....	45
	Appendix D. Dipole Calibration Data	55
	Appendix E. DAE Calibration Data.....	63

COMPETENCES AND GUARANTEES

DEKRA is a testing laboratory competent to carry out the tests described in this report.

In order to assure the traceability to other national and international laboratories, DEKRA has a calibration and maintenance program for its measurement equipment.

DEKRA guarantees the reliability of the data presented in this report, which is the result of the measurements and the tests performed to the item under test on the date and under the conditions stated in the report and it is based on the knowledge and technical facilities available at DEKRA at the time of performance of the test.

DEKRA is liable to the client for the maintenance of the confidentiality of all information related to the item under test and the results of the test.

The results presented in this Test Report apply only to the particular item under test established in this document.

IMPORTANT: No parts of this report may be reproduced or quoted out of context, in any form or by any means, except in full, without the previous written permission of DEKRA.

GENERAL CONDITIONS

Test Location	No. 99, Hongye Road, Suzhou Industrial Park Suzhou, 215006, P.R. China
Date (receive sample)	Sep. 09, 2021
Date (start test)	Sep. 23, 2021
Date (finish test)	Sep. 30, 2021

1. This report is only referred to the item that has undergone the test.
2. This report does not constitute or imply on its own an approval of the product by the Certification Bodies or Competent Authorities.
3. This document is only valid if complete; no partial reproduction can be made without previous written permission of DEKRA.
4. This test report cannot be used partially or in full for publicity and/or promotional purposes without previous written permission of DEKRA.

ENVIRONMENTAL CONDITIONS

The climatic conditions during the tests are within the limits specified by the manufacturer for the operation of the EUT and the test equipment. The climatic conditions during the tests were within the following limits:

Ambient temperature	18 °C – 25 °C
Relative Humidity air	30% - 60%

If explicitly required in the basic standard or applied product / product family standard the climatic values are recorded and documented separately in this test report.

POSSIBLE TEST CASE VERDICTS

Test case does not apply to test object	N/A
Test object does meet requirement	P (Pass) / PASS
Test object does not meet requirement	F (Fail) / FAIL
Not measured	N/M

DOCUMENT HISTORY

Report No.	Version	Description	Issued Date
2190330R-HP-US-P01V01	V1.0	Initial issue of report.	2021-10-19

REMARKS AND COMMENTS

1. The equipment under test (EUT) does meet the essential requirements of the stated standard(s)/test(s).
2. These test results on a sample of the device are for the purpose of demonstrating Compliance with FCC Part 2.1093.
3. The measurement result is considered in conformance with the requirement if it is within the prescribed limit, It is not necessary to account the uncertainty associated with the measurement result.
4. The test results presented in this report relate only to the object tested.
5. The test report shall not be reproduced without the written approval of DEKRA Testing and Certification (Suzhou) Co., Ltd.
6. This report will not be used for social proof function in China market.
7. DEKRA declines any responsibility with the following test data provided by customer that may affect the validity of result:
 - Chapter 1.1 General Description of the Item(s);
 - Chapter 1.2 Antenna Information.

1 General Information

1.1 General Description of the Item(s)

Product Name	Bluetooth Headset					
Model No.	B825					
Manufacturer	Plantronics, Inc.					
Manufacturer Address	345 Encinal Street, Santa Cruz, CA95060 USA					
EUT Voltage	DC 3.7V					
Frequency Range	Bluetooth 2402~2480MHz					
Channel Number	Bluetooth V3.0+HS:79 V4.0:40					
Type of Modulation	V3.0+HS:GFSK, Pi/4 DQPSK, 8DPSK					
	V4.0:GFSK					
Data Rate	V3.0 +HS: 1Mbps(GFSK), 2Mbps(Pi/4 DQPSK), 3Mbps (8DPSK)					
	V4.0:1Mbps(GFSK)					
Type of Modulation	GFSK					
PHYs	<input checked="" type="checkbox"/>	LE 1M	<input checked="" type="checkbox"/>	LE 2M	<input checked="" type="checkbox"/>	LE Coded S=2/8
Data Rate	<input checked="" type="checkbox"/>	1Mbit/s	<input checked="" type="checkbox"/>	2Mbit/s	<input checked="" type="checkbox"/>	500/125 Kbit/s
Operating Temperature Range	0°C - 35 °C					

1.2 Bluetooth Antenna List

Antenna	Manufacturer	Model No	Peak Gain
Monopole Antenna	Goertek	ILA Antenna	1.97dBi For 2.4GHz

Model Figure

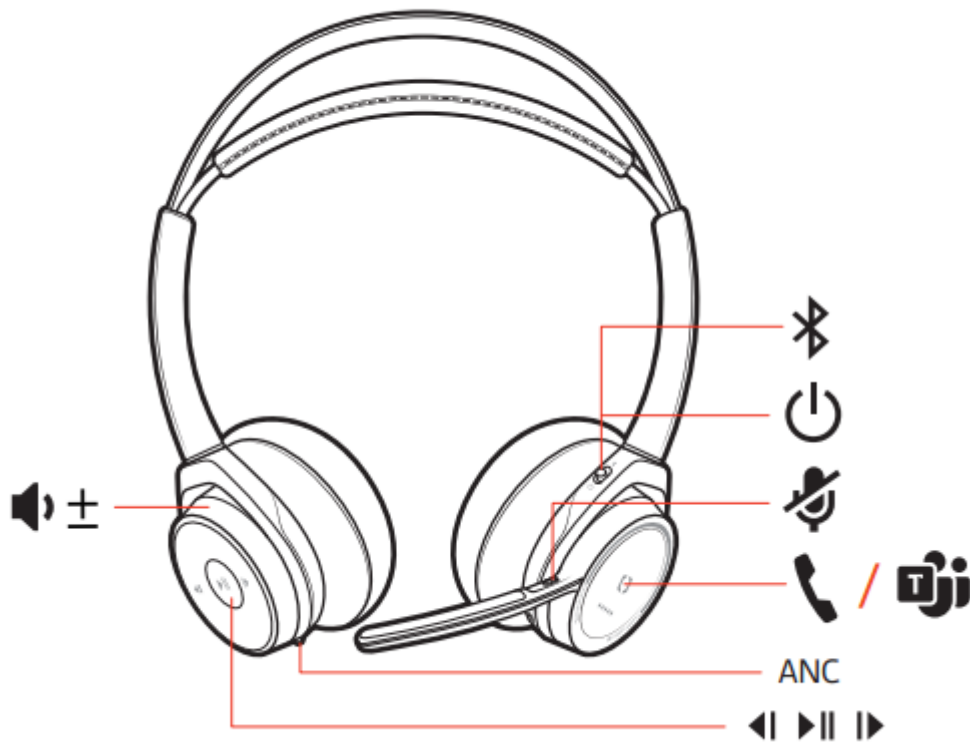

2 SAR MEASUREMENT SYSTEM

2.1 DASY5 System Description

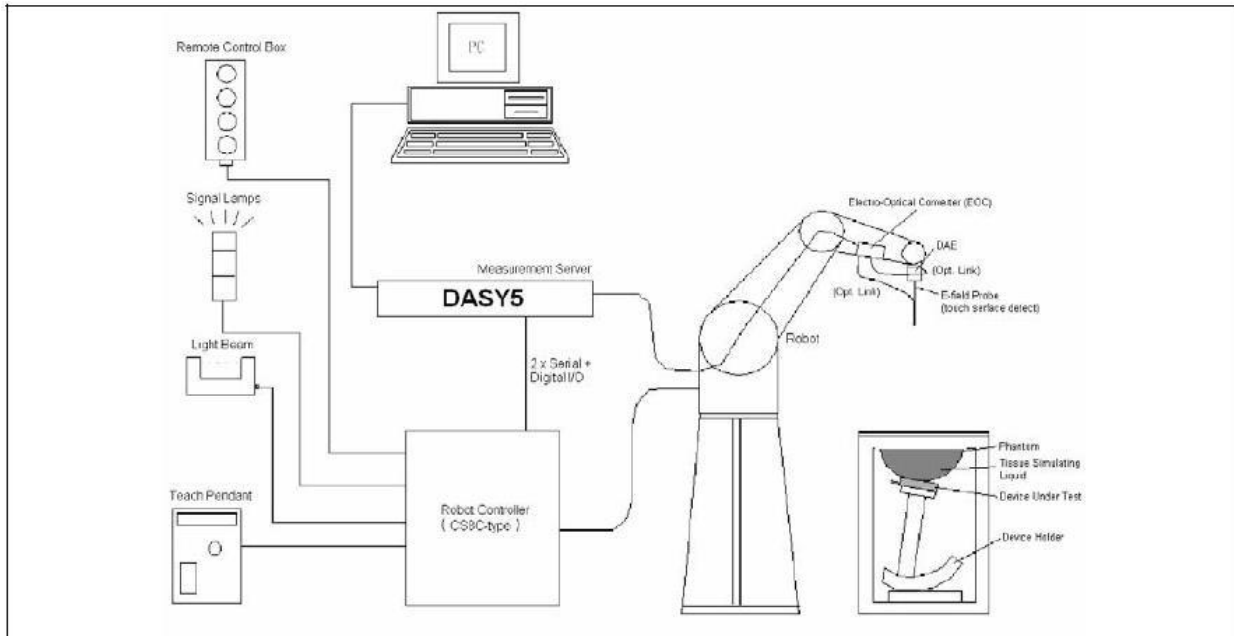

The DASY5 system for performing compliance tests consists of the following items:

1. A standard high precision 6-axis robot with controller, teach pendant and software. An arm extension for accommodating the data acquisition electronics (DAE).
2. A data acquisition electronics (DAE) which performs the signal amplification, signal multiplexing, AD-conversion, offset measurements, mechanical surface detection, collision detection, etc. The unit is battery powered with standard or rechargeable batteries. The signal is optically transmitted to the EOC.
3. The Electro-optical converter (EOC) performs the conversion from optical to electrical signals for the digital communication to the DAE. To use optical surface detection, a special version of the EOC is required. The EOC signal is transmitted to the measurement server.
4. The Light Beam used is for probe alignment. This improves the (absolute) accuracy of the probe positioning.
5. A computer running WinXP and the DASY5 software.
6. Remote control and teach pendant as well as additional circuitry for robot safety such as warning lamps, etc.
7. The phantom, the device holder and other accessories according to the targeted measurement.

2.1.1. Applications

Predefined procedures and evaluations for automated compliance testing with all worldwide standards, e.g., IEEE 1528, OET 65, IEC 62209-1, IEC 62209-2, EN 50360, EN 50383, EN62311 and others.

2.1.2. Area Scans

Area scans are defined prior to the measurement process being executed with a user defined variable spacing between each measurement point (integral) allowing low uncertainty measurements to be conducted. Scans defined for FCC applications utilize a 10mm² step integral, with 1mm interpolation used to locate the peak SAR area used for zoom scan assessments.

When an Area Scan has measured all reachable points, it computes the field maxima found in the scanned area, within a range of the global maximum. The range (in dB) is specified in the standards for compliance testing. For example, a 2 dB range is required in IEEE 1528-2003 and IEC 62209 standards, whereby 3 dB is a requirement when compliance is assessed in accordance with the ARIB standard (Japan).

2.1.3. Zoom Scan (Cube Scan Averaging)

Zoom Scans are used to assess the peak spatial SAR values within a cubic averaging volume containing 1 g and 10 g of simulated tissue. A density of 1000 kg/m³ is used to represent the head and body tissue density and not the phantom liquid density, in order to be consistent with the definition of the liquid dielectric properties, i.e. the side length of the 1 g cube is 10mm, with the side length of the 10 g cube 21,5mm.

The zoom scan integer steps can be user defined so as to reduce uncertainty, but normal practice for typical test applications utilize a physical step of 7x7x7 (5mmx5mmx5mm) providing a volume of 30mm in the X & Y axis, and 30mm in the Z axis.

2.1.4. Uncertainty of Inter-/Extrapolation and Averaging

In order to evaluate the uncertainty of the interpolation, extrapolation and averaged SAR calculation algorithms of the Postprocessor, DASYS5 allows the generation of measurement grids which are artificially predefined by analytically based test functions. Therefore, the grids of area scans and zoom scans can be filled with uncertainty test data, according to the SAR benchmark functions of IEEE 1528. The three analytical functions shown in equations as below are used to describe the possible range of the expected SAR distributions for the tested handsets. The field gradients are covered by the spatially flat distribution f1, the spatially steep distribution f3 and f2 accounts for H-field cancellation on the phantom/tissue surface.

$$f_1(x, y, z) = Ae^{-\frac{z}{2a}} \cos^2 \left(\frac{\pi \sqrt{x'^2 + y'^2}}{2 \cdot 5a} \right)$$

$$f_2(x, y, z) = Ae^{-\frac{z}{a}} \frac{a^2}{a^2 + x'^2} \left(3 - e^{-\frac{2z}{a}} \right) \cos^2 \left(\frac{\pi y'}{2 \cdot 3a} \right)$$

$$f_3(x, y, z) = A \frac{a^2}{\frac{a^2}{4} + x'^2 + y'^2} \left(e^{-\frac{2z}{a}} + \frac{a^2}{2(a + 2z)^2} \right)$$

2.2 DASYS E-Field Probe

The SAR measurement is conducted with the dosimetric probe manufactured by SPEAG. The probe is specially designed and calibrated for use in liquid with high permittivity. The dosimetric probe has special calibration in liquid at different frequency.

SPEAG conducts the probe calibration in compliance with international and national standards (e.g. IEEE 1528, EN 62209-1, IEC 62209, etc.) under ISO 17025. The calibration data are in Appendix D.

Model	EX3DV4	
Construction	Symmetrical design with triangular core Built-in shielding against static charges PEEK enclosure material (resistant to organic solvents, e.g., DGBE)	
Frequency	10 MHz to 6 GHz Linearity: ± 0.2 dB (30 MHz to 6 GHz)	
Directivity	± 0.3 dB in HSL (rotation around probe axis) ± 0.5 dB in tissue material (rotation normal to probe axis)	
Dynamic Range	10 μ W/g to 100 mW/g Linearity: ± 0.2 dB (noise: typically < 1 μ W/g)	
Dimensions	Overall length: 330 mm (Tip: 20 mm) Tip diameter: 2.5 mm (Body: 12 mm) Typical distance from probe tip to dipole centers: 1 mm	
Application	High precision dosimetric measurements in any exposure scenario (e.g., very strong gradient fields). Only probe which enables compliance testing for frequencies up to 6 GHz with precision of better 30%.	

2.3 Boundary Detection Unit and Probe Mounting Device

The DASY probes use a precise connector and an additional holder for the probe, consisting of a plastic tube and a flexible silicon ring to center the probe. The connector at the DAE is flexibly mounted and held in the default position with magnets and springs. Two switching systems in the connector mount detect frontal and lateral probe collisions and trigger the necessary software response.



2.4 DATA Acquisition Electronics (DAE) and Measurement Server

The data acquisition electronics (DAE) consists of a highly sensitive electrometer-grade preamplifier with auto-zeroing, a channel and gain-switching multiplexer, a fast 16 bit AD-converter and a command decoder and control logic unit.

Transmission to the measurement server is accomplished through an optical downlink for data and status information as well as an optical uplink for commands and the clock.

The input impedance of the DAE4 is 200M Ohm; the inputs are symmetrical and floating. Common mode rejection is above 80dB.



The DASY5 measurement server is based on a PC/104 CPU board with a 400MHz intel ULV Celeron, 128MB chipdisk and 128MB RAM. The necessary circuits for communication with the DAE electronics box, as well as the 16 bit AD converter system for optical detection and digital I/O interface are contained on the DASY5 I/O board, which is directly connected to the PC/104 bus of the CPU board.



2.5 Robot

The DASY5 system uses the high precision robots TX90 XL type out of the newer series from Stäubli SA (France). For the 6-axis controller DASY5 system, the CS8C robot controller version from Stäubli is used.

The XL robot series have many features that are important for our application:

- High precision (repeatability 0.02 mm)
- High reliability (industrial design)
- Jerk-free straight movements
- Low ELF interference (the closed metallic construction shields against motor control fields)
- 6-axis controller



2.6 Light Beam Unit

The light beam switch allows automatic "tooling" of the probe. During the process, the actual position of the probe tip with respect to the robot arm is measured, as well as the probe length and the horizontal probe offset. The software then corrects all movements, such that the robot coordinates are valid for the probe tip.

The repeatability of this process is better than 0.1 mm. If a position has been taught with an aligned probe, the same position will be reached with another aligned probe within 0.1 mm, even if the other probe has different dimensions. During probe rotations, the probe tip will keep its actual position.



2.7 Device Holder

The DASY5 device holder is designed to cope with different positions given in the standard. It has two scales for the device rotation (with respect to the body axis) and the device inclination (with respect to the line between the ear reference points). The rotation center for both scales is the ear reference point (EPR).

Thus the device needs no repositioning when changing the angles.

The DASY5 device holder has been made out of low-loss POM material having the following dielectric parameters: relative permittivity $\epsilon_r = 3$ and loss tangent $\delta = 0.02$. The amount of dielectric material has been reduced in the closest vicinity of the device, since measurements have suggested that the influence of the clamp on the test results could thus be lowered.



2.8 SAM Twin Phantom

The SAM twin phantom is a fiberglass shell phantom with 2mm shell thickness (except the ear region where shell thickness increases to 6mm). It has three measurement areas:

- Left head
- Right head
- Flat phantom



The bottom plate contains three pair of bolts for locking the device holder. The device holder positions are adjusted to the standard measurement positions in the three sections. A white cover is provided to tap the phantom during off-periods to prevent water evaporation and changes in the liquid parameters. On the phantom top, three reference markers are provided to identify the phantom position with respect to the robot.

3 TISSUE SIMULATING LIQUID

3.1 The composition of the tissue simulating liquid

INGREDIENT (% Weight)	2450MHz Head
Water	46.5
Salt	0.20
Sugar	0.00
HEC	0.00
Preventol	0.00
DGBE	53.3
Triton X-100	0.00

3.2 Tissue Calibration Result

The dielectric parameters of the liquids were verified prior to the SAR evaluation using DASY5 Dielectric Probe Kit and Agilent Vector Network Analyzer E5071C

Head Tissue Simulant Measurement				
Frequency [MHz]	Description	Dielectric Parameters		Tissue Temp. [°C]
		ϵ_r	σ [s/m]	
2450 MHz	Reference result ± 5% window	39.2 37.24 to 41.16	1.80 1.71 to 1.89	N/A
	09-23-2021	38.52	1.86	21.0

Head Tissue Simulant Measurement (Test Data: 09-23-2021)

Frequency [MHz]	Dielectric Parameters						Tissue Temp. [°C]
	Permittivity ϵ_r	Conductivity σ	Permittivity Target ϵ_r	Conductivity Target σ	Delta (ϵ_r) %	Delta (σ) %	
2402	38.73	1.80	39.3	1.76	-1.45	2.27	21.0
2441	38.57	1.85	39.2	1.79	-1.61	3.35	21.0
2480	38.44	1.89	39.2	1.83	-1.94	3.28	21.0

Note:

- The delta (ϵ_r) and (σ) are within $\pm 5\%$, delta SAR value was not calculated in this report.
- As per IEC 62209-2 Annex F, the SAR correction factor is given by:

$$\Delta \text{SAR} = c_\epsilon \Delta \epsilon_r + c_\sigma \Delta \sigma$$

For the 1g average SAR C_ϵ and C_σ are given by:

$$C_\epsilon = -7.854 \times 10^{-4} f^3 + 9.402 \times 10^{-3} f^2 - 2.742 \times 10^{-2} f - 0.2026$$

$$C_\sigma = 9.804 \times 10^{-3} f^3 - 8.661 \times 10^{-2} f^2 + 2.981 \times 10^{-2} f + 0.7829$$

Where f is the frequency in GHz.

Head Tissue Simulant Measurement (Test Data: 09-23-2021)						
Frequency [MHz]	Dielectric Parameters					Tissue Temp. [°C]
	Delta (ϵ_r) %	Delta (σ) %	C_ϵ	C_σ	Delta SAR%	
2402	-1.45	2.27	-0.23	0.49	1.44	21.0
2441	-1.61	3.35	-0.22	0.48	1.98	21.0
2480	-1.94	3.28	-0.22	0.47	1.99	21.0

Note: The Δ SAR refers to the percent change in SAR relative to the percent change in dielectric properties versus the target values. A negative Δ SAR would translate to a lower measured SAR value than what would be measured if using dielectric properties equal to the target values. A positive Δ SAR would translate to a higher measured SAR value than what would be measured if using dielectric properties equal to the target values. SAR correction shall not be made when the Δ SAR has a positive sign to provide a conservative SAR value. The SAR is only corrected when Δ SAR has a negative sign.

3.3 Tissue Dielectric Parameters for Head and Body Phantoms

The head tissue dielectric parameters recommended by the IEEE SCC-34/SC-2 in P1528 have been incorporated in the following table. These head parameters are derived from planar layer models simulating the highest expected SAR for the dielectric properties and tissue thickness variations in a human head. Other head and body tissue parameters that have not been specified in P1528 are derived from the tissue dielectric parameters computed from the 4-Cole-Cole equations described in Reference [12] and extrapolated according to the head parameters specified in P1528.

Target Frequency (MHz)	Head/ Body	
	ϵ_r	σ (S/m)
150	52.3	0.76
300	45.3	0.87
450	43.5	0.87
835	41.5	0.90
900	41.5	0.97
915	41.5	0.98
1450	40.5	1.20
1610	40.3	1.29
1800 – 2000	40.0	1.40
2450	39.2	1.80
4000	37.4	3.43
5200	36.0	4.66
5800	35.3	5.07

(ϵ_r = relative permittivity, σ = conductivity and $\rho = 1000 \text{ kg/m}^3$)

4 SAR MEASUREMENT PROCEDURE

4.1 SAR System Validation

4.1.1. Validation Dipoles

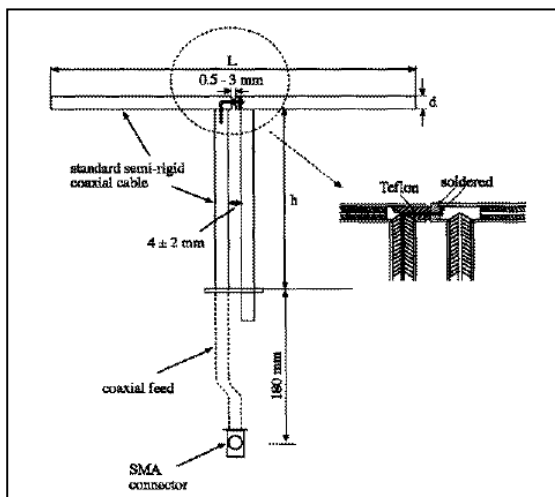

The dipoles used is based on the IEEE-1528 standard, and is complied with mechanical and electrical specifications in line with the requirements of both IEEE and FCC Supplement C. the table below provides details for the mechanical and electrical specifications for the dipoles.

Frequency	L (mm)	h (mm)	d (mm)
2450MHz	53.5	30.4	3.6

4.1.2. Validation Result

System Performance Check at 2450MHz				
Frequency [MHz]	Description	SAR [w/kg] 1g	SAR [w/kg] 10g	Tissue Temp. [°C]
2450 MHz	Reference result ± 10% window	51.2 46.08 to 56.32	23.6 21.24 to 25.96	N/A
	09-23-2021	50	24.08	21.0

Note: All SAR values are normalized to 1W forward power.

4.1.3. Dipole Calibration Data

Impedance Plot for D2450V2

2450MHz Head

Calibrated impedance: 53.330 Ω; Measured impedance: 54.953 Ω (within 5Ω)

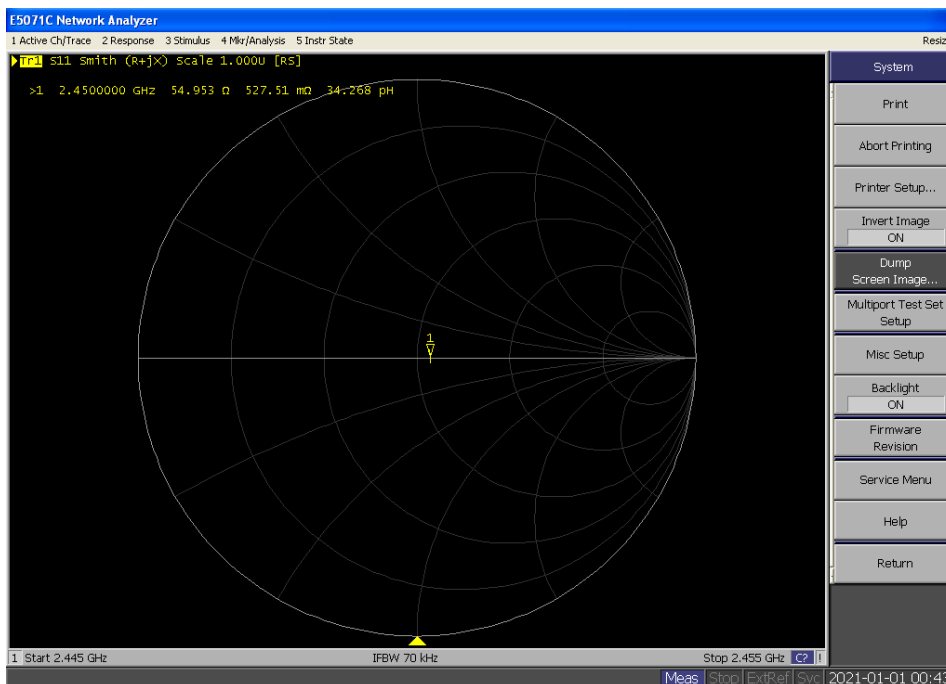

Calibrated return loss: -24.917 dB; Measured impedance: -25.012 dB (within 20%)

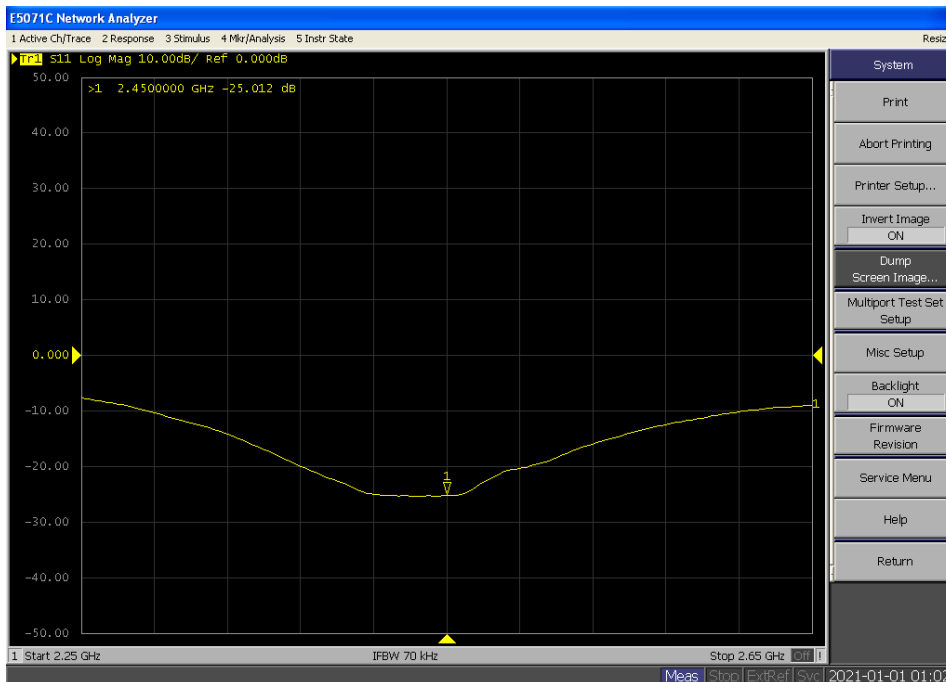

Note: Per KDB 450824 D02 requirements for dipole calibration, DEKRA Lab has adopted three years calibration interval. On annual basis, every measurement dipole has been evaluated and is in compliance with the following criteria:

1. There is no physical damage on the dipole;
2. System validation with specific dipole is within 10% of calibrated value;
3. Return-loss is within 20% of calibrated measurement (Show above);
4. Impedance is within 5Ω of calibrated measurement (Show above).

4.2 SAR Measurement Procedure

The DASY 5 calculates SAR using the following equation,

$$SAR = \frac{\sigma |E|^2}{\rho}$$

σ : represents the simulated tissue conductivity

ρ : represents the tissue density

The EUT is set to transmit at the required power in line with product specification, at each frequency relating to the LOW, MID, and HIGH channel settings.

Pre-scans are made on the device to establish the location for the transmitting antenna, using a large area scan in either air or tissue simulation fluid.

The EUT is placed against the Universal Phantom where the maximum area scan dimensions are larger than the physical size of the resonating antenna. When the scan size is not large enough to cover the peak SAR distribution, it is modified by either extending the area scan size in both the X and Y directions, or the device is shifted within the predefined area.

The area scan is then run to establish the peak SAR location (interpolated resolution set at 1mm^2) which is then used to orient the center of the zoom scan. The zoom scan is then executed and the 1g and 10g averages are derived from the zoom scan volume (interpolated resolution set at 1mm^3).

5 SAR EXPOSURE LIMITS

SAR assessments have been made in line with the requirements of IEEE-1528, FCC Supplement C, and comply with ANSI/IEEE C95.1-1992 “Uncontrolled Environments” limits. These limits apply to a location which is deemed as “Uncontrolled Environment” which can be described as a situation where the general public may be exposed to an RF source with no prior knowledge or control over their exposure.

Limits for General Population/Uncontrolled Exposure (W/kg)

Type Exposure	Uncontrolled Environment Limit
Spatial Peak SAR (1g cube tissue for brain or body)	1.60 W/kg
Spatial Average SAR (whole body)	0.08 W/kg
Spatial Peak SAR (10g for hands, feet, ankles and wrist)	4.00 W/kg

6 TEST EQUIPMENT LIST

Instrument	Manufacturer	Model No.	Serial No.	Cali. Due Date
Stäubli Robot TX60L	Stäubli	TX60L	F10/5C90A1/A/01	N/A
Controller	Stäubli	SP1	S-0034	N/A
Dipole Validation Kits	Speag	D2450V2	839	2022.03.24
SAM Twin Phantom	Speag	SAM	TP-1561/1562	N/A
Device Holder	Speag	SD 000 H01 HA	N/A	N/A
Data Acquisition Electronic	Speag	DAE4	1220	2022.03.10
E-Field Probe	Speag	EX3DV4	3710	2022.04.08
SAR Software	Speag	DASY5	V5.2 Build 162	N/A
Power Amplifier	Mini-Circuit	ZVA-183-S+	N657400950	N/A
Directional Coupler	Agilent	778D	20160	N/A
Vector Network	Agilent	E5071C	MY48367267	2022.03.08
Signal Generator	Agilent	E4438C	MY49070163	2022.03.08
Spectrum Analyzer	Agilent	N9010A	MY48030494	2022.07.10
Temperature/Humidity Meter	Zhichen	ZC1-2	N/A	2022.04.15
Temperature Meter	Dretec	O-274	RF-001	2021.11.05

7 MEASUREMENT UNCERTAINTY

DASY5 Uncertainty according to IEEE std. 1528-2013								
Measurement uncertainty for 300 MHz to 3 GHz averaged over 1 gram / 10 gram.								
Error Description	Uncert. value	Prob. Dist.	Div.	(ci) 1g	(ci) 10g	Std. Unc.(1g)	Std. Unc.(10g)	(vi) v_{eff}
Measurement System								
Probe Calibration	±6.0%	N	1	1	1	±6.0%	±6.0%	∞
Axial Isotropy	±4.7%	R	$\sqrt{3}$	0.7	0.7	±1.9%	±1.9%	∞
Hemispherical Isotropy	±9.6%	R	$\sqrt{3}$	0.7	0.7	±3.9%	±3.9%	∞
Boundary Effects	±1.0%	R	$\sqrt{3}$	1	1	±0.6%	±0.6%	∞
Linearity	±4.7%	R	$\sqrt{3}$	1	1	±2.7%	±2.7%	∞
System Detection Limits	±1.0%	R	$\sqrt{3}$	1	1	±0.6%	±0.6%	∞
Readout Electronics	±0.3%	N	1	1	1	±0.3%	±0.3%	∞
Response Time	±0.8%	R	$\sqrt{3}$	1	1	±0.5%	±0.5%	∞
Integration Time	±2.6%	R	$\sqrt{3}$	1	1	±1.5%	±1.5%	∞
RF Ambient Noise	±3.0%	R	$\sqrt{3}$	1	1	±1.7%	±1.7%	∞
RF Ambient Reflections	±3.0%	R	$\sqrt{3}$	1	1	±1.7%	±1.7%	∞
Probe Positioner	±0.4%	R	$\sqrt{3}$	1	1	±0.2%	±0.2%	∞
Probe Positioning	±2.9%	R	$\sqrt{3}$	1	1	±1.7%	±1.7%	∞
Max. SAR Eval.	±1.0%	R	$\sqrt{3}$	1	1	±0.6%	±0.6%	∞
Test Sample Related								
Device Positioning	±2.9%	N	1	1	1	±2.9%	±2.9%	145
Device Holder	±3.6%	N	1	1	1	±3.6%	±3.6%	5
Power Drift	±5.0%	R	$\sqrt{3}$	1	1	±2.9%	±2.9%	∞
Phantom and Setup								
Phantom Uncertainty	±4.0%	R	$\sqrt{3}$	1	1	±2.3%	±2.3%	∞
Liquid Conductivity (target)	±5.0%	R	$\sqrt{3}$	0.64	0.43	±1.8%	±1.2%	∞
Liquid Conductivity (meas.)	±2.5%	N	1	0.64	0.43	±1.6%	±1.1%	∞
Liquid Permittivity (target)	±5.0%	R	$\sqrt{3}$	0.6	0.49	±1.7%	±1.4%	∞
Liquid Permittivity (meas.)	±2.5%	N	1	0.6	0.49	±1.5%	±1.2%	∞
Combined Std. Uncertainty						±11.0%	±10.8%	387
Expanded STD Uncertainty						±22.0%	±21.5%	

DASY5 Uncertainty according to IEEE std. 1528-2013								
Measurement uncertainty for 3 GHz to 6 GHz averaged over 1 gram / 10 gram.								
Error Description	Uncert. value	Prob. Dist.	Div.	(ci) 1g	(ci) 10g	Std. Unc. (1g)	Std. Unc. (10g)	(vi) V _{eff}
Measurement System								
Probe Calibration	±6.55%	N	1	1	1	±6.55%	±6.55%	∞
Axial Isotropy	±4.7%	R	$\sqrt{3}$	0.7	0.7	±1.9%	±1.9%	∞
Hemispherical Isotropy	±9.6%	R	$\sqrt{3}$	0.7	0.7	±3.9%	±3.9%	∞
Boundary Effects	±2.0%	R	$\sqrt{3}$	1	1	±1.2%	±1.2%	∞
Linearity	±4.7%	R	$\sqrt{3}$	1	1	±2.7%	±2.7%	∞
System Detection Limits	±1.0%	R	$\sqrt{3}$	1	1	±0.6%	±0.6%	∞
Readout Electronics	±0.3%	N	1	1	1	±0.3%	±0.3%	∞
Response Time	±0.8%	R	$\sqrt{3}$	1	1	±0.5%	±0.5%	∞
Integration Time	±2.6%	R	$\sqrt{3}$	1	1	±1.5%	±1.5%	∞
RF Ambient Noise	±3.0%	R	$\sqrt{3}$	1	1	±1.7%	±1.7%	∞
RF Ambient Reflections	±3.0%	R	$\sqrt{3}$	1	1	±1.7%	±1.7%	∞
Probe Positioner	±0.8%	R	$\sqrt{3}$	1	1	±0.5%	±0.5%	∞
Probe Positioning	±9.9%	R	$\sqrt{3}$	1	1	±5.7%	±5.7%	∞
Max. SAR Eval.	±4.0%	R	$\sqrt{3}$	1	1	±2.3%	±2.3%	∞
Test Sample Related								
Device Positioning	±2.9%	N	1	1	1	±2.9%	±2.9%	145
Device Holder	±3.6%	N	1	1	1	±3.6%	±3.6%	5
Power Drift	±5.0%	R	$\sqrt{3}$	1	1	±2.9%	±2.9%	∞
Phantom and Setup								
Phantom Uncertainty	±4.0%	R	$\sqrt{3}$	1	1	±2.3%	±2.3%	∞
Liquid Conductivity (target)	±5.0%	R	$\sqrt{3}$	0.64	0.43	±1.8%	±1.2%	∞
Liquid Conductivity (meas.)	±2.5%	N	1	0.64	0.43	±1.6%	±1.1%	∞
Liquid Permittivity (target)	±5.0%	R	$\sqrt{3}$	0.6	0.49	±1.7%	±1.4%	∞
Liquid Permittivity (meas.)	±2.5%	N	1	0.6	0.49	±1.5%	±1.2%	∞
Combined Std. Uncertainty						±12.8%	±12.6%	330
Expanded STD Uncertainty						±25.6%	±25.2%	

8 POWER TEST RESULTS

BT Output Power:

Mode	Channel	Test Frequency (MHz)	Conducted Power Output (dBm)	Tune up Power Output (dBm)	Tune up Factor	Result
DH5 (Duty Cycle=100%)	00	2402	6.78	7.00	1.052	Pass
	39	2441	7.29	8.00	1.178	Pass
	78	2480	7.61	8.00	1.094	Pass
2DH5 (Duty Cycle=100%)	01	2412	5.17	6.50	1.358	Pass
	00	2402	5.68	6.50	1.208	Pass
	39	2441	6.02	6.50	1.117	Pass
3DH5 (Duty Cycle=100%)	78	2480	4.89	6.50	1.449	Pass
	00	2402	5.62	6.50	1.225	Pass
	39	2441	5.93	6.50	1.140	Pass
BLE(ONLY) (Duty Cycle=100%)	00	2402	6.31	7.50	1.315	Pass
	19	2440	6.79	7.50	1.178	Pass
	39	2480	6.98	7.50	1.127	Pass

Duty Cycle:

DH5

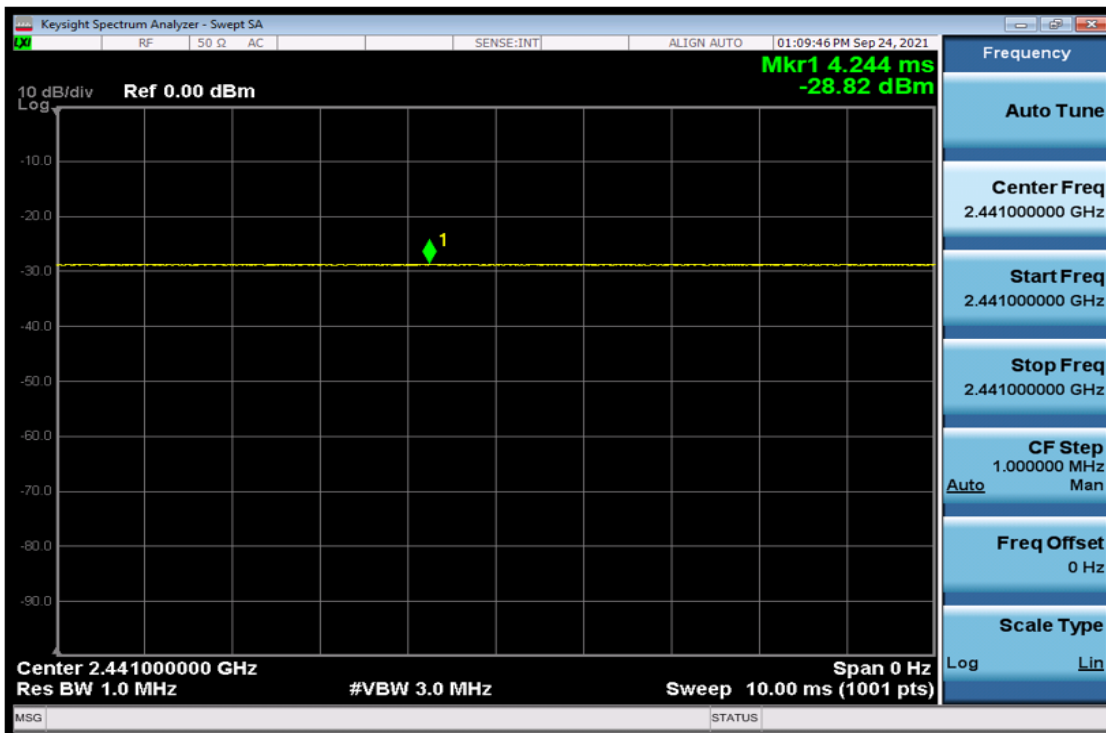

BLE(ONLY)

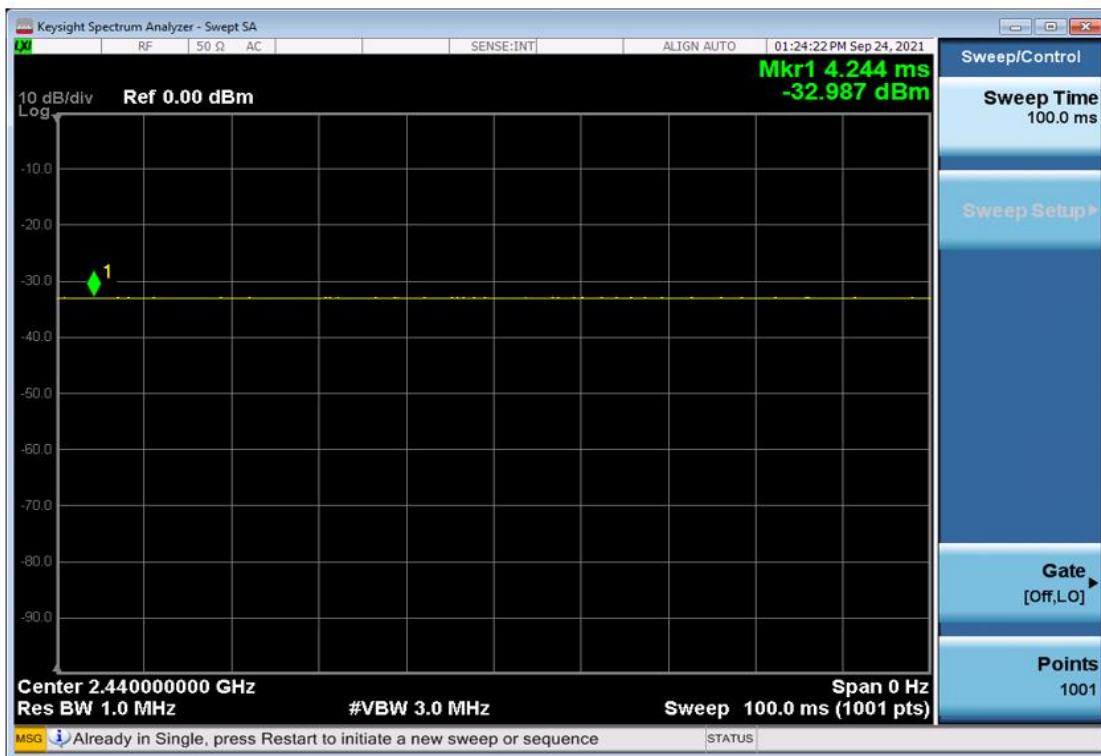

9 SAR TEST RESULTS

9.1 Standalone SAR

SAR MEASUREMENT							
Ambient Temperature (°C) : 21.5 ±2				Relative Humidity (%): 52			
Liquid Temperature (°C) : 21.0 ±2				Depth of Liquid (cm):>15			
Product: Stereo Bluetooth Headset							
Test Position Body	Test Mode	Frequency		Separation Distance (mm)	Power Drift (<±0.2)	SAR 1g (W/kg)	Limit (W/kg)
		Channel	MHz				
Front Side	DH5 1Mbps	78	2480	0	0.12	0.102	1.6
Back Side	DH5 1Mbps	78	2480	0	0.10	0.021	1.6
In Side	DH5 1Mbps	78	2480	0	0.12	0.022	1.6
Out Side	DH5 1Mbps	78	2480	0	0.13	0.070	1.6
Other Side	DH5 1Mbps	78	2480	0	0.04	0.055	1.6
Bottom Side	DH5 1Mbps	78	2480	0	0.18	0.026	1.6
Front Side	DH5 1Mbps	00	2402	0	-0.19	0.046	1.6
Front Side	DH5 1Mbps	39	2441	0	0.19	0.087	1.6
Front Side	BLE(ONLY)	39	2480	0	0.01	0.086	1.6

SAR MEASUREMENT							
Ambient Temperature (°C) : 21.5 ±2				Relative Humidity (%): 52			
Liquid Temperature (°C) : 21.0 ±2				Depth of Liquid (cm):>15			
Product: Stereo Bluetooth Headset							
Test Position Body	Test Mode	Frequency		Scaled Factor	Duty Factor	Reported SAR 1g (W/kg)	Limit (W/kg)
		Cha nnel	MHz				
Front Side	DH5 1Mbps	78	2480	1.094	1.00	0.112	1.6
Back Side	DH5 1Mbps	78	2480	1.094	1.00	0.023	1.6
In Side	DH5 1Mbps	78	2480	1.094	1.00	0.024	1.6
Out Side	DH5 1Mbps	78	2480	1.094	1.00	0.077	1.6
Other Side	DH5 1Mbps	78	2480	1.094	1.00	0.060	1.6
Bottom Side	DH5 1Mbps	78	2480	1.094	1.00	0.028	1.6
Front Side	DH5 1Mbps	00	2402	1.052	1.00	0.048	1.6
Front Side	DH5 1Mbps	39	2441	1.178	1.00	0.102	1.6
Front Side	BLE(ONLY)	39	2480	1.127	1.00	0.097	1.6

Note 1: * - repeated at the highest measured SAR according to the FCC KDB 865664

2: When the reported SAR of the initial test position is > 0.4 W/kg, on the highest maximum output power channel, until the reported SAR is ≤ 0.8 W/kg or all required test positions are tested.

3: For all positions/configurations tested using the initial test position and subsequent test positions, when the reported SAR is > 0.8 W/kg, SAR is measured for these test positions/configurations on the subsequent next highest measured output power channel(s) until the reported SAR is ≤ 1.2 W/kg or all required channels are tested.

4: Per NOTICE 2012-DRS0529, the SAR need to calculated only when the ΔSAR is a negative value.

9.2 Test position and configuration

1. Liquid tissue depth was at least 15.0 cm for all frequencies.
2. The manufacturer has confirmed that the device(s) tested have the same physical, mechanical and thermal characteristics and are within operational tolerances expected for production units.
3. SAR results were scaled to the maximum allowed power to demonstrate compliance per FCC KDB Publication 447498 D01v06.

Appendix A. SAR Validation Data

Date/Time: 9/17/2021

Test Laboratory: DEKRA Lab

System Check head 2450MHz

DUT: Dipole 2450 MHz D2450V2; Type: D2450V2

Communication System: UID 0, CW; Communication System Band: D2450(2450MHz); Duty Cycle: 1:1;

Frequency: 2450 MHz; Medium parameters used: $f = 2450$ MHz; $\sigma = 1.86$ S/m; $\epsilon_r = 38.52$; $\rho = 1000$ kg/m³; Phantom section: Flat Section; Input Power=250mW

Ambient temperature (°C): 21.5, Liquid temperature (°C): 21.0

DASY5 Configuration:

- Probe: EX3DV4 - SN3710; ConvF(7.36, 7.36, 7.36); Calibrated: 4/9/2021
- Sensor-Surface: 4mm (Mechanical Surface Detection)
- Electronics: DAE4 Sn1220; Calibrated: 3/11/2021
- Phantom: SAM2; Type: SAM; Serial: TP1562
- Measurement SW: DASY52, Version 52.10 (4); SEMCAD X Version 14.6.14 (7483)

Configuration/System Check head 2450MHz/Area Scan (7x11x1): Measurement grid: dx=10mm, dy=10mm

Maximum value of SAR (measured) = 15.4 W/kg

Configuration/System Check head 2450MHz/Zoom Scan (7x7x7)/Cube 0: Measurement grid: dx=5mm, dy=5mm, dz=5mm

Reference Value = 92.03 V/m; Power Drift = 0.03 dB

Peak SAR (extrapolated) = 31.1 W/kg

SAR(1 g) = 12.5 W/kg; SAR(10 g) = 6.02 W/kg

Maximum value of SAR (measured) = 17.3 W/kg

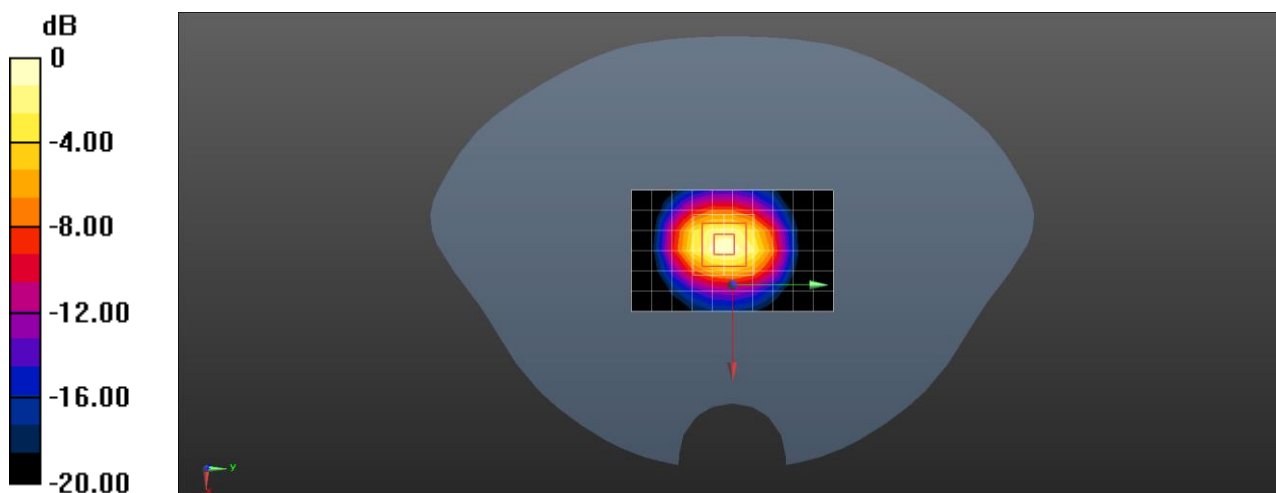

0 dB = 17.3 W/kg = 12.38 dBW/kg

Appendix B. SAR Test Data

Date/Time: 9/23/2021

Test Laboratory: DEKRA Lab

Bluetooth 1Mbps CH78 2480MHz Front Side

DUT: Dongle; Type: B825

Communication System: UID 0, Bluetooth (0); Communication System Band: ISM Band; Duty Cycle: 1:1;

Frequency: 2480 MHz; Medium parameters used: $f = 2480$ MHz; $\sigma = 1.893$ S/m; $\epsilon r = 38.439$; $\rho = 1000$ kg/m³; Phantom section: Flat Section; Input Power=250mW

Ambient temperature (°C): 21.5, Liquid temperature (°C): 21.0

DASY5 Configuration:

- Probe: EX3DV4 - SN3710; ConvF(7.36, 7.36, 7.36); Calibrated: 4/9/2021
- Sensor-Surface: 4mm (Mechanical Surface Detection)
- Electronics: DAE4 Sn1220; Calibrated: 3/11/2021
- Phantom: SAM2; Type: SAM; Serial: TP1562
- Measurement SW: DASY52, Version 52.10 (4); SEMCAD X Version 14.6.14 (7483)

Configuration/DH5 1Mbps CH78 2480MHz Front Side/Area Scan (10x14x1): Measurement grid:

dx=12mm, dy=12mm

Maximum value of SAR (measured) = 0.0947 W/kg

Configuration/DH5 1Mbps CH78 2480MHz Front Side/Zoom Scan (7x7x5)/Cube 0: Measurement grid:

dx=5mm, dy=5mm, dz=4mm

Reference Value = 2.691 V/m; Power Drift = 0.12 dB

Peak SAR (extrapolated) = 0.258 W/kg

SAR(1 g) = 0.102 W/kg; SAR(10 g) = 0.041 W/kg

Maximum value of SAR (measured) = 0.118 W/kg

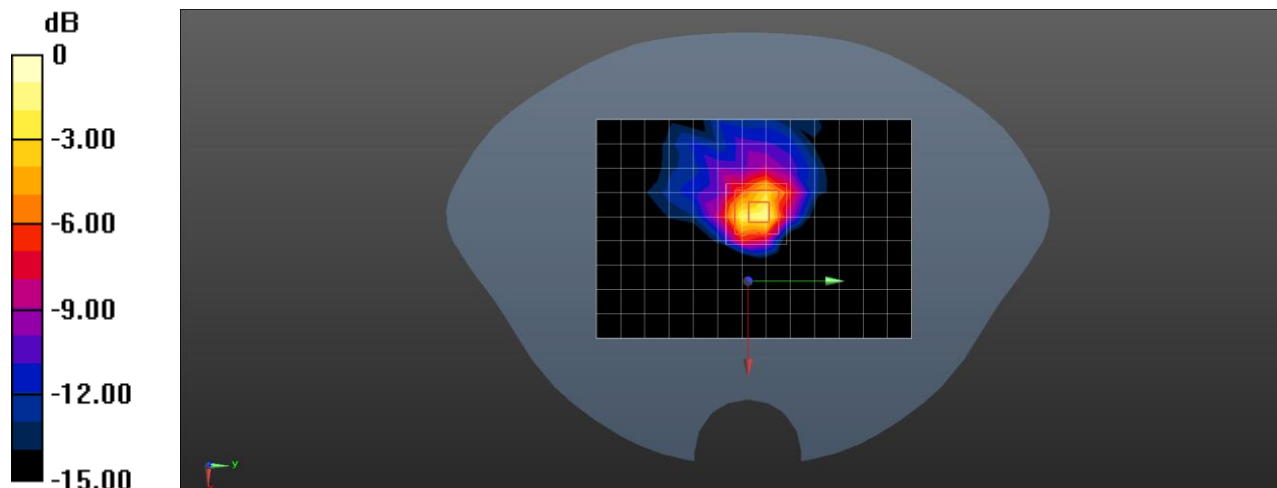

0 dB = 0.118 W/kg = -9.28 dBW/kg

Date/Time: 9/23/2021

Test Laboratory: DEKRA Lab

Bluetooth 1Mbps CH78 2480MHz Back Side

DUT: Dongle; Type: B825

Communication System: UID 0, Bluetooth (0); Communication System Band: ISM Band; Duty Cycle: 1:1;

Frequency: 2480 MHz; Medium parameters used: $f = 2480$ MHz; $\sigma = 1.893$ S/m; $\epsilon r = 38.439$; $\rho = 1000$ kg/m³; Phantom section: Flat Section; Input Power=250mW

Ambient temperature (°C): 21.5, Liquid temperature (°C): 21.0

DASY5 Configuration:

- Probe: EX3DV4 - SN3710; ConvF(7.36, 7.36, 7.36); Calibrated: 4/9/2021
- Sensor-Surface: 4mm (Mechanical Surface Detection)
- Electronics: DAE4 Sn1220; Calibrated: 3/11/2021
- Phantom: SAM2; Type: SAM; Serial: TP1562
- Measurement SW: DASY52, Version 52.10 (4); SEMCAD X Version 14.6.14 (7483)

Configuration/DH5 1Mbps CH78 2480MHz Back Side/Area Scan (10x14x1): Measurement grid: dx=12mm, dy=12mm

Maximum value of SAR (measured) = 0.0208 W/kg

Configuration/DH5 1Mbps CH78 2480MHz Back Side/Zoom Scan (8x8x5)/Cube 0: Measurement grid: dx=5mm, dy=5mm, dz=4mm

Reference Value = 2.089 V/m; Power Drift = 0.10 dB

Peak SAR (extrapolated) = 0.0300 W/kg

SAR(1 g) = 0.021 W/kg; SAR(10 g) = 0.012 W/kg

Maximum value of SAR (measured) = 0.0229 W/kg

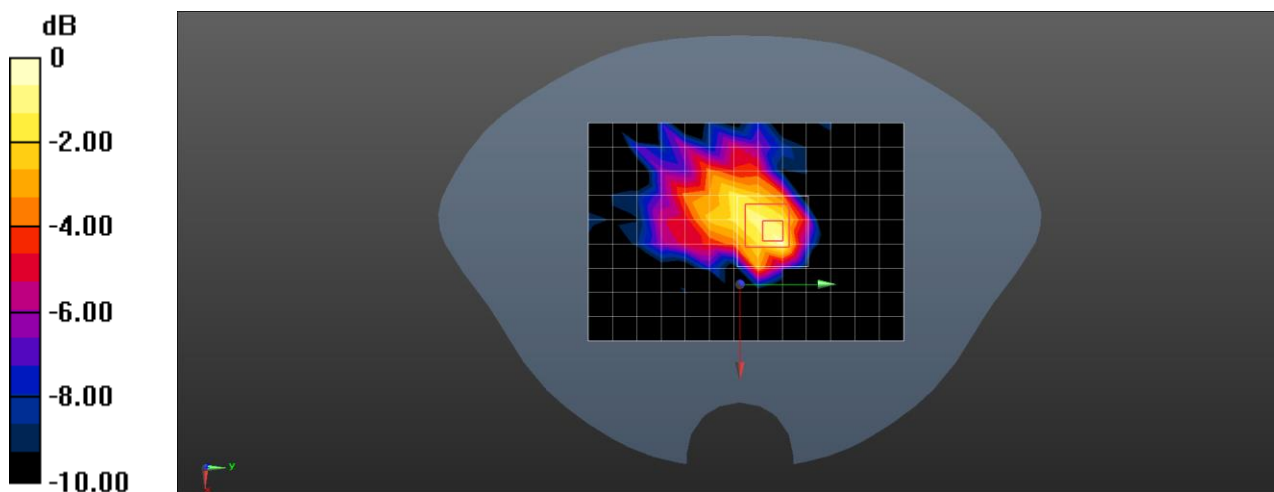

0 dB = 0.0229 W/kg = -16.40 dBW/kg

Date/Time: 9/23/2021

Test Laboratory: DEKRA Lab

Bluetooth 1Mbps CH78 2480MHz In Side

DUT: Dongle; Type: B825

Communication System: UID 0, Bluetooth (0); Communication System Band: ISM Band; Duty Cycle: 1:1;

Frequency: 2480 MHz; Medium parameters used: $f = 2480$ MHz; $\sigma = 1.893$ S/m; $\epsilon r = 38.439$; $\rho = 1000$ kg/m³ ; Phantom section: Flat Section ; Input Power=250mW

Ambient temperature (°C): 21.5, Liquid temperature (°C): 21.0

DASY5 Configuration:

- Probe: EX3DV4 - SN3710; ConvF(7.36, 7.36, 7.36); Calibrated: 4/9/2021
- Sensor-Surface: 4mm (Mechanical Surface Detection)
- Electronics: DAE4 Sn1220; Calibrated: 3/11/2021
- Phantom: SAM2; Type: SAM; Serial: TP1562
- Measurement SW: DASY52, Version 52.10 (4); SEMCAD X Version 14.6.14 (7483)

Configuration/DH5 1Mbps CH78 2480MHz In Side/Area Scan (10x14x1): Measurement grid: dx=12mm, dy=12mm

Maximum value of SAR (measured) = 0.0224 W/kg

Configuration/DH5 1Mbps CH78 2480MHz In Side/Zoom Scan (7x7x5)/Cube 0: Measurement grid:

dx=5mm, dy=5mm, dz=4mm

Reference Value = 2.533 V/m; Power Drift = 0.12 dB

Peak SAR (extrapolated) = 0.0370 W/kg

SAR(1 g) = 0.022 W/kg; SAR(10 g) = 0.010 W/kg

Maximum value of SAR (measured) = 0.0260 W/kg

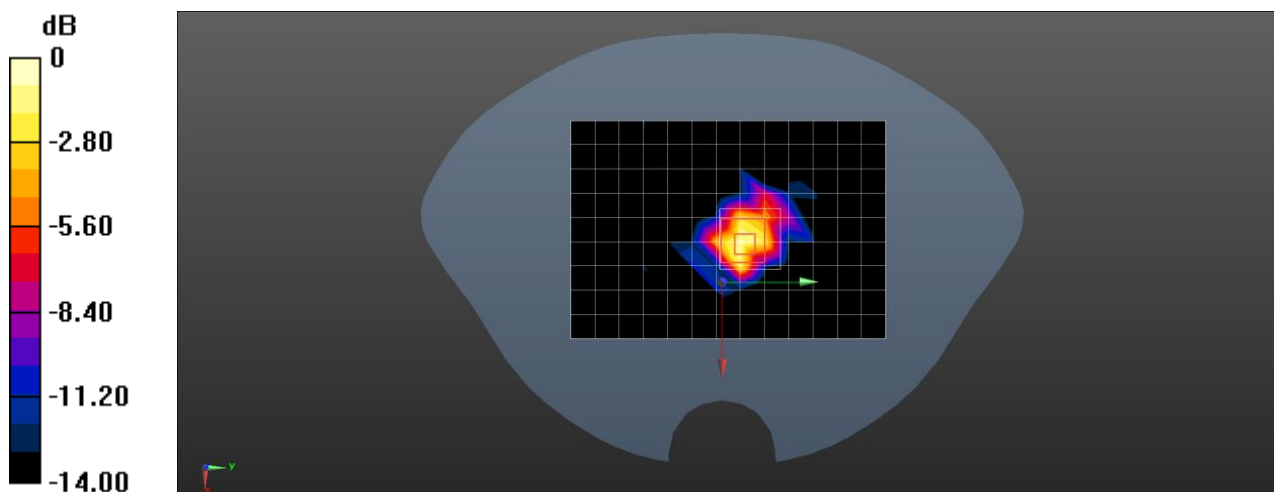

0 dB = 0.0260 W/kg = -15.85 dBW/kg

Date/Time: 9/23/2021

Test Laboratory: DEKRA Lab

Bluetooth 1Mbps CH78 2480MHz Out Side

DUT: Dongle; Type: B825

Communication System: UID 0, Bluetooth (0); Communication System Band: ISM Band; Duty Cycle: 1:1;

Frequency: 2480 MHz; Medium parameters used: $f = 2480$ MHz; $\sigma = 1.893$ S/m; $\epsilon r = 38.439$; $\rho = 1000$ kg/m³ ; Phantom section: Flat Section ; Input Power=250mW

Ambient temperature (°C): 21.5, Liquid temperature (°C): 21.0

DASY5 Configuration:

- Probe: EX3DV4 - SN3710; ConvF(7.36, 7.36, 7.36); Calibrated: 4/9/2021
- Sensor-Surface: 4mm (Mechanical Surface Detection)
- Electronics: DAE4 Sn1220; Calibrated: 3/11/2021
- Phantom: SAM2; Type: SAM; Serial: TP1562
- Measurement SW: DASY52, Version 52.10 (4); SEMCAD X Version 14.6.14 (7483)

Configuration/DH5 1Mbps CH78 2480MHz Out Side/Area Scan (10x14x1): Measurement grid: dx=12mm, dy=12mm

Maximum value of SAR (measured) = 0.0747 W/kg

Configuration/DH5 1Mbps CH78 2480MHz Out Side/Zoom Scan (7x7x5)/Cube 0: Measurement grid:

dx=5mm, dy=5mm, dz=4mm

Reference Value = 6.291 V/m; Power Drift = 0.13 dB

Peak SAR (extrapolated) = 0.132 W/kg

SAR(1 g) = 0.070 W/kg; SAR(10 g) = 0.037 W/kg

Maximum value of SAR (measured) = 0.0769 W/kg

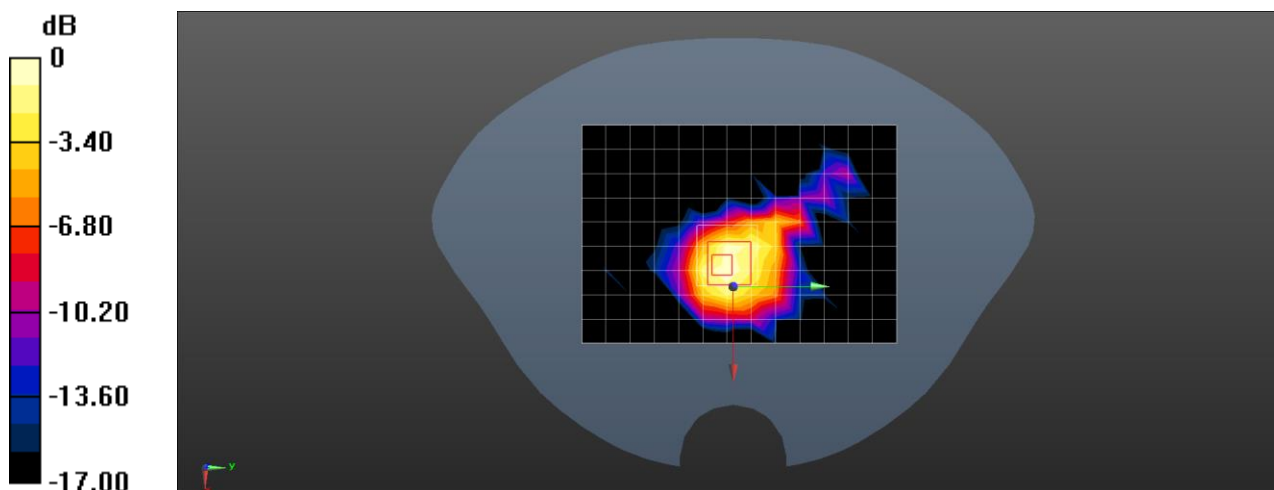

0 dB = 0.0769 W/kg = -11.14 dBW/kg

Date/Time: 9/23/2021

Test Laboratory: DEKRA Lab

Bluetooth 1Mbps CH78 2480MHz Other Side

DUT: Dongle; Type: B825

Communication System: UID 0, Bluetooth (0); Communication System Band: ISM Band; Duty Cycle: 1:1;

Frequency: 2480 MHz; Medium parameters used: $f = 2480$ MHz; $\sigma = 1.893$ S/m; $\epsilon r = 38.439$; $\rho = 1000$ kg/m³ ; Phantom section: Flat Section ; Input Power=250mW

Ambient temperature (°C): 21.5, Liquid temperature (°C): 21.0

DASY5 Configuration:

- Probe: EX3DV4 - SN3710; ConvF(7.36, 7.36, 7.36); Calibrated: 4/9/2021
- Sensor-Surface: 4mm (Mechanical Surface Detection)
- Electronics: DAE4 Sn1220; Calibrated: 3/11/2021
- Phantom: SAM2; Type: SAM; Serial: TP1562
- Measurement SW: DASY52, Version 52.10 (4); SEMCAD X Version 14.6.14 (7483)

Configuration/DH5 1Mbps CH78 2480MHz Other Side/Area Scan (10x14x1): Measurement grid:

dx=12mm, dy=12mm

Maximum value of SAR (measured) = 0.0560 W/kg

Configuration/DH5 1Mbps CH78 2480MHz Other Side/Zoom Scan (7x7x5)/Cube 0: Measurement grid:

dx=5mm, dy=5mm, dz=4mm

Reference Value = 5.339 V/m; Power Drift = 0.04 dB

Peak SAR (extrapolated) = 0.0980 W/kg

SAR(1 g) = 0.055 W/kg; SAR(10 g) = 0.028 W/kg

Maximum value of SAR (measured) = 0.0626 W/kg

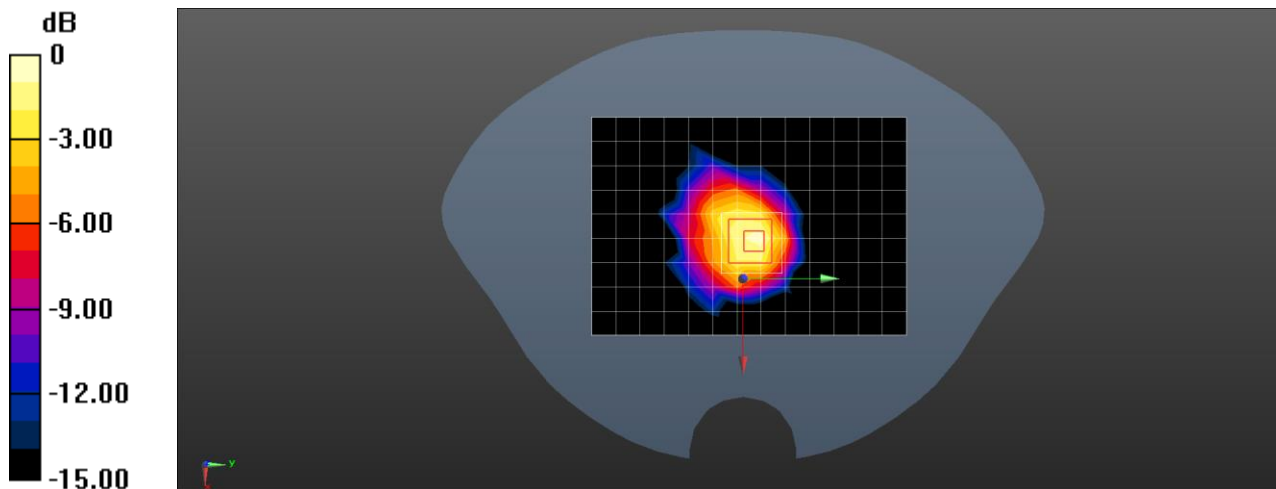

0 dB = 0.0626 W/kg = -12.03 dBW/kg

Date/Time: 9/23/2021

Test Laboratory: DEKRA Lab

Bluetooth 1Mbps CH78 2480MHz Bottom Side

DUT: Dongle; Type: B825

Communication System: UID 0, Bluetooth (0); Communication System Band: ISM Band; Duty Cycle: 1:1;

Frequency: 2480 MHz; Medium parameters used: $f = 2480$ MHz; $\sigma = 1.893$ S/m; $\epsilon r = 38.439$; $\rho = 1000$ kg/m³ ; Phantom section: Flat Section ; Input Power=250mW

Ambient temperature (°C): 21.5, Liquid temperature (°C): 21.0

DASY5 Configuration:

- Probe: EX3DV4 - SN3710; ConvF(7.36, 7.36, 7.36); Calibrated: 4/9/2021
- Sensor-Surface: 4mm (Mechanical Surface Detection)
- Electronics: DAE4 Sn1220; Calibrated: 3/11/2021
- Phantom: SAM2; Type: SAM; Serial: TP1562
- Measurement SW: DASY52, Version 52.10 (4); SEMCAD X Version 14.6.14 (7483)

Configuration/DH5 1Mbps CH78 2480MHz Bottom Side/Area Scan (10x14x1): Measurement grid:

dx=12mm, dy=12mm

Maximum value of SAR (measured) = 0.0272 W/kg

Configuration/DH5 1Mbps CH78 2480MHz Bottom Side/Zoom Scan (8x8x5)/Cube 0: Measurement grid:

dx=5mm, dy=5mm, dz=4mm

Reference Value = 3.372 V/m; Power Drift = 0.18 dB

Peak SAR (extrapolated) = 0.0550 W/kg

SAR(1 g) = 0.026 W/kg; SAR(10 g) = 0.013 W/kg

Maximum value of SAR (measured) = 0.0295 W/kg

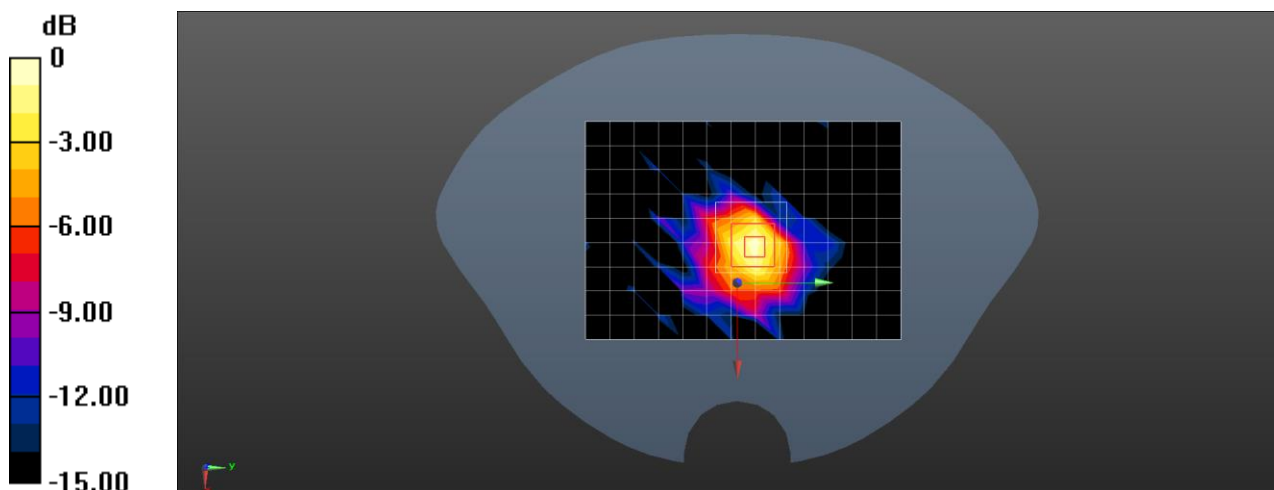

0 dB = 0.0295 W/kg = -15.30 dBW/kg

Date/Time: 9/23/2021

Test Laboratory: DEKRA Lab

Bluetooth 1Mbps CH0 2402MHz Front Side

DUT: Dongle; Type: B825

Communication System: UID 0, Bluetooth (0); Communication System Band: ISM Band; Duty Cycle: 1:1;

Frequency: 2402 MHz; Medium parameters used (interpolated): $f = 2402$ MHz; $\sigma = 1.802$ S/m; $\epsilon_r = 38.729$;

$\rho = 1000$ kg/m³ ; Phantom section: Flat Section ; Input Power=250mW

Ambient temperature (°C): 21.5, Liquid temperature (°C): 21.0

DASY5 Configuration:

- Probe: EX3DV4 - SN3710; ConvF(7.36, 7.36, 7.36); Calibrated: 4/9/2021
- Sensor-Surface: 4mm (Mechanical Surface Detection)
- Electronics: DAE4 Sn1220; Calibrated: 3/11/2021
- Phantom: SAM2; Type: SAM; Serial: TP1562
- Measurement SW: DASY52, Version 52.10 (4); SEMCAD X Version 14.6.14 (7483)

Configuration/DH5 1Mbps CH0 2402MHz Front Side/Area Scan (10x14x1): Measurement grid: dx=12mm, dy=12mm

Maximum value of SAR (measured) = 0.0484 W/kg

Configuration/DH5 1Mbps CH0 2402MHz Front Side/Zoom Scan (7x8x5)/Cube 0: Measurement grid:

dx=5mm, dy=5mm, dz=4mm

Reference Value = 1.213 V/m; Power Drift = -0.19 dB

Peak SAR (extrapolated) = 0.0970 W/kg

SAR(1 g) = 0.046 W/kg; SAR(10 g) = 0.020 W/kg

Maximum value of SAR (measured) = 0.0532 W/kg

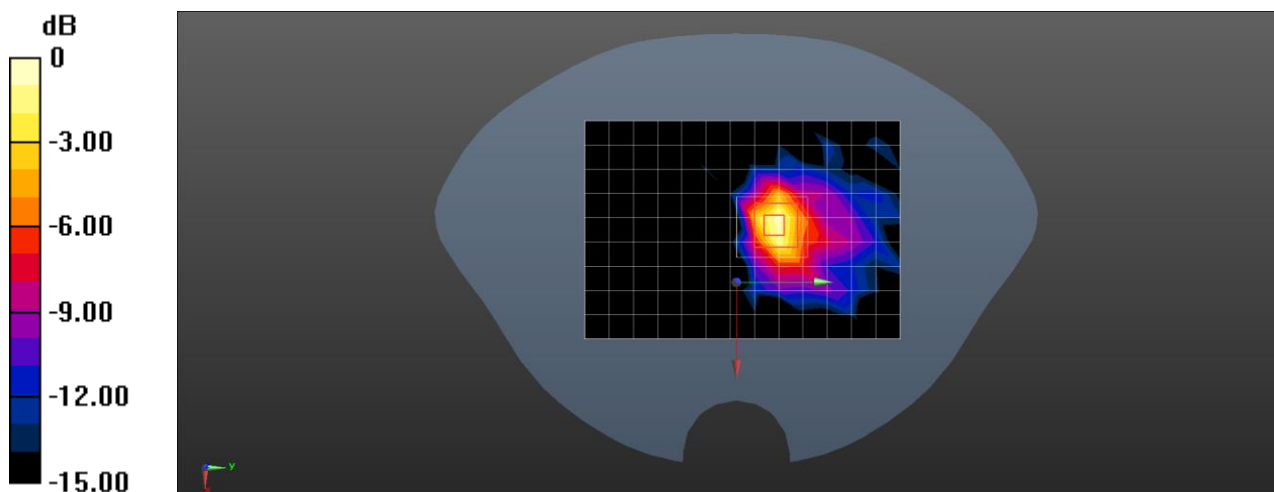

0 dB = 0.0532 W/kg = -12.74 dBW/kg

Date/Time: 9/23/2021

Test Laboratory: DEKRA Lab

Bluetooth 1Mbps CH39 2441MHz Front Side

DUT: Dongle; Type: B825

Communication System: UID 0, Bluetooth (0); Communication System Band: ISM Band; Duty Cycle: 1:1;

Frequency: 2441 MHz; Medium parameters used (interpolated): $f = 2441$ MHz; $\sigma = 1.848$ S/m; $\epsilon_r = 38.571$;

$\rho = 1000$ kg/m³ ; Phantom section: Flat Section ; Input Power=250mW

Ambient temperature (°C): 21.5, Liquid temperature (°C): 21.0

DASY5 Configuration:

- Probe: EX3DV4 - SN3710; ConvF(7.36, 7.36, 7.36); Calibrated: 4/9/2021
- Sensor-Surface: 4mm (Mechanical Surface Detection)
- Electronics: DAE4 Sn1220; Calibrated: 3/11/2021
- Phantom: SAM2; Type: SAM; Serial: TP1562
- Measurement SW: DASY52, Version 52.10 (4); SEMCAD X Version 14.6.14 (7483)

Configuration/DH5 1Mbps CH39 2441MHz Front Side/Area Scan (10x14x1): Measurement grid:

dx=12mm, dy=12mm

Maximum value of SAR (measured) = 0.0740 W/kg

Configuration/DH5 1Mbps CH39 2441MHz Front Side /Zoom Scan (7x7x5)/Cube 0: Measurement grid:

dx=5mm, dy=5mm, dz=4mm

Reference Value = 7.015 V/m; Power Drift = 0.19 dB

Peak SAR (extrapolated) = 0.214 W/kg

SAR(1 g) = 0.087 W/kg; SAR(10 g) = 0.035 W/kg

Maximum value of SAR (measured) = 0.0966 W/kg

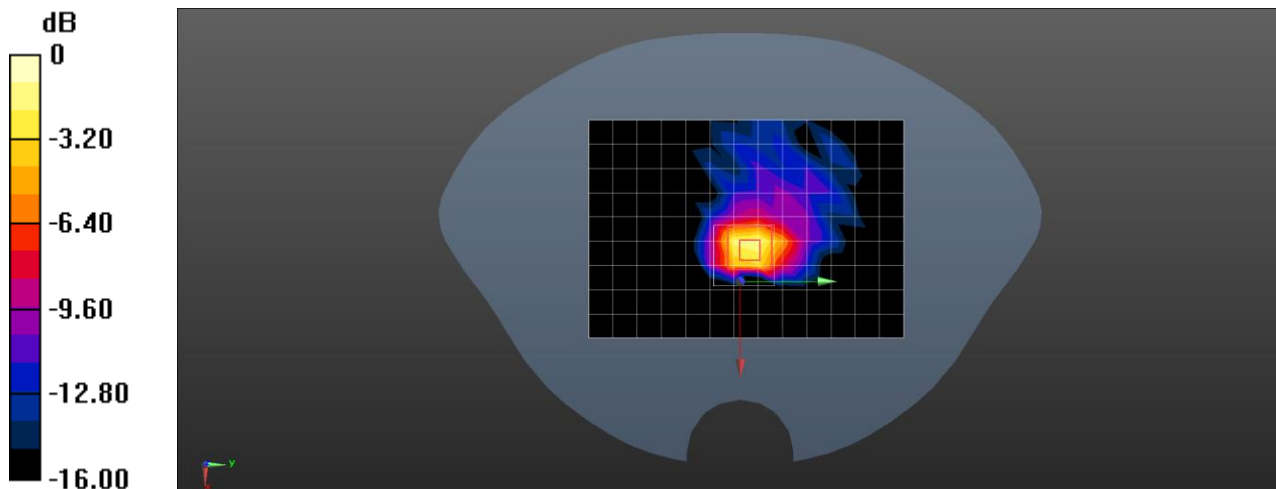

0 dB = 0.0966 W/kg = -10.15 dBW/kg

Date/Time: 9/23/2021

Test Laboratory: DEKRA Lab

Bluetooth BLE(ONLY) CH39 2480MHz Front Side

DUT: Dongle; Type: B825

Communication System: UID 0, Bluetooth (0); Communication System Band: BLE; Duty Cycle: 1:1;

Frequency: 2480 MHz; Medium parameters used: $f = 2480$ MHz; $\sigma = 1.893$ S/m; $\epsilon r = 38.439$; $\rho = 1000$ kg/m³; Phantom section: Flat Section; Input Power=250mW

Ambient temperature (°C): 21.5, Liquid temperature (°C): 21.0

DASY5 Configuration:

- Probe: EX3DV4 - SN3710; ConvF(7.36, 7.36, 7.36); Calibrated: 4/9/2021
- Sensor-Surface: 4mm (Mechanical Surface Detection)
- Electronics: DAE4 Sn1220; Calibrated: 3/11/2021
- Phantom: SAM2; Type: SAM; Serial: TP1562
- Measurement SW: DASY52, Version 52.10 (4); SEMCAD X Version 14.6.14 (7483)

Configuration/BLE CH39 2480MHz Front Side/Area Scan (10x14x1): Measurement grid: dx=12mm, dy=12mm

Maximum value of SAR (measured) = 0.0967 W/kg

Configuration/BLE CH39 2480MHz Front Side/Zoom Scan (7x7x5)/Cube 0: Measurement grid: dx=5mm, dy=5mm, dz=4mm

Reference Value = 5.271 V/m; Power Drift = 0.01 dB

Peak SAR (extrapolated) = 0.226 W/kg

SAR(1 g) = 0.086 W/kg; SAR(10 g) = 0.037 W/kg

Maximum value of SAR (measured) = 0.113 W/kg

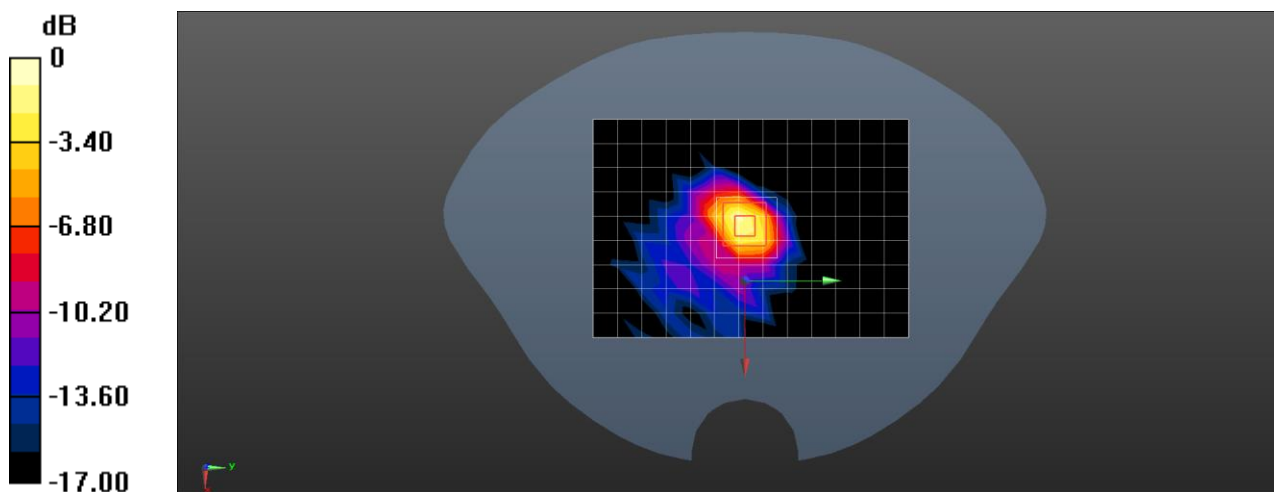

0 dB = 0.113 W/kg = -9.47 dBW/kg

Appendix C. Probe Calibration Data



In Collaboration with
TTL **s p e a g**
 CALIBRATION LABORATORY
 Add: No.52 HuaYuanBei Road, Haidian District, Beijing, 100191, China
 Tel: +86-10-62304633-2512 Fax: +86-10-62304633-2504
 E-mail: ctl@chinatl.com [Http://www.chinatl.cn](http://www.chinatl.cn)



中国认可
 国际互认
 校准
 CALIBRATION
 CNAS L0570

Client **Dekra-CN**

Certificate No: **Z21-60051**

CALIBRATION CERTIFICATE			
Object	EX3DV4 - SN : 3710		
Calibration Procedure(s)	FF-Z11-004-02 Calibration Procedures for Dosimetric E-field Probes		
Calibration date:	April 09, 2021		
<p>This calibration Certificate documents the traceability to national standards, which realize the physical units of measurements(SI). The measurements and the uncertainties with confidence probability are given on the following pages and are part of the certificate.</p> <p>All calibrations have been conducted in the closed laboratory facility: environment temperature(22±3)°C and humidity<70%.</p> <p>Calibration Equipment used (M&TE critical for calibration)</p>			
Primary Standards	ID #	Cal Date(Calibrated by, Certificate No.)	Scheduled Calibration
Power Meter NRP2	101919	16-Jun-20(CTTL, No.J20X04344)	Jun-21
Power sensor NRP-Z91	101547	16-Jun-20(CTTL, No.J20X04344)	Jun-21
Power sensor NRP-Z91	101548	16-Jun-20(CTTL, No.J20X04344)	Jun-21
Reference 10dBAttenuator	18N50W-10dB	10-Feb-20(CTTL, No.J20X00525)	Feb-22
Reference 20dBAttenuator	18N50W-20dB	10-Feb-20(CTTL, No.J20X00526)	Feb-22
Reference Probe EX3DV4	SN 7307	29-May-20(SPEAG, No.EX3-7307_May20)	May-21
DAE4	SN 1555	25-Aug-20(SPEAG, No.DAE4-1555_Aug20)	Aug-21
Secondary Standards	ID #	Cal Date(Calibrated by, Certificate No.)	Scheduled Calibration
SignalGenerator MG3700A	6201052605	23-Jun-20(CTTL, No.J20X04343)	Jun-21
Network Analyzer E5071C	MY46110673	21-Jan-21(CTTL, No.J20X00515)	Jan-22
Calibrated by:	Name	Function	Signature
	Yu Zongying	SAR Test Engineer	
Reviewed by:	Lin Hao	SAR Test Engineer	
Approved by:	Qi Dianyuan	SAR Project Leader	
Issued: April 11, 2021			
This calibration certificate shall not be reproduced except in full without written approval of the laboratory.			



Add: No.52 HuaYuanBei Road, Haidian District, Beijing, 100191, China
 Tel: +86-10-62304633-2512 Fax: +86-10-62304633-2504
 E-mail: cttl@chinattl.com [Http://www.chinattl.cn](http://www.chinattl.cn)

Glossary:

TSL	tissue simulating liquid
NORM _{x,y,z}	sensitivity in free space
ConvF	sensitivity in TSL / NORM _{x,y,z}
DCP	diode compression point
CF	crest factor (1/duty_cycle) of the RF signal
A,B,C,D	modulation dependent linearization parameters
Polarization Φ	Φ rotation around probe axis
Polarization θ	θ rotation around an axis that is in the plane normal to probe axis (at measurement center), i θ=0 is normal to probe axis

Connector Angle information used in DASY system to align probe sensor X to the robot coordinate system

Calibration is Performed According to the Following Standards:

- a) IEEE Std 1528-2013, "IEEE Recommended Practice for Determining the Peak Spatial-Averaged Specific Absorption Rate (SAR) in the Human Head from Wireless Communications Devices: Measurement Techniques", June 2013
- b) IEC 62209-1, "Measurement procedure for the assessment of Specific Absorption Rate (SAR) from hand-held and body-mounted devices used next to the ear (frequency range of 300 MHz to 6 GHz)", July 2016
- c) IEC 62209-2, "Procedure to determine the Specific Absorption Rate (SAR) for wireless communication devices used in close proximity to the human body (frequency range of 30 MHz to 6 GHz)", March 2010
- d) KDB 865664, "SAR Measurement Requirements for 100 MHz to 6 GHz"

Methods Applied and Interpretation of Parameters:

- *NORM_{x,y,z}*: Assessed for E-field polarization θ=0 (f≤900MHz in TEM-cell; f>1800MHz: waveguide). NORM_{x,y,z} are only intermediate values, i.e., the uncertainties of NORM_{x,y,z} does not effect the E²-field uncertainty inside TSL (see below ConvF).
- *NORM(f)_{x,y,z} = NORM_{x,y,z}* frequency_response* (see Frequency Response Chart). This linearization is implemented in DASY4 software versions later than 4.2. The uncertainty of the frequency response is included in the stated uncertainty of ConvF.
- *DCP_{x,y,z}*: DCP are numerical linearization parameters assessed based on the data of power sweep (no uncertainty required). DCP does not depend on frequency nor media.
- *PAR*: PAR is the Peak to Average Ratio that is not calibrated but determined based on the signal characteristics.
- *A_{x,y,z}; B_{x,y,z}; C_{x,y,z}; VR_{x,y,z}; A,B,C* are numerical linearization parameters assessed based on the data of power sweep for specific modulation signal. The parameters do not depend on frequency nor media. VR is the maximum calibration range expressed in RMS voltage across the diode.
- *ConvF and Boundary Effect Parameters*: Assessed in flat phantom using E-field (or Temperature Transfer Standard for f≤800MHz) and inside waveguide using analytical field distributions based on power measurements for f >800MHz. The same setups are used for assessment of the parameters applied for boundary compensation (alpha, depth) of which typical uncertainty valued are given. These parameters are used in DASY4 software to improve probe accuracy close to the boundary. The sensitivity in TSL corresponds to NORM_{x,y,z}* ConvF whereby the uncertainty corresponds to that given for ConvF. A frequency dependent ConvF is used in DASY version 4.4 and higher which allows extending the validity from ±50MHz to ±100MHz.
- *Spherical isotropy (3D deviation from isotropy)*: in a field of low gradients realized using a flat phantom exposed by a patch antenna.
- *Sensor Offset*: The sensor offset corresponds to the offset of virtual measurement center from the probe tip (on probe axis). No tolerance required.
- *Connector Angle*: The angle is assessed using the information gained by determining the NORM_x (no uncertainty required).



Add: No.52 HuaYuanBei Road, Haidian District, Beijing, 100191, China
 Tel: +86-10-62304633-2512 Fax: +86-10-62304633-2504
 E-mail: ctl@chinattl.com [Http://www.chinattl.cn](http://www.chinattl.cn)

DASY/EASY – Parameters of Probe: EX3DV4 – SN:3710

Basic Calibration Parameters

	Sensor X	Sensor Y	Sensor Z	Unc (k=2)
Norm($\mu\text{V}/(\text{V}/\text{m})^2$) ^A	0.37	0.40	0.49	±10.0%
DCP(mV) ^B	102.1	102.7	102.5	

Modulation Calibration Parameters

UID	Communication System Name		A dB	B dB/μV	C	D dB	VR mV	Unc ^E (k=2)
0	CW	X	0.0	0.0	1.0	0.00	140.3	±2.0%
		Y	0.0	0.0	1.0		149.1	
		Z	0.0	0.0	1.0		170.6	

The reported uncertainty of measurement is stated as the standard uncertainty of Measurement multiplied by the coverage factor $k=2$, which for a normal distribution Corresponds to a coverage probability of approximately 95%.

^A The uncertainties of Norm X, Y, Z do not affect the E²-field uncertainty inside TSL (see Page 4 and Page 5).

^B Numerical linearization parameter: uncertainty not required.

^E Uncertainty is determined using the max. deviation from linear response applying rectangular distribution and is expressed for the square of the field value.



Add: No.52 HuaYuanBei Road, Haidian District, Beijing, 100191, China
 Tel: +86-10-62304633-2512 Fax: +86-10-62304633-2504
 E-mail: ctl@chinattl.com [Http://www.chinattl.cn](http://www.chinattl.cn)

DASY/EASY – Parameters of Probe: EX3DV4 – SN:3710

Calibration Parameter Determined in Head Tissue Simulating Media

f [MHz] ^C	Relative Permittivity ^F	Conductivity (S/m) ^F	ConvF X	ConvF Y	ConvF Z	Alpha ^G	Depth ^G (mm)	Unct. (k=2)
750	41.9	0.89	9.57	9.57	9.57	0.40	0.80	±12.1%
835	41.5	0.90	9.32	9.32	9.32	0.14	1.41	±12.1%
900	41.5	0.97	9.29	9.29	9.29	0.16	1.37	±12.1%
1810	40.0	1.40	7.92	7.92	7.92	0.29	0.97	±12.1%
1900	40.0	1.40	7.83	7.83	7.83	0.24	1.11	±12.1%
2450	39.2	1.80	7.36	7.36	7.36	0.47	0.82	±12.1%
2600	39.0	1.96	7.11	7.11	7.11	0.39	0.98	±12.1%
3500	37.9	2.91	6.76	6.76	6.76	0.43	1.02	±13.3%
5250	35.9	4.71	5.30	5.30	5.30	0.45	1.46	±13.3%
5600	35.5	5.07	4.75	4.75	4.75	0.55	1.36	±13.3%
5750	35.4	5.22	4.80	4.80	4.80	0.55	1.40	±13.3%

^C Frequency validity above 300 MHz of ±100MHz only applies for DASY v4.4 and higher (Page 2), else it is restricted to ±50MHz. The uncertainty is the RSS of ConvF uncertainty at calibration frequency and the uncertainty for the indicated frequency band. Frequency validity below 300 MHz is ± 10, 25, 40, 50 and 70 MHz for ConvF assessments at 30, 64, 128, 150 and 220 MHz respectively. Above 5 GHz frequency validity can be extended to ± 110 MHz.

^F At frequency below 3 GHz, the validity of tissue parameters (ϵ and σ) can be relaxed to ±10% if liquid compensation formula is applied to measured SAR values. At frequencies above 3 GHz, the validity of tissue parameters (ϵ and σ) is restricted to ±5%. The uncertainty is the RSS of the ConvF uncertainty for indicated target tissue parameters.

^G Alpha/Depth are determined during calibration. SPEAG warrants that the remaining deviation due to the boundary effect after compensation is always less than ± 1% for frequencies below 3 GHz and below ± 2% for the frequencies between 3-6 GHz at any distance larger than half the probe tip diameter from the boundary.



Add: No.52 HuaYuanBei Road, Haidian District, Beijing, 100191, China
 Tel: +86-10-62304633-2512 Fax: +86-10-62304633-2504
 E-mail: ttl@chinattl.com [Http://www.chinattl.cn](http://www.chinattl.cn)

DASY/EASY – Parameters of Probe: EX3DV4 – SN:3710

Calibration Parameter Determined in Body Tissue Simulating Media

f [MHz] ^C	Relative Permittivity ^F	Conductivity (S/m) ^F	ConvF X	ConvF Y	ConvF Z	Alpha ^G	Depth ^G (mm)	Unct. (k=2)
750	55.5	0.96	9.70	9.70	9.70	0.40	0.80	±12.1%
835	55.2	0.97	9.31	9.31	9.31	0.19	1.34	±12.1%
900	55.0	1.05	9.27	9.27	9.27	0.20	1.30	±12.1%
1810	53.3	1.52	7.68	7.68	7.68	0.20	1.27	±12.1%
1900	53.3	1.52	7.61	7.61	7.61	0.18	1.34	±12.1%
2450	52.7	1.95	7.34	7.34	7.34	0.69	0.69	±12.1%
2600	52.5	2.16	7.14	7.14	7.14	0.65	0.71	±12.1%
3500	51.3	3.31	6.31	6.31	6.31	0.40	1.25	±13.3%
5250	48.9	5.36	4.63	4.63	4.63	0.55	1.60	±13.3%
5600	48.5	5.77	4.06	4.06	4.06	0.60	1.60	±13.3%
5750	48.3	5.94	4.07	4.07	4.07	0.60	1.70	±13.3%

^C Frequency validity above 300 MHz of ±100MHz only applies for DASY v4.4 and higher (Page 2), else it is restricted to ±50MHz. The uncertainty is the RSS of ConvF uncertainty at calibration frequency and the uncertainty for the indicated frequency band. Frequency validity below 300 MHz is ± 10, 25, 40, 50 and 70 MHz for ConvF assessments at 30, 64, 128, 150 and 220 MHz respectively. Above 5 GHz frequency validity can be extended to ± 110 MHz.

^F At frequency below 3 GHz, the validity of tissue parameters (ϵ and σ) can be relaxed to ±10% if liquid compensation formula is applied to measured SAR values. At frequencies above 3 GHz, the validity of tissue parameters (ϵ and σ) is restricted to ±5%. The uncertainty is the RSS of the ConvF uncertainty for indicated target tissue parameters.

^G Alpha/Depth are determined during calibration. SPEAG warrants that the remaining deviation due to the boundary effect after compensation is always less than ± 1% for frequencies below 3 GHz and below ± 2% for the frequencies between 3-6 GHz at any distance larger than half the probe tip diameter from the boundary.



Add: No.52 HuaYuanBei Road, Haidian District, Beijing, 100191, China
Tel: +86-10-62304633-2512 Fax: +86-10-62304633-2504
E-mail: ctl@chinattl.com [Http://www.chinattl.cn](http://www.chinattl.cn)

Frequency Response of E-Field (TEM-Cell: ifi110 EXX, Waveguide: R22)

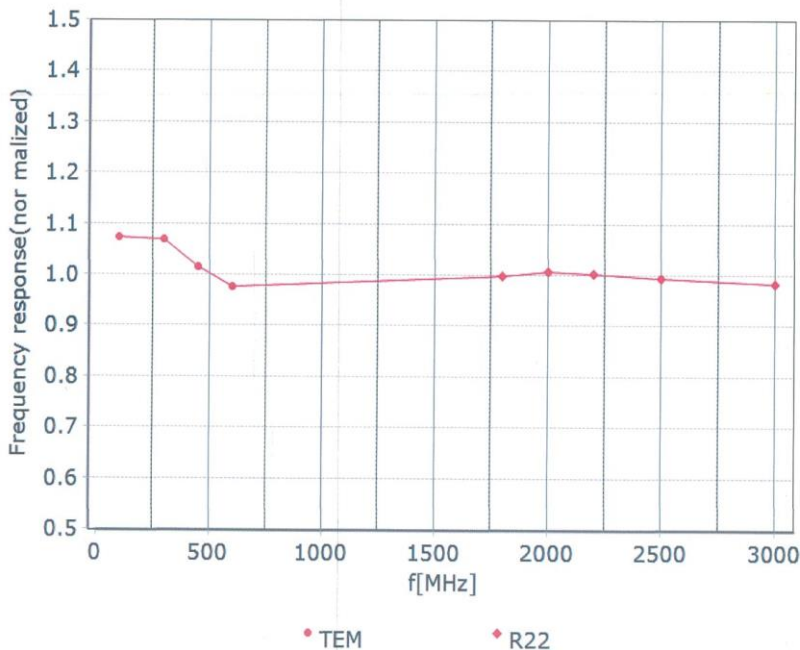

Uncertainty of Frequency Response of E-field: $\pm 7.4\%$ ($k=2$)



Add: No.52 HuaYuanBei Road, Haidian District, Beijing, 100191, China
 Tel: +86-10-62304633-2512 Fax: +86-10-62304633-2504
 E-mail: cttl@chinattl.com [Http://www.chinattl.cn](http://www.chinattl.cn)

Receiving Pattern (Φ), $\theta=0^\circ$

f=600 MHz, TEM

f=1800 MHz, R22

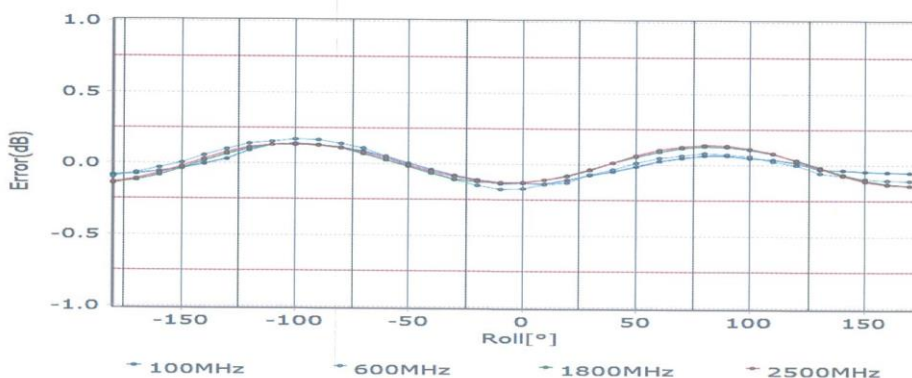
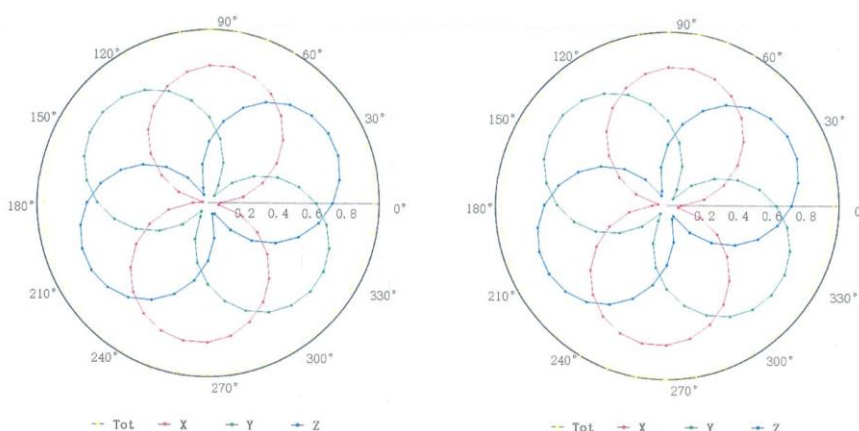

Uncertainty of Axial Isotropy Assessment: $\pm 1.2\%$ ($k=2$)



Add: No.52 HuaYuanBei Road, Haidian District, Beijing, 100191, China
 Tel: +86-10-62304633-2512 Fax: +86-10-62304633-2504
 E-mail: ctl@chinattl.com [Http://www.chinattl.cn](http://www.chinattl.cn)

Dynamic Range f(SAR_{head}) (TEM cell, f = 900 MHz)

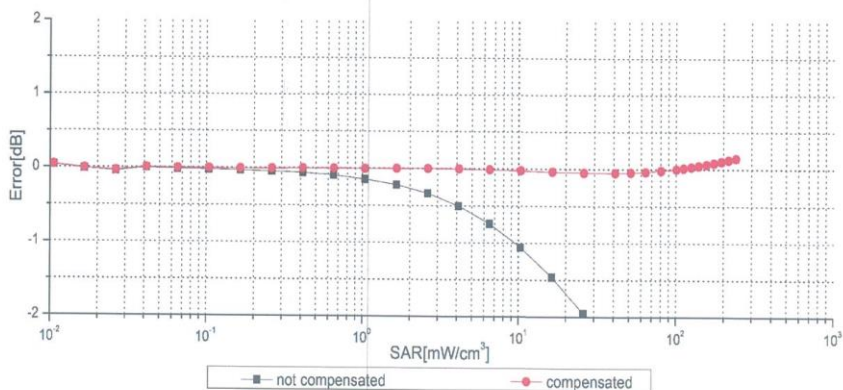
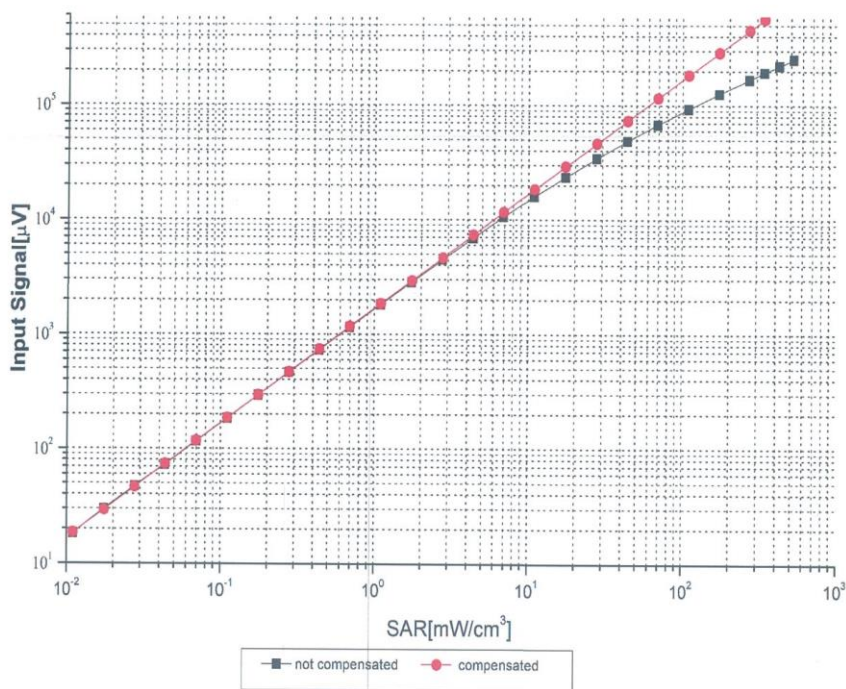

Uncertainty of Linearity Assessment: ±0.9% (k=2)



Add: No.52 HuaYuanBei Road, Haidian District, Beijing, 100191, China
 Tel: +86-10-62304633-2512 Fax: +86-10-62304633-2504
 E-mail: cttl@chinattl.com [Http://www.chinattl.cn](http://www.chinattl.cn)

Conversion Factor Assessment

f=750 MHz,WGLS R9(H_convF)

f=1810 MHz,WGLS R22(H_convF)

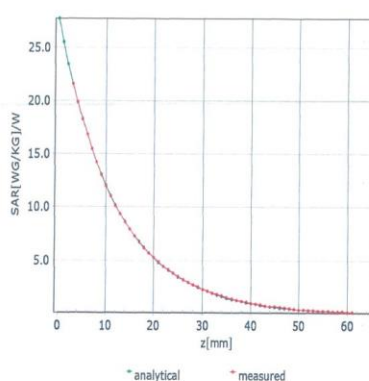
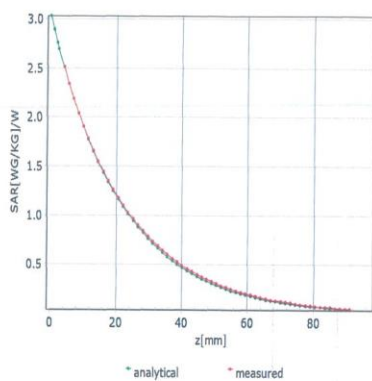

Deviation from Isotropy in Liquid

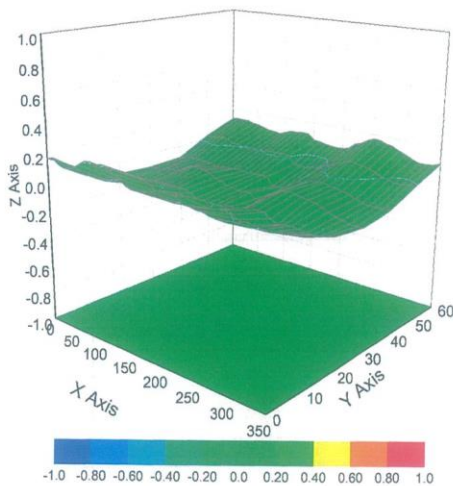

Uncertainty of Spherical Isotropy Assessment: ±3.2% (k=2)



Add: No.52 HuaYuanBei Road, Haidian District, Beijing, 100191, China
 Tel: +86-10-62304633-2512 Fax: +86-10-62304633-2504
 E-mail: cttl@chinattl.com [Http://www.chinattl.cn](http://www.chinattl.cn)

DASY/EASY – Parameters of Probe: EX3DV4 – SN:3710



Other Probe Parameters

Sensor Arrangement	Triangular
Connector Angle (°)	82.2
Mechanical Surface Detection Mode	enabled
Optical Surface Detection Mode	disable
Probe Overall Length	337mm
Probe Body Diameter	10mm
Tip Length	9mm
Tip Diameter	2.5mm
Probe Tip to Sensor X Calibration Point	1mm
Probe Tip to Sensor Y Calibration Point	1mm
Probe Tip to Sensor Z Calibration Point	1mm
Recommended Measurement Distance from Surface	1.4mm

Appendix D. Dipole Calibration Data



Client **Dekra-CN** Certificate No: **Z19-60093**

CALIBRATION CERTIFICATE			
Object	D2450V2 - SN: 839		
Calibration Procedure(s)	FF-Z11-003-01 Calibration Procedures for dipole validation kits		
Calibration date:	March 25, 2019		
<p>This calibration Certificate documents the traceability to national standards, which realize the physical units of measurements(SI). The measurements and the uncertainties with confidence probability are given on the following pages and are part of the certificate.</p> <p>All calibrations have been conducted in the closed laboratory facility: environment temperature(22±3)°C and humidity<70%.</p> <p>Calibration Equipment used (M&TE critical for calibration)</p>			
Primary Standards	ID #	Cal Date(Calibrated by, Certificate No.)	Scheduled Calibration
Power Meter NRP2	106277	20-Aug-18 (CTTL, No.J18X06862)	Aug-19
Power sensor NRP8S	104291	20-Aug-18 (CTTL, No.J18X06862)	Aug-19
Reference Probe EX3DV4	SN 3617	31-Jan-19(SPEAG,No.EX3-3617_Jan19)	Jan-20
DAE4	SN 1331	06-Feb-19(SPEAG,No.DAE4-1331_Feb19)	Feb-20
Secondary Standards	ID #	Cal Date(Calibrated by, Certificate No.)	Scheduled Calibration
Signal Generator E4438C	MY49071430	23-Jan-19 (CTTL, No.J19X00336)	Jan-20
NetworkAnalyzer E5071C	MY46110673	24-Jan-19 (CTTL, No.J19X00547)	Jan-20
Calibrated by:	Name Zhao Jing	Function SAR Test Engineer	Signature 
Reviewed by:	Name Lin Hao	Function SAR Test Engineer	Signature 
Approved by:	Name Qi Dianyuan	Function SAR Project Leader	Signature 
Issued: March 28, 2019			
This calibration certificate shall not be reproduced except in full without written approval of the laboratory.			



In Collaboration with
s p e a g
CALIBRATION LABORATORY

Add: No.51 Xueyuan Road, Haidian District, Beijing, 100191, China
Tel: +86-10-62304633-2079 Fax: +86-10-62304633-2504
E-mail: cntl@chinattl.com <http://www.chinattl.cn>

Glossary:

TSL	tissue simulating liquid
ConvF	sensitivity in TSL / NORM _{x,y,z}
N/A	not applicable or not measured

Calibration is Performed According to the Following Standards:

- IEEE Std 1528-2013, "IEEE Recommended Practice for Determining the Peak Spatial-Averaged Specific Absorption Rate (SAR) in the Human Head from Wireless Communications Devices: Measurement Techniques", June 2013
- IEC 62209-1, "Measurement procedure for assessment of specific absorption rate of human exposure to radio frequency fields from hand-held and body-mounted wireless communication devices- Part 1: Device used next to the ear (Frequency range of 300MHz to 6GHz)", July 2016
- IEC 62209-2, "Procedure to measure the Specific Absorption Rate (SAR) For wireless communication devices used in close proximity to the human body (frequency range of 30MHz to 6GHz)", March 2010
- KDB865664, SAR Measurement Requirements for 100 MHz to 6 GHz

Additional Documentation:

- DASY4/5 System Handbook

Methods Applied and Interpretation of Parameters:

- Measurement Conditions:* Further details are available from the Validation Report at the end of the certificate. All figures stated in the certificate are valid at the frequency indicated.
- Antenna Parameters with TSL:* The dipole is mounted with the spacer to position its feed point exactly below the center marking of the flat phantom section, with the arms oriented parallel to the body axis.
- Feed Point Impedance and Return Loss:* These parameters are measured with the dipole positioned under the liquid filled phantom. The impedance stated is transformed from the measurement at the SMA connector to the feed point. The Return Loss ensures low reflected power. No uncertainty required.
- Electrical Delay:* One-way delay between the SMA connector and the antenna feed point. No uncertainty required.
- SAR measured:* SAR measured at the stated antenna input power.
- SAR normalized:* SAR as measured, normalized to an input power of 1 W at the antenna connector.
- SAR for nominal TSL parameters:* The measured TSL parameters are used to calculate the nominal SAR result.

The reported uncertainty of measurement is stated as the standard uncertainty of Measurement multiplied by the coverage factor $k=2$, which for a normal distribution Corresponds to a coverage probability of approximately 95%.



In Collaboration with
s p e a g
CALIBRATION LABORATORY

Add: No.51 Xueyuan Road, Haidian District, Beijing, 100191, China
Tel: +86-10-62304633-2079 Fax: +86-10-62304633-2504
E-mail: cttl@chinatml.com http://www.chinatml.cn

Measurement Conditions

DASY system configuration, as far as not given on page 1.

DASY Version	DASY52	52.10.2.1495
Extrapolation	Advanced Extrapolation	
Phantom	Triple Flat Phantom 5.1C	
Distance Dipole Center - TSL	10 mm	with Spacer
Zoom Scan Resolution	dx, dy, dz = 5 mm	
Frequency	2450 MHz ± 1 MHz	

Head TSL parameters

The following parameters and calculations were applied.

	Temperature	Permittivity	Conductivity
Nominal Head TSL parameters	22.0 °C	39.2	1.80 mho/m
Measured Head TSL parameters	(22.0 ± 0.2) °C	39.6 ± 6 %	1.84 mho/m ± 6 %
Head TSL temperature change during test	<1.0 °C	----	----

SAR result with Head TSL

SAR averaged over 1 cm ³ (1 g) of Head TSL	Condition	
SAR measured	250 mW input power	12.9 W/kg
SAR for nominal Head TSL parameters	normalized to 1W	51.2 W/kg ± 18.8 % (k=2)
SAR averaged over 10 cm ³ (10 g) of Head TSL	Condition	
SAR measured	250 mW input power	5.92 W/kg
SAR for nominal Head TSL parameters	normalized to 1W	23.6 W/kg ± 18.7 % (k=2)

Body TSL parameters

The following parameters and calculations were applied.

	Temperature	Permittivity	Conductivity
Nominal Body TSL parameters	22.0 °C	52.7	1.95 mho/m
Measured Body TSL parameters	(22.0 ± 0.2) °C	53.8 ± 6 %	2.00 mho/m ± 6 %
Body TSL temperature change during test	<1.0 °C	----	----

SAR result with Body TSL

SAR averaged over 1 cm ³ (1 g) of Body TSL	Condition	
SAR measured	250 mW input power	12.8 W/kg
SAR for nominal Body TSL parameters	normalized to 1W	50.8 W/kg ± 18.8 % (k=2)
SAR averaged over 10 cm ³ (10 g) of Body TSL	Condition	
SAR measured	250 mW input power	5.89 W/kg
SAR for nominal Body TSL parameters	normalized to 1W	23.5 W/kg ± 18.7 % (k=2)



In Collaboration with
s p e a g
CALIBRATION LABORATORY

Add: No.51 Xueyuan Road, Haidian District, Beijing, 100191, China
Tel: +86-10-62304633-2079 Fax: +86-10-62304633-2504
E-mail: cttl@chinattl.com http://www.chinattl.cn

Appendix (Additional assessments outside the scope of CNAS L0570)

Antenna Parameters with Head TSL

Impedance, transformed to feed point	53.3Ω+ 4.84 jΩ
Return Loss	- 24.9dB

Antenna Parameters with Body TSL

Impedance, transformed to feed point	49.5Ω+ 6.02 jΩ
Return Loss	- 24.3dB

General Antenna Parameters and Design

Electrical Delay (one direction)	1.026 ns
----------------------------------	----------

After long term use with 100W radiated power, only a slight warming of the dipole near the feedpoint can be measured.

The dipole is made of standard semirigid coaxial cable. The center conductor of the feeding line is directly connected to the second arm of the dipole. The antenna is therefore short-circuited for DC-signals. On some of the dipoles, small end caps are added to the dipole arms in order to improve matching when loaded according to the position as explained in the "Measurement Conditions" paragraph. The SAR data are not affected by this change. The overall dipole length is still according to the Standard. No excessive force must be applied to the dipole arms, because they might bend or the soldered connections near the feedpoint may be damaged.

Additional EUT Data

Manufactured by	SPEAG
-----------------	-------



In Collaboration with
s p e a g
CALIBRATION LABORATORY

Add: No.51 Xueyuan Road, Haidian District, Beijing, 100191, China
Tel: +86-10-62304633-2079 Fax: +86-10-62304633-2504
E-mail: ttl@chinattl.com http://www.chinattl.cn

DASY5 Validation Report for Head TSL

Date: 03.25.2019

Test Laboratory: CTTL, Beijing, China

DUT: Dipole 2450 MHz; Type: D2450V2; Serial: D2450V2 - SN: 839

Communication System: UID 0, CW; Frequency: 2450 MHz; Duty Cycle: 1:1

Medium parameters used: $f = 2450$ MHz; $\sigma = 1.841$ S/m; $\epsilon_r = 39.63$; $\rho = 1000$ kg/m³

Phantom section: Right Section

DASY5 Configuration:

- Probe: EX3DV4 - SN3617; ConvF(7.62, 7.62, 7.62) @ 2450 MHz; Calibrated: 1/31/2019
- Sensor-Surface: 1.4mm (Mechanical Surface Detection)
- Electronics: DAE4 Sn1331; Calibrated: 2/6/2019
- Phantom: MFP_V5.1C ; Type: QD 000 P51CA; Serial: 1062
- Measurement SW: DASY52, Version 52.10 (2); SEMCAD X Version 14.6.12 (7450)

Dipole Calibration/Zoom Scan (7x7x7) (7x7x7)/Cube 0: Measurement grid: dx=5mm, dy=5mm, dz=5mm

Reference Value = 103.8 V/m; Power Drift = 0.06 dB

Peak SAR (extrapolated) = 27.6 W/kg

SAR(1 g) = 12.9 W/kg; SAR(10 g) = 5.92 W/kg

Maximum value of SAR (measured) = 22.0 W/kg

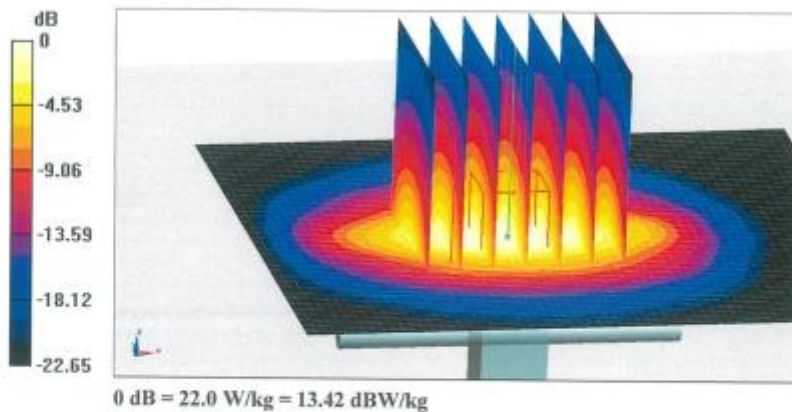



In Collaboration with
s p e a g
CALIBRATION LABORATORY

Add: No.51 Xueyuan Road, Haidian District, Beijing, 100191, China
Tel: +86-10-62304633-2079 Fax: +86-10-62304633-2504
E-mail: entl@chinattl.com <http://www.chinattl.cn>

Impedance Measurement Plot for Head TSL

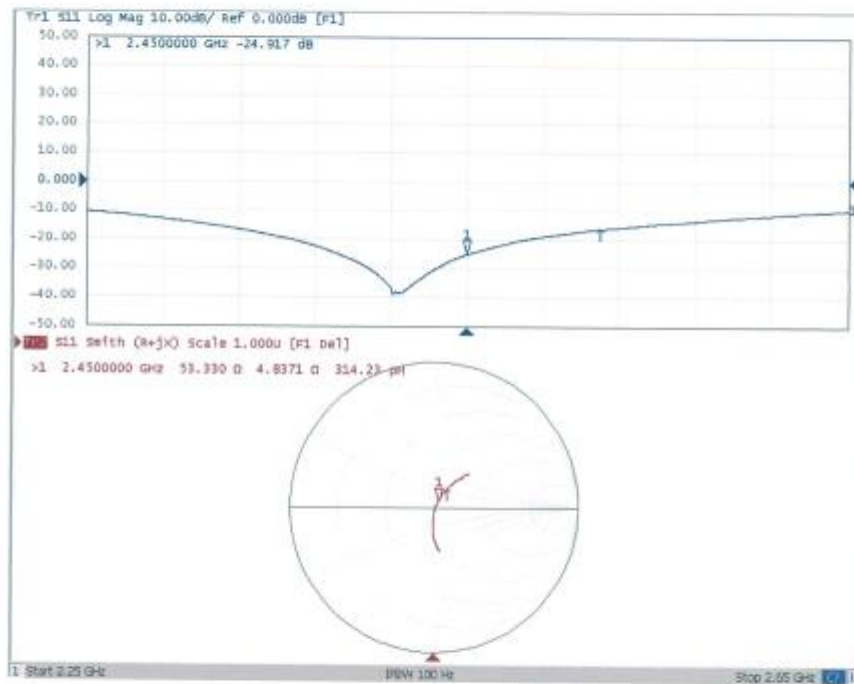



In Collaboration with
s p e a g
CALIBRATION LABORATORY

Add: No.51 Xueyuan Road, Haidian District, Beijing, 100191, China
Tel: +86-10-62304633-2079 Fax: +86-10-62304633-2504
E-mail: cttl@chinattl.com http://www.chinattl.cn

DASY5 Validation Report for Body TSL

Date: 03.25.2019

Test Laboratory: CTTL, Beijing, China

DUT: Dipole 2450 MHz; Type: D2450V2; Serial: D2450V2 - SN: 839

Communication System: UID 0, CW; Frequency: 2450 MHz; Duty Cycle: 1:1

Medium parameters used: $f = 2450$ MHz; $\sigma = 2.003$ S/m; $\epsilon_r = 53.78$; $\rho = 1000$ kg/m³

Phantom section: Center Section

DASY5 Configuration:

- Probe: EX3DV4 - SN3617; ConvF(7.79, 7.79, 7.79) @ 2450 MHz; Calibrated: 1/31/2019
- Sensor-Surface: 1.4mm (Mechanical Surface Detection)
- Electronics: DAE4 Sn1331; Calibrated: 2/6/2019
- Phantom: MFP_V5.1C ; Type: QD 000 P51CA; Serial: 1062
- Measurement SW: DASY52, Version 52.10 (2); SEMCAD X Version 14.6.12 (7450)

Dipole Calibration/Zoom Scan (7x7x7) (7x7x7)/Cube 0: Measurement grid: dx=5mm, dy=5mm, dz=5mm

Reference Value = 94.90 V/m; Power Drift = 0.02 dB

Peak SAR (extrapolated) = 27.0 W/kg

SAR(1 g) = 12.8 W/kg; SAR(10 g) = 5.89 W/kg

Maximum value of SAR (measured) = 21.4 W/kg

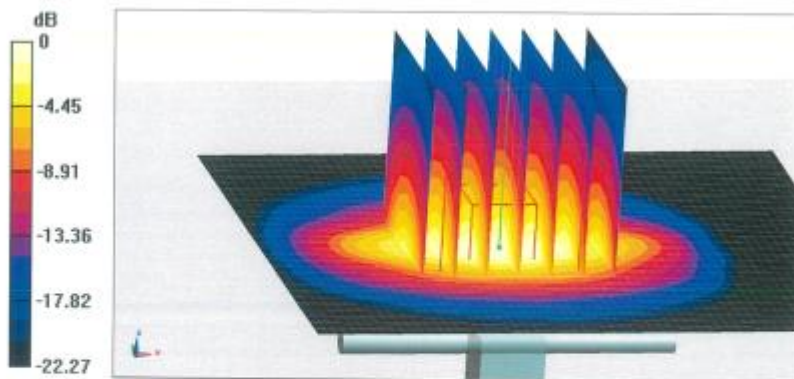



Add: No.51 Xueyuan Road, Haidian District, Beijing, 100191, China
Tel: +86-10-62304633-2079 Fax: +86-10-62304633-2504
E-mail: cttl@chinattl.com http://www.chinattl.cn

Impedance Measurement Plot for Body TSL

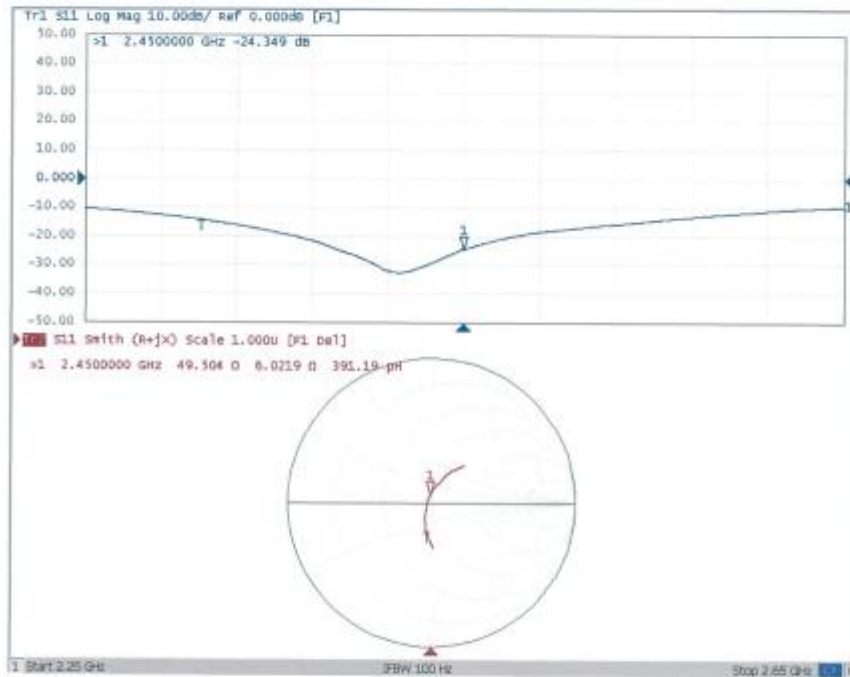

Appendix E. DAE Calibration Data



In Collaboration with
s p e a g
CALIBRATION LABORATORY

Add: No.51 Xueyuan Road, Haidian District, Beijing, 100191, China
Tel: +86-10-62304633-2512 Fax: +86-10-62304633-2504
E-mail: cttl@chinattl.com [Http://www.chinattl.cn](http://www.chinattl.cn)



中国认可
国际互认
校准
CALIBRATION
CNAS L0570

Client : **Dekra-CN**

Certificate No: **Z21-60052**

CALIBRATION CERTIFICATE			
Object	DAE4 - SN: 1220		
Calibration Procedure(s)	FF-Z11-002-01 Calibration Procedure for the Data Acquisition Electronics (DAEx)		
Calibration date:	March 11, 2021		
<p>This calibration Certificate documents the traceability to national standards, which realize the physical units of measurements(SI). The measurements and the uncertainties with confidence probability are given on the following pages and are part of the certificate.</p> <p>All calibrations have been conducted in the closed laboratory facility: environment temperature(22±3)°C and humidity<70%.</p> <p>Calibration Equipment used (M&TE critical for calibration)</p>			
Primary Standards	ID #	Cal Date(Calibrated by, Certificate No.)	Scheduled Calibration
Process Calibrator 753	1971018	16-Jun-20 (CTTL, No.J20X04342)	Jun-21
Calibrated by:	Name Yu Zongying	Function SAR Test Engineer	Signature
Reviewed by:	Name Lin Hao	Function SAR Test Engineer	Signature
Approved by:	Name Qi Dianyuan	Function SAR Project Leader	Signature
			Issued: March 13, 2021
This calibration certificate shall not be reproduced except in full without written approval of the laboratory.			



Add: No.51 Xueyuan Road, Haidian District, Beijing, 100191, China
Tel: +86-10-62304633-2512 Fax: +86-10-62304633-2504
E-mail: cttl@chinattl.com Http://www.chinattl.cn

Glossary:

DAE data acquisition electronics
Connector angle information used in DASY system to align probe sensor X to the robot coordinate system.

Methods Applied and Interpretation of Parameters:

- *DC Voltage Measurement:* Calibration Factor assessed for use in DASY system by comparison with a calibrated instrument traceable to national standards. The figure given corresponds to the full scale range of the voltmeter in the respective range.
- *Connector angle:* The angle of the connector is assessed measuring the angle mechanically by a tool inserted. Uncertainty is not required.
- The report provide only calibration results for DAE, it does not contain other performance test results.



Add: No.51 Xueyuan Road, Haidian District, Beijing, 100191, China
 Tel: +86-10-62304633-2512 Fax: +86-10-62304633-2504
 E-mail: cttl@chinattl.com Http://www.chinattl.cn

DC Voltage Measurement

A/D - Converter Resolution nominal
 High Range: 1LSB = 6.1μV , full range = -100...+300 mV
 Low Range: 1LSB = 61nV , full range = -1.....+3mV
 DASY measurement parameters: Auto Zero Time: 3 sec; Measuring time: 3 sec

Calibration Factors	X	Y	Z
High Range	405.196 ± 0.15% (k=2)	404.915 ± 0.15% (k=2)	404.140 ± 0.15% (k=2)
Low Range	3.97724 ± 0.7% (k=2)	3.99437 ± 0.7% (k=2)	3.98507 ± 0.7% (k=2)

Connector Angle

Connector Angle to be used in DASY system	178° ± 1°
---	-----------