



Test report No:
2190330R-RF-US-P06V02

FCC & ISED TEST REPORT

Product Name	Bluetooth headset
Model and /or type reference	B825
Trademark	Plantronics
FCC ID	AL8-B825
IC	457A-B825
Applicant's name / address	Plantronics, Inc. 345 Encinal Street, Santa Cruz, CA 95060 USA
Test method requested, standard	FCC CFR Title 47 Part 15 Subpart C Section 15.247 ANSI C63.10: 2013 KD558074 D01 15.247 Meas Guidance v05r02 RSS-Gen Issue 5 RSS-247 Issue 2
Verdict Summary	IN COMPLIANCE
Tested by (name / position & signature)	Scott Shen/Project Engineer 
Approved by (name / position & signature)	Jack Zhang/Supervisor 
Date of issue	2021-10-19
Report Version	V1.0
Report template No	Template_FCC 15.247-RF-V1.0

INDEX

	page
General conditions	4
Environmental conditions	4
Possible test case verdicts	5
Abbreviations.....	5
Document History.....	6
Remarks and Comments	6
Used Equipment.....	7
Uncertainty	8
1 General Information	9
1.1 General Description of the Item(s).....	9
1.2 Antenna Information	10
1.3 Channel List.....	11
2 Description of Test Setup.....	12
2.1 Operating mode(s) used for tests	12
2.2 Auxiliary equipment / Test software for the EUT	12
2.3 Test Configuration / Block diagram used for tests.....	13
2.4 Testing process	14
3 Verdict summary section.....	15
3.1 Standards	15
3.2 Deviation(s) from the Standard(s) / Test Specification(s).....	15
3.3 Overview of results	16
3.4 Test Facility.....	17
4 Test Results	18
4.1 Emissions in restricted frequency bands	18
4.1.1 Limit	18
4.1.2 Test Setup	20
4.1.3 Test Procedure	21
4.1.4 Test Data	22
4.2 Band Edge	30
4.2.1 Limit	30
4.2.2 Test Setup	30
4.2.3 Test Procedure	30
4.2.4 Test Data	31
4.3 Fundamental emission output power.....	39

4.3.1	Limit	39
4.3.2	Test Setup	39
4.3.3	Test Procedure	40
4.3.4	Test Data	41
5	Test setup photo and EUT Photo	42

COMPETENCES AND GUARANTEES

DEKRA is a testing laboratory competent to carry out the tests described in this report.

In order to assure the traceability to other national and international laboratories, DEKRA has a calibration and maintenance program for its measurement equipment.

DEKRA guarantees the reliability of the data presented in this report, which is the result of the measurements and the tests performed to the item under test on the date and under the conditions stated in the report and it is based on the knowledge and technical facilities available at DEKRA at the time of performance of the test.

DEKRA is liable to the client for the maintenance of the confidentiality of all information related to the item under test and the results of the test.

The results presented in this Test Report apply only to the particular item under test established in this document.

IMPORTANT: No parts of this report may be reproduced or quoted out of context, in any form or by any means, except in full, without the previous written permission of DEKRA.

GENERAL CONDITIONS

Test Location	No. 99, Hongye Road, Suzhou Industrial Park Suzhou, 215006, P.R. China
Date (receive sample)	Sep. 09, 2021
Date (start test)	Sep. 10, 2021
Date (finish test)	Oct. 08, 2021

1. This report is only referred to the item that has undergone the test.
2. This report does not constitute or imply on its own an approval of the product by the Certification Bodies or Competent Authorities.
3. This document is only valid if complete; no partial reproduction can be made without previous written permission of DEKRA.
4. This test report cannot be used partially or in full for publicity and/or promotional purposes without previous written permission of DEKRA.

ENVIRONMENTAL CONDITIONS

The climatic conditions during the tests are within the limits specified by the manufacturer for the operation of the EUT and the test equipment. The climatic conditions during the tests were within the following limits:

Ambient temperature	15 °C – 35 °C
Relative Humidity air	30% - 60%

If explicitly required in the basic standard or applied product / product family standard the climatic values are recorded and documented separately in this test report.

POSSIBLE TEST CASE VERDICTS

Test case does not apply to test object	N/A
Test object does meet requirement	P (Pass) / PASS
Test object does not meet requirement	F (Fail) / FAIL
Not measured	N/M

ABBREVIATIONS

For the purposes of the present document, the following abbreviations apply:

EUT	: Equipment Under Test
QP	: Quasi-Peak
CAV	: CISPR Average
AV	: Average
CDN	: Coupling Decoupling Network
SAC	: Semi-Anechoic Chamber
OATS	: Open Area Test Site
BW	: Bandwidth
AM	: Amplitude Modulation
PM	: Pulse Modulation
HCP	: Horizontal Coupling Plane
VCP	: Vertical Coupling Plane
U_N	: Nominal voltage
T_x	: Transmitter
R_x	: Receiver
N/A	: Not Applicable
N/M	: Not Measured

DOCUMENT HISTORY

Report No.	Version	Description	Issued Date
2190330R-RF-US-P06V02	V1.0	Initial issue of report.	2021-10-19

REMARKS AND COMMENTS

1. The equipment under test (EUT) does meet the essential requirements of the stated standard(s)/test(s).
2. These test results on a sample of the device are for the purpose of demonstrating Compliance with Part 15 Subpart C Paragraph 15.247, RSS-Gen Issue 5, RSS-247 Issue 2.
3. The measurement result is considered in conformance with the requirement if it is within the prescribed limit, It is not necessary to account the uncertainty associated with the measurement result.
4. The test results presented in this report relate only to the object tested.
5. The test report shall not be reproduced without the written approval of DEKRA Testing and Certification (Suzhou) Co., Ltd.
6. This report will not be used for social proof function in China market.
7. DEKRA declines any responsibility with the following test data provided by customer that may affect the validity of result:
 - Chapter 1.1 General Description of the Item(s);
 - Chapter 1.2 Antenna Information;
 - Chapter 1.3 Channel List.
8. This report is based on DEKRA report No. 14C0469R-RF-US-P06V01, the EUT is changed PCB and hardware, after evaluation, fundamental emission output power, band edge and emissions in restricted frequency bands is retested.

USED EQUIPMENT

Fundamental emission output power / TR8

Instrument	Manufacturer	Model No.	Serial No.	Cal. Date	Next Cal. Date
4TX MIMO Power Sensor	Keysight	X8750A	MY59400102	2021.03.31	2022.03.30
Coaxial Cable	Woken	SFL402	F02-150410-044	2021.01.01	2021.12.31
Temperature/Humidity Meter	RTS	RTS-8S	RF08	2021.07.09	2022.07.08

Radiated Emission(Below 1GHz) / AC2

Instrument	Manufacturer	Model No.	Serial No.	Cal. Date	Next Cal. Date
EMI Test Receiver	R&S	ESCI	100573	2020.12.06	2021.12.05
Loop Antenna	R&S	HFH2-Z2	833799/003	2021.03.04	2022.03.03
Bilog Antenna	Teseq GmbH	CBL6112D	27611	2020.11.27	2021.11.26
Coaxial Cable	Huber+Suhner	SUCOFLEX 106	AC2-C	2021.03.31	2022.03.30
Temperature/Humidity Meter	RTS	RTS-8S	EMC02	2021.07.09	2022.07.08
Dekra test software	Dekra	-	-	-	-

Radiated Emission(1GHz-40GHz) / Band Edge / AC5

Instrument	Manufacturer	Model No.	Serial No.	Cal. Date	Next Cal. Date
EXA Spectrum Analyzer	Keysight	N9010A	MY55370495	2021.03.20	2022.03.19
Amplifier	Keleto	LNPA	SK20190225	2021.09.25	2022.09.24
Preamplifier	EMCI	EMC184045SE	980263	2021.05.22	2022.05.21
DRG Horn Antenna	ETS-Lindgren	3117	00167055	2021.08.23	2022.08.22
Broad-Band Horn Antenna	Schwarzbeck	BBHA9170	294	2021.04.19	2022.04.18
Coaxial Cable	Huber+Suhner	SUCOFLEX 106	AC5-C2	2021.03.31	2022.03.30
Coaxial Cable	ROSENBERGER	LA1-C011- 2000/3000	AC5-40G	2021.03.20	2022.03.19
Temperature/Humidity Meter	RTS	RTS-8S	AC5-TH	2021.07.09	2022.07.08
Dekra test software	Dekra	-	-	-	-

UNCERTAINTY

Uncertainties have been calculated according to the DEKRA internal document. The reported expanded uncertainties are based on a standard uncertainty multiplied by a coverage factor of $k=2$, providing a level of confidence of approximately 95%. The Uncertainties is comply with standard required as below.

Test item	Uncertainty
AC Power Line Conducted Emission	9kHz~150kHz: 2.80dB 150kHz~30MHz: 2.40dB
Peak Power Output	± 1.27 dB
Radiated Emission(30MHz~1GHz)	Horizontal: 30MHz~200MHz: 3.50 dB 300MHz~1GHz: 3.60 dB Vertical: 30MHz~200MHz: 3.60 dB 300MHz~1GHz: 3.50 dB
Radiated Emission(1GHz~26.5GHz)	Horizontal: 1GHz~18GHz: 5.00 dB Vertical: 1GHz~18GHz: 4.80 dB
RF antenna conducted test	± 1.27 dB
Radiated Emission Band Edge	± 3.9 dB
DTS Bandwidth	± 150 Hz
Occupied Bandwidth	± 1 kHz
Power Density	± 1.27 dB

1 GENERAL INFORMATION

1.1 General Description of the Item(s)

Product Name	Bluetooth headset
Model No.	B825
FCC ID	AL8-B825
IC	457A-B825
Manufacturer	Plantronics, Inc.
Manufacturer Address.....	345 Encinal Street, Santa Cruz, CA 95060 USA

Wireless specification.....	BLE					
Operating frequency range(s)	2400~2483.5MHz					
Type of Modulation.....	GFSK					
PHYs	<input checked="" type="checkbox"/>	LE 1M	<input type="checkbox"/>	LE 2M	<input type="checkbox"/>	LE Coded S=2/8
Data Rate	<input checked="" type="checkbox"/>	1Mbit/s	<input type="checkbox"/>	2Mbit/s	<input type="checkbox"/>	500/125 Kbit/s
Number of channel	40					

Rated power supply	Voltage and Frequency					
	<input type="checkbox"/>	AC: 220 – 240 V, 50/60 Hz				
	<input type="checkbox"/>	AC: 100 – 240 V, 50/60 Hz				
	<input type="checkbox"/>	DC: 19 Vdc				
	<input checked="" type="checkbox"/>	Battery: 3.7 Vdc				

1.2 Antenna Information

Antenna model / type number	N/A		
Antenna serial number	N/A		
Antenna Delivery	<input checked="" type="checkbox"/>	1TX + 1RX	
	<input type="checkbox"/>	2TX + 2RX	
	<input type="checkbox"/>	Others:.....	
Antenna technology	<input checked="" type="checkbox"/>	SISO	
	<input type="checkbox"/>	MIMO	<input type="checkbox"/> CDD
			<input type="checkbox"/> Beam-forming
Antenna Type	<input type="checkbox"/>	External	<input type="checkbox"/> Dipole
			<input type="checkbox"/> Sectorized
	<input checked="" type="checkbox"/>	Internal	<input type="checkbox"/> Monopole
			<input checked="" type="checkbox"/> PCB
			<input type="checkbox"/> Others.....
Antenna Gain	1.97 dBi		

1.3 Channel List

Bluetooth Working Frequency of Each Channel:							
Channel	Frequency	Channel	Frequency	Channel	Frequency	Channel	Frequency
00	2402 MHz	01	2404 MHz	02	2406 MHz	03	2408 MHz
04	2410 MHz	05	2412 MHz	06	2414 MHz	07	2416 MHz
08	2418 MHz	09	2420 MHz	10	2422 MHz	11	2424 MHz
12	2426 MHz	13	2428 MHz	14	2430 MHz	15	2432 MHz
16	2434 MHz	17	2436 MHz	18	2438 MHz	19	2440 MHz
20	2442 MHz	21	2444 MHz	22	2446 MHz	23	2448 MHz
24	2450 MHz	25	2452 MHz	26	2454 MHz	27	2456 MHz
28	2458 MHz	29	2460 MHz	30	2462 MHz	31	2464 MHz
32	2466 MHz	33	2468 MHz	34	2470 MHz	35	2472 MHz
36	2474 MHz	37	2476 MHz	38	2478 MHz	39	2480 MHz

Note: The general description of the Item(s), antenna information and channel list in clause 1 are provided and confirmed by the client.

2 DESCRIPTION OF TEST SETUP

2.1 Operating mode(s) used for tests

During the tests the following operating mode(s) has(have) been used.

Test Mode For Bluetooth	Mode1: Transmit by LE_1Mbps
-------------------------	-----------------------------

2.2 Auxiliary equipment / Test software for the EUT

Auxiliary equipment	Type / Version	Manufacturer	Supplied by
Notebook	2526	Think Pad	N/A
Software	Type / Version	Manufacturer	Supplied by
BlueTest3	N/A	N/A	N/A

2.3 Test Configuration / Block diagram used for tests

Test setup Diagram- Radiated Emission Test

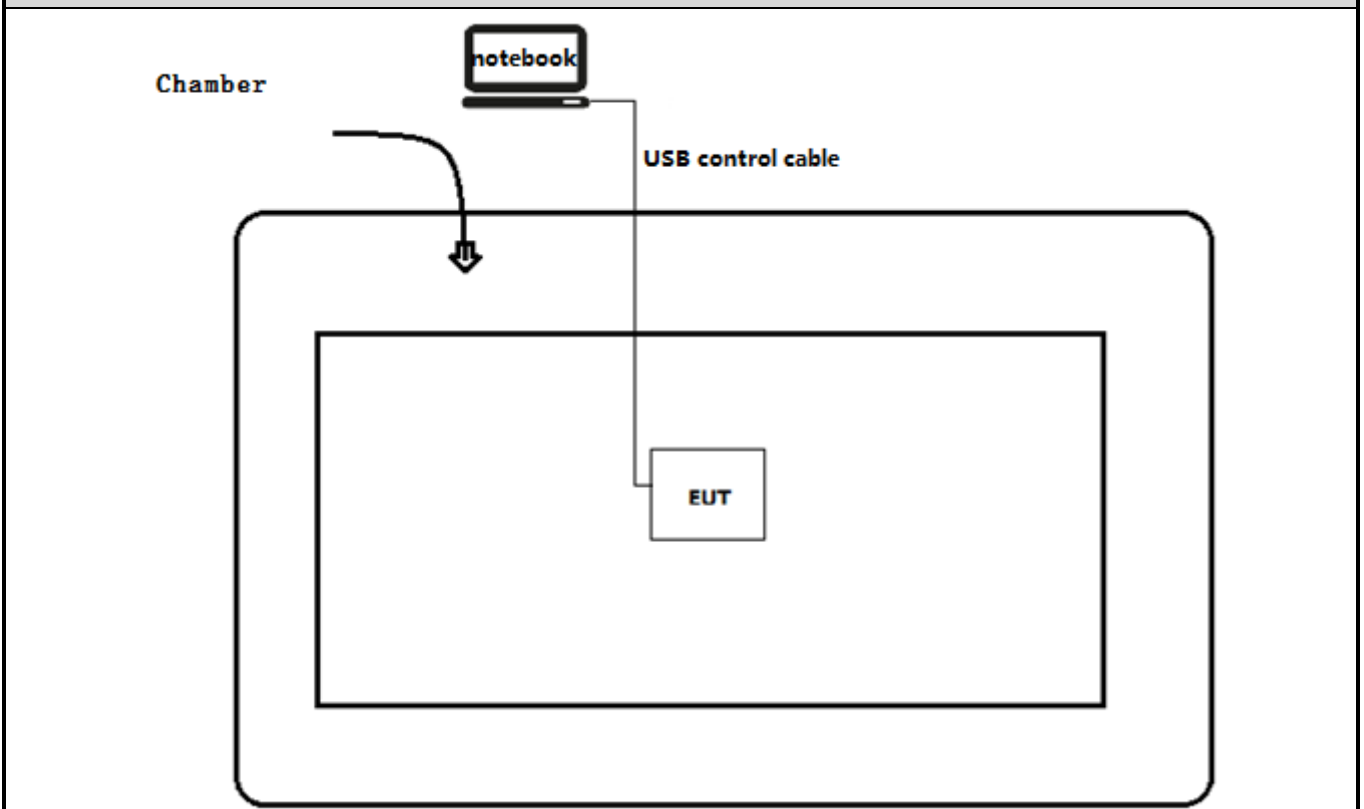

Test setup Diagram- Conducted test

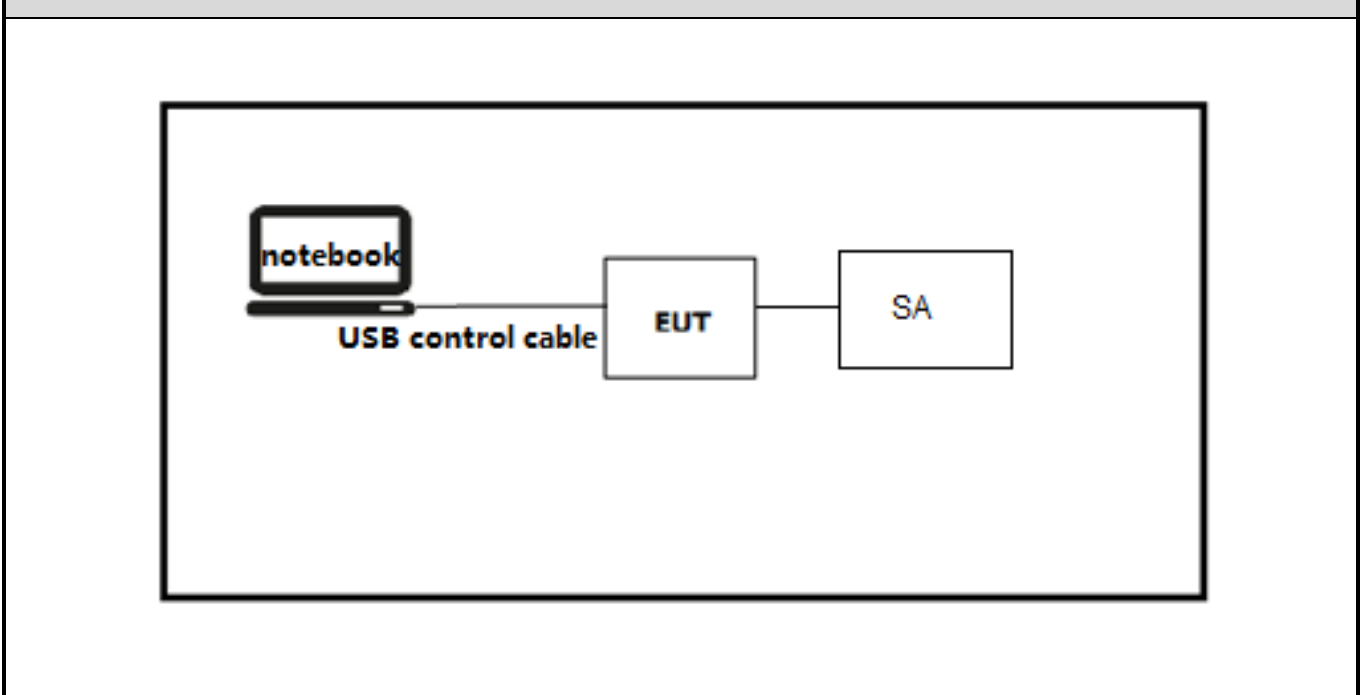

2.4 Testing process

1	Setup the EUT as shown in Section 2.3
2	Execute the test program.
3	Configure the test mode and test channel.
4	Verify that the EUT works properly.

3 VERDICT SUMMARY SECTION

This chapter presents an overview of standards and results. Refer to the next chapters for details of measured test results and applied test levels.

3.1 Standards

Standard	Year	Description
FCC CFR Title 47 Part 15 Subpart C Section 15.247	2021	Operation within the bands 902–928 MHz, 2400–2483.5 MHz, and 5725–5850 MHz.
ANSI C63.10	2013	American National Standard of Procedures for Compliance Testing of Unlicensed Wireless Devices
KDB558074 D01 v05r02	2019	Guidance for performing compliance measurements on Digital Transmission System (DTS) operating under section 15.247
RSS-Gen Issue 5 Amendment 2	2021	General Requirements for Compliance of Radio Apparatus
RSS-247 Issue 2	2017	Digital Transmission Systems (DTSs), Frequency Hopping Systems (FHSs) and Licence-Exempt Local Area Network (LE-LAN) Devices

3.2 Deviation(s) from the Standard(s) / Test Specification(s)

The following deviation(s) was / were made from the published requirements of the listed standards: N/A.

(Please define the deviations from the standard(s) if applicable)

3.3 Overview of results

For FCC

Requirement – Test case	Basic standard(s)	Verdict	Remark
Emissions in restricted frequency bands	FCC 15.247(b)(3)	PASS	---
Band Edge	FCC 15.247(d)	PASS	---
Fundamental emission output power	FCC 15.247(d), FCC 15.209	PASS	---

For ISED

Requirement – Test case	Basic standard(s)	Verdict	Remark
Emissions in restricted frequency bands	RSS-Gen Issue 5 Section 8.9	PASS	---
Band Edge	RSS-Gen Issue 5 Section 8.10	PASS	---
Fundamental emission output power	RSS-247 Issue 2 Section 5.4(d)	PASS	---

3.4 Test Facility

USA	:	FCC Designation Number: CN1199
CA	:	ISED CAB identifier: CN0040

4 TEST RESULTS

4.1 Emissions in restricted frequency bands

VERDICT: PASS

4.1.1 Limit

Standard FCC Part 15 Subpart C Paragraph 15.209

Restricted Bands of operationfor FCC

Frequency (MHz)	Frequency (MHz)	Frequency (MHz)	Frequency (GHz)
0.090 – 0.110	16.42 – 16.423	399.9 – 410	4.5 – 5.15
0.495 – 0.505	16.69475 – 16.69525	608 – 614	5.35 – 5.46
2.1735 – 2.1905	16.80425 – 16.80475	960 – 1240	7.25 – 7.75
4.125 – 4.128	25.5 – 25.67	1300 – 1427	8.025 – 8.5
4.17725 – 4.17775	37.5 – 38.25	1435 – 1626.5	9.0 – 9.2
4.20725 – 4.20775	73 – 74.6	1645.5 – 1646.5	9.3 – 9.5
6.215 – 6.218	74.8 – 75.2	1660 – 1710	10.6 – 12.7
6.26775 – 6.26825	108 – 121.94	1718.8 – 1722.2	13.25 – 13.4
6.31175 – 6.31225	123 – 138	2200 – 2300	14.47 – 14.5
8.291 – 8.294	149.9 – 150.05	2310 – 2390	15.35 – 16.2
8.362 – 8.366	156.52475 – 156.52525	2483.5 – 2500	17.7 – 21.4
8.37625 – 8.38675	156.7 – 156.9	2690 – 2900	22.01 – 23.12
8.81425 – 8.81475	162.0125 – 167.17	3260 – 3267	23.6 – 24.0
12.29 – 12.293	167.72 – 173.2	3332 – 3339	31.2 – 31.8
12.51975 – 12.52025	240 – 285	3345.8 – 3358	36.43 – 36.5
12.57675 – 12.57725	322 – 335.4	3600 – 4400	
13.36 – 13.41			

Restricted Bands of operationfor IC

0.090 - 0.110	13.36 - 13.41	960 - 1427	9.0 - 9.2
0.495 - 0.505	16.42 - 16.423	1435 - 1626.5	9.3 - 9.5
2.1735 - 2.1905	16.69475 - 16.69525	1645.5 - 1646.5	10.6 - 12.7
3.020 - 3.026	16.80425 - 16.80475	1660 - 1710	13.25 - 13.4
4.125 - 4.128	25.5 - 25.67	1718.8 - 1722.2	14.47 - 14.5
4.17725 - 4.17775	37.5 - 38.25	2200 - 2300	15.35 - 16.2
4.20725 - 4.20775	73 - 74.6	2310 - 2390	17.7 - 21.4
5.677 - 5.683	74.8 - 75.2	2483.5 - 2500	22.01 - 23.12
6.215 - 6.218	108 - 138	2655 - 2900	23.6 - 24.0
6.26775 - 6.26825	149.9 - 150.05	3260 - 3267	31.2 - 31.8
6.31175 - 6.31225	156.52475 - 156.52525	3332 - 3339	36.43 - 36.5
8.291 - 8.294	156.7 - 156.9	3345.8 - 3358	Above 38.6
8.362 - 8.366	162.0125 - 167.17	3500 - 4400	
8.37625 - 8.38675	167.72 - 173.2	4500 - 5150	
8.41425 - 8.41475	240 - 285	5350 - 5460	
12.29 - 12.293	322 - 335.4	7250 - 7750	
12.51975 - 12.52025	399.9 - 410	8025 - 8500	
12.57675 - 12.57725	608 - 614	--	

Restricted Band Emissions Limit			
Frequency (MHz)	Field strength ($\mu\text{V/m}$)	Field strength ($\text{dB}\mu\text{V/m}$)	Measurement distance (m)
0.009 - 0.49	2400/F(kHz)	48.5 – 13.8	300 _(Note 1)
0.49 - 1.705	24000/F(kHz)	33.8 - 23	30 _(Note 1)
1.705 - 30	30	29.5	30 _(Note 1)
30 -88	100	40	3 _(Note 2)
88-216	150	43.5	3 _(Note 2)
216 - 960	200	46	3 _(Note 2)
Above 960	500	54	3 _(Note 2)

Note 1: At frequencies below 30 MHz, measurements may be performed at a distance closer than that specified in the regulations; however, an attempt should be made to avoid making measurements in the near field. Pending the development of an appropriate measurement procedure for measurements performed below 30 MHz, when performing measurements at a closer distance than specified, the results shall be extrapolated to the specified distance by either making measurements at a minimum of two distances on at least one radial to determine the proper extrapolation factor or by using the square of an inverse linear distance extrapolation factor (40 dB/decade).

Note 2: At frequencies at or above 30 MHz, measurements may be performed at a distance other than what is specified provided: measurements are not made in the near field except where it can be shown that near field measurements are appropriate due to the characteristics of the device; and it can be demonstrated that the signal levels needed to be measured at the distance employed can be detected by the measurement equipment. Measurements shall not be performed at a distance greater than 30 meters unless it can be further demonstrated that measurements at a distance of 30 meters or less are impractical. When performing measurements at a distance other than that specified, the results shall be extrapolated to the specified distance using an extrapolation factor of 20 dB/decade (inverse linear-distance for field strength measurements; inverse-linear-distance-squared for power density measurements).

4.1.2 Test Setup

Below 30MHz Test Setup:

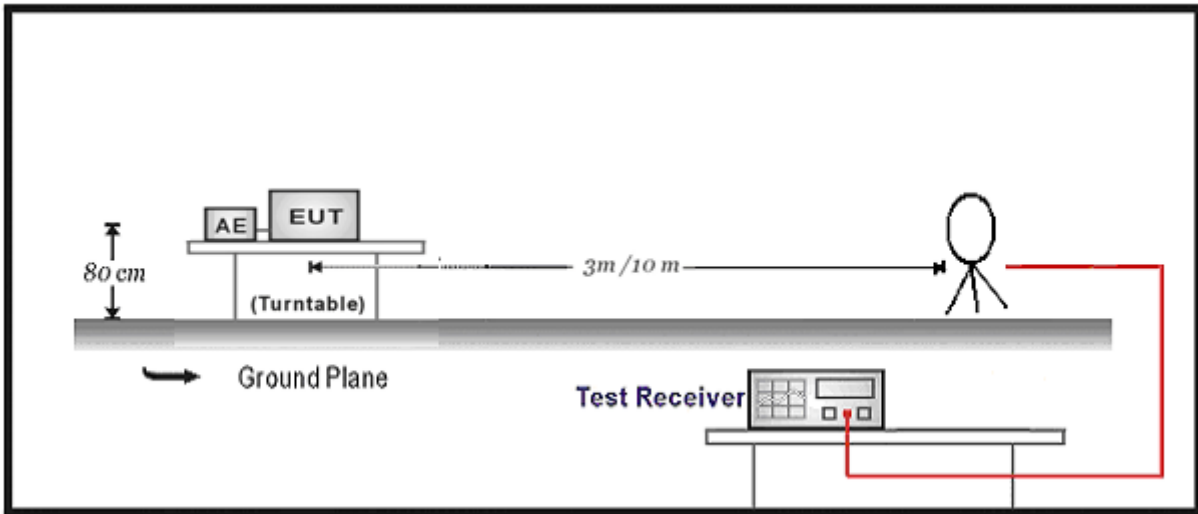

30MHz-1GHz Test Setup:

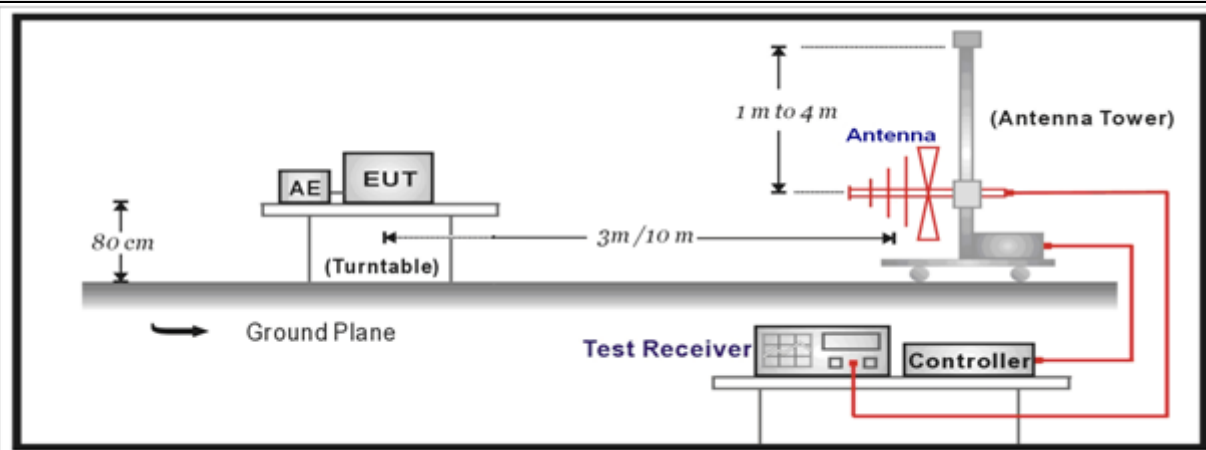

Above 1GHz Test Setup:

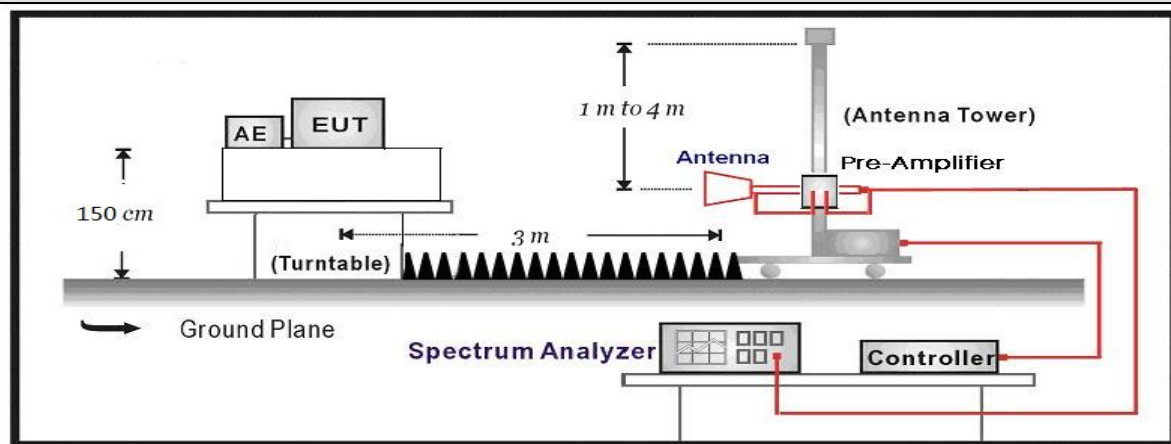

4.1.3 Test Procedure			
	References Rule	Chapter	Description
<input checked="" type="checkbox"/>	ANSI C63.10	11.12	Emissions in restricted frequency bands
	<input checked="" type="checkbox"/> ANSI C63.10	11.12.1	Radiated emission measurements
	<input checked="" type="checkbox"/> ANSI C63.10	11.12.2.7	Radiated spurious emission test
	<input checked="" type="checkbox"/> ANSI C63.10	6.4	Radiated emissions from unlicensed wireless devices below 30 MHz
	<input checked="" type="checkbox"/> ANSI C63.10	6.5	Radiated emissions from unlicensed wireless devices in the frequency range of 30 MHz to 1000 MHz
	<input checked="" type="checkbox"/> ANSI C63.10	6.6	Radiated emissions from unlicensed wireless devices above 1 GHz

4.1.4 Test Data

Profile: 2190330R	Page No.: 199
Engineer: Neil	
Site: AC5	Time: 2021/09/16 - 21:27
Limit: FCC_Part15.209_RE(3m)	Margin: 0
Probe: Horn_3117_00123988_(1-18GHz)	Polarity: Horizontal
EUT: Bluetooth headset	Power: 3.7 Vdc
Note: Mode 1:Transmit at 2402MHz by LE_1Mbps	

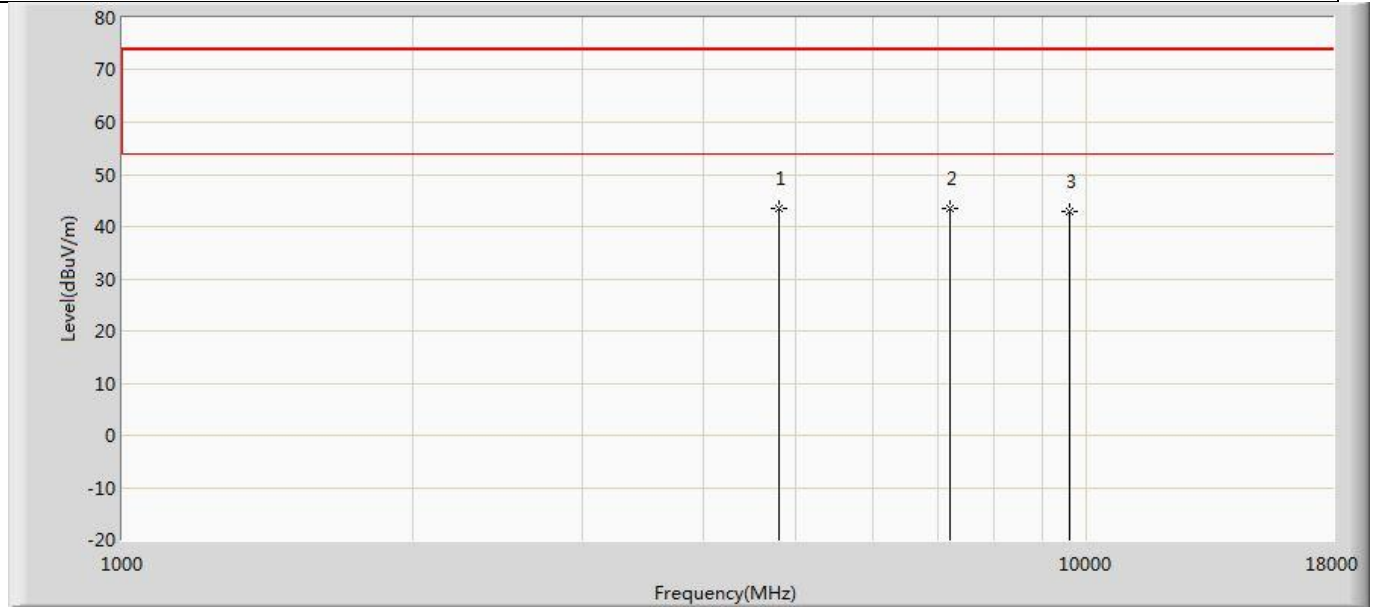

No	Mark	Frequency (MHz)	Measure Level (dBuV/m)	Reading Level (dBuV)	Over Limit (dB)	Limit (dBuV/m)	Factor (dB)	Type
1	*	4804.000	43.619	48.662	-30.381	74.000	-5.044	PK
2		7206.000	43.607	44.653	-30.393	74.000	-1.046	PK
3		9608.000	42.978	40.148	-31.022	74.000	2.830	PK

Profile: 2190330R	Page No.: 200
Engineer: Neil	
Site: AC5	Time: 2021/09/16 - 21:27
Limit: FCC_Part15.209_RE(3m)	Margin: 0
Probe: Horn_3117_00123988_(1-18GHz)	Polarity: Vertical
EUT: Bluetooth headset	Power: 3.7 Vdc
Note: Mode 1:Transmit at 2402MHz by LE_1Mbps	

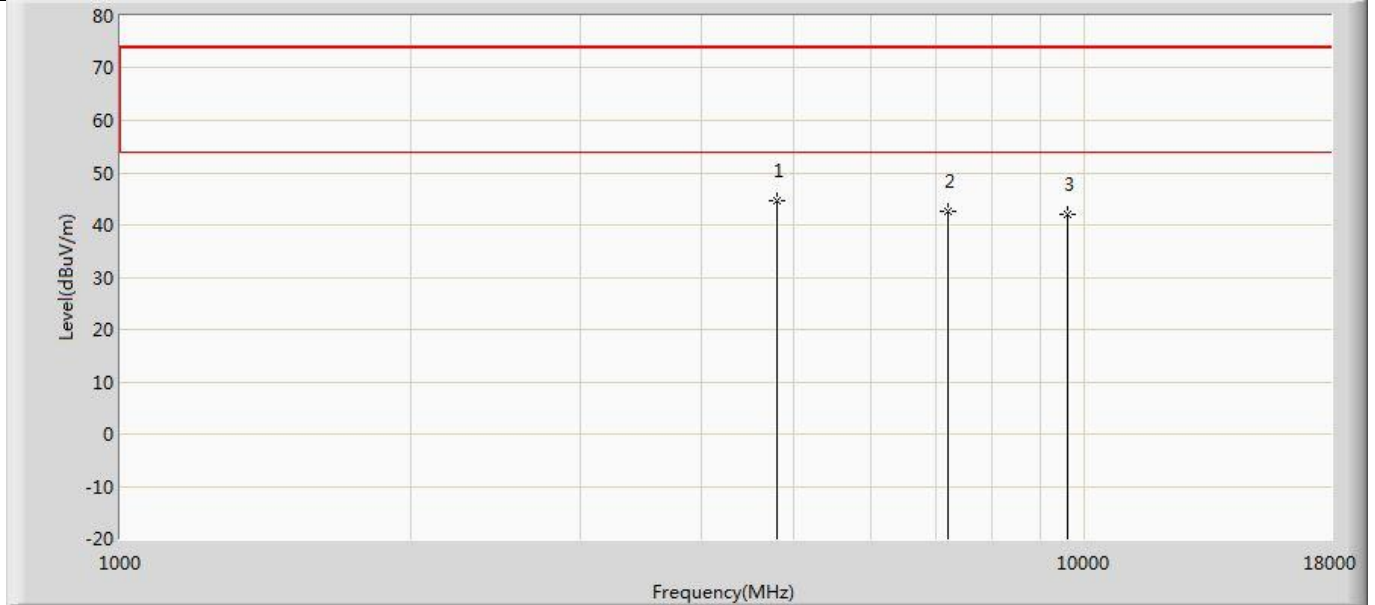

No	Mark	Frequency (MHz)	Measure Level (dBuV/m)	Reading Level (dBuV)	Over Limit (dB)	Limit (dBuV/m)	Factor (dB)	Type
1	*	4804.000	44.728	49.771	-29.272	74.000	-5.044	PK
2		7206.000	42.720	43.766	-31.280	74.000	-1.046	PK
3		9608.000	41.910	39.080	-32.090	74.000	2.830	PK

Profile: 2190330R	Page No.: 201
Engineer: Neil	
Site: AC5	Time: 2021/09/16 - 21:27
Limit: FCC_Part15.209_RE(3m)	Margin: 0
Probe: Horn_3117_00123988_(1-18GHz)	Polarity: Horizontal
EUT: Bluetooth headset	Power: 3.7 Vdc
Note: Mode 1:Transmit at 2440MHz by LE_1Mbps	

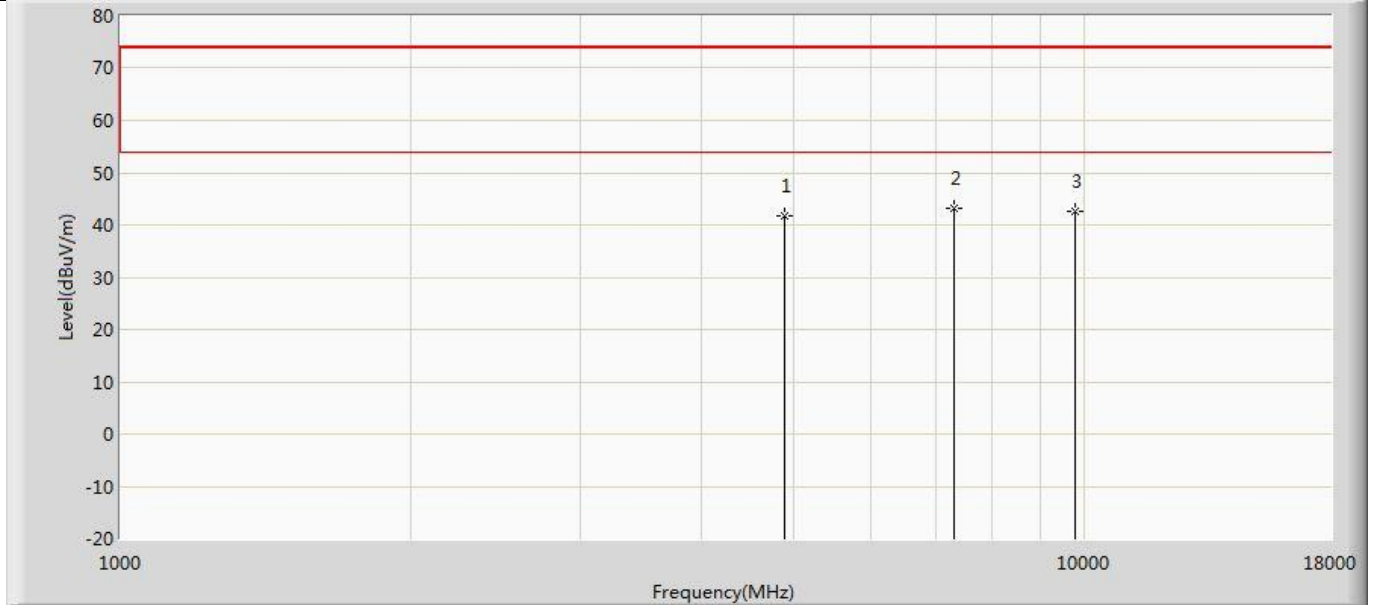

No	Mark	Frequency (MHz)	Measure Level (dBuV/m)	Reading Level (dBuV)	Over Limit (dB)	Limit (dBuV/m)	Factor (dB)	Type
1		4880.000	41.826	46.653	-32.174	74.000	-4.827	PK
2	*	7320.000	43.104	43.997	-30.896	74.000	-0.893	PK
3		9760.000	42.491	39.493	-31.509	74.000	2.998	PK

Profile: 2190330R	Page No.: 202
Engineer: Neil	
Site: AC5	Time: 2021/09/16 - 21:28
Limit: FCC_Part15.209_RE(3m)	Margin: 0
Probe: Horn_3117_00123988_(1-18GHz)	Polarity: Vertical
EUT: Bluetooth headset	Power: 3.7 Vdc
Note: Mode 1:Transmit at 2440MHz by LE_1Mbps	

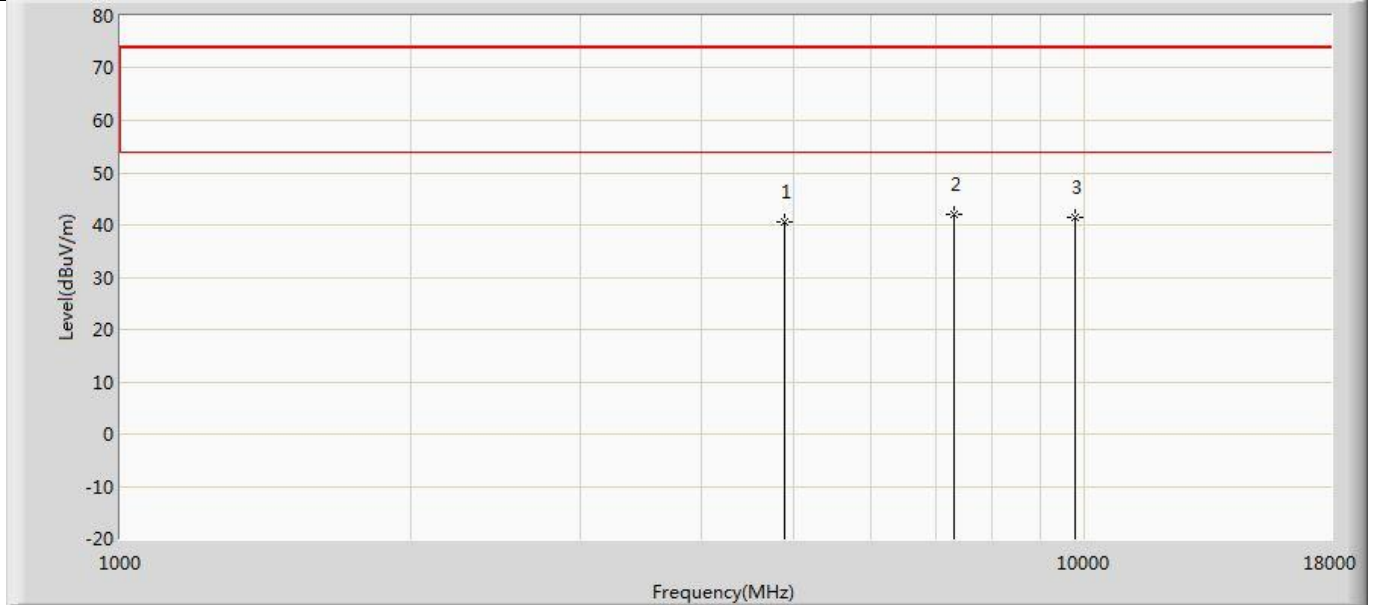

No	Mark	Frequency (MHz)	Measure Level (dBuV/m)	Reading Level (dBuV)	Over Limit (dB)	Limit (dBuV/m)	Factor (dB)	Type
1		4880.000	40.633	45.460	-33.367	74.000	-4.827	PK
2	*	7320.000	41.995	42.888	-32.005	74.000	-0.893	PK
3		9760.000	41.533	38.535	-32.467	74.000	2.998	PK

Profile: 2190330R	Page No.: 203
Engineer: Neil	
Site: AC5	Time: 2021/09/16 - 21:28
Limit: FCC_Part15.209_RE(3m)	Margin: 0
Probe: Horn_3117_00123988_(1-18GHz)	Polarity: Horizontal
EUT: Bluetooth headset	Power: 3.7 Vdc
Note: Mode 1:Transmit at 2480MHz by LE_1Mbps	

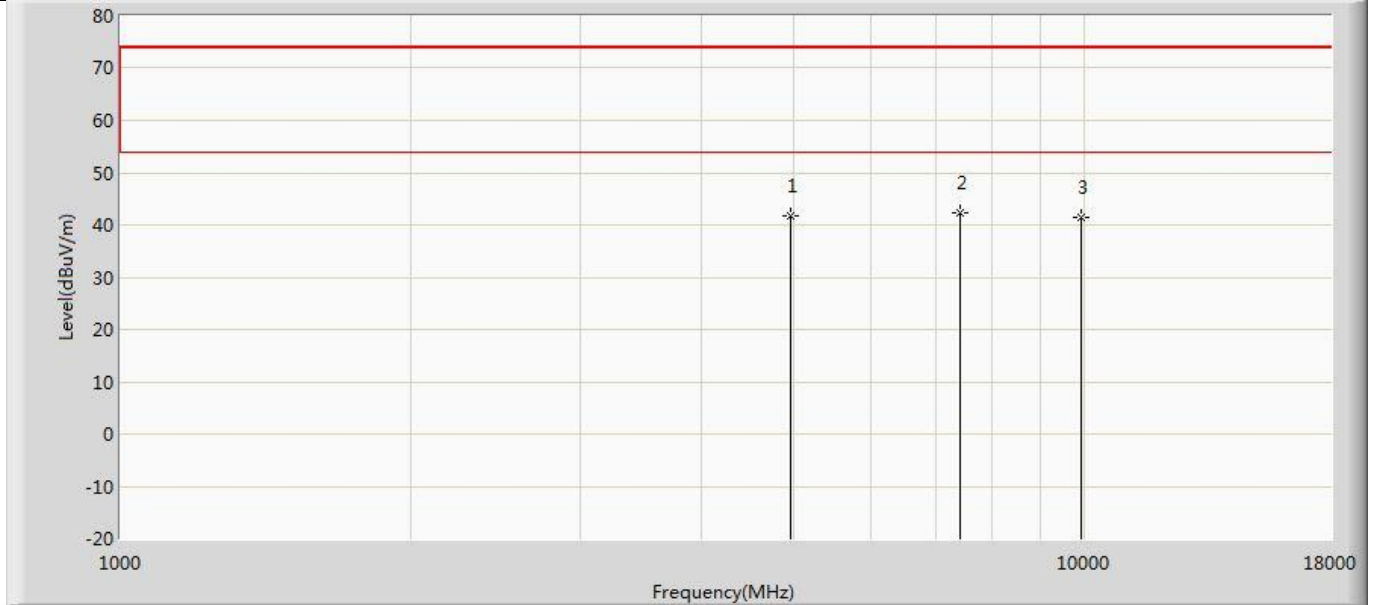

No	Mark	Frequency (MHz)	Measure Level (dBuV/m)	Reading Level (dBuV)	Over Limit (dB)	Limit (dBuV/m)	Factor (dB)	Type
1		4960.000	41.736	46.398	-32.264	74.000	-4.662	PK
2	*	7440.000	42.261	43.304	-31.739	74.000	-1.043	PK
3		9920.000	41.567	38.520	-32.433	74.000	3.047	PK

Profile: 2190330R	Page No.: 204
Engineer: Neil	
Site: AC5	Time: 2021/09/16 - 21:28
Limit: FCC_Part15.209_RE(3m)	Margin: 0
Probe: Horn_3117_00123988_(1-18GHz)	Polarity: Vertical
EUT: Bluetooth headset	Power: 3.7 Vdc
Note: Mode 1:Transmit at 2480MHz by LE_1Mbps	

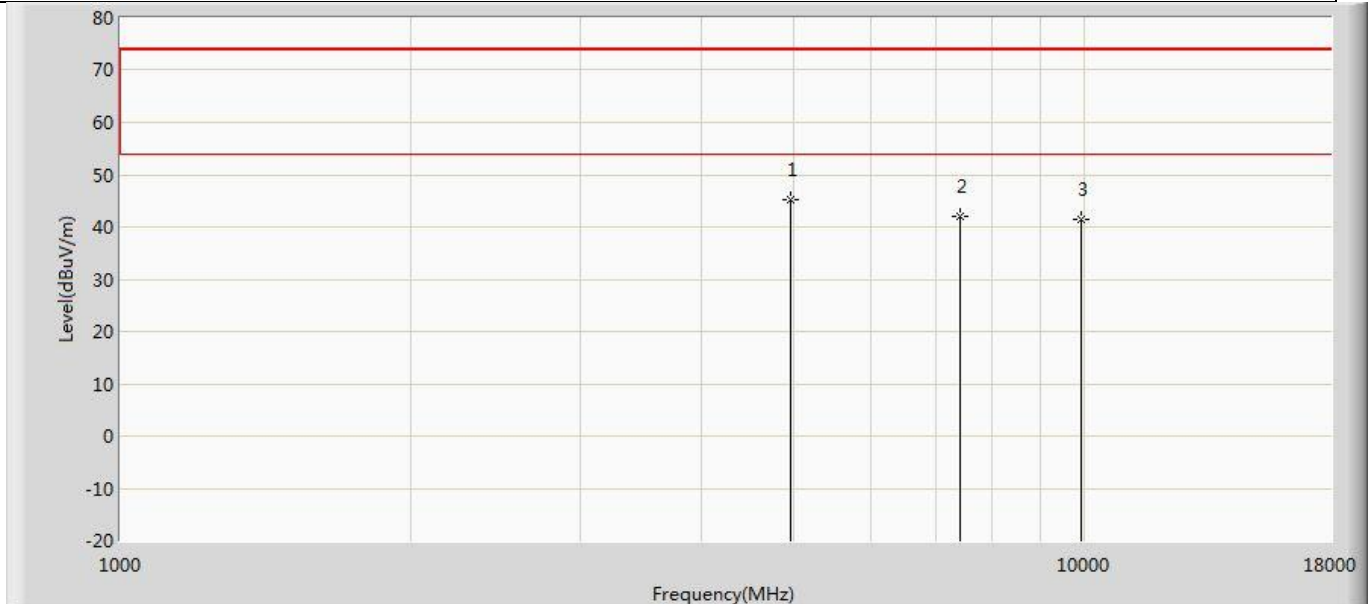

No	Mark	Frequency (MHz)	Measure Level (dBuV/m)	Reading Level (dBuV)	Over Limit (dB)	Limit (dBuV/m)	Factor (dB)	Type
1	*	4960.000	45.310	49.972	-28.690	74.000	-4.662	PK
2		7440.000	41.897	42.940	-32.103	74.000	-1.043	PK
3		9920.000	41.453	38.406	-32.547	74.000	3.047	PK

Note:

1. Measured Level = Reading Level + Factor.
2. The test frequency range, 9kHz~30MHz, 18GHz~26GHz, both of the worst case are at least 20dB below the limits, therefore no data appear in the report.
3. This limit applies for using average detector, if the test result on peak is lower than average limit, then average measurement needn't be performed.
4. As the radiated emission was performed, so conducted emission was not tested.

The worst case of Radiated Emission below 1GHz:

Profile: 2190330R	Page No.: 11
Engineer: Neil	
Site: AC2	Time: 2021/09/17 - 05:44
Limit: FCC_Part15.209_RE(3m)	Margin: 0
Probe: AC2_3M(30-1000M)	Polarity: Horizontal
EUT: Bluetooth headset	Power: 3.7 Vdc
Note: Mode1	

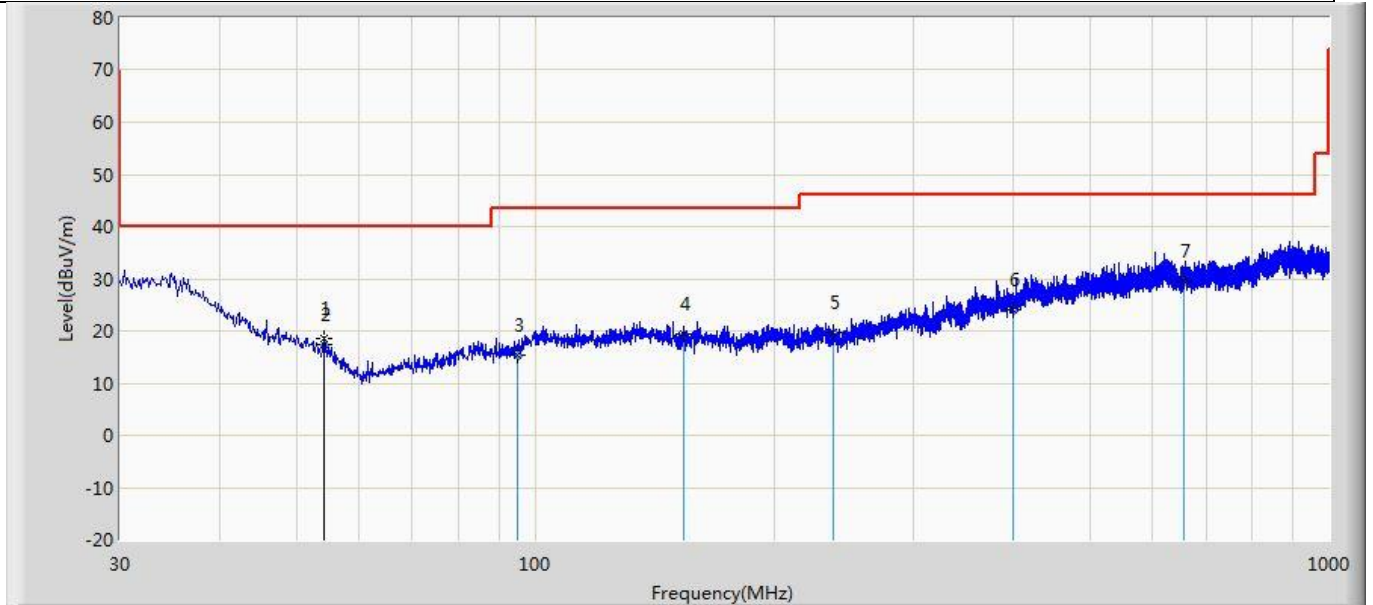

No	Mark	Frequency (MHz)	Measure Level (dBuV/m)	Reading Level (dBuV)	Over Limit (dB)	Limit (dBuV/m)	Factor (dB)	Type
1		54.250	18.579	4.743	-21.421	40.000	13.836	PK
2		54.250	17.485	3.649	-22.515	40.000	13.836	QP
3		95.111	15.487	0.498	-28.013	43.500	14.989	QP
4		153.675	19.524	2.675	-23.976	43.500	16.849	QP
5		237.216	19.598	2.069	-26.402	46.000	17.528	QP
6		399.449	24.125	-0.793	-21.875	46.000	24.918	QP
7	*	655.407	29.587	0.904	-16.413	46.000	28.683	QP

Profile: 2190330R	Page No.: 12
Engineer: Neil	
Site: AC2	Time: 2021/09/17 - 05:48
Limit: FCC_Part15.209_RE(3m)	Margin: 0
Probe: AC2_3M(30-1000M)	Polarity: Vertical
EUT: Bluetooth headset	Power: 3.7 Vdc
Note: Mode1	

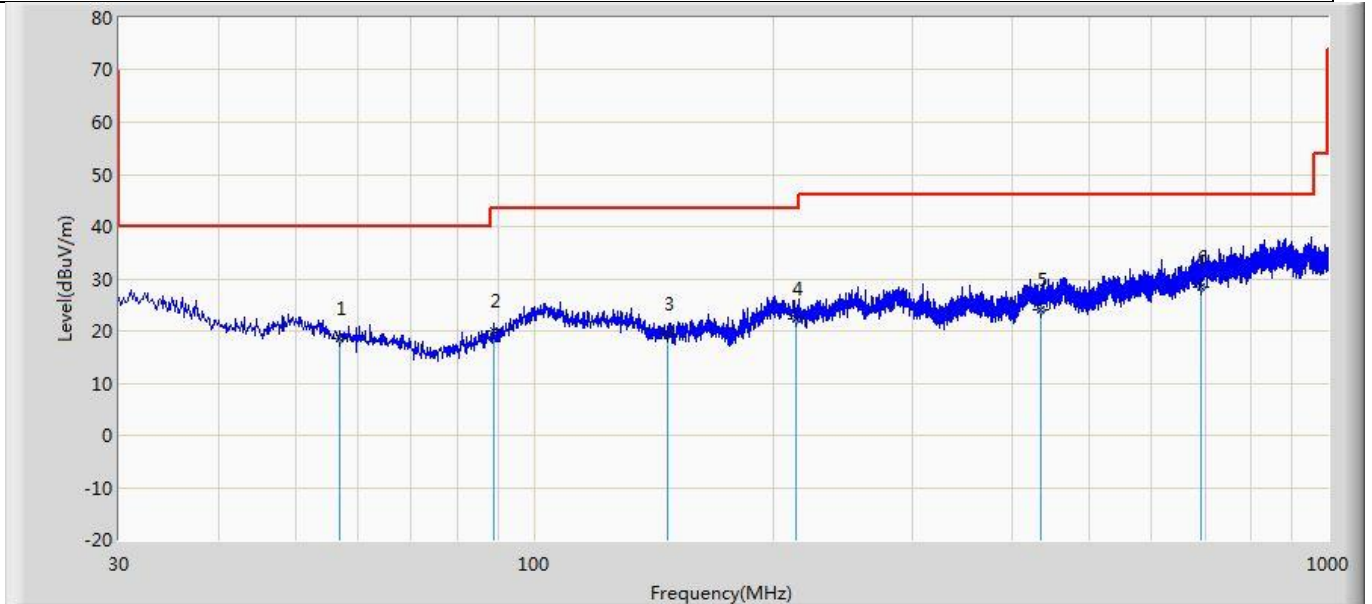

No	Mark	Frequency (MHz)	Measure Level (dBuV/m)	Reading Level (dBuV)	Over Limit (dB)	Limit (dBuV/m)	Factor (dB)	Type
1		56.796	18.524	1.609	-21.476	40.000	16.915	QP
2		88.927	20.125	3.404	-23.375	43.500	16.720	QP
3		147.249	19.364	1.577	-24.136	43.500	17.788	QP
4		213.815	22.345	0.001	-21.155	43.500	22.343	QP
5		434.247	24.166	-1.919	-21.834	46.000	26.084	QP
6	*	691.055	28.416	-1.697	-17.584	46.000	30.112	QP

4.2 Band Edge	VERDICT: PASS
----------------------	----------------------

4.2.1 Limit

Standard		FCC Part 15 Subpart C Paragraph 15.247(d) ,15.209		
Frequency bands (MHz)	Detector	Limit (dB μ V/m)	RBW (MHz)	Distance (m)
2310-2390	PK	74	1	3
2483.5-2500	AV	54	1	3

Note: The field strength of emissions appearing within these frequency bands shall not exceed the limits.

4.2.2 Test Setup

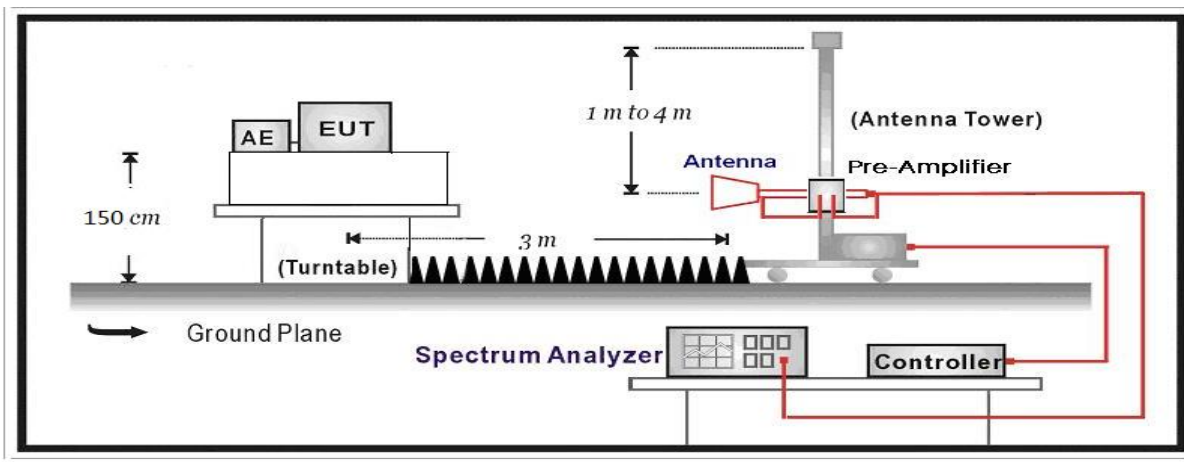

4.2.3 Test Procedure

	References Rule	Chapter	Description
<input checked="" type="checkbox"/>	ANSI C63.10	6.10	Band-edge testing
	<input checked="" type="checkbox"/> ANSI C63.10	6.10.5	Restricted-band band-edge measurements
	<input type="checkbox"/> ANSI C63.10	6.10.6	Marker-delta method
<input checked="" type="checkbox"/>	ANSI C63.10	11.12	Emissions in restricted frequency bands
	<input checked="" type="checkbox"/> ANSI C63.10	11.12.1	Radiated emission measurements
	<input checked="" type="checkbox"/> ANSI C63.10	6.3	Radiated spurious emission test
<input type="checkbox"/>	ANSI C63.10	6.4	Radiated emissions from unlicensed wireless devices below 30 MHz
<input type="checkbox"/>	ANSI C63.10	6.5	Radiated emissions from unlicensed wireless devices in the frequency range of 30 MHz to 1000 MHz
<input checked="" type="checkbox"/>	ANSI C63.10	6.6	Radiated emissions from unlicensed wireless devices above 1 GHz

4.2.4 Test Data

Profile: 2190330R	Page No.: 197
Engineer: Neil	
Site: AC5	Time: 2021/09/16 - 23:26
Limit: FCC_Part15.209_RE(3m)	Margin: 0
Probe: Horn_3117_00123988_(1-18GHz)	Polarity: Horizontal
EUT: Bluetooth headset	Power: 3.7 Vdc
Note: Mode 1:Transmit at 2402MHz by LE_1Mbps	

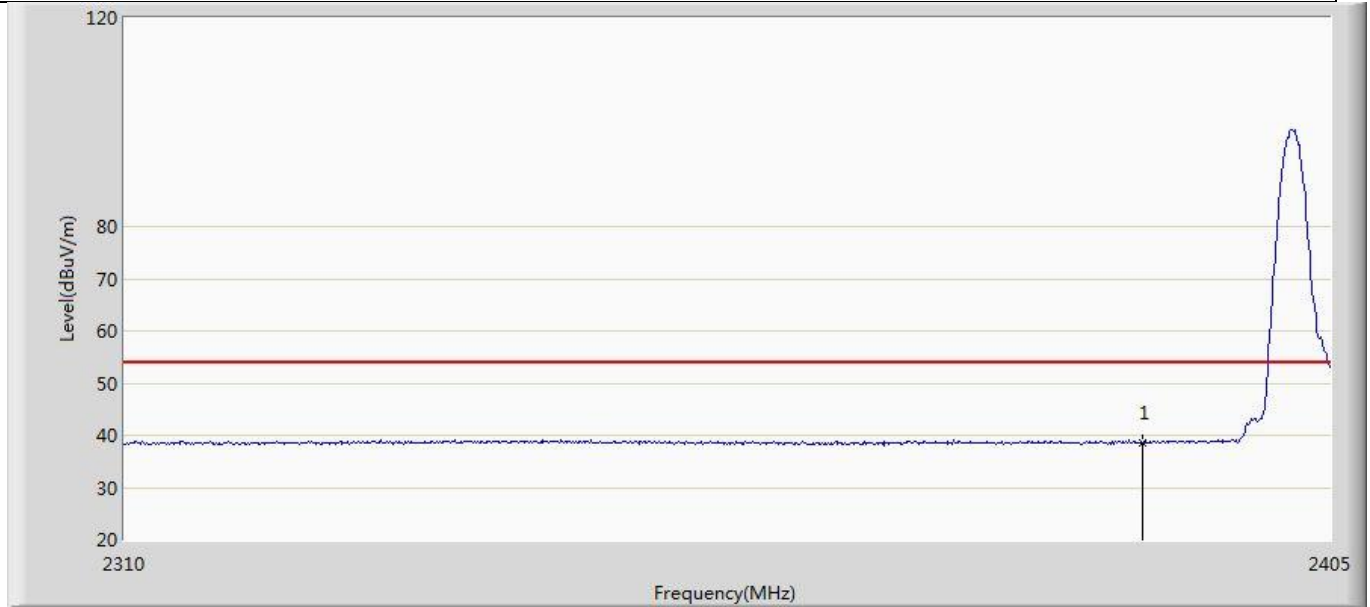

No	Mark	Frequency (MHz)	Measure Level (dBuV/m)	Reading Level (dBuV)	Over Limit (dB)	Limit (dBuV/m)	Factor (dB)	Type
1	*	2390.000	38.627	3.168	-15.373	54.000	35.459	AV

Profile: 2190330R	Page No.: 198
Engineer: Neil	
Site: AC5	Time: 2021/09/16 - 23:37
Limit: FCC_Part15.209_RE(3m)	Margin: 0
Probe: Horn_3117_00123988_(1-18GHz)	Polarity: Horizontal
EUT: Bluetooth headset	Power: 3.7 Vdc
Note: Mode 1:Transmit at 2402MHz by LE_1Mbps	

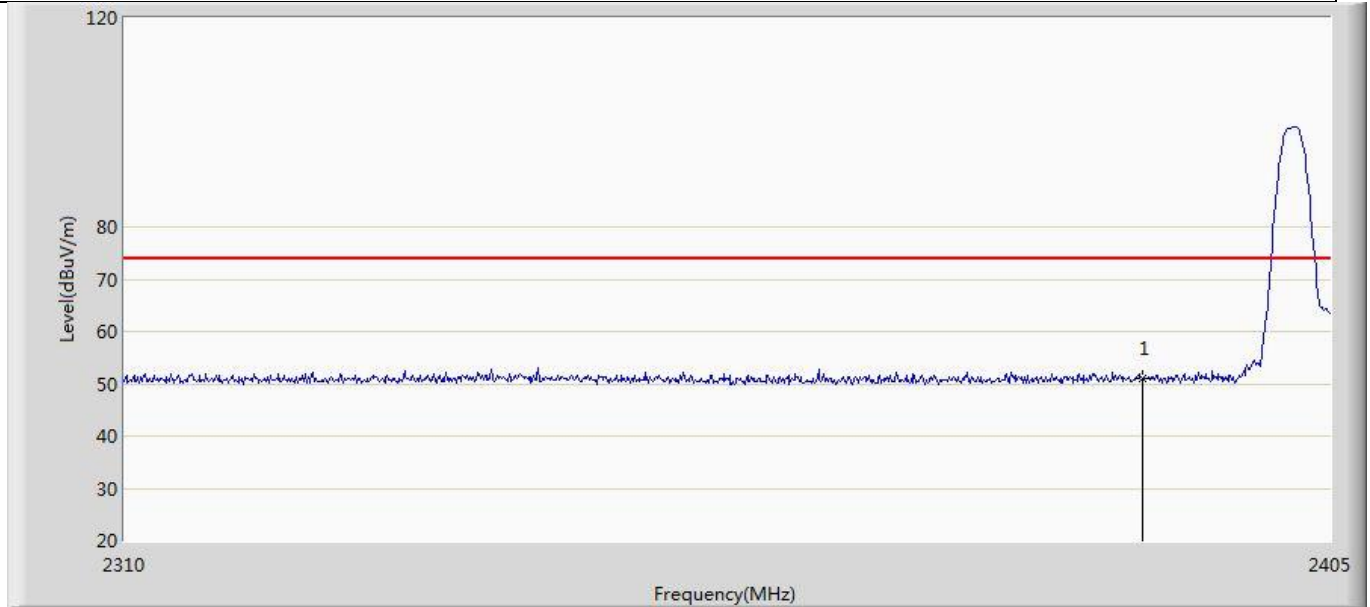

No	Mark	Frequency (MHz)	Measure Level (dBuV/m)	Reading Level (dBuV)	Over Limit (dB)	Limit (dBuV/m)	Factor (dB)	Type
1	*	2390.000	51.115	15.656	-22.885	74.000	35.459	PK

Profile: 2190330R	Page No.: 199
Engineer: Neil	
Site: AC5	Time: 2021/09/16 - 23:38
Limit: FCC_Part15.209_RE(3m)	Margin: 0
Probe: Horn_3117_00123988_(1-18GHz)	Polarity: Vertical
EUT: Bluetooth headset	Power: 3.7 Vdc
Note: Mode 1:Transmit at 2402MHz by LE_1Mbps	

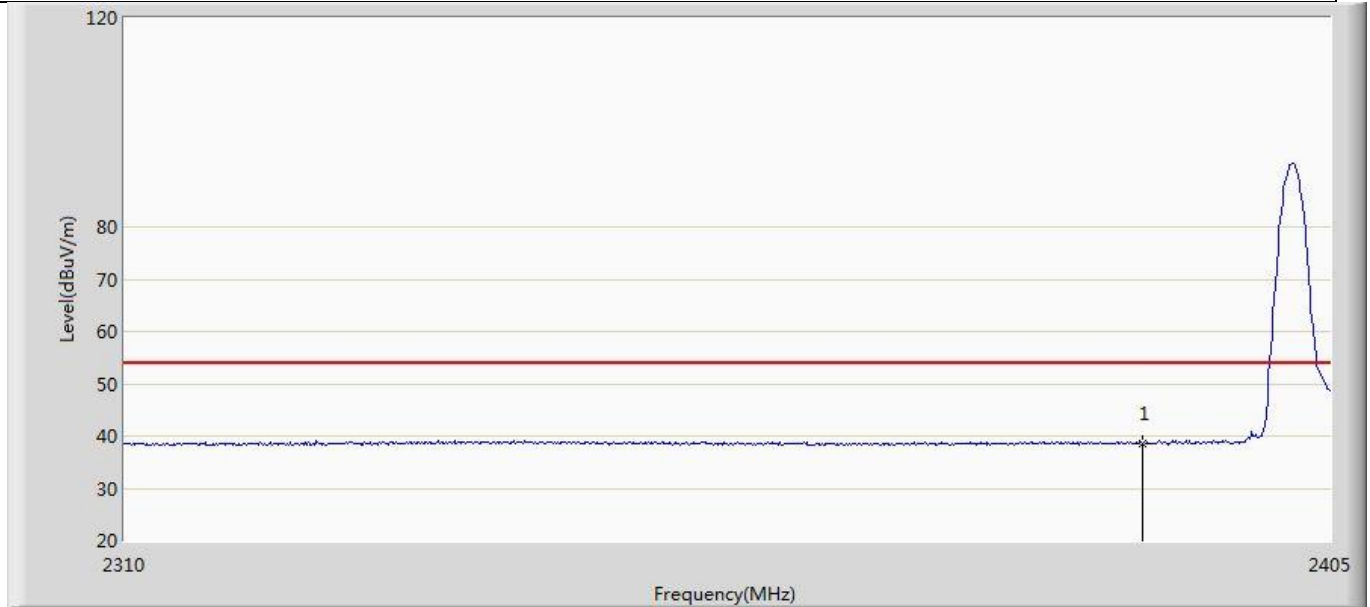

No	Mark	Frequency (MHz)	Measure Level (dBuV/m)	Reading Level (dBuV)	Over Limit (dB)	Limit (dBuV/m)	Factor (dB)	Type
1	*	2390.000	38.565	3.106	-15.435	54.000	35.459	AV

Profile: 2190330R	Page No.: 200
Engineer: Neil	
Site: AC5	Time: 2021/09/16 - 23:39
Limit: FCC_Part15.209_RE(3m)	Margin: 0
Probe: Horn_3117_00123988_(1-18GHz)	Polarity: Vertical
EUT: Bluetooth headset	Power: 3.7 Vdc
Note: Mode 1:Transmit at 2402MHz by LE_1Mbps	

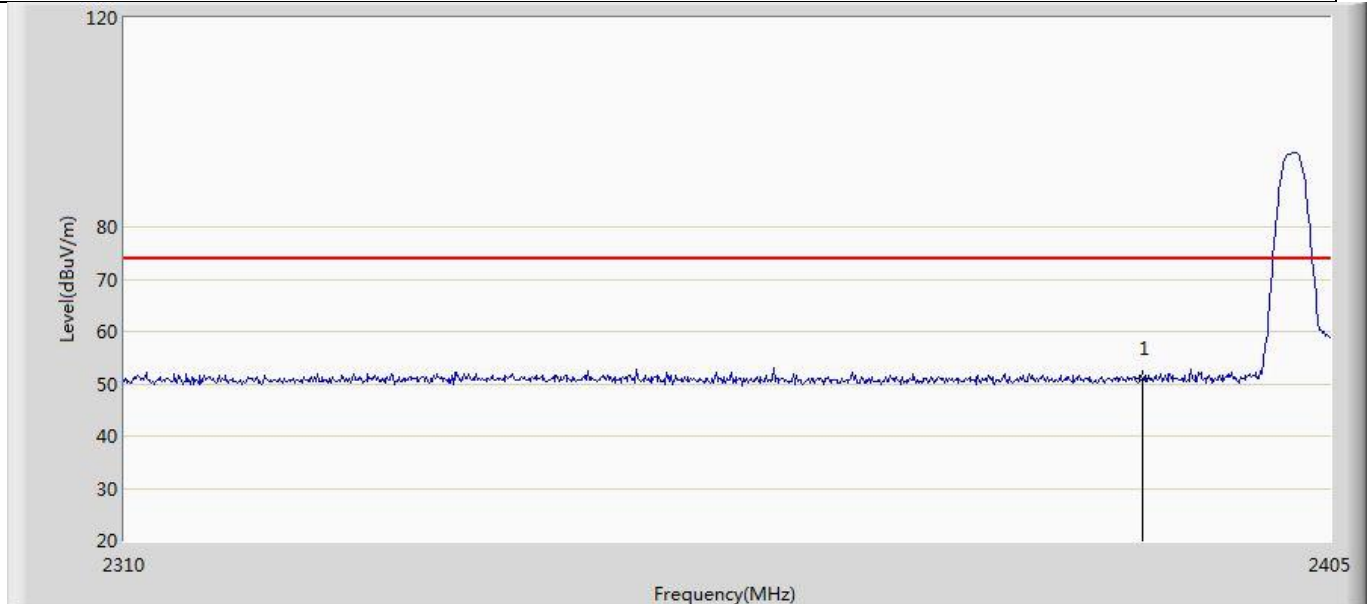

No	Mark	Frequency (MHz)	Measure Level (dBuV/m)	Reading Level (dBuV)	Over Limit (dB)	Limit (dBuV/m)	Factor (dB)	Type
1	*	2390.000	51.022	15.563	-22.978	74.000	35.459	PK

Profile: 2190330R	Page No.: 201
Engineer: Neil	
Site: AC5	Time: 2021/09/16 - 23:40
Limit: FCC_Part15.209_RE(3m)	Margin: 0
Probe: Horn_3117_00123988_(1-18GHz)	Polarity: Horizontal
EUT: Bluetooth headset	Power: 3.7 Vdc
Note: Mode 1:Transmit at 2480MHz by LE_1Mbps	

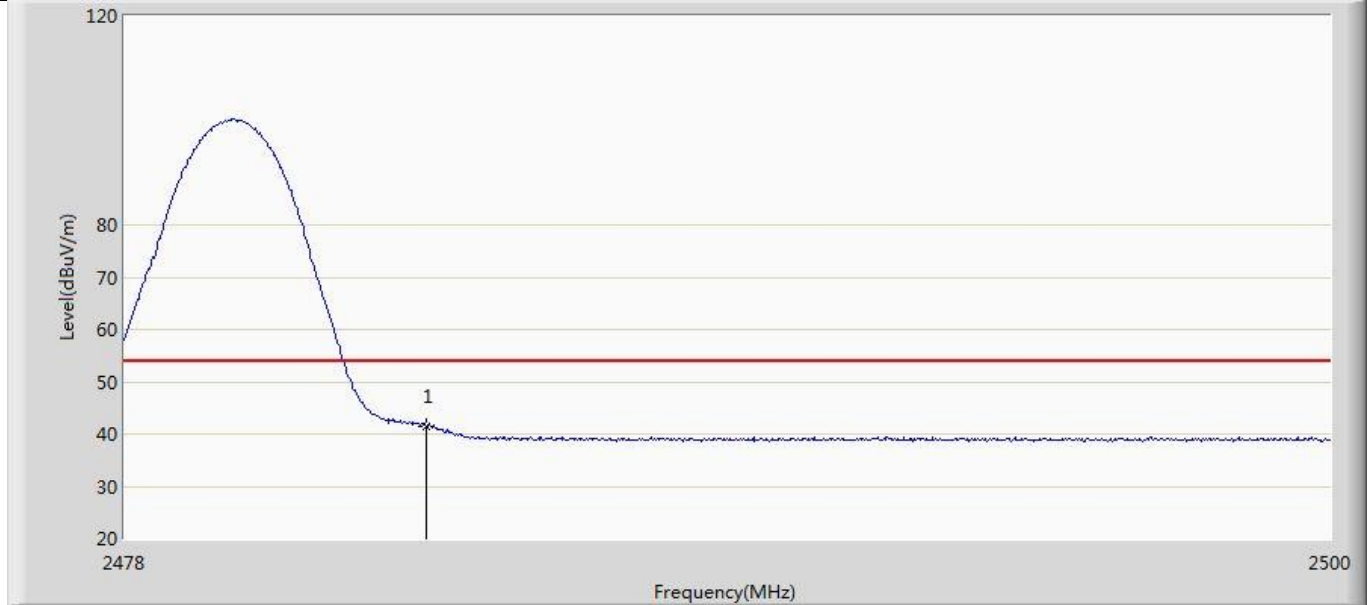

No	Mark	Frequency (MHz)	Measure Level (dBuV/m)	Reading Level (dBuV)	Over Limit (dB)	Limit (dBuV/m)	Factor (dB)	Type
1	*	2483.500	41.342	5.667	-12.658	54.000	35.675	AV

Profile: 2190330R	Page No.: 202
Engineer: Neil	
Site: AC5	Time: 2021/09/16 - 23:43
Limit: FCC_Part15.209_RE(3m)	Margin: 0
Probe: Horn_3117_00123988_(1-18GHz)	Polarity: Horizontal
EUT: Bluetooth headset	Power: 3.7 Vdc
Note: Mode 1:Transmit at 2480MHz by LE_1Mbps	

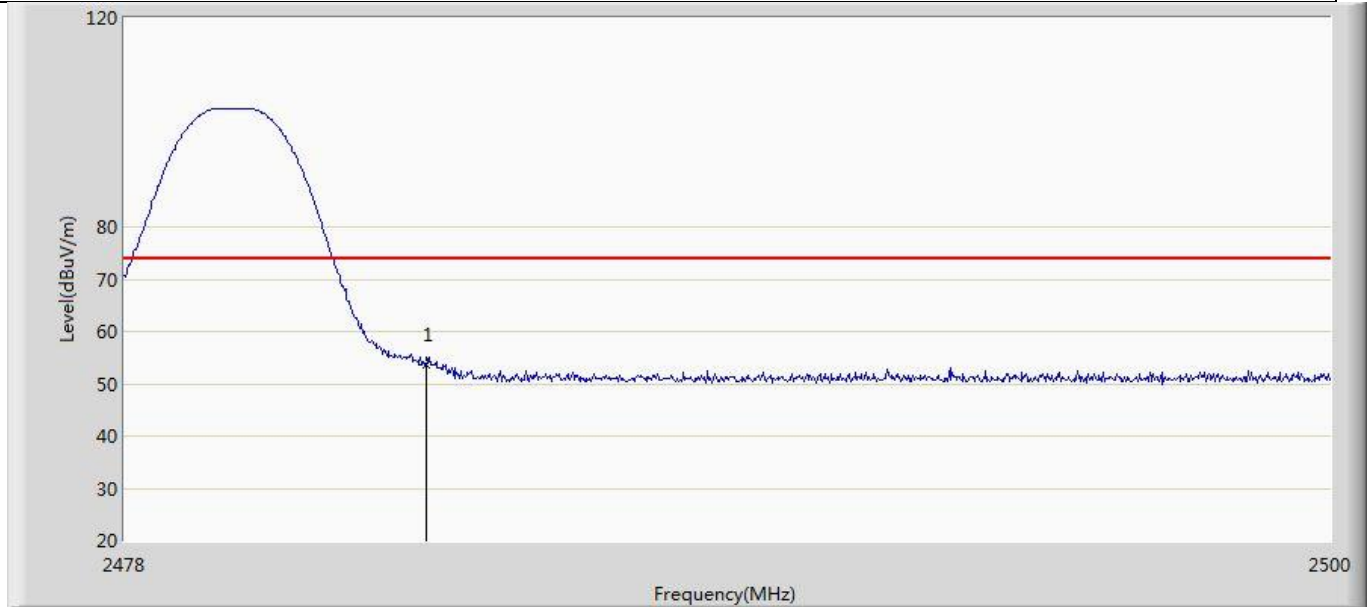

No	Mark	Frequency (MHz)	Measure Level (dBuV/m)	Reading Level (dBuV)	Over Limit (dB)	Limit (dBuV/m)	Factor (dB)	Type
1	*	2483.500	53.700	18.025	-20.300	74.000	35.675	PK

Profile: 2190330R	Page No.: 203
Engineer: Neil	
Site: AC5	Time: 2021/09/16 - 23:43
Limit: FCC_Part15.209_RE(3m)	Margin: 0
Probe: Horn_3117_00123988_(1-18GHz)	Polarity: Vertical
EUT: Bluetooth headset	Power: 3.7 Vdc
Note: Mode 1:Transmit at 2480MHz by LE_1Mbps	

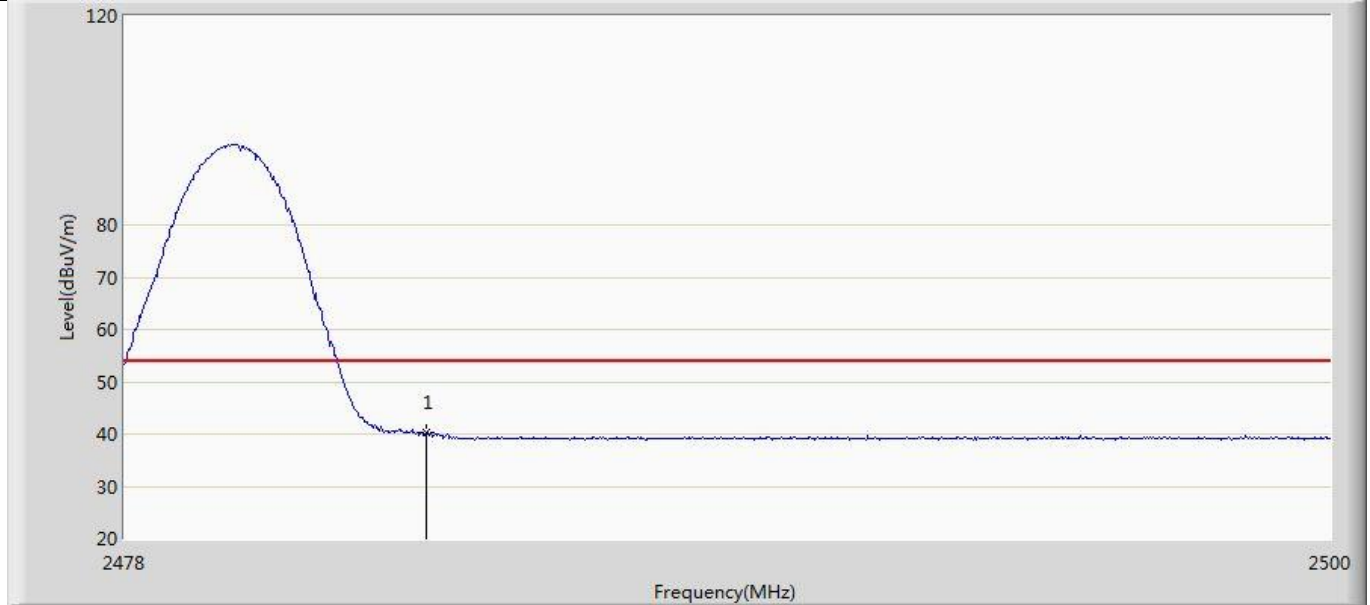

No	Mark	Frequency (MHz)	Measure Level (dBuV/m)	Reading Level (dBuV)	Over Limit (dB)	Limit (dBuV/m)	Factor (dB)	Type
1	*	2483.500	40.296	4.621	-13.704	54.000	35.675	AV

Profile: 2190330R	Page No.: 204
Engineer: Neil	
Site: AC5	Time: 2021/09/16 - 23:45
Limit: FCC_Part15.209_RE(3m)	Margin: 0
Probe: Horn_3117_00123988_(1-18GHz)	Polarity: Vertical
EUT: Bluetooth headset	Power: 3.7 Vdc
Note: Mode 1:Transmit at 2480MHz by LE_1Mbps	

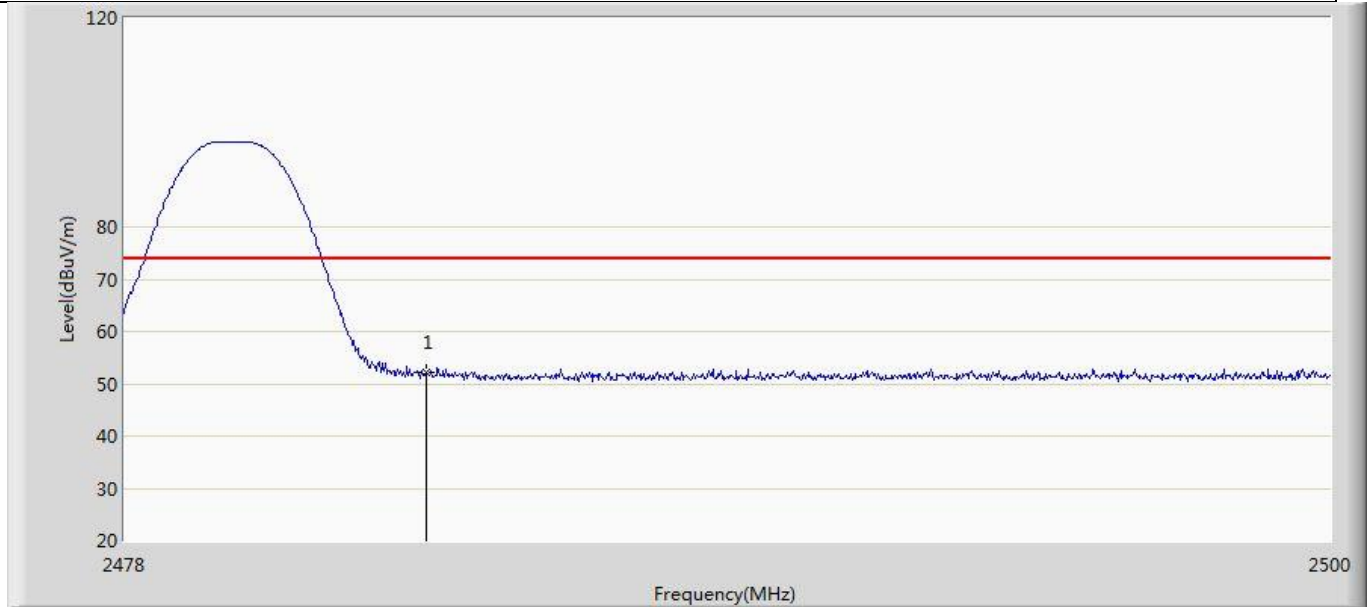

No	Mark	Frequency (MHz)	Measure Level (dBuV/m)	Reading Level (dBuV)	Over Limit (dB)	Limit (dBuV/m)	Factor (dB)	Type
1	*	2483.500	52.267	16.592	-21.733	74.000	35.675	PK

4.3 Fundamental emission output power	VERDICT: PASS
--	----------------------

4.3.1 Limit		
Standard	FCC Part 15 Subpart C Paragraph 15.247 (b)(3)	
<input checked="" type="checkbox"/>	GTX < 6dBi	Pout ≤ 30dBm
<input type="checkbox"/>	GTX > 6dBi	
<input type="checkbox"/>	Non-Fix point-point	Pout ≤ 30 - (GTX - 6)
<input type="checkbox"/>	Fix point-point	Pout ≤ 30 - [(GTX - 6)]/3
<input type="checkbox"/>	Point-to-multipoint	Pout ≤ 30 - (GTX - 6)
<input type="checkbox"/>	Overlap Beams	Pout ≤ 30 - [(GTX - 6)]/3
<input type="checkbox"/>	Aggregate power transmitted simultaneously on all beams	Pout ≤ 30 - [(GTX - 6)]/3
<input type="checkbox"/>	single directional beam	Pout ≤ 30 - [(GTX - 6)]/3 + 8dB
Note 1 : GTX directional gain of transmitting antennas. Note 2 : Pout is maximum peak conducted output power .		

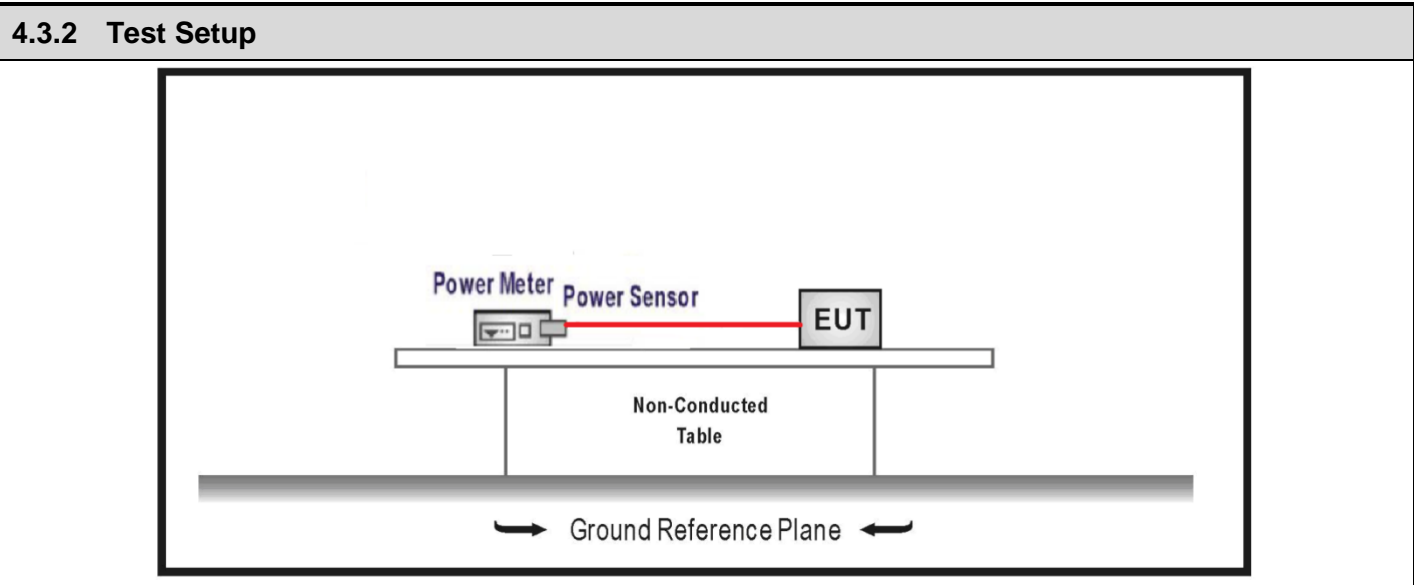

4.3.3 Test Procedure				
	References Rule		Chapter	Description
<input checked="" type="checkbox"/>	ANSI C63.10		11.9	Fundamental emission output power
<input checked="" type="checkbox"/>	<input checked="" type="checkbox"/>	ANSI C63.10	11.9.1	Maximum peak conducted output power
	<input type="checkbox"/>	ANSI C63.10	11.9.1.1	RBW \geq DTS bandwidth
	<input type="checkbox"/>	ANSI C63.10	11.9.1.2	Integrated band power method
	<input checked="" type="checkbox"/>	ANSI C63.10	11.9.1.3	PKPM1 Peak power meter method
	<input type="checkbox"/>	ANSI C63.10	11.9.2	Maximum conducted (average) output power
	<input type="checkbox"/>	ANSI C63.10	11.9.2.2	Measurement using a spectrum analyzer (SA)
		<input type="checkbox"/>	ANSI C63.10	11.9.2.2.2 Method AVGSA-1(Duty cycle \geq 98%)
		<input type="checkbox"/>	ANSI C63.10	11.9.2.2.3 Method AVGSA-1A(Duty cycle \geq 98%)
		<input type="checkbox"/>	ANSI C63.10	11.9.2.2.4 Method AVGSA-2(Duty cycle \leq 98%)
		<input type="checkbox"/>	ANSI C63.10	11.9.2.2.5 Method AVGSA-2A(Duty cycle \leq 98%)
		<input type="checkbox"/>	ANSI C63.10	11.9.2.2.4 Method AVGSA-3
		<input type="checkbox"/>	ANSI C63.10	11.9.2.2.5 Method AVGSA-3A
	<input type="checkbox"/>	ANSI C63.10	11.9.2.3	Measurement using a power meter (PM)
		<input type="checkbox"/>	ANSI C63.10	11.9.2.3.1 Method AVGPM
		<input type="checkbox"/>	ANSI C63.10	11.9.2.3.2 Method AVGPM-G

4.3.4 Test Data

Mode	Channel	Test Frequency (MHz)	Conducted Power (dBm)	EIRP (dBm)	Conducted Power Limit (dBm)	EIRP Limit (dBm)	Result
Mode 1	00	2402	6.31	8.28	≤30	≤36	Pass
	19	2440	6.79	8.76	≤30	≤36	Pass
	39	2480	6.98	8.95	≤30	≤36	Pass

5 TEST SETUP PHOTO AND EUT PHOTO

Remark: The test setup photo and EUT Photo please see appendix.

_____ The End _____