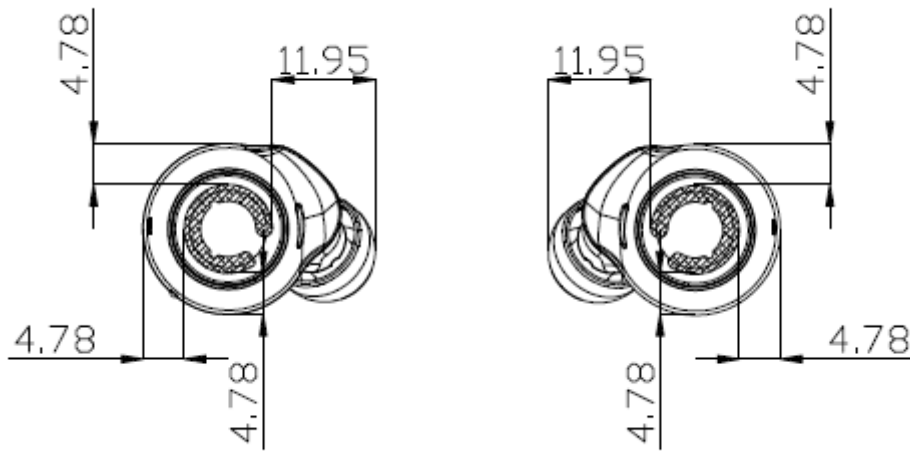


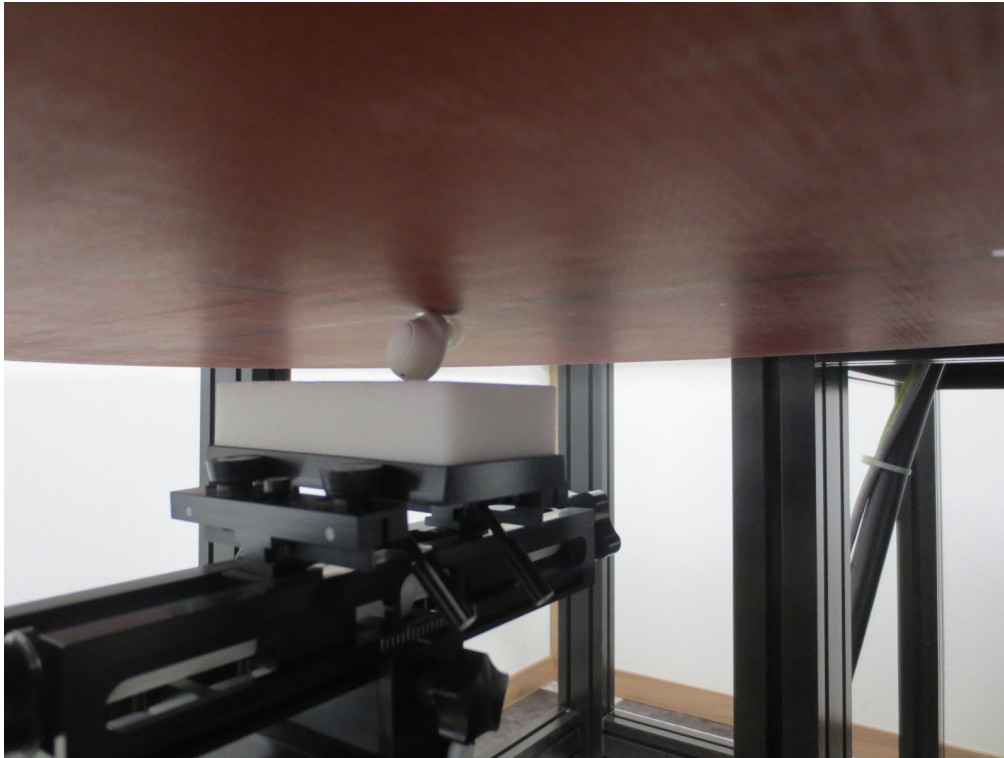
## APPENDIX F: DUT ANTENNA DIAGRAM & SAR TEST SETUP PHOTOGRAPHS

**DUT Antenna Location**

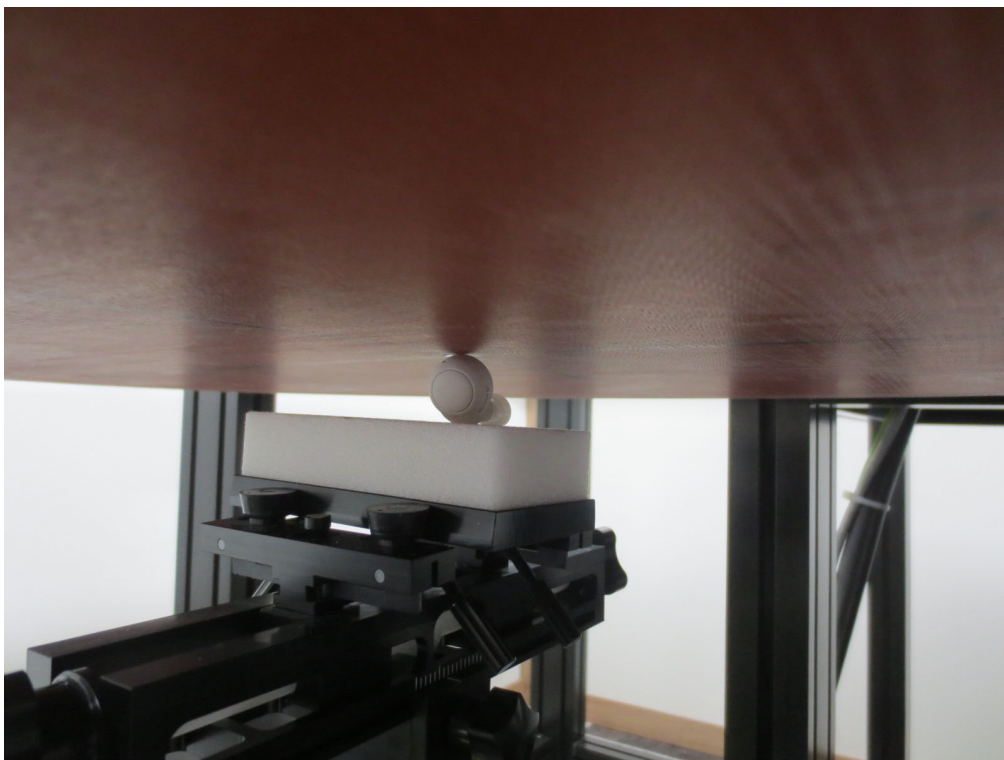


**Figure F-1 Antenna Location**

**SAR Test Setup Photographs**



**Top from Flat Phantom (Separation Distance: 0 cm) – Right Ear**



**Bottom from Flat Phantom (Separation Distance: 0 cm) – Right Ear**



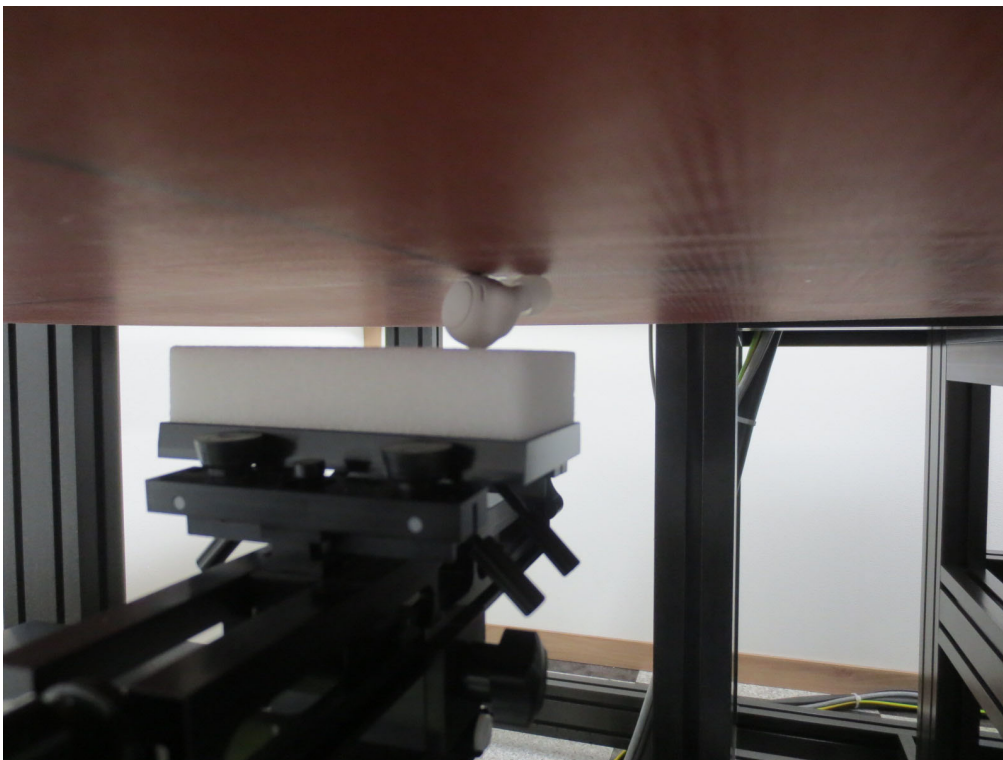
**Front from Flat Phantom (Separation Distance: 0 cm) – Right Ear**



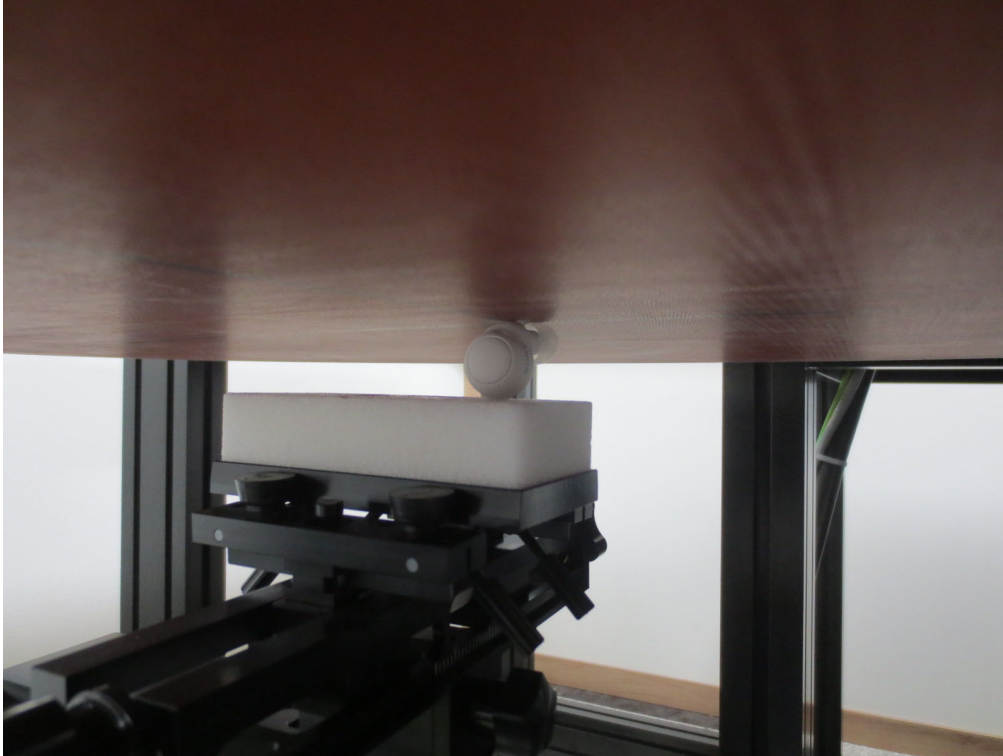
**Right Ear & Rear from Flat Phantom (Separation Distance: 0 cm) – Right Ear**



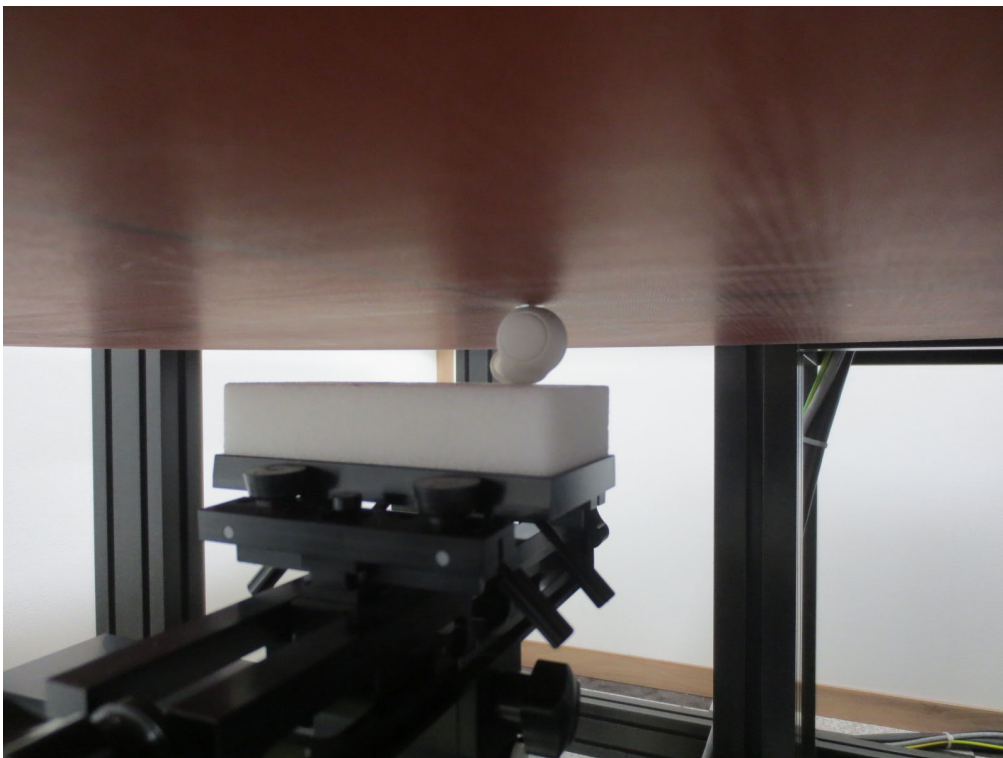
**Right from Flat Phantom (Separation Distance: 0 cm) – Right Ear**



**Left from Flat Phantom (Separation Distance: 0 cm) – Right Ear**



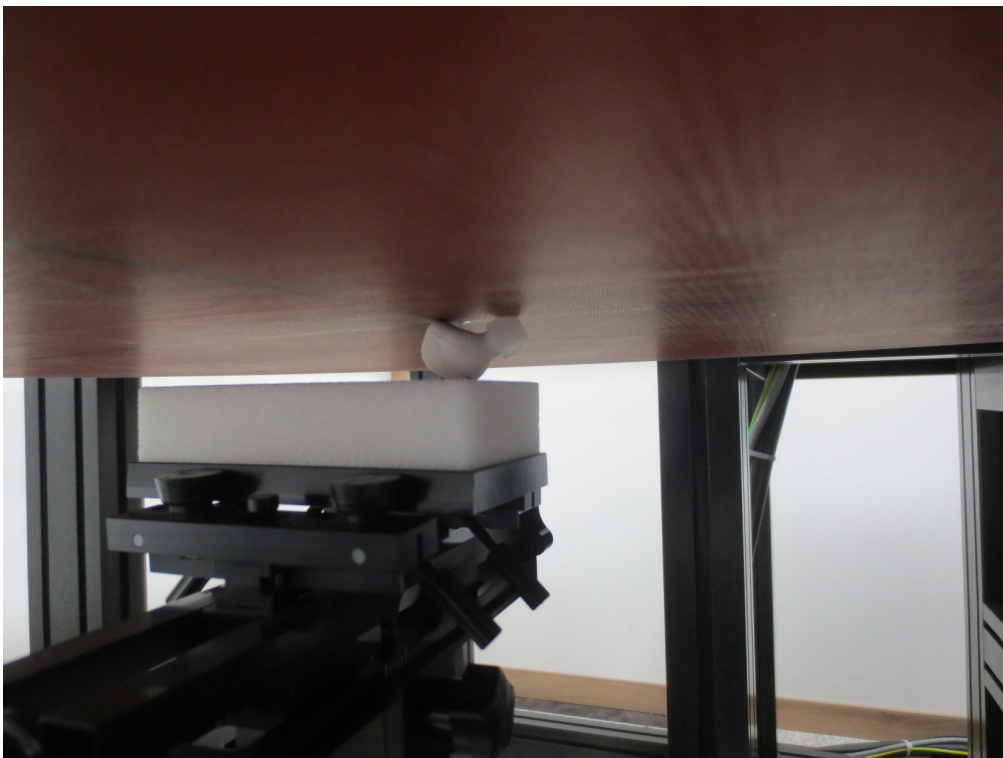
**Top from Flat Phantom (Separation Distance: 0 cm) – Left Ear**



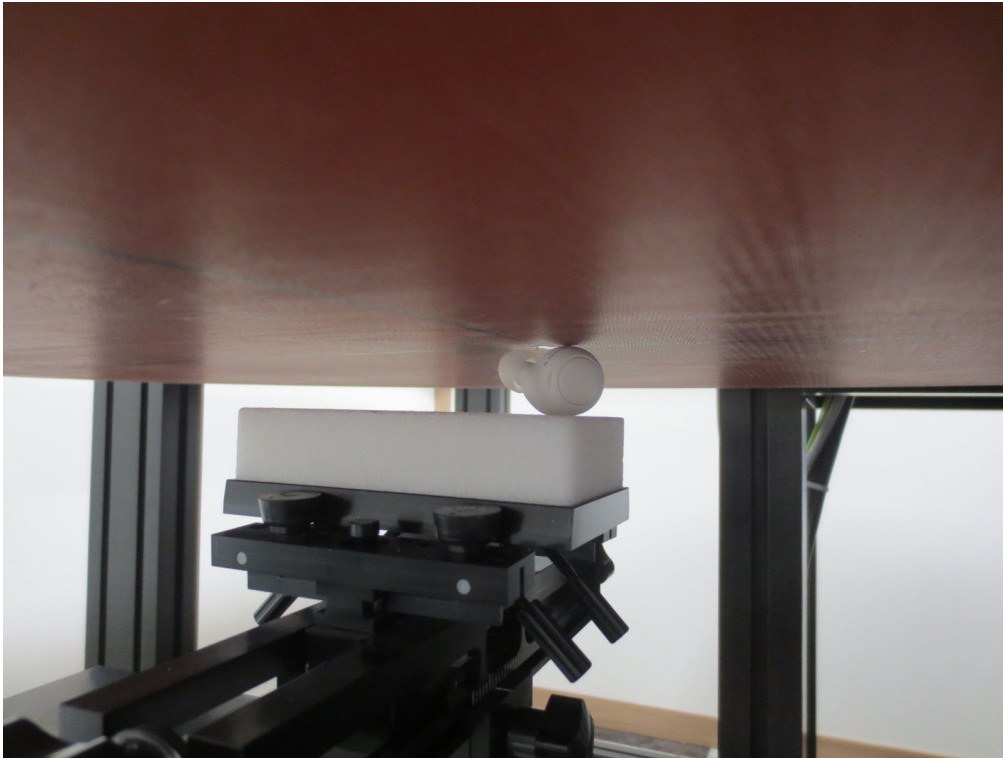
**Bottom from Flat Phantom (Separation Distance: 0 cm) – Left Ear**



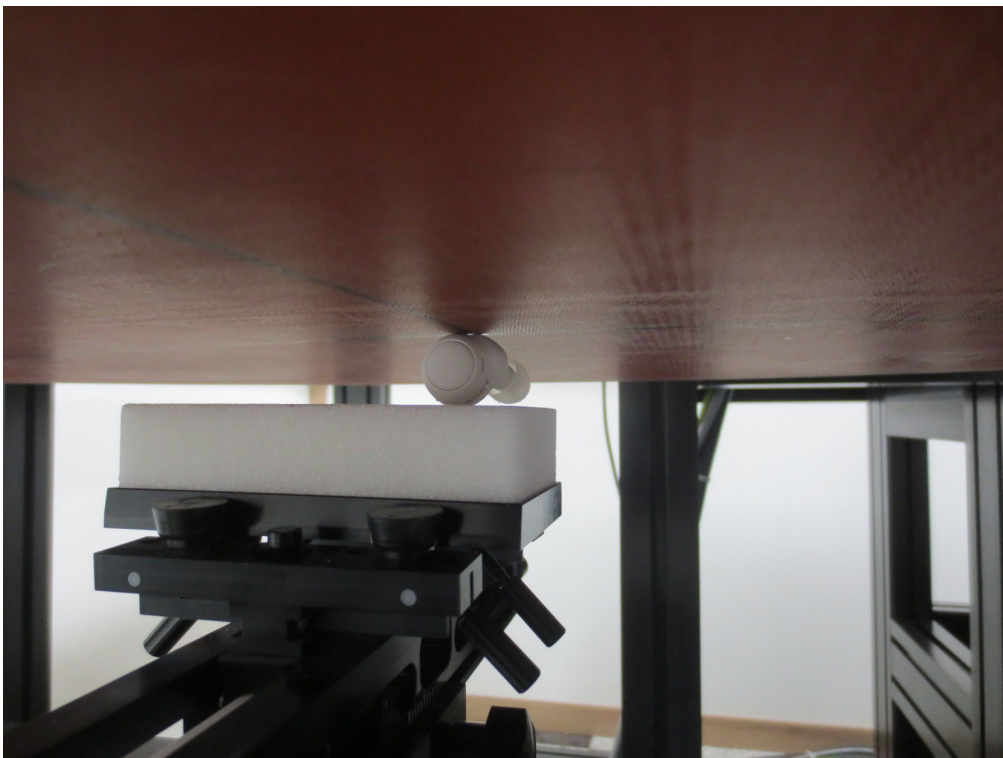
**Front from Flat Phantom (Separation Distance: 0 cm) – Left Ear**



**Left Ear & Rear from Flat Phantom (Separation Distance: 0 cm) – Left Ear**



**Right from Flat Phantom (Separation Distance: 0 cm) – Left Ear**



**Left from Flat Phantom (Separation Distance: 0 cm) – Left Ear**