

IW611-IW620-G

ANTENNA DATA SHEET

Sony Corporation

Manufacturer: Sony Corporation

Manufacturer Address: 1-7-1 Konan
Minato-ku Tokyo
108-0075 Japan

Country of Origin: Malaysia

1. Specification

Item	Characteristics
Antenna Type	Dipole
FrequencyRange	2.4 ~ 2.4835GHz 5.15 ~ 5.85GHz
Input Impedance	50 Ω
V.S.W.R	< 3.0
Polarization	linear polarization

Antenna Type : Dipole

2. Antenna Drawing

Antenna

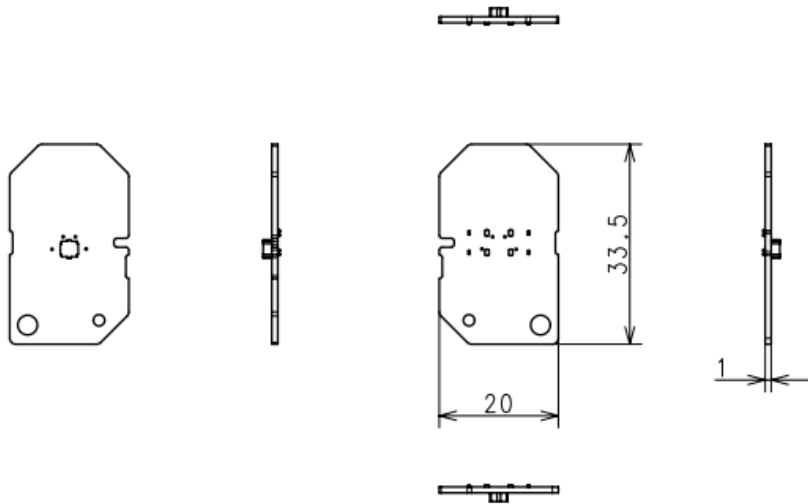

Coaxial cable

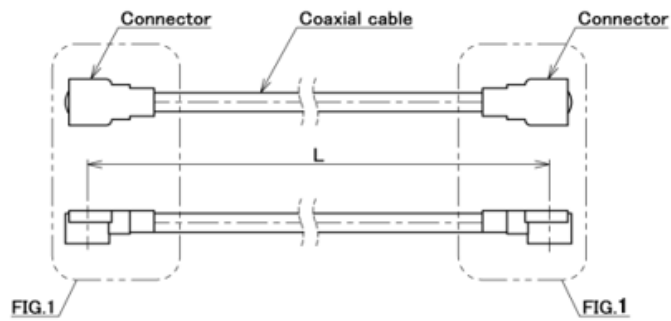
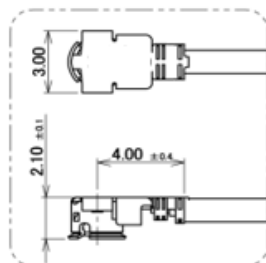

FIG.1



L: Cable Length
Refer to Page 3 and 4.

Serial number	Cable Length [mm]	Cable Loss					
		2.4GHz	2.45GHz	2.5GHz	5.15GHz	5.5GHz	5.85GHz
100	100	0.51	0.51	0.52	0.79	0.80	0.82
110	110	0.54	0.54	0.55	0.84	0.85	0.87
120	120	0.57	0.57	0.58	0.88	0.90	0.92
130	130	0.60	0.60	0.62	0.93	0.94	0.97
140	140	0.63	0.64	0.65	0.98	0.99	1.02
150	150	0.67	0.67	0.68	1.02	1.04	1.07
160	160	0.70	0.70	0.71	1.07	1.09	1.12
170	170	0.73	0.73	0.74	1.11	1.14	1.17
180	180	0.76	0.76	0.77	1.16	1.18	1.22
190	190	0.79	0.79	0.81	1.21	1.23	1.27
200	200	0.82	0.83	0.84	1.25	1.28	1.32
210	210	0.85	0.86	0.87	1.30	1.33	1.37
220	220	0.88	0.89	0.90	1.35	1.37	1.42
230	230	0.91	0.92	0.93	1.39	1.42	1.47
240	240	0.95	0.95	0.96	1.44	1.47	1.52
250	250	0.98	0.98	1.00	1.48	1.52	1.57
260	260	1.01	1.02	1.03	1.53	1.57	1.62
270	270	1.04	1.05	1.06	1.58	1.61	1.67
280	280	1.07	1.08	1.09	1.62	1.66	1.72
290	290	1.10	1.11	1.12	1.67	1.71	1.77
300	300	1.13	1.14	1.15	1.72	1.76	1.82
310	310	1.16	1.17	1.19	1.76	1.81	1.87
320	320	1.19	1.21	1.22	1.81	1.85	1.92
330	330	1.23	1.24	1.25	1.85	1.90	1.97
340	340	1.26	1.27	1.28	1.90	1.95	2.02
350	350	1.29	1.30	1.31	1.95	2.00	2.07
360	360	1.32	1.33	1.34	1.99	2.05	2.12
370	370	1.35	1.36	1.38	2.04	2.09	2.17
380	380	1.38	1.39	1.41	2.09	2.14	2.22
390	390	1.41	1.43	1.44	2.13	2.19	2.27
400	400	1.44	1.46	1.47	2.18	2.24	2.32
410	410	1.47	1.49	1.50	2.23	2.28	2.37
420	420	1.51	1.52	1.53	2.27	2.33	2.42
430	430	1.54	1.55	1.57	2.32	2.38	2.47
440	440	1.57	1.58	1.60	2.36	2.43	2.52
450	450	1.60	1.62	1.63	2.41	2.48	2.57

Serial number	Cable Length [mm]	Cable Loss					
		2.4GHz	2.45GHz	2.5GHz	5.15GHz	5.5GHz	5.85GHz
460	460	1.63	1.65	1.66	2.46	2.52	2.62
470	470	1.66	1.68	1.69	2.50	2.57	2.67
480	480	1.69	1.71	1.72	2.55	2.62	2.72
490	490	1.72	1.74	1.76	2.60	2.67	2.77
500	500	1.75	1.77	1.79	2.64	2.72	2.82
510	510	1.79	1.81	1.82	2.69	2.76	2.87
520	520	1.82	1.84	1.85	2.73	2.81	2.92
530	530	1.85	1.87	1.88	2.78	2.86	2.97
540	540	1.88	1.90	1.91	2.83	2.91	3.02
550	550	1.91	1.93	1.95	2.87	2.96	3.07
560	560	1.94	1.96	1.98	2.92	3.00	3.12
570	570	1.97	2.00	2.01	2.97	3.05	3.17
580	580	2.00	2.03	2.04	3.01	3.10	3.22
590	590	2.03	2.06	2.07	3.06	3.15	3.27
600	600	2.07	2.09	2.11	3.11	3.20	3.32
610	610	2.10	2.12	2.14	3.15	3.24	3.36
620	620	2.13	2.15	2.17	3.20	3.29	3.41
630	630	2.16	2.18	2.20	3.24	3.34	3.46
640	640	2.19	2.22	2.23	3.29	3.39	3.51
650	650	2.22	2.25	2.26	3.34	3.43	3.56
660	660	2.25	2.28	2.30	3.38	3.48	3.61
670	670	2.28	2.31	2.33	3.43	3.53	3.66
680	680	2.31	2.34	2.36	3.48	3.58	3.71
690	690	2.34	2.37	2.39	3.52	3.63	3.76
700	700	2.38	2.41	2.42	3.57	3.67	3.81
710	710	2.41	2.44	2.45	3.61	3.72	3.86
720	720	2.44	2.47	2.49	3.66	3.77	3.91
730	730	2.47	2.50	2.52	3.71	3.82	3.96
740	740	2.50	2.53	2.55	3.75	3.87	4.01
750	750	2.53	2.56	2.58	3.80	3.91	4.06
760	760	2.56	2.60	2.61	3.85	3.96	4.11
770	770	2.59	2.63	2.64	3.89	4.01	4.16
780	780	2.62	2.66	2.68	3.94	4.06	4.21
790	790	2.66	2.69	2.71	3.98	4.11	4.26
800	800	2.69	2.72	2.74	4.03	4.15	4.31

Cable Loss Calculation

■2.4GHz

$$\text{Cable Loss[dB]} = 0.51 + 0.00311 * (\text{Cable Length[mm]} - 100)$$

■2.45GHz

$$\text{Cable Loss[dB]} = 0.51 + 0.00316 * (\text{Cable Length[mm]} - 100)$$

■2.5GHz

$$\text{Cable Loss[dB]} = 0.52 + 0.00317 * (\text{Cable Length[mm]} - 100)$$

■5.15GHz

$$\text{Cable Loss[dB]} = 0.79 + 0.00463 * (\text{Cable Length[mm]} - 100)$$

■5.5GHz

$$\text{Cable Loss[dB]} = 0.80 + 0.00479 * (\text{Cable Length[mm]} - 100)$$

■5.85GHz

$$\text{Cable Loss[dB]} = 0.82 + 0.00499 * (\text{Cable Length[mm]} - 100)$$

3. Antenna Gain Table

Frequency	Max Peak Gain (dBi)
2.400GHz	-1.11
2.450GHz	-0.15
2.500GHz	0.29
5.150-5.250GHz	1.36
5.250-5.350GHz	1.36
5.470-5.725GHz	0.93
5.725-5.850GHz	0.75

Antenna Cable (L = 100mm) included

Frequency	Min Peak Gain (dBi)
2.400GHz	-4.15
2.450GHz	-3.28
2.500GHz	-3.19
5.150-5.250GHz	-2.44
5.250-5.350GHz	-2.74
5.470-5.725GHz	-3.44
5.725-5.850GHz	-3.34

Antenna Cable (L = 800mm) included

How to calculate Min Antenna gain

1.

Calculate 5.25/5.35/5.47/5.725GHz Cable loss for 100mm and 800mm.

5.25GHz Cable Loss[dB]

$$= (5.25-5.15)/(5.5-5.15)*(5.5\text{loss}-5.15\text{loss})+5.15\text{loss}$$

5.35GHz Cable Loss[dB]

$$= (5.35-5.15)/(5.5-5.15)*(5.5\text{loss}-5.15\text{loss})+5.15\text{loss}$$

5.47GHz Cable Loss[dB]

$$= (5.47-5.15)/(5.5-5.15)*(5.5\text{loss}-5.15\text{loss})+5.15\text{loss}$$

ex)5.47GHz 100mm Cable Loss[dB]

$$= (5.47-5.15)/(5.5-5.15)*(0.8-0.79)+0.79 = \mathbf{0.80[dB]}$$

5.725GHz Cable Loss[dB]

$$= (5.725-5.15)/(5.85-5.15)*(5.85\text{loss}-5.15\text{loss})+5.15\text{loss}$$

	100mm	800mm
	loss	loss
[GHz]	[dB]	[dB]
5.15	0.79	4.03
5.25	0.79	4.06
5.35	0.80	4.10
5.47	0.80	4.14
5.5	0.8	4.15
5.725	0.81	4.26
5.85	0.82	4.31

2.

Due to make the worst case for DFS master test, for each band,

Select min value for 100mm loss.

Select max value for 800mm loss.

800mm Min Gain(dBi) = 100m Min Gain + 100mm loss – 800mm loss

ex)5.47-5.725GHz

$$800\text{mm Min Gain(dBi)} = \mathbf{-0.02} + \mathbf{0.8} - \mathbf{4.26} = \mathbf{-3.44 dBi}$$

	100mm	100mm loss		800mm loss		800mm
[GHz]	min gain	using item	[dB]	using item	[dB]	min gain
2.4	-1.97	2.4loss	0.51	2.4loss	2.69	-4.15
2.45	-1.07	2.45loss	0.51	2.45loss	2.72	-3.28
2.5	-0.97	2.5loss	0.52	2.5loss	2.74	-3.19
5.15-5.25	0.83	5.15 loss	0.79	5.25 loss	4.06	-2.44
5.25-5.35	0.57	5.25 loss	0.79	5.35 loss	4.1	-2.74
5.47-5.725	0.02	5.47 loss	0.8	5.725 loss	4.26	-3.44
5.725-5.85	0.16	5.725 loss	0.81	5.85 loss	4.31	-3.34

4. X-Y plane radiation pattern

Freq. (GHz)	Peak Gain (dBi)
2.40	-1.11
2.45	-0.16
2.50	0.12
5.15	0.89
5.25	0.84
5.35	0.57

Antenna Cable (L = 100mm) included

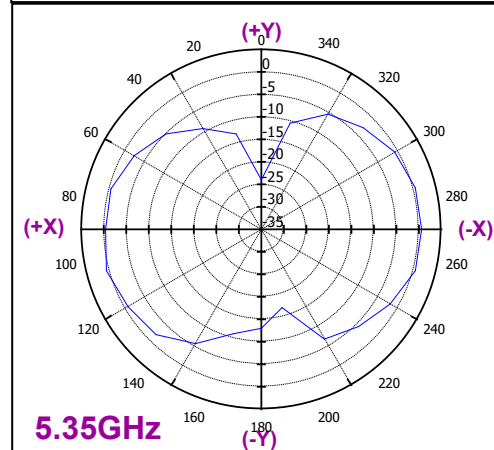
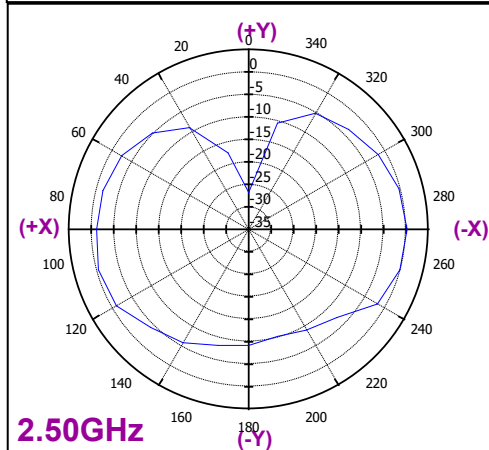
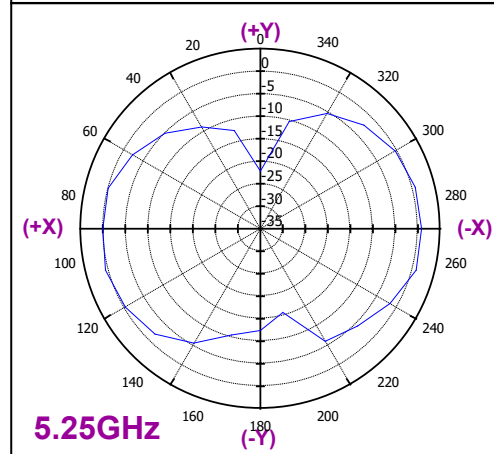
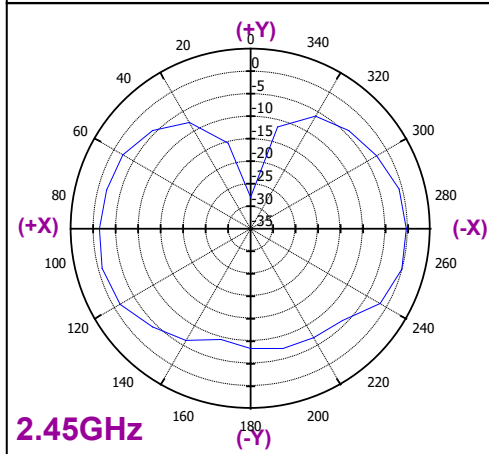
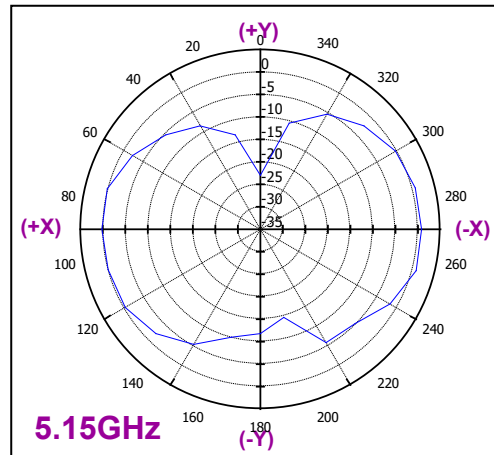
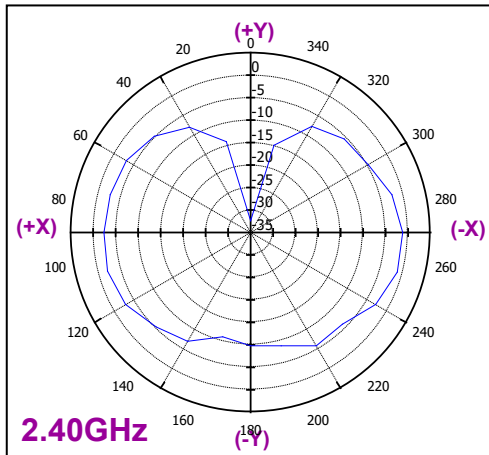

4. X-Y plane radiation pattern

Freq. (GHz)	Peak Gain (dBi)
5.45	0.32
5.55	0.02
5.65	0.10
5.75	0.16
5.85	0.33

Antenna Cable (L = 100mm) included

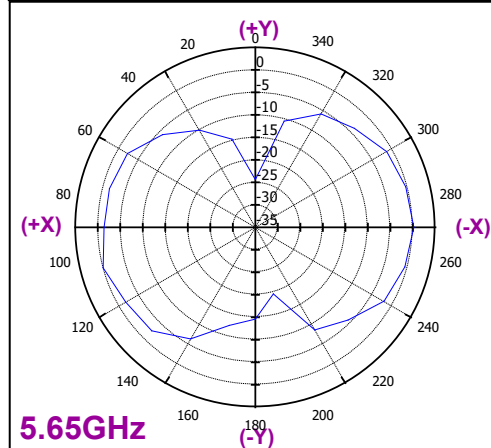
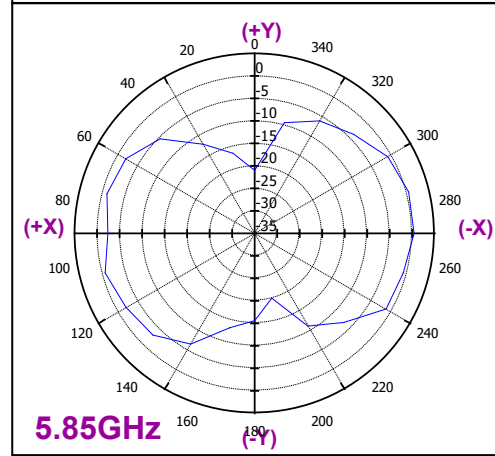
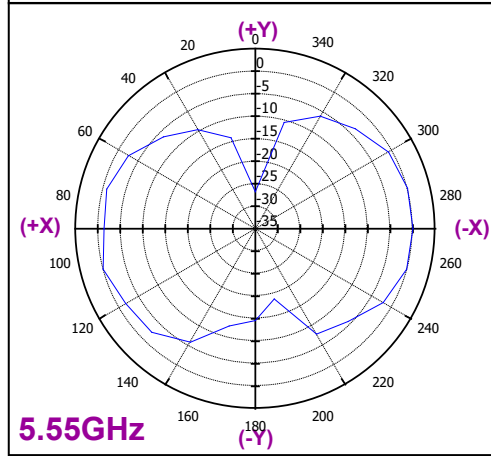
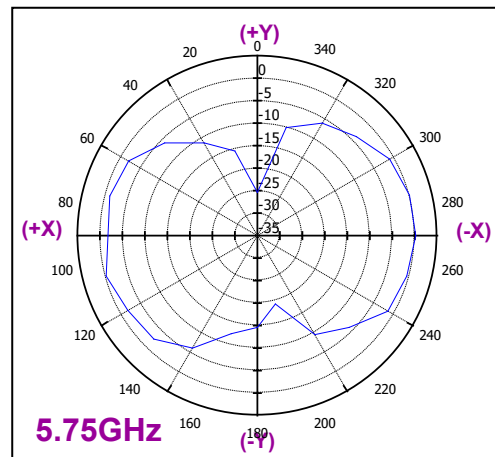
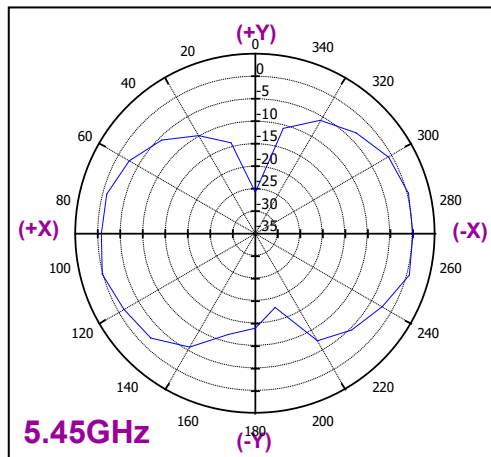

4. Y-Z plane radiation pattern

Freq. (GHz)	Peak Gain (dBi)
2.40	-1.97
2.45	-1.07
2.50	-0.97
5.15	1.12
5.25	1.36
5.35	1.17

Antenna Cable (L = 100mm) included

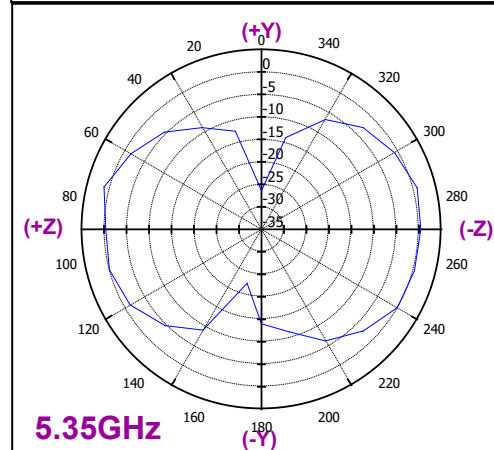
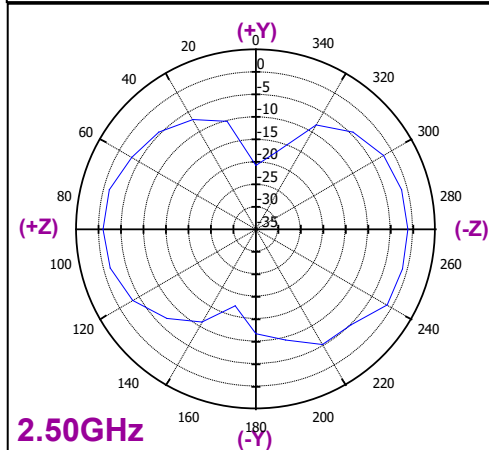
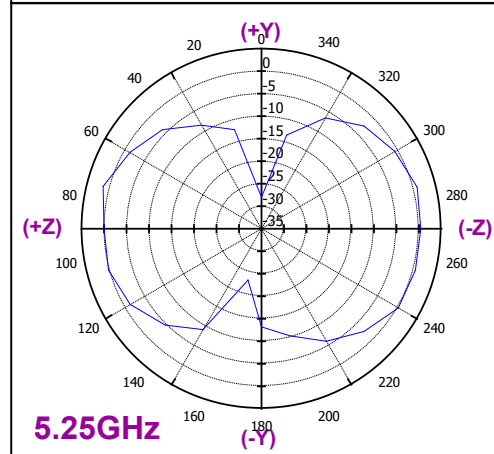
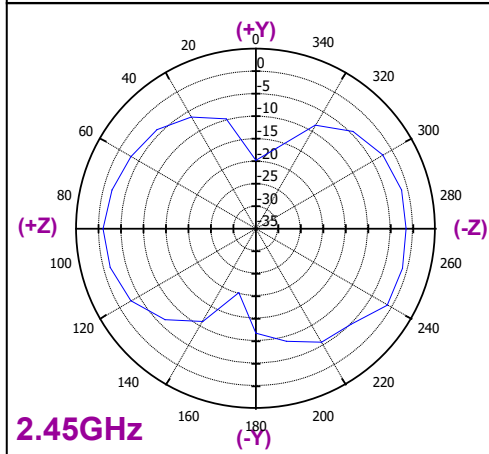
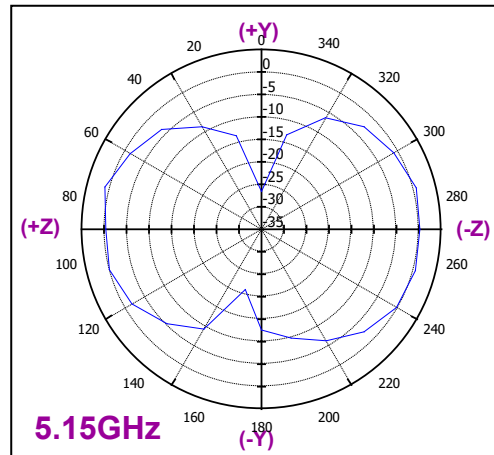
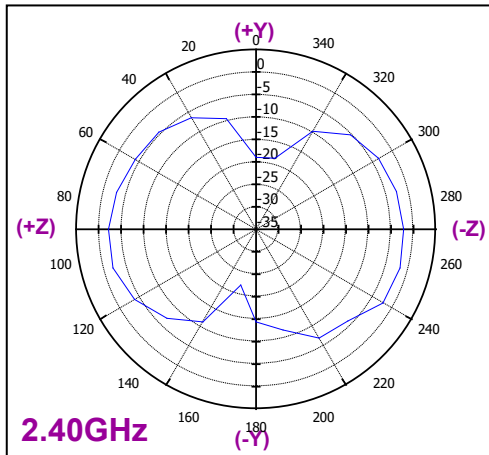

4. Y-Z plane radiation pattern

Freq. (GHz)	Peak Gain (dBi)
5.45	0.98
5.55	0.93
5.65	0.54
5.75	0.75
5.85	0.42

Antenna Cable (L = 100mm) included

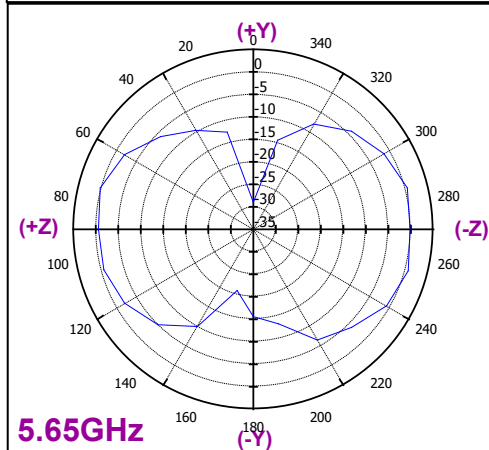
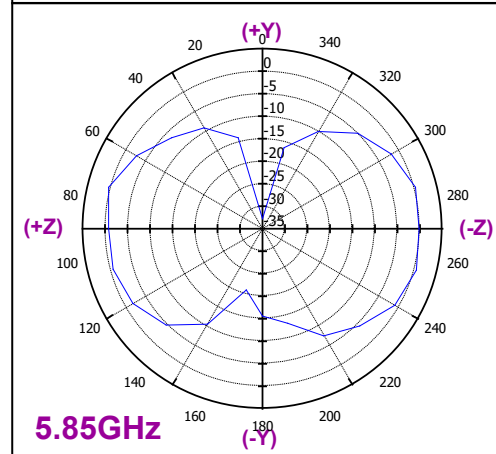
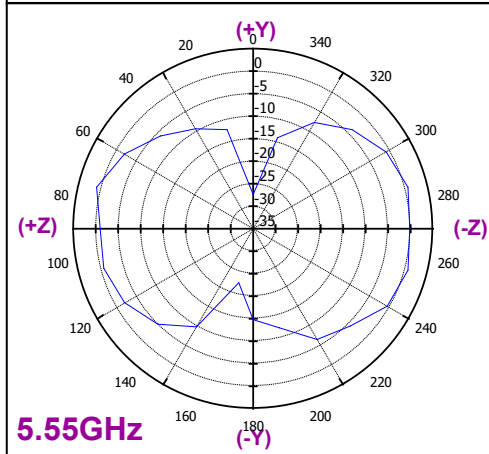
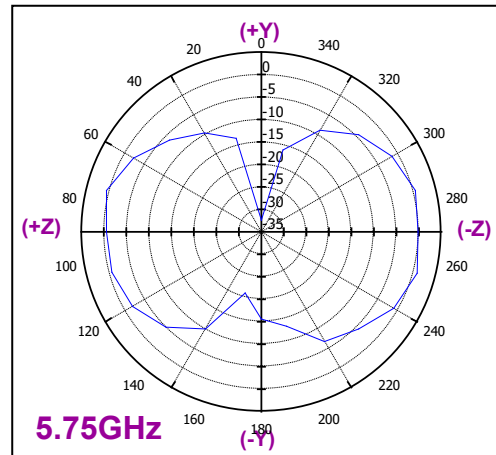
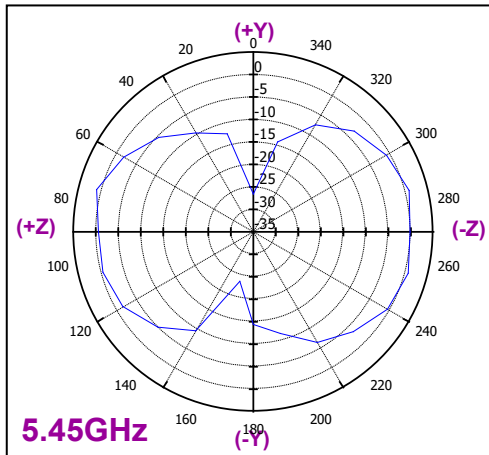

4. Z-X plane radiation pattern

Freq. (GHz)	Peak Gain (dBi)
2.40	-1.11
2.45	-0.15
2.50	0.29
5.15	0.89
5.25	0.83
5.35	0.68

Antenna Cable (L = 100mm) included

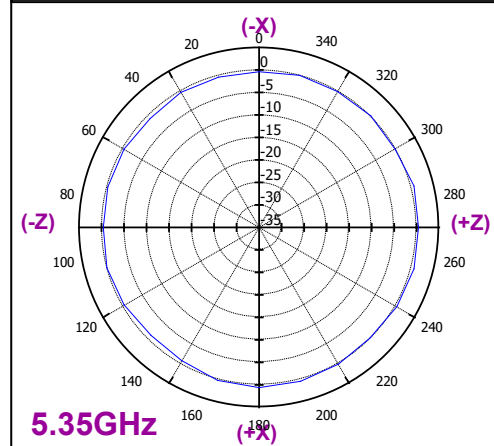
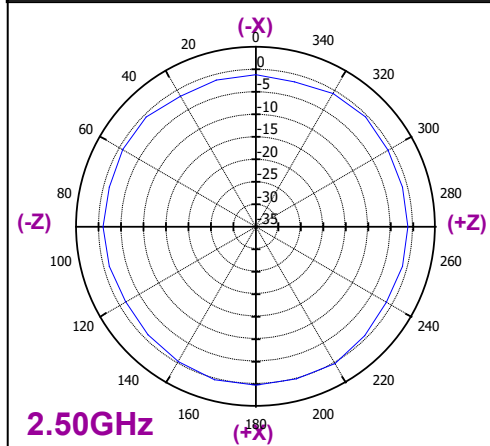
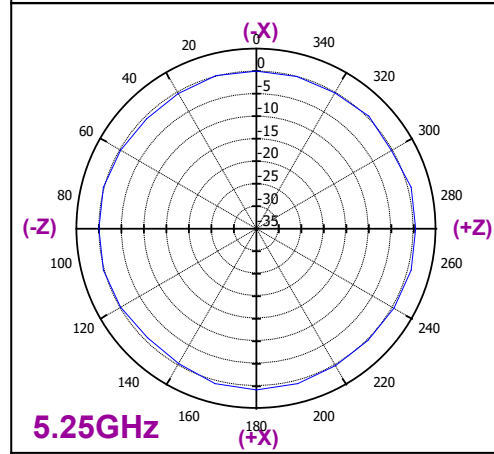
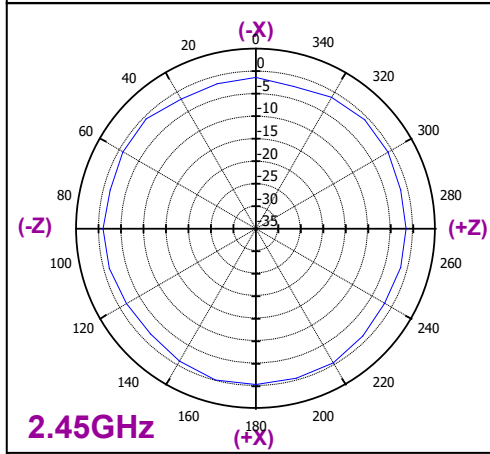
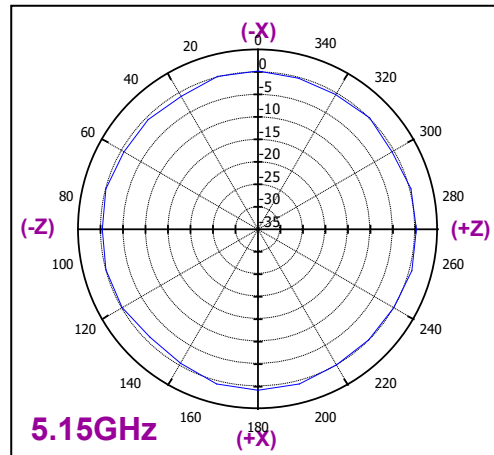
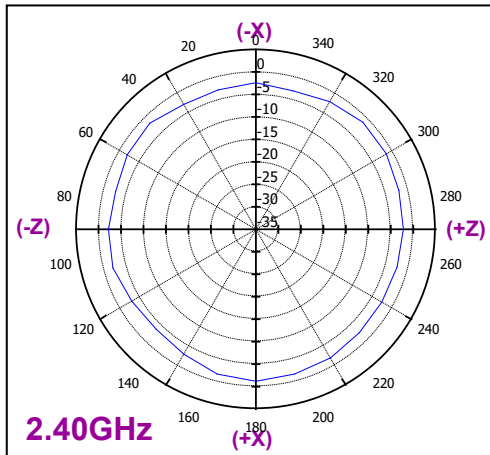

4. Z-X plane radiation pattern

Freq. (GHz)	Peak Gain (dBi)
5.45	0.10
5.55	0.02
5.65	0.13
5.75	0.27
5.85	0.56

Antenna Cable (L = 100mm) included

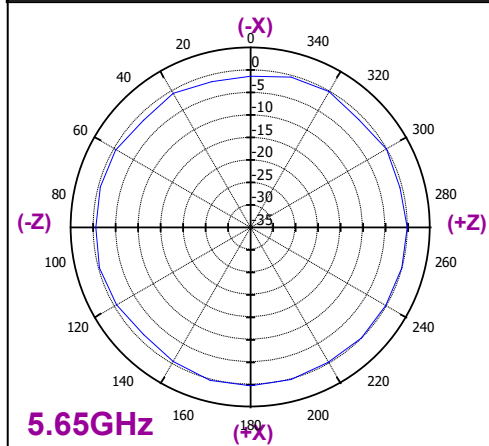
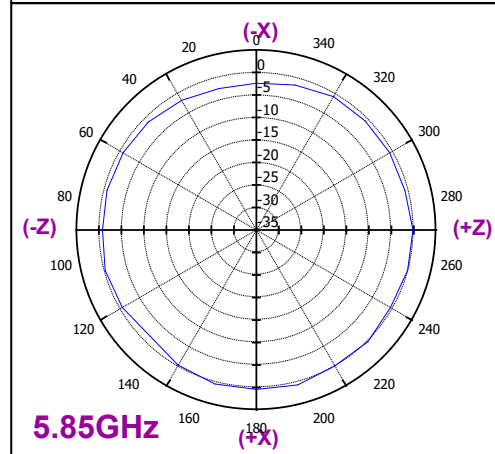
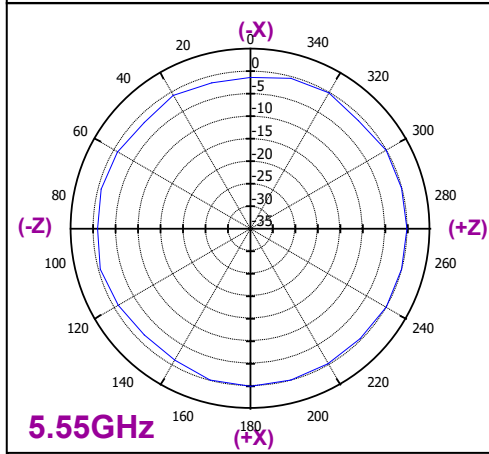
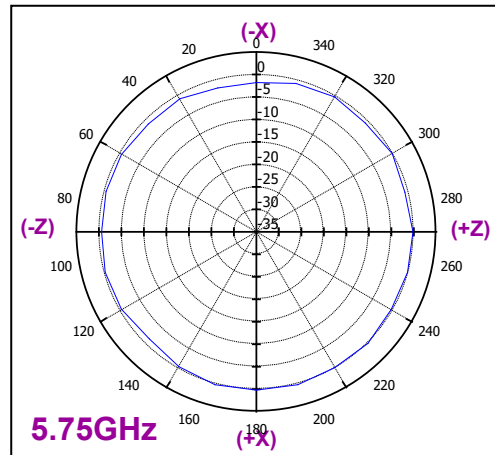
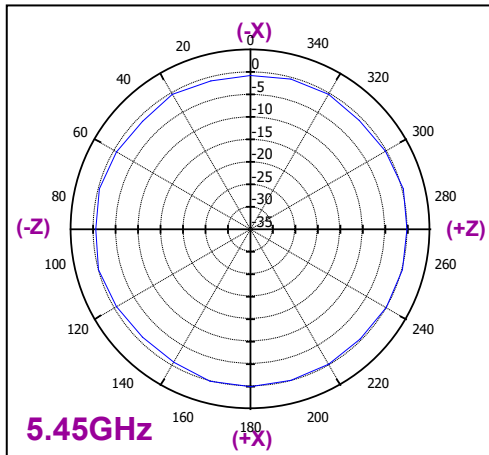

5. Appendix

Sony
IW611-IW620-G ANT Data-
13/13 2023/04/28

Test Equipment

Type of Equipment	Model	Manufacturer	Calibration Date
Measurement Software	EMQuest 1.15 Build 27347	ETS-Lindgren	N/A
Vector Network Analyzer	5071C	Keysight	08/11/2022
Receive Antenna Quad-Ridged Horn Antenna	EMCO 3165-04	ETS-Lindgren	N/A
Multi Axis Positioning System	ETS-Lindgren	ETS-Lindgren	N/A
MIPS™ Controller	EMControl	ETS-Lindgren	N/A

Measurement Condition

Frequency Range	Frequency Step
2300MHz-2600MHz	10MHz
5000MHz-6000MHz	10MHz

Measurement Date	2023/01/10
Operator	Yamada Norihide