

RADIO TEST REPORT

(for Bluetooth Low Energy)

Project No. : JB-Z1165-A
Client's Control No. : None
Client : Sony Corporation
Client's Address : 1-7-1 Konan Minato-ku Tokyo, 108-0075 Japan
Product Name : Radio Equipment
Model No. : WW07509 (WW46442)
FCC ID : AK8WW46442
Test Standard : 47 CFR Part 15 Subpart C
Sample Receipt Date : May 8, 2023
Test Date : May 8, 2023 to May 30, 2023
Report Date : August 4, 2023
Test Result : Complied

Notice:

- * These test results relate only to the items (combination equipment, test configuration, operation condition etc.) tested.
- * This report shall not be reproduced except in full, without written approval of the laboratory.
- * This report must not be used by the client to claim product endorsement by A2LA or any agency of the U.S.
- * Hereby certify that no party is subject to a denial of federal benefits pursuant to section 5301 of the Anti-Drug Abuse Act.
- * All test results are traceable to the national and /or international standards.
- * The testing in which "Non-accreditation" is displayed is outside the accreditation scopes in Sony Global Manufacturing & Operations Corporation EMC/RF Test Laboratory.
- * This report replaces and supersedes all previous versions. Refer to Revision History on the following page.

Reported by:

K. OHYAMA

Koji Ohyama
Technical Manager
EMC/RF Test Laboratory, Main Lab.
Design Technology Division

Approved Signatory:

Koji Hayama

Koji Hayama
Technical Manager
EMC/RF Test Laboratory, Main Lab.
Design Technology Division



TESTING CERT#3203.01

Format No.:NV1-1-01 Version 5.0

TABLE OF CONTENTS

1. General Information	3
1.1. Description of Equipment Under Test (EUT).....	3
1.2. Summary of Test Result.....	4
1.3. Tested Methodology	4
1.4. Measurement Procedures	5
1.5. Test Location.....	7
1.6. Uncertainty	7
2. Test Specification.....	8
2.1. Validation	8
2.2. Operating Condition.....	8
2.3. Special Accessories	8
2.4. EUT Modifications	8
2.5. Configuration of EUT System.....	9
2.6. Typical setup arrangement.....	10
3. Test Data.....	11
3.1. 6dB Bandwidth.....	11
3.2. Maximum Peak Conducted Output Power.....	12
3.3. Power Spectral Density	13
3.4. Radiated Spurious Emissions.....	14
3.5. Conducted Spurious Emissions for Band Edge.....	20
4. Method of Calculation.....	21
4.1. Maximum Peak Conducted Output Power.....	21
4.2. Power Spectral Density	21
4.3. Radiated Spurious Emissions.....	22
4.4. Conducted Spurious Emissions for Band Edge.....	22
5. List of Test Equipment	23
5.1. Antenna-port Conducted Measurements.....	23
5.2. Radiated Spurious Emissions.....	23
6. Photographs of test setup	24
6.1. Antenna-port Conducted Measurements Photo(s)	24
6.2. Radiated Spurious Emissions Photo(s).....	25

Note

- indicates that the listed condition, standard or equipment is applicable for this report.
- indicates that the listed condition, standard or equipment is not applicable for this report.

Revision History

Revision	Date	Overview	Page
JB-Z1165 (Original)	June 16, 2023	-	-
JB-Z1165-A	August 4, 2023	Correction of test date.	P1

Disclaimer

This report includes the information provided by the customer as below;

- Cover page : Client and product related information
- Clause 1.1 : Description of Equipment Under Test (EUT)
- Clause 2 : Operating mode / conditions

* The laboratory is not responsible for any test results affected by the above information.

1. General Information

1.1. Description of Equipment Under Test (EUT)

General Specification

Test Sample Condition : Prototype Pre-production Mass-production
 Product Name : Radio Equipment
 Trade Name : SONY
 Model No. : WW07509 (WW46442)
 Serial No. : 006, 008
 Power Rating of the EUT : DC 3.7 V (The EUT is supplied with the power from the battery)

Similar model(s) to be covered by this report

Model No. : WW84772 (WW91391)
 The only difference between the models is the Model No. for marketing purpose.

Radio Specification

Function of the Equipment : Transceiver
 Operating Frequency : 2402 MHz - 2480 MHz (1 Mbps)
 2404 MHz - 2478 MHz (2 Mbps)
 Modulation Type : GFSK
 Channel Spacing : 2 MHz
 Channel Bandwidth : 1 MHz / 2 MHz
 Number of channels : 40
 Antenna Type : Monopole Antenna
 Antenna Connector Type : None
 Antenna Gain : 0.49 dBi
 Operating Temperature : +0.0 to +40.0 deg.C

1.2. Summary of Test Result

Test Item	Test Method	Worst Margin	Results	Note
AC Power-line Conducted Emissions	-	-	N/A	*2
6dB Bandwidth	Conducted	Refer to the test data	Complied	-
Maximum Peak Conducted Output Power	Conducted	21.75 dB	Complied	-
Power Spectral Density	Conducted	16.96 dB	Complied	-
Radiated Spurious Emissions	Radiated	12.5 dB (AV) 2483.50 MHz Horizontal	Complied	-
Conducted Spurious Emissions for Band Edge	Conducted	40.33 dB 2399.97 MHz	Complied	*1

Note

*1: Conducted Spurious Emissions measurement was tested for the only frequencies in the non-restricted carrier band edges, since the spurious emissions in other non-restricted band were complied with Radiated Spurious Emissions measurement.

*2: This item was not applied to the EUT since its transmission is stopped when the battery is being charged by the PC connected to AC Power-line.

Other requirements

Part 15.31(e) Supply voltage requirement

: Complied (The EUT was tested with a new battery.)

Part 15.203 / 212 Antenna requirement

: Complied (The EUT has an internal antenna which cannot be replaced by users.)

1.3. Tested Methodology

Test Standard

: 47 CFR Part15 Subpart C

Test Method

: ANSI C63.10 - 2013

KDB 558074 D01 15.247 Meas Guidance v05r02

Test Condition

Radiated Spurious Emissions

Test Distance

: 3 m 10m (9 kHz to 30 MHz)

3 m 10m (30 MHz to 1000 MHz)

3 m (1 GHz to 26.5 GHz)

Dimensions of the EUT table

: 0.8 m (below 1 GHz) or 1.5 m (above 1 GHz) height, 1.5 m width and 1 m depth.

Dimensions of validated test volume

: 2.5 m diameter, 3.5 m top height, 0 m bottom height.

1.4. Measurement Procedures

We performed the measurements in accordance with NV3-06, available upon the request.

- No deviation
 Deviation from the above procedure

The summary of the above procedure is mentioned below

Antenna-port Conducted Measurements

1. Antenna-port of the EUT was connected to the power sensor (Maximum Peak Conducted Output Power) or the spectrum analyzer (other test items).
2. For each EUT operation mode, the Antenna-port Conducted Measurements were measured with the power sensor or the spectrum analyzer.

Test Item	Detector	RBW
Antenna-port Conducted Measurements		
6dB Bandwidth	Peak	100 kHz
Maximum Peak Conducted Output Power	Peak	-
Power Spectral Density	Peak	3 kHz
Conducted Spurious Emissions for Band Edge	Peak	100 kHz

Radiated Spurious Emissions

- The non-conductive table (EUT table) made of (FRP, Styrene Foam, other non-conductive material) was placed in the center of the turntable.
- The EUT was placed on the center of the tabletop.
- The test antenna was placed away from the EUT at test distance.
- The limits were compensated the distance factor with follows:
 $9 \text{ kHz to } 490 \text{ kHz [Limit at 3 m]} = [\text{Limit at } 300 \text{ m}] + 40\log(300[\text{m}] / 3[\text{m}])$
 $490 \text{ kHz to } 30 \text{ MHz [Limit at 3 m]} = [\text{Limit at } 30 \text{ m}] + 40\log(30[\text{m}] / 3[\text{m}])$
- Find the worst arrangement of the EUT according to follows:
 - Rotating the turntable and/ or scanning the antenna.
 - On every condition, exploring the highest emissions with the spectrum analyzer.
(9 kHz to 26.5 GHz, peak detector)
- On the worst arrangement of the EUT found in above, choose the six highest harmonics or spurious emissions on the spectrum data.(*excluding carrier band edges)
 The final measurements of all test operating modes carried out on these emissions as follows:

The test antenna and the turntable were performed with follows:

	9 kHz to 30 MHz	30 MHz to 1000 MHz	1 GHz to 26.5 GHz
Antenna	Loop Antenna	Bi-conical Antenna, Log-periodic Antenna	Horn Antenna
Antenna scanning range	1 m, Vertical, 360 degrees	1 m to 4 m, Horizontal and Vertical	1 m to 4 m *, Horizontal and Vertical
Turntable rotating range	360 degrees	360 degrees	360 degrees

*: When the measurement frequencies above 1 GHz, final measurements are performed keeping the antenna in the "cone of radiation" from EUT area and pointed at the area both in azimuth and elevation, with polarization oriented for maximum response.

Instruments settings were carried out with follows:

	9 kHz to 90 kHz 110 kHz to 490 kHz	90 kHz to 110 kHz 490 kHz to 30 MHz	30 MHz to 1000 MHz	1 GHz to 26.5 GHz
Detector	Peak / Average	Quasi-peak	Quasi-peak	Peak / Average
RBW	200 Hz (6 dB) or 9 kHz (6 dB) *1	200 Hz (6 dB) or 9 kHz (6 dB) *1	120 kHz (6 dB)	1 MHz (6 dB)
VBW	N/A	N/A	N/A	3 MHz (for peak) 10 kHz (for average) *2
Instrument	EMI test receiver	EMI test receiver	EMI test receiver	Spectrum analyzer

*1: When the measurement frequencies below 150 kHz, RBW: 200 Hz was used.

*2: VBW setting (for average) was higher than 1/T, and up to 10 kHz. (T is the minimum transmission duration)

- If the final measurement result exceeded the limit in non-restricted band (excluding carrier band edges), the measurement is carried out additionally with follows:

Measurement points

- Fundamental Frequency
- Frequency that exceeded the limit in non-restricted band (excluding carrier band edges)

	9 kHz to 150 kHz	150 kHz to 30 MHz	30 MHz to 26.5 GHz
Detector	Peak	Peak	Peak
RBW	300 Hz (6 dB) *	10 kHz (6 dB) *	100 kHz (6 dB)
Instrument	Spectrum analyzer	Spectrum analyzer	Spectrum analyzer

*: Correction factor of RBW was compensated to a measurement result by the following formula.

$$\text{C.F. of RBW [dB]} = 10 * \log(100 \text{ kHz} / \text{used RBW})$$

8. If the final average measurement result exceeded the limit in the authorized band edge, the integration method is carried out with follows;

	2.4835 GHz to 2.4855 GHz
Detector	Peak
RBW	100 kHz (6 dB)
Instrument	Spectrum analyzer
Function	Channel Power (integration BW : 1 MHz)

9. Although these tests for below 30MHz were performed other than open field area test site, adequate comparison measurements were confirmed against 30 m open field area test site. Therefore sufficient tests were made to demonstrate that the alternative site produces results that correlate with the ones of tests made in an open field based on KDB 414788 D01.
Further these test for above 1GHz were performed test site complied with CISPR 16-1-4.
In the case of EUT size smaller than the validated test volume, the antenna position is adjusted such that the distance between the EUT and the antenna reference point is identical to the 3m used for the S-VSWR validation measurements. These method based on clause 7.3.1 of CISPR16-1-4 Edition 4, therefore correcting distance factor is not applied.

1.5. Test Location

Test Facility Name : Sony Global Manufacturing & Operations Corporation
EMC/RF Test Laboratory, Main Lab.
Address : 8-4 Shiomi Kisarazu-shi Chiba-ken, 292-0834, Japan
Phone : +81 438 37 2750

A2LA Certificate No. : 3203.01
Expiration : October 31, 2023

Antenna-port Conducted Measurements

Shielded Room

4th Site SR1

Radiated Spurious Emissions

Semi-Anechoic chamber

4th Site EMC Site

1.6. Uncertainty

Test Item	Frequency	4th Site SR1
Maximum Conducted Output Power	1 GHz to 6 GHz	± 0.84 dB
Power Spectral Density Conducted Spurious Emissions	below 6 GHz	± 1.02 dB

Test Item	Frequency	Distance	4th Site	EMC Site
AC Power-line Conducted Emissions	150 kHz to 30 MHz	-	± 3.37 dB	± 3.39 dB
Radiated Emissions	9 kHz to 30 MHz	3m	± 3.91 dB	± 3.13 dB
	30 MHz to 1000 MHz	3m	± 4.96 dB	± 5.27 dB
	1 GHz to 18 GHz	3m	± 5.79 dB	± 5.71 dB
	18 GHz to 26.5 GHz	3m	± 4.68 dB	± 4.98 dB

2. Test Specification

2.1. Validation

The system was configured for testing in a typical (as a customer would normally use it).
The tests were conducted with the worst-case modes as follows.

2.2. Operating Condition

The tests have been carried out the following conditions.

[Transmitting mode]

Test Items	Test Channels	Data Rate
Radiated Spurious Emissions (below 1GHz) *1	2402 MHz	1 Mbps
6dB Bandwidth, Maximum Peak Conducted Output Power, Power Spectral Density, Radiated Spurious Emissions (above 1GHz)	2402 MHz	1 Mbps
	2440 MHz	
	2480 MHz	2 Mbps
Conducted Spurious Emissions for Band Edge	2404 MHz	
	2440 MHz	
	2478 MHz	
Conducted Spurious Emissions for Band Edge	2402 MHz	1 Mbps
	2404 MHz	2 Mbps

Note

*1: The test was performed with the representative mode that had been found as the worst emissions while exploratory testing.

The Software for Operating Mode

Software Name : AB1565_AB1568_Airoha_Tool_Kit(ATK)
Software Version : v3.4.2

2.3. Special Accessories

Special accessories needed for connecting the EUT to achieve compliance:

Item	Manufacturer	Model No.	Serial No.	Remark
-	-	-	-	-

2.4. EUT Modifications

- No equipment modification to achieve compliance to the standard levels was done during the tests.
 Equipment was modified to achieve compliance to the standard level as below.

Responsible Party Signature

Typed/ Print Name :
Responsible Party :
Position :
Date :

2.5. Configuration of EUT System

Antenna-port Conducted Measurements

[EUT and Associated Equipment (AE)]

Symbol	EUT/ AE	Item	Manufacturer	Model No.	Serial No.
A	EUT	Radio Equipment	SONY	WW07509 (WW46442)	006

[Type of Cable]

Symbol	Description	Identification (Manufacturer etc.)	Shielded Yes / No	Ferrite Core	Length (m)	Bundled
-	-	-	-	-	-	-

[Connecting Diagram]

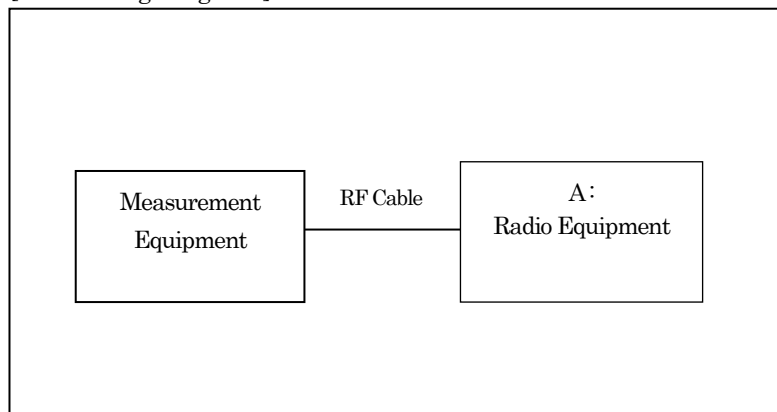

Radiated Spurious Emissions

[EUT and Associated Equipment (AE)]

Symbol	EUT/ AE	Item	Manufacturer	Model No.	Serial No.
A	EUT	Radio Equipment	SONY	WW07509 (WW46442)	008

[Type of Cable]

Symbol	Description	Identification (Manufacturer etc.)	Shielded Yes / No	Ferrite Core	Length (m)	Bundled
-	-	-	-	-	-	-

[Connecting Diagram]

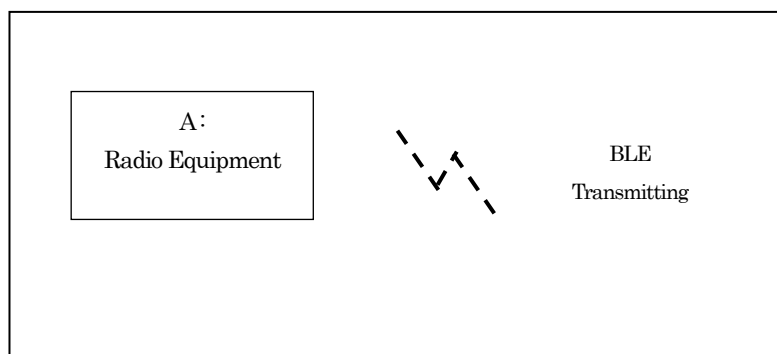

2.6. Typical setup arrangement

Radiated spurious emissions

< 9 kHz - 30 MHz >

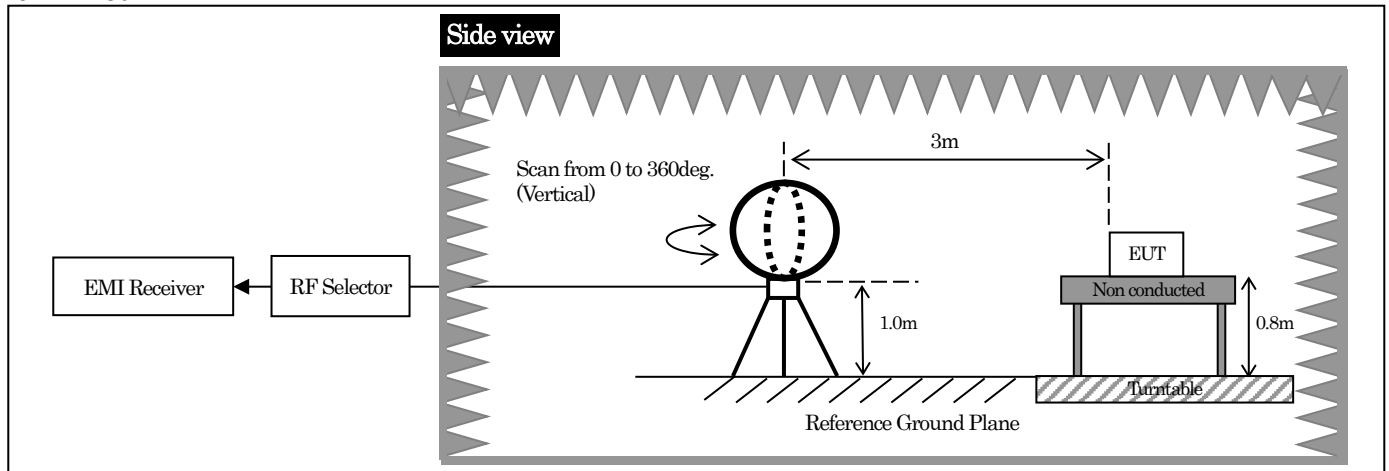

< 30 MHz - 1000 MHz >

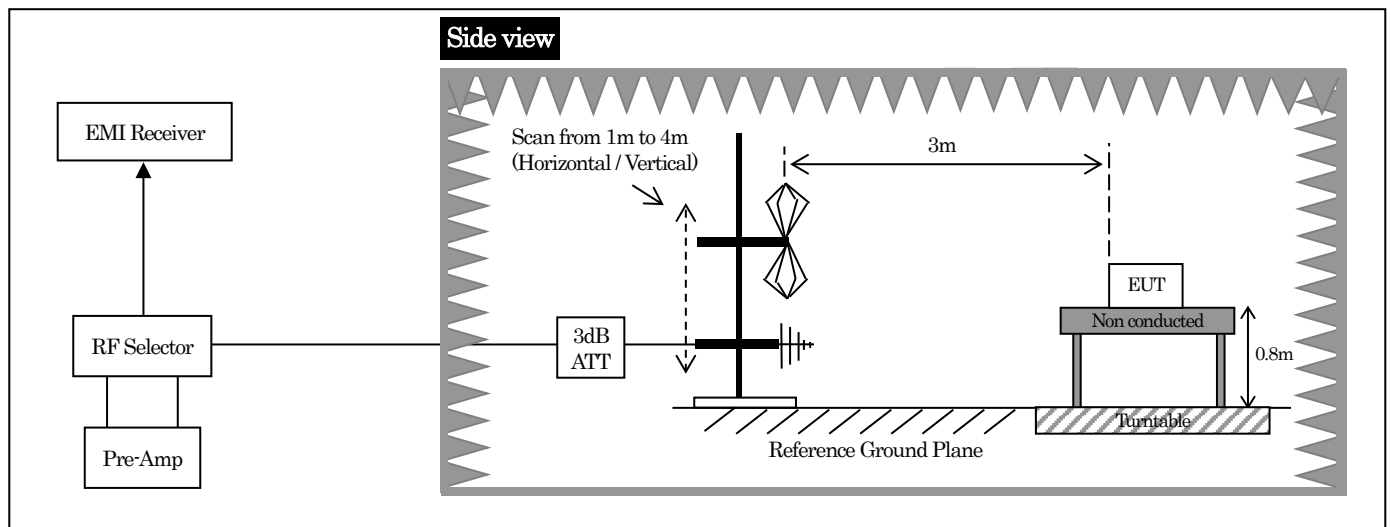

< 1 GHz - 26.5 GHz >

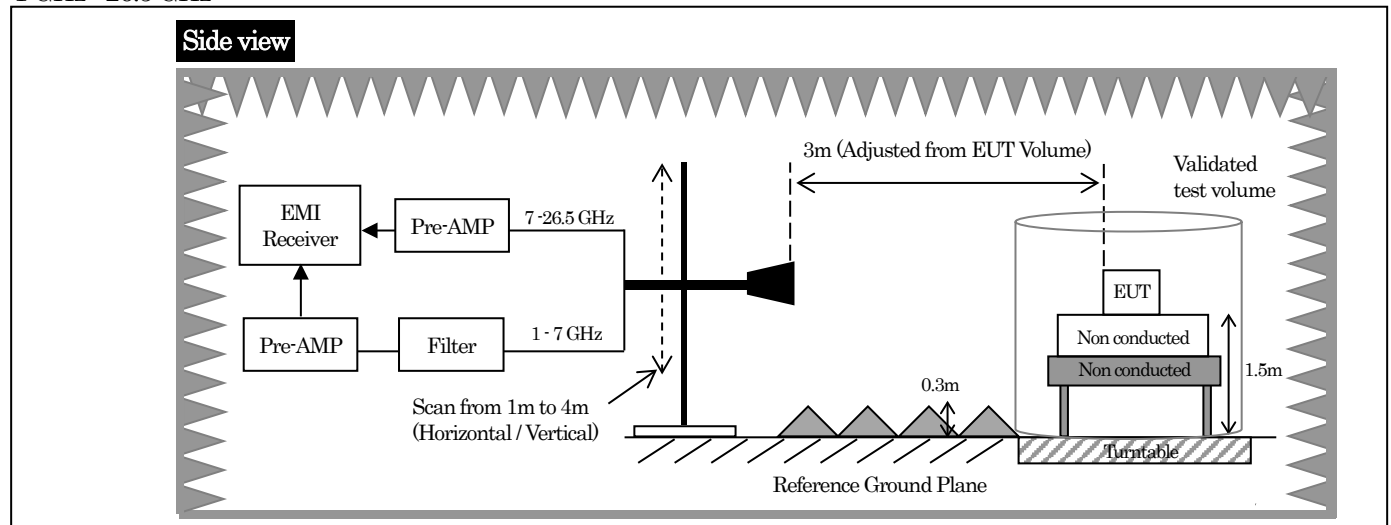

3. Test Data

3.1. 6dB Bandwidth

Date of measurement	Ambient temperature	Relative humidity	Measured by
May 10, 2023	22.2 deg.C	54.6 %	Mikiko Kouga

Mode	Rate [Mbps]	Channel [MHz]	Result [MHz]	Limit [MHz]
BLE	1	2402	0.668	≥ 0.5
		2440	0.664	≥ 0.5
		2480	0.663	≥ 0.5
	2	2404	1.251	≥ 0.5
		2440	1.250	≥ 0.5
		2478	1.253	≥ 0.5

[1 Mbps / 2402 MHz]

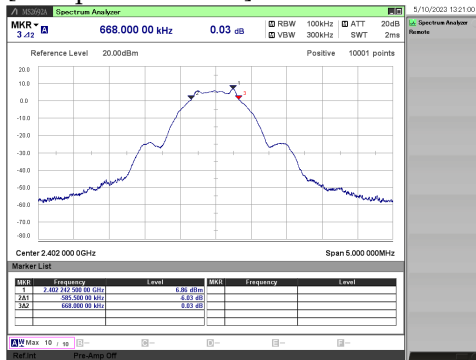

[1 Mbps / 2440 MHz]

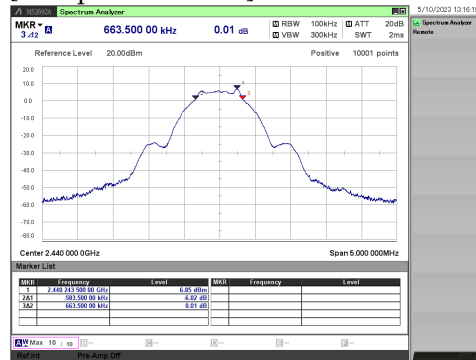

[1 Mbps / 2480 MHz]

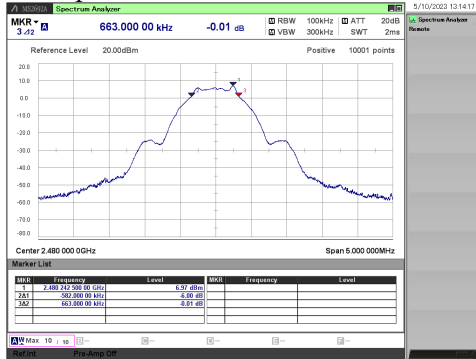

[2 Mbps / 2404 MHz]



[2 Mbps / 2440 MHz]



[2 Mbps / 2478 MHz]



3.2. Maximum Peak Conducted Output Power

Date of measurement	Ambient temperature	Relative humidity	Measured by
May 8, 2023	22.1 deg.C	62.8 %	Mikiko Kouga

Maximum Peak Conducted Output Power

Mode	Rate [Mbps]	Channel [MHz]	Reading(PK) [dBm]	C.F. [dB]	Result(PK) [dBm]	Result(PK) [W]	Limit [dBm]	Limit [W]	Margin [dB]
BLE	1	2402	7.50	0.75	8.25	0.00668	≤ 30.0	≤ 1.0	21.75
		2440	7.36	0.75	8.11	0.00647	≤ 30.0	≤ 1.0	21.89
		2480	7.38	0.75	8.13	0.00650	≤ 30.0	≤ 1.0	21.87
	2	2404	7.46	0.75	8.21	0.00662	≤ 30.0	≤ 1.0	21.79
		2440	7.38	0.75	8.13	0.00650	≤ 30.0	≤ 1.0	21.87
		2478	7.38	0.75	8.13	0.00650	≤ 30.0	≤ 1.0	21.87

3.3. Power Spectral Density

Date of measurement	Ambient temperature	Relative humidity	Measured by
May 10, 2023	22.2 deg.C	54.6 %	Mikiko Kouga

Mode	Rate [Mbps]	Channel [MHz]	Reading(PK) [dBm]	C.F. [dB]	Result(PK) [dBm]	Limit [dBm]	Margin [dB]
BLE	1	2402	-10.09	1.12	-8.97	≤ 8.0	16.97
		2440	-10.18	1.12	-9.06	≤ 8.0	17.06
		2480	-10.08	1.12	-8.96	≤ 8.0	16.96
	2	2404	-12.80	1.12	-11.68	≤ 8.0	19.68
		2440	-12.92	1.12	-11.80	≤ 8.0	19.80
		2478	-12.75	1.12	-11.63	≤ 8.0	19.63

[1 Mbps / 2402 MHz]

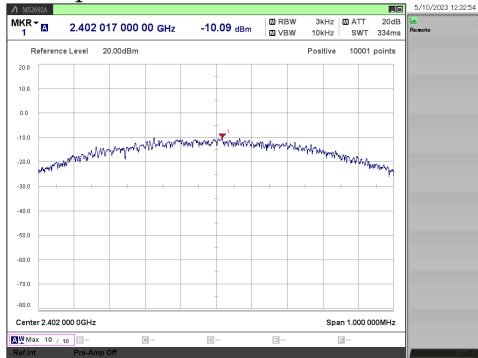

[1 Mbps / 2440 MHz]

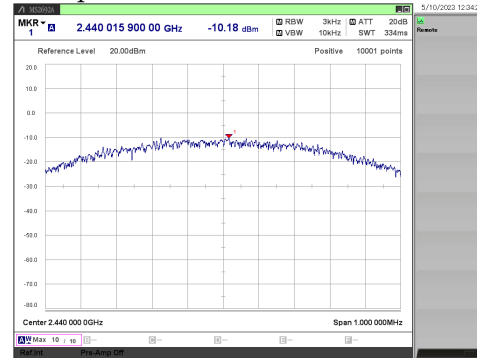

[1 Mbps / 2480 MHz]

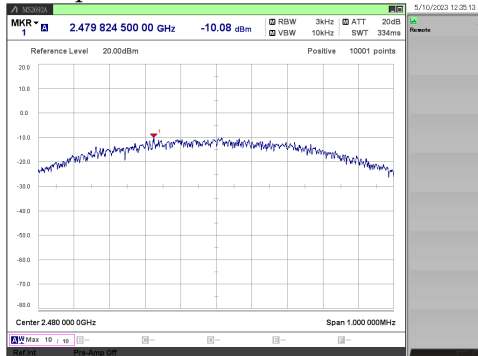

[2 Mbps / 2404 MHz]

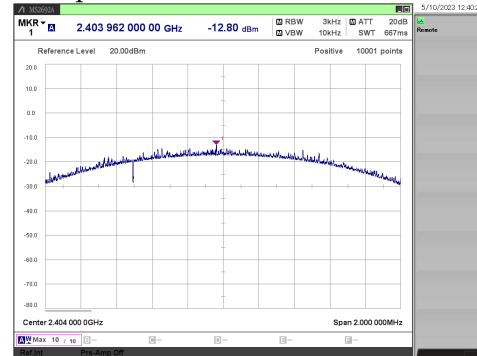

[2 Mbps / 2440 MHz]

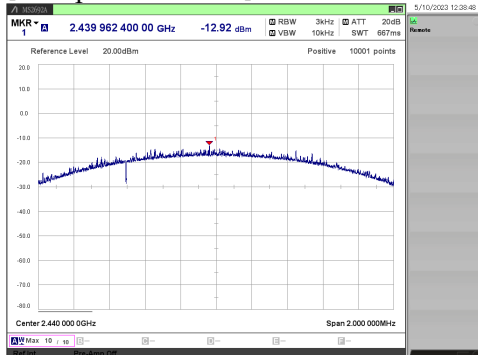

[2 Mbps / 2478 MHz]

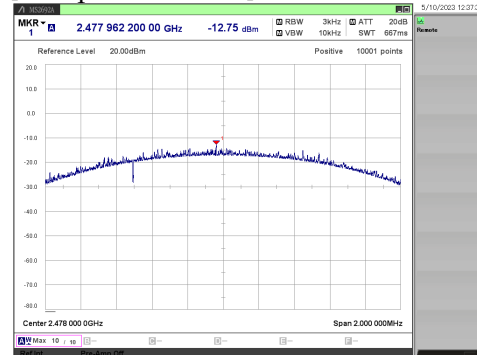

3.4. Radiated Spurious Emissions

Measurement band	Date of measurement	Ambient temperature	Relative humidity	Measured by
9 kHz to 1000 MHz	May 30, 2023	21.0 deg.C	72.0 %	Mikiko Kouga
1 GHz to 7 GHz	May 9, 2023	23.0 deg.C	42.0 %	Shuma Terasawa
	May 23, 2023	21.0 deg.C	61.0 %	Mikiko Kouga
7 GHz to 18 GHz	May 24, 2023	20.0 deg.C	50.0 %	Mikiko Kouga
18 GHz to 26.5 GHz	May 25, 2023	21.0 deg.C	54.0 %	Mikiko Kouga

9 kHz to 1000 MHz
[1 Mbps / 2402 MHz]

Frequency [MHz]	Detector	Polar.	Reading [dBμV]	C.F. [dB/m]	Result [dBμV/m]	Limit [dBμV/m]	Margin [dB]	Height [cm]	Angle [degree]	EUT Position
799.204	QP	H	25.2	-3.4	21.8	≤ 46.0	24.2	240.0	242.0	Y
924.444	QP	H	24.8	-1.4	23.4	≤ 46.0	22.6	180.0	10.0	Y
1.666	QP	V	7.6	19.6	27.2	≤ 63.2	36.0	100.0	0.0	Y
810.895	QP	V	25.1	-3.1	22.0	≤ 46.0	24.0	242.1	48.0	Y
936.580	QP	V	24.8	-1.3	23.5	≤ 46.0	22.5	290.0	190.0	Y

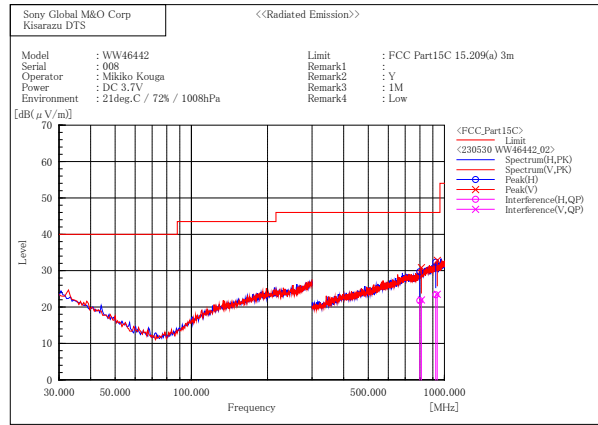
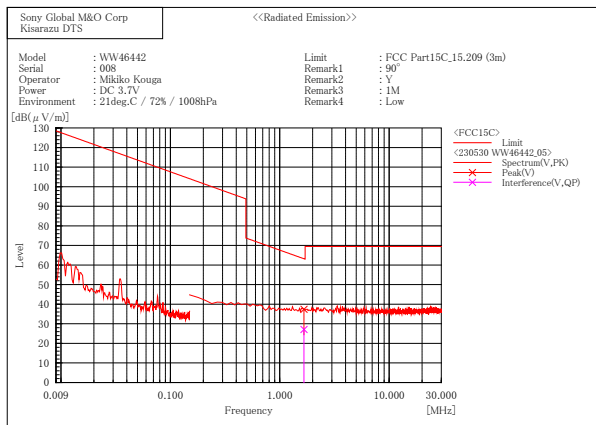

1 GHz to 26.5 GHz

* Although "Height" in radiated emissions data, which shows the height of the boom of the antenna mast, might exceed 400.0 cm. because of the antenna tilt positioner attached to the edge of the boom for the bore-sighting measurement, the height of the reference point of the antenna does not exceed 400.0 cm.

[1 Mbps / 2402 MHz]

Frequency [MHz]	Detector	Polar.	Reading [dB μ V]	C.F. [dB/m]	Result [dB μ V/m]	Limit [dB μ V/m]	Margin [dB]	Height [cm]	Angle [degree]	EUT Position	VBW [kHz]
2390.000	AV	H	44.1	-7.4	36.7	≤ 54.0	17.3	224.0	156.6	Y	10.0
2390.000	PK	H	53.5	-7.4	46.1	≤ 74.0	27.9	225.4	162.2	Y	-
4804.000	AV	H	34.2	-3.5	30.7	≤ 54.0	23.3	233.9	155.3	Y	10.0
4804.000	PK	H	43.9	-3.5	40.4	≤ 74.0	33.6	227.7	154.6	Y	-
14412.000	AV	H	39.6	-5.1	34.5	≤ 54.0	19.5	116.0	191.1	Y	10.0
14412.000	PK	H	49.9	-5.1	44.8	≤ 74.0	29.2	115.0	190.1	Y	-
21618.000	AV	H	39.9	-1.3	38.6	≤ 54.0	15.4	266.0	270.0	Y	10.0
21618.000	PK	H	50.2	-1.3	48.9	≤ 74.0	25.1	265.0	268.0	Y	-
2390.000	AV	V	43.7	-7.4	36.3	≤ 54.0	17.7	403.8	89.8	Y	10.0
2390.000	PK	V	53.2	-7.4	45.8	≤ 74.0	28.2	403.0	107.9	Y	-
4804.000	AV	V	34.5	-3.5	31.0	≤ 54.0	23.0	399.0	89.0	Y	10.0
4804.000	PK	V	44.0	-3.5	40.5	≤ 74.0	33.5	400.0	90.0	Y	-
9608.000	AV	V	37.6	-6.2	31.4	≤ 54.0	22.6	180.0	211.1	Y	10.0
9608.000	PK	V	48.0	-6.2	41.8	≤ 74.0	32.2	181.0	210.1	Y	-
19216.000	AV	V	38.8	-0.6	38.2	≤ 54.0	15.8	400.0	190.0	Y	10.0
19216.000	PK	V	48.6	-0.6	48.0	≤ 74.0	26.0	400.0	191.0	Y	-

[1 Mbps / 2440 MHz]

Frequency [MHz]	Detector	Polar.	Reading [dB μ V]	C.F. [dB/m]	Result [dB μ V/m]	Limit [dB μ V/m]	Margin [dB]	Height [cm]	Angle [degree]	EUT Position	VBW [kHz]
4880.000	AV	H	35.4	-3.5	31.9	≤ 54.0	22.1	100.0	180.2	Y	10.0
4880.000	PK	H	46.0	-3.5	42.5	≤ 74.0	31.5	100.0	181.2	Y	-
14640.000	AV	H	38.9	-5.0	33.9	≤ 54.0	20.1	299.0	9.1	Y	10.0
14640.000	PK	H	49.2	-5.0	44.2	≤ 74.0	29.8	296.0	10.1	Y	-
17080.000	AV	H	37.0	-1.9	35.1	≤ 54.0	18.9	349.0	99.1	Y	10.0
17080.000	PK	H	47.5	-1.9	45.6	≤ 74.0	28.4	350.0	96.1	Y	-
19520.000	AV	H	38.0	-0.5	37.5	≤ 54.0	16.5	275.0	81.0	Y	10.0
19520.000	PK	H	48.6	-0.5	48.1	≤ 74.0	25.9	275.0	80.0	Y	-
4880.000	AV	V	35.0	-3.5	31.5	≤ 54.0	22.5	120.0	211.2	Y	10.0
4880.000	PK	V	44.5	-3.5	41.0	≤ 74.0	33.0	121.0	212.2	Y	-
9760.000	AV	V	37.9	-5.5	32.4	≤ 54.0	21.6	400.0	260.1	Y	10.0
9760.000	PK	V	47.9	-5.5	42.4	≤ 74.0	31.6	400.0	259.1	Y	-
12200.000	AV	V	38.6	-5.4	33.2	≤ 54.0	20.8	120.0	5.1	Y	10.0
12200.000	PK	V	48.4	-5.4	43.0	≤ 74.0	31.0	122.0	6.1	Y	-
24400.000	AV	V	40.2	-2.4	37.8	≤ 54.0	16.2	100.0	242.0	Y	10.0
24400.000	PK	V	50.8	-2.4	48.4	≤ 74.0	25.6	100.0	240.0	Y	-

[1 Mbps / 2480 MHz]

Frequency [MHz]	Detector	Polar.	Reading [dB μ V]	C.F. [dB/m]	Result [dB μ V/m]	Limit [dB μ V/m]	Margin [dB]	Height [cm]	Angle [degree]	EUT Position	VBW [kHz]
2483.500	AV	H	48.5	-7.0	41.5	≤ 54.0	12.5	386.0	162.2	Y	10.0
2483.500	PK	H	58.9	-7.0	51.9	≤ 74.0	22.1	385.0	160.2	Y	-
4960.000	AV	H	34.6	-3.2	31.4	≤ 54.0	22.6	100.0	178.2	Y	10.0
4960.000	PK	H	44.6	-3.2	41.4	≤ 74.0	32.6	100.0	180.2	Y	-
14880.000	AV	H	39.1	-5.1	34.0	≤ 54.0	20.0	325.0	309.1	Y	10.0
14880.000	PK	H	49.2	-5.1	44.1	≤ 74.0	29.9	326.0	306.1	Y	-
19840.000	AV	H	38.6	-0.6	38.0	≤ 54.0	16.0	421.0	81.0	Y	10.0
19840.000	PK	H	48.1	-0.6	47.5	≤ 74.0	26.5	421.0	80.0	Y	-
2483.500	AV	V	46.9	-7.0	39.9	≤ 54.0	14.1	431.0	91.2	Y	10.0
2483.500	PK	V	57.0	-7.0	50.0	≤ 74.0	24.0	431.0	90.2	Y	-
4960.000	AV	V	34.8	-3.2	31.6	≤ 54.0	22.4	118.0	128.2	Y	10.0
4960.000	PK	V	44.8	-3.2	41.6	≤ 74.0	32.4	119.0	129.2	Y	-
9920.000	AV	V	37.6	-5.1	32.5	≤ 54.0	21.5	342.0	140.1	Y	10.0
9920.000	PK	V	48.2	-5.1	43.1	≤ 74.0	30.9	344.0	138.1	Y	-
24800.000	AV	V	40.2	-2.4	37.8	≤ 54.0	16.2	400.0	135.0	Y	10.0
24800.000	PK	V	50.8	-2.4	48.4	≤ 74.0	25.6	400.0	136.0	Y	-

[2 Mbps / 2404 MHz]

Frequency [MHz]	Detector	Polar.	Reading [dB μ V]	C.F. [dB/m]	Result [dB μ V/m]	Limit [dB μ V/m]	Margin [dB]	Height [cm]	Angle [degree]	EUT Position	VBW [kHz]
2390.000	AV	H	43.8	-7.4	36.4	≤ 54.0	17.6	418.0	180.2	Y	10.0
2390.000	PK	H	53.6	-7.4	46.2	≤ 74.0	27.8	418.0	181.2	Y	-
4808.000	AV	H	34.6	-3.5	31.1	≤ 54.0	22.9	100.0	159.2	Y	10.0
4808.000	PK	H	45.0	-3.5	41.5	≤ 74.0	32.5	100.0	160.2	Y	-
9616.000	AV	H	37.0	-6.2	30.8	≤ 54.0	23.2	100.0	169.1	Y	10.0
9616.000	PK	H	47.4	-6.2	41.2	≤ 74.0	32.8	100.0	172.1	Y	-
21636.000	AV	H	39.4	-1.3	38.1	≤ 54.0	15.9	431.0	135.0	Y	10.0
21636.000	PK	H	49.9	-1.3	48.6	≤ 74.0	25.4	431.0	136.0	Y	-
2390.000	AV	V	43.4	-7.4	36.0	≤ 54.0	18.0	411.0	98.2	Y	10.0
2390.000	PK	V	53.2	-7.4	45.8	≤ 74.0	28.2	412.0	100.2	Y	-
4808.000	AV	V	34.5	-3.5	31.0	≤ 54.0	23.0	111.0	115.2	Y	10.0
4808.000	PK	V	45.6	-3.5	42.1	≤ 74.0	31.9	110.0	116.2	Y	-
16828.000	AV	V	37.9	-2.5	35.4	≤ 54.0	18.6	194.0	22.1	Y	10.0
16828.000	PK	V	47.9	-2.5	45.4	≤ 74.0	28.6	198.0	20.1	Y	-
24040.000	AV	V	40.0	-2.4	37.6	≤ 54.0	16.4	271.0	15.0	Y	10.0
24040.000	PK	V	49.8	-2.4	47.4	≤ 74.0	26.6	270.0	16.0	Y	-

[2 Mbps / 2440 MHz]

Frequency [MHz]	Detector	Polar.	Reading [dB μ V]	C.F. [dB/m]	Result [dB μ V/m]	Limit [dB μ V/m]	Margin [dB]	Height [cm]	Angle [degree]	EUT Position	VBW [kHz]
4880.000	AV	H	35.4	-3.5	31.9	≤ 54.0	22.1	100.0	166.2	Y	10.0
4880.000	PK	H	45.1	-3.5	41.6	≤ 74.0	32.4	100.0	165.2	Y	-
12200.000	AV	H	39.0	-5.4	33.6	≤ 54.0	20.4	298.0	326.1	Y	10.0
12200.000	PK	H	48.6	-5.4	43.2	≤ 74.0	30.8	294.0	325.1	Y	-
14640.000	AV	H	38.8	-5.0	33.8	≤ 54.0	20.2	316.0	71.1	Y	10.0
14640.000	PK	H	49.0	-5.0	44.0	≤ 74.0	30.0	312.0	70.1	Y	-
21960.000	AV	H	39.4	-1.5	37.9	≤ 54.0	16.1	318.0	248.0	Y	10.0
21960.000	PK	H	49.9	-1.5	48.4	≤ 74.0	25.6	318.0	250.0	Y	-
4880.000	AV	V	34.9	-3.5	31.4	≤ 54.0	22.6	121.0	60.2	Y	10.0
4880.000	PK	V	44.9	-3.5	41.4	≤ 74.0	32.6	122.0	58.2	Y	-
9760.000	AV	V	37.6	-5.5	32.1	≤ 54.0	21.9	126.0	268.1	Y	10.0
9760.000	PK	V	47.0	-5.5	41.5	≤ 74.0	32.5	128.0	269.1	Y	-
17080.000	AV	V	37.1	-1.9	35.2	≤ 54.0	18.8	350.0	285.1	Y	10.0
17080.000	PK	V	46.5	-1.9	44.6	≤ 74.0	29.4	348.0	286.1	Y	-
19520.000	AV	V	37.9	-0.5	37.4	≤ 54.0	16.6	268.0	218.0	Y	10.0
19520.000	PK	V	48.0	-0.5	47.5	≤ 74.0	26.5	268.0	220.0	Y	-

[2 Mbps / 2478 MHz]

Frequency [MHz]	Detector	Polar.	Reading [dBμV]	C.F. [dB/m]	Result [dBμV/m]	Limit [dBμV/m]	Margin [dB]	Height [cm]	Angle [degree]	EUT Position	VBW [kHz]
2483.500	AV	H	46.0	-7.0	39.0	≤ 54.0	15.0	389.0	166.2	Y	10.0
2483.500	PK	H	56.0	-7.0	49.0	≤ 74.0	25.0	388.0	165.2	Y	-
4956.000	AV	H	35.0	-3.2	31.8	≤ 54.0	22.2	100.0	281.2	Y	10.0
4956.000	PK	H	44.8	-3.2	41.6	≤ 74.0	32.4	100.0	280.2	Y	-
9912.000	AV	H	38.0	-5.1	32.9	≤ 54.0	21.1	388.0	81.1	Y	10.0
9912.000	PK	H	48.5	-5.1	43.4	≤ 74.0	30.6	390.0	80.1	Y	-
24780.000	AV	H	40.4	-2.4	38.0	≤ 54.0	16.0	100.0	285.0	Y	10.0
24780.000	PK	H	50.4	-2.4	48.0	≤ 74.0	26.0	100.0	282.0	Y	-
2483.500	AV	V	45.1	-7.0	38.1	≤ 54.0	15.9	431.0	111.2	Y	10.0
2483.500	PK	V	54.8	-7.0	47.8	≤ 74.0	26.2	431.0	110.2	Y	-
4956.000	AV	V	34.6	-3.2	31.4	≤ 54.0	22.6	119.0	66.2	Y	10.0
4956.000	PK	V	45.2	-3.2	42.0	≤ 74.0	32.0	120.0	65.2	Y	-
12390.000	AV	V	39.4	-5.4	34.0	≤ 54.0	20.0	365.0	345.1	Y	10.0
12390.000	PK	V	49.4	-5.4	44.0	≤ 74.0	30.0	360.0	350.2	Y	-
22302.000	AV	V	39.6	-1.7	37.9	≤ 54.0	16.1	388.0	178.0	Y	10.0
22302.000	PK	V	50.1	-1.7	48.4	≤ 74.0	25.6	388.0	180.0	Y	-

Plot data for 2.4 GHz Restricted-Band Edge

These plot data show peak (trace blue) and average (trace black) spectrum for worst case emissions in the restricted-band edges. (Restricted band edges: below 2390 MHz and above 2483.5 MHz)

The result of the final radiated spurious emissions measurement refers in previous pages.

[1 Mbps / 2402 MHz]

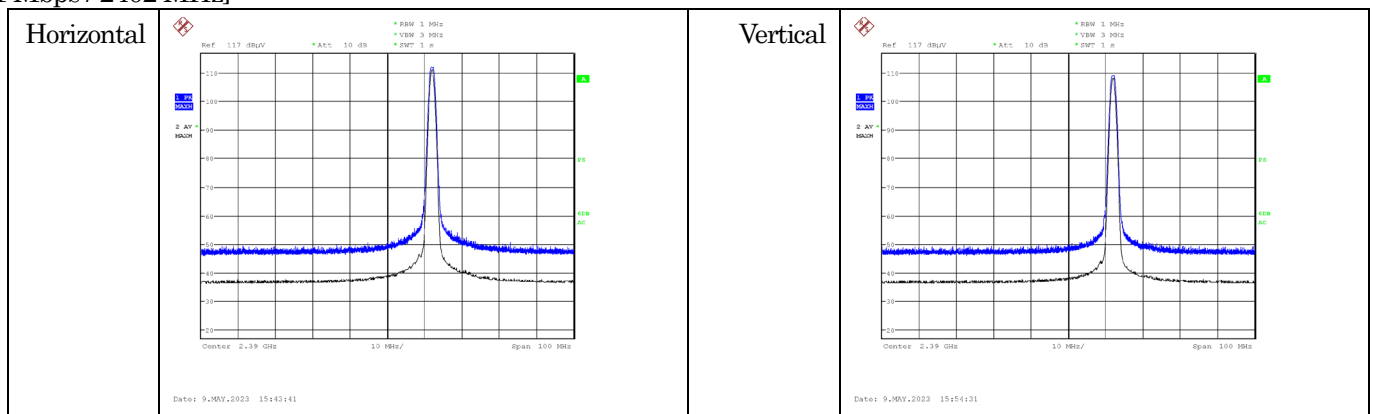

[1 Mbps / 2480 MHz]

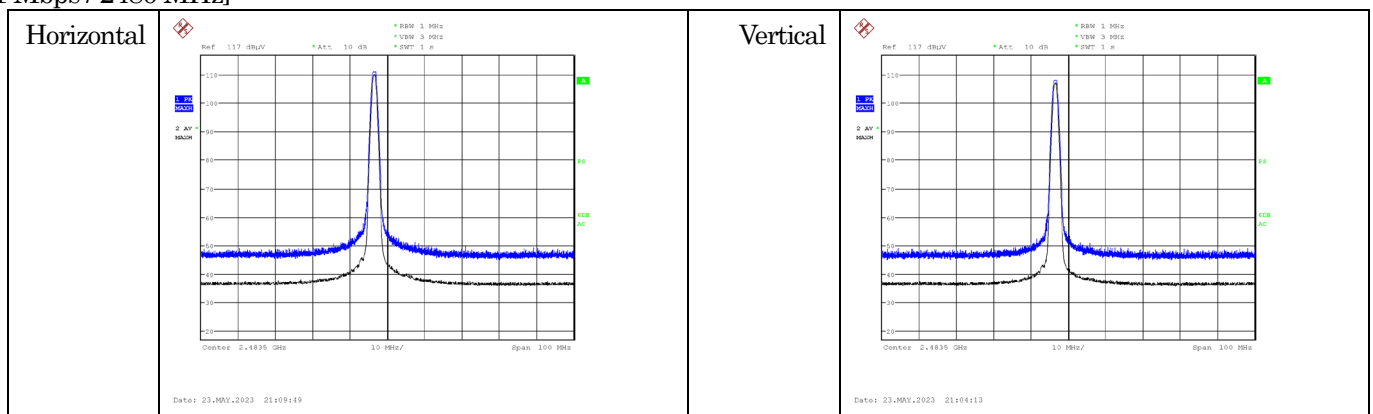

[2 Mbps / 2404 MHz]

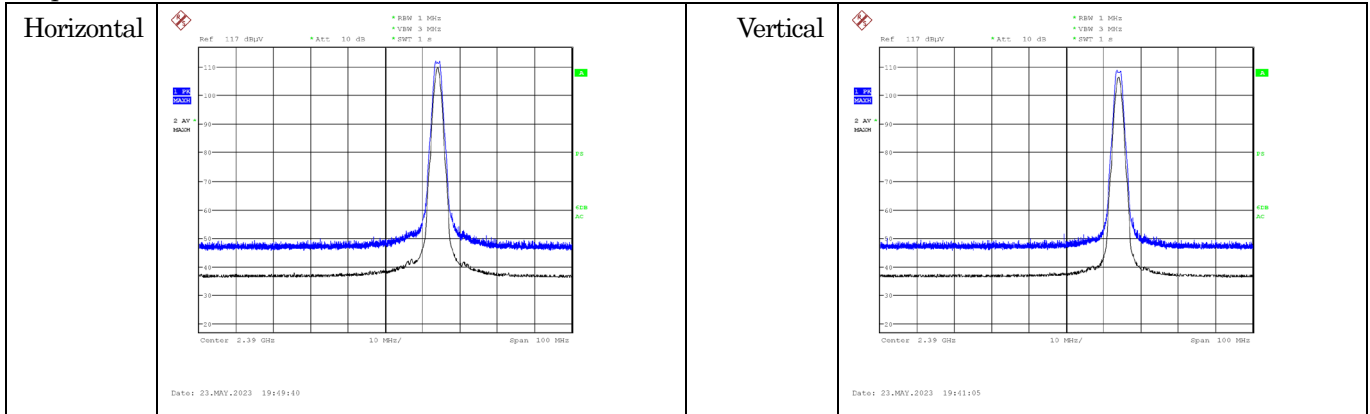

[2 Mbps / 2480 MHz]

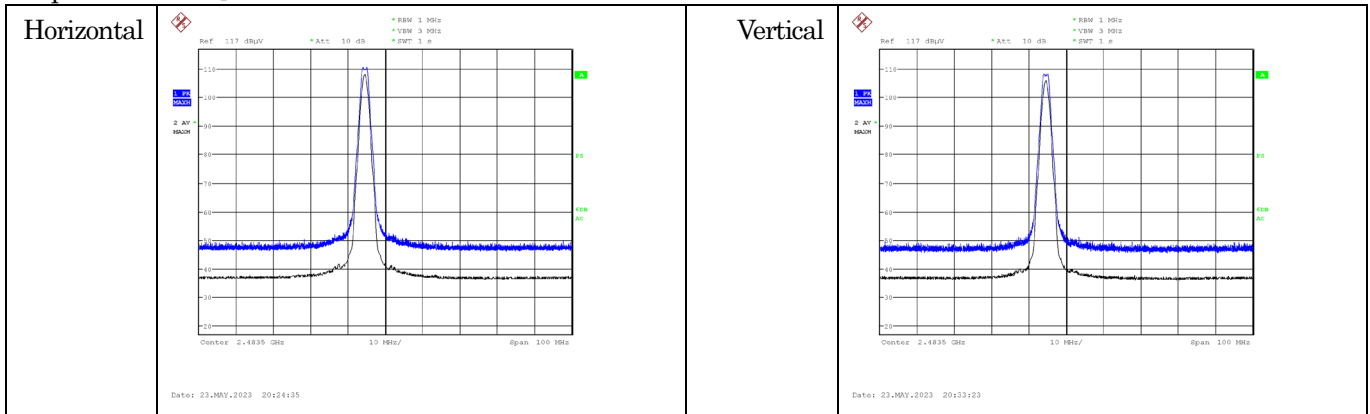

Plot data for above 1GHz in worst mode

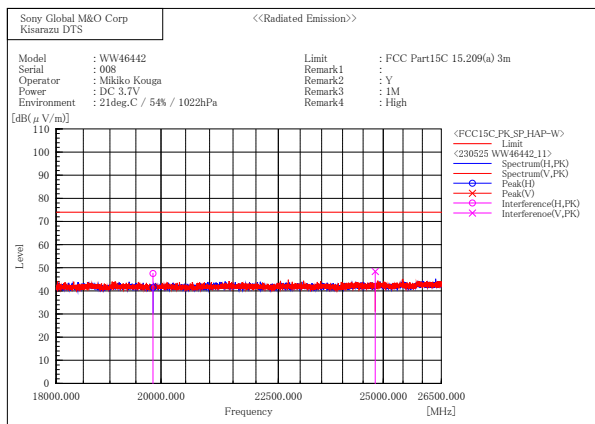
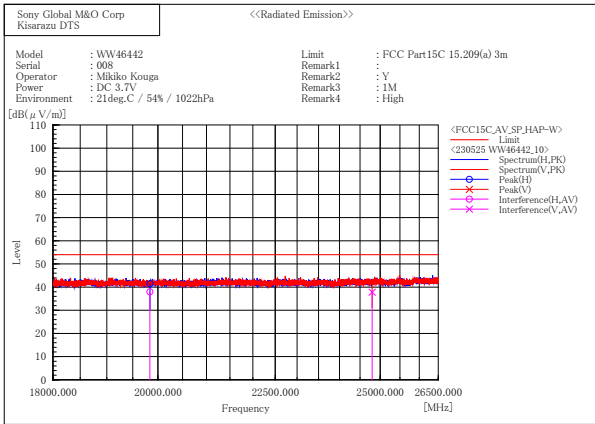
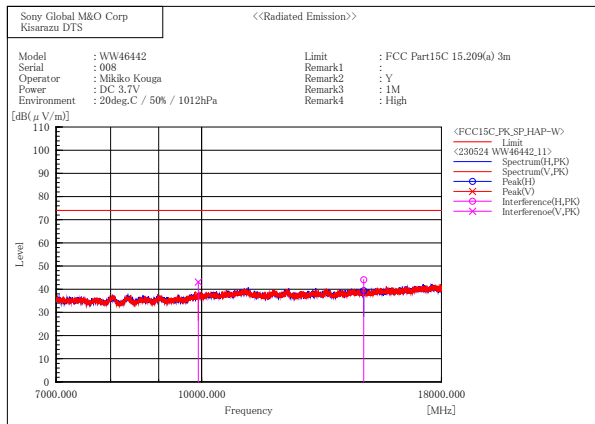
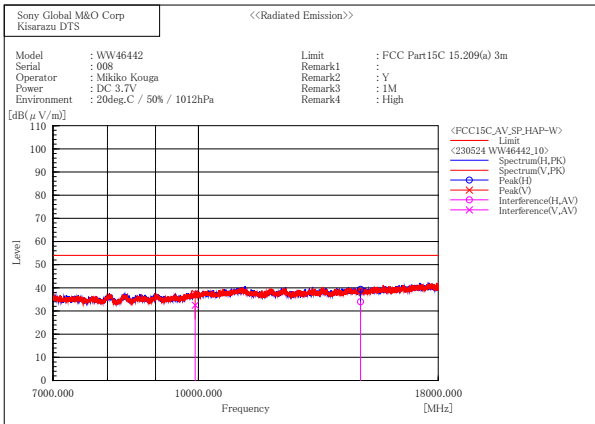
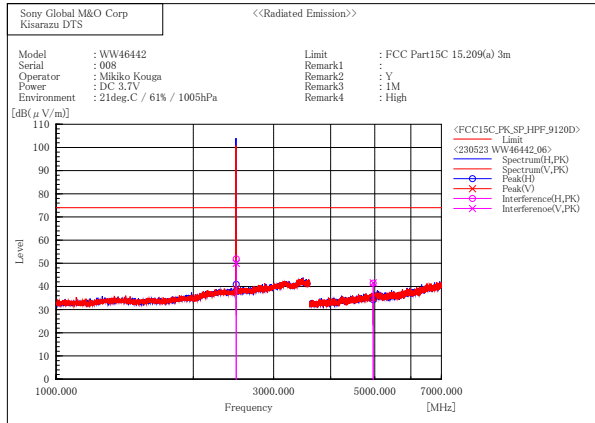
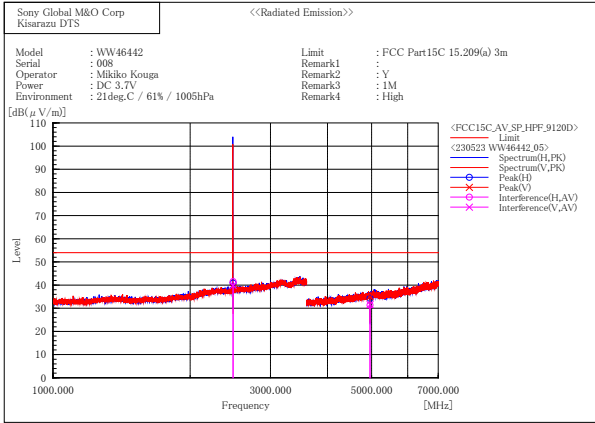

3.5. Conducted Spurious Emissions for Band Edge

Date of measurement	Ambient temperature	Relative humidity	Measured by
May 10, 2023	22.2 deg.C	54.6 %	Mikiko Kouga

Mode	Rate [Mbps]	Channel [MHz]	Frequency [MHz]	Reading(PK) [dBm]	C.F. [dB]	Result [dBm]	Limit [dBm]	Margin [dB]
BLE	1	2402	2402.24	6.96	1.12	8.08	-	-
			2399.97	-53.37	1.12	-52.25	≤ -11.92	40.33
	2	2404	2404.49	5.63	1.12	6.75	-	-
			2400.00	-58.47	1.12	-57.35	≤ -13.25	44.10

[1 Mbps / 2402 MHz]

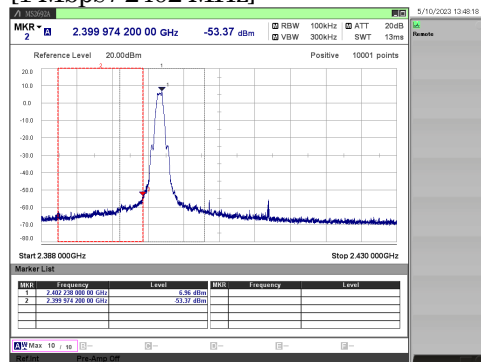

[2 Mbps / 2404 MHz]

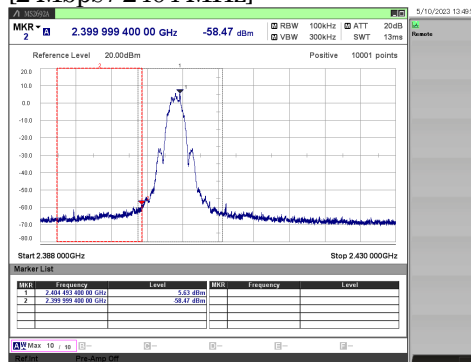

4. Method of Calculation

4.1. Maximum Peak Conducted Output Power

Method of calculation : Software
Software Name : SW-0316
Software Version : Ver.3

Test Result (PK) [dBm] = Meter Reading [dBm] + C.F. [dB]

Test Result (AV) [dBm] = Meter Reading [dBm] + C.F. [dB] + Duty Factor [dB]

Note (a) Meter Reading : Reading of the power meter
(b) C.F. : System Cable Loss + EUT Cable Loss
(c) Duty Factor : $10\log \{(\text{Tx ON Time} + \text{Tx OFF Time}) / (\text{Tx ON Time})\}$

4.2. Power Spectral Density

Method of calculation : Software
Software Name : SW-0316
Software Version : Ver.3

Test Result [dBm] = Meter Reading [dBm] + C.F. [dB]

Note (a) Meter Reading : Reading of the spectrum analyzer
(b) C.F. : System Cable Loss + EUT Cable Loss

4.3. Radiated Spurious Emissions

Method of calculation : Software
Software Name : V-Scan
Software Version : Ver.4.0.30

Test Result [dBuV/ m] = Meter Reading [dBuV] + C.F. [dB/ m]

Note (a) Meter Reading : Reading of the EMI test receiver or the spectrum analyzer.
(b) C.F. : Antenna Factor (including Balun Loss) + System GainLoss
: Antenna Factor (including Balun Loss) + System GainLoss + 20 log (3 m/ 10 m)

4.4. Conducted Spurious Emissions for Band Edge

Method of calculation : Software
Software Name : SW-0316
Software Version : Ver.3

Test Result [dBm] = Meter Reading [dBm] + C.F. [dB]

Note (a) Meter Reading : Reading of the spectrum analyzer.
(b) C.F. : System Cable Loss + EUT Cable Loss

5. List of Test Equipment

All test results are traceable to the national and/or international standards.

5.1. Antenna-port Conducted Measurements

Used	Ctrl#	Equipment	Model No.	Serial No.	Manufacturer	Cal.Interval	Last Cal.
-	W0140	Spectrum Analyzer	FSU26	200717	Rohde & Schwarz	12 months	22.11.01
x	W0100	Signal Analyzer	MS2692A	6201338955	Anritsu	12 months	22.05.11
x	W0006	Power Meter	N1911A	MY50000295	Agilent Technologies	12 months	22.11.01
x	W0007	Power Sensor	N1922A	MY50180022	Agilent Technologies	12 months	22.11.01
-	W0029	ATT (10dB, SMA)	8493C	76549	Agilent Technologies	12 months	22.11.02
-	WC0002	50ohm Coaxial Cable (1m)	SUCOFLEX102	34124/2	HUBER + SUHNER	12 months	22.11.02
-	WC0003	50ohm Coaxial Cable (1m)	SUCOFLEX102	34127/2	HUBER + SUHNER	12 months	22.11.02
-	WC0004	50ohm Coaxial Cable (0.5m)	SUCOFLEX102	34288/2	HUBER + SUHNER	12 months	22.11.02
x	WC0005	50ohm Coaxial Cable (0.5m)	SUCOFLEX102	34287/2	HUBER + SUHNER	12 months	22.11.02
-	WC0006	50ohm Coaxial Cable (0.5m)	SUCOFLEX102	34289/2	HUBER + SUHNER	12 months	22.11.02
-	WC0007	50ohm Coaxial Cable (0.5m)	SUCOFLEX102	34286/2	HUBER + SUHNER	12 months	22.11.02
x	M0720	Thermometer	TH-321	140036	AS ONE	12 months	22.11.17

5.2. Radiated Spurious Emissions

Date of Measurement : May 9, 2023

Used	Ctrl#	Equipment	Model No.	Serial No.	Manufacturer	Cal.Interval	Last Cal.
-	M0515	EMI Receiver	ESCI	100606	Rohde & Schwarz	-	-
x	M0504	EMI Receiver	ESU40	100086	Rohde & Schwarz	12 months	22.12.07
x	A0073	Loop Antenna	HFH2-Z2	100171	Rohde & Schwarz	12 months	22.11.16
x	A0043	Biconical Antenna	BBA9106	V5(91032598)	Schwarzbeck	12 months	22.11.10
x	A0046	Log periodic Antenna	UHALP9108A1	0830	Schwarzbeck	12 months	22.11.10
x	A0056	Horn Antenna	BBHA9120D	670	Schwarzbeck	12 months	23.03.01
x	A0057	Horn Antenna	HAP06-18W	00000037	Toyo Corporation	12 months	23.03.01
x	A0058	Horn Antenna	HAP18-26W	00000016	Toyo Corporation	12 months	23.02.03
-	A0060	Horn Antenna	HAP26-40W	00000009	Toyo Corporation	12 months	23.02.03
-	CS0037	Fourth Site RE Cable SYS1	-	-	-	12 months	22.06.26
x	CS0039	Fourth Site RE Cable SYS3	-	-	-	12 months	22.06.26
x	CS0054	Fourth Site EMF Cable SYS	-	-	-	12 months	22.06.26
x	M1055	GHz Filter Box	WSF-109	17111786	Wakoh	12 months	23.03.01
x	M0510	RF Selector	NS4900	0802-226	Toyo Corporation	12 months	22.06.26
x	M0620	RF Pre-Amp	8447D	2944A10720	Agilent Technologies	12 months	22.06.26
x	M0706	3dB Attenuator	8491A	MY39267782	Agilent Technologies	12 months	22.06.26
x	M5314	Temperature Meter	608-H2	83148485	testo	24 months	21.09.16
x	M1048	Scientific Ambient Monitor	0560 6220	39512479/703	testo	12 months	22.08.03
x	M5061	Scientific Ambient Monitor	0560 6220	39515471/801	testo	12 months	23.05.10

Date of Measurement : May 23, 2023 to May 30, 2023

Used	Ctrl#	Equipment	Model No.	Serial No.	Manufacturer	Cal.Interval	Last Cal.
-	M0515	EMI Receiver	ESCI	100606	Rohde & Schwarz	-	-
x	M0504	EMI Receiver	ESU40	100086	Rohde & Schwarz	12 months	22.12.07
x	A0073	Loop Antenna	HFH2-Z2	100171	Rohde & Schwarz	12 months	22.11.16
x	A0043	Biconical Antenna	BBA9106	V5(91032598)	Schwarzbeck	12 months	22.11.10
x	A0046	Log periodic Antenna	UHALP9108A1	0830	Schwarzbeck	12 months	22.11.10
x	A0056	Horn Antenna	BBHA9120D	670	Schwarzbeck	12 months	23.03.01
x	A0057	Horn Antenna	HAP06-18W	00000037	Toyo Corporation	12 months	23.03.01
x	A0058	Horn Antenna	HAP18-26W	00000016	Toyo Corporation	12 months	23.02.03
-	A0060	Horn Antenna	HAP26-40W	00000009	Toyo Corporation	12 months	23.02.03
-	CS0037	Fourth Site RE Cable SYS1	-	-	-	12 months	23.05.14
x	CS0039	Fourth Site RE Cable SYS3	-	-	-	12 months	23.05.14
x	CS0054	Fourth Site EMF Cable SYS	-	-	-	12 months	23.05.14
x	M1055	GHz Filter Box	WSF-109	17111786	Wakoh	12 months	23.03.01
x	M0510	RF Selector	NS4900	0802-226	Toyo Corporation	12 months	23.05.14
x	M0620	RF Pre-Amp	8447D	2944A10720	Agilent Technologies	12 months	23.05.14
x	M0706	3dB Attenuator	8491A	MY39267782	Agilent Technologies	12 months	23.05.14
x	M5314	Temperature Meter	608-H2	83148485	testo	24 months	21.09.16
x	M1048	Scientific Ambient Monitor	0560 6220	39512479/703	testo	12 months	22.08.03
x	M5061	Scientific Ambient Monitor	0560 6220	39515471/801	testo	12 months	23.05.10

About calibration interval

Valid until the end of the month listed in "Cal. Int." column.