

FCC RADIO TEST REPORT

FCC 47 CFR PART 15 SUBPART C

INDUSTRY CANADA RSS-247

Test Standard	FCC Part 15.247 and RSS-247 Issue 2
FCC ID	AK8WN4645R
ISED ID	409B-WN4645R
Brand name	SONY
Applicant	Sony Corporation
Product name	802.11n, 2.4G 2T2R Wireless LAN USB Module
Model No.	WN4645R
Test Result	Pass

The test Result was tested by Compliance Certification Services Inc. The test data, data evaluation, test procedures, and equipment configurations shown in this report were given in ANSI C63.10: 2013 and compliance standards.

The test results of this report relate only to the tested sample (EUT) identified in this report.

The test Report of full or partial shall not copy. Without written approval of Compliance Certification Services Inc. (Wugu Laboratory)



Approved by:

Tested by:

Handwritten signature of Sam Chuang in black ink.

Handwritten signature of Jerry Chuang in black ink.

Sam Chuang
Manager

Jerry Chuang
Engineer

Revision History

Rev.	Issue Date	Revisions	Revised By
00	December 8, 2017	Initial Issue	May Lin

Table of contents

1. GENERAL INFORMATION	4
1.1 EUT INFORMATION.....	4
1.2 EUT CHANNEL INFORMATION	5
1.3 ANTENNA INFORMATION	5
1.4 MEASUREMENT UNCERTAINTY	6
1.5 FACILITIES AND TEST LOCATION	7
1.6 INSTRUMENT CALIBRATION	7
1.7 SUPPORT AND EUT ACCESSORIES EQUIPMENT.....	8
2. TEST SUMMERY.....	9
3. DESCRIPTION OF TEST MODES	10
3.1 THE WORST MODE OF OPERATING CONDITION.....	10
3.2 THE WORST MODE OF MEASUREMENT	11
3.3 EUT DUTY CYCLE	12
4. TEST RESULT.....	13
4.1 AC POWER LINE CONDUCTED EMISSION	13
4.2 6DB BANDWIDTH AND OCCUPIED BANDWIDTH(99%).....	16
4.3 OUTPUT POWER MEASUREMENT	24
4.4 POWER SPECTRAL DENSITY	27
4.5 CONDUCTED BANDEDGE AND SPURIOUS EMISSION	35
4.6 RADIATION BANDEDGE AND SPURIOUS EMISSION.....	54
APPENDIX 1 - PHOTOGRAPHS OF EUT	

1. GENERAL INFORMATION

1.1 EUT INFORMATION

Applicant	Sony Corporation
Applicant address	1-7-1 Konan Minato-ku, Tokyo 108-0075 Japan
Manufacturer	LITE-ON TECHNOLOGY (Changzhou) CO., LTD A9 Building, No.88, Yanghu Road, Wujin Hi-Tech Industrial Development Zone, Changzhou City, Jiangsu Province, P. R. China
Equipment	802.11n, 2.4G 2T2R Wireless LAN USB Module
Model Name	WN4645R
Model Discrepancy	N/A
Received Date	June 7, 2017
Date of Test	December 1 ~ 7, 2017
Output Power(W)	IEEE 802.11b mode: 0.0865 IEEE 802.11g mode: 0.2307 IEEE 802.11n HT 20 MHz mode: 0.3622 IEEE 802.11n HT 40 MHz mode: 0.3879
Power Operation	<input type="checkbox"/> AC 120V/60Hz <input type="checkbox"/> Adapter <input type="checkbox"/> PoE <input checked="" type="checkbox"/> Host system(NB) <input type="checkbox"/> DC Type : <input type="checkbox"/> Battery <input type="checkbox"/> DC Power Supply <input type="checkbox"/> External DC adapter

1.2 EUT CHANNEL INFORMATION

Frequency Range	2412MHz-2462MHz
Modulation Type	1. IEEE 802.11b mode: CCK 2. IEEE 802.11g mode: OFDM 3. IEEE 802.11n HT 20 MHz mode: OFDM 4. IEEE 802.11n HT 40 MHz mode: OFDM
Bandwidth	1. IEEE 802.11b mode: 11 Channels 2. IEEE 802.11g mode: 11 Channels 3. IEEE 802.11n HT 20 MHz mode: 11 Channels 4. IEEE 802.11n HT 40 MHz mode: 7 Channels

Remark:

Refer as ANSI 63.10:2013 clause 5.6.1 Table 4

Number of frequencies to be tested		
Frequency range in which device operates	Number of frequencies	Location in frequency range of operation
<input type="checkbox"/> 1 MHz or less	1	Middle
<input type="checkbox"/> 1 MHz to 10 MHz	2	1 near top and 1 near bottom
<input checked="" type="checkbox"/> More than 10 MHz	3	1 near top, 1 near middle, and 1 near bottom

1.3 ANTENNA INFORMATION

Antenna Type	<input checked="" type="checkbox"/> PIFA <input type="checkbox"/> PCB <input type="checkbox"/> Dipole <input type="checkbox"/> Coils
Antenna Gain	Walsin / RFMTA200700NNLB002 Antenna 1: Gain: 1.53dBi Antenna 2: Gain: -0.29dBi Directional Gain: 0.71 dBi

Note:

$Directional\ gain = 10 \log\left(\frac{10^{(Ant1/10)} + 10^{(Ant2/10)}}{2}\right) = 10 \log\left(\frac{10^{(1.53/10)} + 10^{(-0.29/10)}}{2}\right) = 0.71\ dBi$

1.4 MEASUREMENT UNCERTAINTY

PARAMETER	UNCERTAINTY
Semi Anechoic Chamber (966 Chamber_B) / Radiated Emission, 30 to 1000 MHz	+/- 3.97
Semi Anechoic Chamber (966 Chamber_B) / Radiated Emission, 1 to 18GHz	+/- 3.58
Semi Anechoic Chamber (966 Chamber_B) / Radiated Emission, 18 to 26 GHz	+/- 3.59
Semi Anechoic Chamber (966 Chamber_B) / Radiated Emission, 26 to 40 GHz	+/- 3.81
Conducted Emission (Mains Terminals), 9kHz to 30MHz	+/- 2.48

Remark:

1. This uncertainty represents an expanded uncertainty expressed at approximately the 95% confidence level using a coverage factor of $k=2$
2. ISO/IEC 17025 requires that an estimate of the measurement uncertainties associated with the emissions test results be included in the report.

1.5 FACILITIES AND TEST LOCATION

All measurement facilities used to collect the measurement data are located at
No.11, Wugong 6th Rd., Wugu Dist., New Taipei City 24891, Taiwan. (R.O.C.)

Test site	Test Engineer	Remark
AC Conduction Room	Stemmi Guo	
Radiation	ED Chiang	
RF Conducted	Eric Lee	

Remark: The sites are constructed in conformance with the requirements of ANSI C63.7, ANSI C63.4 and CISPR Publication 22.

1.6 INSTRUMENT CALIBRATION

RF Conducted Test Site					
Equipment	Manufacturer	Model	S/N	Cal Date	Cal Due
Power Meter	Anritsu	ML2495A	1033009	04/11/2017	04/10/2018
Power Sensor	Anritsu	MA2411B	917072	07/03/2017	07/02/2018
Spectrum Analyzer	R&S	FSV 40	101073	10/02/2017	10/01/2018
Thermostatic/Hrgrosatic Chamber	GWINSTEK	GTC-288MH-CC	TH160402	05/23/2017	05/22/2018
SUCOFLEX Cable	HUBER SUHNER	SUCOFLEX 104PEA	25157	07/31/2017	07/30/2018
Divider	Solvang Technology	2-18GHz 4Way	STI08-0015	07/26/2017	07/25/2018
Coupler	Agilent	87301d	MY44350252	07/25/2017	07/24/2018
3M 966 Chamber Test Site					
Equipment	Manufacturer	Model	S/N	Cal Date	Cal Due
Bilog Antenna	Sunol Sciences	JB3	A030105	06/20/2017	06/19/2018
Horn Antenna	EMCO	3117	00055165	02/20/2017	02/19/2018
Horn Antenna	ETS LINDGREN	3116	00026370	01/12/2017	01/11/2018
K Type Cable	Huber+Suhner	SUCOFLEX 102	29406/2	01/10/2017	01/09/2018
K Type Cable	Huber+Suhner	SUCOFLEX 102	22470/2	01/10/2017	01/09/2018
Pre-Amplifier	MITEQ	AMF-6F-260400-40-8P	985646	01/10/2017	01/09/2018
Pre-Amplifier	EMEC	EM01M26G	60570	08/01/2017	07/31/2018
Pre-Amplifier	EMEC	EM330	060609	06/07/2017	06/06/2018
Spectrum Analyzer	Agilent	E4446A	US42510252	11/27/2017	11/26/2018
Antenna Tower	CCS	CC-A-1F	N/A	N.C.R	N.C.R
Controller	CCS	CC-C-1F	N/A	N.C.R	N.C.R
Turn Table	CCS	CC-T-1F	N/A	N.C.R	N.C.R
AC Conducted Emissions Test Site					
Equipment	Manufacturer	Model	S/N	Cal Date	Cal Due
LISN	R&S	ENV216	101054	05/18/2017	05/17/2018
LISN	SCHWARZBECK	NSLK 8127	8127-541	02/14/2017	02/13/2018
EMI Test Receiver	R&S	ESCI	100064	05/17/2017	05/16/2018

Remark: Each piece of equipment is scheduled for calibration once a year.

1.7 SUPPORT AND EUT ACCESSORIES EQUIPMENT

EUT Accessories Equipment					
No.	Equipment	Brand	Model	Series No.	FCC ID
	N/A				

Support Equipment					
No.	Equipment	Brand	Model	Series No.	FCC ID
1	NB	DELL	PP19L	N/A	E2KWM3945ABG
2	NB(H)	Acer	Aspire 4320 series	N/A	QDS-BRCM1018

1.8 Test methodology and applied standards

The test methodology, setups and results comply with all requirements in accordance with ANSI C63.10:2013, FCC Part 2, FCC Part 15.247, KDB 558074 D01 v03r04.

2. TEST SUMMERY

FCC Standard Section	IC Standard Section	Report Section	Test Item	Result
15.203	-	1.2	Antenna Requirement	Pass
15.207(a)	RSS-GEN 8.8	4.1	AC Conducted Emission	Pass
15.247(a)(2)	RSS-247(5.2)(1)	4.2	6 dB Bandwidth	Pass
-	RSS-GEN 6.6	4.2	Occupied Bandwidth (99%)	Pass
15.247(b)	RSS-247(5.4)(4)	4.3	Output Power Measurement	Pass
15.247(e)	RSS-247(5.2)(2)	4.4	Power Spectral Density	Pass
15.247(d)	RSS-247(5.5)	4.5	Conducted Band Edge	Pass
15.247(d)	RSS-247(5.5)	4.5	Conducted Emission	Pass
15.247(d)	RSS-GEN 8.9, 8.10	4.6	Radiation Band Edge	Pass
15.247(d)	RSS-GEN 8.9, 8.10	4.6	Radiation Spurious Emission	Pass

3. DESCRIPTION OF TEST MODES

3.1 THE WORST MODE OF OPERATING CONDITION

Operation mode	IEEE 802.11b mode :1Mbps IEEE 802.11g mode :6Mbps IEEE 802.11n HT20 mode :MCS8 IEEE 802.11n HT40 mode :MCS8
Test Channel Frequencies	IEEE 802.11b mode : 1. Lowest Channel : 2412MHz 2. Middle Channel : 2437MHz 3. Highest Channel : 2462MHz IEEE 802.11g mode : 1. Lowest Channel : 2412MHz 2. Middle Channel : 2437MHz 3. Highest Channel : 2462MHz IEEE 802.11n HT20 mode : 1. Lowest Channel : 2412MHz 2. Middle Channel : 2437MHz 3. Highest Channel : 2462MHz IEEE 802.11n HT40 mode : 1. Lowest Channel : 2422MHz 2. Middle Channel : 2437MHz 3. Highest Channel : 2452MHz
Operation Transmitter	IEEE 802.11b mode :1T1R IEEE 802.11g mode :1T1R IEEE 802.11n HT20 mode :2T2R IEEE 802.11n HT40 mode :2T2R

Remark:

1. EUT pre-scanned data rate of output power for each mode, the worst data rate were recorded in this report.

3.2 THE WORST MODE OF MEASUREMENT

AC Power Line Conducted Emission	
Test Condition	AC Power line conducted emission for line and neutral
Voltage/Hz	DC 5V
Test Mode	Mode 1: EUT power by Host system.
Worst Mode	<input checked="" type="checkbox"/> Mode 1 <input type="checkbox"/> Mode 2 <input type="checkbox"/> Mode 3 <input type="checkbox"/> Mode 4

Radiated Emission Measurement Above 1G	
Test Condition	Band edge, Emission for Unwanted and Fundamental
Voltage/Hz	DC 5V
Test Mode	Mode 1: EUT power by Host system.
Worst Mode	<input checked="" type="checkbox"/> Mode 1 <input type="checkbox"/> Mode 2 <input type="checkbox"/> Mode 3 <input type="checkbox"/> Mode 4
Worst Position	<input type="checkbox"/> Placed in fixed position. <input checked="" type="checkbox"/> Placed in fixed position at X-Plane (E2-Plane) <input type="checkbox"/> Placed in fixed position at Y-Plane (E1-Plane) <input type="checkbox"/> Placed in fixed position at Z-Plane (H-Plane)
Worst Polarity	<input checked="" type="checkbox"/> Horizontal <input type="checkbox"/> Vertical

Radiated Emission Measurement Below 1G	
Test Condition	Radiated Emission Below 1G
Voltage/Hz	DC 5V
Test Mode	Mode 1: EUT power by Host system.
Worst Mode	<input checked="" type="checkbox"/> Mode 1 <input type="checkbox"/> Mode 2 <input type="checkbox"/> Mode 3 <input type="checkbox"/> Mode 4

Remark:

1. The worst mode was record in this test report.
2. EUT pre-scanned in three axis, X, Y, Z and two polarity, Horizontal and Vertical for radiated measurement. The worst case (X-Plane and Horizontal) were recorded in this report
3. For below 1G, AC power line conducted emission and radiation emission were performed the EUT transmit at the highest output power channel as worse case.

3.3 EUT DUTY CYCLE

Duty Cycle				
Configuration	TX ON (ms)	TX ALL (ms)	Duty Cycle (%)	Duty Factor(dB)
802.11b	1.0200	1.1000	92.73%	0.33
802.11g	1.4500	1.5500	93.55%	0.29
802.11n HT20	0.7100	0.8100	87.65%	0.57
802.11n HT40	0.1790	0.2500	71.60%	1.45

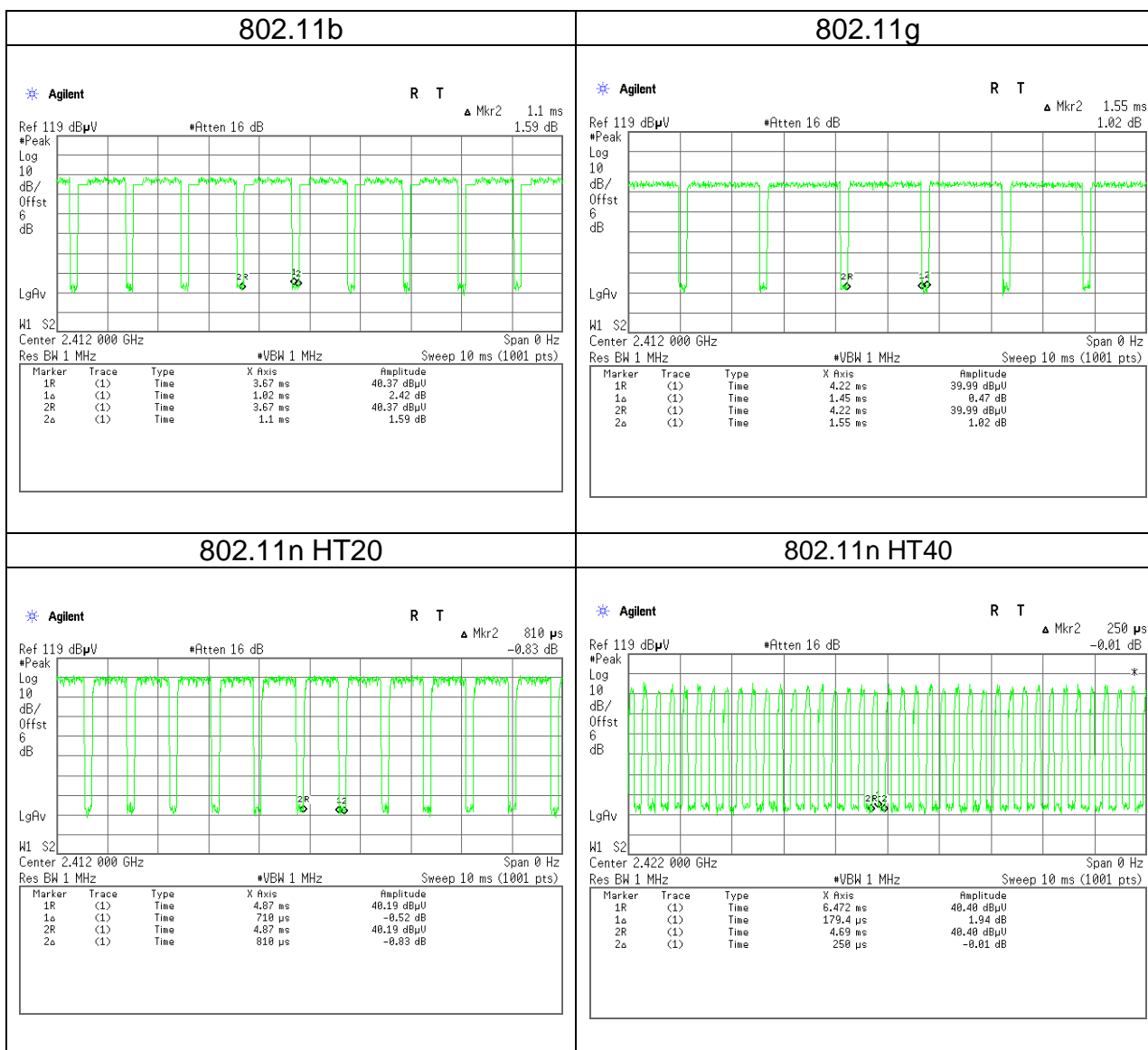

4. TEST RESULT

4.1 AC POWER LINE CONDUCTED EMISSION

4.1.1 Test Limit

According to §15.207(a)(2)

Frequency Range (MHz)	Limits(dBμV)	
	Quasi-peak	Average
0.15 to 0.50	66 to 56*	56 to 46*
0.50 to 5	56	46
5 to 30	60	50

* Decreases with the logarithm of the frequency.

4.1.2 Test Procedure

Test method Refer as ANSI 63.10:2013 clause 6.2,

1. The EUT was placed on a non-conducted table, which is 0.8m above horizontal ground plane and 0.4m above vertical ground plane.
2. EUT connected to the line impedance stabilization network (LISN)
3. Receiver set RBW of 9kHz and Detector Peak, and note as quasi-peak and average.
4. Maximum procedure was performed on the six highest emissions to ensure EUT compliance.
5. Recorded Line for Neutral and Line.

4.1.3 Test Setup

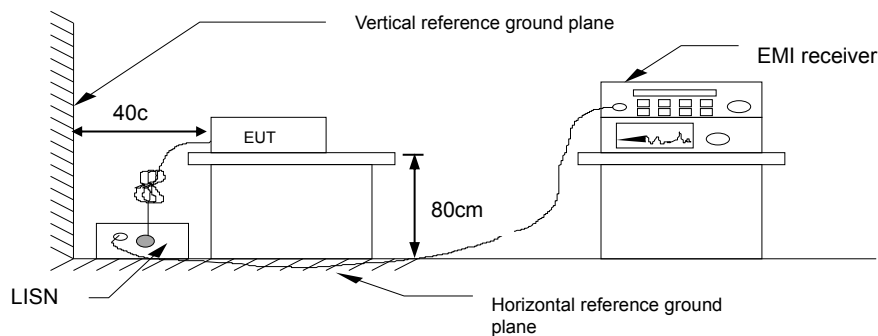

4.1.4 Test Result

Pass.

Test Data

Test Mode:	Mode 1	Temp/Hum	24(°C)/ 50%RH
Test Voltage:	120Vac / 60Hz	Test Date	December 1, 2017
Phase:	Line	Test Engineer	Eric Lee

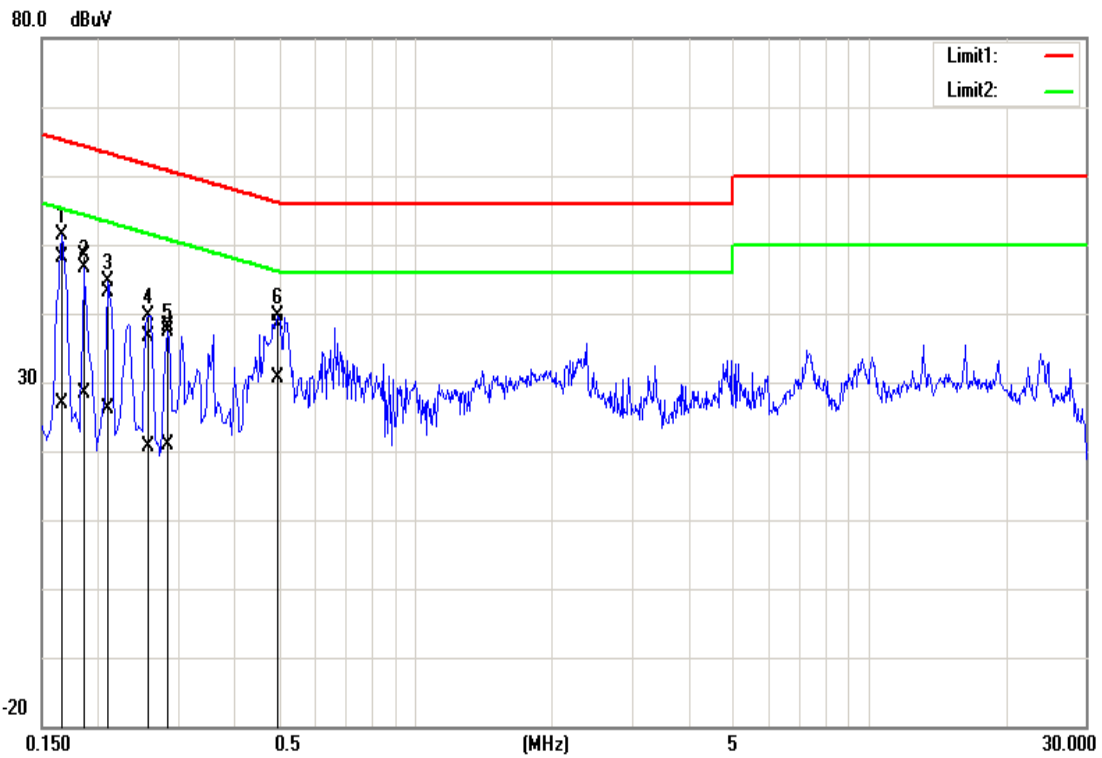

Frequency (MHz)	Quasi Peak reading (dBuV)	Average reading (dBuV)	Correction factor (dB)	Quasi Peak result (dBuV)	Average result (dBuV)	Quasi Peak limit (dBuV)	Average limit (dBuV)	Quasi Peak margin (dB)	Average margin (dB)	Remark
0.1660	48.15	26.76	0.05	48.20	26.81	65.16	55.16	-16.96	-28.35	Pass
0.1860	48.27	28.25	0.05	48.32	28.30	64.21	54.21	-15.89	-25.91	Pass
0.2100	43.13	26.09	0.05	43.18	26.14	63.21	53.21	-20.03	-27.07	Pass
0.2580	36.65	20.54	0.05	36.70	20.59	61.50	51.50	-24.80	-30.91	Pass
0.2860	38.13	20.80	0.05	38.18	20.85	60.64	50.64	-22.46	-29.79	Pass
0.4980	38.45	30.66	0.05	38.50	30.71	56.03	46.03	-17.53	-15.32	Pass

Test Mode:	Mode 1	Temp/Hum	24(°C)/ 50%RH
Test Voltage:	120Vac / 60Hz	Test Date	December 1, 2017
Phase:	Neutral	Test Engineer	Eric Lee

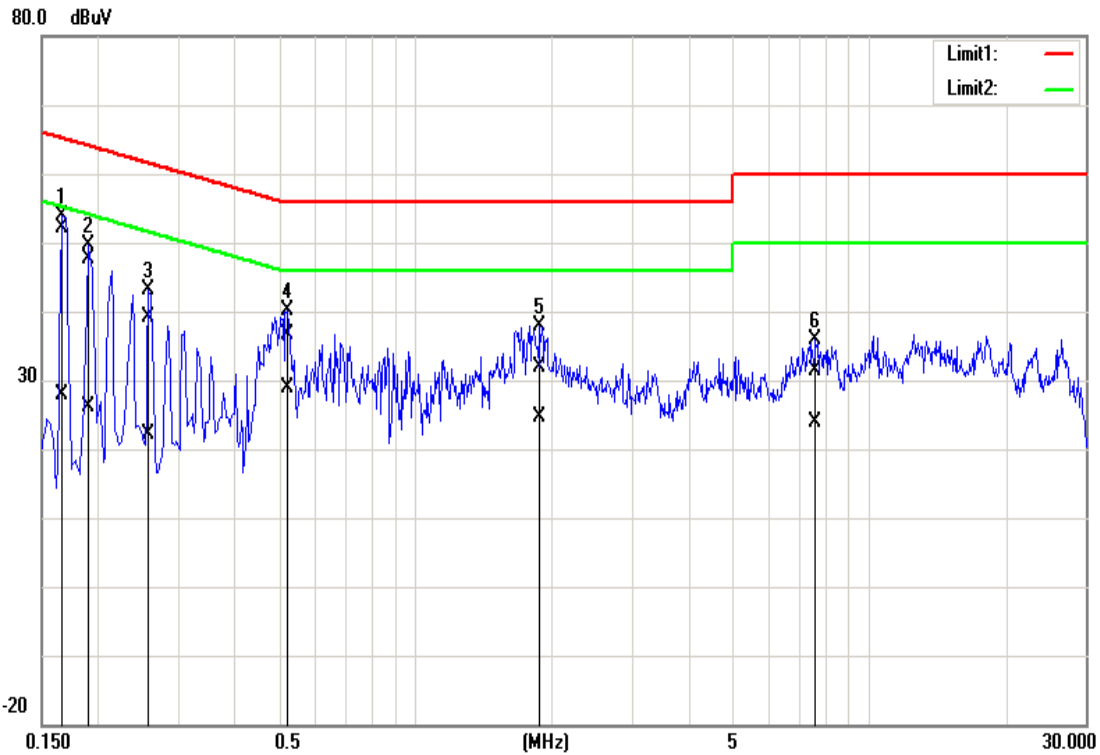

Frequency (MHz)	Quasi Peak reading (dBuV)	Average reading (dBuV)	Correction factor (dB)	Quasi Peak result (dBuV)	Average result (dBuV)	Quasi Peak limit (dBuV)	Average limit (dBuV)	Quasi Peak margin (dB)	Average margin (dB)	Remark
0.1660	52.00	27.87	0.12	52.12	27.99	65.16	55.16	-13.04	-27.17	Pass
0.1900	47.42	25.98	0.12	47.54	26.10	64.04	54.04	-16.50	-27.94	Pass
0.2580	39.08	22.02	0.12	39.20	22.14	61.50	51.50	-22.30	-29.36	Pass
0.5220	36.58	28.64	0.13	36.71	28.77	56.00	46.00	-19.29	-17.23	Pass
1.8860	31.78	24.42	0.17	31.95	24.59	56.00	46.00	-24.05	-21.41	Pass
7.6100	31.02	23.62	0.29	31.31	23.91	60.00	50.00	-28.69	-26.09	Pass

4.2 6DB BANDWIDTH AND OCCUPIED BANDWIDTH (99%)

4.2.1 Test Limit

According to §15.247(a)(2) and RSS-247 section 5.2(a),

6 dB Bandwidth :

Limit	Shall be at least 500kHz
-------	--------------------------

Occupied Bandwidth(99%) : For reporting purposes only.

4.2.2 Test Procedure

Test method Refer as KDB 558074 D01 v03r04, Section 8.1 and ANSI 63.10:2013 clause 6.9.2,

1. The EUT RF output connected to the spectrum analyzer by RF cable.
2. Setting maximum power transmit of EUT
3. SA set RBW = 100kHz, VBW = 300kHz and Detector = Peak, to measurement 6 dB Bandwidth.
4. Measure and record the result of 6 dB Bandwidth and 99% Bandwidth. in the test report.

4.2.3 Test Setup

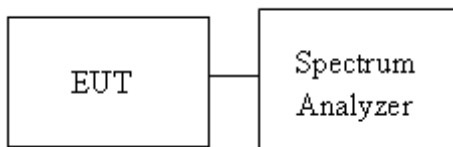

4.2.4 Test Result

Test mode: IEEE 802.11b mode / 2412-2462 MHz						
Channel	Frequency (MHz)	Chain 0 OBW(99%) (MHz)	Chain 1 OBW(99%) (MHz)	Chain 0 6dB BW (MHz)	Chain 1 6dB BW (MHz)	6dB limit (kHz)
Low	2412	14.3270	-	10.0435	-	≥500
Mid	2437	14.3270	-	10.0000	-	
High	2462	14.2836	-	9.6087	-	

Test mode: IEEE 802.11g mode / 2412-2462 MHz						
Channel	Frequency (MHz)	Chain 0 OBW(99%) (MHz)	Chain 1 OBW(99%) (MHz)	Chain 0 6dB BW (MHz)	Chain 1 6dB BW (MHz)	6dB limit (kHz)
Low	2412	16.4978	-	15.1304	-	≥500
Mid	2437	16.8017	-	15.1304	-	
High	2462	16.8451	-	15.1304	-	

Test mode: IEEE 802.11n HT 20 MHz mode / 2412-2462 MHz						
Channel	Frequency (MHz)	Chain 0 OBW(99%) (MHz)	Chain 1 OBW(99%) (MHz)	Chain 0 6dB BW (MHz)	Chain 1 6dB BW (MHz)	6dB limit (kHz)
Low	2412	17.5832	17.6700	15.1304	15.0870	≥500
Mid	2437	17.5832	17.6700	15.1304	15.1304	
High	2462	17.5832	17.7134	15.1304	15.1304	

Test mode: IEEE 802.11n HT 40 MHz mode / 2422-2452 MHz						
Channel	Frequency (MHz)	Chain 0 OBW(99%) (MHz)	Chain 1 OBW(99%) (MHz)	Chain 0 6dB BW (MHz)	Chain 1 6dB BW (MHz)	6dB limit (kHz)
Low	2422	36.2373	36.0057	35.130	35.014	>500
Mid	2437	36.2373	36.0057	35.014	35.014	
High	2452	36.2373	36.1215	35.130	35.014	

Test Data

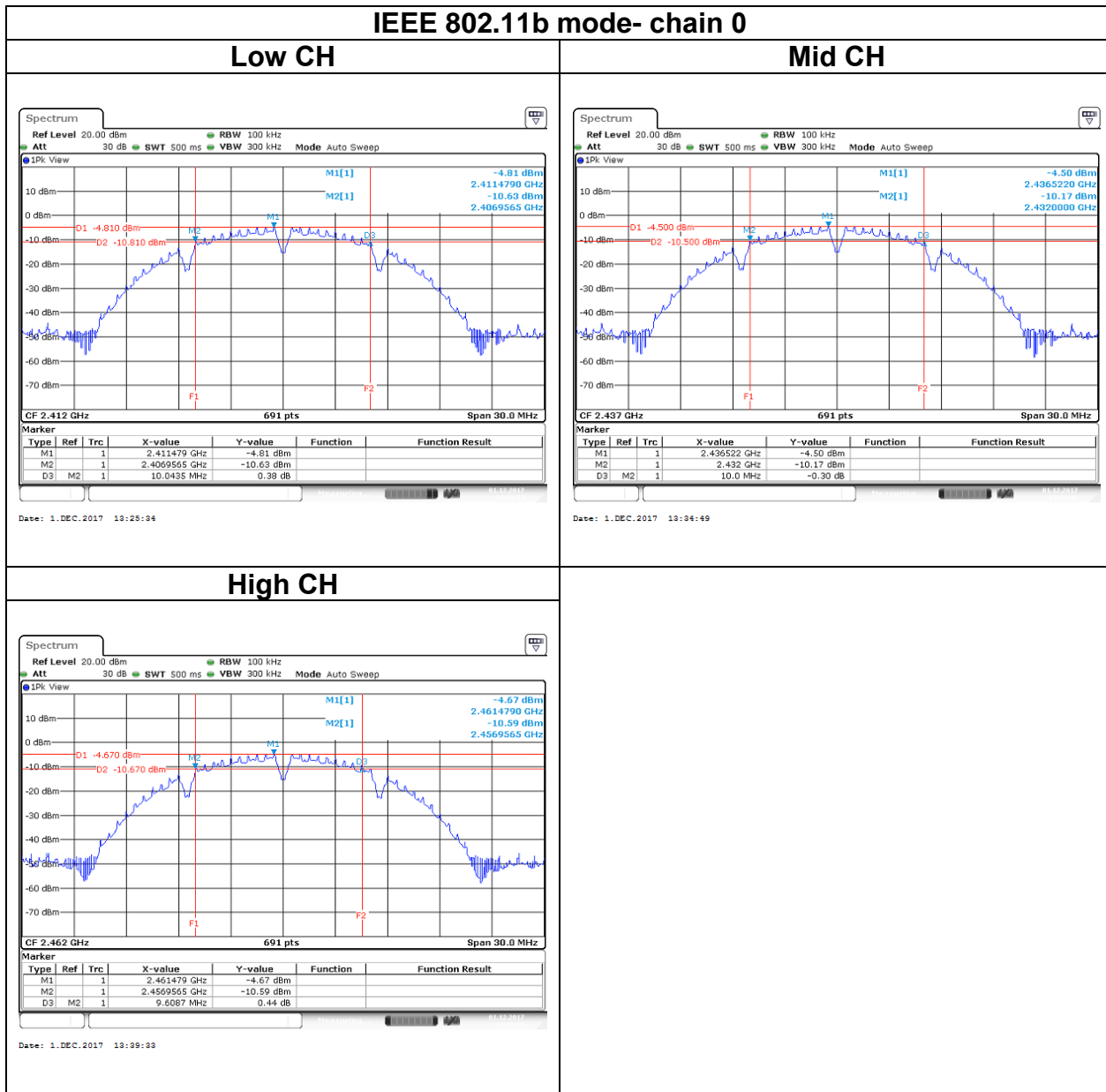

IEEE 802.11g mode- chain 0

Low CH

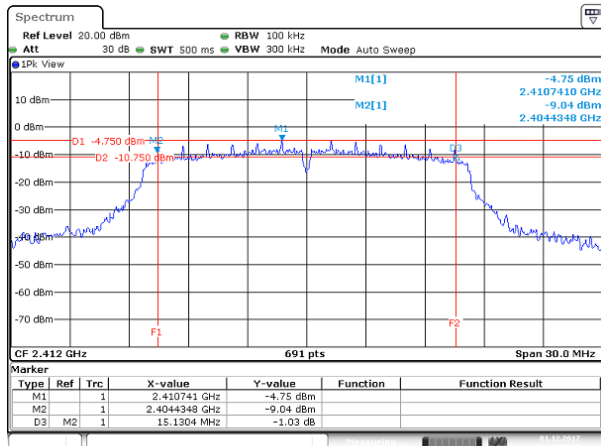

Mid CH

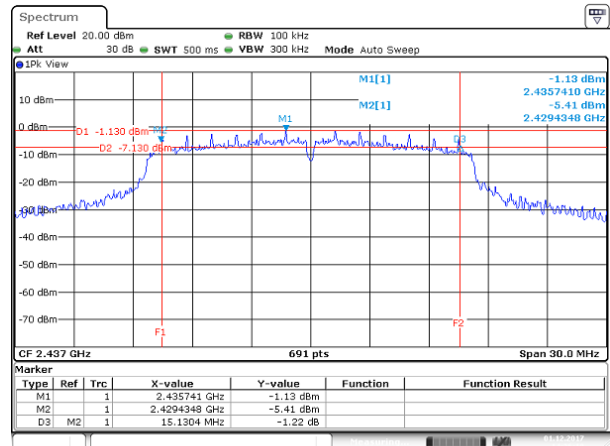

High CH

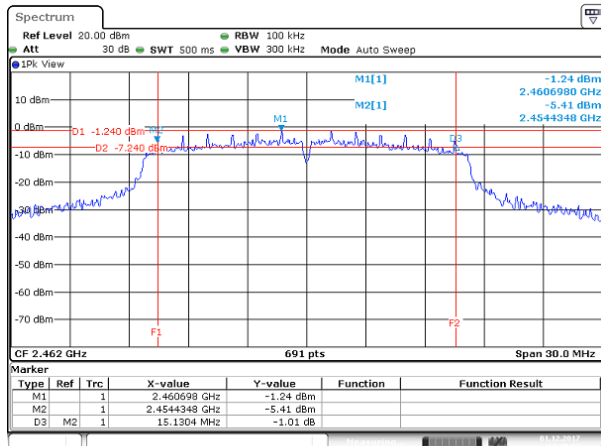

IEEE 802.11n HT20 mode- chain 0

Low CH

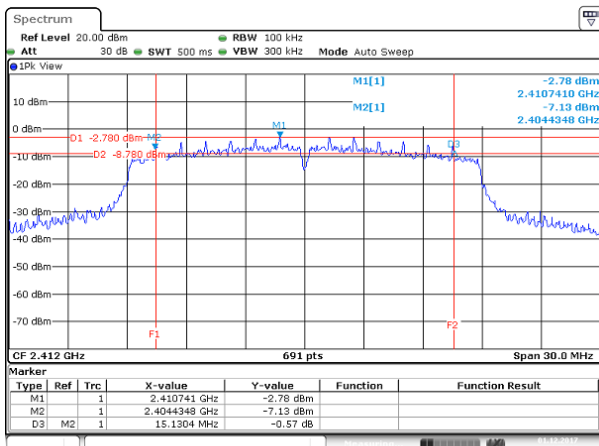

Date: 1.DEC.2017 14:57:06

Mid CH

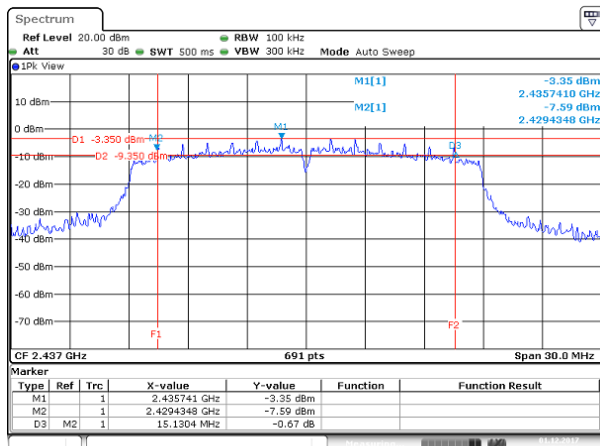

Date: 1.DEC.2017 15:01:28

High CH

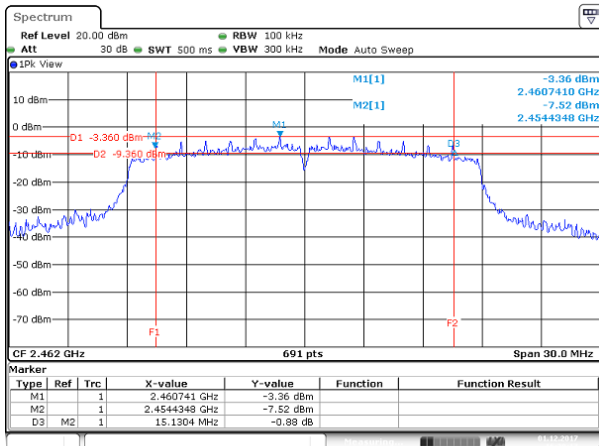

Date: 1.DEC.2017 16:38:17

IEEE 802.11n HT20 mode- chain 1

Low CH

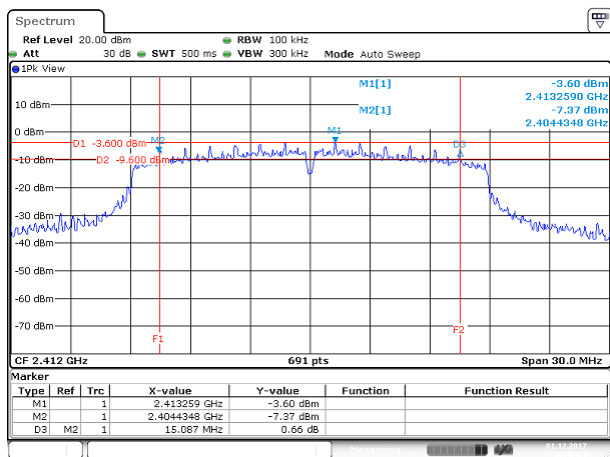

Date: 1.DEC.2017 16:46:22

Mid CH

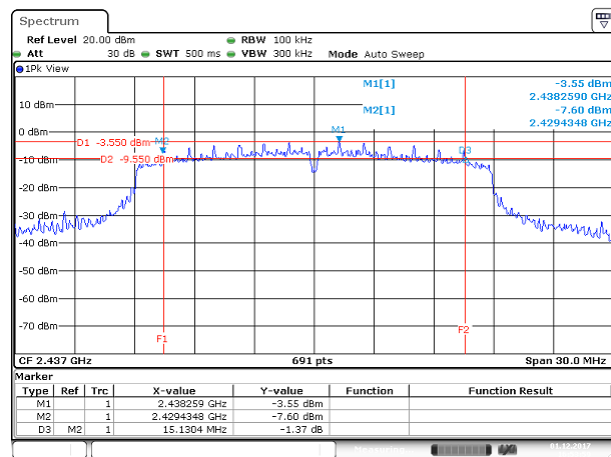

Date: 1.DEC.2017 16:53:59

High CH

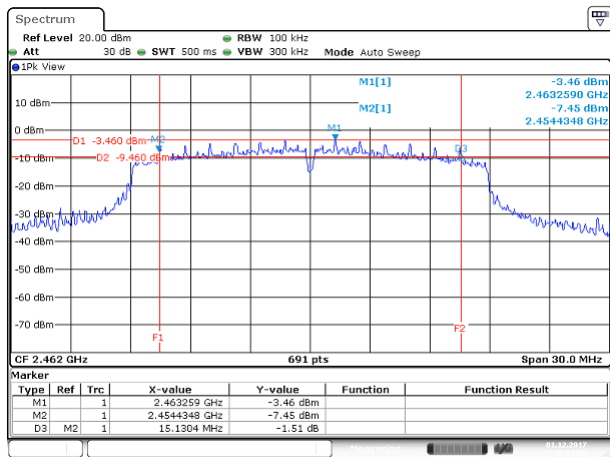

Date: 1.DEC.2017 16:59:55

IEEE 802.11n HT40 mode- chain 0

Low CH

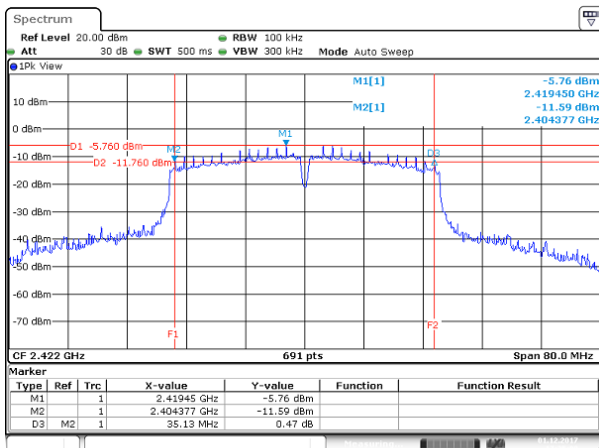

Date: 1.DEC.2017 17:35:00

Mid CH

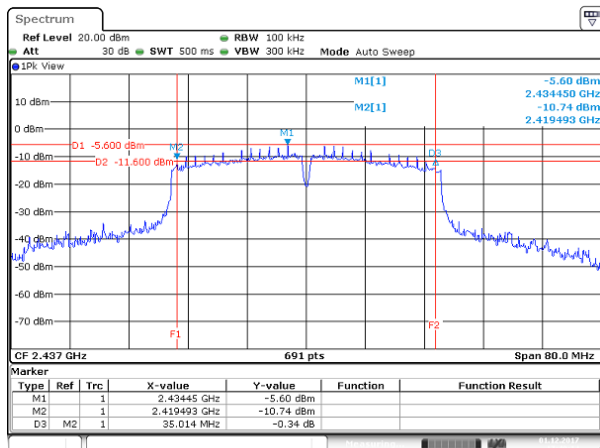

Date: 1.DEC.2017 17:40:14

High CH

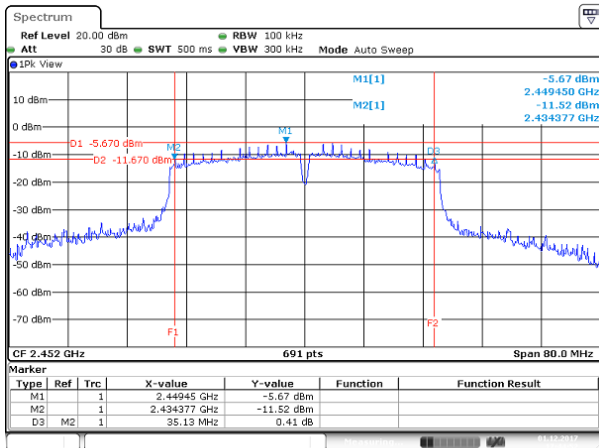

Date: 1.DEC.2017 17:44:52

IEEE 802.11n HT40 mode- chain 1

Low CH

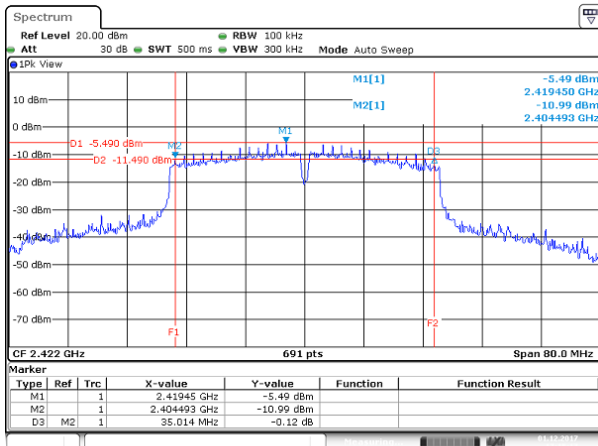

Mid CH

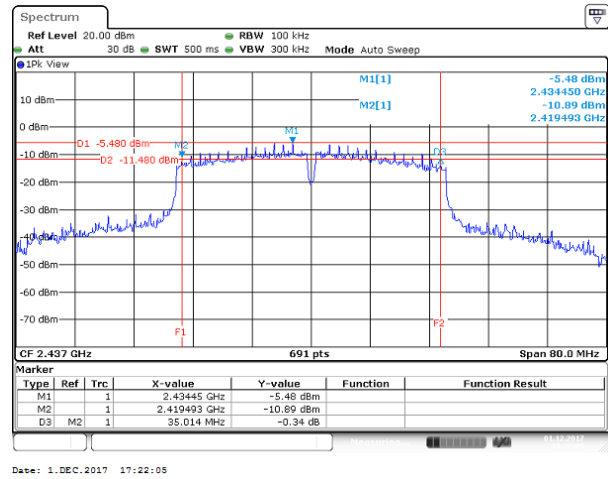

chain 1 High CH

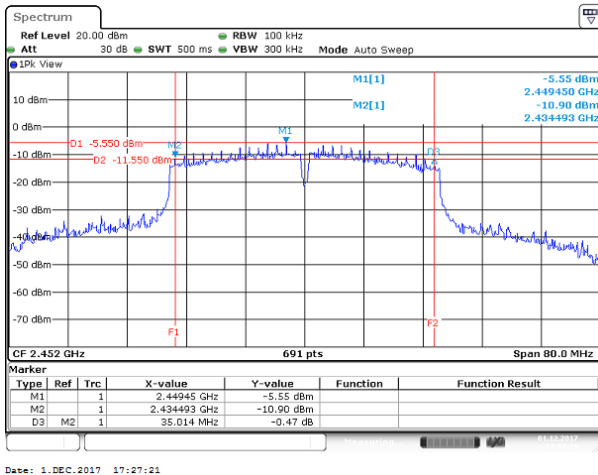

4.3 OUTPUT POWER MEASUREMENT

4.3.1 Test Limit

According to §15.247(b) and RSS-247 section 5.4(4),

Peak output power :

For systems using digital modulation in the 2400-2483.5 MHz, and 5725-5850 MHz bands: 1 Watt(30 dBm) and the e.i.r.p. shall not exceed 4Watt(36 dBm), base on the use of antennas with directional gain not exceed 6 dBi If transmitting antennas of directional gain greater than 6dBi are used the peak output power the conducted output power from the intentional radiator shall be reduced by the amount in dB that the directional gain of the antenna exceeds 6 dBi. In case of point-to-point operation, the limit has to be reduced by 1dB for every 3 dB that the directional gain of the antenna exceeds 6 dBi.

Limit	<input checked="" type="checkbox"/> Antenna not exceed 6 dBi : 30dBm <input type="checkbox"/> Antenna with DG greater than 6 dBi : [Limit = 30 – (DG – 6)] <input type="checkbox"/> Point-to-point operation :
-------	---

Average output power : For reporting purposes only.

4.3.2 Test Procedure

Test method Refer as KDB 558074 D01 v03r04, Section 9.1.2.

1. The EUT RF output connected to the power meter by RF cable.
2. Setting maximum power transmit of EUT.
3. The path loss was compensated to the results for each measurement.
4. Measure and record the result of Peak output power and Average output power. in the test report.

4.3.3 Test Setup

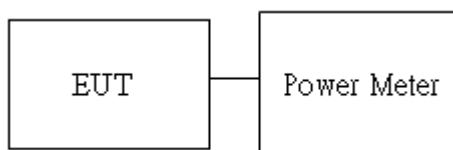

4.3.4 Test Result

Peak output power :

Wifi 2.4G									
Config	CH	Freq. (MHz)	power set		PK Power(dBm)		PK Total Power (dBm)	PK Total Power (W)	Limit (dBm)
			chain0	chain1	chain0	chain1			
IEEE 802.11b Data rate: 1Mbps	Low	2412	26	-	19.27	-	19.27	0.0845	30
	Mid	2437	26	-	19.23	-	19.23	0.0838	
	High	2462	26	-	19.37	-	19.37	0.0865	
IEEE 802.11g Data rate: 6Mbps	Low	2412	21	-	22.70	-	22.70	0.1862	
	Mid	2437	28	-	23.63	-	23.63	0.2307	
	High	2462	1F	-	22.19	-	22.19	0.1656	
IEEE 802.11n HT20 Data rate: MCS8	Low	2412	1F	1F	20.68	20.58	23.64	0.2312	
	Mid	2437	27	27	22.53	22.62	25.59	0.3622	
	High	2462	1D	1D	19.56	19.70	22.64	0.1837	
IEEE 802.11n HT40 Data rate: MCS8	Low	2422	18	18	18.10	17.63	20.88	0.1225	
	Mid	2437	28	28	22.83	22.90	25.88	0.3873	
	High	2452	11	11	15.32	14.67	18.02	0.0634	

Average output power :

Wifi 2.4G					
Config	CH	Freq. (MHz)	AV Power(dBm)		AV Total Power (dBm)
			chain0	chain1	
IEEE 802.11b Data rate: 1Mbps	Low	2412	17.60	-	17.60
	Mid	2437	17.54	-	17.54
	High	2462	17.68	-	17.68
IEEE 802.11g Data rate: 6Mbps	Low	2412	15.13	-	15.13
	Mid	2437	17.98	-	17.98
	High	2462	14.16	-	14.16
IEEE 802.11n HT20 Data rate: MCS8	Low	2412	12.77	12.70	15.75
	Mid	2437	16.23	16.37	19.31
	High	2462	11.80	11.65	14.74
IEEE 802.11n HT40 Data rate: MCS8	Low	2422	9.22	9.21	12.23
	Mid	2437	16.56	17.04	19.82
	High	2452	5.46	5.52	8.50

4.4 POWER SPECTRAL DENSITY

4.4.1 Test Limit

According to §15.247(e) and RSS-247 section 5.2(2)

For digitally modulated systems, the power spectral density conducted from the intentional radiator to the antenna shall not be greater than 8 dBm in any 3 kHz band during any time interval of continuous transmission.

Limit	<input checked="" type="checkbox"/> Antenna not exceed 6 dBi : 8dBm <input type="checkbox"/> Antenna with DG greater than 6 dBi : [Limit = 8 – (DG – 6)] <input type="checkbox"/> Point-to-point operation :
-------	---

4.4.2 Test Procedure

Test method Refer as KDB 558074 D01 v03r04, Section 10.2

1. The EUT RF output connected to the spectrum analyzer by RF cable.
2. Setting maximum power transmit of EUT
3. SA set RBW = 3kHz, VBW = 30kHz, Span = 1.5 times DTS Bandwidth (6 dB BW), Detector = Peak, Sweep Time = Auto and Trace = Max hold.
4. The path loss and Duty Factor were compensated to the results for each measurement by SA.
5. Mark the maximum level.
6. Measure and record the result of power spectral density. in the test report.

4.4.3 Test Setup

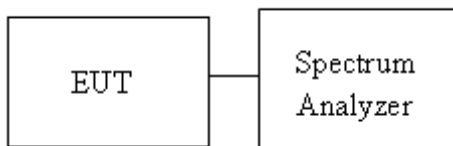

4.4.4 Test Result

Test mode: IEEE 802.11b mode / 2412-2462 MHz					
Channel	Frequency (MHz)	Chain 0 PPSD (dBm)	Chain 1 PPSD (dBm)	Total PSSD (dBm)	Limit (dBm)
Low	2412	-9.58	-	-9.58	8
Mid	2437	-10.30	-	-10.30	
High	2462	-9.55	-	-9.55	

Test mode: IEEE 802.11g mode / 2412-2462 MHz					
Channel	Frequency (MHz)	Chain 0 PPSD (dBm)	Chain 1 PPSD (dBm)	Total PSSD (dBm)	Limit (dBm)
Low	2412	-8.20	-	-8.20	8
Mid	2437	-7.41	-	-7.41	
High	2462	-7.67	-	-7.67	

Test mode: IEEE 802.11n HT 20 MHz mode / 2412-2462 MHz					
Channel	Frequency (MHz)	Chain 0 PPSD (dBm)	Chain 1 PPSD (dBm)	Total PSSD (dBm)	Limit (dBm)
Low	2412	-8.06	-9.27	-5.61	8
Mid	2437	-8.46	-8.84	-5.64	
High	2462	-8.90	-9.16	-6.02	

Test mode: IEEE 802.11n HT 40 MHz mode / 2422-2452 MHz					
Channel	Frequency (MHz)	Chain 0 PPSD (dBm)	Chain 1 PPSD (dBm)	Total PSSD (dBm)	Limit (dBm)
Low	2422	-10.41	-9.34	-6.83	8
Mid	2437	-10.10	-9.32	-6.68	
High	2452	-10.22	-9.79	-6.99	

Test Data

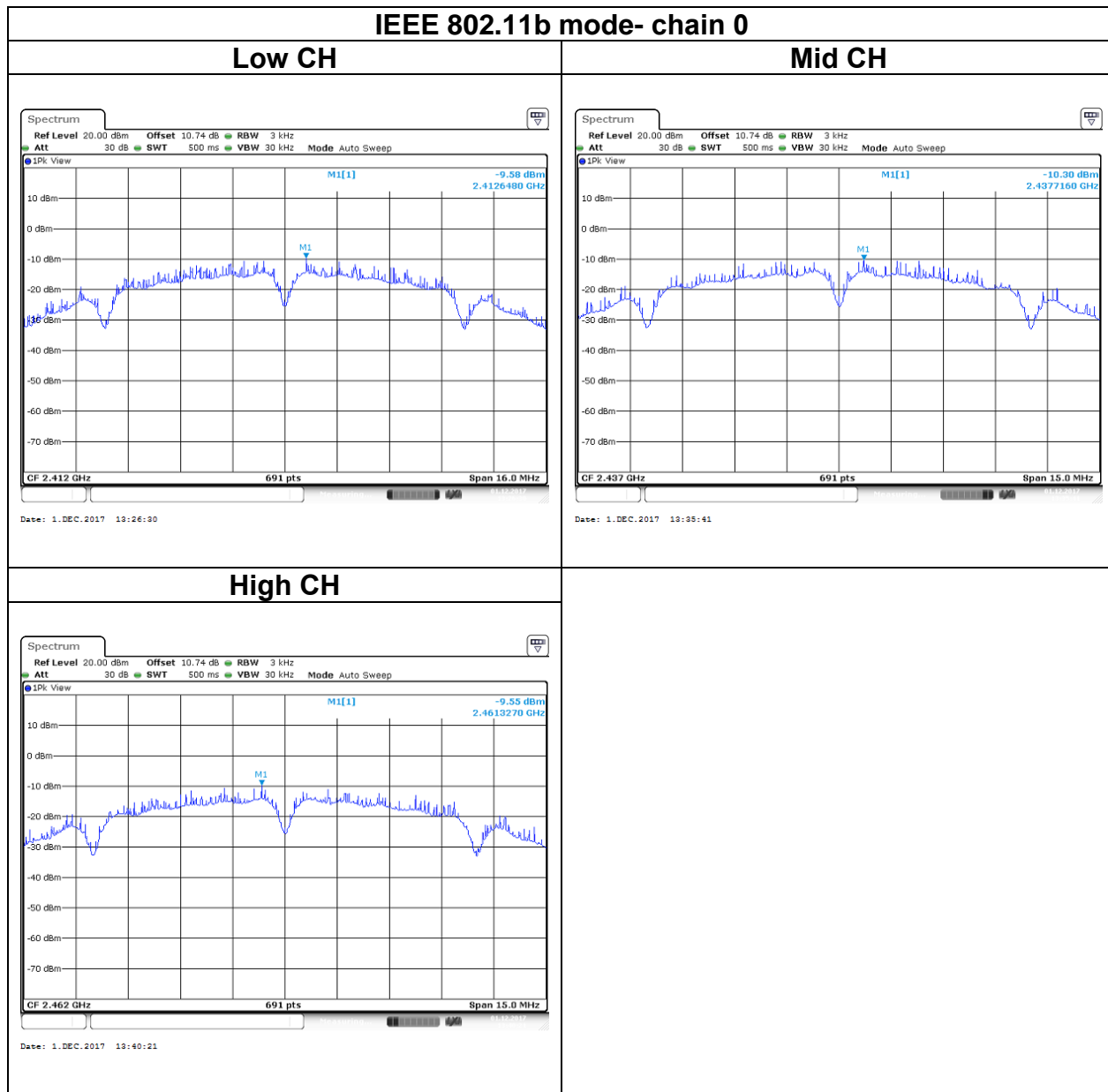

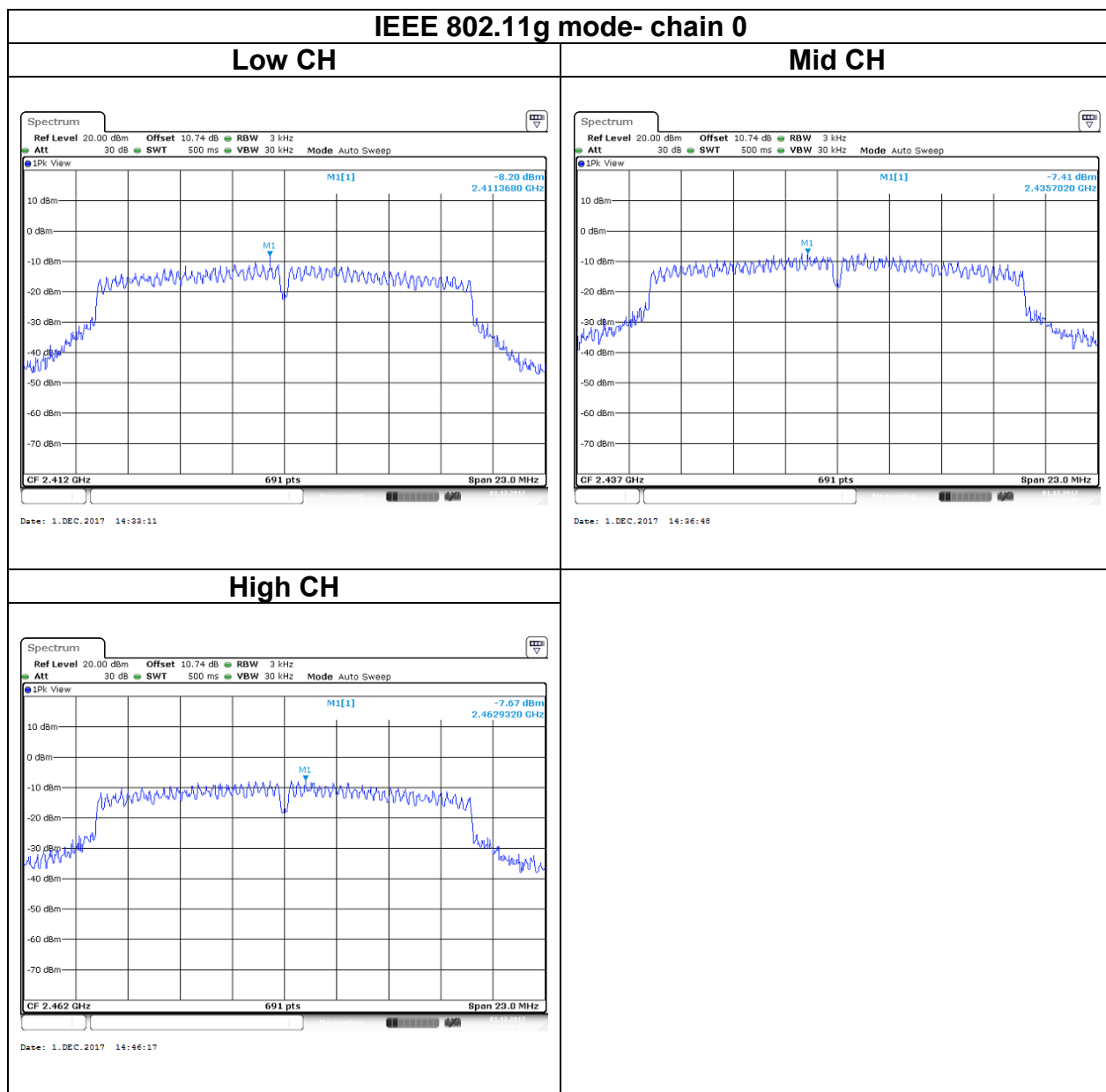

IEEE 802.11n HT20 mode- chain 0

Low CH

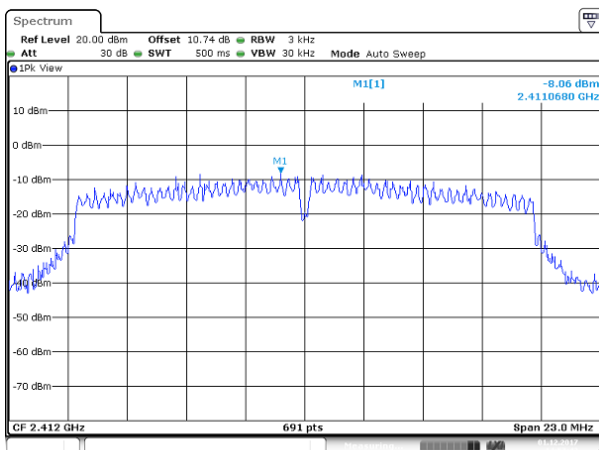

Date: 1.DEC.2017 14:57:44

Mid CH

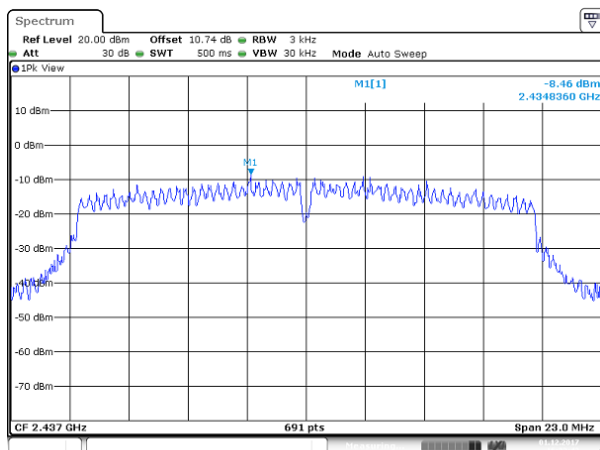

Date: 1.DEC.2017 16:33:43

High CH

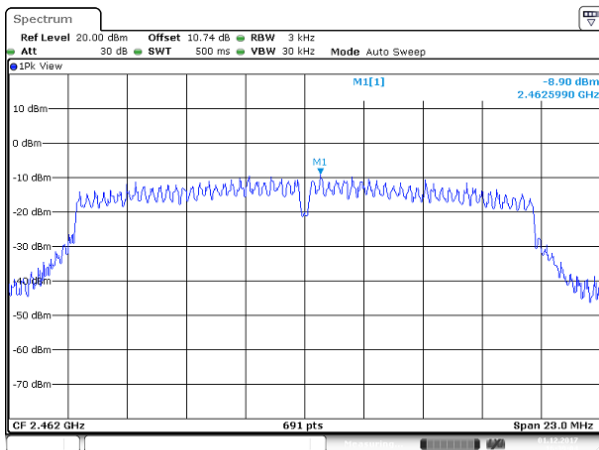

Date: 1.DEC.2017 16:39:05

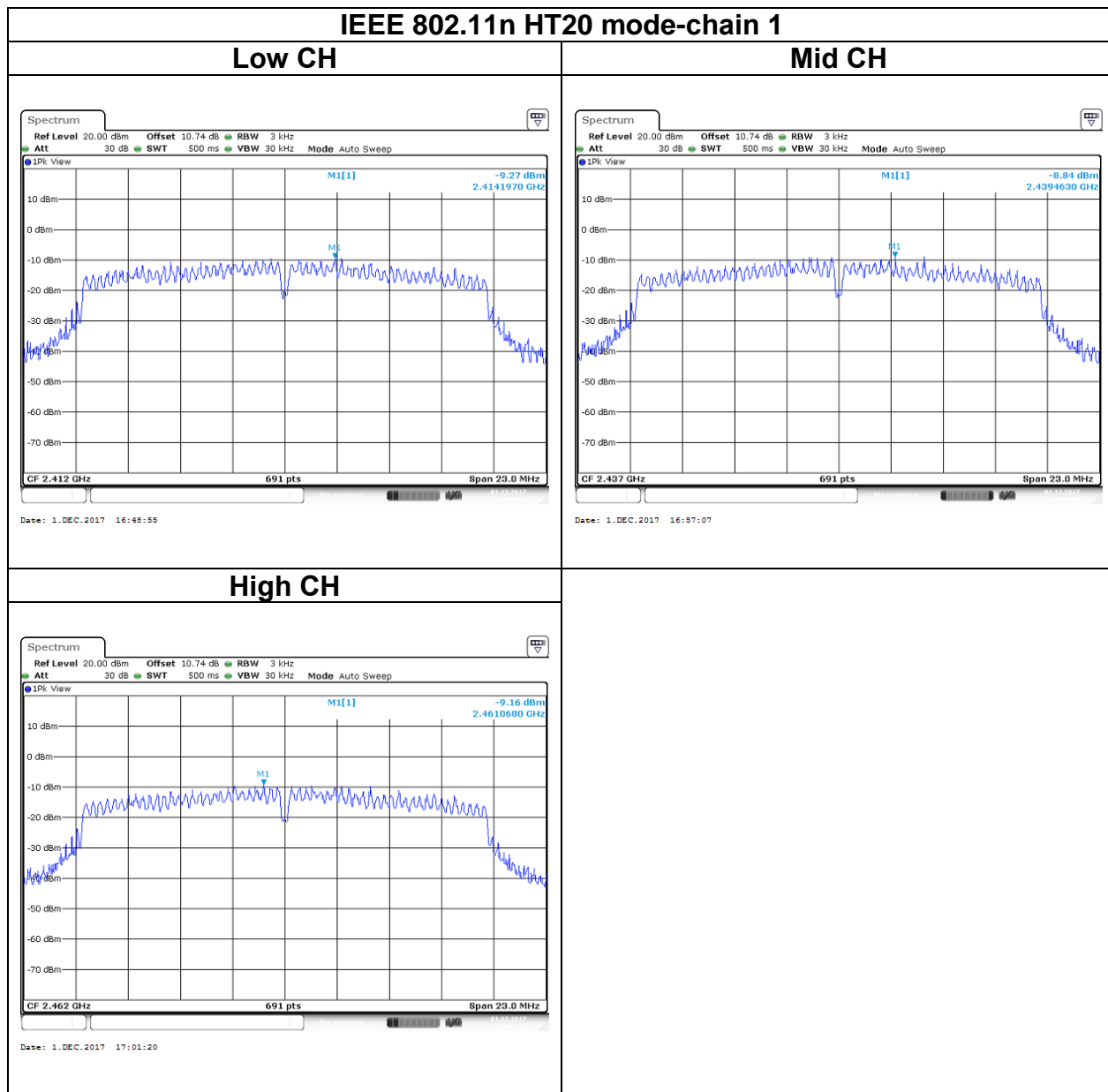

IEEE 802.11n HT40 mode-chain 0

Low CH

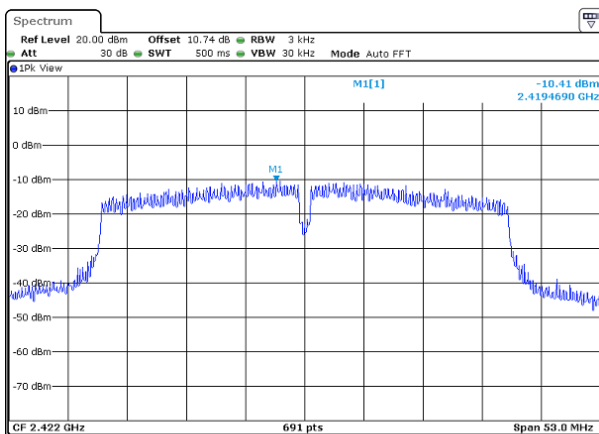

Date: 1.DEC.2017 17:50:49

Mid CH

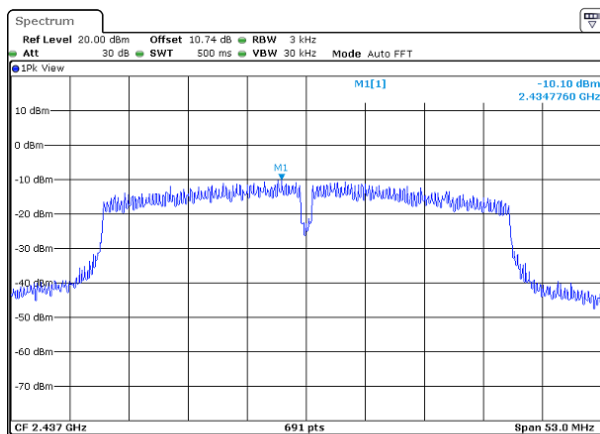

Date: 1.DEC.2017 17:42:00

High CH

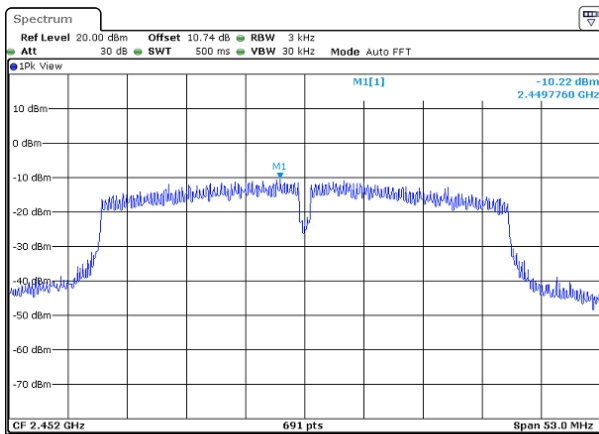

Date: 1.DEC.2017 17:46:31

IEEE 802.11n HT40 mode-chain 1

Low CH

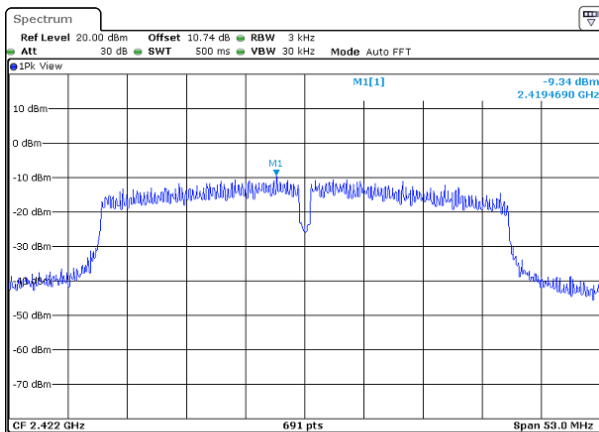

Date: 1.DEC.2017 17:17:22

Mid CH

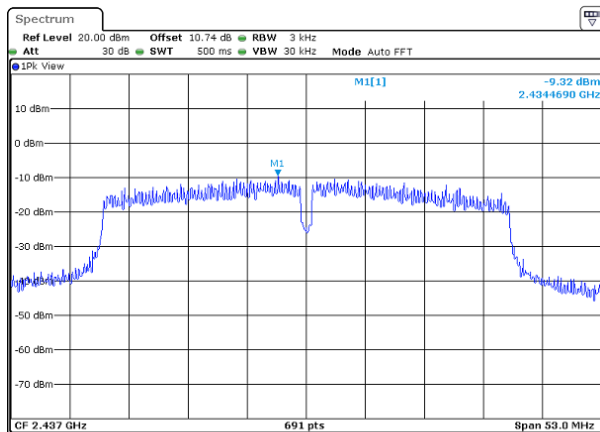

Date: 1.DEC.2017 17:22:21

High CH

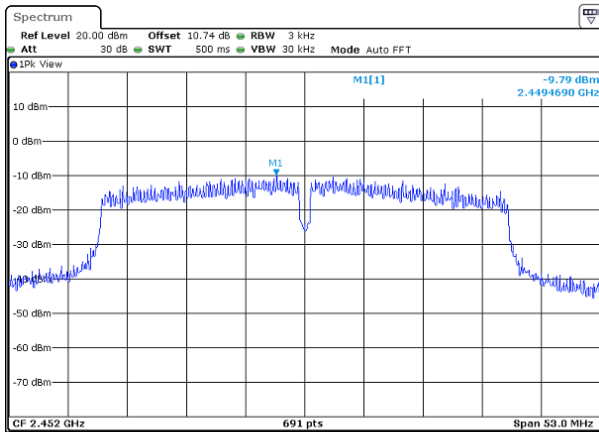

Date: 1.DEC.2017 17:29:03

4.5 CONDUCTED BANDEGE AND SPURIOUS EMISSION

4.5.1 Test Limit

According to §15.247(d) and RSS-247 section 5.5,

In any 100 kHz bandwidth outside the authorized frequency band,

Non-restricted bands shall be attenuated at least 20 dB/30 dB relative to the maximum PSD level in 100 kHz by RF conducted or a radiated measurement which fall in the restricted bands, as defined in §15.205(a), must also comply with the radiated emission limits specified in §15.209(a).

4.5.2 Test Procedure

Test method Refer as KDB 558074 D01 v03r04, Section 11.

1. EUT RF output port connected to the SA by RF cable, and the path loss was compensated to result.
2. SA setting, RBW=100kHz, VBW=300kHz, Detector=Peak, Trace mode = max hold, SWT = Auto.
3. In any 100 kHz bandwidth outside the authorized frequency band, shall be attenuated at least 20 dB relative to the maximum in-band peak PSD level in 100 kHz when conducted power procedure is used. f the transmitter complies with the conducted power limits based on the use of RMS averaging over a time interval, the attenuation required under this paragraph shall be 30 dB instead of 20 dB.

4.5.3 Test Setup

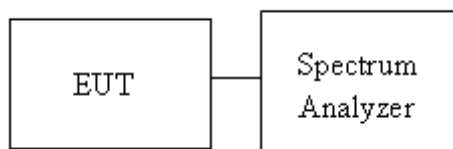

4.5.4 Test Result

Test Data

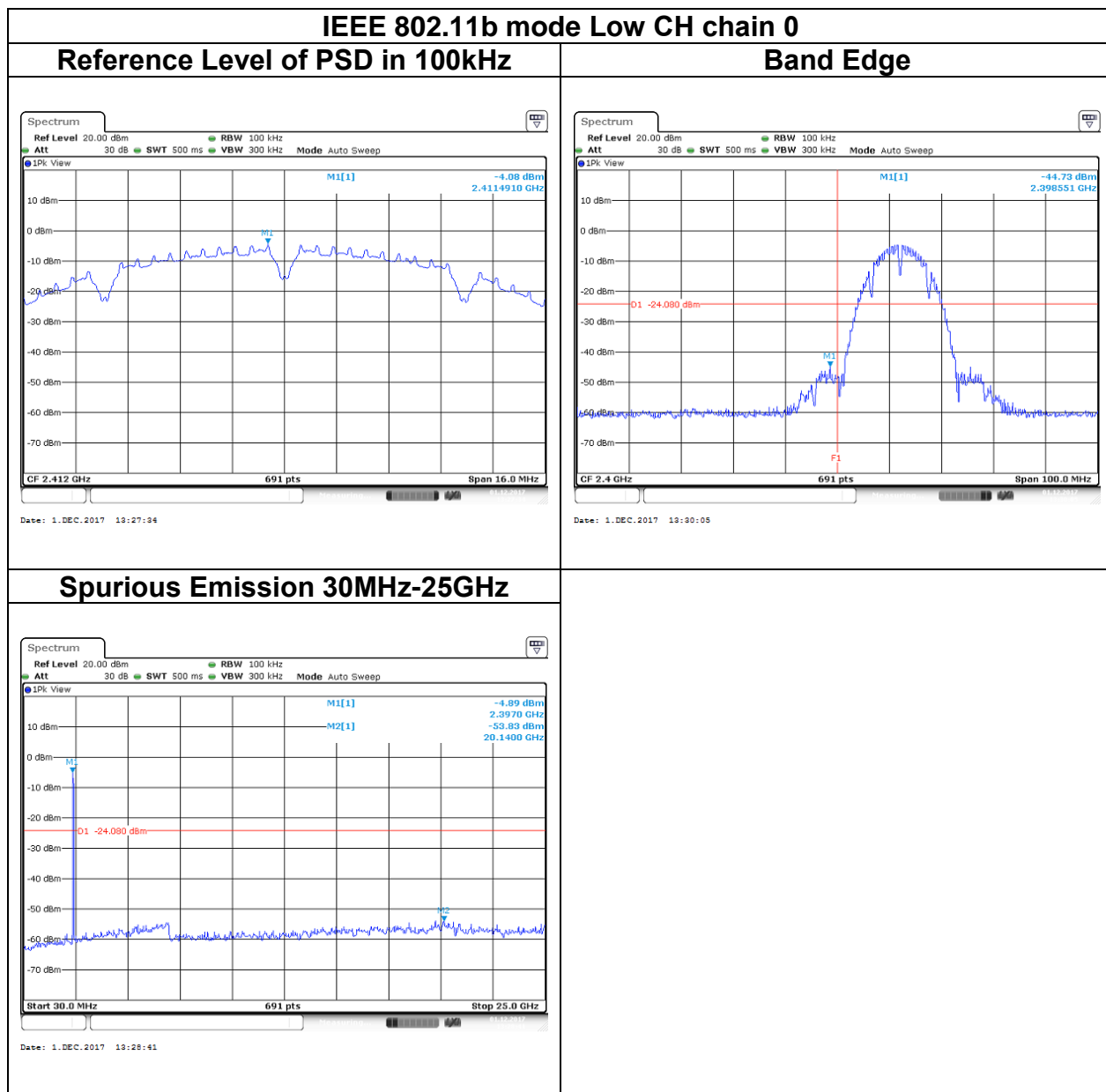

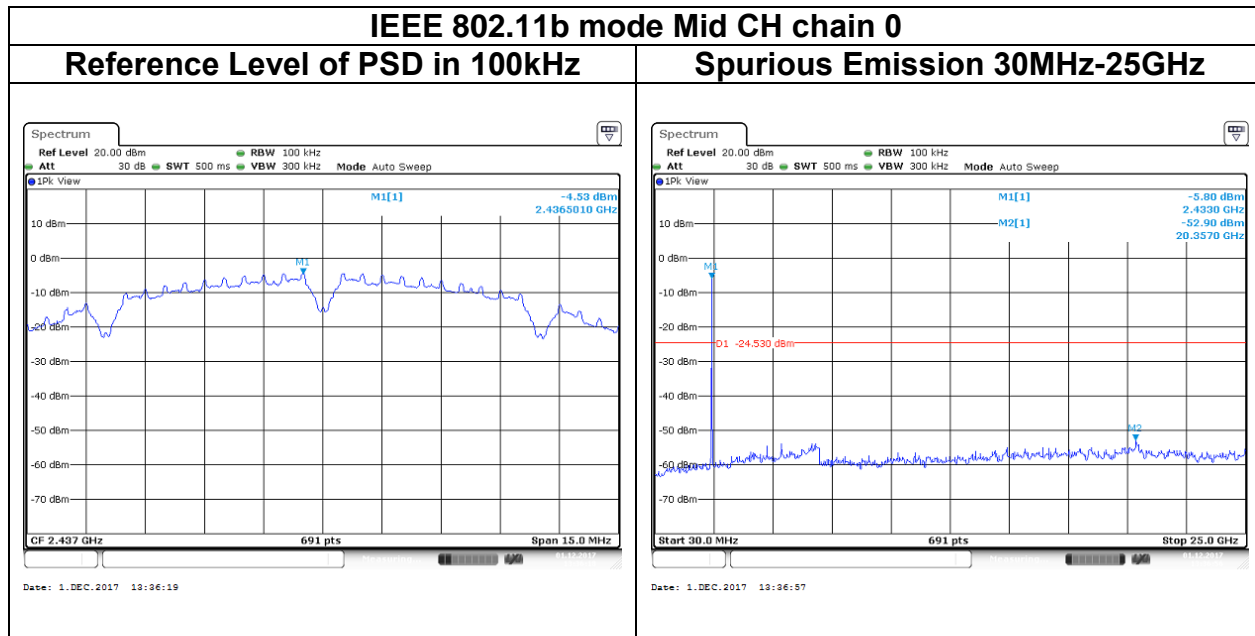

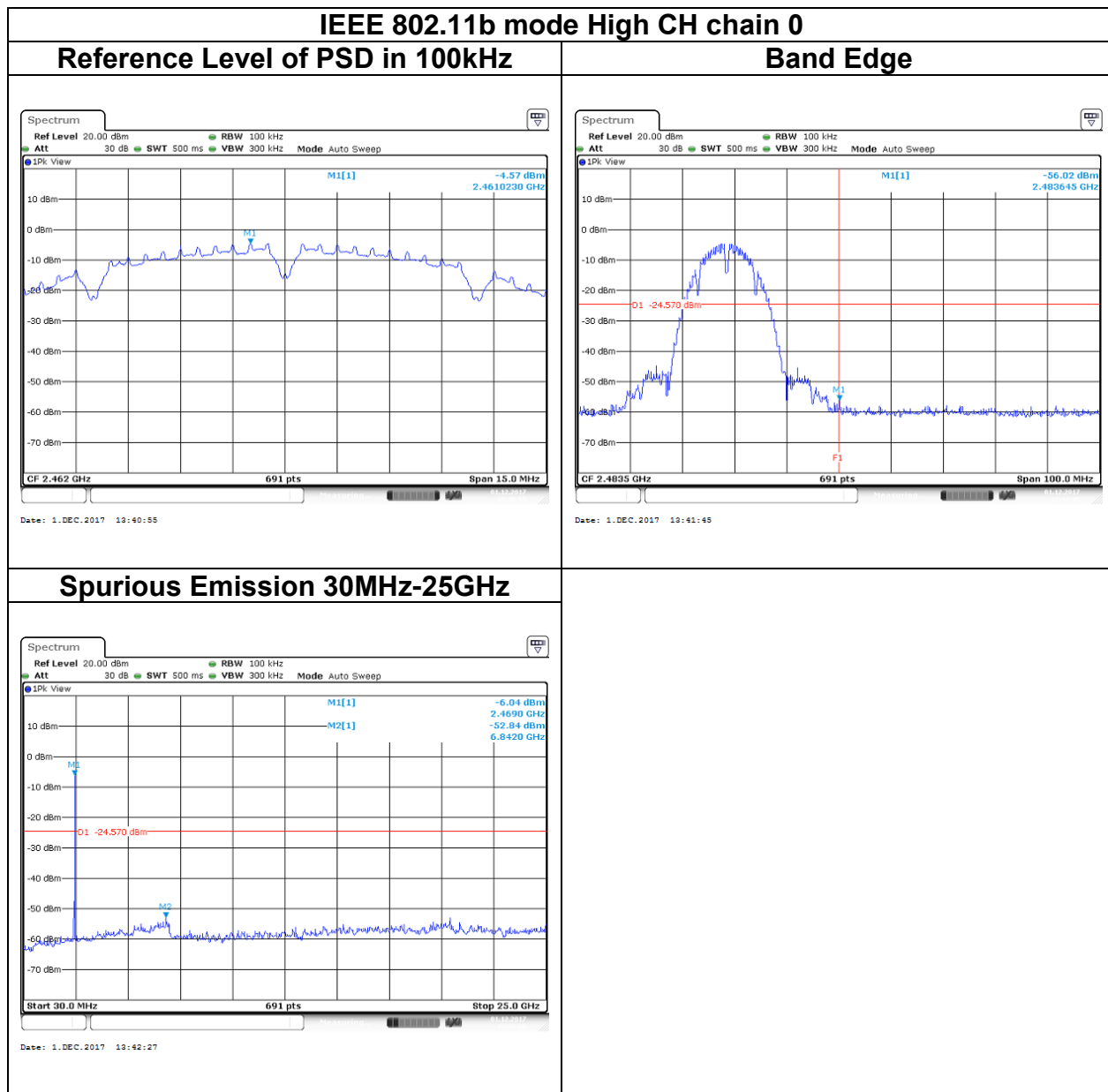

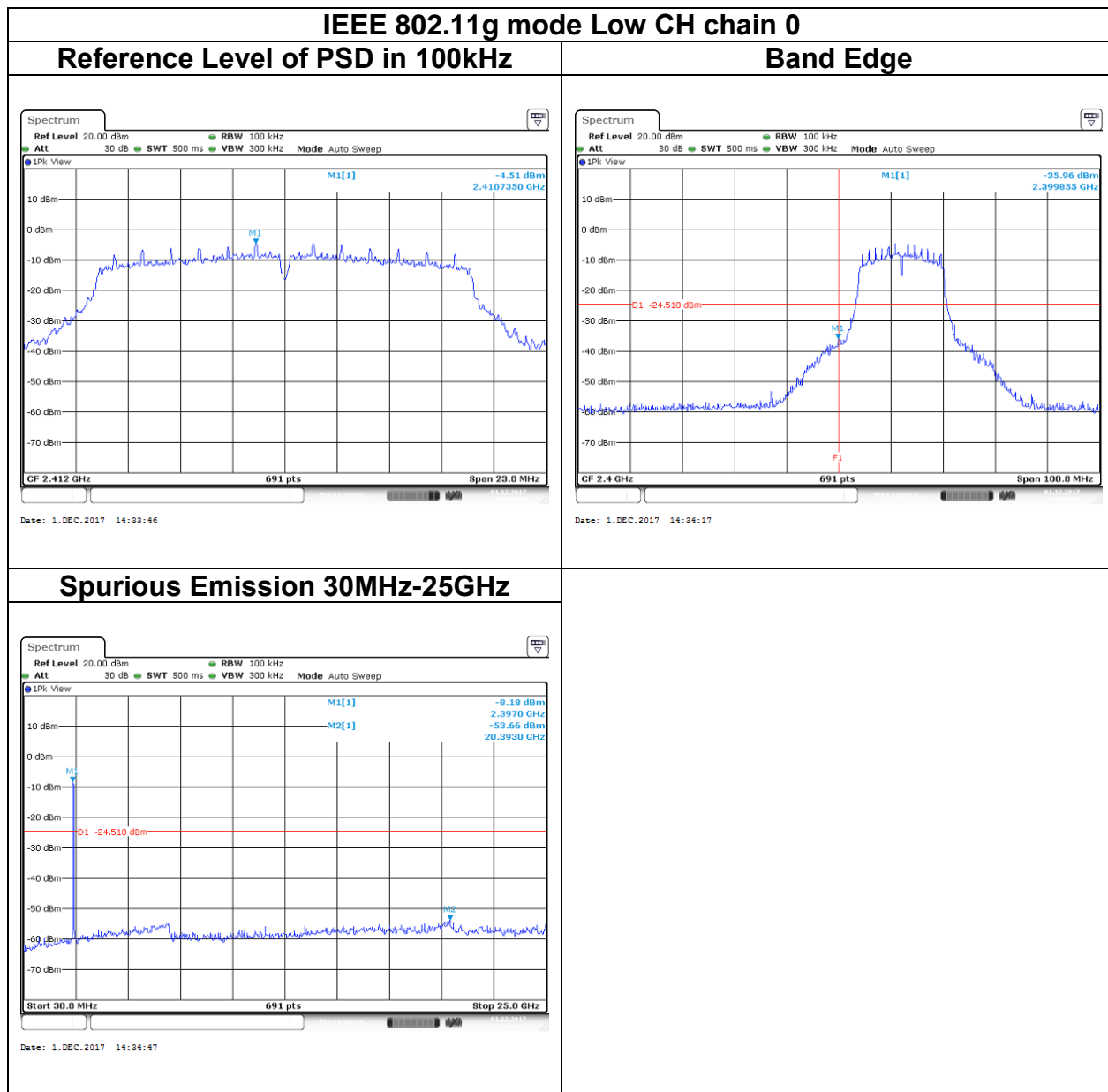

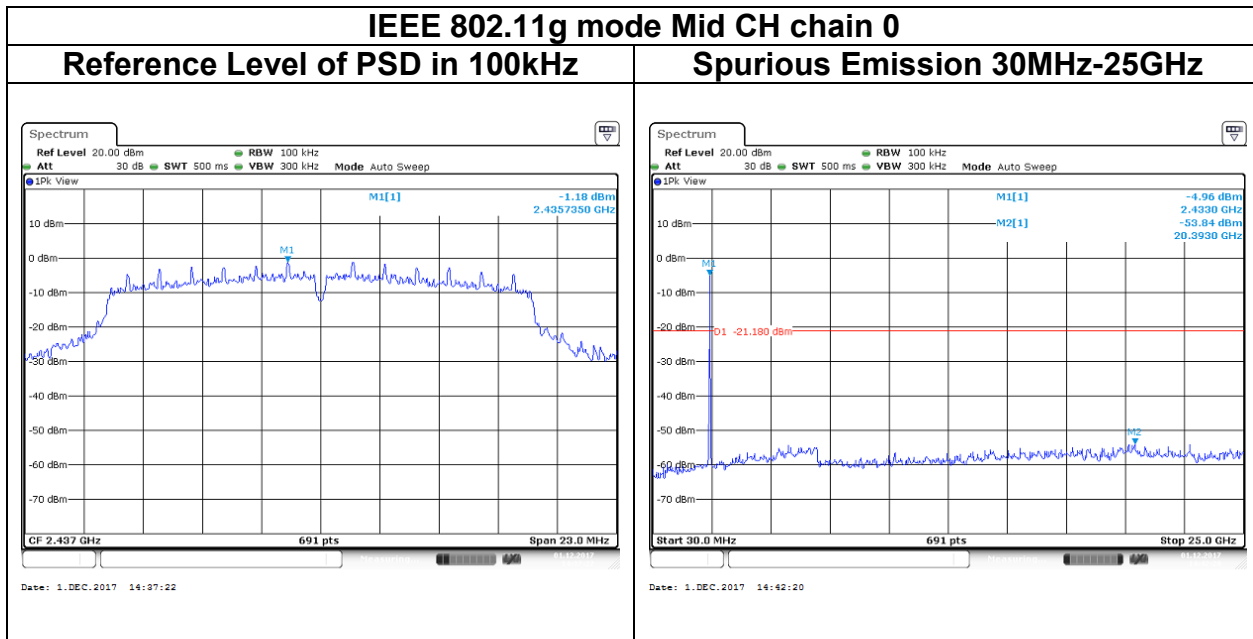

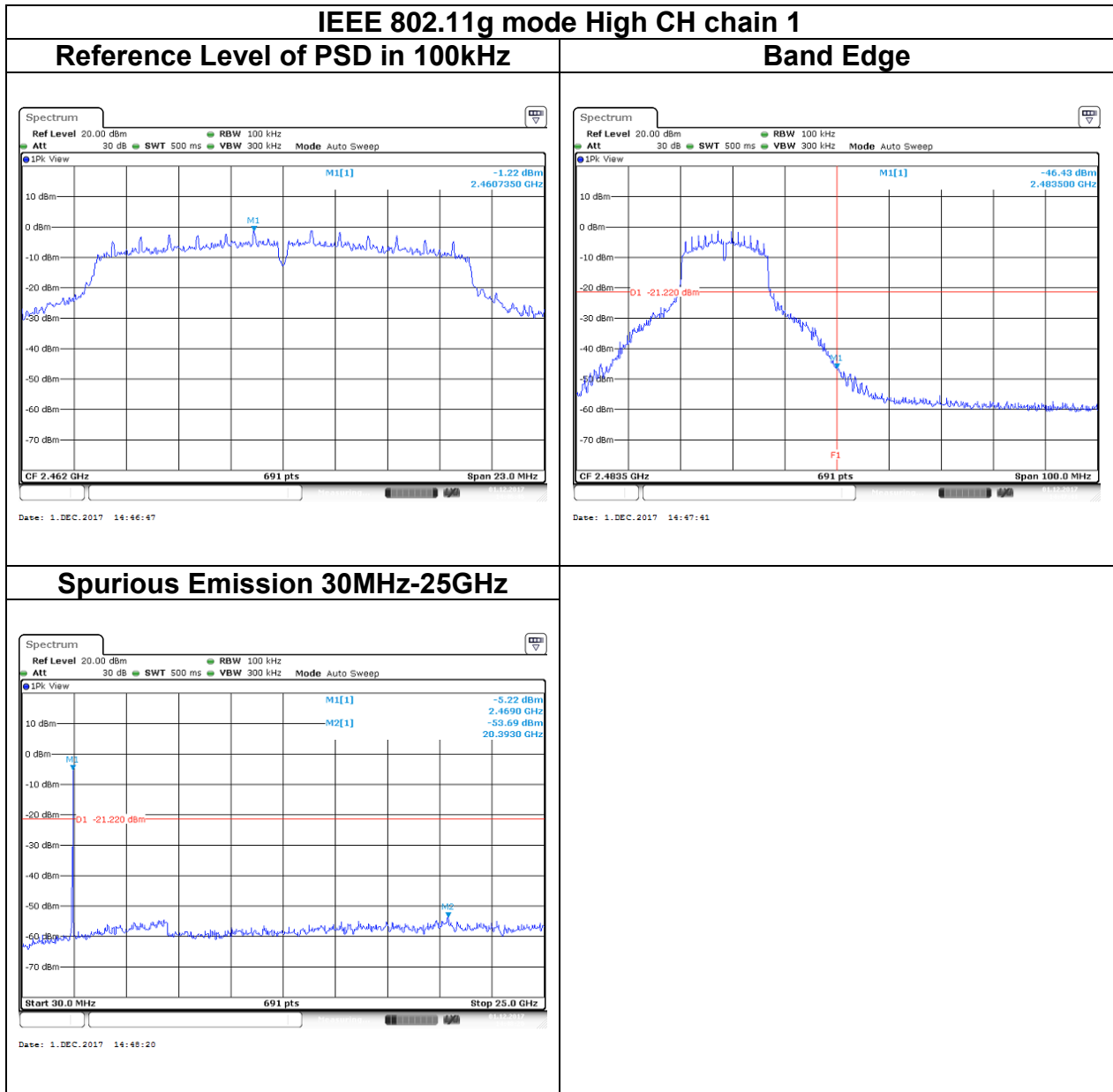

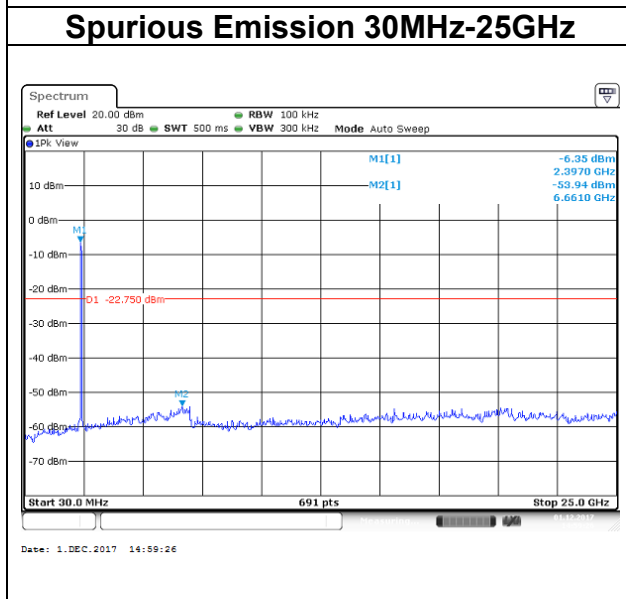
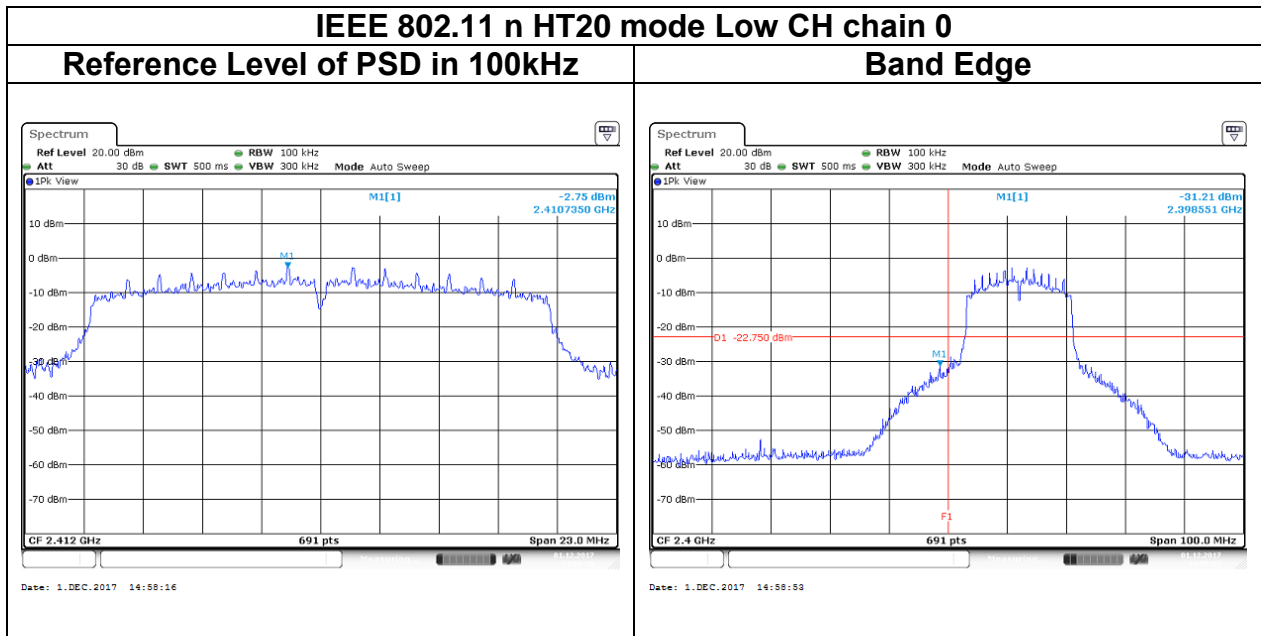

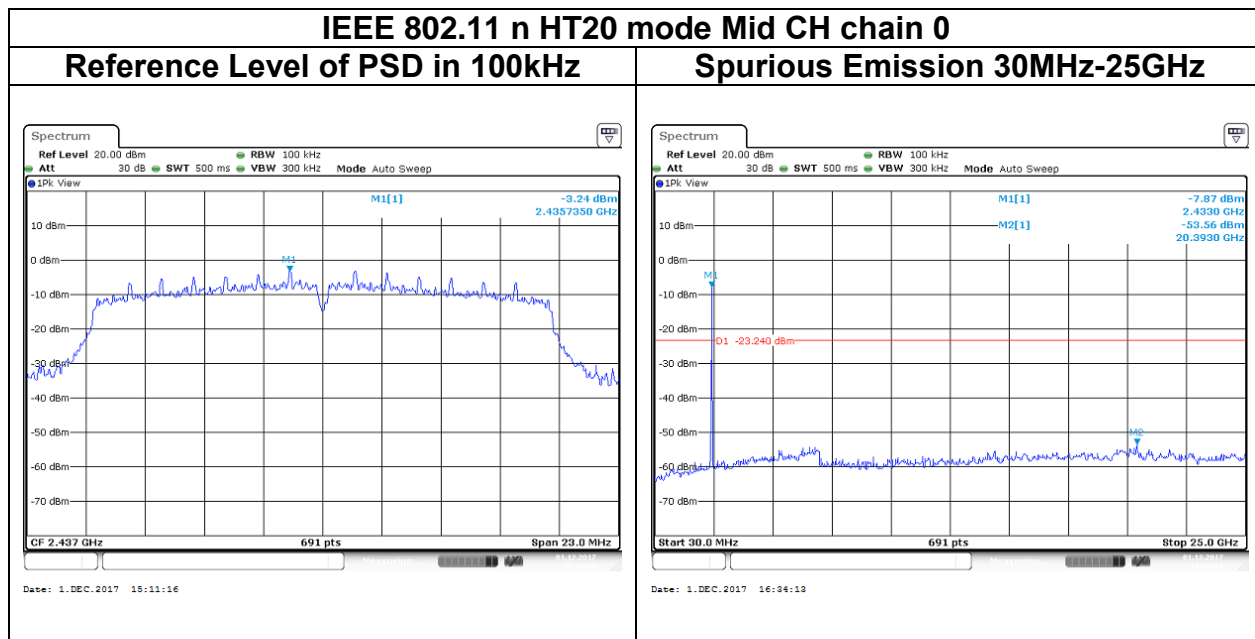

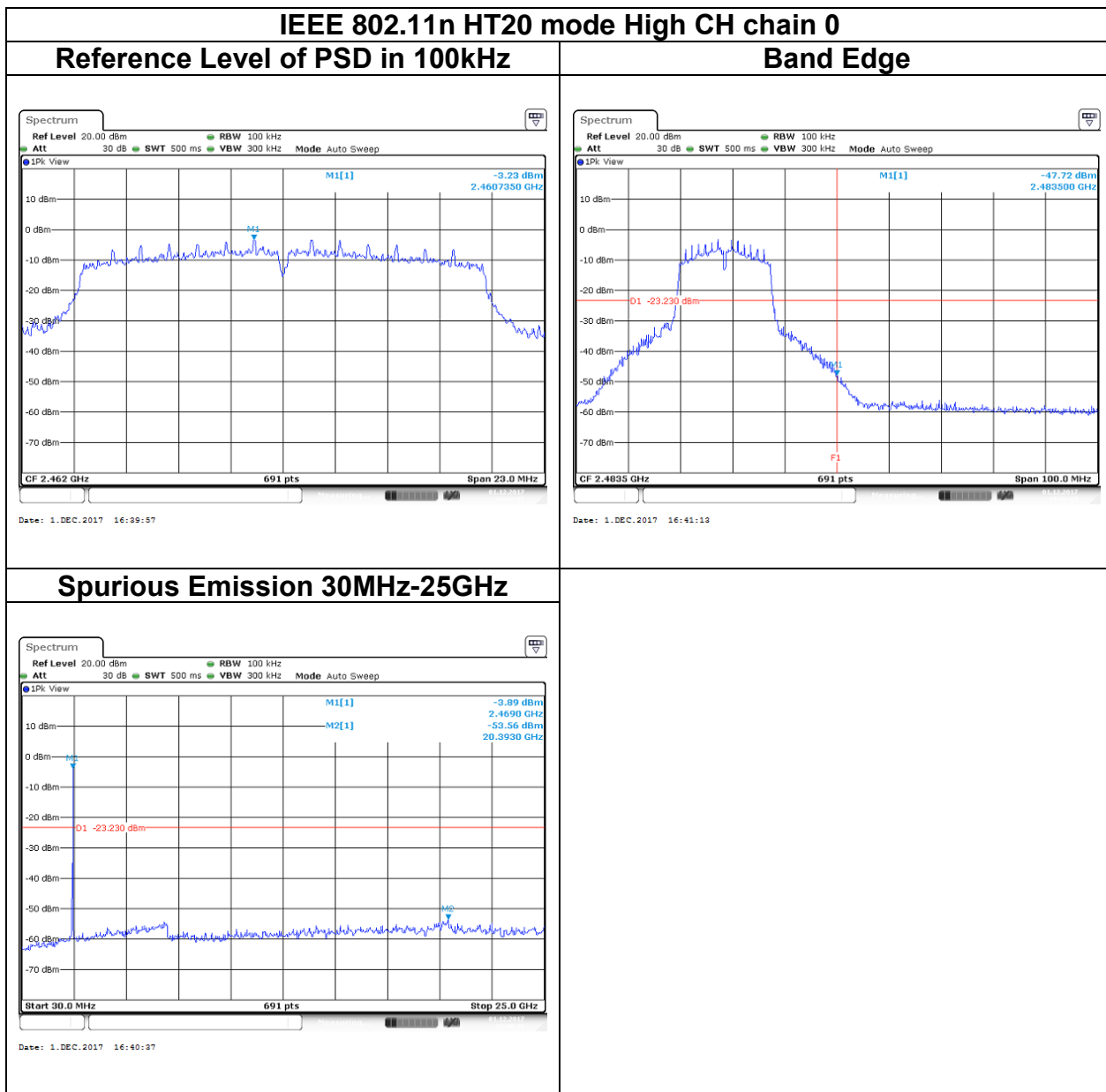

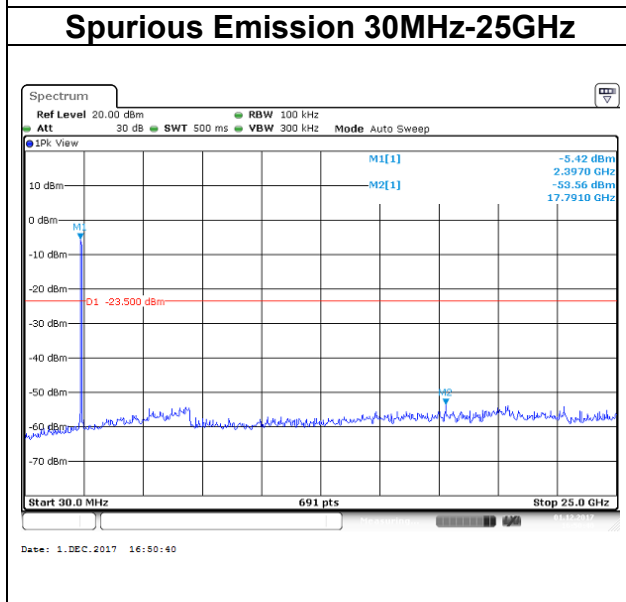
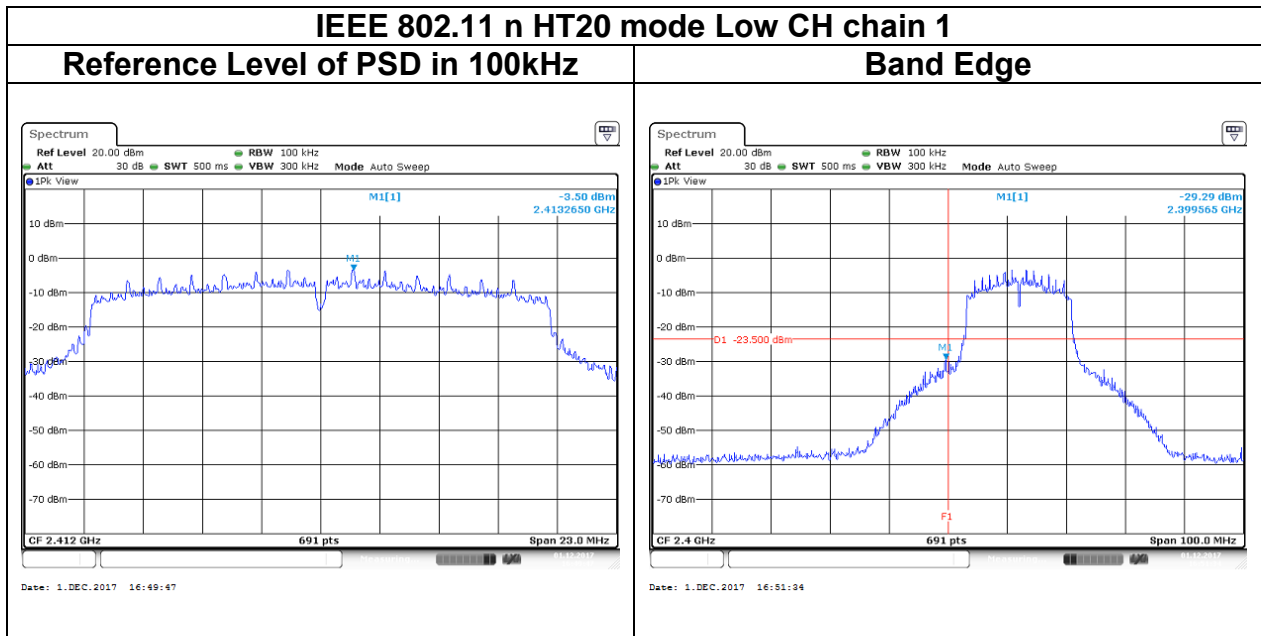

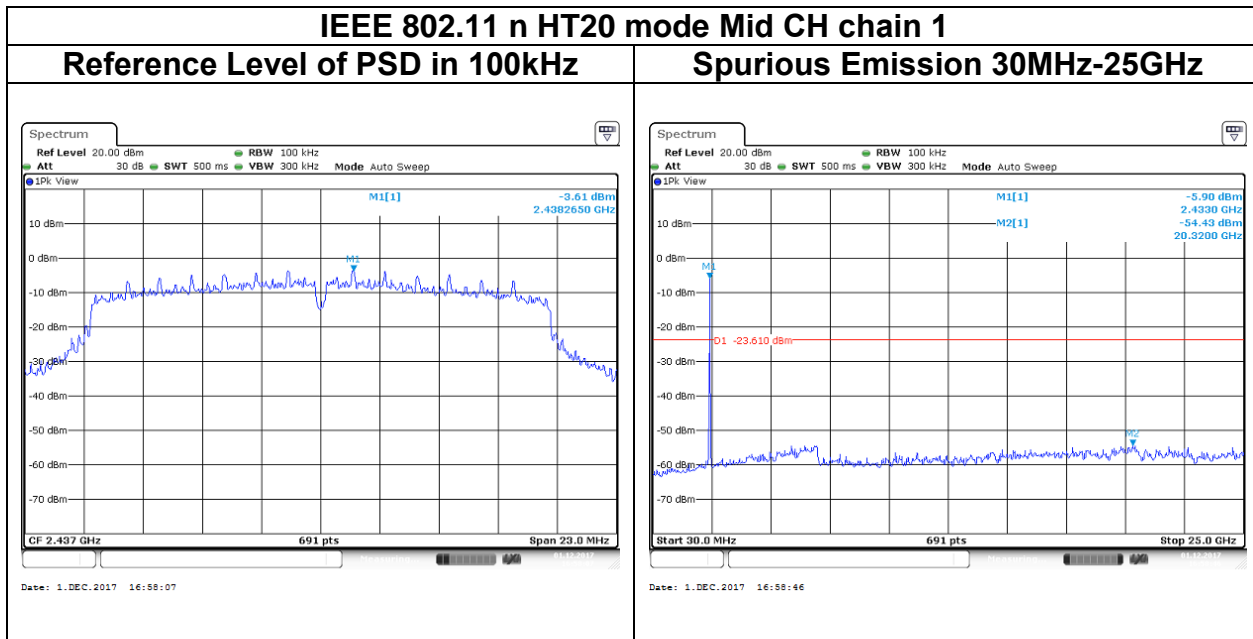

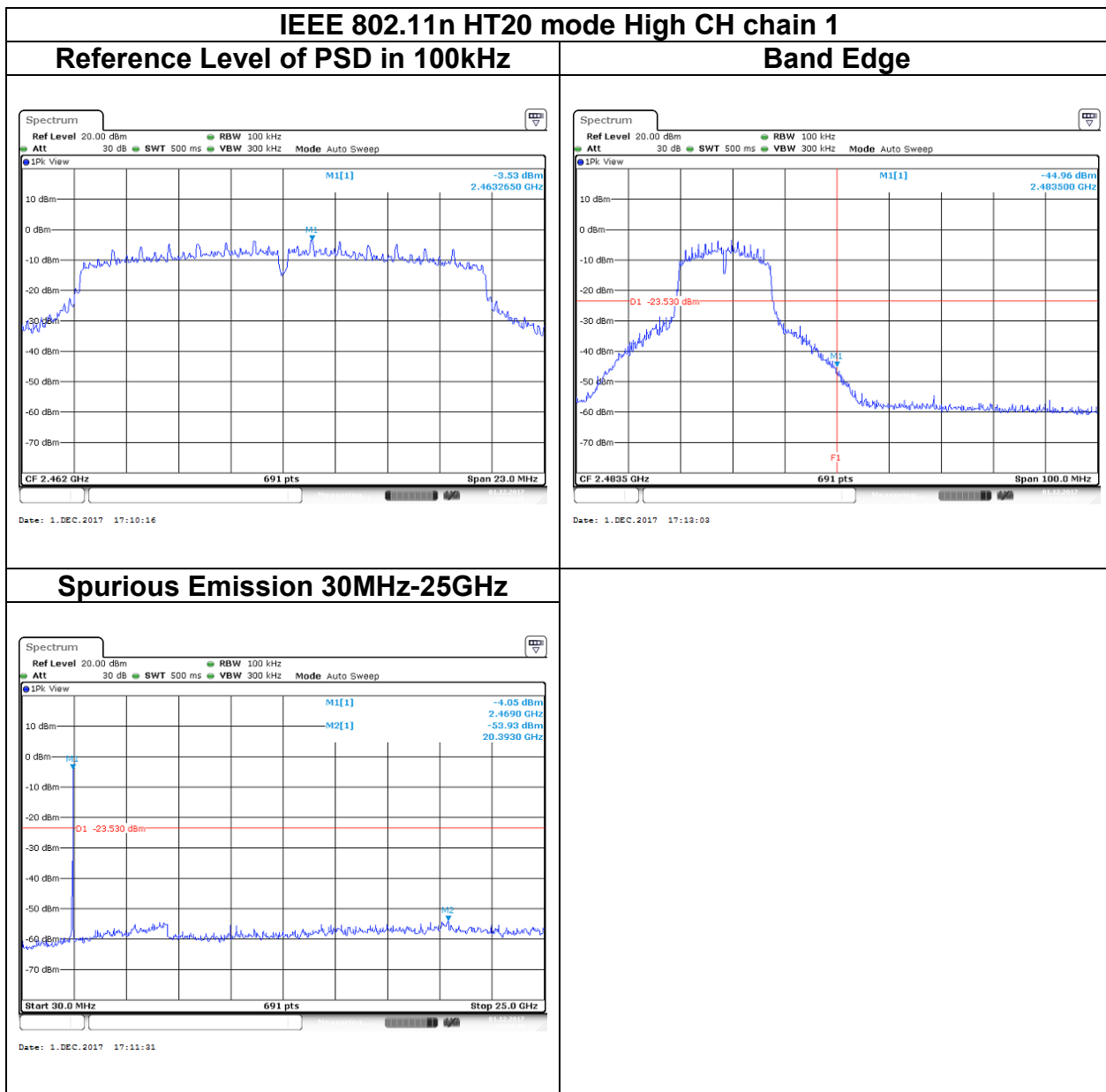

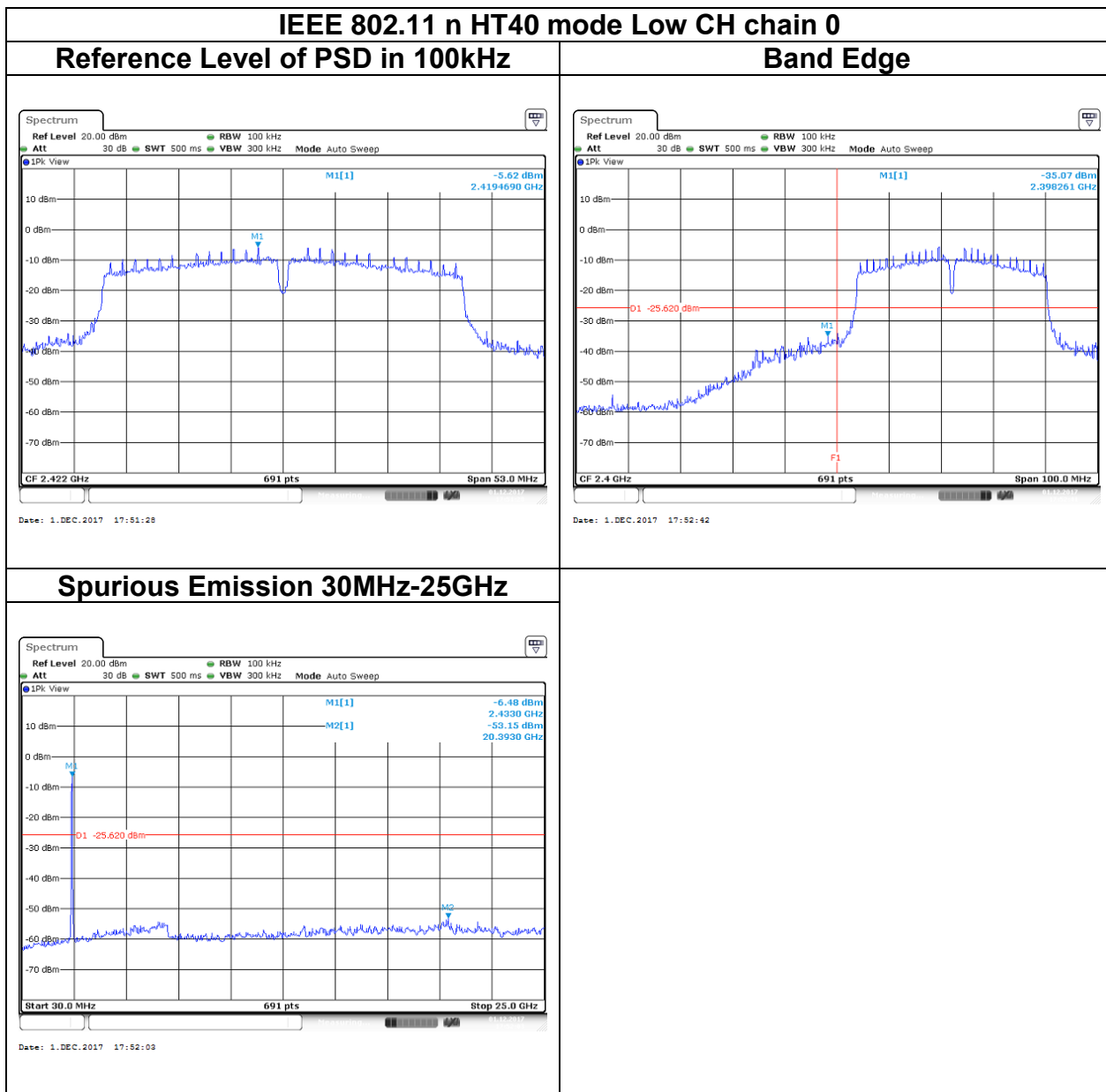

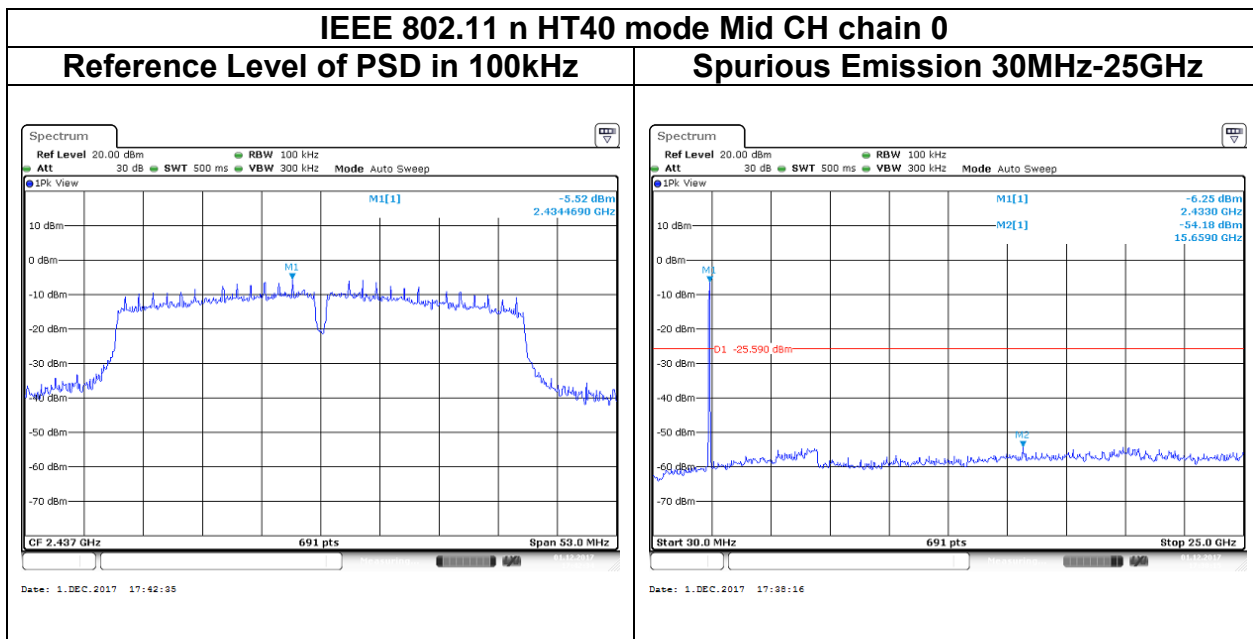

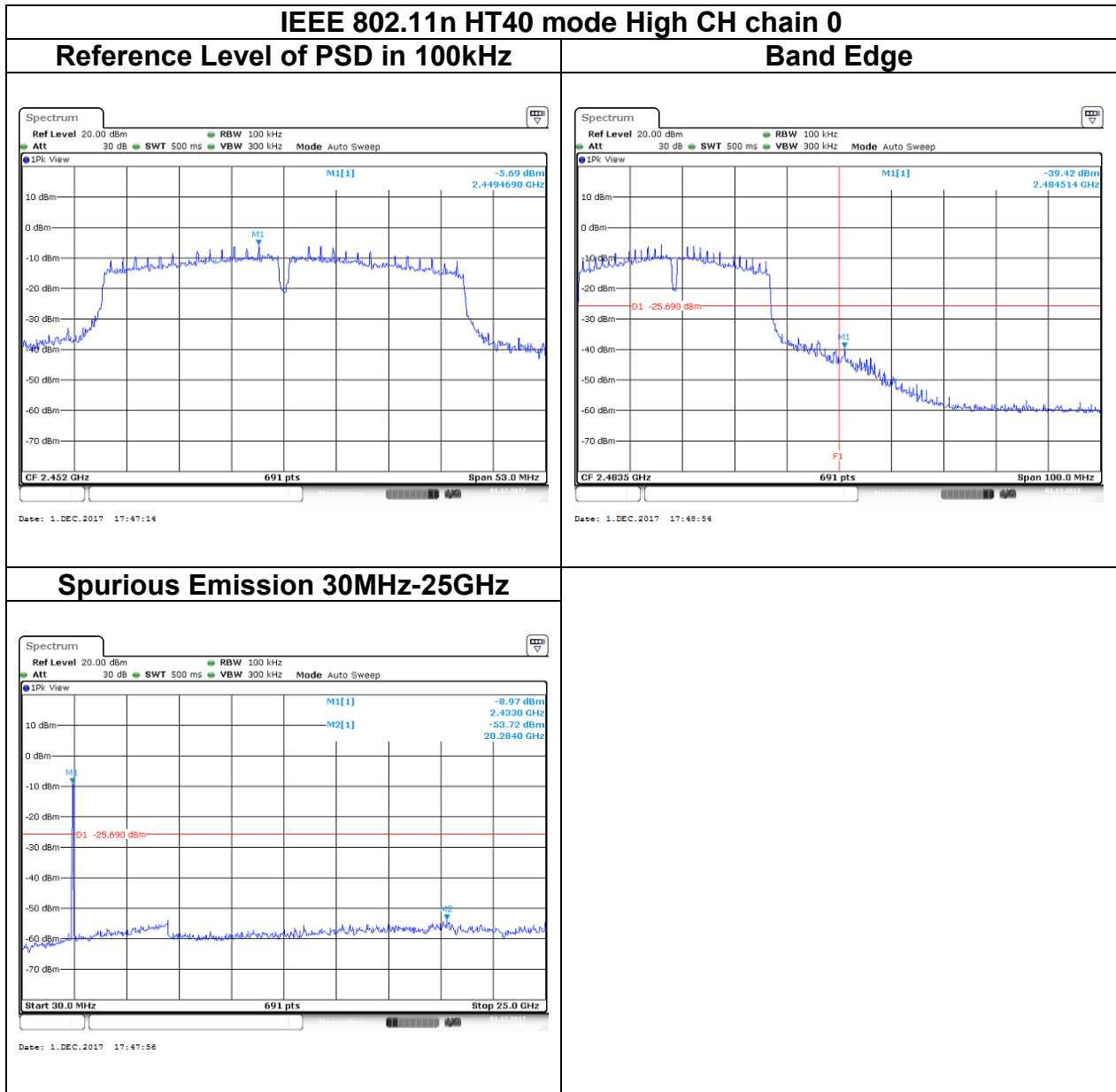

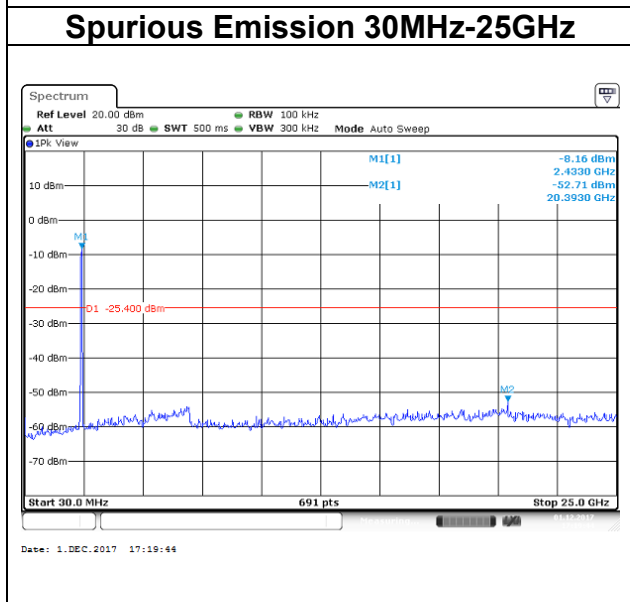
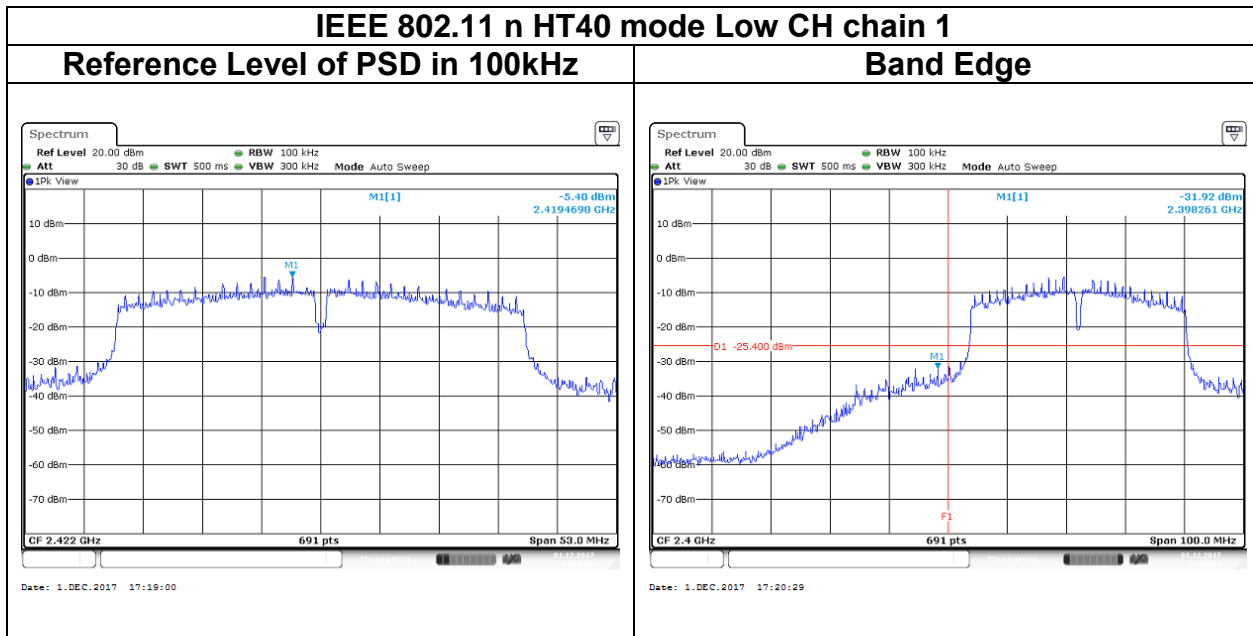

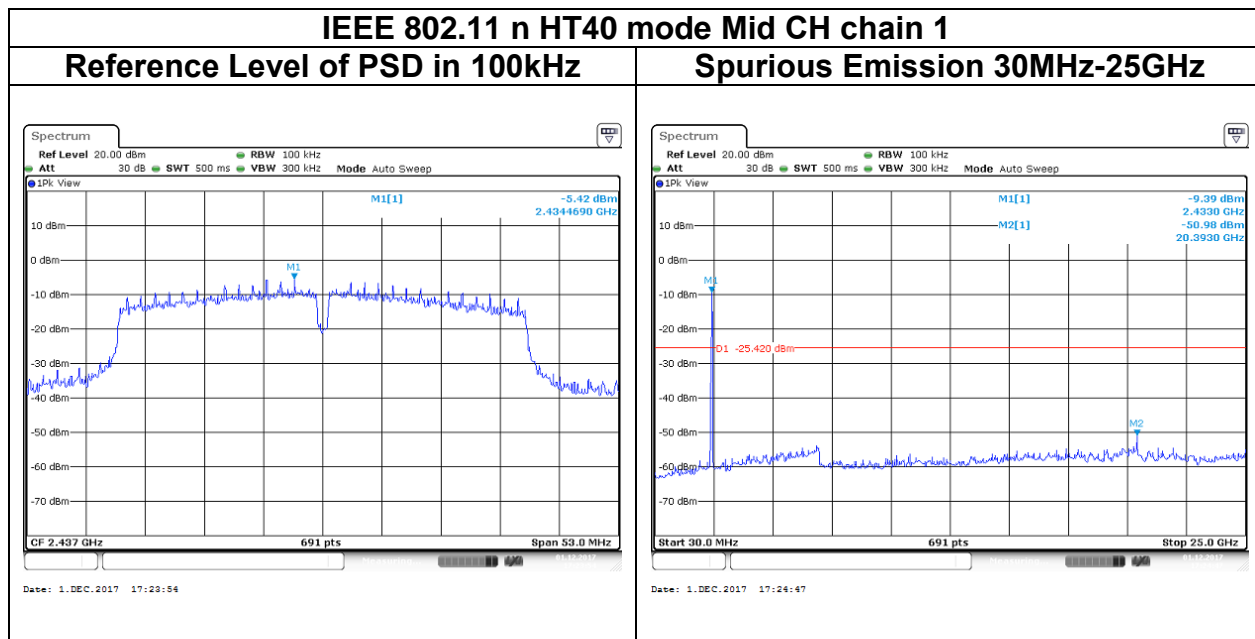

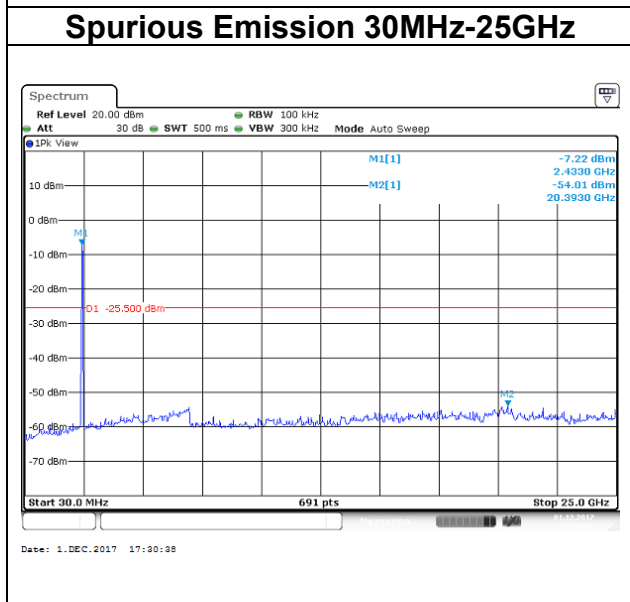
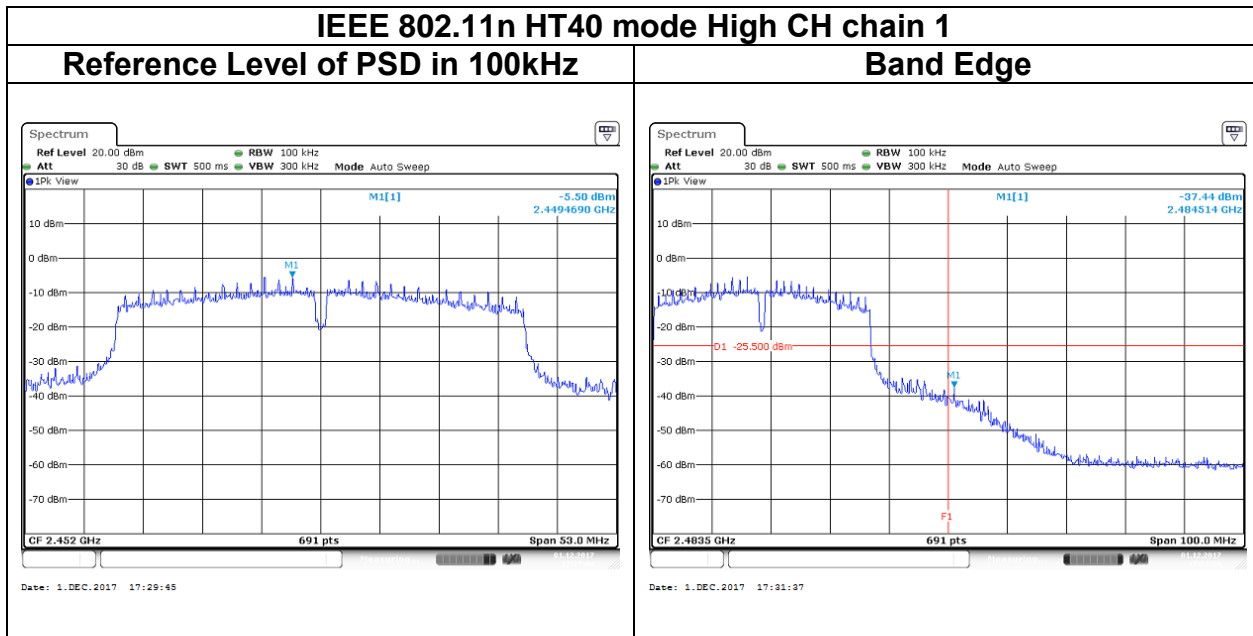

4.6 RADIATION BANDEDGE AND SPURIOUS EMISSION

4.6.1 Test Limit

FCC according to §15.247(d), §15.209 and §15.205,

IC according to RSS-247 section 5.5, RSS-Gen, Section 8.9 and 8.10

In any 100 kHz bandwidth outside the authorized frequency band, all harmonic and spurious must be least 20 dB below the highest emission level with the authorized frequency band. Radiation emission which fall in the restricted bands must also follow the FCC section 15.209 as below limit in table.

Below 30 MHz

Frequency	Field Strength (microvolts/m)	Magnetic H-Field (microamperes/m)	Measurement Distance (metres)
9-490 kHz	2,400/F (F in kHz)	2,400/F (F in kHz)	300
490-1,705 kHz	24,000/F (F in kHz)	24,000/F (F in kHz)	30
1.705-30 MHz	30	N/A	30

Above 30 MHz

Frequency	Field Strength (microvolts/m)	Measurement Distance (metres)
30-88	100	3
88-216	150	3
216-960	200	3
Above 960	500	3

4.6.2 Test Procedure

Test method Refer as KDB 558074 D01 v03r04, Section 12.1.

1. The EUT is placed on a turntable, Above 1 GHz is 1.5m and below 1 GHz is 0.8m above ground plane. The EUT Configured un accordance with ANSI C63.10, and the EUT set in a continuous mode.
2. The turntable shall be rotated for 360 degrees to determine the position of maximum emission level. And EUT is set 3m away from the receiving antenna, which is scanned from 1m to 4m above the ground plane to find out the highest emissions. Measurement are made polarized in both the vertical and the horizontal positions with antenna.
3. Span shall wide enough to full capture the emission measured. The SA from 30MHz to 26.5GHz set to the low, Mid and High channels with the EUT transmit.
5. The SA setting following :
 - (1) Below 1G : RBW = 100kHz, VBW \geq 3 RBW, Sweep = Auto, Detector = Peak, Trace = Max hold.
 - (2) Above 1G :
 - (2.1) For Peak measurement : RBW = 1MHz, VBW \geq 3 RBW, Sweep = Auto, Detector = Peak, Trace = Max hold.
 - (2.2) For Average measurement : RBW = 1MHz, VBW
 - If Duty Cycle \geq 98%, VBW=10Hz.
 - If Duty Cycle < 98%, VBW=1/T.

Configuration	Duty Cycle (%)	VBW
802.11b	93%	1KHz
802.11g	94%	750Hz
802.11n HT20	88%	1.6KHz
802.11n HT40	72%	5.6KHz

4.6.3 Test Setup

9kHz ~ 30MHz

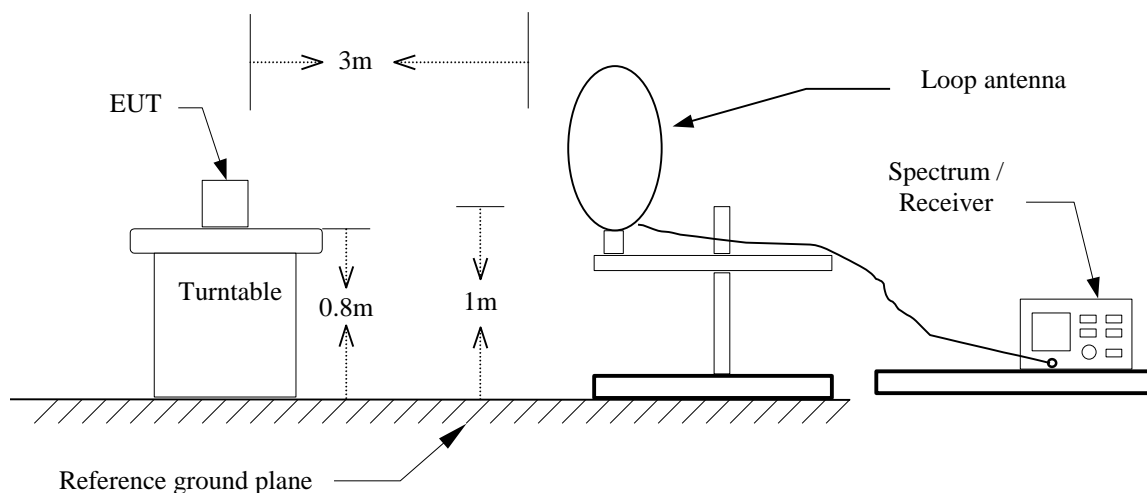

30MHz ~ 1GHz

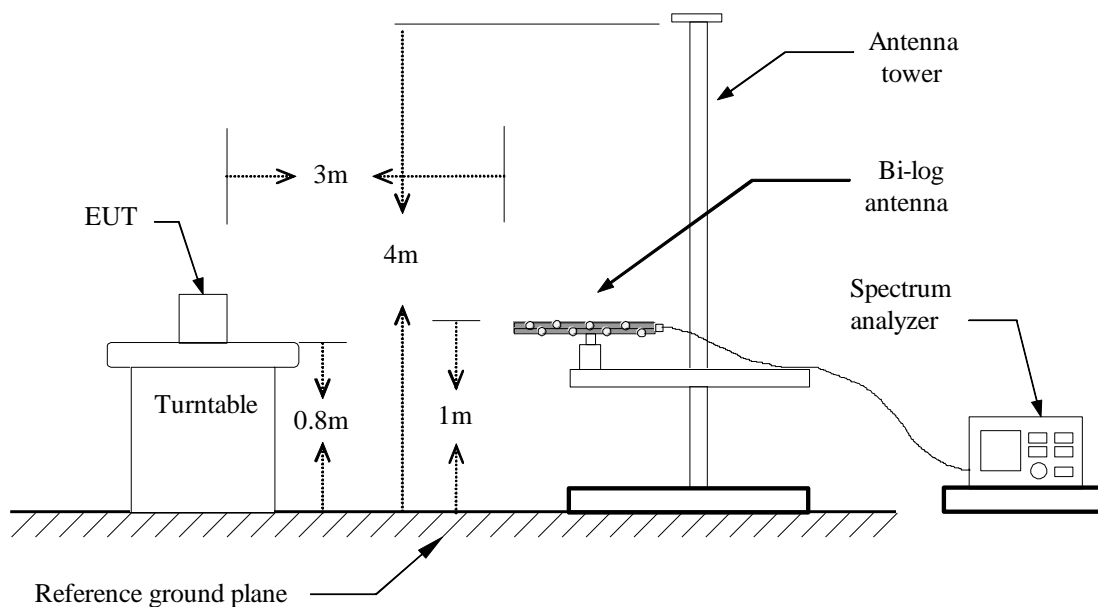

Above 1 GHz

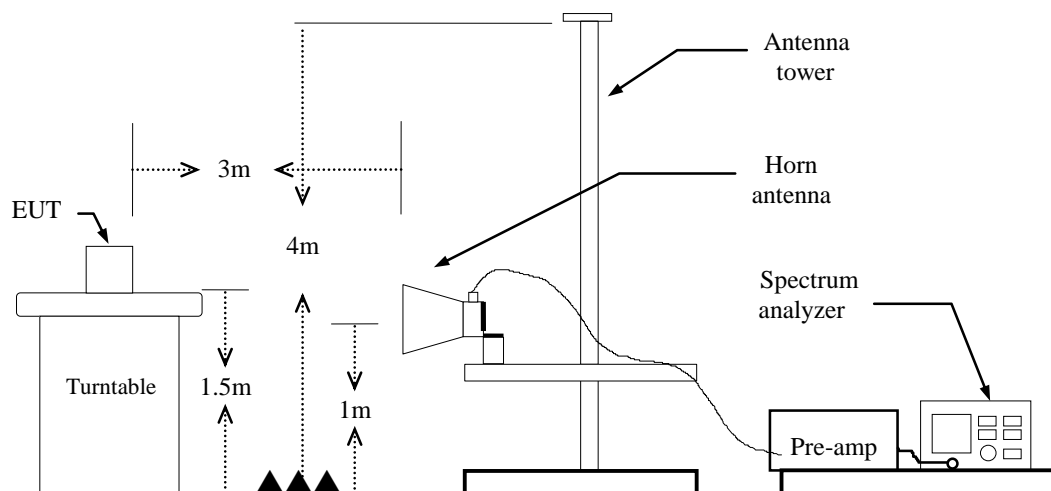

4.6.4 Test Result

Band Edge Test Data

Test Mode	IEEE 802.11b Low CH	Temp/Hum	24(°C)/ 33%RH
Test Item	Band Edge	Test Date	December 7, 2017
Polarize	Horizontal	Test Engineer	Jerry Chuang
Detector	Peak	Test Voltage	120Vac / 60Hz

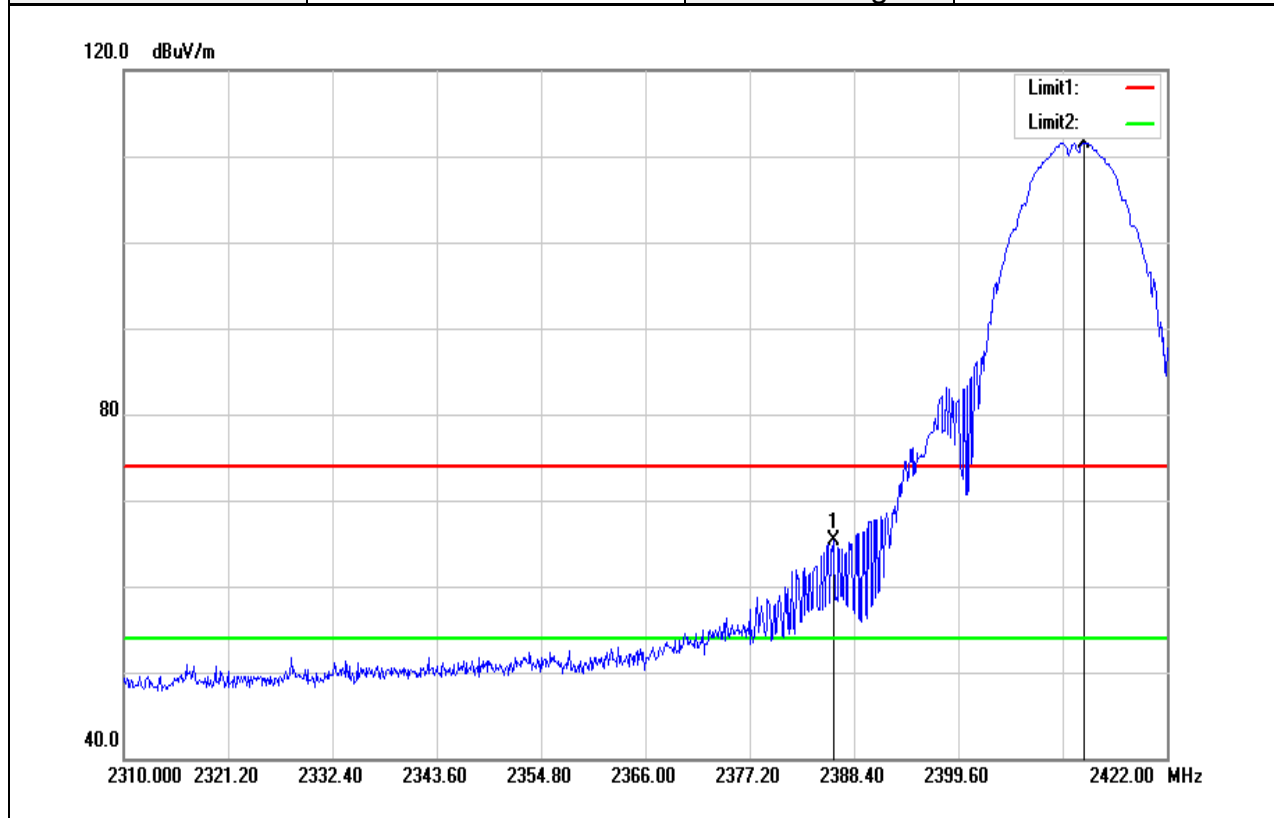

No.	Frequency (MHz)	Reading (dBuV)	Correct Factor(dB/m)	Result (dBuV/m)	Limit (dBuV/m)	Margin (dB)	Remark
1	2386.160	68.24	-2.99	65.25	74.00	-8.75	peak
2	2413.152	114.42	-2.90	111.52	-	-	peak

Test Mode	IEEE 802.11b Low CH	Temperature:	24(°C) / 33%RH
Test Item	Band Edge	Test Date	December 7, 2017
Polarize	Horizontal	Test Engineer	Jerry Chuang
Detector	Average	Test Voltage	120Vac / 60Hz

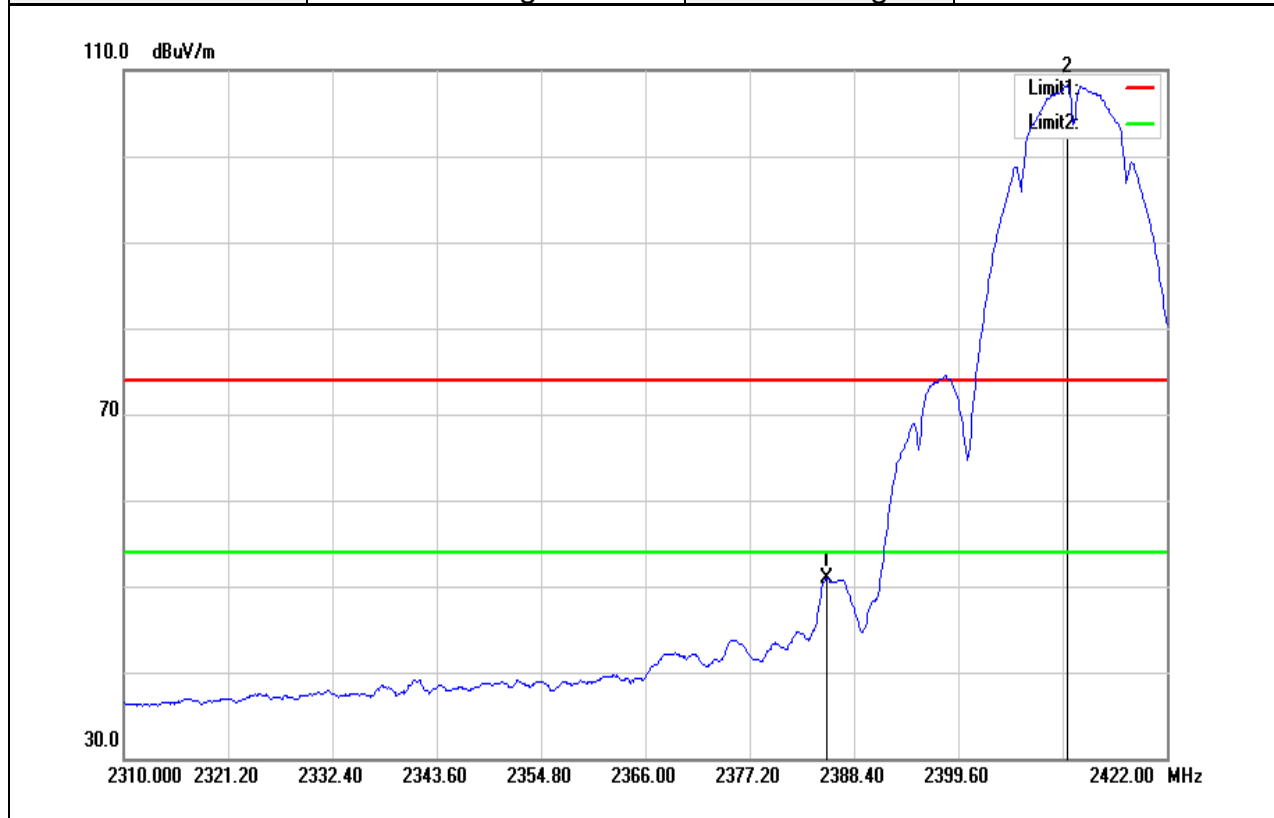

No.	Frequency (MHz)	Reading (dBuV)	Correct Factor(dB/m)	Result (dBuV/m)	Limit (dBuV/m)	Margin (dB)	Remark
1	2385.488	53.83	-2.99	50.84	54.00	-3.16	AVG
2	2411.248	111.13	-2.92	108.21	-	-	AVG

Test Mode	IEEE 802.11b High CH	Temp/Hum	24(°C)/ 33%RH
Test Item	Band Edge	Test Date	December 7, 2017
Polarize	Horizontal	Test Engineer	Jerry Chuang
Detector	Peak	Test Voltage	120Vac / 60Hz

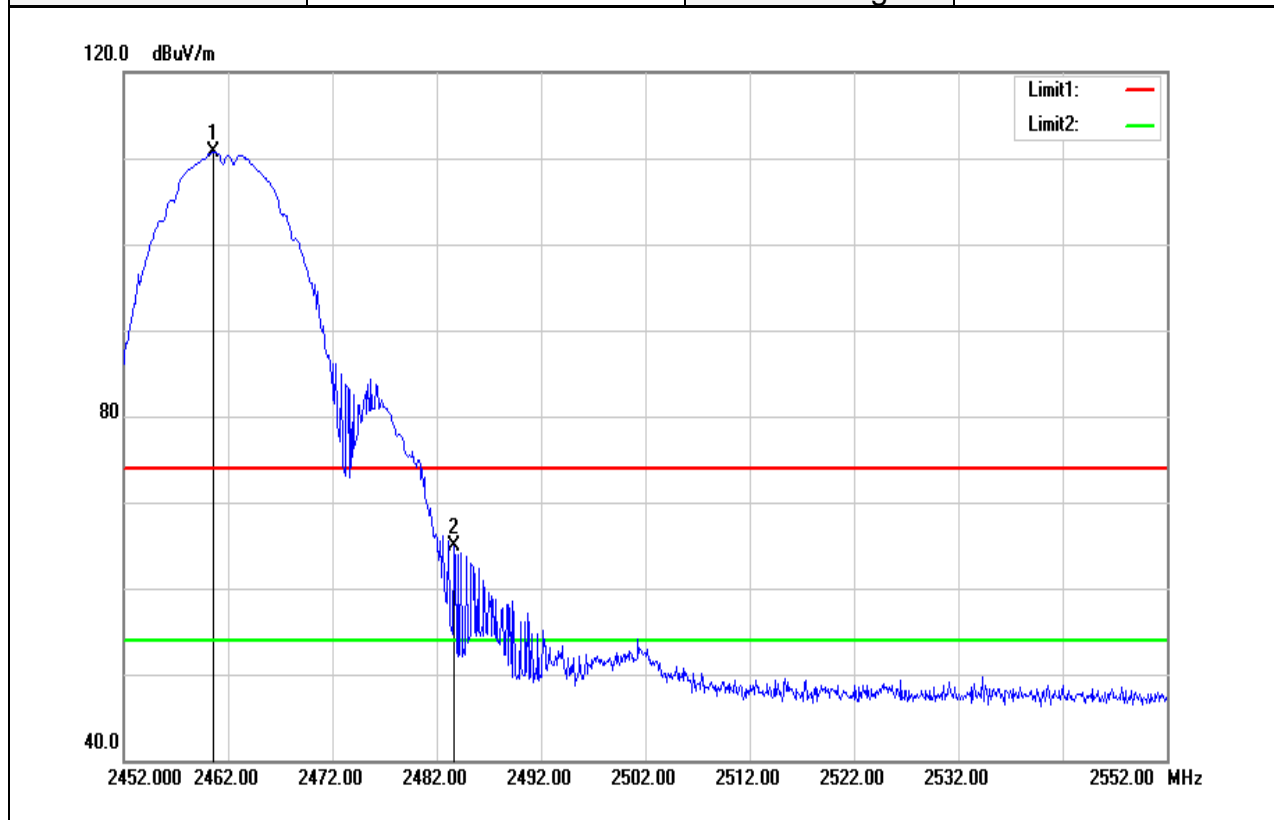

No.	Frequency (MHz)	Reading (dBuV)	Correct Factor(dB/m)	Result (dBuV/m)	Limit (dBuV/m)	Margin (dB)	Remark
1	2460.600	113.49	-2.76	110.73	-	-	peak
2	2483.600	67.59	-2.69	64.90	74.00	-9.10	peak

Test Mode	IEEE 802.11b High CH	Temperature:	24(°C) / 33%RH
Test Item	Band Edge	Test Date	December 7, 2017
Polarize	Horizontal	Test Engineer	Jerry Chuang
Detector	Average	Test Voltage	120Vac / 60Hz

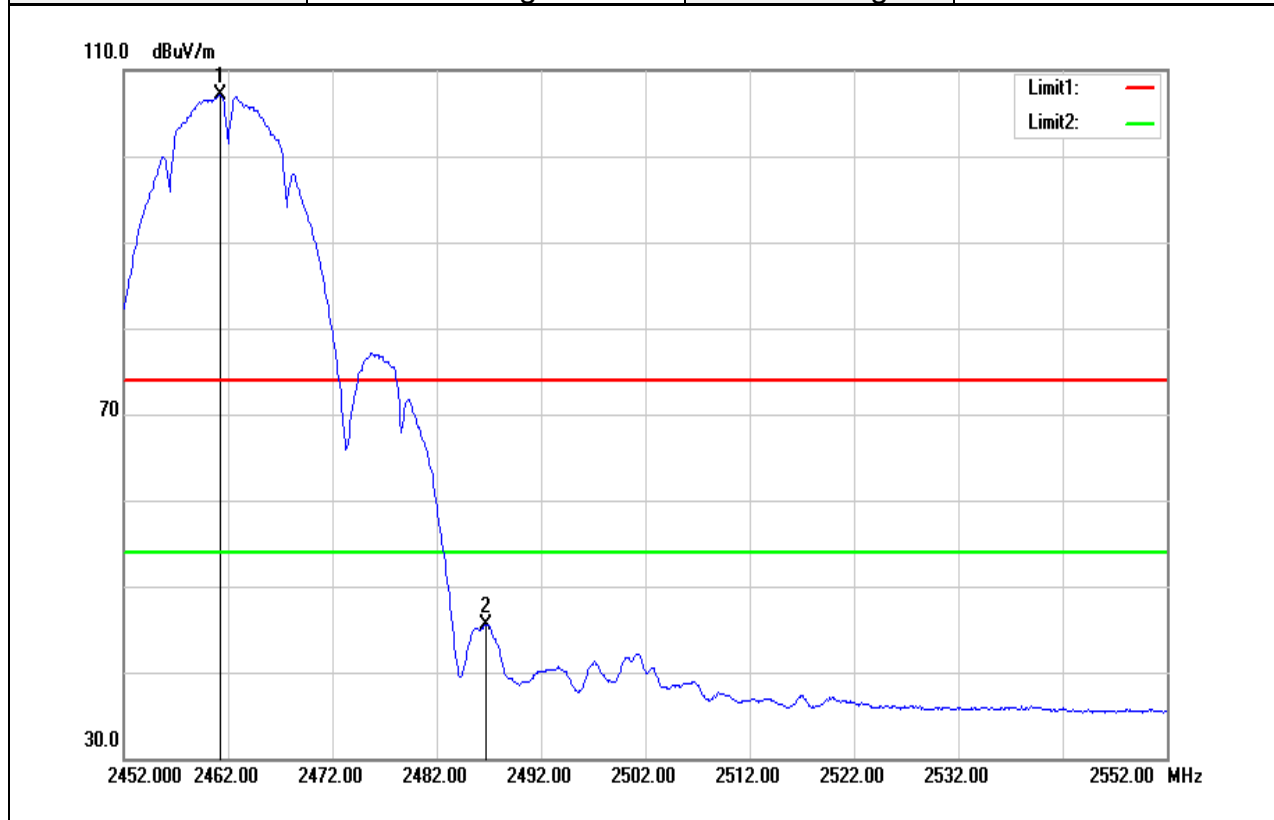

No.	Frequency (MHz)	Reading (dBuV)	Correct Factor(dB/m)	Result (dBuV/m)	Limit (dBuV/m)	Margin (dB)	Remark
1	2461.200	109.88	-2.76	107.12	-	-	AVG
2	2486.700	48.27	-2.68	45.59	54.00	-8.41	AVG

Test Mode	IEEE 802.11g Low CH	Temp/Hum	24(°C) / 33%RH
Test Item	Band Edge	Test Date	December 7, 2017
Polarize	Horizontal	Test Engineer	Jerry Chuang
Detector	Peak	Test Voltage	120Vac / 60Hz

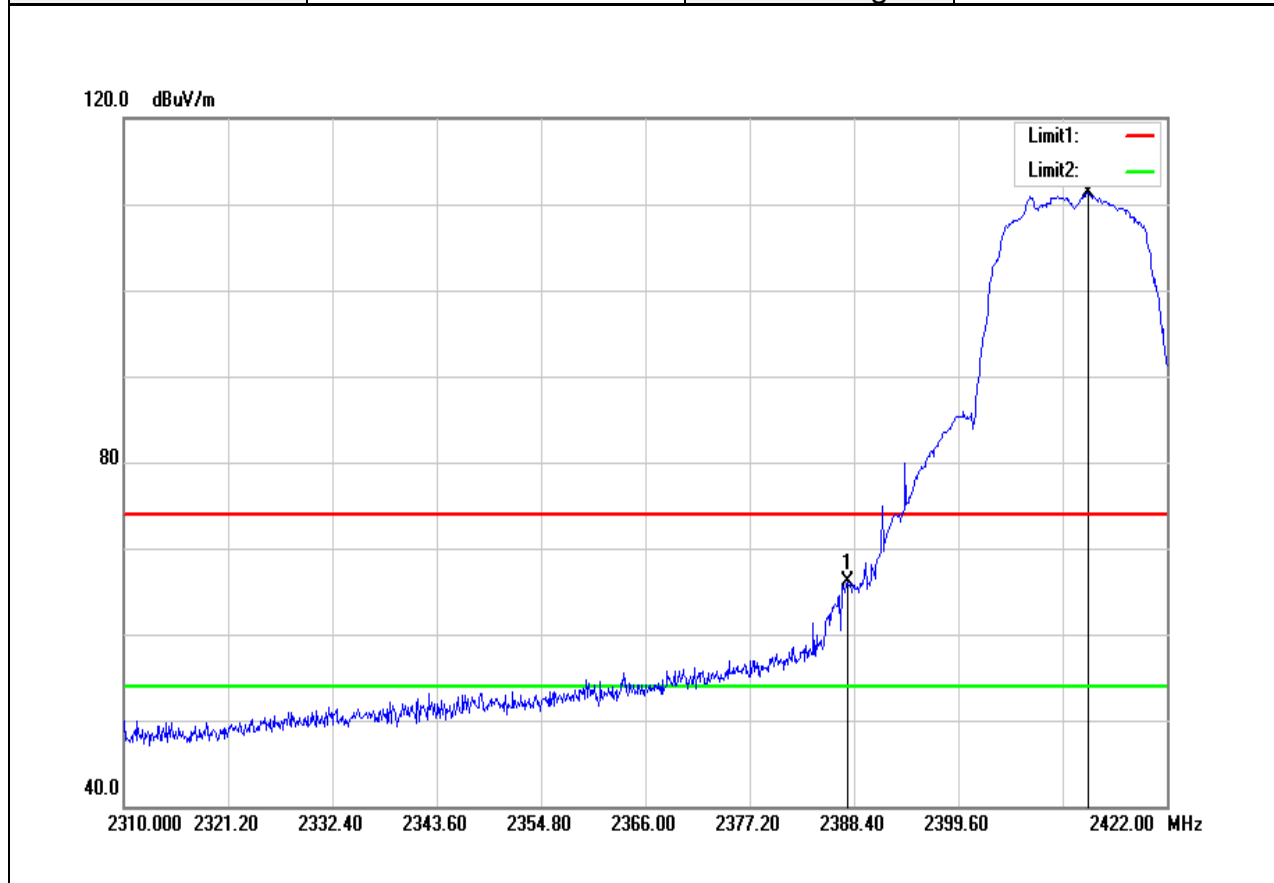

No.	Frequency (MHz)	Reading (dBuV)	Correct Factor(dB/m)	Result (dBuV/m)	Limit (dBuV/m)	Margin (dB)	Remark
1	2387.728	69.06	-2.98	66.08	74.00	-7.92	peak
2	2413.488	114.23	-2.90	111.33	-	-	peak

Test Mode	IEEE 802.11g Low CH	Temperature:	24(°C) / 33%RH
Test Item	Band Edge	Test Date	December 7, 2017
Polarize	Horizontal	Test Engineer	Jerry Chuang
Detector	Average	Test Voltage	120Vac / 60Hz

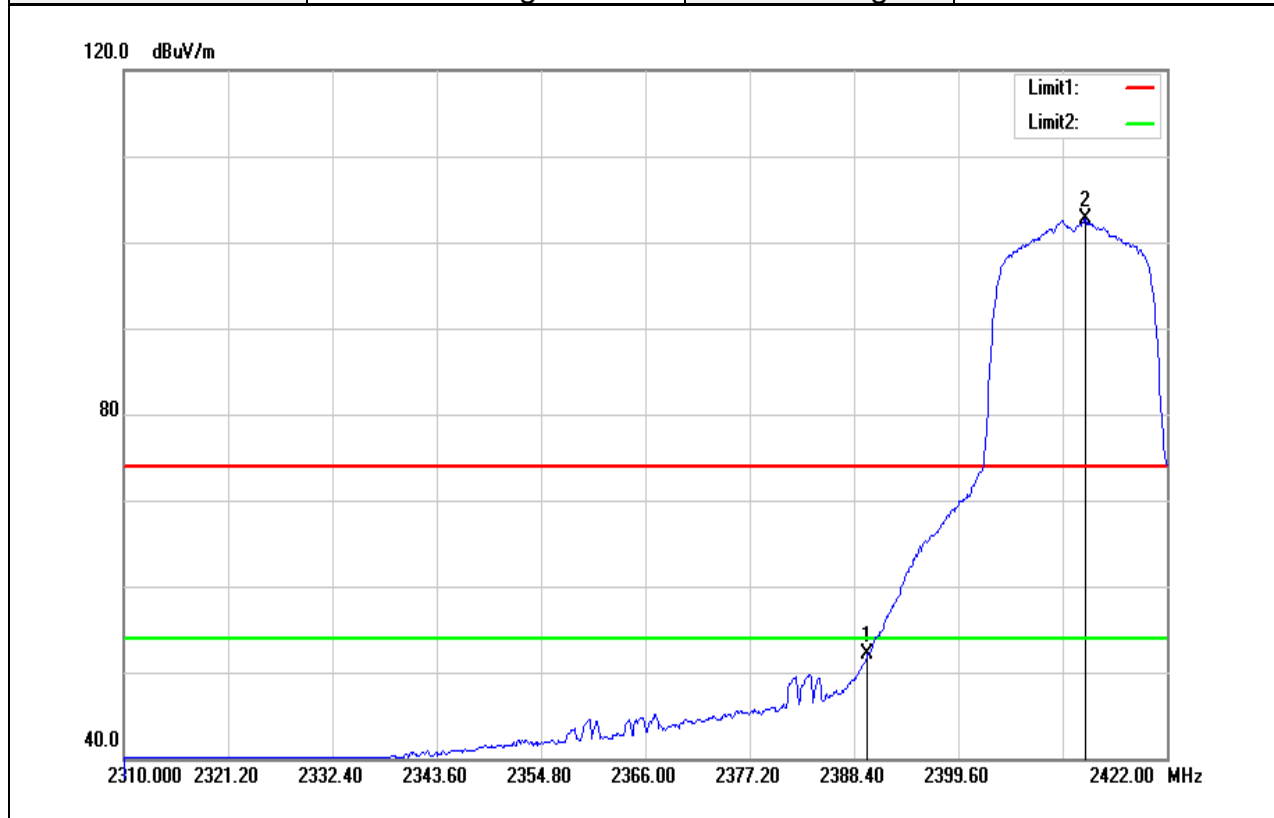

No.	Frequency (MHz)	Reading (dBuV)	Correct Factor(dB/m)	Result (dBuV/m)	Limit (dBuV/m)	Margin (dB)	Remark
1	2389.856	55.07	-2.98	52.09	54.00	-1.91	AVG
2	2413.264	105.55	-2.90	102.65	-	-	AVG

Test Mode	IEEE 802.11g High CH	Temp/Hum	24(°C)/ 33%RH
Test Item	Band Edge	Test Date	December 7, 2017
Polarize	Horizontal	Test Engineer	Jerry Chuang
Detector	Peak	Test Voltage	120Vac / 60Hz

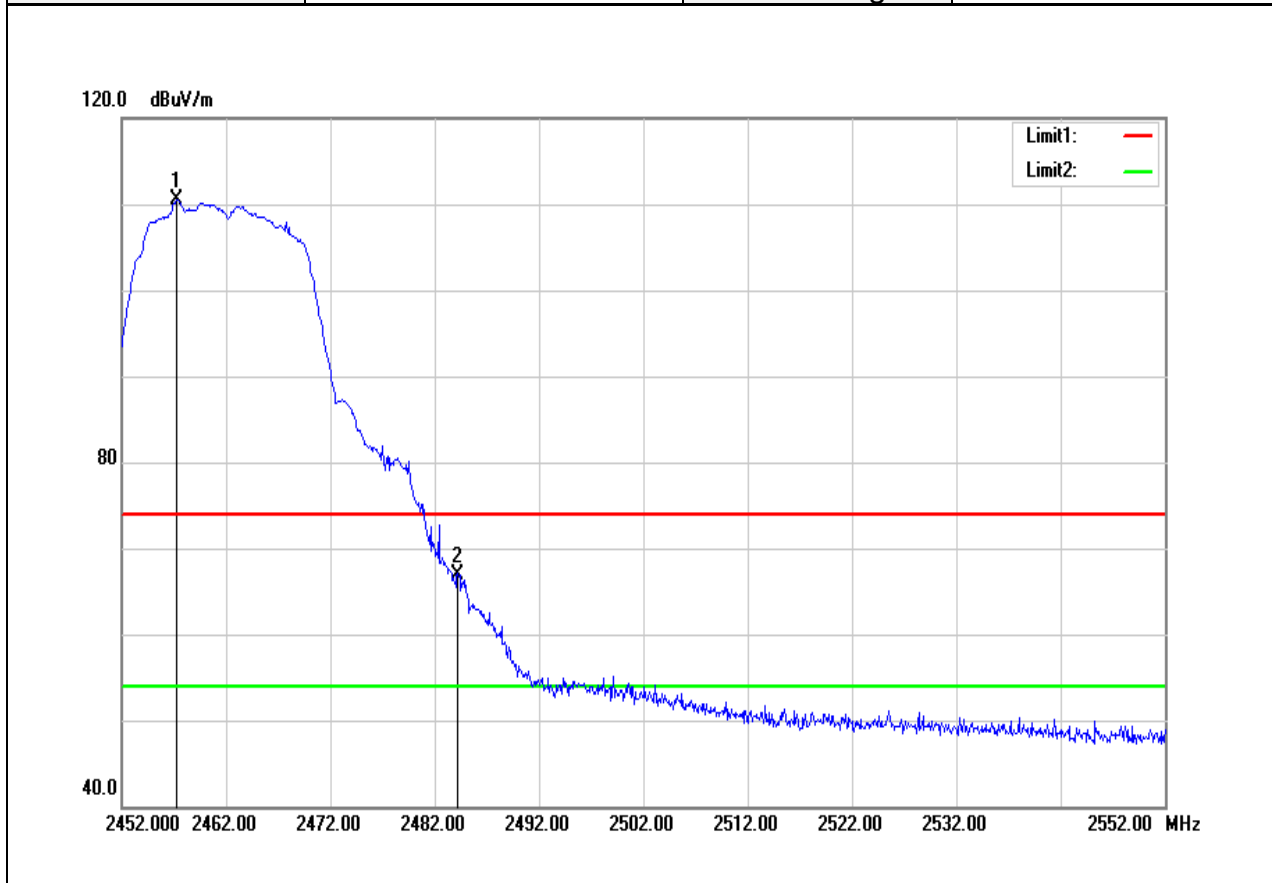

No.	Frequency (MHz)	Reading (dBuV)	Correct Factor(dB/m)	Result (dBuV/m)	Limit (dBuV/m)	Margin (dB)	Remark
1	2457.300	113.26	-2.78	110.48	-	-	peak
2	2484.200	69.69	-2.69	67.00	74.00	-7.00	peak

Test Mode	IEEE 802.11g High CH	Temperature:	24(°C) / 33%RH
Test Item	Band Edge	Test Date	December 7, 2017
Polarize	Horizontal	Test Engineer	Jerry Chuang
Detector	Average	Test Voltage	120Vac / 60Hz

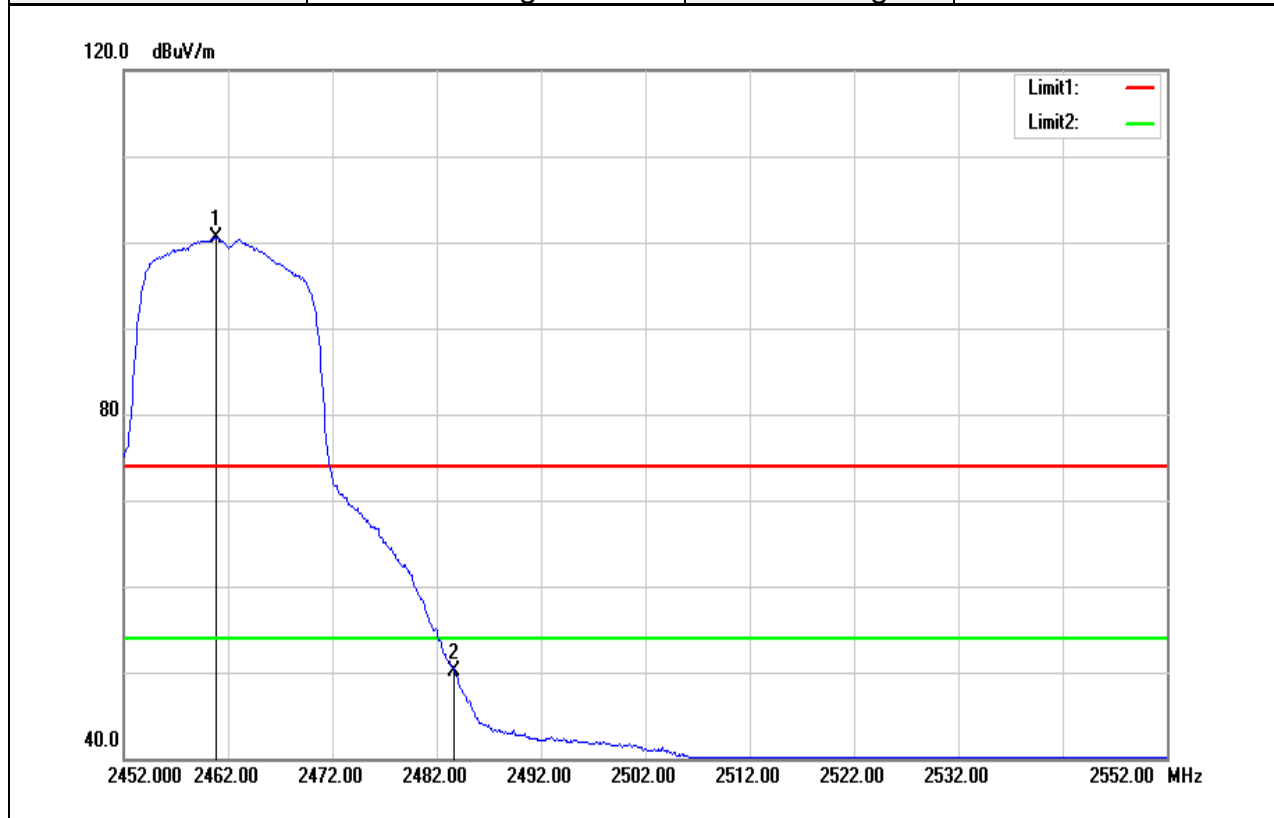

No.	Frequency (MHz)	Reading (dBuV)	Correct Factor(dB/m)	Result (dBuV/m)	Limit (dBuV/m)	Margin (dB)	Remark
1	2460.900	103.33	-2.76	100.57	-	-	AVG
2	2483.700	52.85	-2.69	50.16	54.00	-3.84	AVG

Test Mode	IEEE 802.11n HT20 Low CH	Temp/Hum	24(°C)/ 33%RH
Test Item	Band Edge	Test Date	December 7, 2017
Polarize	Horizontal	Test Engineer	Jerry Chuang
Detector	Peak	Test Voltage	120Vac / 60Hz

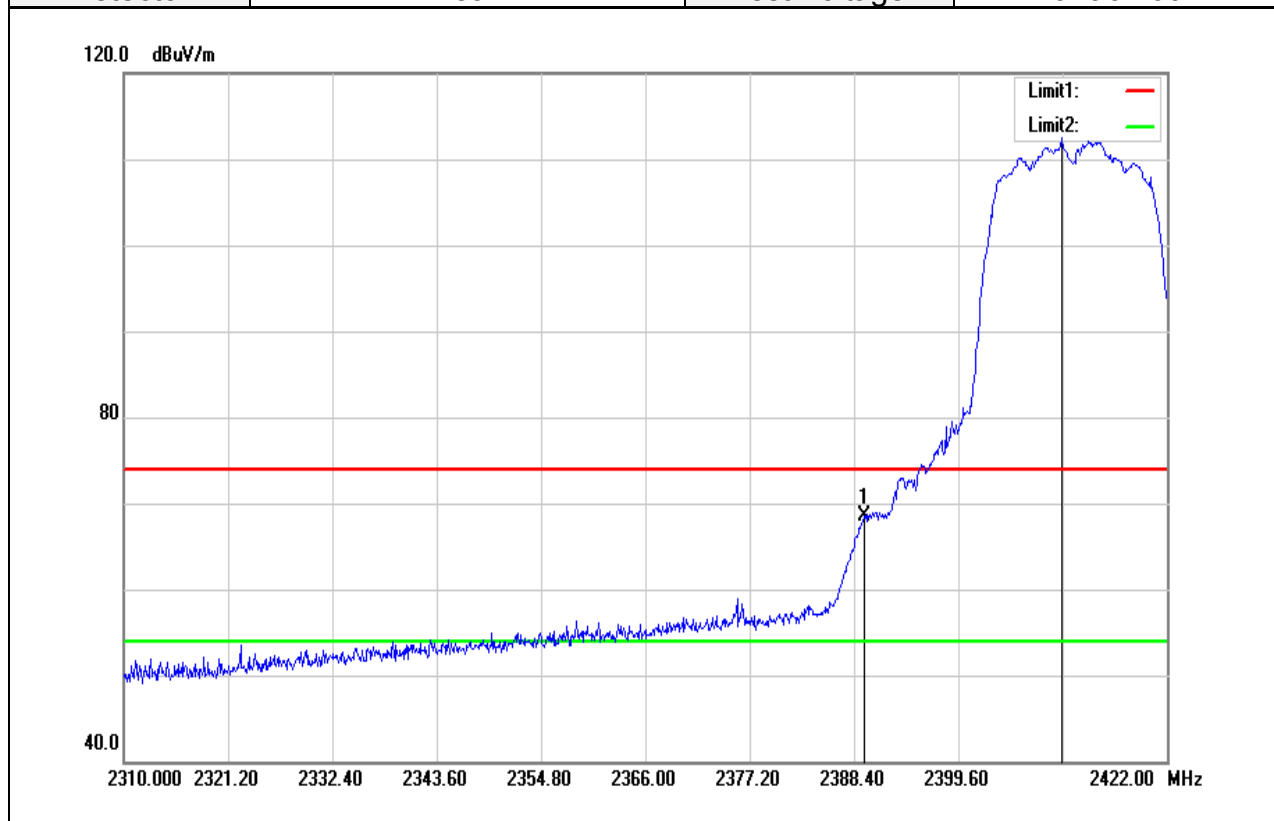

No.	Frequency (MHz)	Reading (dBuV)	Correct Factor(dB/m)	Result (dBuV/m)	Limit (dBuV/m)	Margin (dB)	Remark
1	2389.520	71.57	-2.98	68.59	74.00	-5.41	peak
2	2410.688	115.38	-2.92	112.46	-	-	peak

Test Mode	IEEE 802.11n HT20 Low CH	Temperature:	24(°C) / 33%RH
Test Item	Band Edge	Test Date	December 7, 2017
Polarize	Horizontal	Test Engineer	Jerry Chuang
Detector	Average	Test Voltage	120Vac / 60Hz

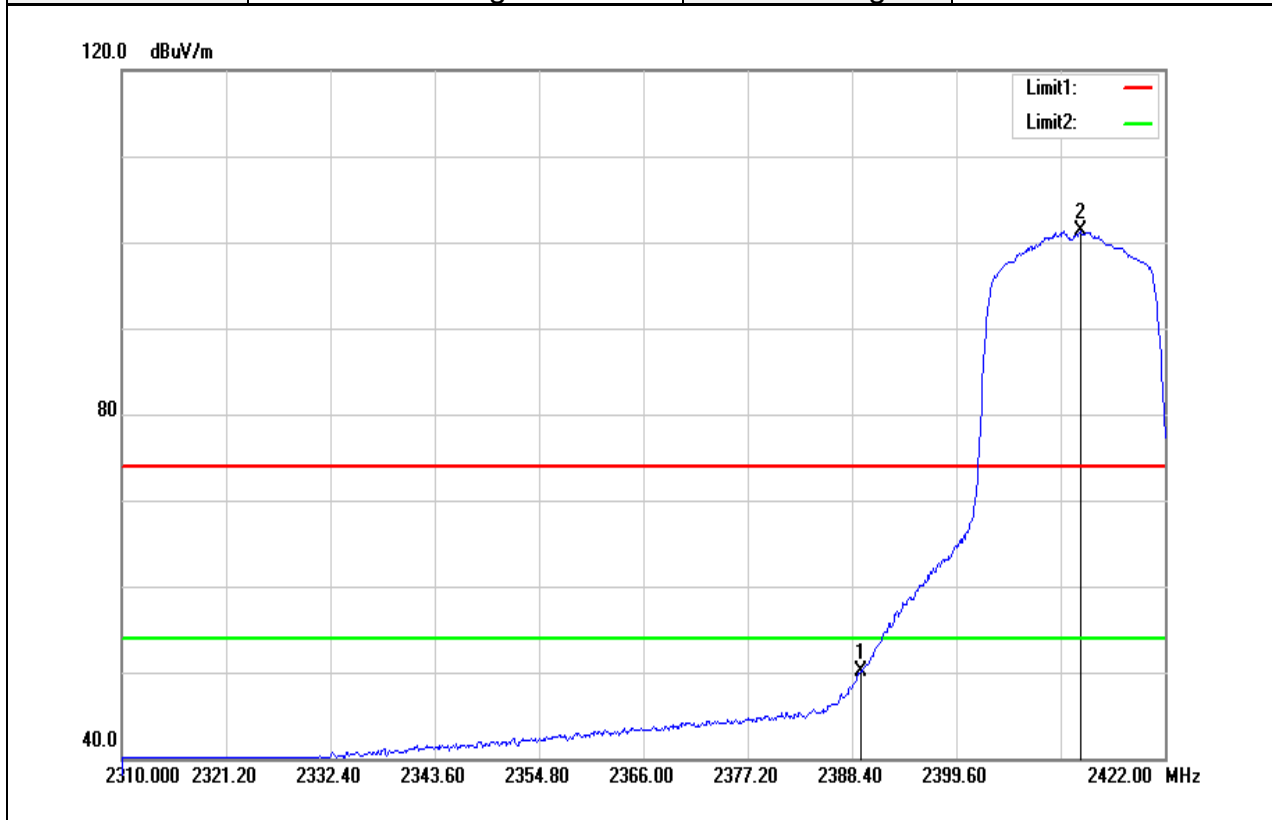

No.	Frequency (MHz)	Reading (dBuV)	Correct Factor(dB/m)	Result (dBuV/m)	Limit (dBuV/m)	Margin (dB)	Remark
1	2389.296	53.13	-2.98	50.15	54.00	-3.85	AVG
2	2412.928	104.12	-2.90	101.22	-	-	AVG

Test Mode	IEEE 802.11n HT20 High CH	Temp/Hum	24(°C)/ 33%RH
Test Item	Band Edge	Test Date	December 7, 2017
Polarize	Horizontal	Test Engineer	Jerry Chuang
Detector	Peak	Test Voltage	120Vac / 60Hz

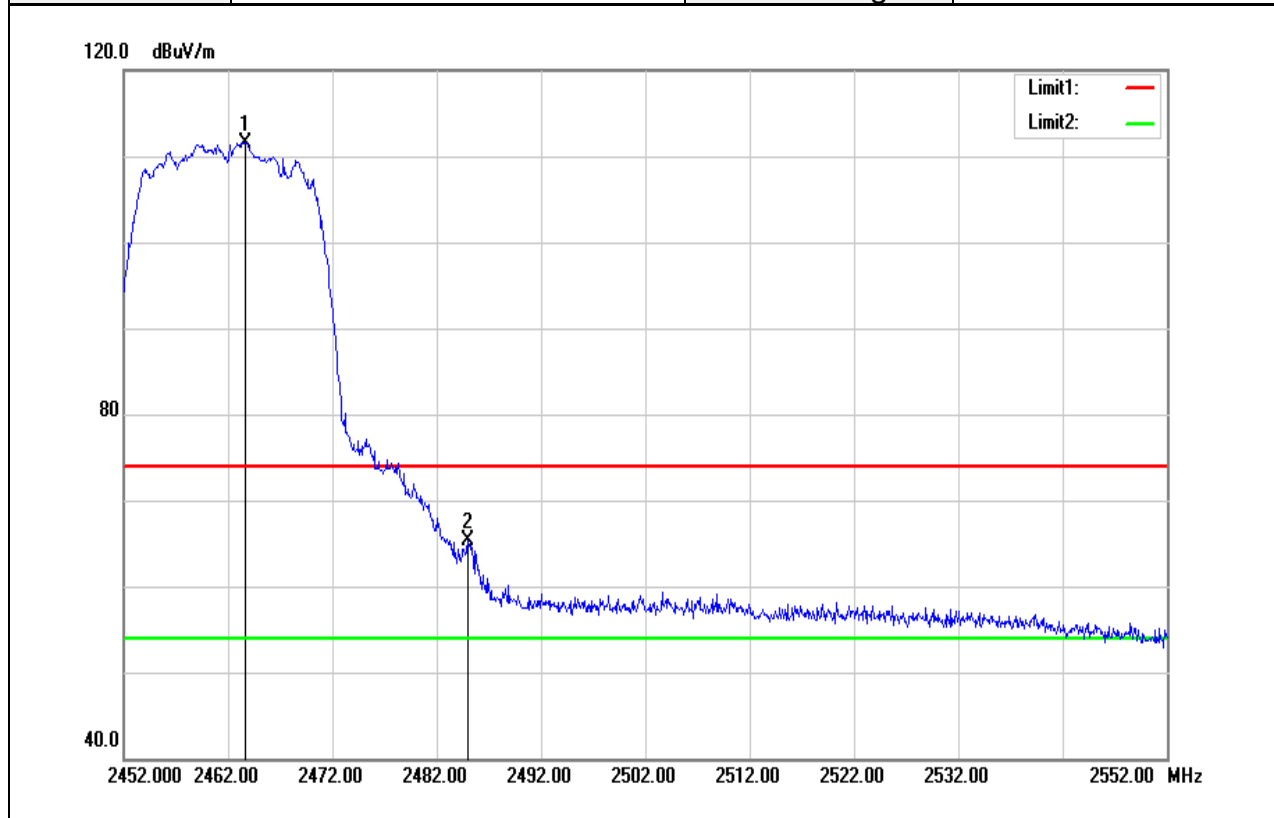

No.	Frequency (MHz)	Reading (dBuV)	Correct Factor(dB/m)	Result (dBuV/m)	Limit (dBuV/m)	Margin (dB)	Remark
1	2463.700	114.35	-2.75	111.60	-	-	peak
2	2485.000	67.98	-2.69	65.29	74.00	-8.71	peak

Test Mode	IEEE 802.11n HT20 High CH	Temperature:	24(°C)/ 33%RH
Test Item	Band Edge	Test Date	December 7, 2017
Polarize	Horizontal	Test Engineer	Jerry Chuang
Detector	Average	Test Voltage	120Vac / 60Hz

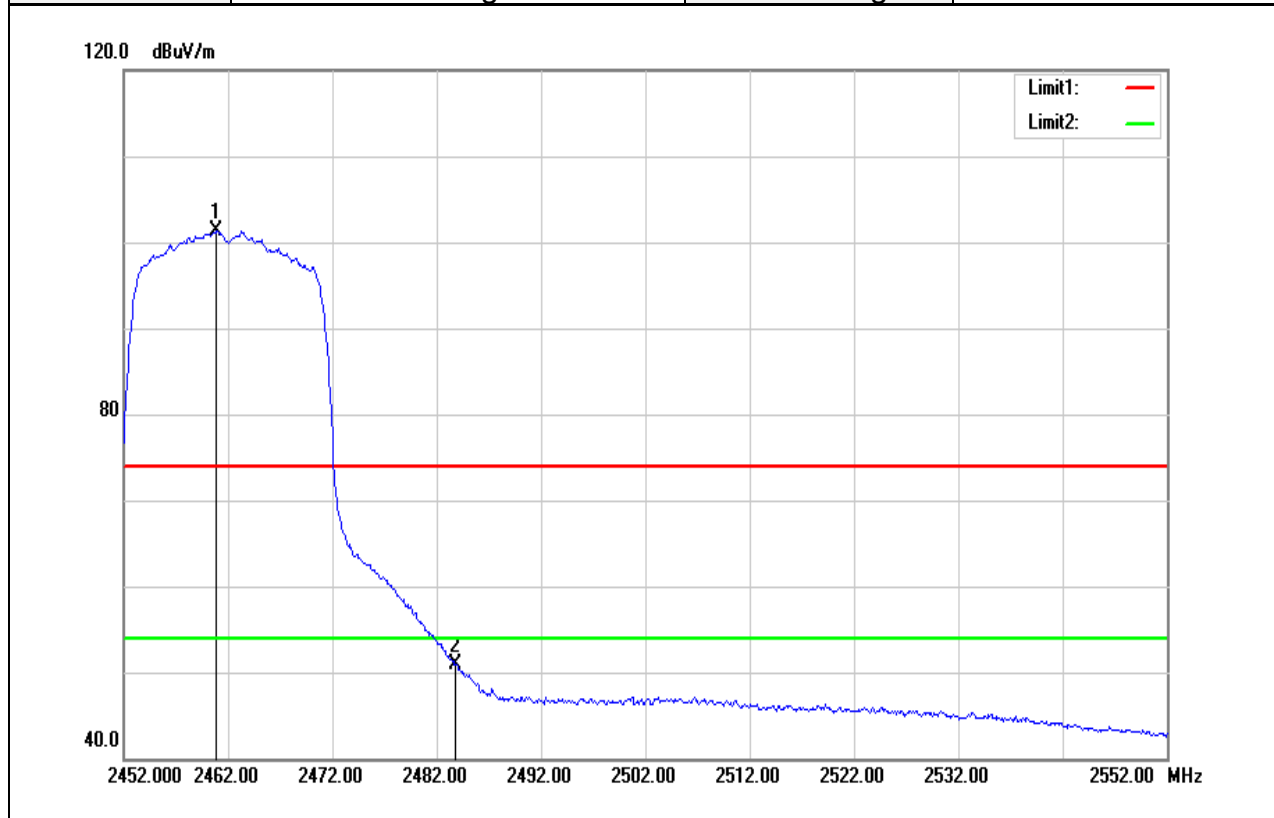

No.	Frequency (MHz)	Reading (dBuV)	Correct Factor(dB/m)	Result (dBuV/m)	Limit (dBuV/m)	Margin (dB)	Remark
1	2460.900	104.06	-2.76	101.30	-	-	AVG
2	2483.800	53.54	-2.69	50.85	54.00	-3.15	AVG

Test Mode	IEEE 802.11n HT40 Low CH	Temp/Hum	24(°C)/ 33%RH
Test Item	Band Edge	Test Date	December 7, 2017
Polarize	Horizontal	Test Engineer	Jerry Chuang
Detector	Peak	Test Voltage	120Vac / 60Hz

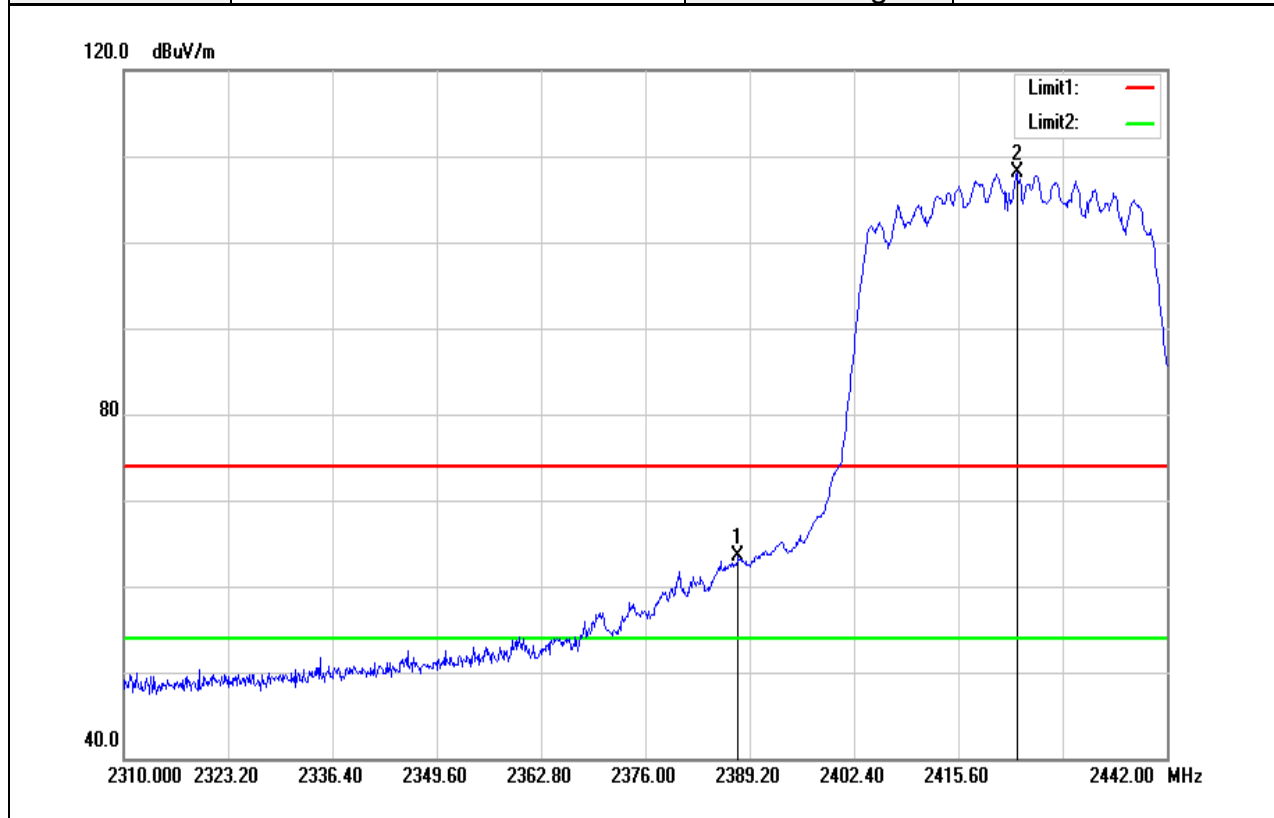

No.	Frequency (MHz)	Reading (dBuV)	Correct Factor(dB/m)	Result (dBuV/m)	Limit (dBuV/m)	Margin (dB)	Remark
1	2387.748	66.50	-2.98	63.52	74.00	-10.48	peak
2	2422.992	110.98	-2.87	108.11	-	-	peak

Test Mode	IEEE 802.11n HT40 Low CH	Temperature:	24(°C) / 33%RH
Test Item	Band Edge	Test Date	December 7, 2017
Polarize	Horizontal	Test Engineer	Jerry Chuang
Detector	Average	Test Voltage	120Vac / 60Hz

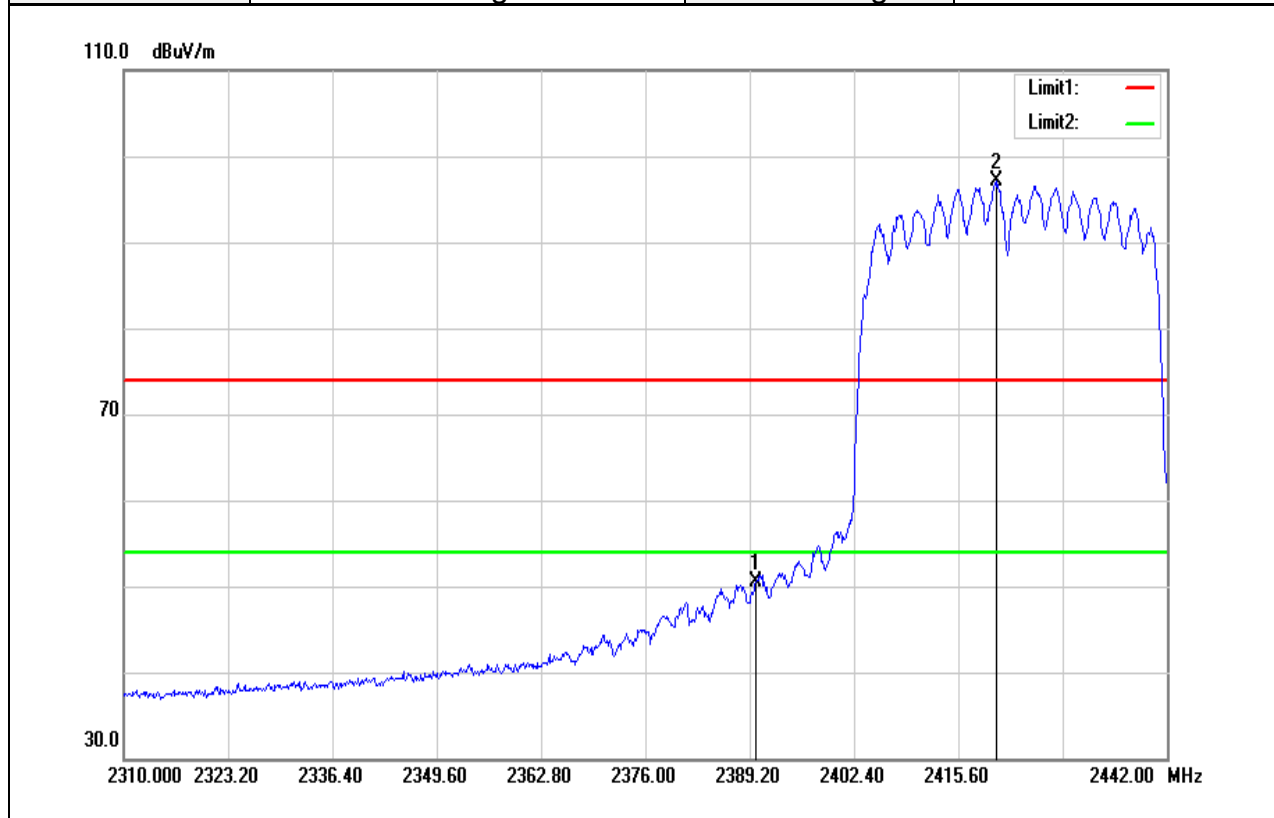

No.	Frequency (MHz)	Reading (dBuV)	Correct Factor(dB/m)	Result (dBuV/m)	Limit (dBuV/m)	Margin (dB)	Remark
1	2389.992	53.39	-2.98	50.41	54.00	-3.59	AVG
2	2420.352	99.95	-2.89	97.06	-	-	AVG

Test Mode	IEEE 802.11n HT40 High CH	Temp/Hum	24(°C)/ 33%RH
Test Item	Band Edge	Test Date	December 7, 2017
Polarize	Horizontal	Test Engineer	Jerry Chuang
Detector	Peak	Test Voltage	120Vac / 60Hz

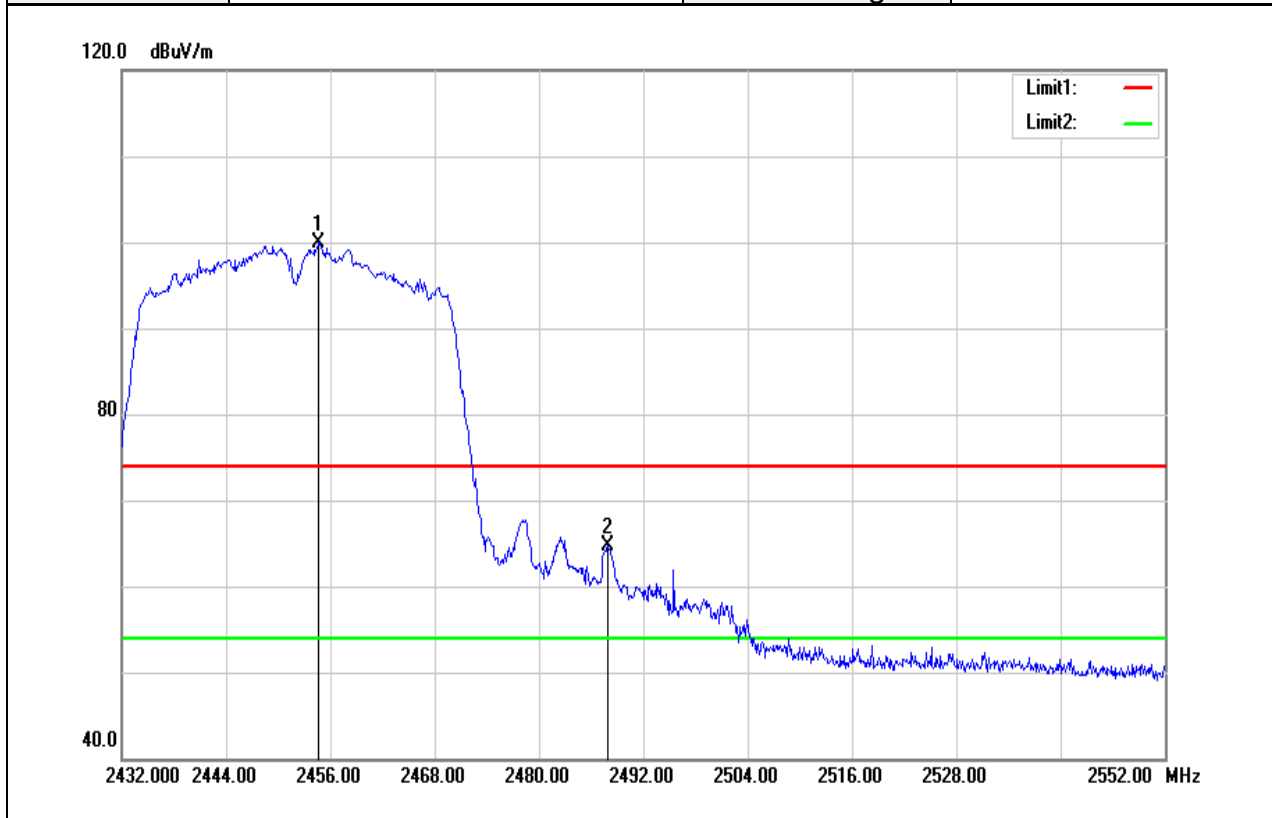

No.	Frequency (MHz)	Reading (dBuV)	Correct Factor(dB/m)	Result (dBuV/m)	Limit (dBuV/m)	Margin (dB)	Remark
1	2454.680	102.64	-2.78	99.86	-	-	peak
2	2487.920	67.44	-2.67	64.77	74.00	-9.23	peak

Test Mode	IEEE 802.11n HT40 High CH	Temperature:	24(°C)/ 33%RH
Test Item	Band Edge	Test Date	December 7, 2017
Polarize	Horizontal	Test Engineer	Jerry Chuang
Detector	Average	Test Voltage	120Vac / 60Hz

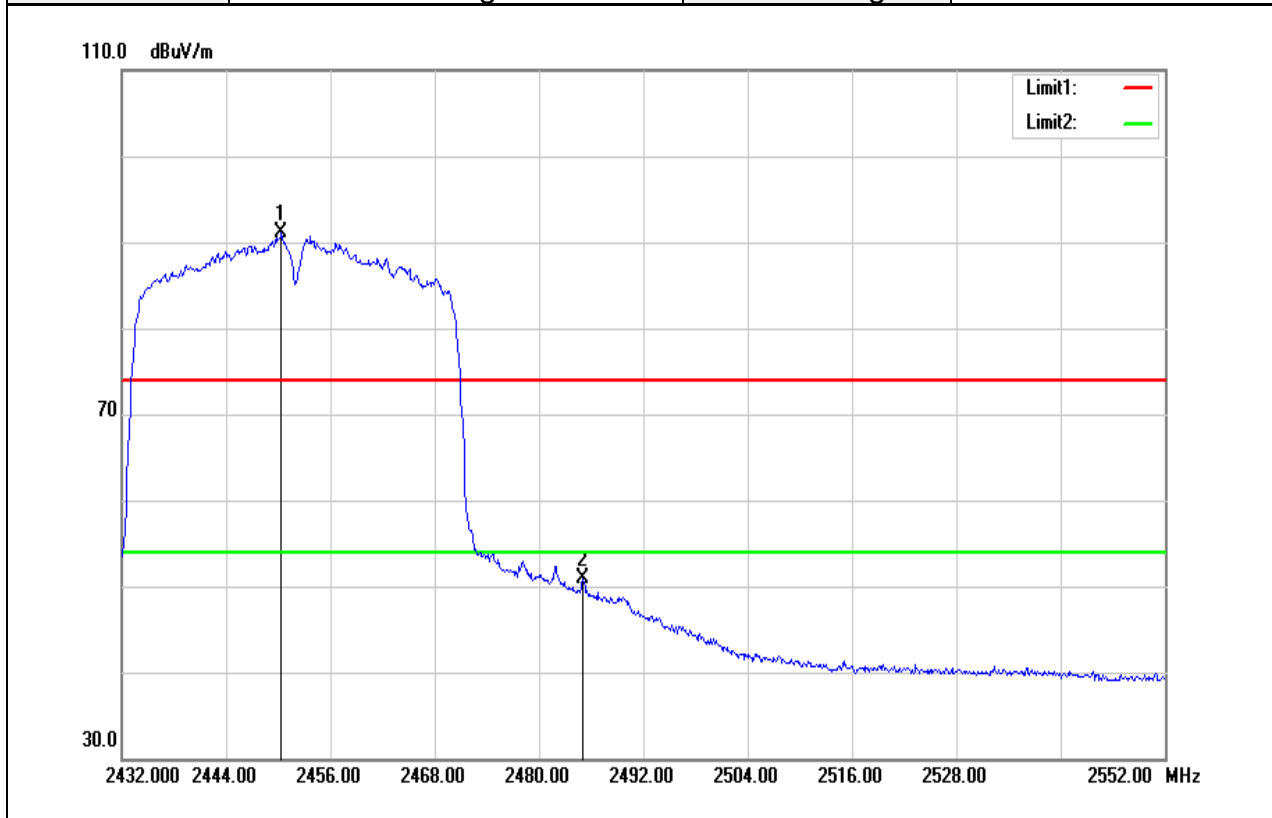

No.	Frequency (MHz)	Reading (dBuV)	Correct Factor(dB/m)	Result (dBuV/m)	Limit (dBuV/m)	Margin (dB)	Remark
1	2450.360	93.85	-2.79	91.06	-	-	AVG
2	2485.040	53.68	-2.69	50.99	54.00	-3.01	AVG

Below 1G Test Data

Test Mode	Mode 1	Temp/Hum	24(°C)/ 33%RH
Test Item	30MHz-1GHz	Test Date	December 7, 2017
Polarize	Vertical	Test Engineer	Jerry Chuang
Detector	Peak and Qusi-peak	Test Voltage	120Vac / 60Hz

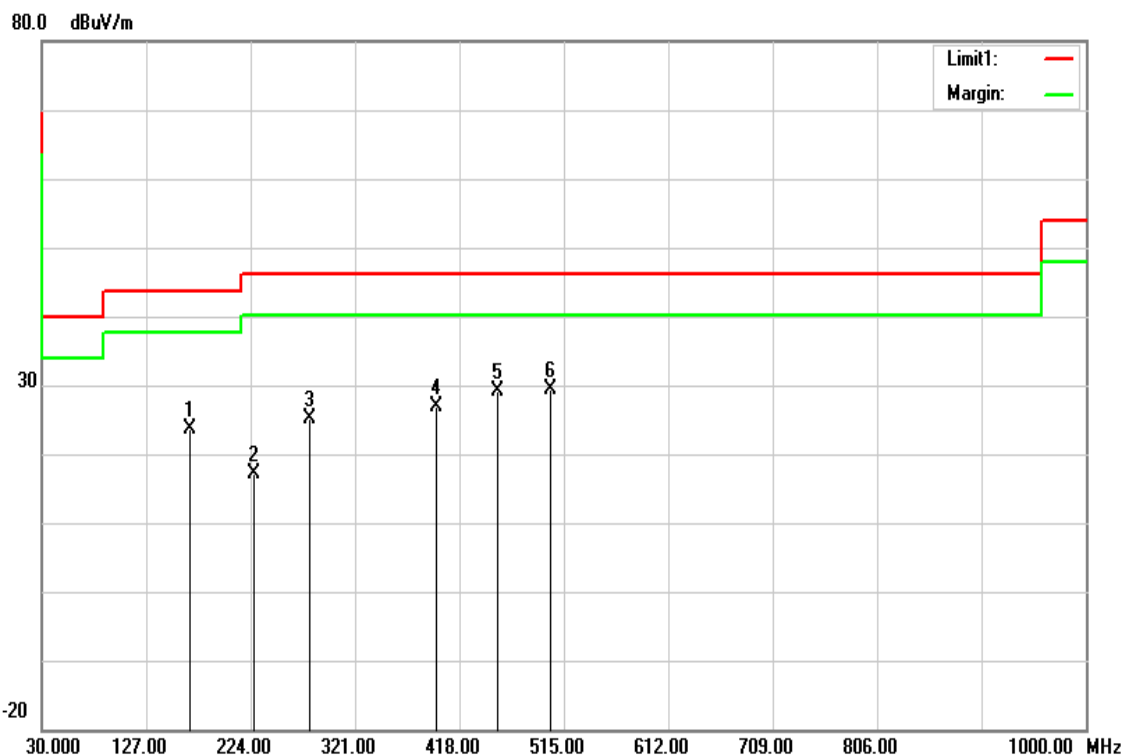

Frequency (MHz)	Reading (dBuV)	Correct Factor (dB/m)	Result (dBuV/m)	Limit (dBuV/m)	Margin (dB)	Remark
167.7400	40.07	-16.41	23.66	43.52	-19.86	peak
226.9100	33.99	-16.93	17.06	46.02	-28.96	peak
279.2900	39.52	-14.31	25.21	46.02	-20.81	peak
396.6600	38.34	-11.50	26.84	46.02	-19.18	peak
452.9200	38.62	-9.53	29.09	46.02	-16.93	peak
502.3900	37.89	-8.45	29.44	46.02	-16.58	peak

Test Mode	Mode 1	Temp/Hum	24(°C)/ 33%RH
Test Item	30MHz-1GHz	Test Date	December 7, 2017
Polarize	Vertical	Test Engineer	Jerry Chuang
Detector	Peak and Qusi-peak	Test Voltage	120Vac / 60Hz

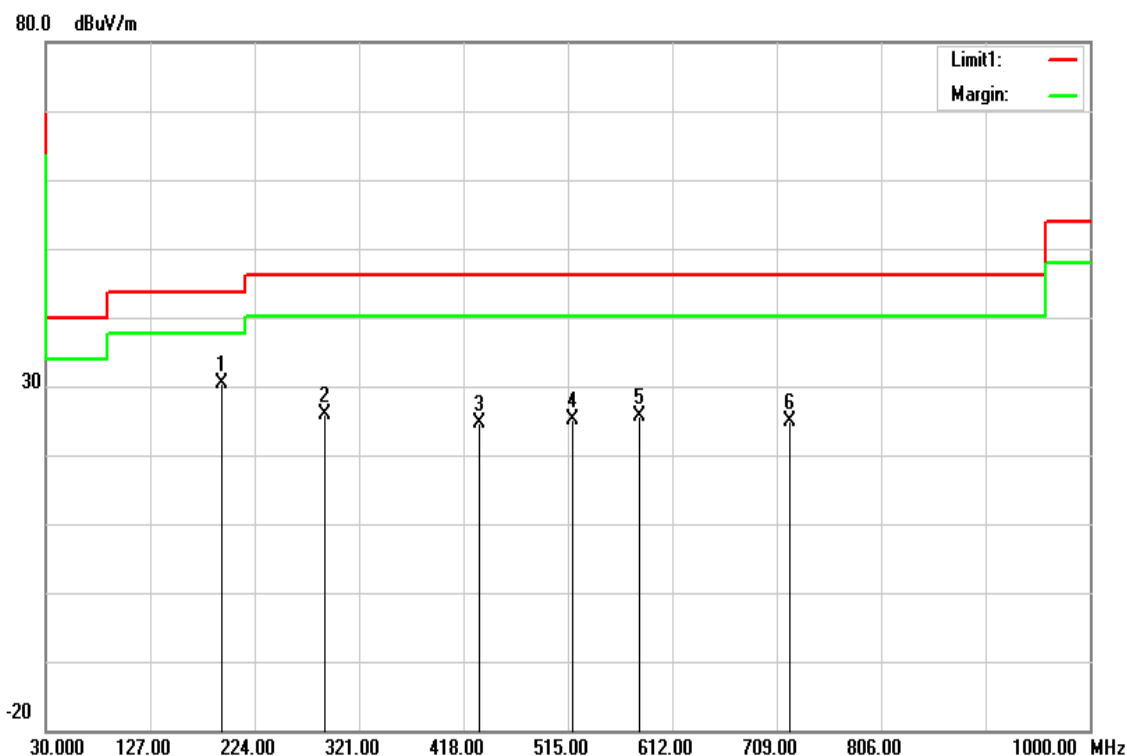

Frequency (MHz)	Reading (dBuV)	Correct Factor (dB/m)	Result (dBuV/m)	Limit (dBuV/m)	Margin (dB)	Remark
192.9600	46.34	-15.95	30.39	43.52	-13.13	peak
288.9900	40.16	-14.19	25.97	46.02	-20.05	peak
432.5500	34.95	-10.22	24.73	46.02	-21.29	peak
518.8800	33.35	-8.14	25.21	46.02	-20.81	peak
580.9600	32.78	-7.16	25.62	46.02	-20.40	peak
720.6400	29.56	-4.64	24.92	46.02	-21.10	peak

Above 1G Test Data

Test Mode	IEEE 802.11b Low CH	Temp/Hum	24(°C)/ 33%RH
Test Item	Harmonic	Test Date	December 7, 2017
Polarize	Vertical	Test Engineer	Jerry Chuang
Detector	Peak and Average	Test Voltage	120Vac / 60Hz

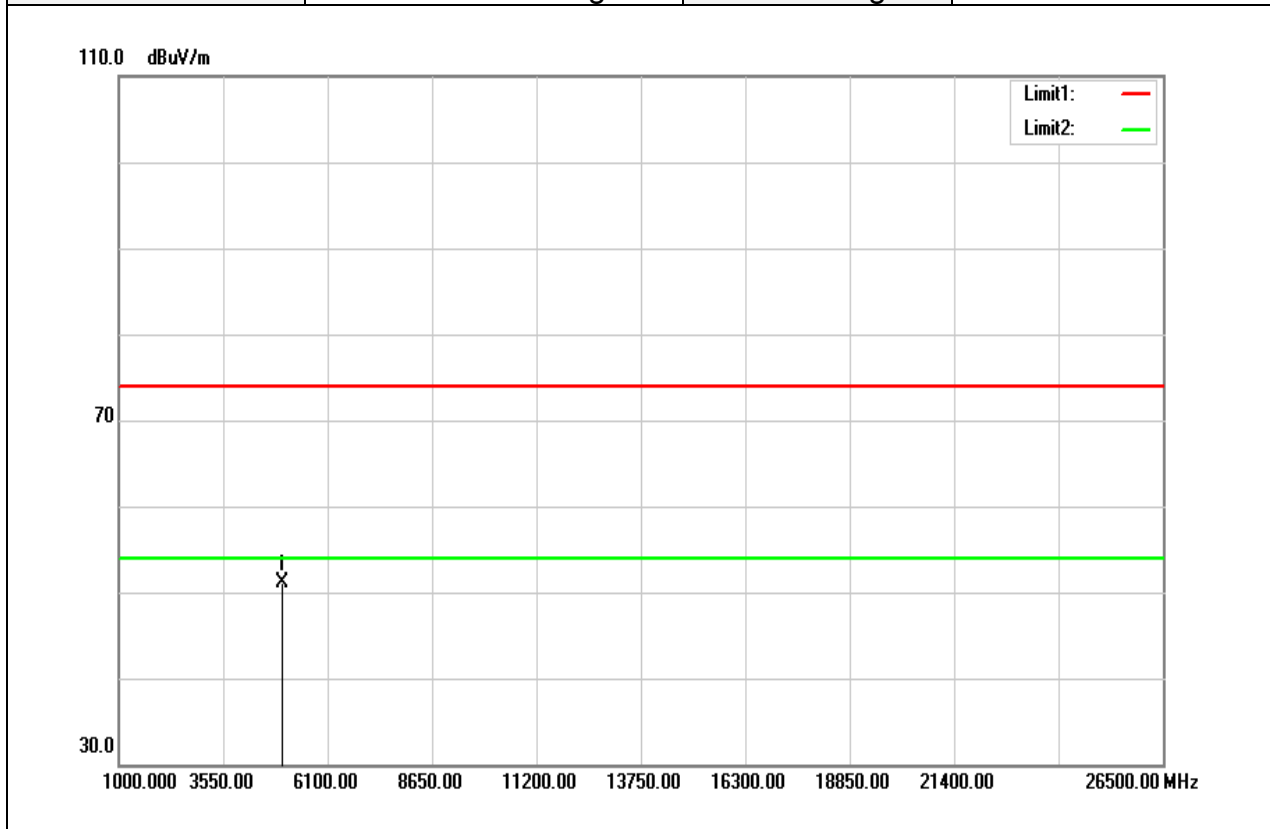

Frequency (MHz)	Reading (dBuV)	Correct Factor (dB/m)	Result (dBuV/m)	Limit (dBuV/m)	Margin (dB)	Remark
4981.000	46.52	4.66	51.18	74.00	-22.82	peak
N/A						

Remark:

1. Measuring frequencies from 1 GHz to the 10th harmonic of highest fundamental frequency.
2. For above 1GHz, the EUT peak value was under average limit, therefore the Average value compliance with the average limit

Test Mode	IEEE 802.11b Low CH	Temp/Hum	24(°C)/ 33%RH
Test Item	Harmonic	Test Date	December 7, 2017
Polarize	Horizontal	Test Engineer	Jerry Chuang
Detector	Peak and Average	Test Voltage	120Vac / 60Hz

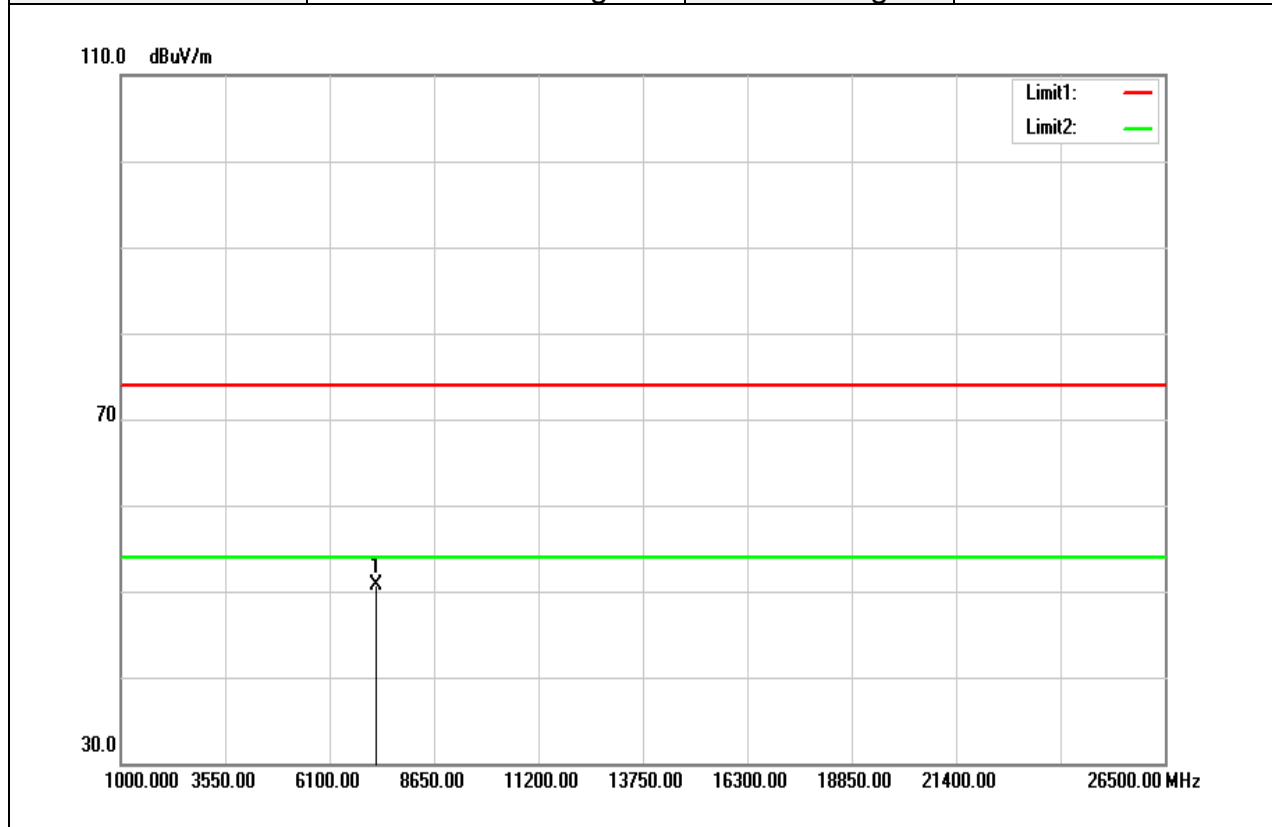

Frequency (MHz)	Reading (dBuV)	Correct Factor (dB/m)	Result (dBuV/m)	Limit (dBuV/m)	Margin (dB)	Remark
7235.000	40.33	10.40	50.73	74.00	-23.27	peak
N/A						

Remark:

1. Measuring frequencies from 1 GHz to the 10th harmonic of highest fundamental frequency.
2. For above 1GHz, the EUT peak value was under average limit, therefore the Average value compliance with the average limit

Test Mode	IEEE 802.11b Mid CH	Temp/Hum	24(°C)/ 33%RH
Test Item	Harmonic	Test Date	December 7, 2017
Polarize	Vertical	Test Engineer	Jerry Chuang
Detector	Peak and Average	Test Voltage	120Vac / 60Hz

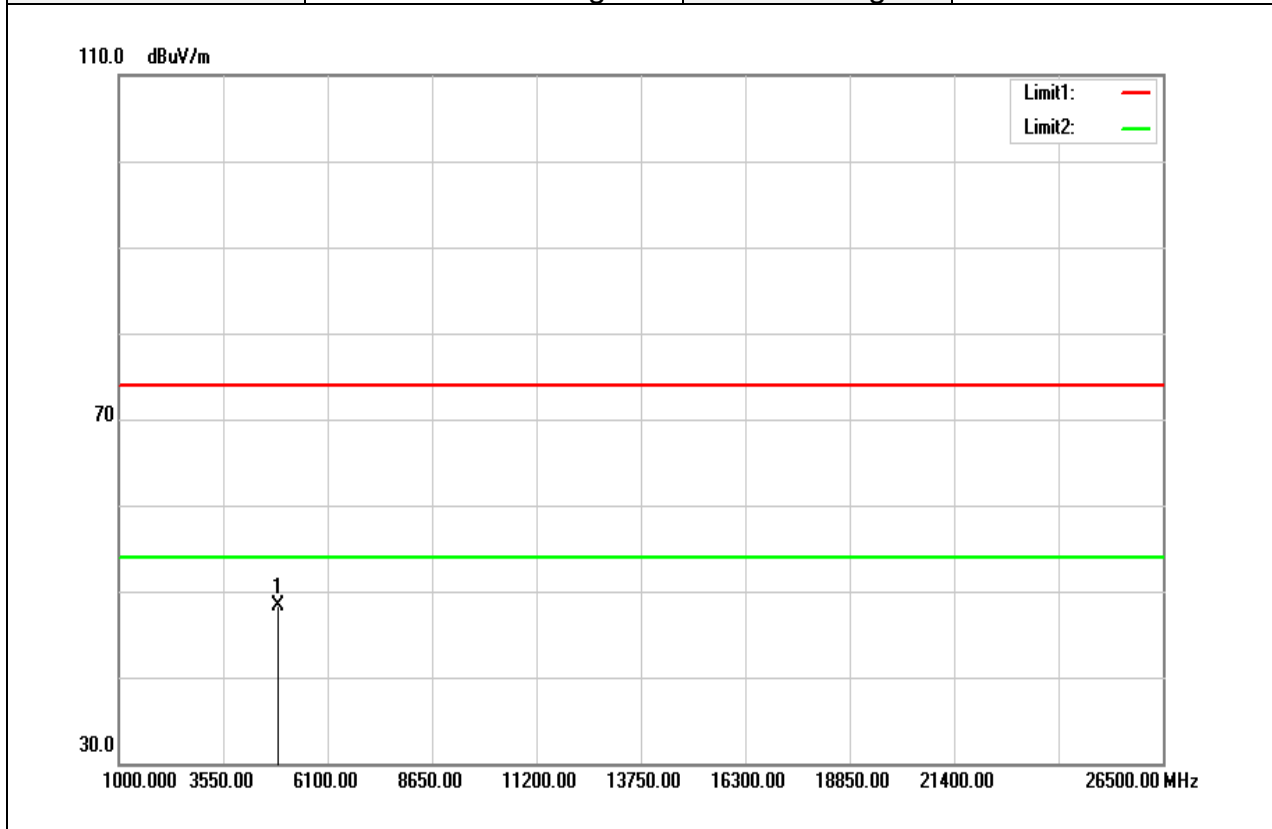

Frequency (MHz)	Reading (dBuV)	Correct Factor (dB/m)	Result (dBuV/m)	Limit (dBuV/m)	Margin (dB)	Remark
4876.000	43.89	4.47	48.36	74.00	-25.64	peak
N/A						

Remark:

1. Measuring frequencies from 1 GHz to the 10th harmonic of highest fundamental frequency.
2. For above 1GHz, the EUT peak value was under average limit, therefore the Average value compliance with the average limit

Test Mode	IEEE 802.11b Mid CH	Temp/Hum	24(°C)/ 33%RH
Test Item	Harmonic	Test Date	December 7, 2017
Polarize	Horizontal	Test Engineer	Jerry Chuang
Detector	Peak and Average	Test Voltage	120Vac / 60Hz

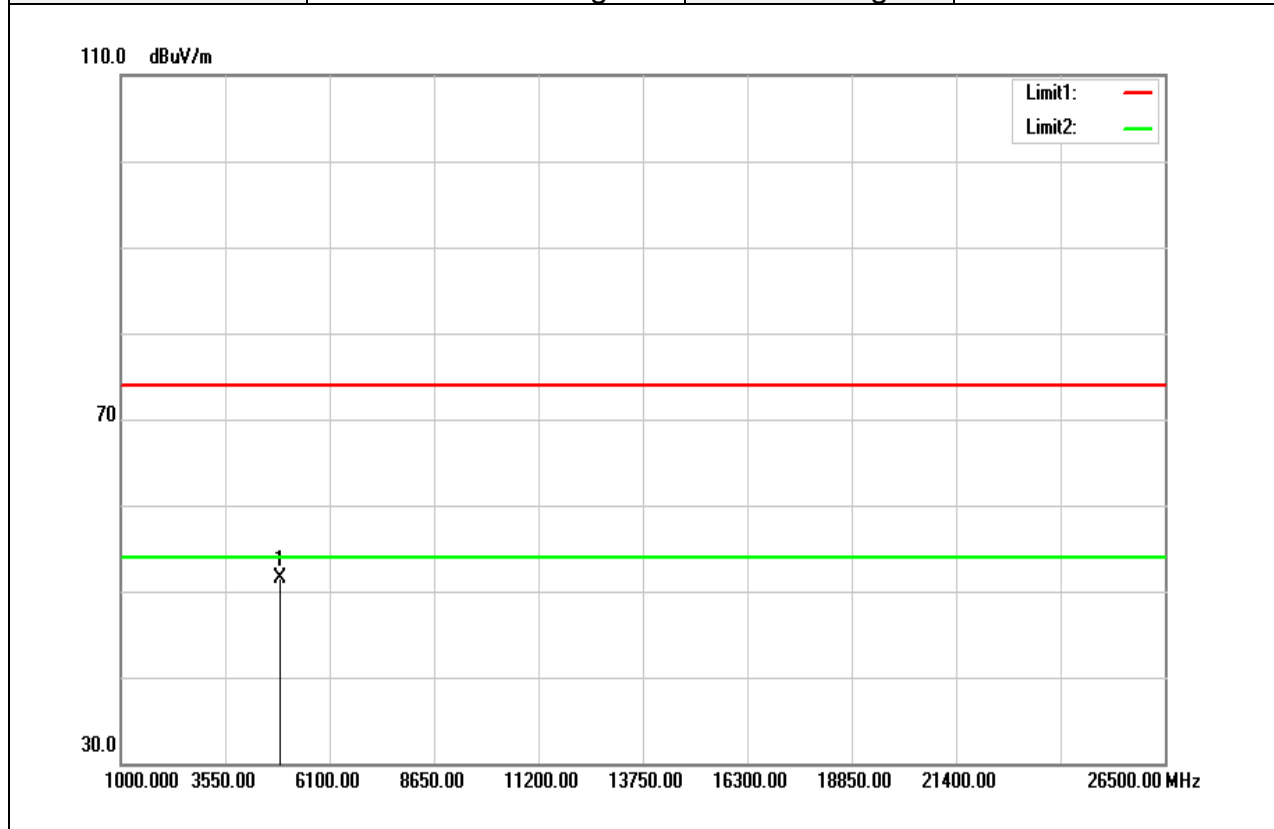

Frequency (MHz)	Reading (dBuV)	Correct Factor (dB/m)	Result (dBuV/m)	Limit (dBuV/m)	Margin (dB)	Remark
4876.000	47.07	4.47	51.54	74.00	-22.46	peak
N/A						

Remark:

1. Measuring frequencies from 1 GHz to the 10th harmonic of highest fundamental frequency.
2. For above 1GHz, the EUT peak value was under average limit, therefore the Average value compliance with the average limit

Test Mode	IEEE 802.11b High CH	Temp/Hum	24(°C)/ 33%RH
Test Item	Harmonic	Test Date	December 7, 2017
Polarize	Vertical	Test Engineer	Jerry Chuang
Detector	Peak and Average	Test Voltage	120Vac / 60Hz

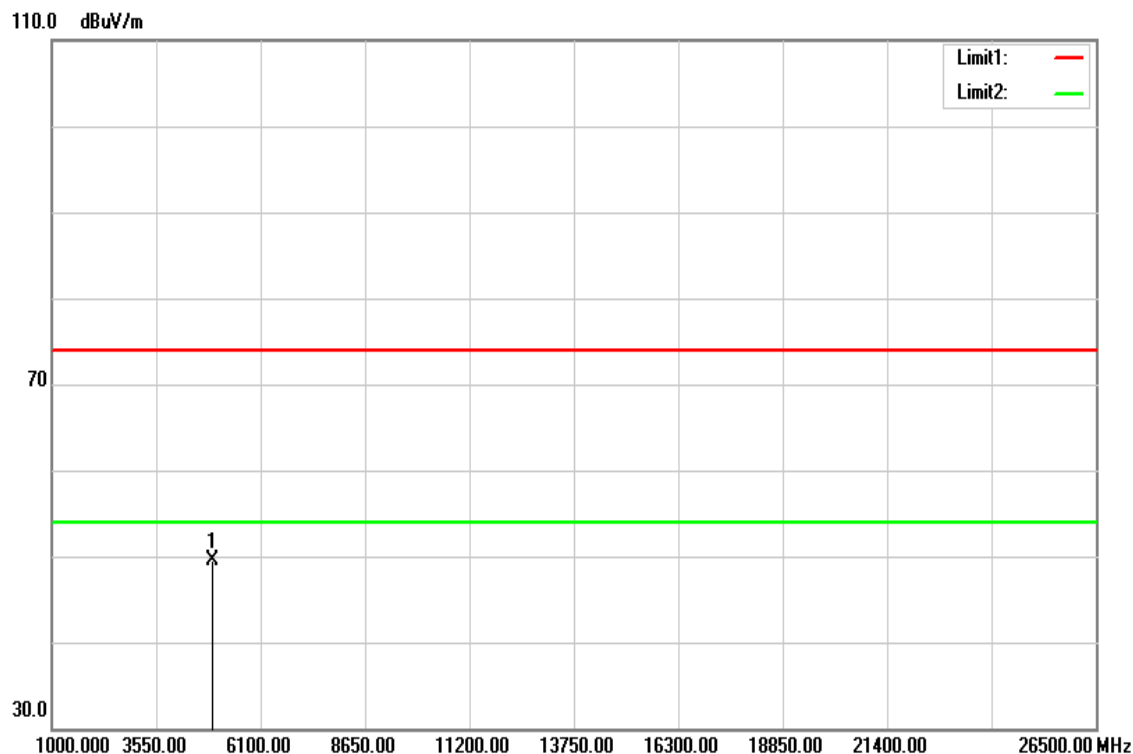

Frequency (MHz)	Reading (dBuV)	Correct Factor (dB/m)	Result (dBuV/m)	Limit (dBuV/m)	Margin (dB)	Remark
4925.000	44.87	4.55	49.42	74.00	-24.58	peak
N/A						

Remark:

1. Measuring frequencies from 1 GHz to the 10th harmonic of highest fundamental frequency.
2. For above 1GHz, the EUT peak value was under average limit, therefore the Average value compliance with the average limit

Test Mode	IEEE 802.11b High CH	Temp/Hum	24(°C)/ 33%RH
Test Item	Harmonic	Test Date	December 7, 2017
Polarize	Horizontal	Test Engineer	Jerry Chuang
Detector	Peak and Average	Test Voltage	120Vac / 60Hz

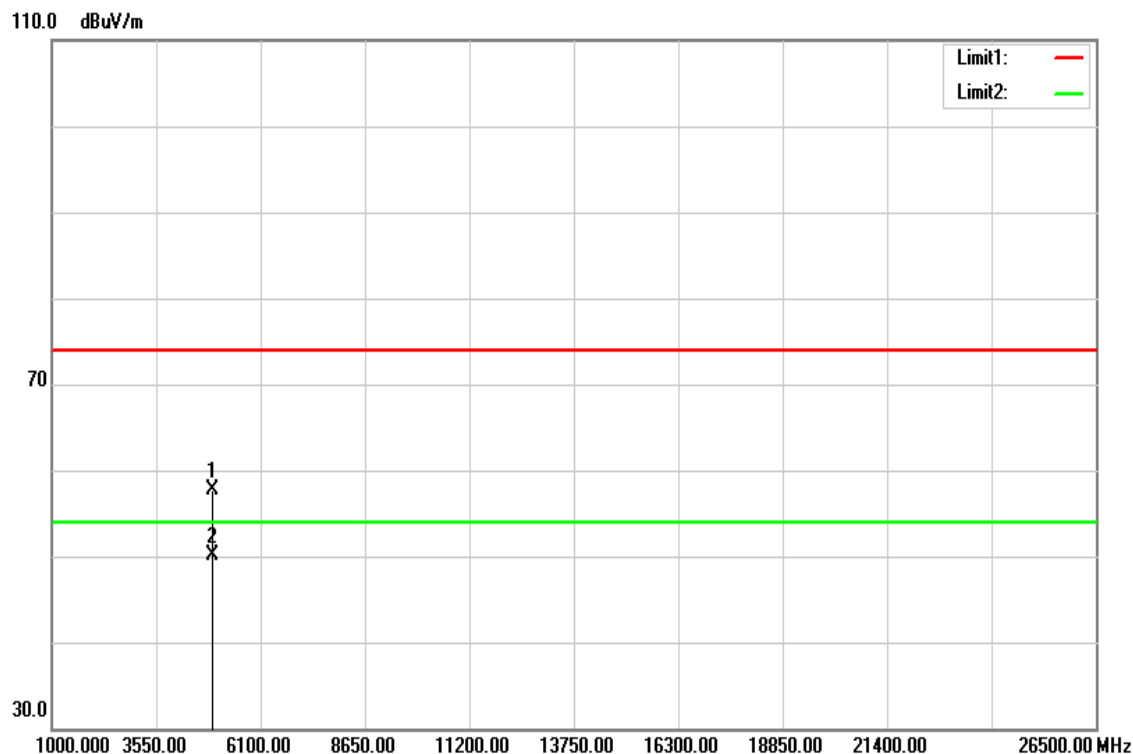

Frequency (MHz)	Reading (dBuV)	Correct Factor (dB/m)	Result (dBuV/m)	Limit (dBuV/m)	Margin (dB)	Remark
4925.000	53.11	4.55	57.66	74.00	-16.34	peak
4925.000	45.62	4.55	50.17	54.00	-3.83	AVG
N/A						

Remark:

1. Measuring frequencies from 1 GHz to the 10th harmonic of highest fundamental frequency.
2. For above 1GHz, the EUT peak value was under average limit, therefore the Average value compliance with the average limit

Test Mode	IEEE 802.11g Low CH	Temp/Hum	24(°C)/ 33%RH
Test Item	Harmonic	Test Date	December 7, 2017
Polarize	Vertical	Test Engineer	Jerry Chuang
Detector	Peak and Average	Test Voltage	120Vac / 60Hz

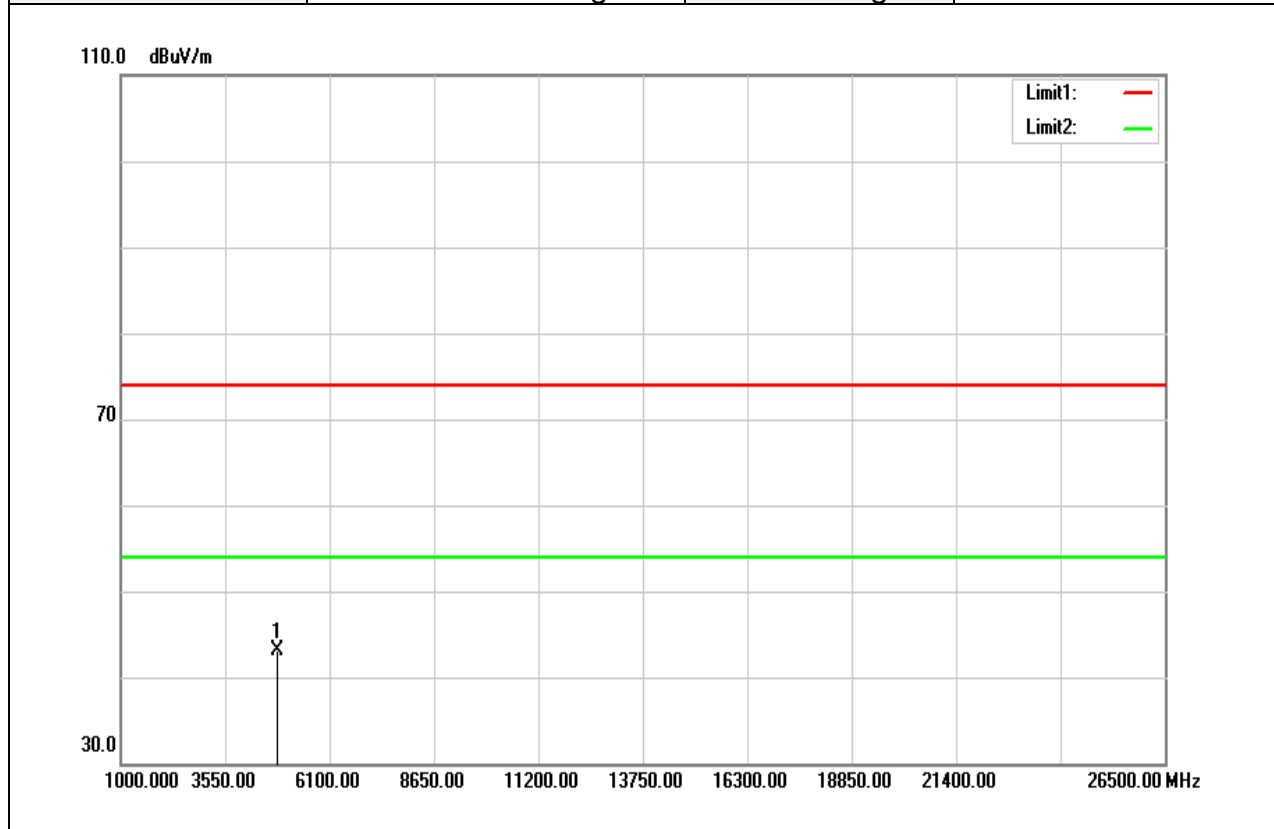

Frequency (MHz)	Reading (dBuV)	Correct Factor (dB/m)	Result (dBuV/m)	Limit (dBuV/m)	Margin (dB)	Remark
4824.000	38.70	4.38	43.08	74.00	-30.92	peak
N/A						

Remark:

1. Measuring frequencies from 1 GHz to the 10th harmonic of highest fundamental frequency.
2. For above 1GHz, the EUT peak value was under average limit, therefore the Average value compliance with the average limit

Test Mode	IEEE 802.11g Low CH	Temp/Hum	24(°C)/ 33%RH
Test Item	Harmonic	Test Date	December 7, 2017
Polarize	Horizontal	Test Engineer	Jerry Chuang
Detector	Peak and Average	Test Voltage	120Vac / 60Hz

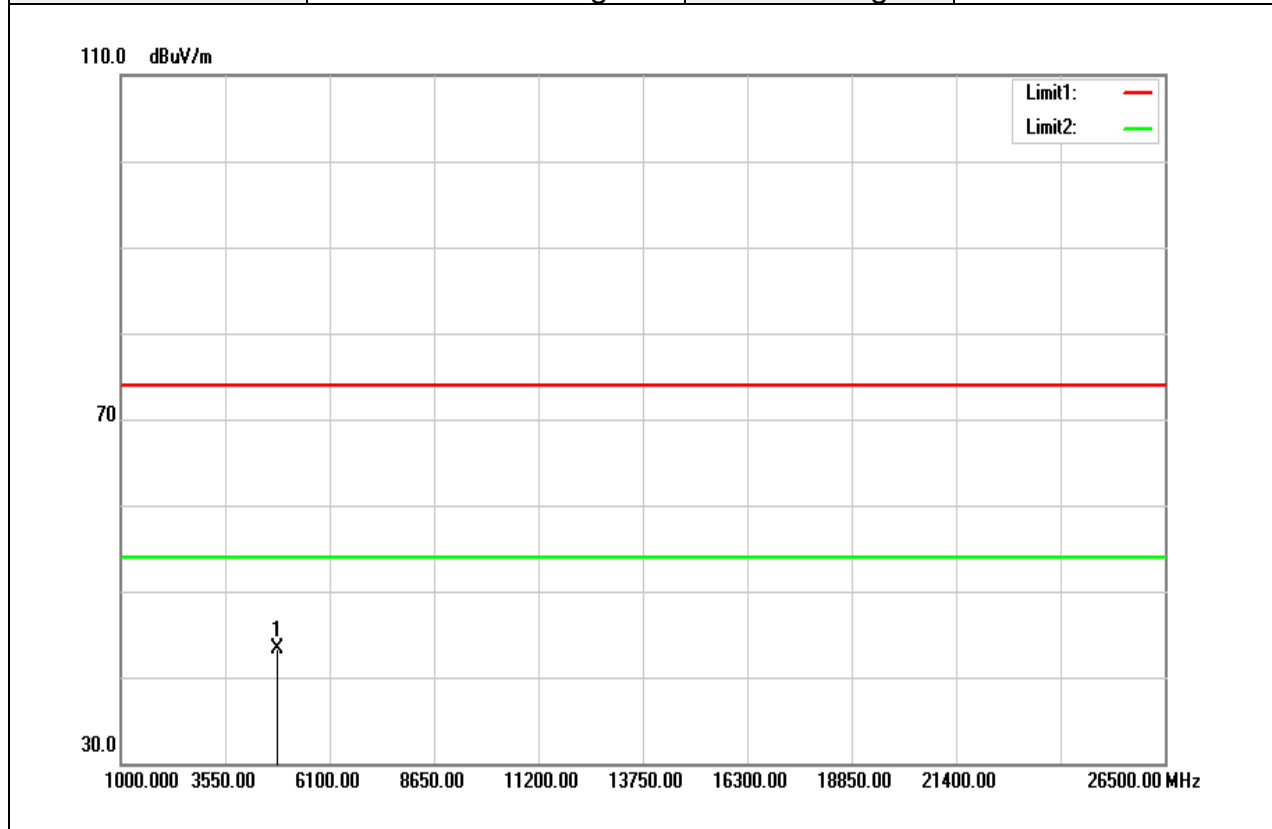

Frequency (MHz)	Reading (dBuV)	Correct Factor (dB/m)	Result (dBuV/m)	Limit (dBuV/m)	Margin (dB)	Remark
4824.000	38.86	4.38	43.24	74.00	-30.76	peak
N/A						

Remark:

1. Measuring frequencies from 1 GHz to the 10th harmonic of highest fundamental frequency.
2. For above 1GHz, the EUT peak value was under average limit, therefore the Average value compliance with the average limit

Test Mode	IEEE 802.11g Mid CH	Temp/Hum	24(°C)/ 33%RH
Test Item	Harmonic	Test Date	December 7, 2017
Polarize	Vertical	Test Engineer	Jerry Chuang
Detector	Peak and Average	Test Voltage	120Vac / 60Hz

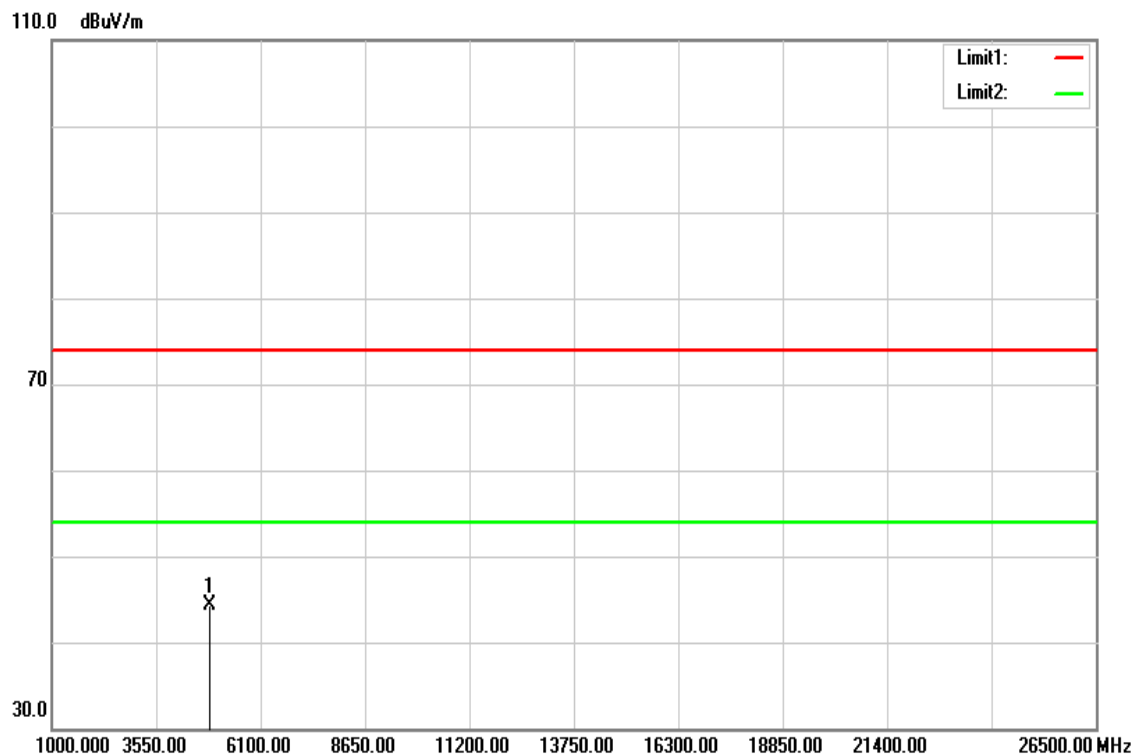

Frequency (MHz)	Reading (dBuV)	Correct Factor (dB/m)	Result (dBuV/m)	Limit (dBuV/m)	Margin (dB)	Remark
4874.000	39.83	4.47	44.30	74.00	-29.70	peak
N/A						

Remark:

1. Measuring frequencies from 1 GHz to the 10th harmonic of highest fundamental frequency.
2. For above 1GHz, the EUT peak value was under average limit, therefore the Average value compliance with the average limit

Test Mode	IEEE 802.11g Mid CH	Temp/Hum	24(°C)/ 33%RH
Test Item	Harmonic	Test Date	December 7, 2017
Polarize	Horizontal	Test Engineer	Jerry Chuang
Detector	Peak and Average	Test Voltage	120Vac / 60Hz

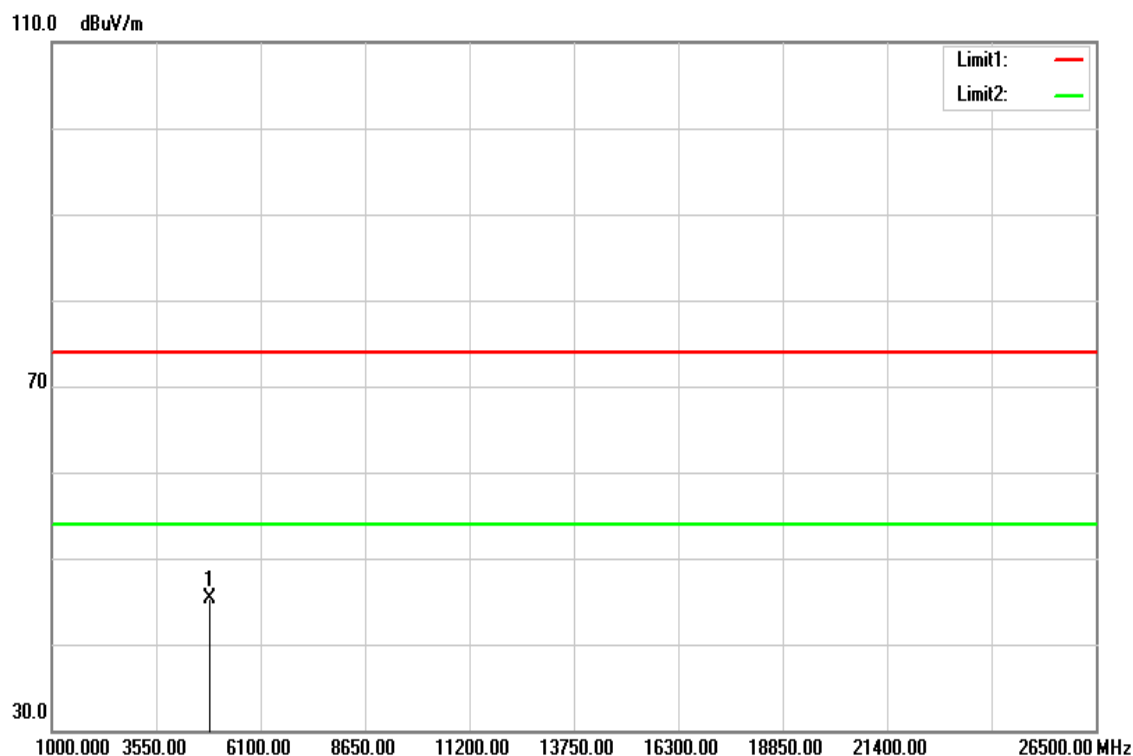

Frequency (MHz)	Reading (dBuV)	Correct Factor (dB/m)	Result (dBuV/m)	Limit (dBuV/m)	Margin (dB)	Remark
4874.000	40.78	4.47	45.25	74.00	-28.75	peak
N/A						

Remark:

1. Measuring frequencies from 1 GHz to the 10th harmonic of highest fundamental frequency.
2. For above 1GHz, the EUT peak value was under average limit, therefore the Average value compliance with the average limit

Test Mode	IEEE 802.11g High CH	Temp/Hum	24(°C)/ 33%RH
Test Item	Harmonic	Test Date	December 7, 2017
Polarize	Vertical	Test Engineer	Jerry Chuang
Detector	Peak and Average	Test Voltage	120Vac / 60Hz

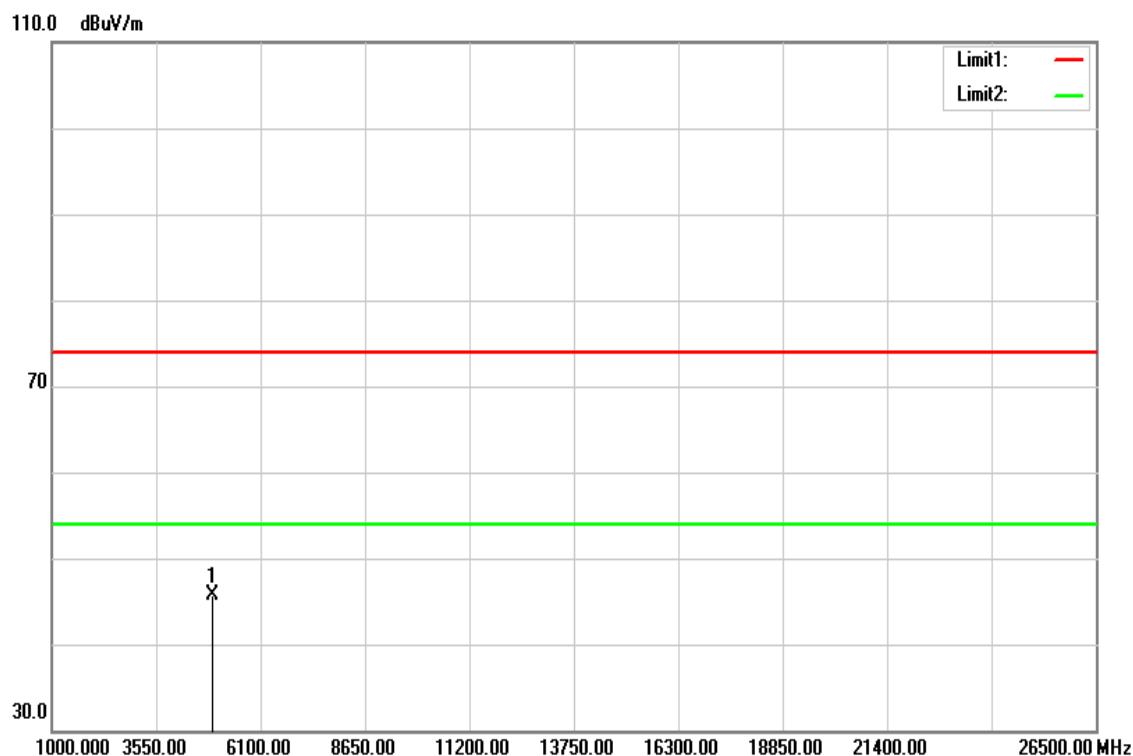

Frequency (MHz)	Reading (dBuV)	Correct Factor (dB/m)	Result (dBuV/m)	Limit (dBuV/m)	Margin (dB)	Remark
4925.000	41.08	4.55	45.63	74.00	-28.37	peak
N/A						

Remark:

1. Measuring frequencies from 1 GHz to the 10th harmonic of highest fundamental frequency.
2. For above 1GHz, the EUT peak value was under average limit, therefore the Average value compliance with the average limit

Test Mode	IEEE 802.11g High CH	Temp/Hum	24(°C)/ 33%RH
Test Item	Harmonic	Test Date	December 7, 2017
Polarize	Horizontal	Test Engineer	Jerry Chuang
Detector	Peak and Average	Test Voltage	120Vac / 60Hz

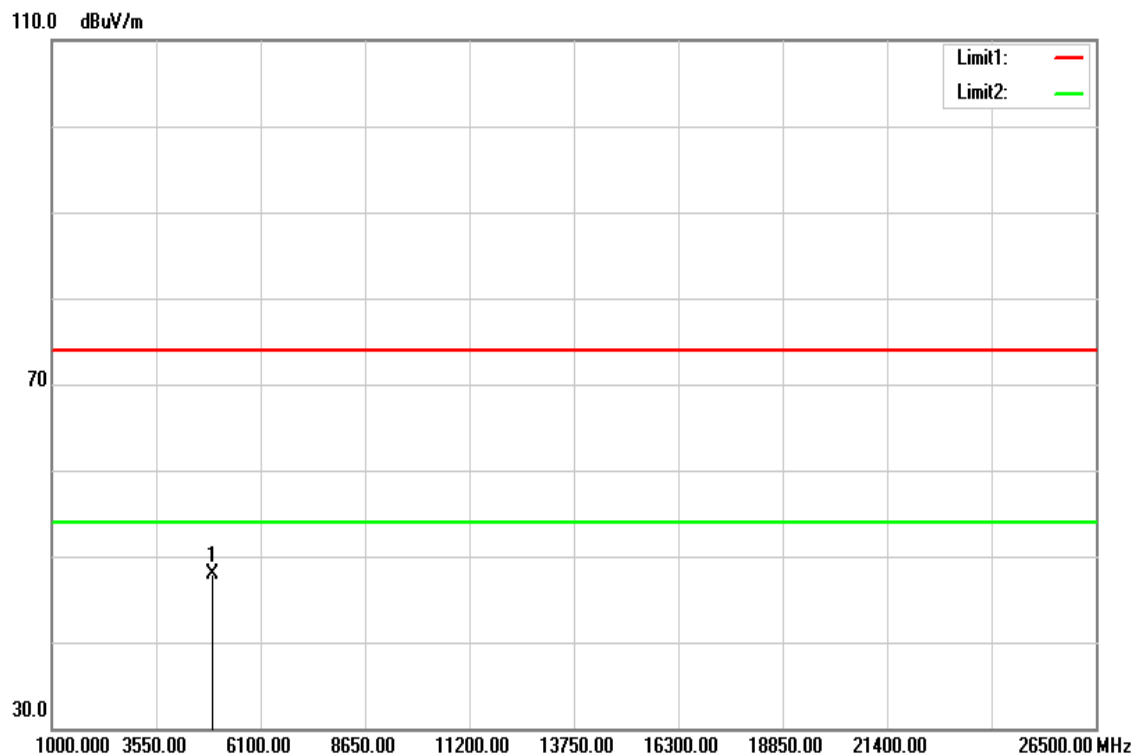

Frequency (MHz)	Reading (dBuV)	Correct Factor (dB/m)	Result (dBuV/m)	Limit (dBuV/m)	Margin (dB)	Remark
4925.000	43.38	4.55	47.93	74.00	-26.07	peak
N/A						

Remark:

1. Measuring frequencies from 1 GHz to the 10th harmonic of highest fundamental frequency.
2. For above 1GHz, the EUT peak value was under average limit, therefore the Average value compliance with the average limit

Test Mode	IEEE 802.11n HT20 Low CH	Temp/Hum	24(°C)/ 33%RH
Test Item	Harmonic	Test Date	December 7, 2017
Polarize	Vertical	Test Engineer	Jerry Chuang
Detector	Peak and Average	Test Voltage	120Vac / 60Hz

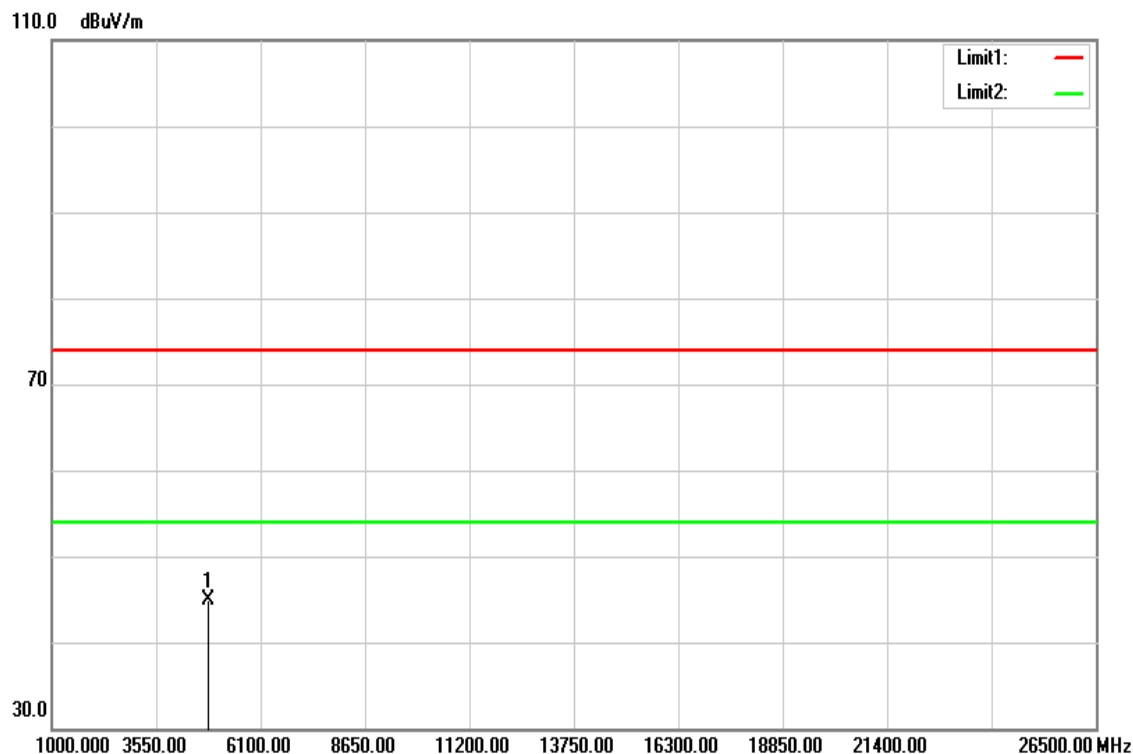

Frequency (MHz)	Reading (dBuV)	Correct Factor (dB/m)	Result (dBuV/m)	Limit (dBuV/m)	Margin (dB)	Remark
4827.000	40.45	4.38	44.83	74.00	-29.17	peak
N/A						

Remark:

1. Measuring frequencies from 1 GHz to the 10th harmonic of highest fundamental frequency.
2. For above 1GHz, the EUT peak value was under average limit, therefore the Average value compliance with the average limit

Test Mode	IEEE 802.11n HT20 Low CH	Temp/Hum	24(°C)/ 33%RH
Test Item	Harmonic	Test Date	December 7, 2017
Polarize	Horizontal	Test Engineer	Jerry Chuang
Detector	Peak and Average	Test Voltage	120Vac / 60Hz

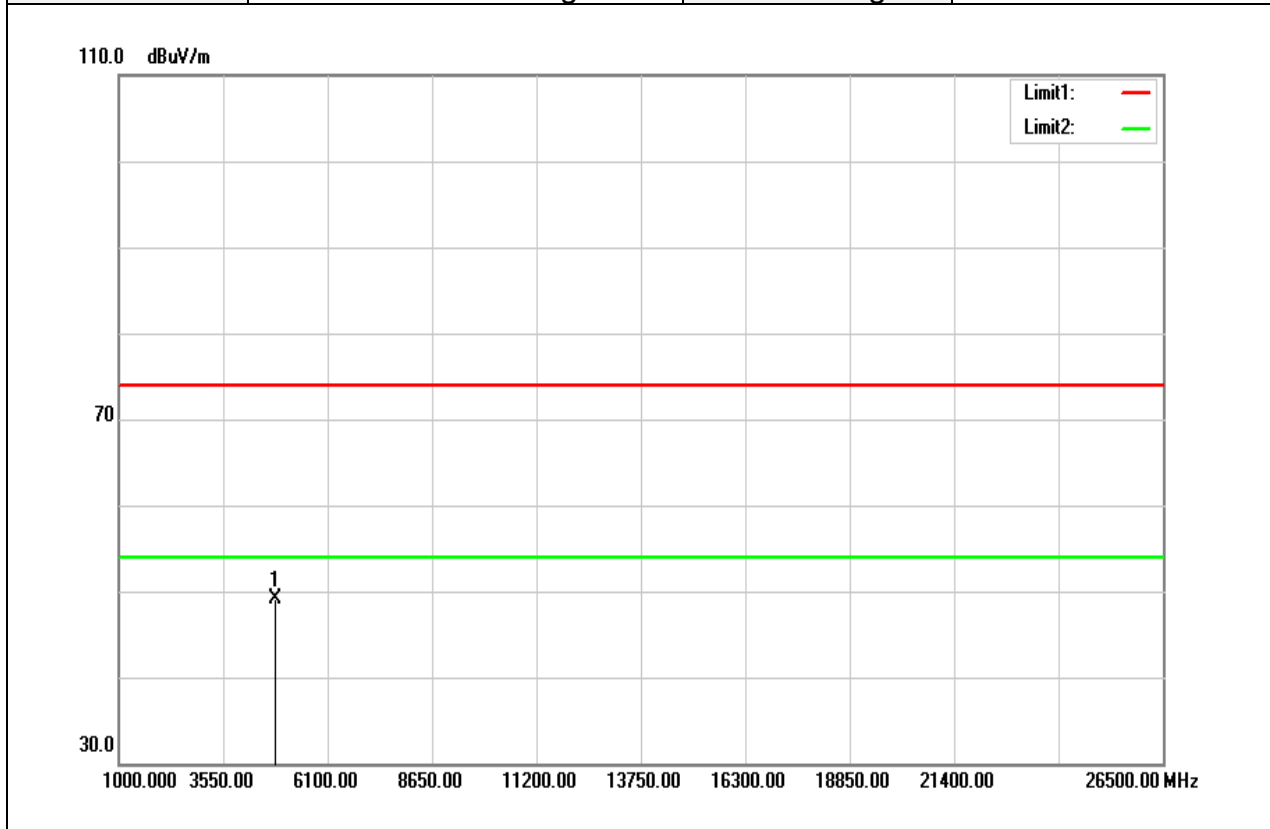

Frequency (MHz)	Reading (dBuV)	Correct Factor (dB/m)	Result (dBuV/m)	Limit (dBuV/m)	Margin (dB)	Remark
4820.000	44.68	4.36	49.04	74.00	-24.96	peak
N/A						

Remark:

1. Measuring frequencies from 1 GHz to the 10th harmonic of highest fundamental frequency.
2. For above 1GHz, the EUT peak value was under average limit, therefore the Average value compliance with the average limit

Test Mode	IEEE 802.11n HT20 Mid CH	Temp/Hum	24(°C)/ 33%RH
Test Item	Harmonic	Test Date	December 7, 2017
Polarize	Vertical	Test Engineer	Jerry Chuang
Detector	Peak and Average	Test Voltage	120Vac / 60Hz

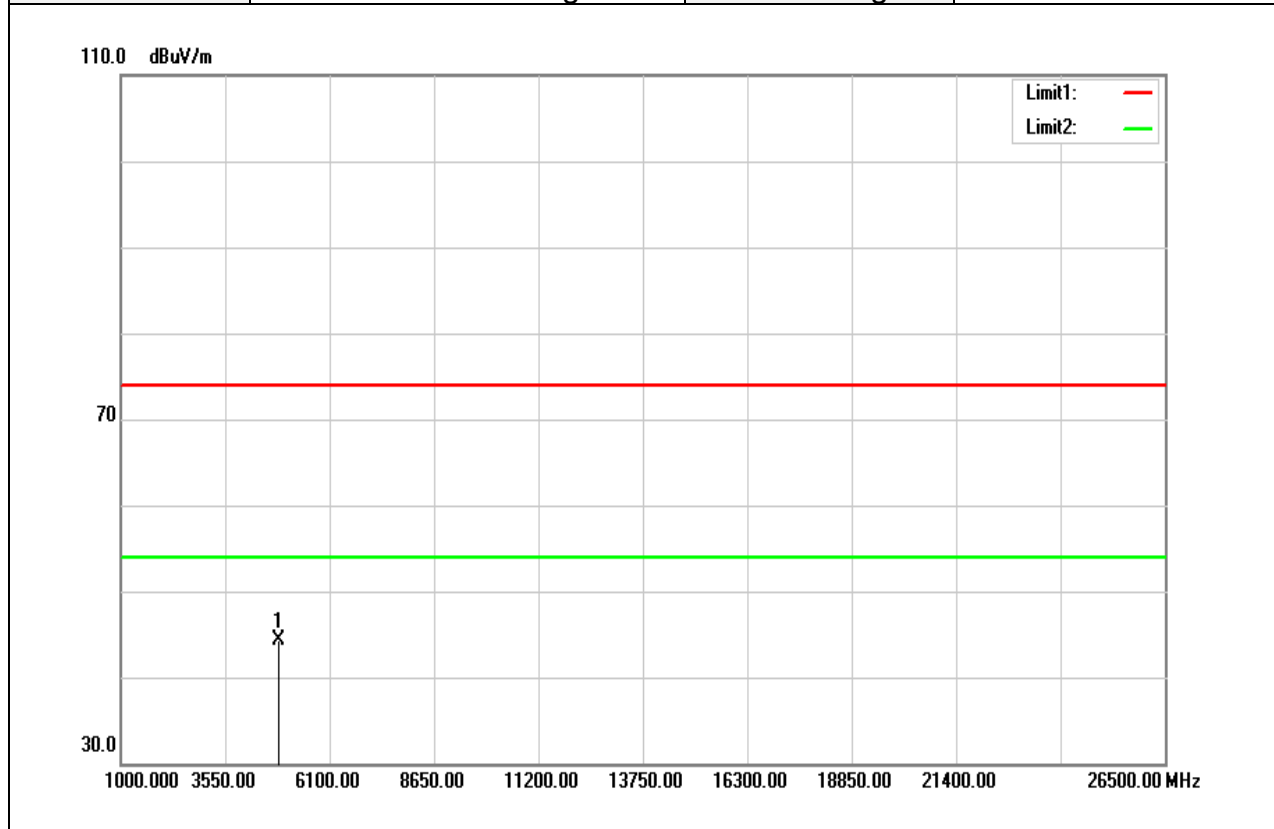

Frequency (MHz)	Reading (dBuV)	Correct Factor (dB/m)	Result (dBuV/m)	Limit (dBuV/m)	Margin (dB)	Remark
4874.000	39.85	4.47	44.32	74.00	-29.68	peak
N/A						

Remark:

1. Measuring frequencies from 1 GHz to the 10th harmonic of highest fundamental frequency.
2. For above 1GHz, the EUT peak value was under average limit, therefore the Average value compliance with the average limit

Test Mode	IEEE 802.11n HT20 Mid CH	Temp/Hum	24(°C)/ 33%RH
Test Item	Harmonic	Test Date	December 7, 2017
Polarize	Horizontal	Test Engineer	Jerry Chuang
Detector	Peak and Average	Test Voltage	120Vac / 60Hz

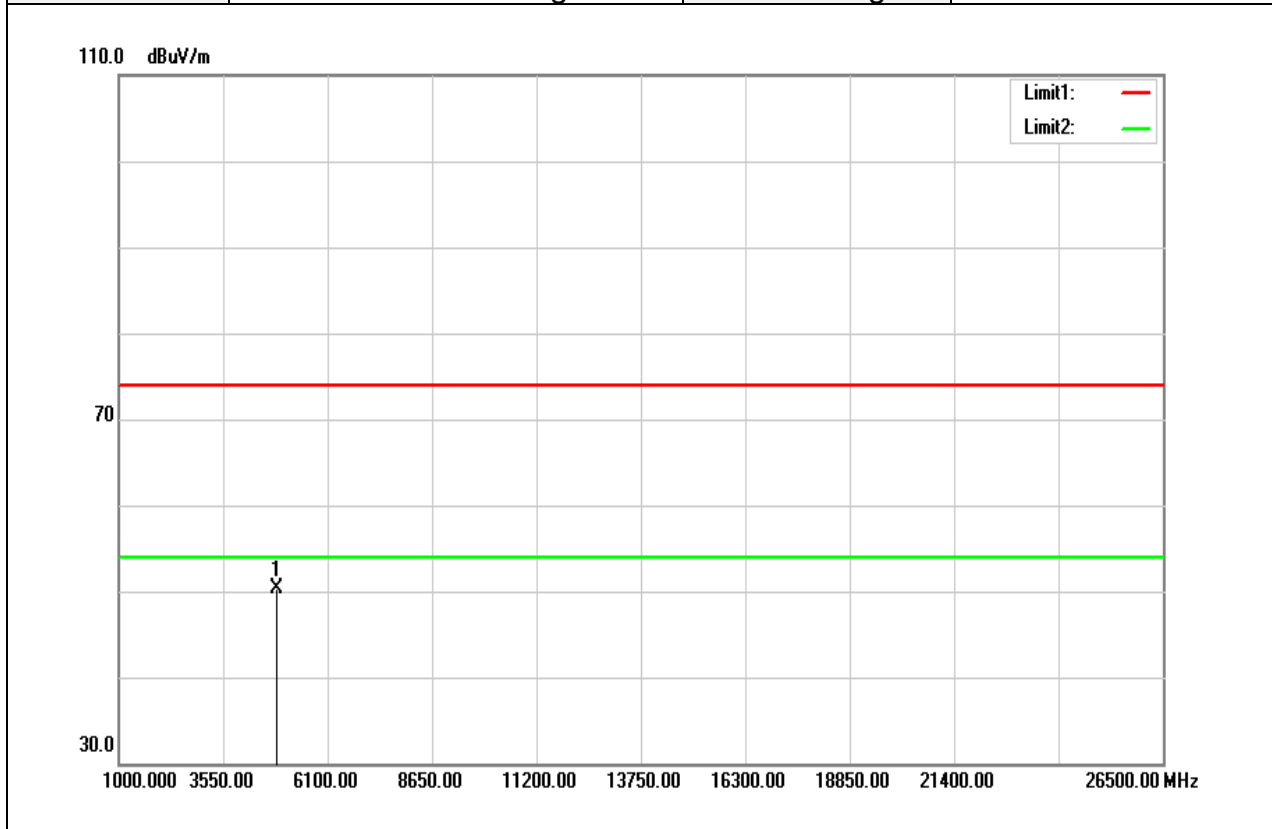

Frequency (MHz)	Reading (dBuV)	Correct Factor (dB/m)	Result (dBuV/m)	Limit (dBuV/m)	Margin (dB)	Remark
4869.000	45.89	4.45	50.34	74.00	-23.66	peak
N/A						

Remark:

1. Measuring frequencies from 1 GHz to the 10th harmonic of highest fundamental frequency.
2. For above 1GHz, the EUT peak value was under average limit, therefore the Average value compliance with the average limit

Test Mode	IEEE 802.11n HT20 High CH	Temp/Hum	24(°C)/ 33%RH
Test Item	Harmonic	Test Date	December 7, 2017
Polarize	Vertical	Test Engineer	Jerry Chuang
Detector	Peak and Average	Test Voltage	120Vac / 60Hz

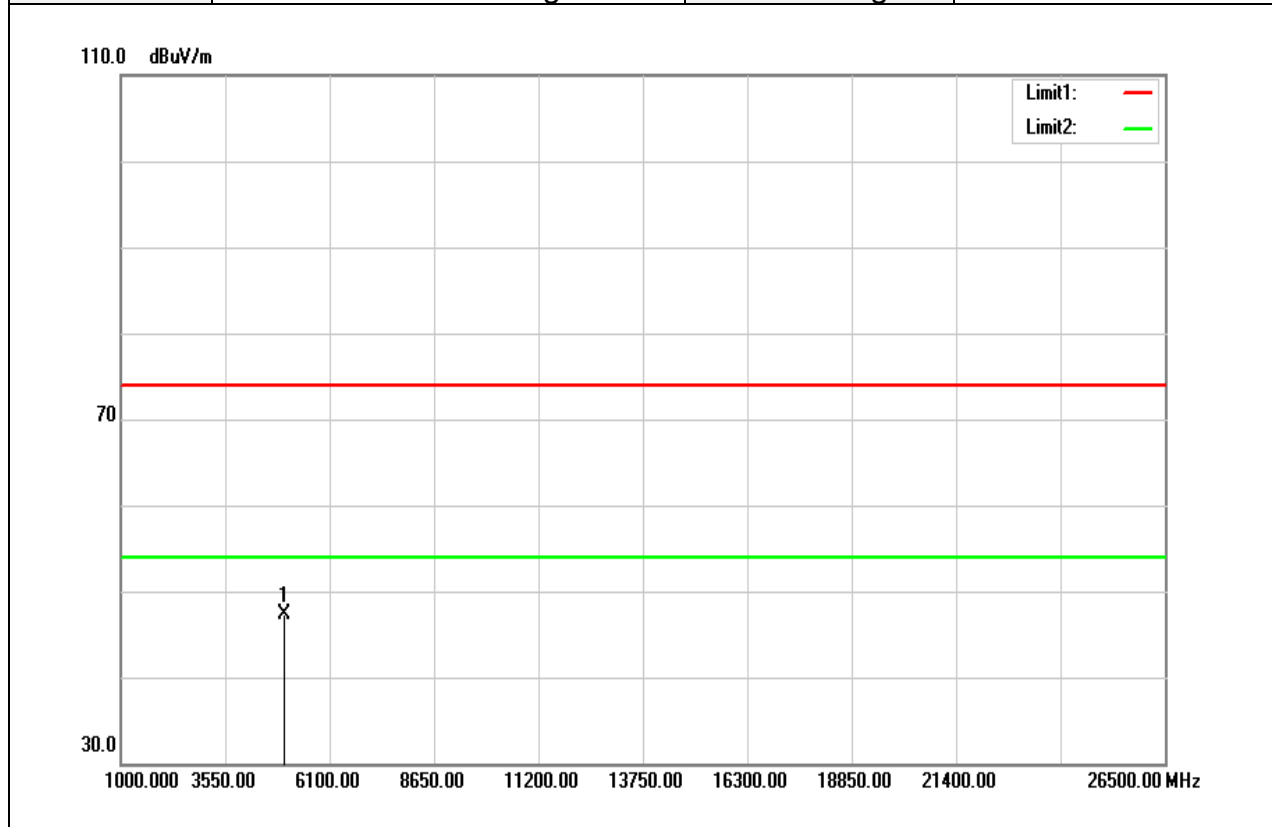

Frequency (MHz)	Reading (dBuV)	Correct Factor (dB/m)	Result (dBuV/m)	Limit (dBuV/m)	Margin (dB)	Remark
4995.000	42.71	4.67	47.38	74.00	-26.62	peak
N/A						

Remark:

1. Measuring frequencies from 1 GHz to the 10th harmonic of highest fundamental frequency.
2. For above 1GHz, the EUT peak value was under average limit, therefore the Average value compliance with the average limit

Test Mode	IEEE 802.11n HT20 High CH	Temp/Hum	24(°C)/ 33%RH
Test Item	Harmonic	Test Date	December 7, 2017
Polarize	Horizontal	Test Engineer	Jerry Chuang
Detector	Peak and Average	Test Voltage	120Vac / 60Hz

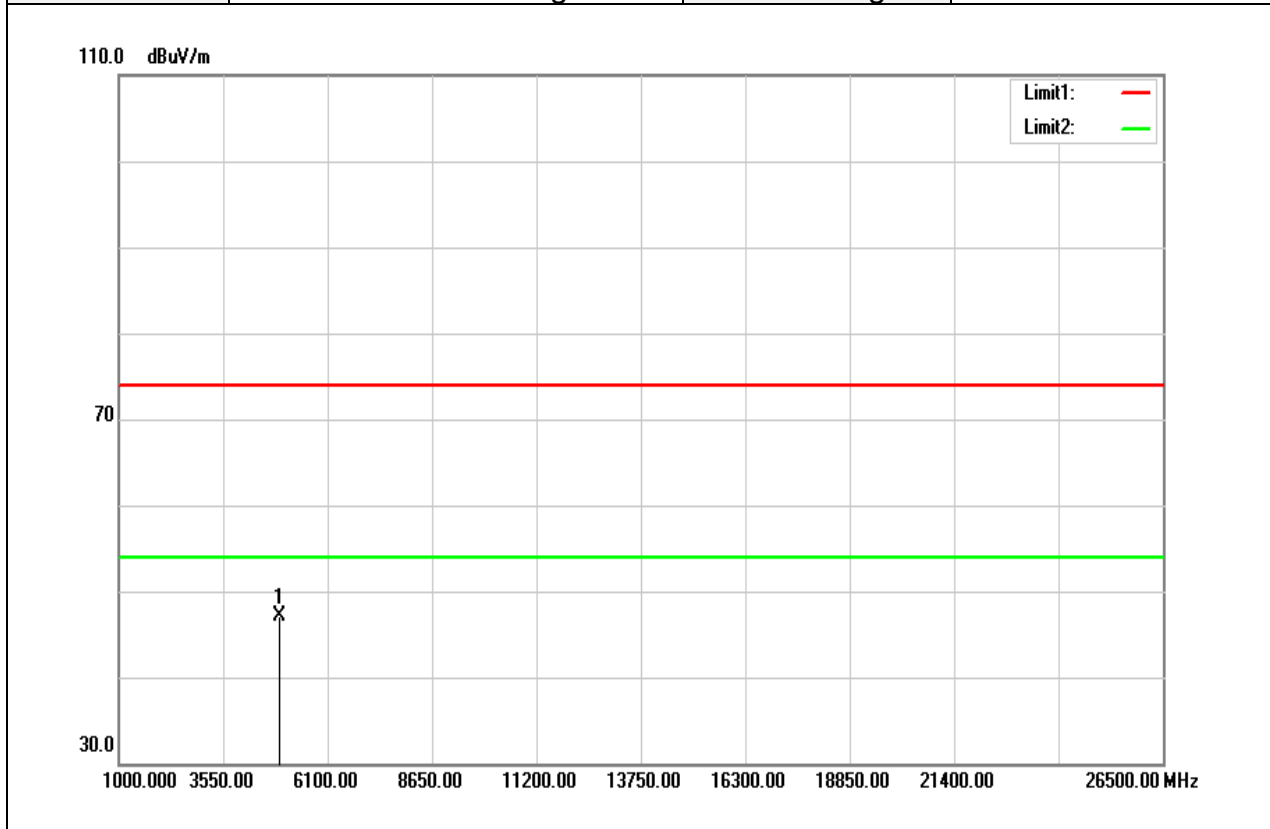

Frequency (MHz)	Reading (dBuV)	Correct Factor (dB/m)	Result (dBuV/m)	Limit (dBuV/m)	Margin (dB)	Remark
4925.000	42.55	4.55	47.10	74.00	-26.90	peak
N/A						

Remark:

1. Measuring frequencies from 1 GHz to the 10th harmonic of highest fundamental frequency.
2. For above 1GHz, the EUT peak value was under average limit, therefore the Average value compliance with the average limit

Test Mode	IEEE 802.11n HT40 Low CH	Temp/Hum	24(°C)/ 33%RH
Test Item	Harmonic	Test Date	December 7, 2017
Polarize	Vertical	Test Engineer	Jerry Chuang
Detector	Peak and Average	Test Voltage	120Vac / 60Hz

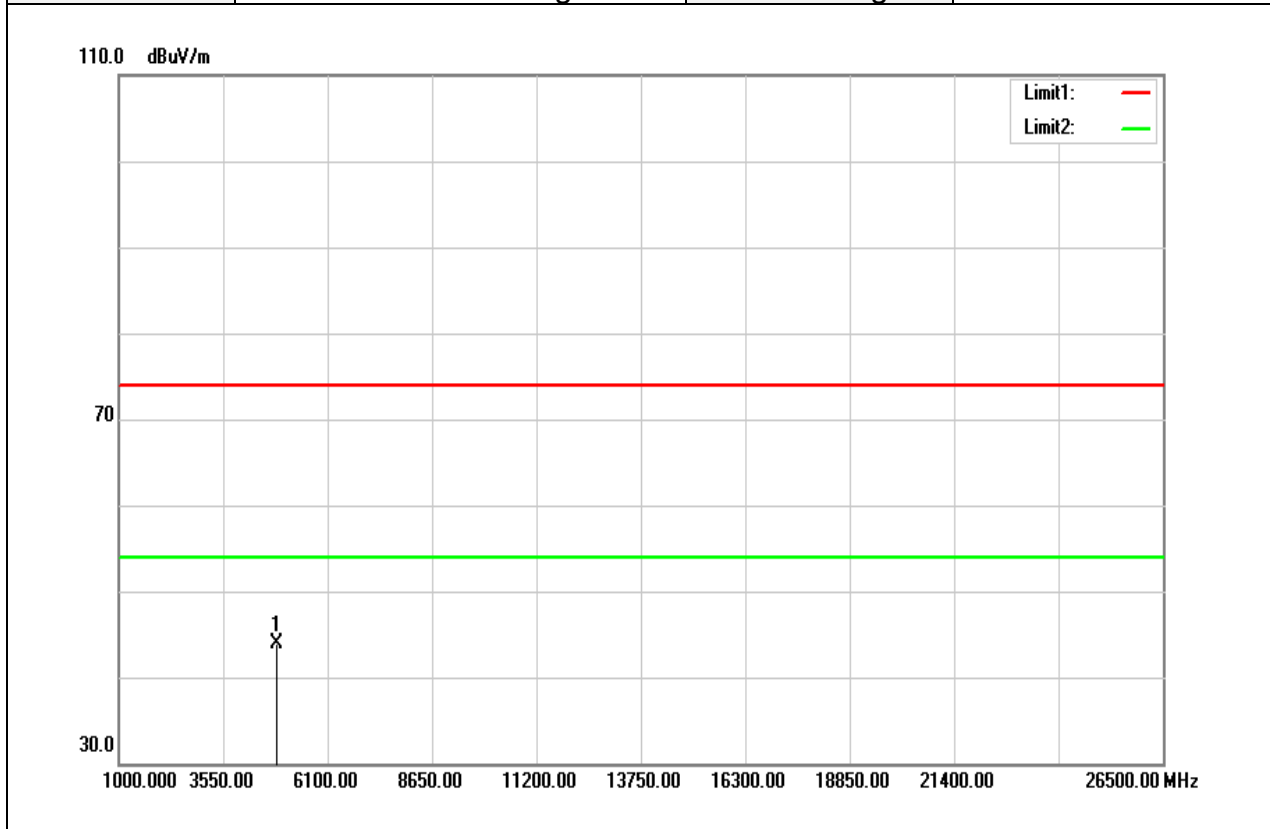

Frequency (MHz)	Reading (dBuV)	Correct Factor (dB/m)	Result (dBuV/m)	Limit (dBuV/m)	Margin (dB)	Remark
4844.000	39.48	4.41	43.89	74.00	-30.11	peak
N/A						

Remark:

1. Measuring frequencies from 1 GHz to the 10th harmonic of highest fundamental frequency.
2. For above 1GHz, the EUT peak value was under average limit, therefore the Average value compliance with the average limit

Test Mode	IEEE 802.11n HT40 Low CH	Temp/Hum	24(°C)/ 33%RH
Test Item	Harmonic	Test Date	December 7, 2017
Polarize	Horizontal	Test Engineer	Jerry Chuang
Detector	Peak and Average	Test Voltage	120Vac / 60Hz

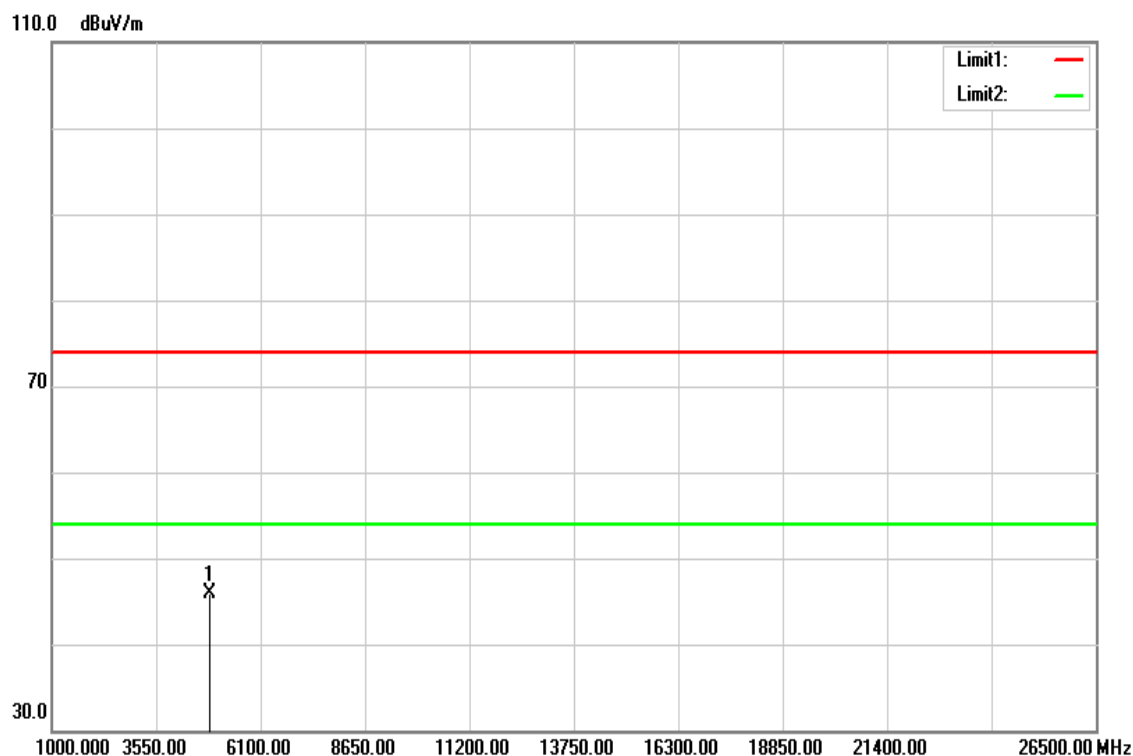

Frequency (MHz)	Reading (dBuV)	Correct Factor (dB/m)	Result (dBuV/m)	Limit (dBuV/m)	Margin (dB)	Remark
4848.000	41.53	4.43	45.96	74.00	-28.04	peak
N/A						

Remark:

1. Measuring frequencies from 1 GHz to the 10th harmonic of highest fundamental frequency.
2. For above 1GHz, the EUT peak value was under average limit, therefore the Average value compliance with the average limit

Test Mode	IEEE 802.11n HT40 Mid CH	Temp/Hum	24(°C)/ 33%RH
Test Item	Harmonic	Test Date	December 7, 2017
Polarize	Vertical	Test Engineer	Jerry Chuang
Detector	Peak and Average	Test Voltage	120Vac / 60Hz

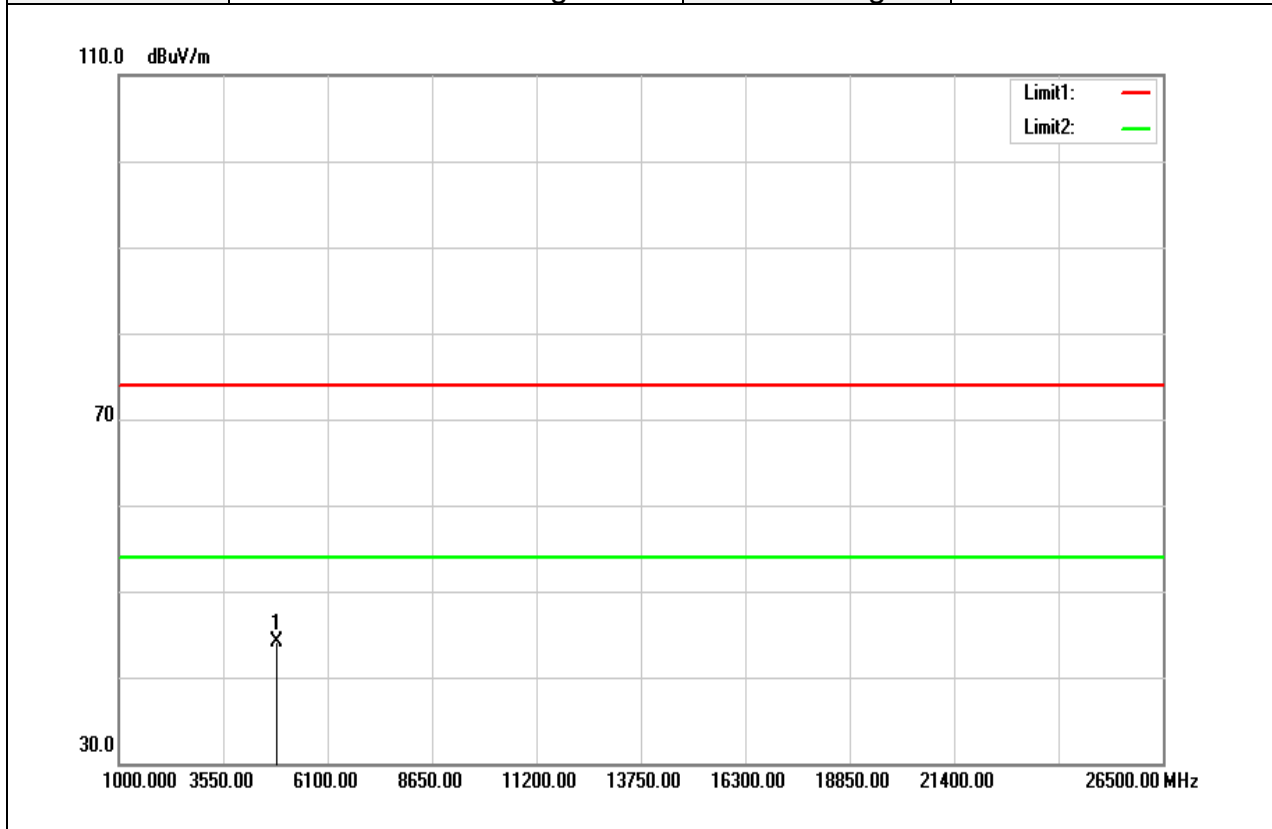

Frequency (MHz)	Reading (dBuV)	Correct Factor (dB/m)	Result (dBuV/m)	Limit (dBuV/m)	Margin (dB)	Remark
4874.000	39.69	4.47	44.16	74.00	-29.84	peak
N/A						

Remark:

1. Measuring frequencies from 1 GHz to the 10th harmonic of highest fundamental frequency.
2. For above 1GHz, the EUT peak value was under average limit, therefore the Average value compliance with the average limit

Test Mode	IEEE 802.11n HT40 Mid CH	Temp/Hum	24(°C)/ 33%RH
Test Item	Harmonic	Test Date	December 7, 2017
Polarize	Horizontal	Test Engineer	Jerry Chuang
Detector	Peak and Average	Test Voltage	120Vac / 60Hz

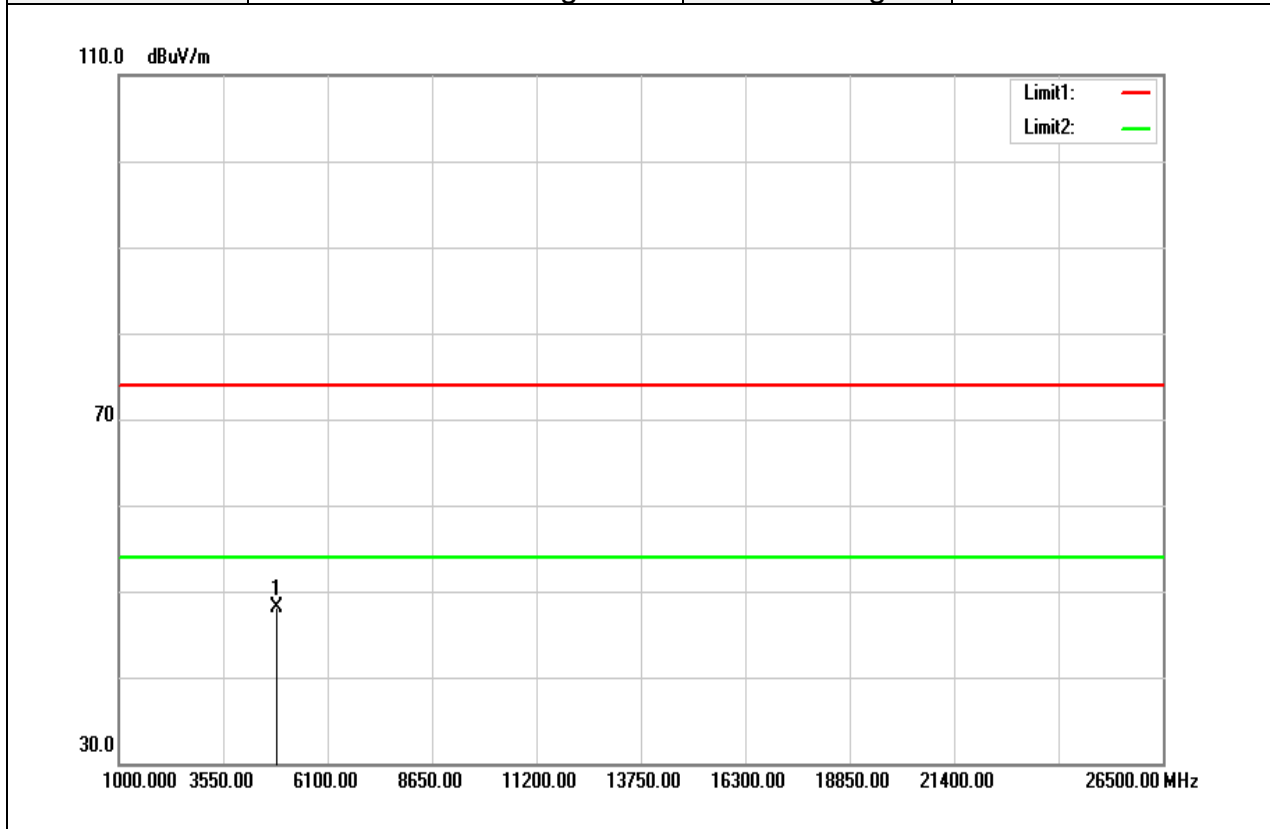

Frequency (MHz)	Reading (dBuV)	Correct Factor (dB/m)	Result (dBuV/m)	Limit (dBuV/m)	Margin (dB)	Remark
4869.000	43.56	4.45	48.01	74.00	-25.99	peak
N/A						

Remark:

1. Measuring frequencies from 1 GHz to the 10th harmonic of highest fundamental frequency.
2. For above 1GHz, the EUT peak value was under average limit, therefore the Average value compliance with the average limit

Test Mode	IEEE 802.11n HT40 High CH	Temp/Hum	24(°C)/ 33%RH
Test Item	Harmonic	Test Date	December 7, 2017
Polarize	Vertical	Test Engineer	Jerry Chuang
Detector	Peak and Average	Test Voltage	120Vac / 60Hz

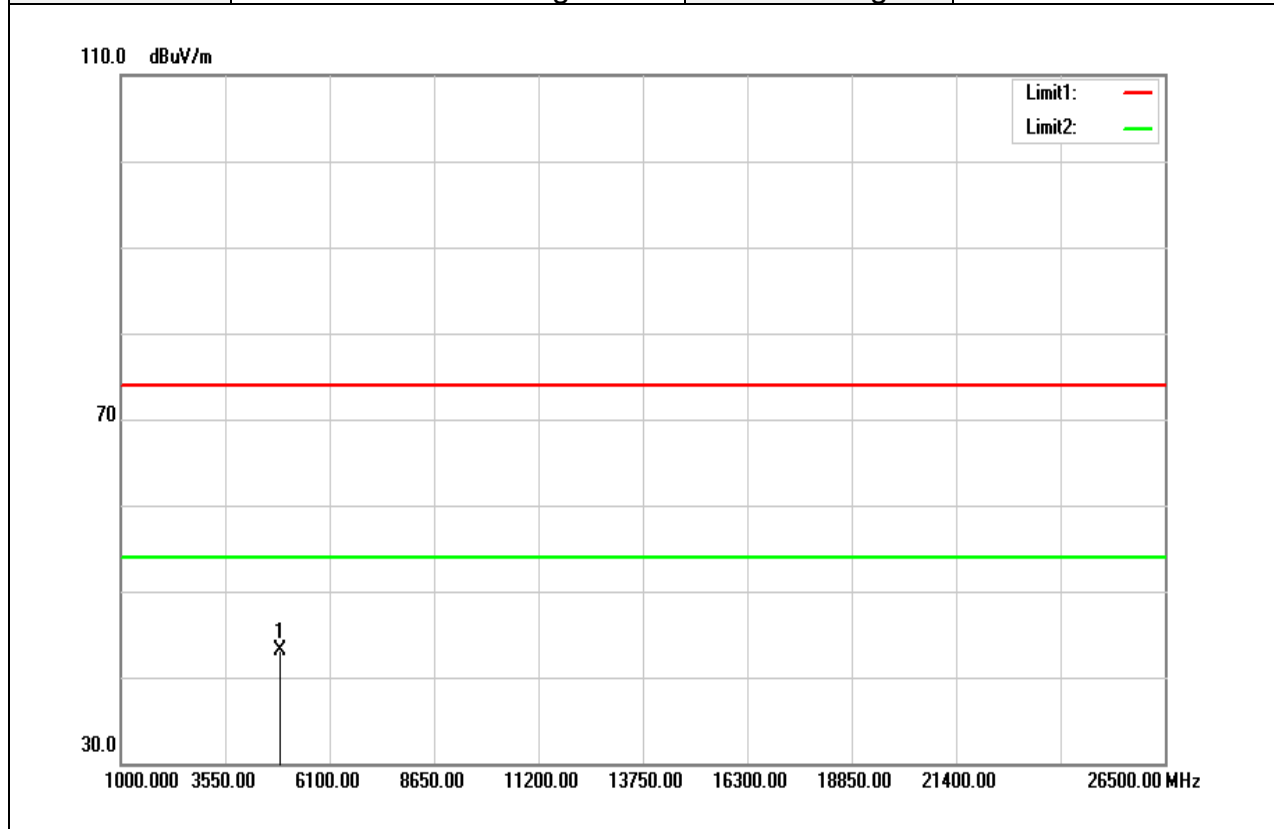

Frequency (MHz)	Reading (dBuV)	Correct Factor (dB/m)	Result (dBuV/m)	Limit (dBuV/m)	Margin (dB)	Remark
4904.000	38.57	4.51	43.08	74.00	-30.92	peak
N/A						

Remark:

1. Measuring frequencies from 1 GHz to the 10th harmonic of highest fundamental frequency.
2. For above 1GHz, the EUT peak value was under average limit, therefore the Average value compliance with the average limit

Test Mode	IEEE 802.11n HT40 High CH	Temp/Hum	24(°C)/ 33%RH
Test Item	Harmonic	Test Date	December 7, 2017
Polarize	Horizontal	Test Engineer	Jerry Chuang
Detector	Peak and Average	Test Voltage	120Vac / 60Hz

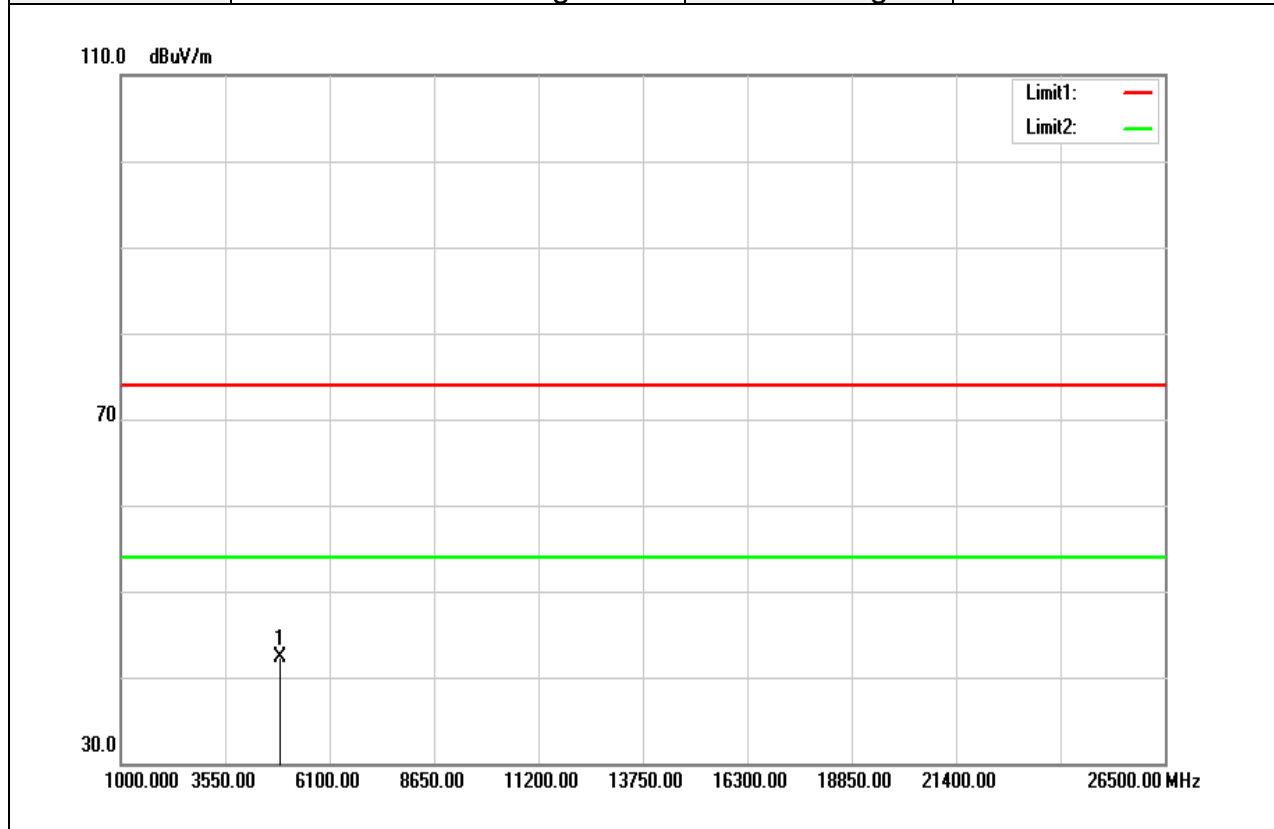

Frequency (MHz)	Reading (dBuV)	Correct Factor (dB/m)	Result (dBuV/m)	Limit (dBuV/m)	Margin (dB)	Remark
4904.000	37.71	4.51	42.22	74.00	-31.78	peak
N/A						

Remark:

1. Measuring frequencies from 1 GHz to the 10th harmonic of highest fundamental frequency.
2. For above 1GHz, the EUT peak value was under average limit, therefore the Average value compliance with the average limit