



# SAR TEST REPORT

**Test Report No. : 12803138H-D**

**Applicant** : Sony Corporation

**Type of Equipment** : UHF SYNTHESIZED TRANSMITTER

**Model No.** : UTX-B40

**FCC ID** : AK8UTXB40

**Test regulation** : FCC47CFR 2.1093

**Test Result** : Complied (Refer to SECTION 4)

**Reported SAR(1g) Value** : **The highest reported SAR(1g)**  
 Body : 0.17 W/kg

1. This test report shall not be reproduced in full or partial, without the written approval of UL Japan, Inc.
2. The results in this report apply only to the sample tested.
3. This sample tested is in compliance with the limits of the above regulation.
4. The test results in this report are traceable to the national or international standards.
5. This test report covers SAR technical requirements. It does not cover administrative issues such as Manual or non-SAR test related Requirements. (if applicable)
6. The all test items in this test report are conducted by UL Japan, Inc. Ise EMC Lab.
7. This test report must not be used by the customer to claim product certification, approval, or endorsement by NVLAP, NIST, or any agency of the Federal Government.
8. The information provided from the customer for this report is identified in SECTION 1.

**Date of test:** June 28 and July 9, 2019

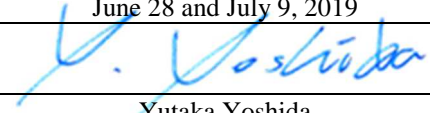
**Representative test engineer:**   
 Yutaka Yoshida  
 Engineer  
 Consumer Technology Division

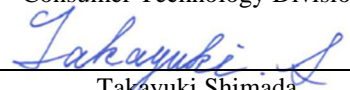
**Approved by :**   
 Takayuki Shimada  
 Leader  
 Consumer Technology Division



This laboratory is accredited by the NVLAP LAB CODE 200572-0, U.S.A. The tests reported herein have been performed in accordance with its terms of accreditation. \*As for the range of Accreditation in NVLAP, you may refer to the WEB address, [http://japan.ul.com/resources/emc\\_accredited/](http://japan.ul.com/resources/emc_accredited/)

- The testing in which "Non-accreditation" is displayed is outside the accreditation scopes in UL Japan.
- There is no testing item of "Non-accreditation".



<b>CONTENTS</b>	<b>PAGE</b>
<b>SECTION1: Customer information.....</b>	<b>4</b>
<b>SECTION2: Equipment under test (E.U.T.).....</b>	<b>4</b>
2.1 Identification of E.U.T. ....	4
2.2 Product description.....	4
<b>SECTION3: Test standard information.....</b>	<b>6</b>
3.1 Test Specification .....	6
3.2 Procedure.....	6
3.3 Exposure limit .....	7
3.4 SAR .....	7
3.5 Test Location .....	7
<b>SECTION4: Test result.....</b>	<b>8</b>
4.1 Result.....	8
4.2 Stand-alone SAR result .....	8
<b>SECTION5: Tune-up tolerance information and software information.....</b>	<b>9</b>
<b>SECTION6: RF Exposure Conditions (Test Configurations) .....</b>	<b>10</b>
6.1 Summary of the distance between antenna and surface of EUT.....	10
6.2 SAR test exclusion considerations according to KDB447498 D01.....	10
6.3 Procedure for SAR test position determination .....	12
6.4 Test position for Body setup.....	12
<b>SECTION7: Description of the operating mode.....</b>	<b>12</b>
7.1 Output Power and SAR test required.....	12
<b>SECTION8: Test surrounding .....</b>	<b>13</b>
8.1 Measurement uncertainty .....	13
<b>SECTION9: Parameter Check.....</b>	<b>14</b>
9.1 For SAR system check .....	15
9.2 For SAR measurement .....	16
<b>SECTION10: System Check confirmation.....</b>	<b>17</b>
<b>SECTION11: Measured and Reported (Scaled) SAR Results .....</b>	<b>18</b>
11.1 Radio microphone .....	18
<b>SECTION12: Test instruments .....</b>	<b>19</b>
<b>APPENDIX 1 : System Check.....</b>	<b>20</b>
<b>APPENDIX 2 : SAR Measurement data .....</b>	<b>26</b>
<b>APPENDIX 3 : System specifications.....</b>	<b>39</b>
<b>APPENDIX 4 : Photographs of test setup.....</b>	<b>131</b>

## **SECTION1: Customer information**

Company Name : Sony Global Manufacturing & Operations Corporation  
Address : 8-4 Shiomi Kisarazu-shi, Chiba, 292-0834 Japan  
Telephone Number : +81-438-37-4704  
Contact Person : Youhei Hisano

### **\*Remarks**

Sony Global Manufacturing & Operations Corporation (Subsidiary Company Name) is on behalf of the applicant: Sony Corporation.

The information provided from the customer is as follows;

- Applicant, Type of Equipment, Model No. on the cover and other relevant pages
- Operating/Test Mode(s) (Mode(s)) on all the relevant pages
- SECTION 1: Customer information
- SECTION 2: Equipment under test (E.U.T.)
- SECTION 5: Description of the operating mode

\* The laboratory is exempted from liability of any test results affected from the above information in SECTION 2 and 5.

## **SECTION2: Equipment under test (E.U.T.)**

### **2.1 Identification of E.U.T.**

#### **<Information of the EUT>**

Type of Equipment : UHF SYNTHESIZED TRANSMITTER  
Model No. : UTX-B40  
Serial No. : UC14(used for 470.125 MHz)  
UC25(used for 539.000 MHz)  
UC42(used for 607.875 MHz)  
UC90(used for 941.625 MHz / 950.625 MHz / 959.625 MHz)  
Rating : DC 3.0 V (2 x AA Batteries) , DC 5.0V (USB)  
Receipt Date of Sample : April 22, 2019  
Country of Mass-production : Korea  
Condition of EUT : Engineering prototype  
(Not for Sale: This sample is equivalent to mass-produced items.)  
Modification of EUT : No Modification by the test lab

### **2.2 Product description**

Model: UTX-B40 (referred to as the EUT in this report) is a UHF SYNTHESIZED TRANSMITTER.

#### **General Specification**

Clock frequency(ies) in the system : DSP: 12 MHz (SPXO)

### Radio Specification

Radio type	:	Transmitter
Modulation type	:	Frequency modulation
Emission designator	:	116KF3E
Necessary bandwidth	:	116 kHz = 2M + 2D where M: Maximum modulation frequency = 18 kHz D: Peak deviation = 40 kHz
Channel spacing	:	125 kHz
Frequency of operation	:	UTX-B40 (UC14) : 470.125 MHz - 541.875 MHz UTX-B40 (UC25) : 536.125 MHz - 607.875 MHz UTX-B40 (U90) : 941.625 MHz - 951.875 MHz 953.000 MHz - 956.125 MHz 956.625 MHz - 959.625 MHz
Clock frequency(ies)	:	PLL: 26 MHz (TCXO)
RF power	:	High: 30 mW, Low: 5 mW
Antenna type	:	1/4 Lambda Monopole antenna (whip type)
Antenna gain	:	2.14 dBi
Power Supply (radio part input)	:	DC 3.3 V, DC5.5 V
AF Specification	:	40 Hz - 18000 Hz, Maximum input: -24 dBV (MIC level, ATT 0 dB)

**SECTION3: Test standard information**

**3.1 Test Specification**

Title : **FCC47CFR 2.1093**  
Radiofrequency radiation exposure evaluation: portable devices.  
: **IEEE Std 1528-2013:**  
IEEE Recommended Practice for Determining the Peak Spatial-Average Specific Absorption Rate (SAR) in the Human Head from Wireless Communications Devices: Measurement Techniques.  
: **Published RF exposure KDB procedures**

- KDB447498D01(v06)** RF Exposure Procedures and Equipment Authorization Policies for Mobile and Portable Devices
- KDB447498D02(v02r01)** SAR Measurement Procedures for USB Dongle Transmitters
- KDB648474D04(v01r03)** SAR Evaluation Considerations for Wireless Handsets
- KDB941225D01(v03r01)** 3G SAR Measurement Procedures
- KDB941225D05(v02r05)** SAR Evaluation Considerations for LTE Devices
- KDB941225D06(v02r01)** SAR Evaluation Procedures for Portable Devices with Wireless Router Capabilities (Hot Spot SAR)
- KDB941225D07(v01r02)** SAR Evaluation Procedures for UMPC Mini-Tablet Devices
- KDB616217D04(v01r02)** SAR Evaluation Considerations for Laptop, Notebook, Netbook and Tablet Computers
- KDB865664D01(v01r04)** SAR Measurement Requirements for 100MHz to 6 GHz
- KDB248227D01(v02r02)** SAR Guidance for 802.11(Wi-Fi) Transmitters
- KDB206256D01(v02)** Basic Certification Requirements For Wireless Microphones

**Reference**

[1]SPEAG uncertainty document (AN 15-7/AN19-17) for DASY 5 System from SPEAG (Schmid & Partner Engineering AG).

**3.2 Procedure**

<b>Transmitter</b>	<b>Radio Microphone</b>
<b>Test Procedure</b>	Published RF exposure KDB procedures
<b>Category</b>	FCC47CFR 2.1093
Note: UL Japan, Inc. 's SAR Work Procedures 13-EM-W0429 and 13-EM-W0430	

### 3.3 Exposure limit

(A) Limits for Occupational/Controlled Exposure (W/kg)

Spatial Average (averaged over the whole body)	Spatial Peak (averaged over any 1g of tissue)	Spatial Peak (hands/wrists/feet/ankles averaged over 10g)
0.4	8.0	20.0

(B) Limits for General population/Uncontrolled Exposure (W/kg)

Spatial Average (averaged over the whole body)	Spatial Peak (averaged over any 1g of tissue)	Spatial Peak (hands/wrists/feet/ankles averaged over 10g)
0.08	1.6	4.0

**Occupational/Controlled Environments:** are defined as locations where there is exposure that may be incurred by people who are aware of the potential for exposure, (i.e. as a result of employment or occupation).

**General Population/Uncontrolled Environments:** are defined as locations where there is the exposure of individuals who have no knowledge or control of their exposure.

**NOTE:GENERAL POPULATION/UNCONTROLLED EXPOSURE  
SPATIAL PEAK(averaged over any 1g of tissue) LIMIT  
1.6 W/kg**

### 3.4 SAR

Specific Absorption Rate (SAR): The time derivative (rate) of the incremental energy (dW) absorbed by (dissipated in) an incremental mass (dm) contained in a volume element (dV) of a given density ( $\rho$ ), as shown in the following equation:

$$SAR = \frac{d}{dt} \left( \frac{dW}{dm} \right) = \frac{d}{dt} \left( \frac{dW}{\rho dV} \right)$$

SAR is expressed in units of watts per kilogram (W/kg) or equivalently milliwatts per gram (mW/g).

SAR is related to the E-field at a point by the following equation:

$$SAR = \frac{\sigma |E|^2}{\rho}$$

where

$\sigma$  = conductivity of the tissue (S/m)  
 $\rho$  = mass density of the tissue (kg/m<sup>3</sup>)  
E = rms E-field strength (V/m)

### 3.5 Test Location

\*Shielded room for SAR testings

UL Japan, Inc. Ise EMC Lab.

NVLAP Lab. code: 200572-0 / FCC Test Firm Registration Number: 199967 / ISED SAR Lab Company Number: 2973C

4383-326 Asama-cho, Ise-shi, Mie-ken 516-0021 JAPAN

Telephone : +81 596 24 8999

Facsimile : +81 596 24 8124

**UL Japan, Inc.**

**Ise EMC Lab.**

4383-326 Asama-cho, Ise-shi, Mie-ken 516-0021 JAPAN

Telephone: +81 596 24 8999

Facsimile: +81 596 24 8124

## **SECTION4: Test result**

### **4.1 Result**

Complied

Highest values at each band are listed next section.

### **4.2 Stand-alone SAR result**

#### **Reported SAR**

Measured SAR is scaled to the maximum tune-up tolerance limit by the following formulas.

Reported SAR= Measured SAR [W/kg] · Scaled factor

Maximum tune-up tolerance limit is by the specification from a customer.

\* Scaled factor = Maximum tune-up tolerance limit [mW] / Measured power [mW]

#### **Body SAR**

Mode	Frequency [MHz]	Measured average Power [dBm]	Tune-up upper Power [dBm]	Measured power [mW]	Maximum tune-up tolerance limit [mW]	Measured SAR [W/kg]	Scaled factor	Reported SAR [W/kg]
Radio Microphone	470.125	14.57	14.77	28.6	30.0	0.155	1.047	0.162
Radio Microphone	950.625	14.34	14.77	27.2	30.0	0.155	1.104	0.171

#### **Note(s):**

The sample used by the SAR test is not more than 2 dB lower than the maximum tune-up tolerance limit. That is, measured power is included the tune-up tolerance range.

Maximum tune-up tolerance limit is defined as maximum timed-average value. (Considering to maximum duty cycle)



**SECTION5: Tune-up tolerance information and software information**

Maximum tune-up tolerance limit

Mode	Band	Maximum tune-up tolerance limit [dBm]	Maximum tune-up tolerance limit [mW]
Radio microphone	470.125 - 607.875 MHz	14.77	30.0
Radio microphone	941.625 - 959.625 MHz	14.77	30.0

Maximum tune-up tolerance limit is defined as maximum timed-average value. (Considering to maximum duty cycle)

**Software setting**

\*The power value of the EUT was set for testing as follows (setting value might be different from product specification value);

Power settings: High (30 mW)

Software / version: 190415d

\*This setting of software is the worst case.

The test was performed with condition that obtained the maximum average power in pre-check.

Any conditions under the normal use do not exceed the condition of setting.

In addition, end users cannot change the settings of the output power of the product.

**SECTION6: RF Exposure Conditions (Test Configurations)**

**6.1 Summary of the distance between antenna and surface of EUT**

Test position	Distance
Front	5.9 mm
Rear	5.4 mm
Left	47.65 mm
Right	9.6 mm
Top	0.00 mm
Bottom	74.2 mm

\* Details are shown in appendix 4

**6.2 SAR test exclusion considerations according to KDB447498 D01**

The following is based on KDB447498D01.

1) The 1-g and 10-g SAR test exclusion thresholds for 100 MHz to 6 GHz at test separation distances  $\leq 50$  mm are determined by:

$$[(\text{max. power of channel, including tune-up tolerance, mW}) / (\text{min. test separation distance, mm})] \cdot [\sqrt{f(\text{GHz})}] \leq 3.0$$

for 1-g SAR and  $\leq 7.5$  for 10-g extremity SAR

1. The upper frequency of the frequency band was used in order to calculate standalone SAR test exclusion considerations.
2. Power and distance are rounded to the nearest mW and mm before calculation
3. The result is rounded to one decimal place for comparison
4. The test exclusions are applicable only when the minimum test separation distance is  $\leq 50$  mm and for transmission frequencies between 100 MHz and 6 GHz. When the minimum test separation distance is  $< 5$  mm, a distance of 5 mm is applied to determine SAR test exclusion. When the separation of antenna to EUT's surfaces and edges are  $\leq 50$  mm, the separation distance used for the SAR exclusion calculations is 5 mm.
5. "N/A" displayed on below exclusion calculation means not applicable this formula since distance between antenna and surface is  $> 50$  mm.

When the calculated threshold value by a numerical formula above-mentioned in the following table is 3.0 or less, SAR test is excluded.

SAR exclusion calculations for antenna  $< 50$ mm from the user

Antenna	Tx Interface	Frequency (MHz)	Output Power		Calculated Threshold Value					
			dBm	mW	Front	Rear	Left	Right	Top	Bottom
Fixed	Radio microphone	607.875	14.77	30	3.9	4.7	0.5	2.3	4.7	N/A
					-MEASURE-	-MEASURE-	-EXEMPT-	-EXEMPT-	-MEASURE-	
Fixed	Radio microphone	959.625	14.77	30	4.9	5.9	0.6	2.9	5.9	N/A
					-MEASURE-	-MEASURE-	-EXEMPT-	-EXEMPT-	-MEASURE-	

2) At 100 MHz to 6 GHz and for test separation distances > 50 mm, the SAR test exclusion threshold is determined according to the following.

- a)  $[(3 \cdot 50) / (\sqrt{f(\text{GHz})})] + (\text{test separation distance} - 50 \text{ mm}) \cdot (f(\text{MHz}) / 150)$  mW at > 100 MHz and  $\leq 1500$  MHz  
b)  $[(3 \cdot 50) / (\sqrt{f(\text{GHz})})] + (\text{test separation distance} - 50 \text{ mm}) \cdot 10$  mW at > 1500 MHz and  $\leq 6$  GHz

1. The upper frequency of the frequency band was used in order to calculate standalone SAR test exclusion considerations.
2. Power and distance are rounded to the nearest mW and mm before calculation
3. "N/A" displayed on below exclusion calculation means not applicable this formula since distance between antenna and surface is < 50 mm.

When output power is less than the calculated threshold value by a numerical formula above-mentioned in the following table, SAR test is excluded.

### SAR exclusion calculations for antenna >50mm from the user

Antenna	Tx Interface	Frequency (MHz)	Output Power		Calculated Threshold Value					
			dBm	mW	Front	Rear	Left	Right	Top	Bottom
Fixed	Radio microphone	607.875	14.77	30	N/A	N/A	N/A	N/A	N/A	290.5 mW -EXEMPT-
Fixed	Radio microphone	959.625	14.77	30	N/A	N/A	N/A	N/A	N/A	307.9 mW -EXEMPT-

Description of the Body setup

**6.3 Procedure for SAR test position determination**

-The tested procedure was performed according to the KDB 447498 D01 (Mobile and Portable Device RF Exposure Procedures and Equipment Authorization Policies).

**6.4 Test position for Body setup**

No.	Position	Test distance	Radio microphone
			Tested
1	Front	0mm	<input checked="" type="checkbox"/>
2	Rear	0mm	<input checked="" type="checkbox"/>
3	Left	0mm	<input type="checkbox"/>
4	Right	0mm	<input checked="" type="checkbox"/> *2
5	Top	0mm	<input checked="" type="checkbox"/> *1
6	Bottom	0mm	<input type="checkbox"/>

\*1 Top position is not a typical use of EUT, but testing is considered as a conservative SAR test mode.

\*2 Right position was considered as a representative and conservative SAR test mode for left and right side surfaces.

**SECTION7: Description of the operating mode**

**7.1 Output Power and SAR test required**

**Radio microphone**

Mode	Freq. (MHz)	Tune-up upper Power (dBm)	Measured average Power (dBm)	Initial test configuration	Note(s)
Radio microphone	470.125	14.77	14.57		
	539.000	14.77	14.64	Yes	
	607.875	14.77	14.49		

Mode	Freq. (MHz)	Tune-up upper Power (dBm)	Measured average Power (dBm)	Initial test configuration	Note(s)
Radio microphone	941.625	14.77	14.36	Yes	
	950.625	14.77	14.34		
	959.625	14.77	14.27		

**UL Japan, Inc.**

**Ise EMC Lab.**

4383-326 Asama-cho, Ise-shi, Mie-ken 516-0021 JAPAN

Telephone: +81 596 24 8999

Facsimile: +81 596 24 8124

**SECTION8: Test surrounding**

**8.1 Measurement uncertainty**

This measurement uncertainty budget is suggested by IEEE Std 1528(2013) and IEC62209-2:2010, and determined by Schmid & Partner Engineering AG (DASY5 Uncertainty Budget). Per KDB 865664 D01 SAR Measurement 100 MHz to 6 GHz Section 2.8.1., when the highest measured SAR(1g) within a frequency band is < 1.5W/kg, the extensive SAR measurement uncertainty analysis described in IEEE Std.1528 (2013) is not required in SAR reports submitted for equipment approval.

<0.3 – 3GHz range Body>

Error Description	Uncertai value ±	Probability distribution	divisor	(ci) 1g	Standard (1g)
<b>Measurement System</b>					
Probe calibration	± 6.00	Normal	1	1	± 6.00
Axial isotropy of the probe	± 4.7	Rectangular	√3	0.7	± 1.9
Spherical isotropy of the probe	± 9.6	Rectangular	√3	0.7	± 3.9
Boundary effects	± 1.0	Rectangular	√3	1	± 0.6
Probe linearity	± 4.7	Rectangular	√3	1	± 2.7
Detection limit	± 1.0	Rectangular	√3	1	± 0.6
Modulation response	± 2.4	Rectangular	√3	1	± 1.4
Readout electronics	± 0.3	Normal	1	1	± 0.3
Response time	± 0.8	Rectangular	√3	1	± 0.5
Integration time	± 2.6	Rectangular	√3	1	± 1.5
RF ambient Noise	± 3.0	Rectangular	√3	1	± 1.7
RF ambient Reflections	± 3.0	Rectangular	√3	1	± 1.7
Probe Positioner	± 0.4	Rectangular	√3	1	± 0.2
Probe positioning	± 2.9	Rectangular	√3	1	± 1.7
Max.SAR Eval.	± 2.0	Rectangular	√3	1	± 1.2
<b>Test Sample Related</b>					
Device positioning	± 2.9	Normal	1	1	± 2.9
Device holder uncertainty	± 3.6	Normal	1	1	± 3.6
Power drift	± 5.0	Rectangular	√3	1	± 2.9
Power Scaling	+ 0.0	Rectangular	√3	1	± 0.0
<b>Phantom and Setup</b>					
Phantom uncertainty	± 6.1	Rectangular	√3	1	± 3.5
Algorithm for correcting SAR for deviations in permittivity and conductivity	± 1.9	Rectangular	√3	1	± 1.1
Liquid conductivity (meas.)	+ 1.3	Rectangular	√3	0.78	+ 0.6
Liquid permittivity (meas.)	+ 1.1	Rectangular	√3	0.26	- 0.2
Liquid conductivity - temp.unc (below 2deg.C.)	± 5.2	Rectangular	√3	0.78	± 2.3
Liquid permittivity - temp.unc (below 2deg.C.)	± 0.8	Rectangular	√3	0.23	± 0.1
<b>Combined Standard Uncertainty</b>					± <b>11.170</b>
<b>Expanded Uncertainty (k=2)</b>					± <b>22.3</b>

\*. Table of uncertainties are listed for ISO/IEC 17025.

## **SECTION9: Parameter Check**

The dielectric parameters were checked prior to assessment using the DAK dielectric probe kit.  
The dielectric parameters measurement is reported in each correspondent section.

According to KDB865664 D01, +/- 5% tolerances are required for  $\epsilon_r$  and  $\sigma$  and then below table which is the target value of the simulated tissue liquid is quoted from KDB865664 D01.

Target Frequency (MHz)	Head		Body	
	$\epsilon_r$	$\sigma$ (S/m)	$\epsilon_r$	$\sigma$ (S/m)
150	52.3	0.76	61.9	0.80
300	45.3	0.87	58.2	0.92
450	43.5	0.87	56.7	0.94
835	41.5	0.90	55.2	0.97
900	41.5	0.97	55.0	1.05
915	41.5	0.98	55.0	1.06
1450	40.5	1.20	54.0	1.30
1610	40.3	1.29	53.8	1.40
1800 – 2000	40.0	1.40	53.3	1.52
2450	39.2	1.80	52.7	1.95
3000	38.5	2.40	52.0	2.73
5800	35.3	5.27	48.2	6.00

( $\epsilon_r$  = relative permittivity,  $\sigma$  = conductivity and  $\rho = 1000 \text{ kg/m}^3$ )

**9.1 For SAR system check**

DIELECTRIC PARAMETERS MEASUREMENT RESULTS											
Date	Ambient Temp. [deg.c]	Relative Humidity [%]	Liquid type	Liquid Temp. [deg.c]	Measured Frequency [MHz]	Parameters	Target Value	Measured	Deviation [%]	Limit [%]	Remark
2019/6/28	24.0	45	HSL450	23.5	450	$\sigma$ [mho/m]	0.87	0.88	1.0	+/-5	*1
						$\epsilon_r$	43.5	43.5	0.0	+/-5	
2019/6/28	24.0	45	HBBL600-10000	23.5	600	$\sigma$ [mho/m]	0.88	0.89	1.3	+/-5	*2
						$\epsilon_r$	42.7	42.6	-0.3	+/-5	
2019/7/9	24.0	45	HBBL600-10000	23.5	900	$\sigma$ [mho/m]	0.97	0.95	-2.3	+/-5	*1
						$\epsilon_r$	41.5	41.5	0.0	+/-5	

$\sigma$  : Conductivity /  $\epsilon_r$ : Relative Permittivity

\*1 The Target value is a parameter defined in KDB 865664D01.

\*2 The dielectric parameters should be linearly interpolated between the closest pair of target frequencies to determine the applicable dielectric parameters corresponding to the device test frequency.

**Correlation confirmation with measured TSL parameters of the calibration certificate of system check dipoles (Refer to Appendix 3)**

+/- 6% limit for deviation provided by manufacture tolerances are required for  $\epsilon_r$  and  $\sigma$  and then below table which is the target value of the simulated tissue liquid is quoted from data measured TSL parameters of dipole calibration.

Freq [MHz]	Model,S/N	Head	
		$\sigma$	$\epsilon_r$
450	D450,1051	0.87	44.4
600	D600,1003	0.87	41.5
900	D900,1d168	0.94	40.6

DIELECTRIC PARAMETERS MEASUREMENT RESULTS											
Date	Ambient Temp. [deg.c]	Relative Humidity [%]	Liquid type	Liquid Temp. [deg.c]	Measured Frequency [MHz]	Parameters	Target Value*1	Measured	Deviation [%]	Limit [%]	Remark
2019/6/28	24.0	45	HSL450	23.5	450	$\sigma$ [mho/m]	0.87	0.88	1.0	+/-6	
						$\epsilon_r$	44.4	43.5	-2.0	+/-6	
2019/6/28	24.0	45	HBBL600-10000	23.5	600	$\sigma$ [mho/m]	0.87	0.89	2.7	+/-6	
						$\epsilon_r$	41.5	42.6	2.6	+/-6	
2019/7/9	24.0	45	HBBL600-10000	23.5	900	$\sigma$ [mho/m]	0.94	0.95	0.8	+/-6	
						$\epsilon_r$	40.6	41.5	2.3	+/-6	

$\epsilon_r$ : Relative Permittivity /  $\sigma$  : Conductivity

\*1 The Target value is a parameter defined in each Dipole.

## 9.2 For SAR measurement

DIELECTRIC PARAMETERS MEASUREMENT RESULTS											
Date	Ambient Temp. [deg.c]	Relative Humidity [%]	Liquid type	Liquid Temp. [deg.c]	Measured Frequency [MHz]	Parameters	Target Value	Measured	Deviation [%]	Limit [%]	Remark
2019/6/28	24.0	45	HSL450	23.5	470.125	$\sigma$ [mho/m]	0.87	0.88	0.7	+/-5	*1
						$\epsilon_r$	43.4	43.4	0.1	+/-5	
2019/6/28	24.0	45	HSL450	23.5	539	$\sigma$ [mho/m]	0.88	0.89	0.9	+/-5	*1
						$\epsilon_r$	43.0	43.2	0.4	+/-5	
2019/6/28	24.0	45	HBBL600-10000	23.5	607.875	$\sigma$ [mho/m]	0.88	0.89	<b>1.3</b>	+/-5	*1
						$\epsilon_r$	42.7	42.5	-0.4	+/-5	
2019/7/9	24.0	45	HBBL600-10000	23.5	941.625	$\sigma$ [mho/m]	0.99	0.98	-0.8	+/-5	*1
						$\epsilon_r$	41.5	41.7	0.7	+/-5	
2019/7/9	24.0	45	HBBL600-10000	23.5	950.625	$\sigma$ [mho/m]	0.99	0.99	-0.3	+/-5	*1
						$\epsilon_r$	41.4	41.8	1.0	+/-5	
2019/7/9	24.0	45	HBBL600-10000	23.5	959.625	$\sigma$ [mho/m]	1.00	1.00	0.2	+/-5	*1
						$\epsilon_r$	41.4	41.9	<b>1.1</b>	+/-5	

$\sigma$  : Conductivity /  $\epsilon_r$ : Relative Permittivity

\*1 The dielectric parameters should be linearly interpolated between the closest pair of target frequencies to determine the applicable dielectric parameters corresponding to the device test frequency.



**SECTION10: System Check confirmation**

The measurements were performed in the flat section of the TWIN SAM or ELI phantom, shell thickness: 2.0 ±0.2 mm (bottom plate) filled with Body or Head simulating liquid of the following parameters.

The depth of tissue-equivalent liquid in a phantom must be ≥ 15.0 cm ± 0.5 cm for SAR measurements ≤ 3 GHz and ≥ 10.0 cm ± 0.5 cm for measurements > 3 GHz.

The DASY system with an E-Field Probe was used for the measurements.

The dipole was mounted on the small tripod so that the dipole feed point was positioned below the center marking of the flat phantom section and the dipole was oriented parallel to the body axis (the long side of the phantom).

The standard measuring distance was 10 mm (above 1GHz to 6GHz) and 15 mm (below 1GHz) from dipole center to the simulating liquid surface.

The coarse grid with a grid spacing of 12 mm (1GHz to 3GHz) and 15 mm (below 1GHz) was aligned with the dipole.

For 5 GHz band - The coarse grid with a grid spacing of 10 mm was aligned with the dipole.

Special 7x7x7 (below 3 GHz) and/or 8x8x7 (above 3 GHz) fine cube was chosen for the cube.

Distance between probe sensors and phantom surface was set to 3 mm.

For 5 GHz band - Distance between probe sensors and phantom surface was set to 2.5 mm

The dipole input power (forward power) was 100 mW(For 5GHz band) or 250 mW(For other band).

The results are normalized to 1 W input power.

**Target Value**

Freq [MHz]	Model,S/N	Head	
		(SPEAG) 1g [W/kg]	(SPEAG) 10g[W/kg]
450	D450,1051	4.48	3.00
600	D600,1003	6.44	4.20
900	D900,1d168	10.52	6.72

Date Tested	Test Freq	Model,S/N	T.S. Liquid	Measured Results		Target (Ref. Value)	Delta ±10 %	
				Zoom Scan	Normalize to 1 W			
2019/6/28	450	D450,1051	Head	1g	1.20	4.8	4.48	7.1
				10g	0.79	3.2	3.00	5.5
2019/6/28	600	D600,1003	Head	1g	1.66	6.6	6.44	3.1
				10g	1.08	4.32	4.20	2.9
2019/7/9	900	D900,1d168	Head	1g	2.67	10.7	10.52	1.5
				10g	1.73	6.92	6.72	3.0

\* The target(reference) SAR values can be obtained from the calibration certificate of system validation dipoles(Refer to Appendix 3). The target SAR values are SAR measured value in the calibration certificate scaled to 1W.

## SECTION11: Measured and Reported (Scaled) SAR Results

SAR Test Reduction criteria are as follows

- **KDB 447498 D01 (General RF Exposure Guidance):**

Testing of other required channels within the operating mode of a frequency band is not required when the reported 1-g or 10-g SAR for the mid-band or highest output power channel is:

- ◇  $\leq 0.8$  W/kg or 2.0 W/kg, for 1-g or 10-g respectively, when the transmission band is  $\leq 100$  MHz
- ◇  $\leq 0.6$  W/kg or 1.5 W/kg, for 1-g or 10-g respectively, when the transmission band is between 100 MHz and 200 MHz
- ◇  $\leq 0.4$  W/kg or 1.0 W/kg, for 1-g or 10-g respectively, when the transmission band is  $\geq 200$  MHz

- According to Notice 2016-DRS001 based on the IEEE1528 and IEC 62209 requirements, the low, mid and high frequency channels for the configuration with the highest SAR value must be tested regardless of the SAR value measured.
- When reported SAR value is exceed 1.2W/kg(if any), device holder perturbation verification is required; however, since distance between device holder and antenna of EUT is enough, it was not conducted.
- Reported SAR= Measured SAR [W/kg] · Scaled factor  
\* Scaled factor = Maximum tune-up tolerance limit [mW] / Measured power [mW]
- Maximum tune-up tolerance limit is by the specification from a customer.

### 11.1 Radio microphone

Test Position	Dist. (mm)	Freq. (MHz)	Power (dBm)		Scaled factor	1-g SAR (W/kg)	
			Tune-up upper Power	Measured average Power		Meas.	Reported
Front	0	470.125	14.77	14.57	1.047		
		539.000	14.77	14.64	1.030	0.155	0.160
		607.875	14.77	14.49	1.067		
Rear	0	470.125	14.77	14.57	1.047		
		539.000	14.77	14.64	1.030	0.132	0.136
		607.875	14.77	14.49	1.067		
Right	0	470.125	14.77	14.57	1.047	0.155	0.1623
		539.000	14.77	14.64	1.030	0.157	0.1618
		607.875	14.77	14.49	1.067	0.071	0.076
Top	0	470.125	14.77	14.57	1.047		
		539.000	14.77	14.64	1.030	0.100	0.103
		607.875	14.77	14.49	1.067		

Test Position	Dist. (mm)	Freq. (MHz)	Power (dBm)		Scaled factor	1-g SAR (W/kg)	
			Tune-up upper Power	Measured average Power		Meas.	Reported
Front	0	941.625	14.77	14.36	1.099	0.146	0.160
		950.625	14.77	14.34	1.104	0.155	0.171
		959.625	14.77	14.27	1.122	0.151	0.169
Rear	0	941.625	14.77	14.36	1.099	0.142	0.156
		950.625	14.77	14.34	1.104		
		959.625	14.77	14.27	1.122		
Right	0	941.625	14.77	14.36	1.099	0.105	0.115
		950.625	14.77	14.34	1.104		
		959.625	14.77	14.27	1.122		
Top	0	941.625	14.77	14.36	1.099	0.056	0.062
		950.625	14.77	14.34	1.104		
		959.625	14.77	14.27	1.122		

UL Japan, Inc.

Ise EMC Lab.

4383-326 Asama-cho, Ise-shi, Mie-ken 516-0021 JAPAN

Telephone: +81 596 24 8999

Facsimile: +81 596 24 8124

**SECTION12: Test instruments**

Control No.	Instrument	Manufacturer	Model No	Serial No	Test Item	Calibration Date * Interval(month)
MDA-09	Dipole Antenna	Schmid&Partner Engineering AG	D450V3	1051	SAR	2018/09/10 * 12
A2588	Dipole Antenna	Schmid&Partner Engineering AG	D900V2	1d168	SAR(D900)	2018/09/18 * 12
MDA-21	Dipole Antenna	Schmid&Partner Engineering AG	D600V3	1003	SAR(D600)	2016/09/19 * 36
COTS-MSAR-03	Dasy5	Schmid&Partner Engineering AG	DASY5	-	SAR	-
MHBBL600-10000	Head Simulating Liquid	Schmid&Partner Engineering AG	SL AAH U16 BC	-	SAR	Pre Check
MHSL0450	Tissue simulation liquid (Head)	Schmid&Partner Engineering AG	HSL450V2	SL AHH 045 AA	SAR	Pre Check
MNA-03	Vector Reflectometer	Copper Mountain Technologies	PLANAR R140	0030913	SAR	2019/04/01 * 12
MDPK-03	Dielectric assessment kit	Schmid&Partner Engineering AG	DAK-3.5	0008	SAR	2019/04/09 * 12
MOS-37	Digital thermometer	LKM electronic	DTM3000	-	SAR	2018/07/30 * 12
COTS-MSAR-04	Dielectric assessment software	Schmid&Partner Engineering AG	DAK	-	SAR	-
MDAE-02	Data Acquisition Electronics	Schmid&Partner Engineering AG	DAE4	1369	SAR	2019/05/08 * 12
MPB-08	Dosimetric E-Field Probe	Schmid&Partner Engineering AG	EX3DV4	3917	SAR	2019/05/15 * 12
A2436	Dosimetric E-Field Probe	Schmid&Partner Engineering AG	ES3DV3	3335	SAR	2018/07/26 * 12
MPF-03	2mm Oval Flat Phantom	Schmid&Partner Engineering AG	QDOVA001BB	1203	SAR	2019/05/14 * 12
MDH-04	Device holder	Schmid&Partner Engineering AG	Mounting device for transmitter	-	SAR	Pre Check
MOS-35	Digital thermometer	HANNA	Checktemp 4	-	SAR	2018/07/30 * 12
MRBT-03	SAR robot	Schmid&Partner Engineering AG	TX60 Lspeag	F13/5PPLD1/A/01	SAR	2019/04/26 * 12
MPM-11	Dual Power Meter	Agilent	E4419B	MY45102060	SAR	2018/08/07 * 12
MPSE-15	Power sensor	Agilent	E9301A	MY41498311	SAR	2018/08/07 * 12
MPSE-16	Power sensor	Agilent	E9301A	MY41498313	SAR	2018/08/07 * 12
MRFA-24	Pre Amplifier	R&K	R&K CGA020M602- 2633R	B30550	SAR	2019/06/17 * 12
MSG-10	Signal Generator	Agilent	N5181A	MY47421098	SAR	2018/11/14 * 12
MAT-78	Attenuator	Telegartner	J01156A0011	0042294119	SAR	Pre Check
MAT-81	Attenuator	Weinschel Associates	WA1-20-33	100131	SAR	2019/04/02 * 12
MPSE-24	Power sensor	Anritsu Limited	MA24106A	1026164	SAR	2018/08/07 * 12
COTS-MPSE-02	Software for MA24106A	Anritsu Limited	Anritsu PowerXpert	-	SAR	-
MHDC-21	Dual Directional Coupler	Agilent	778D	MY52180243	SAR (0.1-2GHz)	Pre Check

**The expiration date of the calibration is the end of the expired month.**

**All equipment is calibrated with valid calibrations. Each measurement data is traceable to the national or international standards.**

**As for some calibrations performed after the tested dates, those test equipment have been controlled by means of an unbroken chains of calibrations.**

**SAR room is checked before every testing and ambient noise is <0.012W/kg**

## APPENDIX 1 : System Check

### System check result Body 450MHz

#### 20190628 450MHz System Check

Communication System: UID 0, CW (0); Communication System Band: D450 (450.0 MHz); Frequency: 450 MHz; Duty Cycle: 1:1

Medium parameters used:  $f = 450$  MHz;  $\sigma = 0.878$  S/m;  $\epsilon_r = 43.497$ ;  $\rho = 1000$  kg/m<sup>3</sup>

Phantom section: Flat Section

Measurement Standard: DASYS (IEEE/IEC/ANSI C63.19-2007)

DASY5 Configuration

Probe: EX3DV4 - SN3917; ConvF(11.3, 11.3, 11.3) @ 450 MHz; Calibrated: 2019/05/15

Sensor-Surface: 1.4mm (Mechanical Surface Detection)

Electronics: DAE4 Sn1369; Calibrated: 2019/05/08

Phantom: ELI v5.0 (20deg probe tilt); Type: QDOVA001BB; Serial: TP:1203

Measurement SW: DASYS2, Version 52.10 (2); SEMCAD X Version 14.6.12 (7450)

**Pin/250mW/Area Scan (61x61x1):** Interpolated grid: dx=1.500 mm, dy=1.500 mm

Maximum value of SAR (interpolated) = 1.59 W/kg

**Pin/250mW/Zoom Scan (7x7x7) (7x7x7)/Cube 0:** Measurement grid: dx=5mm, dy=5mm, dz=5mm

Reference Value = 44.27 V/m; Power Drift = 0.03 dB

Peak SAR (extrapolated) = 1.93 W/kg

**SAR(1 g) = 1.2 W/kg; SAR(10 g) = 0.790 W/kg**

Maximum value of SAR (measured) = 1.65 W/kg

Date: 2019/06/28

Ambient Temp. : 24.0 degree.C. Liquid Temp.; 23.5 degree.C.

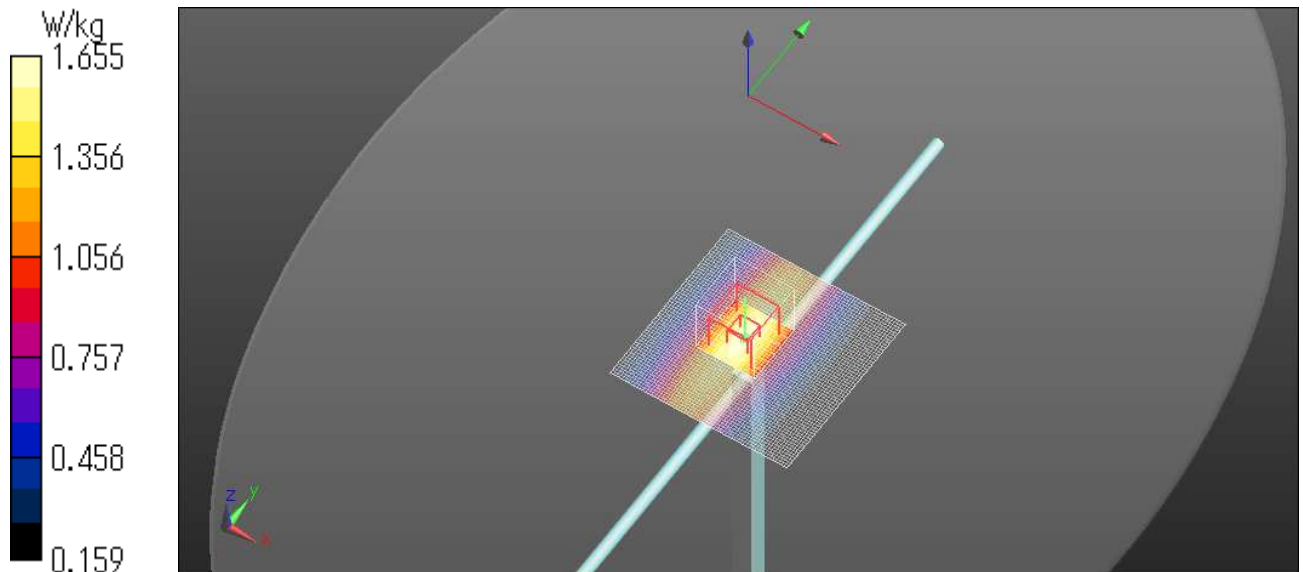

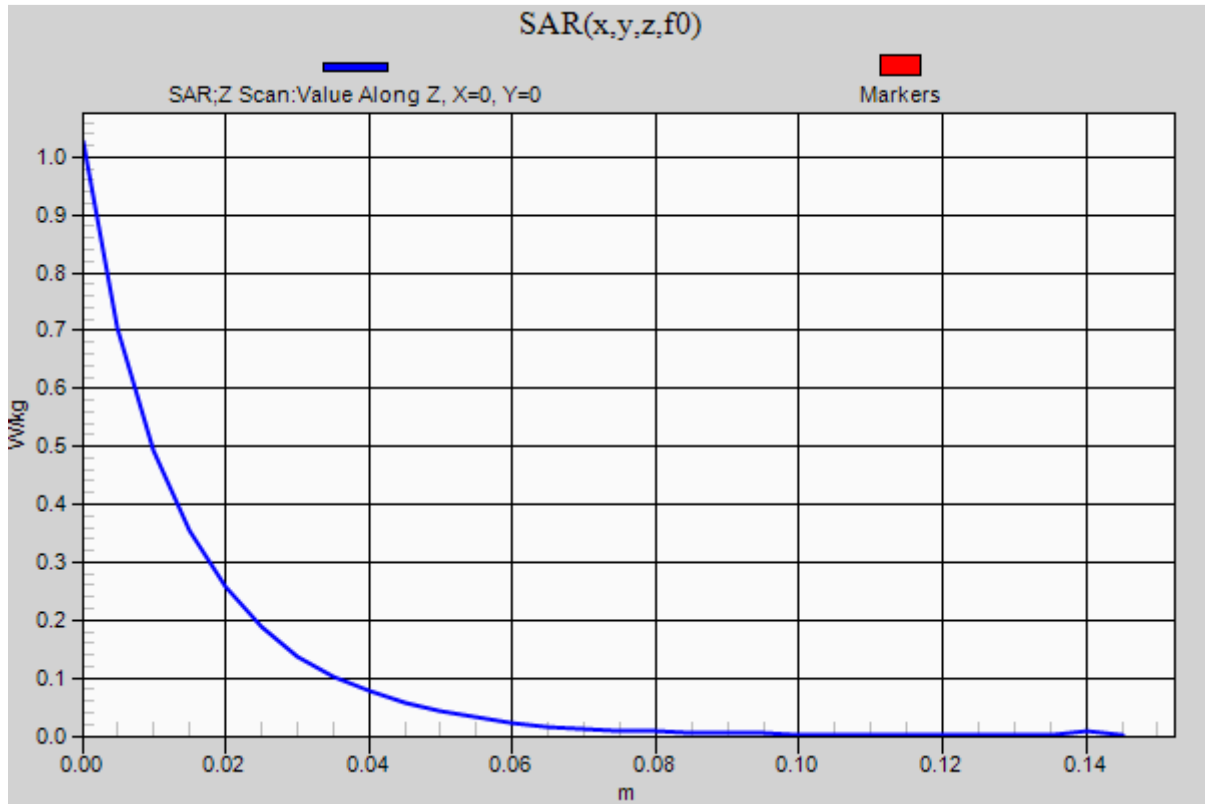

**System check result Body 600MHz**  
**20190628 600MHz System Check**

Communication System: UID 0, #CW (0); Communication System Band: D600 (600.0 MHz); Frequency: 600 MHz; Duty Cycle: 1:1

Medium parameters used:  $f = 600$  MHz;  $\sigma = 0.893$  S/m;  $\epsilon_r = 42.587$ ;  $\rho = 1000$  kg/m<sup>3</sup>

Phantom section: Flat Section

Measurement Standard: DASYS (IEEE/IEC/ANSI C63.19-2007)

DASY5 Configuration

Probe: EX3DV4 - SN3917; ConvF(10.38, 10.38, 10.38) @ 600 MHz; Calibrated: 2019/05/15

Sensor-Surface: 1.4mm (Mechanical Surface Detection), Sensor-Surface: 0mm (Fix Surface)

Electronics: DAE4 Sn1369; Calibrated: 2019/05/08

Phantom: ELI v5.0 (20deg probe tilt); Type: QDOVA001BB; Serial: TP:1203

Measurement SW: DASYS2, Version 52.10 (2); SEMCAD X Version 14.6.12 (7450)

**Area Scan (61x61x1):** Interpolated grid: dx=1.500 mm, dy=1.500 mm

Maximum value of SAR (interpolated) = 2.24 W/kg

**Zoom Scan (7x7x7) (7x7x7)/Cube 0:** Measurement grid: dx=5mm, dy=5mm, dz=5mm

Reference Value = 51.47 V/m; Power Drift = -0.02 dB

Peak SAR (extrapolated) = 2.71 W/kg

**SAR(1 g) = 1.66 W/kg; SAR(10 g) = 1.08 W/kg**

Maximum value of SAR (measured) = 2.30 W/kg

**Z Scan (1x1x31):** Measurement grid: dx=20mm, dy=20mm, dz=5mm

Maximum value of SAR (measured) = 1.42 W/kg

Date: 2019/06/28

Ambient Temp. : 24.0 degree.C. Liquid Temp.; 23.5 degree.C.

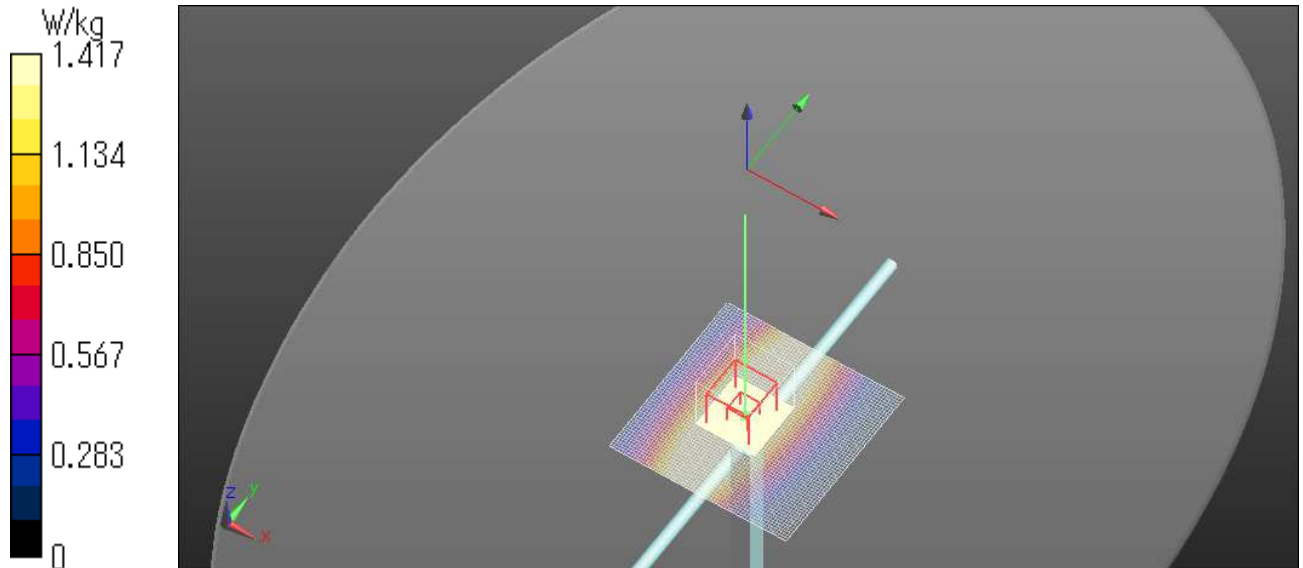

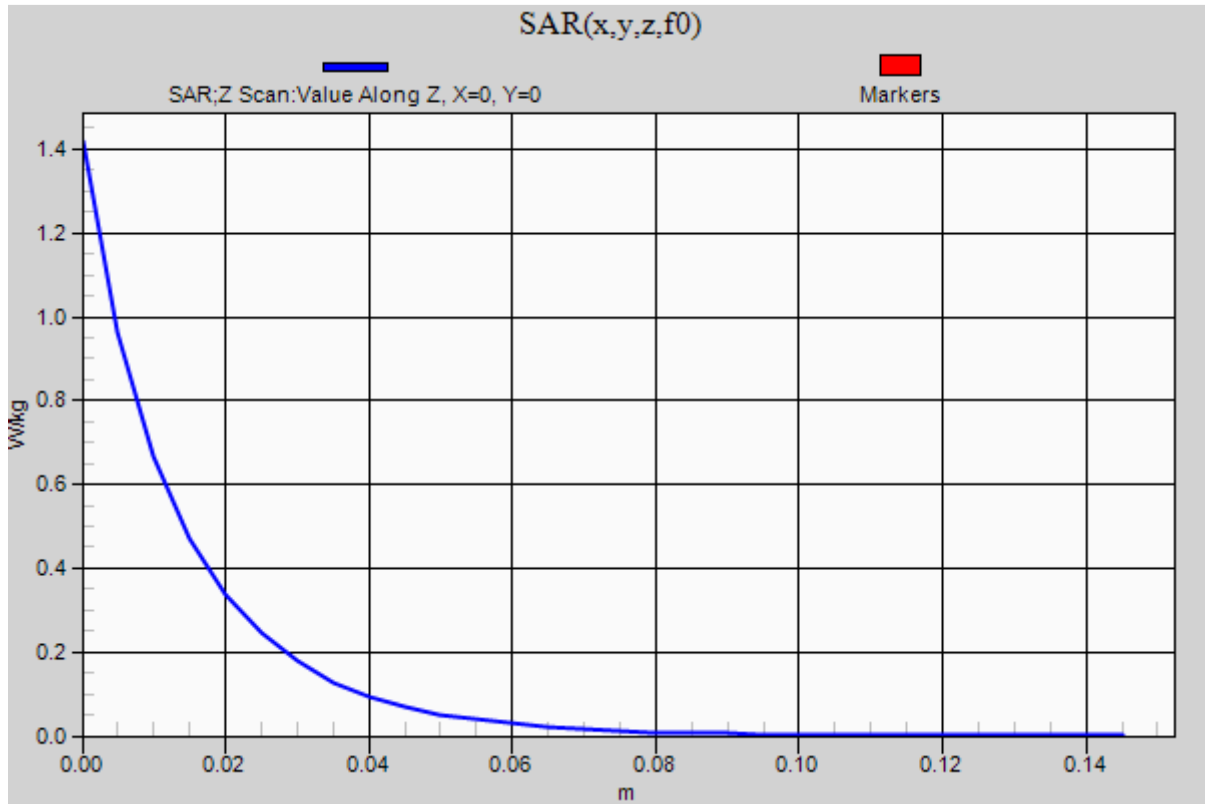

**System check result Body 900MHz**  
**20190709 900MHz System Check**

Communication System: UID 0, #CW (0); Communication System Band: D900 (900.0 MHz); Frequency: 900 MHz; Duty Cycle: 1:1

Medium parameters used:  $f = 900$  MHz;  $\sigma = 0.947$  S/m;  $\epsilon_r = 41.52$ ;  $\rho = 1000$  kg/m<sup>3</sup>

Phantom section: Flat Section

Measurement Standard: DASY5 (IEEE/IEC/ANSI C63.19-2007)

DASY5 Configuration

Probe: ES3DV3 - SN3335; ConvF(6.31, 6.31, 6.31) @ 900 MHz; Calibrated: 2018/07/26

Sensor-Surface: 3mm (Mechanical Surface Detection), Sensor-Surface: 0mm (Fix Surface)

Electronics: DAE4 Sn1369; Calibrated: 2019/05/08

Phantom: ELI v5.0 (20deg probe tilt); Type: QDOVA001BB; Serial: TP:1203

Measurement SW: DASY52, Version 52.10 (2); SEMCAD X Version 14.6.12 (7450)

**Pin/250mW/Area Scan (61x61x1):** Interpolated grid: dx=1.500 mm, dy=1.500 mm  
Maximum value of SAR (interpolated) = 3.10 W/kg

**Pin/250mW/Zoom Scan (7x7x7) (7x7x7)/Cube 0:** Measurement grid: dx=5mm, dy=5mm, dz=5mm

Reference Value = 59.38 V/m; Power Drift = 0.03 dB

Peak SAR (extrapolated) = 3.98 W/kg

**SAR(1 g) = 2.67 W/kg; SAR(10 g) = 1.73 W/kg**

Maximum value of SAR (measured) = 3.12 W/kg

**Pin/250mW/Z Scan (1x1x31):** Measurement grid: dx=20mm, dy=20mm, dz=5mm

Maximum value of SAR (measured) = 2.09 W/kg

Date: 2019/07/09

Ambient Temp. : 24.0 degree.C. Liquid Temp.; 23.5 degree.C.

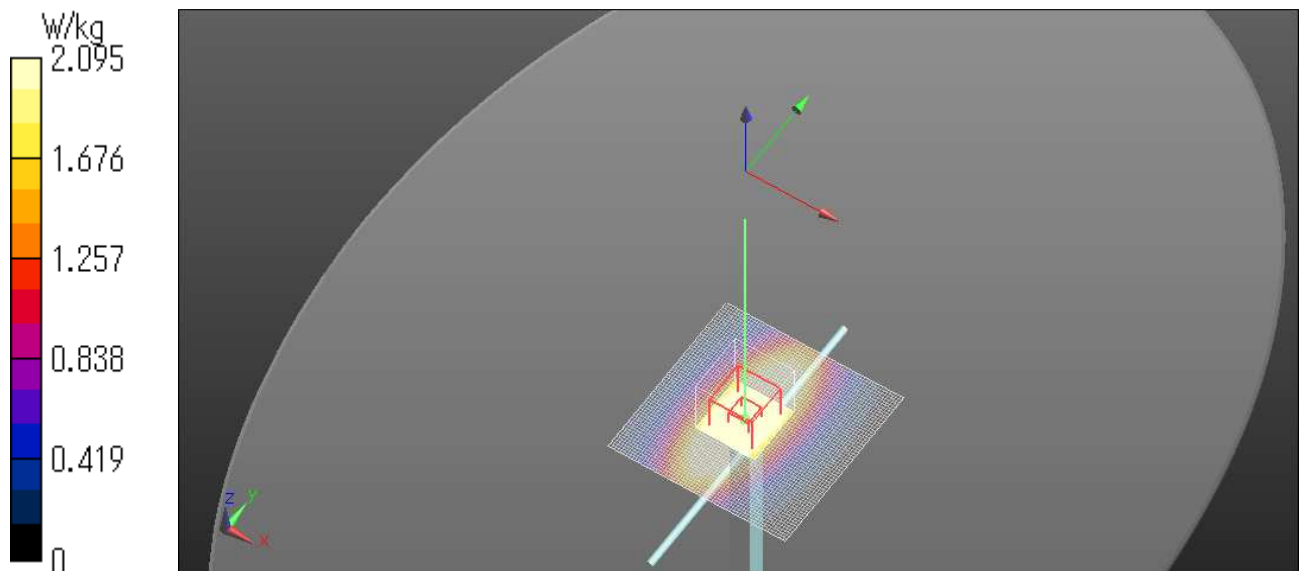



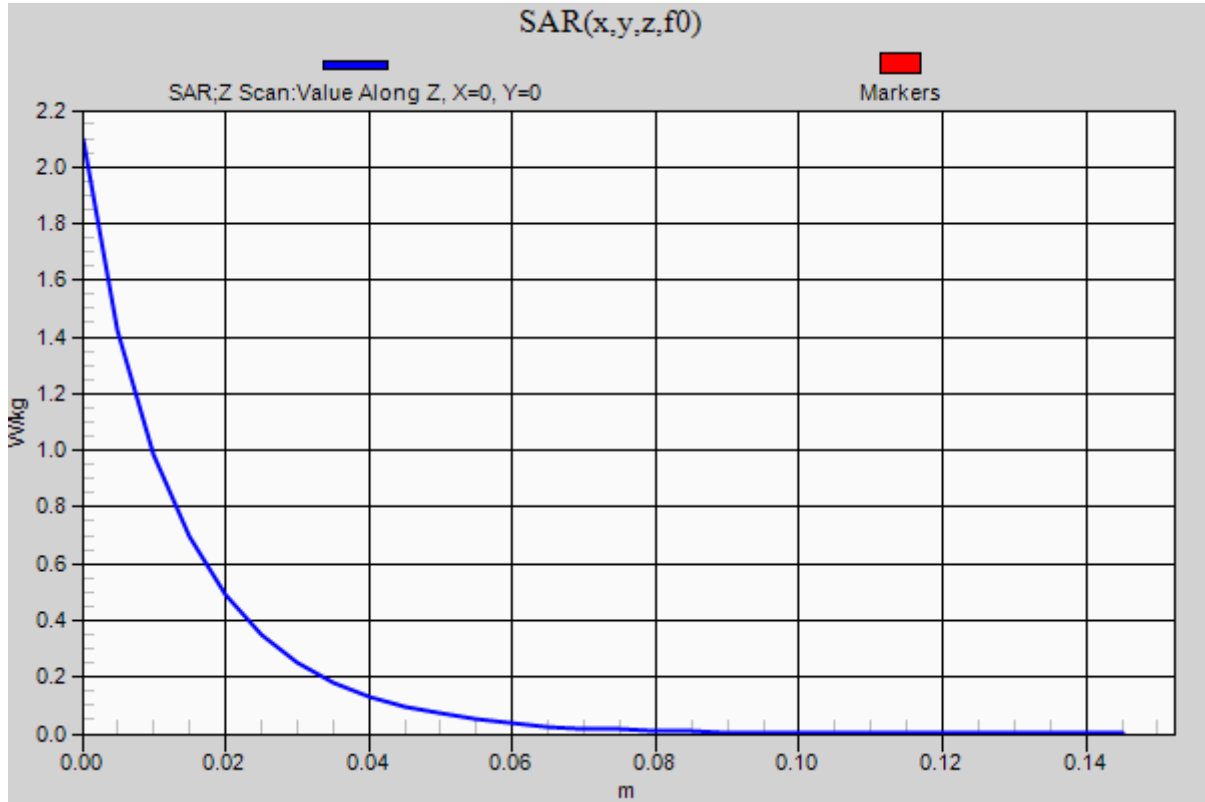

## **APPENDIX 2 : SAR Measurement data**

### **Evaluation procedure**

**The evaluation was performed with the following procedure:**

**Step 1:** Measurement of the E-field at a fixed location above the ear point or central position of flat phantom was used as a reference value for assessing the power drop.

**Step 2:** The SAR distribution at the exposed side of head or body position was measured at a distance of each device from the inner surface of the shell. The area covered the entire dimension of the antenna of EUT and the horizontal grid spacing was 15 mm x 15 mm, 12 mm x 12 mm or 10mm x 10mm. Based on these data, the area of the maximum absorption was determined by spline interpolation.

**Step 3:** Around this point found in the Step 2 (area scan), a volume of 30mm x 30mm x 30mm or more was assessed by measuring 7 x 7 x 7 points at least for below 3GHz and a volume of 28 mm x 28mm x 22.5mm or more was assessed by measuring 8 x 8 x 6(ratio step method (\*1)) points at least for 5GHz band.

And for any secondary peaks found in the Step2 which are within 2dB of maximum peak and not with this Step3 (Zoom scan) is repeated. On the basis of this data set, the spatial peak SAR value was evaluated under the following procedure:

(1). The data at the surface were extrapolated, since the center of the dipoles is 1mm(EX3DV4) away from the tip of the probe and the distance between the surface and the lowest measuring point is 1.3 mm. The extrapolation was based on a least square algorithm [4]. A polynomial of the fourth order was calculated through the points in z-axes.

This polynomial was then used to evaluate the points between the surface and the probe tip.

(2). The maximum interpolated value was searched with a straightforward algorithm. Around this maximum the SAR values averaged over the spatial volumes (1 g or 10 g) were computed by the 3D-Spline interpolation algorithm. The 3D-Spline is composed of three one-dimensional splines with the "Not a knot"-condition (in x, y and z-directions) [4], [5]. The volume was integrated with the trapezoidal-algorithm. One thousand points (10 x 10 x 10) were interpolated to calculate the average.

(3). All neighboring volumes were evaluated until no neighboring volume with a higher average value was found.

**\*1. Ratio step method parameters used;**

**The first measurement point: 2mm from the phantom surface, the initial grid separation: 2mm, subsequent graded grid ratio: 1.5**

**These parameters comply with the requirement of the KDB 865664D01.**

**Step 4:** Re-measurement of the E-field at the same location as in Step 1.

Confirmation after SAR testing

It was checked that the power drift [W] is within +/-5%.The verification of power drift during the SAR test is that DASY5 system calculates the power drift by measuring the e-filed at the same location at beginning and the end of the scan measurement for each test position.

DASY5 system calculation Power drift value[dB] =20log(Ea)/(Eb)

Before SAR testing : Eb[V/m]

After SAR testing : Ea[V/m]

Limit of power drift[W] =+/-5%

X[dB]=10log[P]=10log(1.05/1)=10log(1.05)-10log(1)=0.212dB

from E-filed relations with power.

$p=E^2/\eta=E^2/$

Therefore, The correlation of power and the E-filed

$XdB=10log(P)=10log(E)^2=20log(E)$

Therefore,

The calculated power drift of DASY5 System must be the less than +/-0.212dB.

**Measurement data**  
**Radio Microphone 539MHz Front 0mm**

Communication System: UID 0, Radio microphone (0); Communication System Band: UC; Frequency: 539 MHz; Duty Cycle: 1:1

Medium parameters used (interpolated):  $f = 539$  MHz;  $\sigma = 0.885$  S/m;  $\epsilon_r = 43.197$ ;  $\rho = 1000$  kg/m<sup>3</sup>

Phantom section: Flat Section

Measurement Standard: DASY5 (IEEE/IEC/ANSI C63.19-2007)

DASY5 Configuration

Probe: EX3DV4 - SN3917; ConvF(11.3, 11.3, 11.3) @ 539 MHz; Calibrated: 2019/05/15

Sensor-Surface: 1.4mm (Mechanical Surface Detection)

Electronics: DAE4 Sn1369; Calibrated: 2019/05/08

Phantom: ELI v5.0 (20deg probe tilt); Type: QDOVA001BB; Serial: TP:1203

Measurement SW: DASY52, Version 52.10 (2); SEMCAD X Version 14.6.12 (7450)

**Area Scan (51x161x1):** Interpolated grid: dx=1.500 mm, dy=1.500 mm

Maximum value of SAR (interpolated) = 0.198 W/kg

**Front/Zoom Scan (7x7x7)/Cube 0:** Measurement grid: dx=5mm, dy=5mm, dz=5mm

Reference Value = 13.45 V/m; Power Drift = -0.14 dB

Peak SAR (extrapolated) = 0.314 W/kg

**SAR(1 g) = 0.155 W/kg; SAR(10 g) = 0.090 W/kg**

Maximum value of SAR (measured) = 0.242 W/kg

Date: 2019/06/28

Ambient Temp. : 24.0 degree.C. Liquid Temp.; 23.5 degree.C.

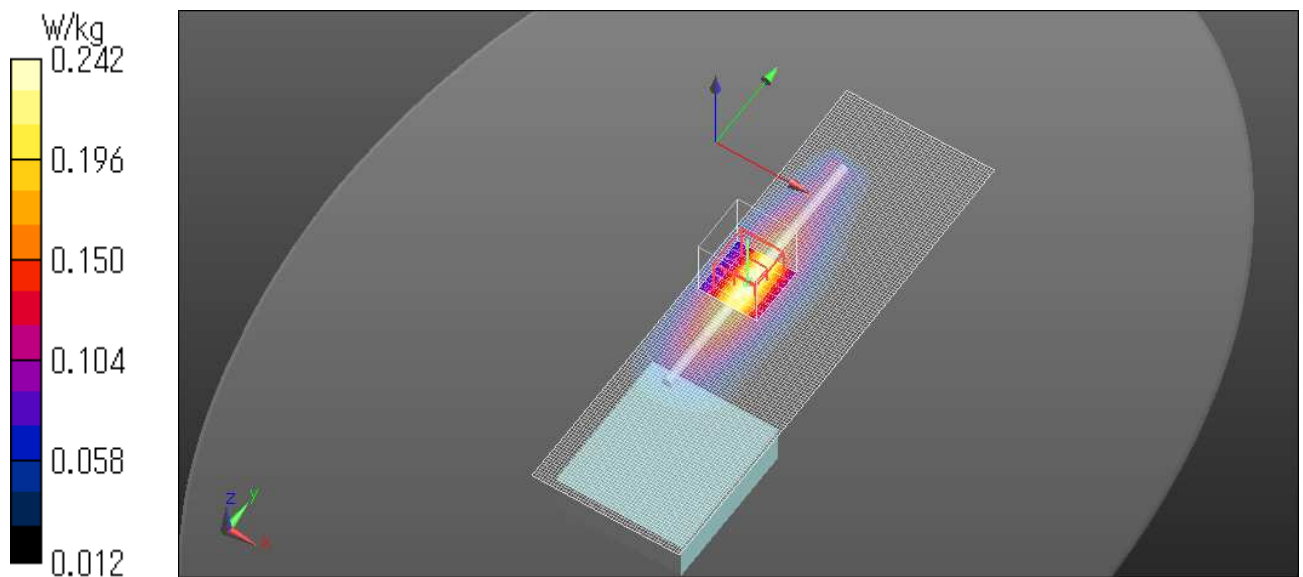

### Radio Microphone 470.125MHz Right 0mm

Communication System: UID 0, Radio microphone (0); Communication System Band: UC; Frequency: 470.125 MHz; Duty Cycle: 1:1

Medium parameters used (interpolated):  $f = 470.125$  MHz;  $\sigma = 0.877$  S/m;  $\epsilon_r = 43.447$ ;  $\rho = 1000$  kg/m<sup>3</sup>

Phantom section: Flat Section

Measurement Standard: DASYS (IEEE/IEC/ANSI C63.19-2007)

DASY5 Configuration

Probe: EX3DV4 - SN3917; ConvF(11.3, 11.3, 11.3) @ 470.125 MHz; Calibrated: 2019/05/15

Sensor-Surface: 1.4mm (Mechanical Surface Detection)

Electronics: DAE4 Sn1369; Calibrated: 2019/05/08

Phantom: ELI v5.0 (20deg probe tilt); Type: QDOVA001BB; Serial: TP:1203

Measurement SW: DASYS2, Version 52.10 (2); SEMCAD X Version 14.6.12 (7450)

**Area Scan (41x161x1):** Interpolated grid: dx=1.500 mm, dy=1.500 mm

Maximum value of SAR (interpolated) = 0.239 W/kg

**Zoom Scan (7x7x7)/Cube 0:** Measurement grid: dx=5mm, dy=5mm, dz=5mm

Reference Value = 13.60 V/m; Power Drift = 0.20 dB

Peak SAR (extrapolated) = 1.55 W/kg

**SAR(1 g) = 0.155 W/kg; SAR(10 g) = 0.047 W/kg**

Maximum value of SAR (measured) = 0.701 W/kg

Date: 2019/06/28

Ambient Temp. : 24.0 degree.C. Liquid Temp.; 23.5 degree.C.

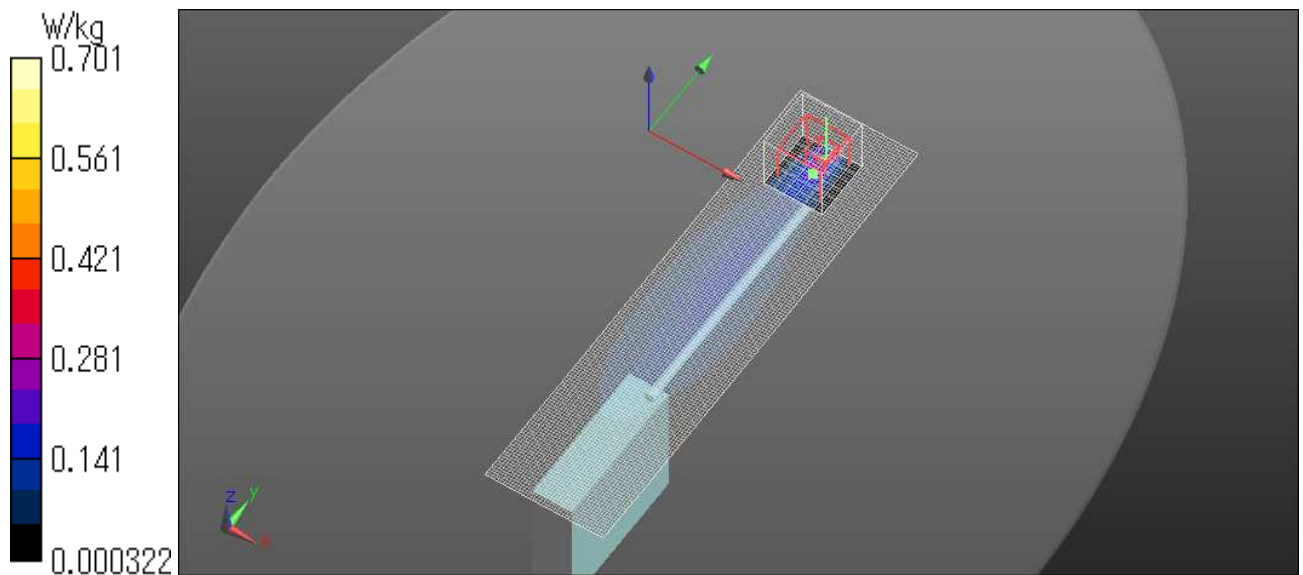

### Radio Microphone 539MHz Right 0mm

Communication System: UID 0, Radio microphone (0); Communication System Band: UC; Frequency: 539 MHz; Duty Cycle: 1:1

Medium parameters used (interpolated):  $f = 539$  MHz;  $\sigma = 0.885$  S/m;  $\epsilon_r = 43.197$ ;  $\rho = 1000$  kg/m<sup>3</sup>

Phantom section: Flat Section

Measurement Standard: DASYS5 (IEEE/IEC/ANSI C63.19-2007)

DASY5 Configuration

Probe: EX3DV4 - SN3917; ConvF(11.3, 11.3, 11.3) @ 539 MHz; Calibrated: 2019/05/15

Sensor-Surface: 1.4mm (Mechanical Surface Detection)

Electronics: DAE4 Sn1369; Calibrated: 2019/05/08

Phantom: ELI v5.0 (20deg probe tilt); Type: QDOVA001BB; Serial: TP:1203

Measurement SW: DASYS52, Version 52.10 (2); SEMCAD X Version 14.6.12 (7450)

**Area Scan (41x161x1):** Interpolated grid: dx=1.500 mm, dy=1.500 mm

Maximum value of SAR (interpolated) = 0.693 W/kg

**Zoom Scan (7x19x7)/Cube 0:** Measurement grid: dx=5mm, dy=5mm, dz=5mm

Reference Value = 19.18 V/m; Power Drift = -0.16 dB

Peak SAR (extrapolated) = 1.25 W/kg

**SAR(1 g) = 0.157 W/kg; SAR(10 g) = 0.076 W/kg**

Maximum value of SAR (measured) = 0.522 W/kg

Date: 2019/06/28

Ambient Temp. : 24.0 degree.C. Liquid Temp.; 23.5 degree.C.

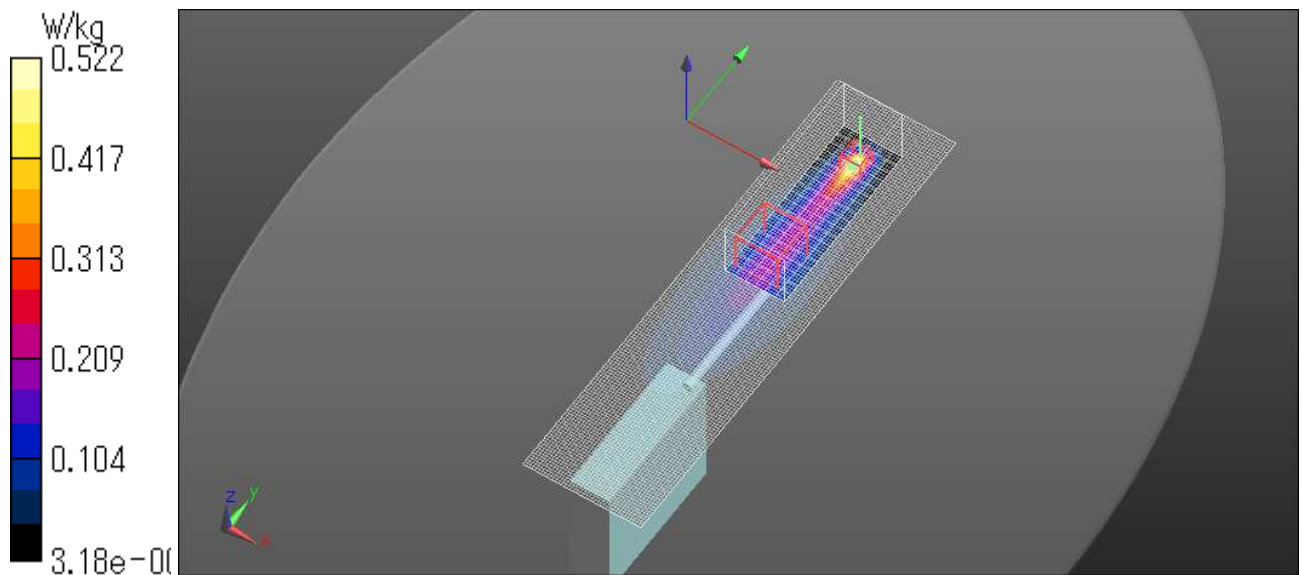

### Radio Microphone 607.875MHz Right 0mm

Communication System: UID 0, Radio microphone (0); Communication System Band: UC; Frequency: 607.875 MHz; Duty Cycle: 1:1

Medium parameters used (interpolated):  $f = 607.875$  MHz;  $\sigma = 0.894$  S/m;  $\epsilon_r = 42.502$ ;  $\rho = 1000$  kg/m<sup>3</sup>

Phantom section: Flat Section

Measurement Standard: DASYS5 (IEEE/IEC/ANSI C63.19-2007)

DASY5 Configuration

Probe: EX3DV4 - SN3917; ConvF(10.38, 10.38, 10.38) @ 607.875 MHz; Calibrated: 2019/05/15

Sensor-Surface: 1.4mm (Mechanical Surface Detection)

Electronics: DAE4 Sn1369; Calibrated: 2019/05/08

Phantom: ELI v5.0 (20deg probe tilt); Type: QDOVA001BB; Serial: TP:1203

Measurement SW: DASYS52, Version 52.10 (2); SEMCAD X Version 14.6.12 (7450)

**Area Scan (41x161x1):** Interpolated grid: dx=1.500 mm, dy=1.500 mm

Maximum value of SAR (interpolated) = 0.130 W/kg

**Zoom Scan (8x18x7)/Cube 0:** Measurement grid: dx=5mm, dy=5mm, dz=5mm

Reference Value = 10.11 V/m; Power Drift = -0.01 dB

Peak SAR (extrapolated) = 0.510 W/kg

**SAR(1 g) = 0.071 W/kg; SAR(10 g) = 0.042 W/kg**

Maximum value of SAR (measured) = 0.211 W/kg

Date: 2019/06/28

Ambient Temp. : 24.0 degree.C. Liquid Temp.; 23.5 degree.C.

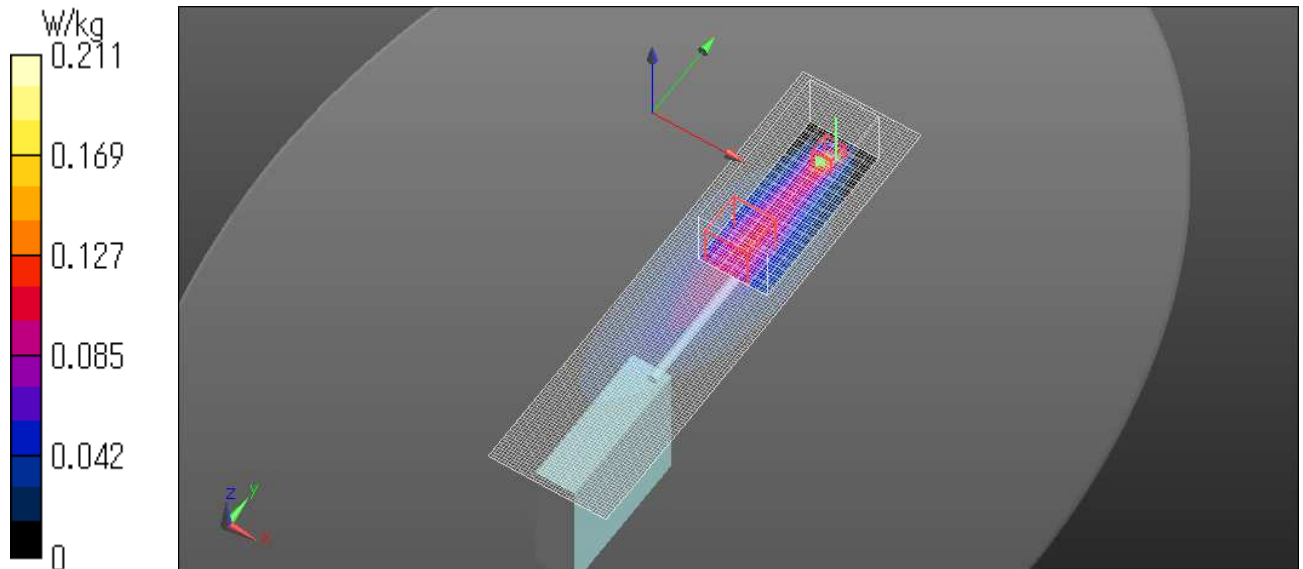

### Radio Microphone 539MHz Rear 0mm

Communication System: UID 0, Radio microphone (0); Communication System Band: UC; Frequency: 539 MHz; Duty Cycle: 1:1

Medium parameters used (interpolated):  $f = 539$  MHz;  $\sigma = 0.885$  S/m;  $\epsilon_r = 43.197$ ;  $\rho = 1000$  kg/m<sup>3</sup>

Phantom section: Flat Section

Measurement Standard: DASYS5 (IEEE/IEC/ANSI C63.19-2007)

DASY5 Configuration

Probe: EX3DV4 - SN3917; ConvF(11.3, 11.3, 11.3) @ 539 MHz; Calibrated: 2019/05/15

Sensor-Surface: 1.4mm (Mechanical Surface Detection)

Electronics: DAE4 Sn1369; Calibrated: 2019/05/08

Phantom: ELI v5.0 (20deg probe tilt); Type: QDOVA001BB; Serial: TP:1203

Measurement SW: DASYS52, Version 52.10 (2); SEMCAD X Version 14.6.12 (7450)

**Area Scan (51x161x1):** Interpolated grid: dx=1.500 mm, dy=1.500 mm

Maximum value of SAR (interpolated) = 0.531 W/kg

**Zoom Scan (8x21x7)/Cube 0:** Measurement grid: dx=5mm, dy=5mm, dz=5mm

Reference Value = 16.97 V/m; Power Drift = 0.07 dB

Peak SAR (extrapolated) = 1.03 W/kg

**SAR(1 g) = 0.132 W/kg; SAR(10 g) = 0.074 W/kg**

Maximum value of SAR (measured) = 0.412 W/kg

Date: 2019/06/28

Ambient Temp. : 24.0 degree.C. Liquid Temp.; 23.5 degree.C.

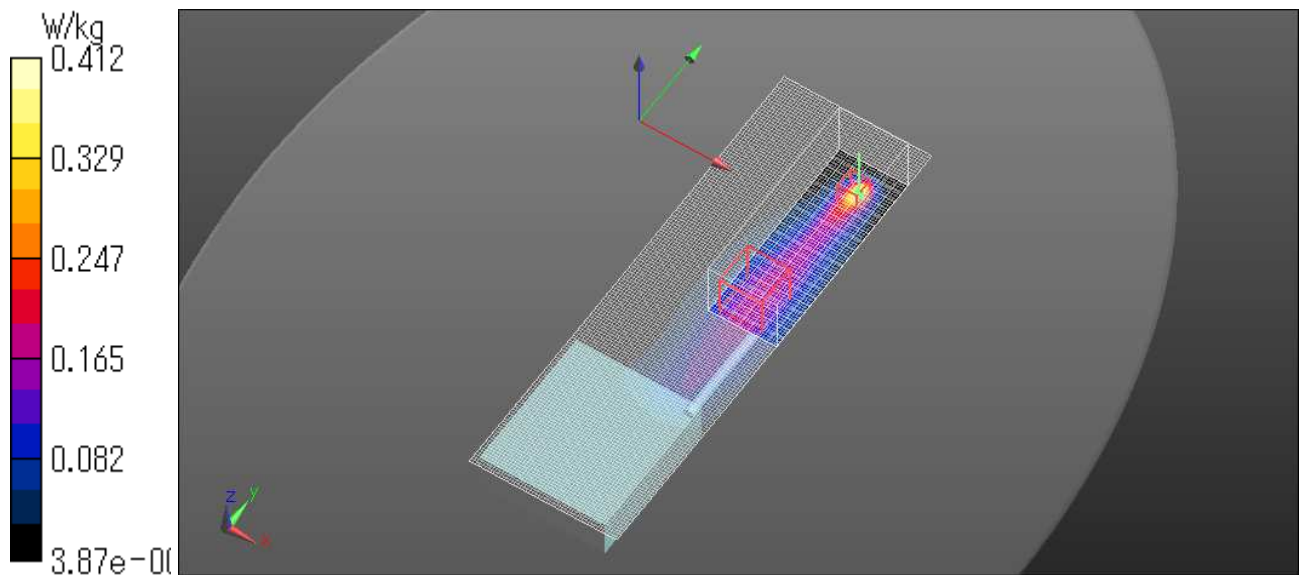

### Radio Microphone 539MHz Top 0mm

Communication System: UID 0, Radio microphone (0); Communication System Band: UC; Frequency: 539 MHz; Duty Cycle: 1:1

Medium parameters used (interpolated):  $f = 539$  MHz;  $\sigma = 0.885$  S/m;  $\epsilon_r = 43.197$ ;  $\rho = 1000$  kg/m<sup>3</sup>

Phantom section: Flat Section

Measurement Standard: DASYS5 (IEEE/IEC/ANSI C63.19-2007)

DASY5 Configuration

Probe: EX3DV4 - SN3917; ConvF(11.3, 11.3, 11.3) @ 539 MHz; Calibrated: 2019/05/15

Sensor-Surface: 1.4mm (Mechanical Surface Detection)

Electronics: DAE4 Sn1369; Calibrated: 2019/05/08

Phantom: ELI v5.0 (20deg probe tilt); Type: QDOVA001BB; Serial: TP:1203

Measurement SW: DASYS52, Version 52.10 (2); SEMCAD X Version 14.6.12 (7450)

**Area Scan (61x61x1):** Interpolated grid: dx=1.500 mm, dy=1.500 mm

Maximum value of SAR (interpolated) = 0.226 W/kg

**Zoom Scan (8x7x7)/Cube 0:** Measurement grid: dx=5mm, dy=5mm, dz=5mm

Reference Value = 13.18 V/m; Power Drift = 0.18 dB

Peak SAR (extrapolated) = 1.52 W/kg

**SAR(1 g) = 0.100 W/kg; SAR(10 g) = 0.019 W/kg**

Maximum value of SAR (measured) = 0.626 W/kg

Date: 2019/06/28

Ambient Temp. : 24.0 degree.C. Liquid Temp.; 23.5 degree.C.

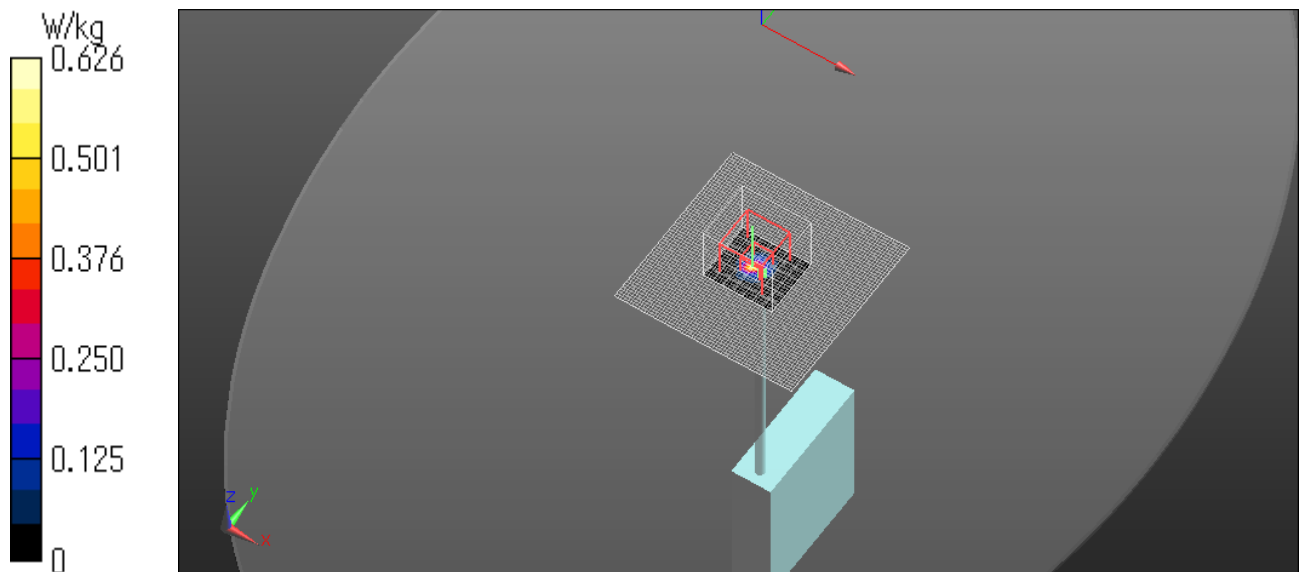



### Radio Microphone 941.625MHz Front 0mm

Communication System: UID 0, Radio microphone (0); Communication System Band: UC; Frequency: 941.625 MHz; Duty Cycle: 1:1

Medium parameters used (interpolated):  $f = 941.625$  MHz;  $\sigma = 0.983$  S/m;  $\epsilon_r = 41.731$ ;  $\rho = 1000$  kg/m<sup>3</sup>

Phantom section: Flat Section

Measurement Standard: DASYS5 (IEEE/IEC/ANSI C63.19-2007)

DASY5 Configuration

Probe: ES3DV3 - SN3335; ConvF(6.31, 6.31, 6.31) @ 941.625 MHz; Calibrated: 2018/07/26

Sensor-Surface: 3mm (Mechanical Surface Detection)

Electronics: DAE4 Sn1369; Calibrated: 2019/05/08

Phantom: ELI v5.0 (20deg probe tilt); Type: QDOVA001BB; Serial: TP:1203

Measurement SW: DASYS52, Version 52.10 (2); SEMCAD X Version 14.6.12 (7450)

**Area Scan (51x111x1):** Interpolated grid: dx=1.500 mm, dy=1.500 mm

Maximum value of SAR (interpolated) = 0.171 W/kg

**Zoom Scan (7x7x7)/Cube 0:** Measurement grid: dx=5mm, dy=5mm, dz=5mm

Reference Value = 12.42 V/m; Power Drift = -0.06 dB

Peak SAR (extrapolated) = 0.261 W/kg

**SAR(1 g) = 0.146 W/kg; SAR(10 g) = 0.085 W/kg**

Maximum value of SAR (measured) = 0.181 W/kg

Date: 2019/07/09

Ambient Temp. : 24.0 degree.C. Liquid Temp.; 23.5 degree.C.

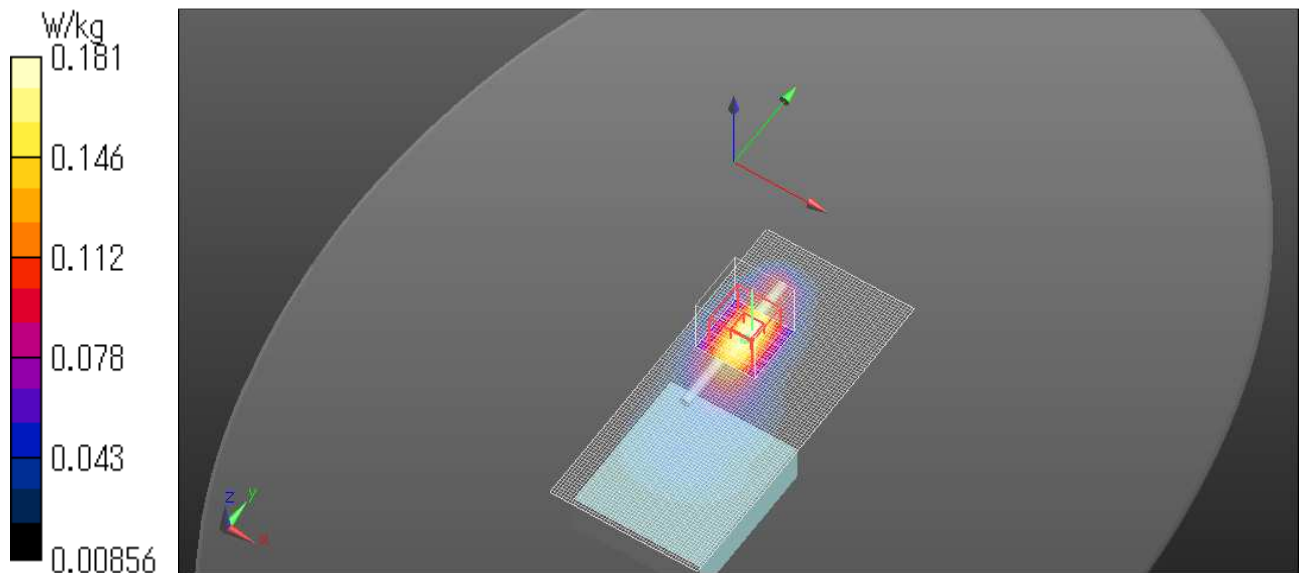

### Radio Microphone 950.625MHz Front 0mm

Communication System: UID 0, Radio microphone (0); Communication System Band: UC; Frequency: 950.625 MHz; Duty Cycle: 1:1

Medium parameters used (interpolated):  $f = 950.625$  MHz;  $\sigma = 0.991$  S/m;  $\epsilon_r = 41.806$ ;  $\rho = 1000$  kg/m<sup>3</sup>

Phantom section: Flat Section

Measurement Standard: DASYS (IEEE/IEC/ANSI C63.19-2007)

DASY5 Configuration

Probe: ES3DV3 - SN3335; ConvF(6.31, 6.31, 6.31) @ 950.625 MHz; Calibrated: 2018/07/26

Sensor-Surface: 3mm (Mechanical Surface Detection)

Electronics: DAE4 Sn1369; Calibrated: 2019/05/08

Phantom: ELI v5.0 (20deg probe tilt); Type: QDOVA001BB; Serial: TP:1203

Measurement SW: DASYS2, Version 52.10 (2); SEMCAD X Version 14.6.12 (7450)

**Radio Microphone/Front/Area Scan (51x111x1):** Interpolated grid: dx=1.500 mm, dy=1.500 mm

Maximum value of SAR (interpolated) = 0.174 W/kg

**Radio Microphone/Front/Zoom Scan (7x7x7)/Cube 0:** Measurement grid: dx=5mm, dy=5mm, dz=5mm

Reference Value = 12.78 V/m; Power Drift = 0.16 dB

Peak SAR (extrapolated) = 0.269 W/kg

**SAR(1 g) = 0.155 W/kg; SAR(10 g) = 0.091 W/kg**

Maximum value of SAR (measured) = 0.190 W/kg

Date: 2019/07/09

Ambient Temp. : 24.0 degree.C. Liquid Temp.; 23.5 degree.C.

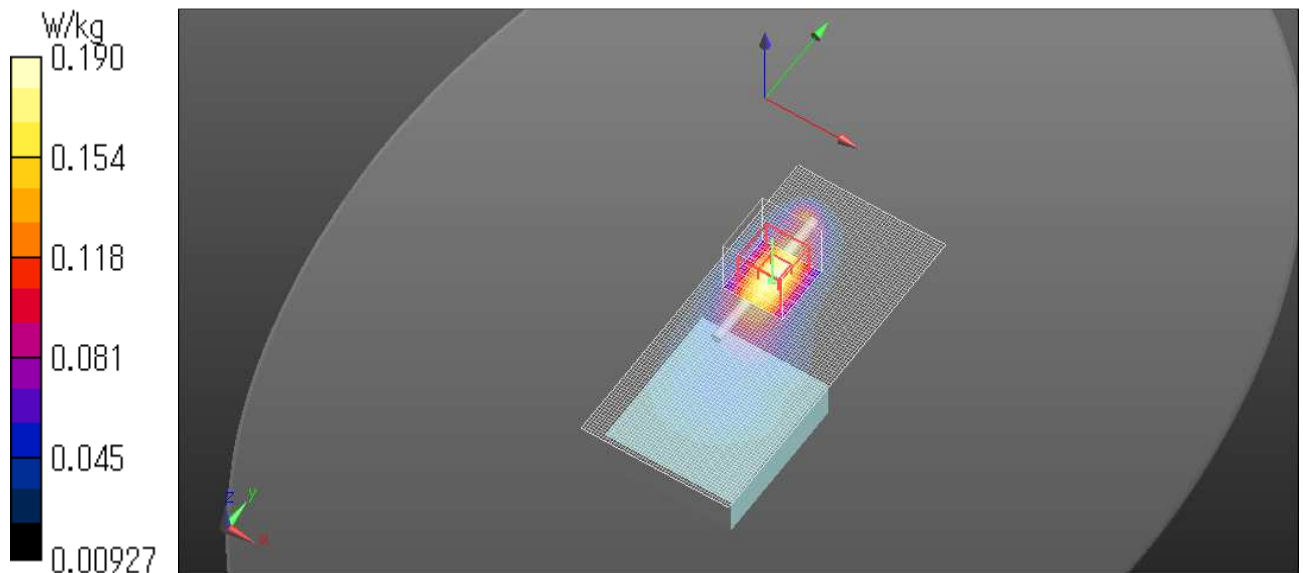

### Radio Microphone 959.625MHz Front 0mm

Communication System: UID 0, Radio microphone (0); Communication System Band: UC; Frequency: 959.625 MHz; Duty Cycle: 1:1

Medium parameters used:  $f = 960$  MHz;  $\sigma = 0.999$  S/m;  $\epsilon_r = 41.889$ ;  $\rho = 1000$  kg/m<sup>3</sup>

Phantom section: Flat Section

Measurement Standard: DASYS (IEEE/IEC/ANSI C63.19-2007)

DASY5 Configuration

Probe: ES3DV3 - SN3335; ConvF(6.31, 6.31, 6.31) @ 959.625 MHz; Calibrated: 2018/07/26

Sensor-Surface: 3mm (Mechanical Surface Detection)

Electronics: DAE4 Sn1369; Calibrated: 2019/05/08

Phantom: ELI v5.0 (20deg probe tilt); Type: QDOVA001BB; Serial: TP:1203

Measurement SW: DASYS2, Version 52.10 (2); SEMCAD X Version 14.6.12 (7450)

**Area Scan (51x111x1):** Interpolated grid: dx=1.500 mm, dy=1.500 mm

Maximum value of SAR (interpolated) = 0.171 W/kg

**Zoom Scan (7x7x7)/Cube 0:** Measurement grid: dx=5mm, dy=5mm, dz=5mm

Reference Value = 12.34 V/m; Power Drift = 0.13 dB

Peak SAR (extrapolated) = 0.265 W/kg

**SAR(1 g) = 0.151 W/kg; SAR(10 g) = 0.088 W/kg**

Maximum value of SAR (measured) = 0.186 W/kg

Date: 2019/07/09

Ambient Temp. : 24.0 degree.C. Liquid Temp.; 23.5 degree.C.

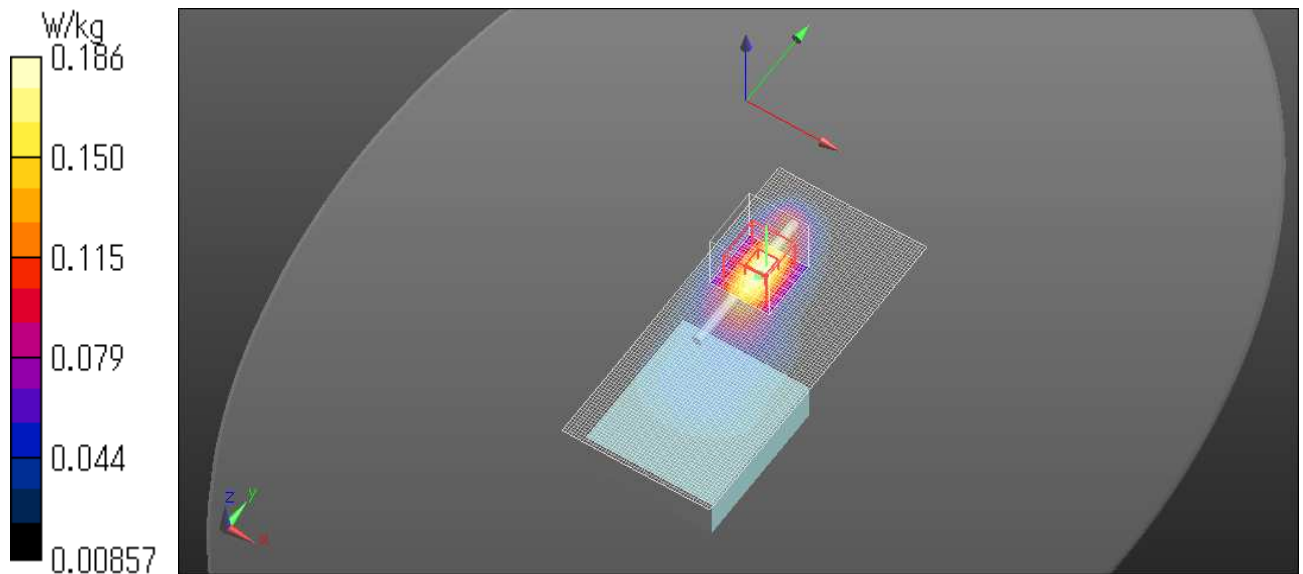

### Radio Microphone 941.625MHz Right 0mm

Communication System: UID 0, Radio microphone (0); Communication System Band: UC; Frequency: 941.625 MHz; Duty Cycle: 1:1

Medium parameters used (interpolated):  $f = 941.625$  MHz;  $\sigma = 0.983$  S/m;  $\epsilon_r = 41.731$ ;  $\rho = 1000$  kg/m<sup>3</sup>

Phantom section: Flat Section

Measurement Standard: DASYS (IEEE/IEC/ANSI C63.19-2007)

DASY5 Configuration

Probe: ES3DV3 - SN3335; ConvF(6.31, 6.31, 6.31) @ 941.625 MHz; Calibrated: 2018/07/26

Sensor-Surface: 3mm (Mechanical Surface Detection)

Electronics: DAE4 Sn1369; Calibrated: 2019/05/08

Phantom: ELI v5.0 (20deg probe tilt); Type: QDOVA001BB; Serial: TP:1203

Measurement SW: DASYS2, Version 52.10 (2); SEMCAD X Version 14.6.12 (7450)

**Area Scan (41x111x1):** Interpolated grid: dx=1.500 mm, dy=1.500 mm

Maximum value of SAR (interpolated) = 0.135 W/kg

**Zoom Scan (8x13x7)/Cube 0:** Measurement grid: dx=5mm, dy=5mm, dz=5mm

Reference Value = 11.67 V/m; Power Drift = -0.13 dB

Peak SAR (extrapolated) = 0.566 W/kg

**SAR(1 g) = 0.105 W/kg; SAR(10 g) = 0.063 W/kg**

Maximum value of SAR (measured) = 0.130 W/kg

Date: 2019/07/09

Ambient Temp. : 24.0 degree.C. Liquid Temp.; 23.5 degree.C.

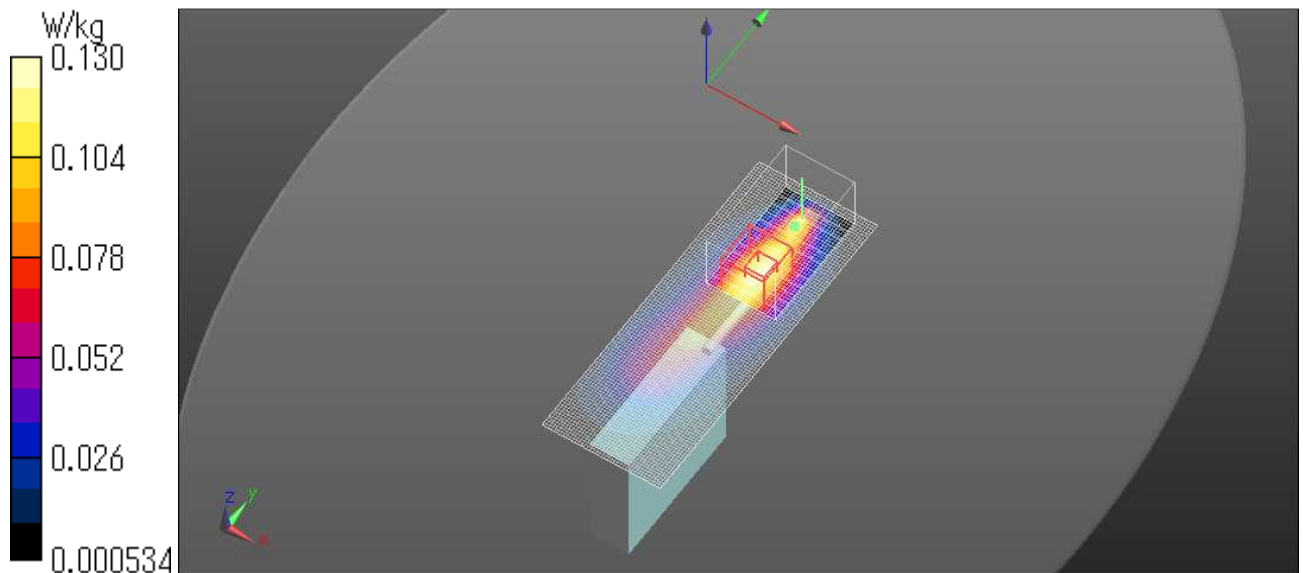

### Radio Microphone 941.625MHz Rear 0mm

Communication System: UID 0, Radio microphone (0); Communication System Band: UC; Frequency: 941.625 MHz; Duty Cycle: 1:1

Medium parameters used (interpolated):  $f = 941.625$  MHz;  $\sigma = 0.983$  S/m;  $\epsilon_r = 41.731$ ;  $\rho = 1000$  kg/m<sup>3</sup>

Phantom section: Flat Section

Measurement Standard: DASYS5 (IEEE/IEC/ANSI C63.19-2007)

DASY5 Configuration

Probe: ES3DV3 - SN3335; ConvF(6.31, 6.31, 6.31) @ 941.625 MHz; Calibrated: 2018/07/26

Sensor-Surface: 3mm (Mechanical Surface Detection)

Electronics: DAE4 Sn1369; Calibrated: 2019/05/08

Phantom: ELI v5.0 (20deg probe tilt); Type: QDOVA001BB; Serial: TP:1203

Measurement SW: DASYS52, Version 52.10 (2); SEMCAD X Version 14.6.12 (7450)

**Area Scan (51x111x1):** Interpolated grid: dx=1.500 mm, dy=1.500 mm

Maximum value of SAR (interpolated) = 0.177 W/kg

**Zoom Scan (8x14x7)/Cube 0:** Measurement grid: dx=5mm, dy=5mm, dz=5mm

Reference Value = 12.48 V/m; Power Drift = 0.10 dB

Peak SAR (extrapolated) = 0.754 W/kg

**SAR(1 g) = 0.142 W/kg; SAR(10 g) = 0.083 W/kg**

Maximum value of SAR (measured) = 0.179 W/kg

Date: 2019/07/09

Ambient Temp. : 24.0 degree.C. Liquid Temp.; 23.5 degree.C.

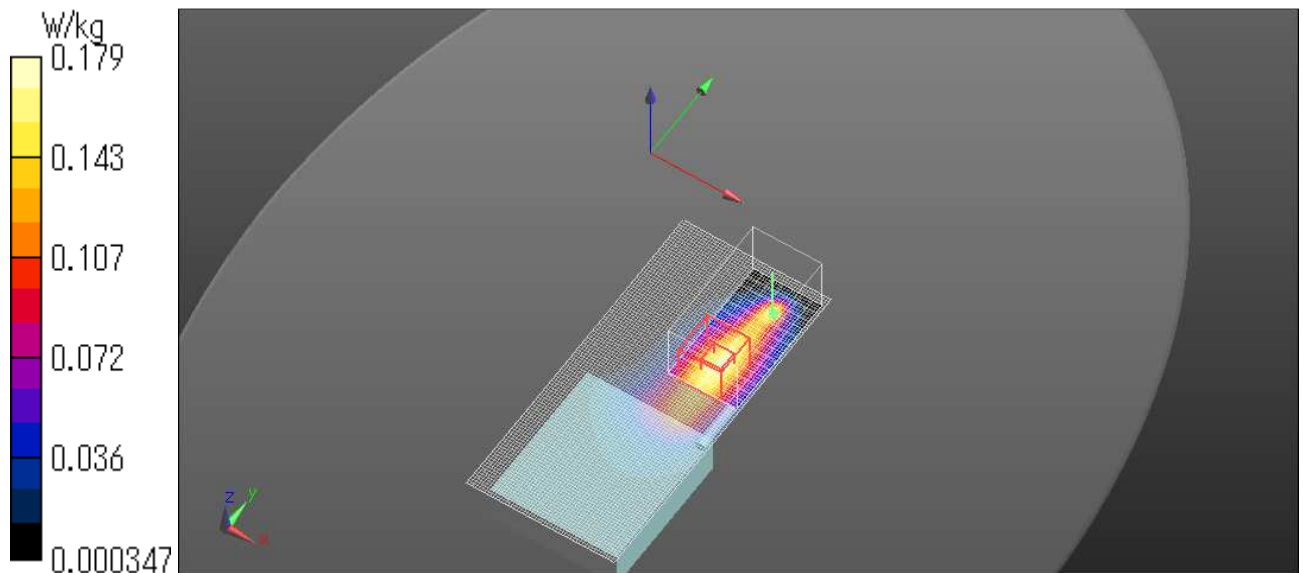

### Radio Microphone 941.625MHz Top 0mm

Communication System: UID 0, Radio microphone (0); Communication System Band: UC; Frequency: 941.625 MHz; Duty Cycle: 1:1

Medium parameters used (interpolated):  $f = 941.625$  MHz;  $\sigma = 0.983$  S/m;  $\epsilon_r = 41.731$ ;  $\rho = 1000$  kg/m<sup>3</sup>

Phantom section: Flat Section

Measurement Standard: DASYS5 (IEEE/IEC/ANSI C63.19-2007)

DASY5 Configuration

Probe: ES3DV3 - SN3335; ConvF(6.31, 6.31, 6.31) @ 941.625 MHz; Calibrated: 2018/07/26

Sensor-Surface: 3mm (Mechanical Surface Detection)

Electronics: DAE4 Sn1369; Calibrated: 2019/05/08

Phantom: ELI v5.0 (20deg probe tilt); Type: QDOVA001BB; Serial: TP:1203

Measurement SW: DASYS52, Version 52.10 (2); SEMCAD X Version 14.6.12 (7450)

**Area Scan (41x41x1):** Interpolated grid: dx=1.500 mm, dy=1.500 mm

Maximum value of SAR (interpolated) = 0.172 W/kg

**Zoom Scan (7x7x7)/Cube 0:** Measurement grid: dx=5mm, dy=5mm, dz=5mm

Reference Value = 13.51 V/m; Power Drift = -0.15 dB

Peak SAR (extrapolated) = 0.679 W/kg

**SAR(1 g) = 0.056 W/kg; SAR(10 g) = 0.013 W/kg**

Maximum value of SAR (measured) = 0.161 W/kg

Date: 2019/07/09

Ambient Temp. : 24.0 degree.C. Liquid Temp.; 23.5 degree.C.

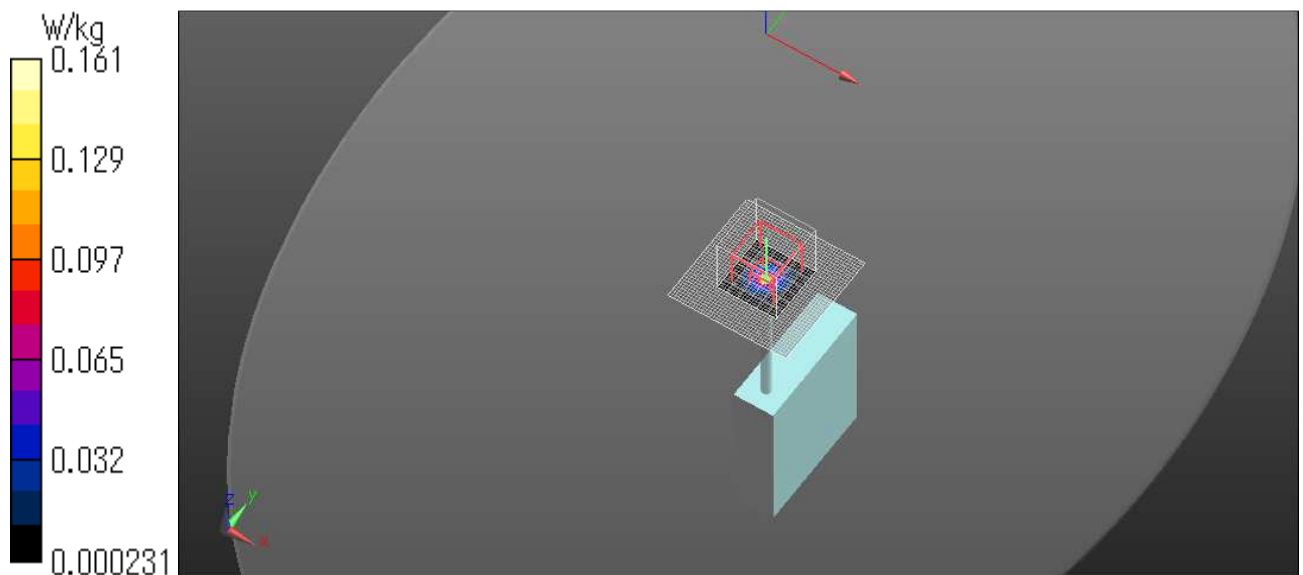

## APPENDIX 3 : System specifications

### Configuration and peripherals

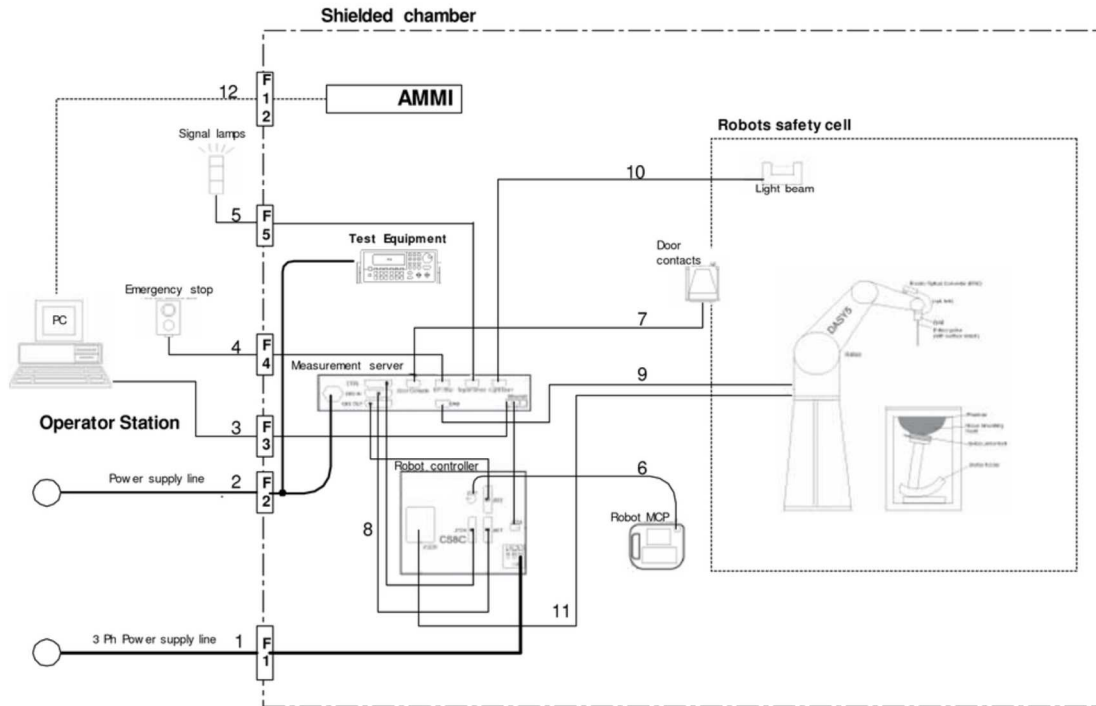

The DASYS5 system for performing compliance tests consist of the following items:

- a) A standard high precision 6-axis robot (Stäubli RX family) with controller and software.  
An arm extension for accommodating the data acquisition electronics (DAE).
- b) An isotropic field probe optimized and calibrated for the targeted measurement.
- c) A data acquisition electronic (DAE), which performs the signal amplification, signal multiplexing, AD-conversion, offset measurements, mechanical surface detection, collision detection, etc. The unit is battery powered with standard or rechargeable batteries. The signal is optically transmitted to the EOC.
- d) The Electro-optical converter (EOC) performs the conversion between optical and electrical of the signals for the digital communication to the DAE and for the analog signal from the optical surface detection.  
The EOC is connected to the measurement server.
- e) The function of the measurement server is to perform the time critical tasks such as signal filtering, control of the robot operation and fast movement interrupts.
- f) The Light Beam used is for probe alignment. This improves the (absolute) accuracy of the probe positioning.
- g) A computer running WinXP and the DASYS5 software.
- h) Remote control with teaches pendant and additional circuitry for robot safety such as warning lamps, etc.
- i) The phantom, the device holder and other accessories according to the targeted measurement.

## Specifications

### **a) Robot TX60L**

Number of Axes	:	6
Nominal Load	:	2 kg
Maximum Load	:	5kg
Reach	:	920mm
Repeatability	:	+/-0.03mm
Control Unit	:	CS8c
Programming Language	:	VAL3
Weight	:	52.2kg
Manufacture	:	Stäubli Robotics

### **b) E-Field Probe**

Model	:	EX3DV4
Construction	:	Symmetrical design with triangular core Built-in shielding against static charges PEEK enclosure material (resistant to organic solvents, e.g., glycol ether)
Frequency	:	10 MHz to > 6 GHz Linearity: $\pm 0.2$ dB (30 MHz to 6 GHz)
Directivity	:	+/-0.3 dB in HSL (rotation around probe axis) +/-0.5 dB in tissue material (rotation normal probe axis)
Dynamic Range	:	10 $\mu$ W/g to > 100 mW/g; Linearity +/-0.2 dB (noise: typically < 1 $\mu$ W/g)
Dimensions	:	Overall length: 337 mm (Tip: 20 mm) Tip diameter: 2.5mm (Body: 12 mm) Typical distance from probe tip to dipole centers: 1 mm
Application	:	Highprecision dosimetric measurement in any exposure scenario (e.g., very strong gradient fields). Only probe which enables compliance testing for frequencies up to 6GHz with precision of better 30%.
Manufacture	:	Schmid & Partner Engineering AG



**EX3DV4 E-field Probe**



<b>Model</b>	:	ES3DV3
<b>Construction</b>	:	Symmetric design with triangular core Interleaved sensors Built-in shielding against static charges PEEK enclosure material (resistant to organic solvents, e.g., DGBE) (resistant to organic solvents, e.g., glycol ether)
<b>Frequency</b>	:	10 MHz – 4 GHz; Linearity: $\pm 0.2$ dB (30 MHz – 4 GHz)
<b>Directivity</b>	:	$\pm 0.2$ dB in TSL (rotation around probe axis) $\pm 0.3$ dB in TSL (rotation normal to probe axis)
<b>Dynamic Range</b>	:	5 $\mu$ W/g – >100 mW/g; Linearity: $\pm 0.2$ dB)
<b>Dimensions</b>	:	Overall length: 337 mm (tip: 20 mm) Tip diameter: 3.9 mm (body: 12 mm) Distance from probe tip to dipole centers: 2.0 mm
<b>Application</b>	:	General dosimetry up to 4 GHz Dosimetry in strong gradient fields Compliance tests of mobile phones
<b>Manufacture</b>	:	Schmid & Partner Engineering AG



**ES3DV3 E-field Probe**

#### **c)Data Acquisition Electronic (DAE4)**

<b>Features</b>	:	Signal amplifier, multiplexer, A/D converter and control logic Serial optical link for communication with DASY5 embedded system (fully remote controlled) Two step probe touch detector for mechanical surface detection and emergency robot stop
<b>Measurement Range</b>	:	-100 to +300 mV (16 bit resolution and two range settings: 4mV, 400mV)
<b>Input Offset voltage</b>	:	< 5 $\mu$ V (with auto zero)
<b>Input Resistance</b>	:	200 M $\Omega$
<b>Input Bias Current</b>	:	< 50 fA
<b>Battery Power</b>	:	> 10 h of operation (with two 9.6 V NiMH accus)
<b>Dimension</b>	:	60 x 60 x 68 mm
<b>Manufacture</b>	:	Schmid & Partner Engineering AG

#### **d)Electro-Optic Converter (EOC)**

<b>Version</b>	:	EOC 61
<b>Description</b>	:	for TX60 robot arm, including proximity sensor
<b>Manufacture</b>	:	Schmid & Partner Engineering AG

#### **e)DASY5 Measurement server**

<b>Features</b>	:	Intel ULV Celeron 400MHz 128MB chip disk and 128MB RAM 16 Bit A/D converter for surface detection system Vacuum Fluorescent Display Robot Interface Serial link to DAE (with watchdog supervision) Door contact port (Possibility to connect a light curtain) Emergency stop port (to connect the remote control) Signal lamps port Light beam port Three Ethernet connection ports Two USB 2.0 Ports Two serial links Expansion port for future applications
<b>Dimensions (L x W x H)</b>	:	440 x 241 x 89 mm
<b>Manufacture</b>	:	Schmid & Partner Engineering AG

#### **f) Light Beam Switches**

<b>Version</b>	:	LB5
<b>Dimensions (L x H)</b>	:	110 x 80 mm
<b>Thickness</b>	:	12 mm
<b>Beam-length</b>	:	80 mm
<b>Manufacture</b>	:	Schmid & Partner Engineering AG

#### **g)Software**

<b>Item</b>	:	Dosimetric Assessment System DASY5
<b>Type No.</b>	:	SD 000 401A, SD 000 402A
<b>Software version No.</b>	:	DASY52, Version 52.6 (1)
<b>Manufacture / Origin</b>	:	Schmid & Partner Engineering AG

#### **h)Robot Control Unit**

<b>Weight</b>	:	70 Kg
<b>AC Input Voltage</b>	:	selectable
<b>Manufacturer</b>	:	Stäubli Robotics

### i) Phantom and Device Holder

#### Phantom

<b>Type</b>	:	SAM Twin Phantom V4.0
<b>Description</b>	:	The shell corresponds to the specifications of the Specific Anthropomorphic Mannequin (SAM) phantom defined in IEEE 1528 and IEC 62209-1. It enables the dosimetric evaluation of left and right hand phone usage as well as body mounted usage at the flat phantom region. A cover prevents evaporation of the liquid. Reference markings on the phantom allow the complete setup of all predefined phantom positions and measurement grids by teaching three points with the robot.
<b>Material</b>	:	Vinylester, glass fiber reinforced (VE-GF)
<b>Shell Material</b>	:	Fiberglass
<b>Thickness</b>	:	2.0 +/-0.2 mm
<b>Dimensions</b>	:	Length: 1000 mm Width: 500 mm Height: adjustable feet
<b>Volume</b>	:	Approx. 25 liters
<b>Manufacture</b>	:	Schmid & Partner Engineering AG

<b>Type</b>	:	2mm Flat phantom ERI4.0
<b>Description</b>	:	Phantom for compliance testing of handheld and body-mounted wireless devices in the frequency range of 30 MHz to 6 GHz. ELI4 is fully compatible with the latest draft of the standard IEC 62209 Part II and all known tissue simulating liquids. ELI4 has been optimized regarding its performance and can be integrated into our standard phantom tables. A cover prevents evaporation of the liquid. Reference markings on the phantom allow installation of the complete setup, including all predefined phantom positions and measurement grids, by teaching three points. The phantom is supported by software version DAS4.5 and higher and is compatible with all SPEAG dosimetric probes and dipoles.
<b>Material</b>	:	Vinylester, glass fiber reinforced (VE-GF)
<b>Shell Thickness</b>	:	2.0 ± 0.2 mm (sagging: <1%)
<b>Filling Volume</b>	:	approx. 30 liters
<b>Dimensions</b>	:	Major ellipse axis: 600 mm Minor axis: 400 mm
<b>Manufacture</b>	:	Schmid & Partner Engineering AG

#### Device Holder

In combination with the Twin SAM Phantom V4.0/V4.0c or ELI4, the Mounting Device enables the rotation of the mounted transmitter device in spherical coordinates. Rotation point is the ear opening point. Transmitter devices can be easily and accurately positioned according to IEC, IEEE, FCC or other specifications. The device holder can be locked for positioning at different phantom sections (left head, right head, flat).

**Material** : POM

#### Laptio Extensions kit

Simple but effective and easy-to-use extension for Mounting Device that facilitates the testing of larger devices according to IEC 62209-2 (e.g., laptops, cameras, etc.). It is lightweight and fits easily on the upper part of the Mounting Device in place of the phone positioner. The extension is fully compatible with the Twin-SAM, ELI4 Phantoms.

**Material** : POM, Acrylic glass, Foam

#### Urethane

For this measurement, the urethane foam was used as device holder.

**j) Simulated Tissues (Liquid)**

The following tissue formulations are provided for reference only as some of the parameters have not been thoroughly verified. The composition of ingredients may be modified accordingly to achieve the desired target tissue parameters required for routine SAR evaluation.

Mixture (%)	Frequency (MHz)									
	450		900		1800		1950		2450	
Tissue Type	Head	Body	Head	Body	Head	Body	Head	Body	Head	Body
Water	38.91	46.21	40.29	50.75	55.24	70.17	55.41	69.79	55.0	68.64
Sugar	56.93	51.17	57.90	48.21	-	-	-	-	-	-
Cellulose	0.25	0.18	0.24	0.00	-	-	-	-	-	-
Salt (NaCl)	3.79	2.34	1.38	0.94	0.31	0.39	0.08	0.2	-	-
Preventol	0.12	0.08	0.18	0.10	-	-	-	-	-	-
DGMBE	-	-	-	-	44.45	29.44	44.51	30.0	45.0	31.37
Dielectric Constant	43.42	58.0	42.54	56.1	42.0	56.8	39.9	54.0	39.8	52.5
Conductivity (S/m)	0.85	0.83	0.91	0.95	1.0	1.07	1.42	1.45	1.88	1.78

Note: DGMBE (Diethylenglycol-monobutyl ether)

The simulated tissue (liquid) of 1800MHz was used for the test frequency of 1700MHz to 1800MHz.

Mixture (%)	Frequency (MHz)	
	650&750	1450
Tissue Type	Head and Body	Head and Body
Water	35-58%	52-75%
Sugar	40-60%	-
Cellulose	<0.3%	-
Salt (NaCl)	0-6%	<1%
Preventol	0.1-0.7%	-
DGMBE	-	25-48%

Mixture (%)	Frequency (MHz)	
	5800	
Tissue Type	Head	Body
Water	64.0	78.0
Mineral Oil	18.0	11.0
Emulsifiers	15.0	9.0
Additives and salt	3.0	2.0

**Product identifier**

Trade name	Broad Band Tissue Simulation Liquid HBBL600-10000V6, MBBL600-6000V6, HU16B, MU16B
Manufacturer/Supplier	Schmid & Partner Engineering AG

**Declarable components:**

CAS: 107-21-1 EINECS: 203-473-3 Reg.nr.: 01-2119456816-28-0000	<b>Ethenediol</b> STOT RE 2, H373; Acute Tox. 4, H302	< 5.2%
CAS: 68608-26-4 EINECS: 271-781-5 Reg.nr.: 01-2119527859-22-0000	<b>Sodium petroleum sulfonate</b> Eye Irrit. 2, H319	< 2.9%
CAS: 107-41-5 EINECS: 203-489-0 Reg.nr.: 01-2119539582-35-0000	<b>Hexylene Glycol / 2-Methyl-pentane-2,4-diol</b> Skin Irrit. 2, H315; Eye Irrit. 2, H319	< 2.9%
CAS: 68920-66-1 NLP: 500-236-9 Reg.nr.: 01-2119489407-26-0000	<b>Alkoxylated alcohol, &gt; C<sub>16</sub></b> Aquatic Chronic 2, H411; Skin Irrit. 2, H315; Eye Irrit. 2, H319	< 2.0%

**UL Japan, Inc.**

**Ise EMC Lab.**

4383-326 Asama-cho, Ise-shi, Mie-ken 516-0021 JAPAN

Telephone: +81 596 24 8999

Facsimile: +81 596 24 8124

System Check Dipole SAR Calibration Certificate -Dipole 450MHz(D450MHzV3,S/N:1051)

**Calibration Laboratory of  
Schmid & Partner  
Engineering AG**  
Zeughausstrasse 43, 8004 Zurich, Switzerland



**S** Schweizerischer Kalibrierdienst  
**C** Service suisse d'étalonnage  
**S** Servizio svizzero di taratura  
**S** Swiss Calibration Service

Accredited by the Swiss Accreditation Service (SAS)  
The Swiss Accreditation Service is one of the signatories to the EA  
Multilateral Agreement for the recognition of calibration certificates

Accreditation No.: SCS 0108

Client **UL Japan (Vitec)**

Certificate No: **D450V3-1051\_Sep18**

CALIBRATION CERTIFICATE			
Object	D450V3 - SN:1051		
Calibration procedure(s)	QA CAL-15.v8 Calibration procedure for dipole validation kits below 700 MHz		
Calibration date:	September 10, 2018		
This calibration certificate documents the traceability to national standards, which realize the physical units of measurements (SI). The measurements and the uncertainties with confidence probability are given on the following pages and are part of the certificate.			
All calibrations have been conducted in the closed laboratory facility: environment temperature (22 ± 3)°C and humidity < 70%.			
Calibration Equipment used (M&TE critical for calibration)			
Primary Standards	ID #	Cal Date (Certificate No.)	Scheduled Calibration
Power meter NRP	SN: 104778	04-Apr-18 (No. 217-02672/02673)	Apr-19
Power sensor NRP-Z91	SN: 103244	04-Apr-18 (No. 217-02672)	Apr-19
Power sensor NRP-Z91	SN: 103245	04-Apr-18 (No. 217-02673)	Apr-19
Reference 20 dB Attenuator	SN: 5277 (20x)	04-Apr-18 (No. 217-02682)	Apr-19
Type-N mismatch combination	SN: 5047.2 / 06327	04-Apr-18 (No. 217-02683)	Apr-19
Reference Probe EX3DV4	SN: 3877	30-Dec-17 (No. EX3-3877_Dec17)	Dec-18
DAE4	SN: 654	05-Jul-18 (No. DAE4-654_Jul18)	Jul-19
Secondary Standards	ID #	Check Date (in house)	Scheduled Check
Power meter E4419B	SN: GB41293874	12-Jun-18 (No. 217-02285/02284)	In house check: Jun-20
Power sensor E4412A	SN: MY41498087	12-Jun-18 (No. 217-02285)	In house check: Jun-20
Power sensor E4412A	SN: 000110210	12-Jun-18 (No. 217-02284)	In house check: Jun-20
RF generator HP 8648C	SN: US3642U01700	04-Aug-99 (in house check Jun-18)	In house check: Jun-20
Network Analyzer Agilent E8358A	SN: US41080477	31-Mar-14 (in house check Oct-17)	In house check: Oct-18
Calibrated by:	Name Michael Weber	Function Laboratory Technician	Signature 
Approved by:	Name Katja Pokovic	Function Technical Manager	Signature 
			Issued: September 10, 2018
This calibration certificate shall not be reproduced except in full without written approval of the laboratory.			

Certificate No: D450V3-1051\_Sep18

Page 1 of 8

**Calibration Laboratory of**  
Schmid & Partner  
Engineering AG  
Zeughausstrasse 43, 8004 Zurich, Switzerland



**S** Schweizerischer Kalibrierdienst  
**C** Service suisse d'étalonnage  
**S** Servizio svizzero di taratura  
**S** Swiss Calibration Service

Accredited by the Swiss Accreditation Service (SAS)  
The Swiss Accreditation Service is one of the signatories to the EA  
Multilateral Agreement for the recognition of calibration certificates

Accreditation No.: **SCS 0108**

**Glossary:**

TSL tissue simulating liquid  
ConvF sensitivity in TSL / NORM x,y,z  
N/A not applicable or not measured

**Calibration is Performed According to the Following Standards:**

- a) IEEE Std 1528-2013, "IEEE Recommended Practice for Determining the Peak Spatial-Averaged Specific Absorption Rate (SAR) in the Human Head from Wireless Communications Devices: Measurement Techniques", June 2013
- b) IEC 62209-1, "Measurement procedure for the assessment of Specific Absorption Rate (SAR) from hand-held and body-mounted devices used next to the ear (frequency range of 300 MHz to 6 GHz)", July 2016
- c) IEC 62209-2, "Procedure to determine the Specific Absorption Rate (SAR) for wireless communication devices used in close proximity to the human body (frequency range of 30 MHz to 6 GHz)", March 2010
- d) KDB 865664, "SAR Measurement Requirements for 100 MHz to 6 GHz"

**Additional Documentation:**

- e) DASY4/5 System Handbook

**Methods Applied and Interpretation of Parameters:**

- *Measurement Conditions:* Further details are available from the Validation Report at the end of the certificate. All figures stated in the certificate are valid at the frequency indicated.
- *Antenna Parameters with TSL:* The dipole is mounted with the spacer to position its feed point exactly below the center marking of the flat phantom section, with the arms oriented parallel to the body axis.
- *Feed Point Impedance and Return Loss:* These parameters are measured with the dipole positioned under the liquid filled phantom. The impedance stated is transformed from the measurement at the SMA connector to the feed point. The Return Loss ensures low reflected power. No uncertainty required.
- *Electrical Delay:* One-way delay between the SMA connector and the antenna feed point. No uncertainty required.
- *SAR measured:* SAR measured at the stated antenna input power.
- *SAR normalized:* SAR as measured, normalized to an input power of 1 W at the antenna connector.
- *SAR for nominal TSL parameters:* The measured TSL parameters are used to calculate the nominal SAR result.

The reported uncertainty of measurement is stated as the standard uncertainty of measurement multiplied by the coverage factor  $k=2$ , which for a normal distribution corresponds to a coverage probability of approximately 95%.

### Measurement Conditions

DASY system configuration, as far as not given on page 1.

DASY Version	DASY5	V52.10.1
Extrapolation	Advanced Extrapolation	
Phantom	ELI4 Flat Phantom	Shell thickness: 2 ± 0.2 mm
Distance Dipole Center - TSL	15 mm	with Spacer
Zoom Scan Resolution	dx, dy, dz = 5 mm	
Frequency	450 MHz ± 1 MHz	

### Head TSL parameters

The following parameters and calculations were applied.

	Temperature	Permittivity	Conductivity
Nominal Head TSL parameters	22.0 °C	43.5	0.87 mho/m
Measured Head TSL parameters	(22.0 ± 0.2) °C	44.4 ± 6 %	0.87 mho/m ± 6 %
Head TSL temperature change during test	< 0.5 °C	----	----

### SAR result with Head TSL

SAR averaged over 1 cm <sup>3</sup> (1 g) of Head TSL	Condition	
SAR measured	250 mW input power	1.12 W/kg
SAR for nominal Head TSL parameters	normalized to 1W	<b>4.50 W/kg ± 18.1 % (k=2)</b>

SAR averaged over 10 cm <sup>3</sup> (10 g) of Head TSL	condition	
SAR measured	250 mW input power	0.749 W/kg
SAR for nominal Head TSL parameters	normalized to 1W	<b>3.01 W/kg ± 17.6 % (k=2)</b>

### Body TSL parameters

The following parameters and calculations were applied.

	Temperature	Permittivity	Conductivity
Nominal Body TSL parameters	22.0 °C	56.7	0.94 mho/m
Measured Body TSL parameters	(22.0 ± 0.2) °C	56.2 ± 6 %	0.92 mho/m ± 6 %
Body TSL temperature change during test	< 0.5 °C	----	----

### SAR result with Body TSL

SAR averaged over 1 cm <sup>3</sup> (1 g) of Body TSL	Condition	
SAR measured	250 mW input power	1.10 W/kg
SAR for nominal Body TSL parameters	normalized to 1W	<b>4.47 W/kg ± 18.1 % (k=2)</b>

SAR averaged over 10 cm <sup>3</sup> (10 g) of Body TSL	condition	
SAR measured	250 mW input power	0.737 W/kg
SAR for nominal Body TSL parameters	normalized to 1W	<b>2.99 W/kg ± 17.6 % (k=2)</b>

**Appendix (Additional assessments outside the scope of SCS 0108)**

**Antenna Parameters with Head TSL**

Impedance, transformed to feed point	58.6 $\Omega$ - 4.0 j $\Omega$
Return Loss	- 21.2 dB

**Antenna Parameters with Body TSL**

Impedance, transformed to feed point	54.8 $\Omega$ - 7.9 j $\Omega$
Return Loss	- 21.1 dB

**General Antenna Parameters and Design**

Electrical Delay (one direction)	1.349 ns
----------------------------------	----------

After long term use with 100W radiated power, only a slight warming of the dipole near the feedpoint can be measured.

The dipole is made of standard semirigid coaxial cable. The center conductor of the feeding line is directly connected to the second arm of the dipole. The antenna is therefore short-circuited for DC-signals. On some of the dipoles, small end caps are added to the dipole arms in order to improve matching when loaded according to the position as explained in the "Measurement Conditions" paragraph. The SAR data are not affected by this change. The overall dipole length is still according to the Standard.

No excessive force must be applied to the dipole arms, because they might bend or the soldered connections near the feedpoint may be damaged.

**Additional EUT Data**

Manufactured by	SPEAG
Manufactured on	July 29, 2005



**DASY5 Validation Report for Head TSL**

Date: 10.09.2018

Test Laboratory: SPEAG, Zurich, Switzerland

**DUT: Dipole 450 MHz D450V3; Type: D450V3; Serial: D450V3 - SN:1051**

Communication System: UID 0 - CW; Frequency: 450 MHz  
Medium parameters used:  $f = 450 \text{ MHz}$ ;  $\sigma = 0.87 \text{ S/m}$ ;  $\epsilon_r = 44.4$ ;  $\rho = 1000 \text{ kg/m}^3$   
Phantom section: Flat Section  
Measurement Standard: DASY5 (IEEE/IEC/ANSI C63.19-2011)

DASY52 Configuration:

- Probe: EX3DV4 - SN3877; ConvF(10.5, 10.5, 10.5) @ 450 MHz; Calibrated: 30.12.2017
- Sensor-Surface: 1.4mm (Mechanical Surface Detection)
- Electronics: DAE4 Sn654; Calibrated: 05.07.2018
- Phantom: ELI v4.0; Type: QDOVA001BB; Serial: TP:1003
- DASY52 52.10.1(1476); SEMCAD X 14.6.11(7439)

**Dipole Calibration for Head Tissue/d=15mm, Pin=250mW/Zoom Scan (7x7x7)/Cube 0:**

Measurement grid:  $dx=5\text{mm}$ ,  $dy=5\text{mm}$ ,  $dz=5\text{mm}$   
Reference Value = 38.61 V/m; Power Drift = 0.01 dB  
Peak SAR (extrapolated) = 1.73 W/kg  
**SAR(1 g) = 1.12 W/kg; SAR(10 g) = 0.749 W/kg**  
Maximum value of SAR (measured) = 1.51 W/kg

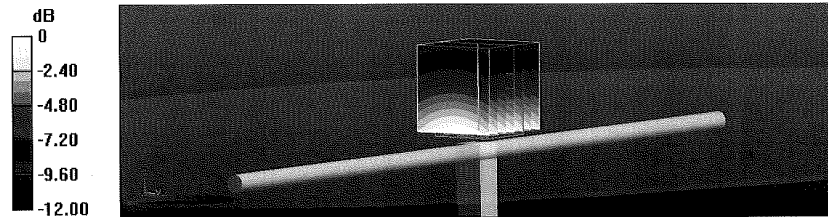

0 dB = 1.51 W/kg = 1.79 dBW/kg

Impedance Measurement Plot for Head TSL

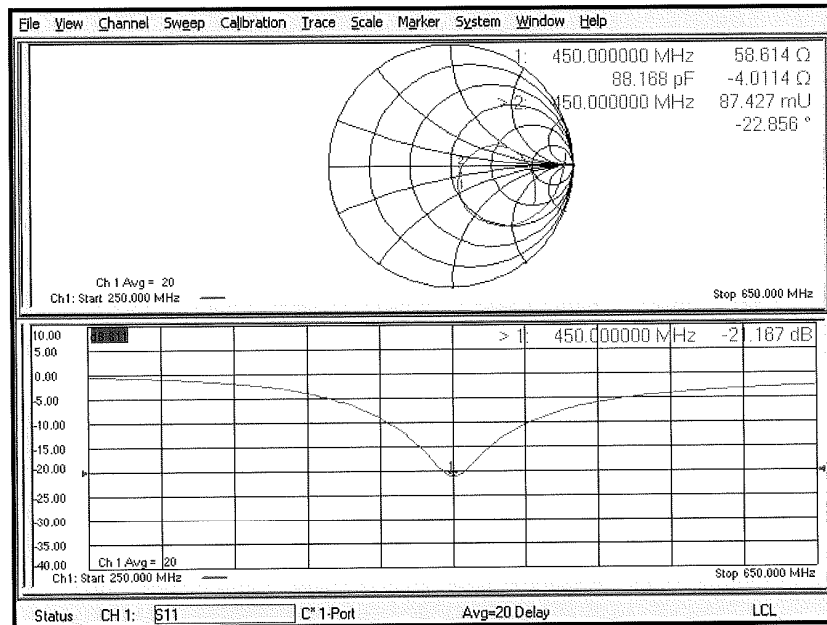

**DASY5 Validation Report for Body TSL**

Date: 10.09.2018

Test Laboratory: SPEAG, Zurich, Switzerland

**DUT: Dipole 450 MHz D450V3; Type: D450V3; Serial: D450V3 - SN:1051**

Communication System: UID 0 - CW; Frequency: 450 MHz  
Medium parameters used:  $f = 450$  MHz;  $\sigma = 0.92$  S/m;  $\epsilon_r = 56.2$ ;  $\rho = 1000$  kg/m<sup>3</sup>  
Phantom section: Flat Section  
Measurement Standard: DASY5 (IEEE/IEC/ANSI C63.19-2011)

DASY52 Configuration:

- Probe: EX3DV4 - SN3877; ConvF(10.8, 10.8, 10.8) @ 450 MHz; Calibrated: 30.12.2017
- Sensor-Surface: 1.4mm (Mechanical Surface Detection)
- Electronics: DAE4 Sn654; Calibrated: 05.07.2018
- Phantom: ELI v4.0; Type: QDOVA001BB; Serial: TP:1003
- DASY52 52.10.1(1476); SEMCAD X 14.6.11(7439)

**Dipole Calibration for Body Tissue/d=15mm, Pin=250mW/Zoom Scan (7x7x7)/Cube 0:**

Measurement grid:  $dx=5$ mm,  $dy=5$ mm,  $dz=5$ mm  
Reference Value = 41.30 V/m; Power Drift = -0.06 dB  
Peak SAR (extrapolated) = 1.70 W/kg  
**SAR(1 g) = 1.1 W/kg; SAR(10 g) = 0.737 W/kg**  
Maximum value of SAR (measured) = 1.48 W/kg

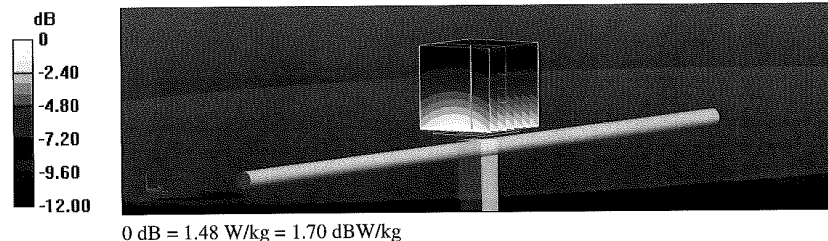

Impedance Measurement Plot for Body TSL

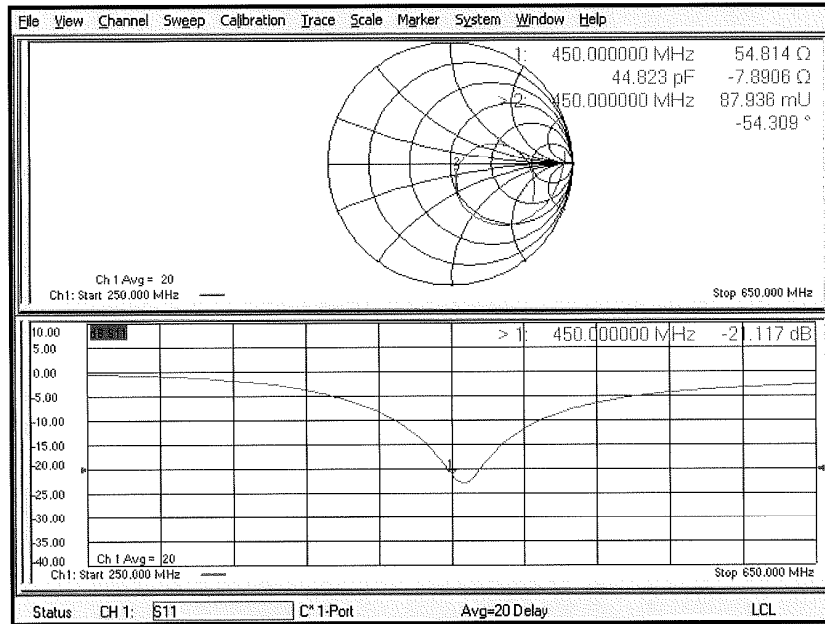

**System Check Dipole SAR Calibration Certificate -Dipole 600MHz(D600V3,S/N:1003)**

**Calibration Laboratory of  
 Schmid & Partner  
 Engineering AG**  
 Zeughausstrasse 43, 8004 Zurich, Switzerland



**S** Schweizerischer Kalibrierdienst  
**C** Service suisse d'étalonnage  
**S** Servizio svizzero di taratura  
**S** Swiss Calibration Service

Accredited by the Swiss Accreditation Service (SAS)  
 The Swiss Accreditation Service is one of the signatories to the EA  
 Multilateral Agreement for the recognition of calibration certificates

Accreditation No.: SCS 0108

Client **UL Japan (Vitec)**

Certificate No: **D600V3-1003\_Sep16**

CALIBRATION CERTIFICATE			
Object	D600V3 - SN: 1003		
Calibration procedure(s)	QA CAL-15.v8 Calibration procedure for dipole validation kits below 700 MHz		
Calibration date:	September 19, 2016		
This calibration certificate documents the traceability to national standards, which realize the physical units of measurements (SI). The measurements and the uncertainties with confidence probability are given on the following pages and are part of the certificate.			
All calibrations have been conducted in the closed laboratory facility: environment temperature (22 ± 3)°C and humidity < 70%.			
Calibration Equipment used (M&TE critical for calibration)			
<b>Primary Standards</b>	<b>ID #</b>	<b>Cal Date (Certificate No.)</b>	<b>Scheduled Calibration</b>
Power meter NRP	SN: 104778	06-Apr-16 (No. 217-02288/02289)	Apr-17
Power sensor NRP-Z91	SN: 103244	06-Apr-16 (No. 217-02288)	Apr-17
Power sensor NRP-Z91	SN: 103245	06-Apr-16 (No. 217-02289)	Apr-17
Reference 20 dB Attenuator	SN: 5277 (20x)	05-Apr-16 (No. 217-02293)	Apr-17
Type-N mismatch combination	SN: 5047.2 / 06327	05-Apr-16 (No. 217-02295)	Apr-17
Reference Probe ET3DV6	SN: 1507	31-Dec-15 (No. ET3-1507_Dec15)	Dec-16
DAE4	SN: 654	12-Aug-16 (No. DAE4-654_Aug16)	Aug-17
<b>Secondary Standards</b>	<b>ID #</b>	<b>Check Date (in house)</b>	<b>Scheduled Check</b>
Power meter E4419B	SN: GB41293874	06-Apr-16 (No. 217-02285/02284)	In house check: Jun-18
Power sensor E4412A	SN: MY41498097	06-Apr-16 (No. 217-02285)	In house check: Jun-18
Power sensor E4412A	SN: 000110210	06-Apr-16 (No. 217-02284)	In house check: Jun-18
RF generator HP 8648C	SN: US3642U01700	04-Aug-99 (in house check Jun-16)	In house check: Jun-18
Network Analyzer HP 8753E	SN: US37390585	18-Oct-01 (in house check Oct-15)	In house check: Oct-16
Calibrated by:	Name Michael Weber	Function Laboratory Technician	Signature 
Approved by:	Name Katja Pokovic	Function Technical Manager	Signature 
			Issued: September 19, 2016
This calibration certificate shall not be reproduced except in full without written approval of the laboratory.			

Calibration Laboratory of  
Schmid & Partner  
Engineering AG  
Zeughausstrasse 43, 8004 Zurich, Switzerland



S Schweizerischer Kalibrierdienst  
C Service suisse d'étalonnage  
S Servizio svizzero di taratura  
S Swiss Calibration Service

Accredited by the Swiss Accreditation Service (SAS)  
The Swiss Accreditation Service is one of the signatories to the EA  
Multilateral Agreement for the recognition of calibration certificates

Accreditation No.: SCS 0108

**Glossary:**

TSL tissue simulating liquid  
ConvF sensitivity in TSL / NORM x,y,z  
N/A not applicable or not measured

**Calibration is Performed According to the Following Standards:**

- a) IEEE Std 1528-2013, "IEEE Recommended Practice for Determining the Peak Spatial-Averaged Specific Absorption Rate (SAR) in the Human Head from Wireless Communications Devices: Measurement Techniques", June 2013
- b) IEC 62209-1, "Procedure to measure the Specific Absorption Rate (SAR) for hand-held devices used in close proximity to the ear (frequency range of 300 MHz to 3 GHz)", February 2005
- c) IEC 62209-2, "Procedure to determine the Specific Absorption Rate (SAR) for wireless communication devices used in close proximity to the human body (frequency range of 30 MHz to 6 GHz)", March 2010
- d) KDB 865664, "SAR Measurement Requirements for 100 MHz to 6 GHz"

**Additional Documentation:**

- e) DASY4/5 System Handbook

**Methods Applied and Interpretation of Parameters:**

- *Measurement Conditions:* Further details are available from the Validation Report at the end of the certificate. All figures stated in the certificate are valid at the frequency indicated.
- *Antenna Parameters with TSL:* The dipole is mounted with the spacer to position its feed point exactly below the center marking of the flat phantom section, with the arms oriented parallel to the body axis.
- *Feed Point Impedance and Return Loss:* These parameters are measured with the dipole positioned under the liquid filled phantom. The impedance stated is transformed from the measurement at the SMA connector to the feed point. The Return Loss ensures low reflected power. No uncertainty required.
- *Electrical Delay:* One-way delay between the SMA connector and the antenna feed point. No uncertainty required.
- *SAR measured:* SAR measured at the stated antenna input power.
- *SAR normalized:* SAR as measured, normalized to an input power of 1 W at the antenna connector.
- *SAR for nominal TSL parameters:* The measured TSL parameters are used to calculate the nominal SAR result.

The reported uncertainty of measurement is stated as the standard uncertainty of measurement multiplied by the coverage factor  $k=2$ , which for a normal distribution corresponds to a coverage probability of approximately 95%.

### Measurement Conditions

DASY system configuration, as far as not given on page 1.

DASY Version	DASY5	V52.8.8
Extrapolation	Advanced Extrapolation	
Phantom	ELI4 Flat Phantom	Shell thickness: $2 \pm 0.2$ mm
Distance Dipole Center - TSL	15 mm	with Spacer
Zoom Scan Resolution	dx, dy, dz = 5 mm	
Frequency	600 MHz $\pm$ 1 MHz	

### Head TSL parameters

The following parameters and calculations were applied.

	Temperature	Permittivity	Conductivity
Nominal Head TSL parameters	22.0 °C	42.7	0.88 mho/m
Measured Head TSL parameters	(22.0 $\pm$ 0.2) °C	41.5 $\pm$ 6 %	0.87 mho/m $\pm$ 6 %
Head TSL temperature change during test	< 0.5 °C	----	----

### SAR result with Head TSL

SAR averaged over 1 cm <sup>3</sup> (1 g) of Head TSL	Condition	
SAR measured	250 mW input power	1.61 W/kg
SAR for nominal Head TSL parameters	normalized to 1W	6.46 W/kg $\pm$ 18.1 % (k=2)

SAR averaged over 10 cm <sup>3</sup> (10 g) of Head TSL	condition	
SAR measured	250 mW input power	1.05 W/kg
SAR for nominal Head TSL parameters	normalized to 1W	4.21 W/kg $\pm$ 17.6 % (k=2)

### Body TSL parameters

The following parameters and calculations were applied.

	Temperature	Permittivity	Conductivity
Nominal Body TSL parameters	22.0 °C	56.1	0.95 mho/m
Measured Body TSL parameters	(22.0 $\pm$ 0.2) °C	55.8 $\pm$ 6 %	0.91 mho/m $\pm$ 6 %
Body TSL temperature change during test	< 0.5 °C	----	----

### SAR result with Body TSL

SAR averaged over 1 cm <sup>3</sup> (1 g) of Body TSL	Condition	
SAR measured	250 mW input power	1.62 W/kg
SAR for nominal Body TSL parameters	normalized to 1W	6.69 W/kg $\pm$ 18.1 % (k=2)

SAR averaged over 10 cm <sup>3</sup> (10 g) of Body TSL	condition	
SAR measured	250 mW input power	1.07 W/kg
SAR for nominal Body TSL parameters	normalized to 1W	4.40 W/kg $\pm$ 17.6 % (k=2)

**Appendix (Additional assessments outside the scope of SCS 0108)**

**Antenna Parameters with Head TSL**

Impedance, transformed to feed point	60.2 $\Omega$ + 2.3 $\mu\Omega$
Return Loss	- 20.5 dB

**Antenna Parameters with Body TSL**

Impedance, transformed to feed point	53.0 $\Omega$ - 4.8 $\mu\Omega$
Return Loss	- 25.2 dB

**General Antenna Parameters and Design**

Electrical Delay (one direction)	1.153 ns
----------------------------------	----------

After long term use with 100W radiated power, only a slight warming of the dipole near the feedpoint can be measured.

The dipole is made of standard semirigid coaxial cable. The center conductor of the feeding line is directly connected to the second arm of the dipole. The antenna is therefore short-circuited for DC-signals. On some of the dipoles, small end caps are added to the dipole arms in order to improve matching when loaded according to the position as explained in the "Measurement Conditions" paragraph. The SAR data are not affected by this change. The overall dipole length is still according to the Standard.

No excessive force must be applied to the dipole arms, because they might bend or the soldered connections near the feedpoint may be damaged.

**Additional EUT Data**

Manufactured by	SPEAG
Manufactured on	February 08, 2013



**DASY5 Validation Report for Head TSL**

Date: 19.09.2016

Test Laboratory: SPEAG, Zurich, Switzerland

**DUT: Dipole 600 MHz; Type: D600V3; Serial: D600V3 - SN: 1003**

Communication System: UID 0 - CW; Frequency: 600 MHz  
Medium parameters used:  $f = 600$  MHz;  $\sigma = 0.87$  S/m;  $\epsilon_r = 41.5$ ;  $\rho = 1000$  kg/m<sup>3</sup>  
Phantom section: Flat Section  
Measurement Standard: DASY5 (IEEE/IEC/ANSI C63.19-2011)

DASY52 Configuration:

- Probe: ET3DV6 - SN1507; ConvF(6.54, 6.54, 6.54); Calibrated: 31.12.2015;
- Sensor-Surface: 4mm (Mechanical Surface Detection)
- Electronics: DAE4 Sn654; Calibrated: 12.08.2016
- Phantom: ELI v4.0; Type: QDOVA001BB; Serial: TP:1003
- DASY52 52.8.8(1258); SEMCAD X 14.6.10(7372)

**Dipole Calibration for Head Tissue/Pin=250 mW, d=15mm/Zoom Scan (7x7x7)/Cube 0:**

Measurement grid: dx=5mm, dy=5mm, dz=5mm  
Reference Value = 45.72 V/m; Power Drift = -0.00 dB  
Peak SAR (extrapolated) = 2.57 W/kg  
**SAR(1 g) = 1.61 W/kg; SAR(10 g) = 1.05 W/kg**  
Maximum value of SAR (measured) = 1.72 W/kg

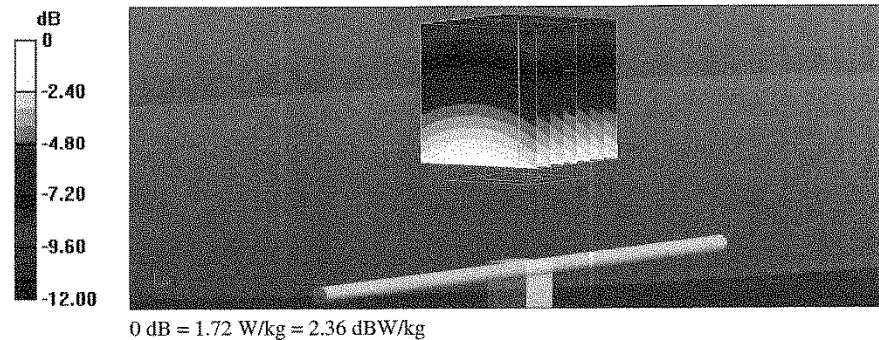

Impedance Measurement Plot for Head TSL

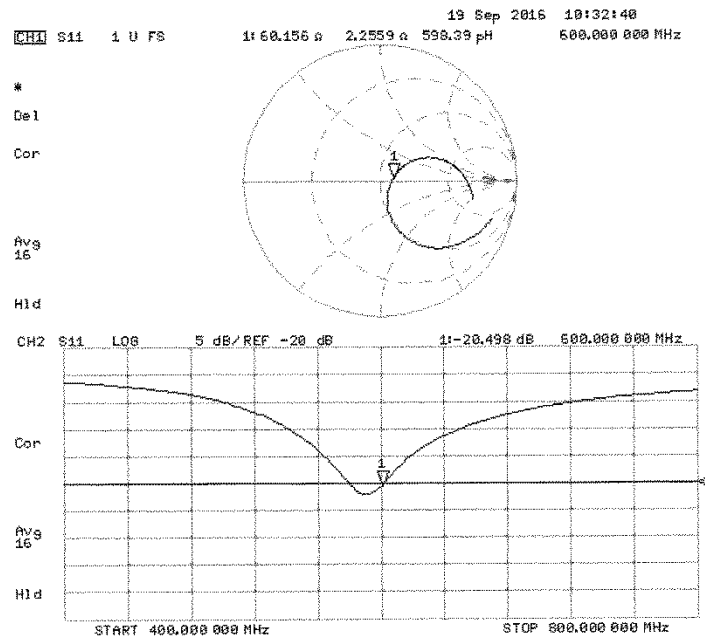

**DASY5 Validation Report for Body TSL**

Date: 19.09.2016

Test Laboratory: SPEAG, Zurich, Switzerland

**DUT: Dipole 600 MHz; Type: D600V3; Serial: D600V3 - SN: 1003**

Communication System: UID 0 - CW; Frequency: 600 MHz

Medium parameters used:  $f = 600$  MHz;  $\sigma = 0.91$  S/m;  $\epsilon_r = 55.8$ ;  $\rho = 1000$  kg/m<sup>3</sup>

Phantom section: Flat Section

Measurement Standard: DASY5 (IEEE/IEC/ANSI C63.19-2011)

DASY52 Configuration:

- Probe: ET3DV6 - SN1507; ConvF(6.5, 6.5, 6.5); Calibrated: 31.12.2015;
- Sensor-Surface: 4mm (Mechanical Surface Detection)
- Electronics: DAE4 Sn654; Calibrated: 12.08.2016
- Phantom: ELI v4.0; Type: QDOVA001BB; Serial: TP:1003
- DASY52 52.8.8(1258); SEMCAD X 14.6.10(7372)

**Dipole Calibration for Body Tissue/Pin=250 mW, d=15mm/Zoom Scan (7x7x7)/Cube 0:**

Measurement grid: dx=5mm, dy=5mm, dz=5mm

Reference Value = 44.64 V/m; Power Drift = -0.00 dB

Peak SAR (extrapolated) = 2.58 W/kg

**SAR(1 g) = 1.62 W/kg; SAR(10 g) = 1.07 W/kg**

Maximum value of SAR (measured) = 1.74 W/kg

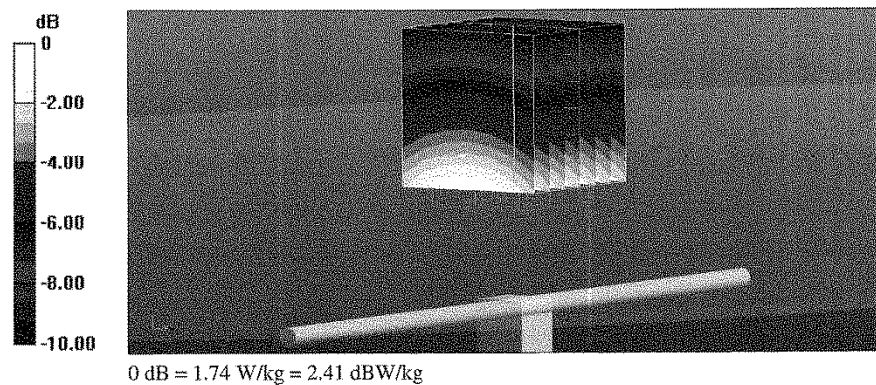

Impedance Measurement Plot for Body TSL

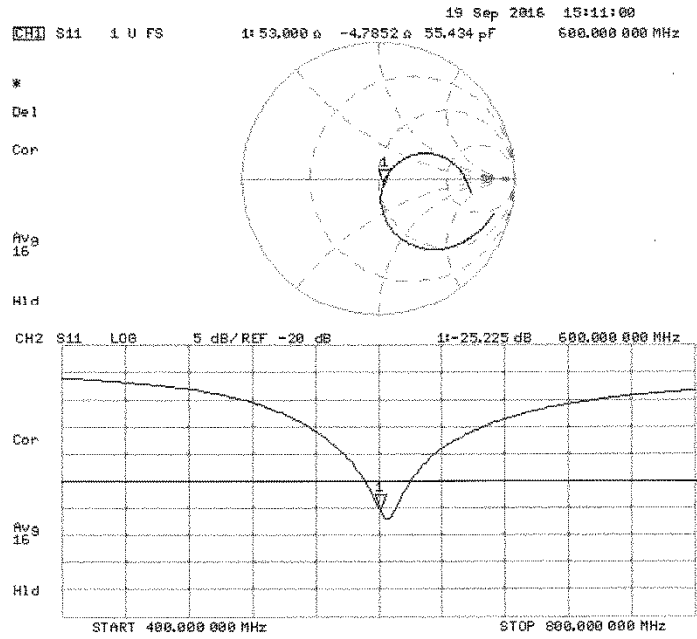

## D600V3 Calibration for Impedance and Return-loss

Equipment	Dipole Antenna	Model	D600V3
Manufacture	Schmid&Partner Engineering AG	Serial	1003
Tested by	Tomohisa Nakagawa		

### 1. Test environment

Date	September13, 2017		
Ambient Temperature	23.0 deg.C	Relative humidity	68%RH
Date	September10, 2018		
Ambient Temperature	24.0 deg.C	Relative humidity	56%RH

### 2. Equipment used

Calibration at September, 2017

Control No.	Instrument	Manufacturer	Model No	Serial No	Test Item	Calibration Date * Interval(month)
MOS-37	Digital thermometer	LKM electronic	DTM3000	-	SAR	2017/07/26 * 12
MPF-03	2mm Oval Flat Phantom	Schmid&Partner Engineering AG	QDOVA001BB	1203	SAR	2017/05/29 * 12
MMSL0650	Tissue simulation liquid (Body)	Schmid&Partner Engineering AG	MSL650	20090914		Pre Check
MHSL0650	Tissue simulation liquid (Head)	Schmid&Partner Engineering AG	HSL650	20090911		Pre Check
EST-63	Network Analyzer	KEYSIGHT	E5071C	MY46523746	SAR	2017/02/03 * 12
EST-64	Calibration Kit	KEYSIGHT	85032F	MY53200995	SAR	2017/02/02 * 12
MDA-21	Dipole Antenna	Schmid&Partner Engineering AG	D600V3	1003	SAR	2016/09/19 * 12

Calibration at September, 2018

Control No.	Instrument	Manufacturer	Model No	Serial No	Test Item	Calibration Date * Interval(month)
MOS-37	Digital thermometer	LKM electronic	DTM3000	-	SAR	2018/07/30 * 12
MPF-03	2mm Oval Flat Phantom	Schmid&Partner Engineering AG	QDOVA001BB	1203	SAR	2018/05/08 * 12
MMSL0650	Tissue simulation liquid (Body)	Schmid&Partner Engineering AG	MSL650	20090914		Pre Check
MHSL0650	Tissue simulation liquid (Head)	Schmid&Partner Engineering AG	HSL650	20090911		Pre Check
EST-63	Network Analyzer	KEYSIGHT	E5071C	MY46523746	SAR	2018/04/30 * 12
EST-64	Calibration Kit	KEYSIGHT	85032F	MY53200995	SAR	2018/04/23 * 12
MDA-21	Dipole Antenna	Schmid&Partner Engineering AG	D600V3	1003	SAR	2016/09/19 * 24

**UL Japan, Inc.**

**Ise EMC Lab.**

4383-326 Asama-cho, Ise-shi, Mie-ken 516-0021 JAPAN

Telephone: +81 596 24 8999

Facsimile: +81 596 24 8124

### 3. Test Result

Impedance,Transformed to feed point	cal day	Head (real part) [Ω]	Head (img part) [jΩ]	Deviation (real part) [Ω]	Deviation (img part) [jΩ]	Tolerance	Result
Calibration (SPEAG)	2016/9/19	60.20	2.30	-	-	-	-
Calibration(ULJ)	2017/9/13	61.12	-1.06	0.92	-3.36	+/-5Ω+/-5jΩ	Complied
Calibration(ULJ)	2018/9/10	59.94	-2.63	-1.18	-1.57	+/-5Ω+/-5jΩ	Complied

Return loss	cal day	Head [dB]	Deviation [dB]	Tolerance [+/-dB]	Result
Calibration (SPEAG)	2016/9/19	-20.50	-	-	-
Calibration(ULJ)	2017/9/13	-22.75	-2.25	4.10	Complied
Calibration(ULJ)	2018/9/10	-24.25	-3.75	4.55	Complied

Impedance,Transformed to feed point	cal day	Body (real part) [Ω]	Body (img part) [jΩ]	Deviation (real part) [Ω]	Deviation (img part) [jΩ]	Tolerance	Result
Calibration (SPEAG)	2016/9/19	53.00	-4.80	-	-	-	-
Calibration(ULJ)	2017/9/13	56.19	-5.78	3.19	-0.98	+/-5Ω+/-5jΩ	Complied
Calibration(ULJ)	2018/9/10	55.05	-5.45	-1.14	0.33	+/-5Ω+/-5jΩ	Complied

Return loss	cal day	Body [dB]	Deviation [dB]	Tolerance [+/-dB]	Result
Calibration (SPEAG)	2016/9/19	-25.20	-	-	-
Calibration(ULJ)	2017/9/13	-22.67	2.54	5.04	Complied
Calibration(ULJ)	2018/9/10	-25.29	-2.63	4.533	Complied

\*Tolerance : According to the KDB865664D01

### Measurement Plots

<Head Liquid> 2017

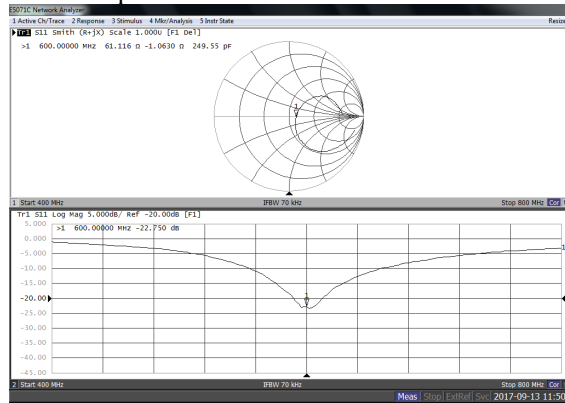

<Head Liquid> 2018

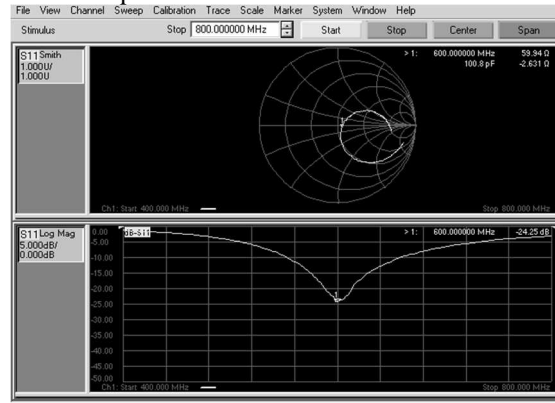

<Body Liquid> 2017

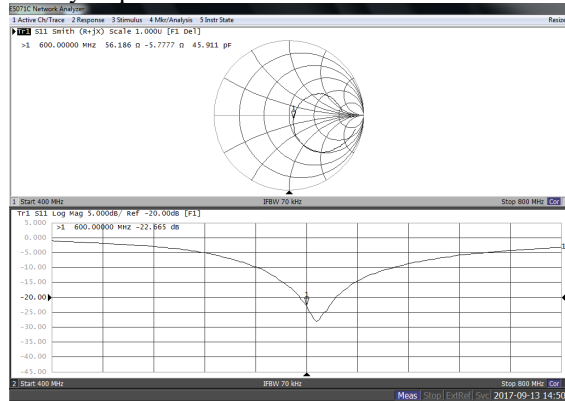

<Body Liquid> 2018

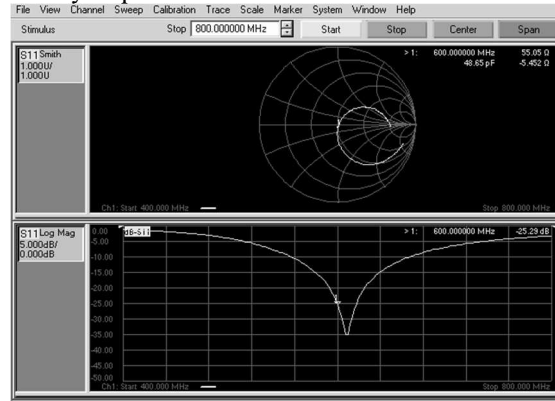

**System Check Dipole SAR Calibration Certificate -Dipole 900MHz (D900V2 S/N: 1d168)**

**Calibration Laboratory of  
 Schmid & Partner  
 Engineering AG**  
 Zeughausstrasse 43, 8004 Zurich, Switzerland



*Checked  
 M. Nage 05/10/2018*

**S** Schweizerischer Kalibrierdienst  
**C** Service suisse d'étalonnage  
**S** Servizio svizzero di taratura  
**S** Swiss Calibration Service

Accredited by the Swiss Accreditation Service (SAS)  
 The Swiss Accreditation Service is one of the signatories to the EA  
 Multilateral Agreement for the recognition of calibration certificates

Accreditation No.: **SCS 0108**

Client **UL RFI UK**

Certificate No: **D900V2-1d168\_Sep18**

CALIBRATION CERTIFICATE			
Object	D900V2 - SN:1d168		
Calibration procedure(s)	QA CAL-05.v10 Calibration procedure for dipole validation kits above 700 MHz		
Calibration date:	September 18, 2018		
This calibration certificate documents the traceability to national standards, which realize the physical units of measurements (SI). The measurements and the uncertainties with confidence probability are given on the following pages and are part of the certificate.			
All calibrations have been conducted in the closed laboratory facility: environment temperature (22 ± 3)°C and humidity < 70%.			
Calibration Equipment used (M&TE critical for calibration)			
<b>Primary Standards</b>	<b>ID #</b>	<b>Cal Date (Certificate No.)</b>	<b>Scheduled Calibration</b>
Power meter NRP	SN: 104778	04-Apr-18 (No. 217-02672/02673)	Apr-19
Power sensor NRP-Z91	SN: 103244	04-Apr-18 (No. 217-02672)	Apr-19
Power sensor NRP-Z91	SN: 103245	04-Apr-18 (No. 217-02673)	Apr-19
Reference 20 dB Attenuator	SN: 5058 (20k)	04-Apr-18 (No. 217-02682)	Apr-19
Type-N mismatch combination	SN: 5047.2 / 06327	04-Apr-18 (No. 217-02683)	Apr-19
Reference Probe EX3DV4	SN: 7349	30-Dec-17 (No. EX3-7349_Dec17)	Dec-18
DAE4	SN: 601	26-Oct-17 (No. DAE4-601_Oct17)	Oct-18
<b>Secondary Standards</b>	<b>ID #</b>	<b>Check Date (in house)</b>	<b>Scheduled Check</b>
Power meter EPM-442A	SN: GB37480704	07-Oct-15 (in house check Oct-16)	In house check: Oct-18
Power sensor HP 8481A	SN: US37292783	07-Oct-15 (in house check Oct-16)	In house check: Oct-18
Power sensor HP 8481A	SN: MY41092317	07-Oct-15 (in house check Oct-16)	In house check: Oct-18
RF generator R&S SMT-06	SN: 100972	15-Jun-15 (in house check Oct-16)	In house check: Oct-18
Network Analyzer Agilent E8358A	SN: US41080477	31-Mar-14 (in house check Oct-17)	In house check: Oct-18
Calibrated by:	Name Jeton Kastrati	Function Laboratory Technician	Signature 
Approved by:	Name Katja Pokovic	Technical Manager	
This calibration certificate shall not be reproduced except in full without written approval of the laboratory.			Issued: September 19, 2018

**Calibration Laboratory of  
Schmid & Partner  
Engineering AG**  
Zeughausstrasse 43, 8004 Zurich, Switzerland



S Schweizerischer Kalibrierdienst  
C Service suisse d'étalonnage  
S Servizio svizzero di taratura  
S Swiss Calibration Service

Accredited by the Swiss Accreditation Service (SAS)  
The Swiss Accreditation Service is one of the signatories to the EA  
Multilateral Agreement for the recognition of calibration certificates

Accreditation No.: SCS 0108

**Glossary:**

TSL tissue simulating liquid  
ConvF sensitivity in TSL / NORM x,y,z  
N/A not applicable or not measured

**Calibration is Performed According to the Following Standards:**

- IEEE Std 1528-2013, "IEEE Recommended Practice for Determining the Peak Spatial-Averaged Specific Absorption Rate (SAR) in the Human Head from Wireless Communications Devices: Measurement Techniques", June 2013
- IEC 62209-1, "Measurement procedure for the assessment of Specific Absorption Rate (SAR) from hand-held and body-mounted devices used next to the ear (frequency range of 300 MHz to 6 GHz)", July 2016
- IEC 62209-2, "Procedure to determine the Specific Absorption Rate (SAR) for wireless communication devices used in close proximity to the human body (frequency range of 30 MHz to 6 GHz)", March 2010
- KDB 865664, "SAR Measurement Requirements for 100 MHz to 6 GHz"

**Additional Documentation:**

- DASY4/5 System Handbook

**Methods Applied and Interpretation of Parameters:**

- Measurement Conditions:** Further details are available from the Validation Report at the end of the certificate. All figures stated in the certificate are valid at the frequency indicated.
- Antenna Parameters with TSL:** The dipole is mounted with the spacer to position its feed point exactly below the center marking of the flat phantom section, with the arms oriented parallel to the body axis.
- Feed Point Impedance and Return Loss:** These parameters are measured with the dipole positioned under the liquid filled phantom. The impedance stated is transformed from the measurement at the SMA connector to the feed point. The Return Loss ensures low reflected power. No uncertainty required.
- Electrical Delay:** One-way delay between the SMA connector and the antenna feed point. No uncertainty required.
- SAR measured:** SAR measured at the stated antenna input power.
- SAR normalized:** SAR as measured, normalized to an input power of 1 W at the antenna connector.
- SAR for nominal TSL parameters:** The measured TSL parameters are used to calculate the nominal SAR result.

The reported uncertainty of measurement is stated as the standard uncertainty of measurement multiplied by the coverage factor  $k=2$ , which for a normal distribution corresponds to a coverage probability of approximately 95%.



### Measurement Conditions

DASY system configuration, as far as not given on page 1.

DASY Version	DASY5	V52.10.1
Extrapolation	Advanced Extrapolation	
Phantom	Modular Flat Phantom	
Distance Dipole Center - TSL	15 mm	with Spacer
Zoom Scan Resolution	dx, dy, dz = 5 mm	
Frequency	900 MHz ± 1 MHz	

### Head TSL parameters

The following parameters and calculations were applied.

	Temperature	Permittivity	Conductivity
Nominal Head TSL parameters	22.0 °C	41.5	0.97 mho/m
Measured Head TSL parameters	(22.0 ± 0.2) °C	40.6 ± 6 %	0.94 mho/m ± 6 %
Head TSL temperature change during test	< 0.5 °C	----	----

### SAR result with Head TSL

SAR averaged over 1 cm <sup>3</sup> (1 g) of Head TSL	Condition	
SAR measured	250 mW input power	2.63 W/kg
SAR for nominal Head TSL parameters	normalized to 1W	10.7 W/kg ± 17.0 % (k=2)

SAR averaged over 10 cm <sup>3</sup> (10 g) of Head TSL	condition	
SAR measured	250 mW input power	1.68 W/kg
SAR for nominal Head TSL parameters	normalized to 1W	6.82 W/kg ± 16.5 % (k=2)

### Body TSL parameters

The following parameters and calculations were applied.

	Temperature	Permittivity	Conductivity
Nominal Body TSL parameters	22.0 °C	55.0	1.05 mho/m
Measured Body TSL parameters	(22.0 ± 0.2) °C	55.3 ± 6 %	1.02 mho/m ± 6 %
Body TSL temperature change during test	< 0.5 °C	----	----

### SAR result with Body TSL

SAR averaged over 1 cm <sup>3</sup> (1 g) of Body TSL	Condition	
SAR measured	250 mW input power	2.68 W/kg
SAR for nominal Body TSL parameters	normalized to 1W	11.0 W/kg ± 17.0 % (k=2)

SAR averaged over 10 cm <sup>3</sup> (10 g) of Body TSL	condition	
SAR measured	250 mW input power	1.74 W/kg
SAR for nominal Body TSL parameters	normalized to 1W	7.09 W/kg ± 16.5 % (k=2)

**Appendix (Additional assessments outside the scope of SCS 0108)**

**Antenna Parameters with Head TSL**

Impedance, transformed to feed point	50.7 $\Omega$ - 1.3 j $\Omega$
Return Loss	- 36.7 dB

**Antenna Parameters with Body TSL**

Impedance, transformed to feed point	45.5 $\Omega$ - 3.1 j $\Omega$
Return Loss	- 24.9 dB

**General Antenna Parameters and Design**

Electrical Delay (one direction)	1.403 ns
----------------------------------	----------

After long term use with 100W radiated power, only a slight warming of the dipole near the feedpoint can be measured.

The dipole is made of standard semirigid coaxial cable. The center conductor of the feeding line is directly connected to the second arm of the dipole. The antenna is therefore short-circuited for DC-signals. On some of the dipoles, small end caps are added to the dipole arms in order to improve matching when loaded according to the position as explained in the "Measurement Conditions" paragraph. The SAR data are not affected by this change. The overall dipole length is still according to the Standard.

No excessive force must be applied to the dipole arms, because they might bend or the soldered connections near the feedpoint may be damaged.

**Additional EUT Data**

Manufactured by	SPEAG
Manufactured on	March 27, 2013

**DASY5 Validation Report for Head TSL**

Date: 18.09.2018

Test Laboratory: SPEAG, Zurich, Switzerland

**DUT: Dipole 900 MHz; Type: D900V2; Serial: D900V2 - SN:1d168**

Communication System: UID 0 - CW; Frequency: 900 MHz

Medium parameters used:  $f = 900$  MHz;  $\sigma = 0.94$  S/m;  $\epsilon_r = 40.6$ ;  $\rho = 1000$  kg/m<sup>3</sup>

Phantom section: Flat Section

Measurement Standard: DASY5 (IEEE/IEC/ANSI C63.19-2011)

DASY52 Configuration:

- Probe: EX3DV4 - SN7349; ConvF(9.71, 9.71, 9.71) @ 900 MHz; Calibrated: 30.12.2017
- Sensor-Surface: 1.4mm (Mechanical Surface Detection)
- Electronics: DAE4 Sn601; Calibrated: 26.10.2017
- Phantom: Flat Phantom 4.9 (front); Type: QD 00L P49 AA; Serial: 1001
- DASY52 52.10.1(1476); SEMCAD X 14.6.11(7439)

**Dipole Calibration for Head Tissue/Pin=250 mW, d=15mm/Zoom Scan (7x7x7)/Cube 0:**

Measurement grid: dx=5mm, dy=5mm, dz=5mm

Reference Value = 65.39 V/m; Power Drift = -0.04 dB

Peak SAR (extrapolated) = 4.05 W/kg

**SAR(1 g) = 2.63 W/kg; SAR(10 g) = 1.68 W/kg**

Maximum value of SAR (measured) = 3.56 W/kg

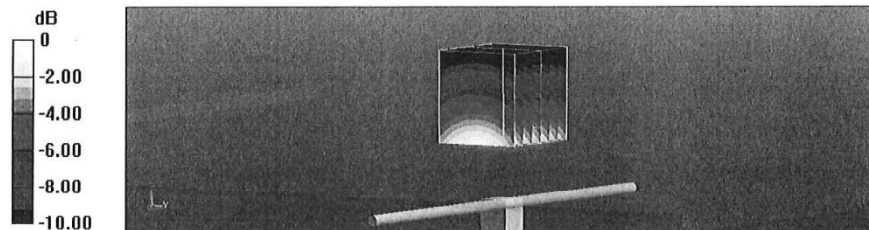

0 dB = 3.56 W/kg = 5.51 dBW/kg

Impedance Measurement Plot for Head TSL

