



RADIO TEST REPORT

Test Report No. : 13554183S-J-R2

Applicant : Sony Corporation, Japan and Sony Group Companies
Type of EUT : CONTROL BOX
Model Number of EUT : TMR-A9WT (Module: 1PJ)
FCC ID : AK8TMRA9WT
Test regulation : FCC Part 15 Subpart E: 2021
(DFS test only)
*Master
Test Result : Complied (Refer to SECTION 3.2)

1. This test report shall not be reproduced in full or partial, without the written approval of UL Japan, Inc.
2. The results in this report apply only to the sample tested.
3. This sample tested is in compliance with the limits of the above regulation.
4. The test results in this test report are traceable to the national or international standards.
5. This test report must not be used by the customer to claim product certification, approval, or endorsement by the A2LA accreditation body.
6. This test report covers Radio technical requirements.
It does not cover administrative issues such as Manual or non-Radio test related Requirements. (if applicable)
7. The all test items in this test report are conducted by UL Japan, Inc. Shonan EMC Lab.
8. The opinions and the interpretations to the result of the description in this report are outside scopes where UL Japan has been accredited.
9. The information provided from the customer for this report is identified in Section 1.
10. This report is a revised version of 13554183S-J-R1. 13554183S-J-R1 is replaced with this report.

Date of test: October 14 to December 21, 2020

Representative test engineer: K. Adachi
Kenichi Adachi
Engineer
Consumer Technology Division

Approved by: T. Imamura
Toyokazu Imamura
Leader
Consumer Technology Division



CERTIFICATE 1266.03

- The testing in which "Non-accreditation" is displayed is outside the accreditation scopes in UL Japan.
 There is no testing item of "Non-accreditation".

UL Japan, Inc.
Shonan EMC Lab.

1-22-3 Megumigaoka, Hiratsuka-shi, Kanagawa-ken, 259-1220 JAPAN
Telephone : +81 463 50 6400
Facsimile : +81 463 50 6401

REVISION HISTORY

Original Test Report No.: 13554183S-J-R2

Revision	Test report No.	Date	Page revised	Contents
- (Original)	13554183S-J	February 22, 2021	-	-
1	13554183S-J-R1	March 2, 2021	5	Addition of remarks: "The DFS Master device for this device is module 1PJ, which is certified by FCC ID: 3VPYLBEE5ZZ1PJ. Therefore, this report uses the data of module 1PJ (FCC ID: 3VPYLBEE5ZZ1PJ). The customer has also consented to the use of the test data from module 1PJ for TMR-A9WT (FCC ID: AK8TMRA9WT)."
			14	Addition of remarks: "* This test has been conducted with a module."
			13	Correction error of reference report and power data: (p.13 (Correction of reference report no. ""2008RSU027-U1 and 1808WSU011-U4" to "134183S-I-R1. Correction of the value of table of power level(EIRP) of the EUT and the value of table of power spectral density level (EIRP).)
2	13554183S-J-R2	March 3, 2021	5	Update of remarks: From "The DFS Master device for this device is module 1PJ, which is certified by FCC ID: 3VPYLBEE5ZZ1PJ. Therefore, this report uses the data of module 1PJ (FCC ID: 3VPYLBEE5ZZ1PJ). The customer has also consented to the use of the test data from module 1PJ for TMR-A9WT (FCC ID: AK8TMRA9WT)." To "The DFS Master device for this device is module 1PJ, which is certified by FCC ID: VPYLBEE5ZZ1PJ. Therefore, this report uses the data of module 1PJ (FCC ID: VPYLBEE5ZZ1PJ). The customers (Sony Corporation, Japan and Sony Group Companies and Murata Manufacturing Co., Ltd.) has also consented to the use of the following test data from module 1PJ for TMR-A9WT (FCC ID: AK8TMRA9WT). Information of 1PJ FCC certification - Applicant: Murata Manufacturing Co., Ltd. - DFS Test Report No.: 13554188S-A-R2 - FCC ID: VPYLBEE5ZZ1PJ"
			13	Update of test report No: From "No.13554188S-A" to "No.13554188S-A-R2"

UL Japan, Inc.

Shonan EMC Lab.

1-22-3 Megumigaoka, Hiratsuka-shi, Kanagawa-ken, 259-1220 JAPAN

Telephone : +81 463 50 6400

Facsimile : +81 463 50 6401

Reference: Abbreviations (Including words undescribed in this report)

A2LA	The American Association for Laboratory Accreditation	MCS	Modulation and Coding Scheme
AC	Alternating Current	MRA	Mutual Recognition Arrangement
AFH	Adaptive Frequency Hopping	N/A	Not Applicable
AM	Amplitude Modulation	NIST	National Institute of Standards and Technology
Amp, AMP	Amplifier	NS	No signal detect.
ANSI	American National Standards Institute	NSA	Normalized Site Attenuation
Ant, ANT	Antenna	NVLAP	National Voluntary Laboratory Accreditation Program
AP	Access Point	OBW	Occupied Band Width
ASK	Amplitude Shift Keying	OFDM	Orthogonal Frequency Division Multiplexing
Atten., ATT	Attenuator	P/M	Power meter
AV	Average	PCB	Printed Circuit Board
BPSK	Binary Phase-Shift Keying	PER	Packet Error Rate
BR	Bluetooth Basic Rate	PHY	Physical Layer
BT	Bluetooth	PK	Peak
BT LE	Bluetooth Low Energy	PN	Pseudo random Noise
BW	BandWidth	PRBS	Pseudo-Random Bit Sequence
Cal Int	Calibration Interval	PSD	Power Spectral Density
CCK	Complementary Code Keying	QAM	Quadrature Amplitude Modulation
Ch., CH	Channel	QP	Quasi-Peak
CISPR	Comite International Special des Perturbations Radioelectriques	QPSK	Quadri-Phase Shift Keying
CW	Continuous Wave	RBW	Resolution Band Width
DBPSK	Differential BPSK	RDS	Radio Data System
DC	Direct Current	RE	Radio Equipment
D-factor	Distance factor	RF	Radio Frequency
DFS	Dynamic Frequency Selection	RMS	Root Mean Square
DQPSK	Differential QPSK	RSS	Radio Standards Specifications
DSSS	Direct Sequence Spread Spectrum	Rx	Receiving
EDR	Enhanced Data Rate	SA, S/A	Spectrum Analyzer
EIRP, e.i.r.p.	Equivalent Isotropically Radiated Power	SG	Signal Generator
EMC	ElectroMagnetic Compatibility	SVSWR	Site-Voltage Standing Wave Ratio
EMI	ElectroMagnetic Interference	TR	Test Receiver
EN	European Norm	Tx	Transmitting
ERP, e.r.p.	Effective Radiated Power	VBW	Video BandWidth
EU	European Union	Vert.	Vertical
EUT	Equipment Under Test	WLAN	Wireless LAN
Fac.	Factor		
FCC	Federal Communications Commission		
FHSS	Frequency Hopping Spread Spectrum		
FM	Frequency Modulation		
Freq.	Frequency		
FSK	Frequency Shift Keying		
GFSK	Gaussian Frequency-Shift Keying		
GNSS	Global Navigation Satellite System		
GPS	Global Positioning System		
Hori.	Horizontal		
ICES	Interference-Causing Equipment Standard		
IEC	International Electrotechnical Commission		
IEEE	Institute of Electrical and Electronics Engineers		
IF	Intermediate Frequency		
ILAC	International Laboratory Accreditation Conference		
ISED	Innovation, Science and Economic Development Canada		
ISO	International Organization for Standardization		
JAB	Japan Accreditation Board		
LAN	Local Area Network		
LIMS	Laboratory Information Management System		

UL Japan, Inc.

Shonan EMC Lab.

1-22-3 Megumigaoka, Hiratsuka-shi, Kanagawa-ken, 259-1220 JAPAN

Telephone : +81 463 50 6400

Facsimile : +81 463 50 6401

CONTENTS	PAGE
SECTION 1: Customer information.....	5
SECTION 2: Equipment under test (EUT).....	5
SECTION 3: Scope of Report.....	8
SECTION 4: Test specification, procedures & results.....	8
SECTION 5: Operation of EUT during testing.....	13
SECTION 6: U-NII Detection Bandwidth.....	21
SECTION 7: Initial Channel Availability Check Time	23
SECTION 8: Radar Burst at the Beginning of the Channel Availability Check Time.....	24
SECTION 9: Radar Burst at the End of the Channel Availability Check Time	26
SECTION 10: Channel Move Time, Channel Closing Transmission Time.....	28
SECTION 11: Non-Occupancy Period.....	30
SECTION 12: In-Service Monitoring (Statistical Performance Check)	32
APPENDIX 1: Data of DFS test.....	34
APPENDIX 2: Test instruments	85
APPENDIX 3: Photographs of test setup	86

UL Japan, Inc.

Shonan EMC Lab.

1-22-3 Megumigaoka, Hiratsuka-shi, Kanagawa-ken, 259-1220 JAPAN

Telephone : +81 463 50 6400

Facsimile : +81 463 50 6401

SECTION 1: Customer information

Company Name : Sony Corporation, Japan and Sony Group Companies
Address : 1-7-1 Konan Minato-ku, Tokyo, 108-0075 Japan
Contact Person : Kazuhiko Nagano

The information provided from the customer is as follows;

- Applicant, Type of EUT, Model Number of EUT, FCC ID on the cover and other relevant pages
 - Operating/Test Mode(s) (Mode(s)) on all the relevant pages
 - SECTION 1: Customer information
 - SECTION 2: Equipment under test (EUT) other than the Receipt Date
 - SECTION 4: Operation of EUT during testing
- * The laboratory is exempted from liability of any test results affected from the above information in SECTION 2 and 4.

SECTION 2: Equipment under test (EUT)

2.1 Identification of EUT

Type : CONTROL BOX
Model Number : TMR-A9WT
Serial Number : Refer to SECTION 4.2
Rating : AC adapter Input: AC 100 V – 240 V, 50/60 Hz
DC 12 V
Receipt Date : October 14, 2020
Country of Mass-production : Malaysia
Condition : Engineering prototype
(Not for Sale: This sample is equivalent to mass-produced items.)
Modification : No Modification by the test lab

2.2 Product Description

Model: TMR-A9WT (referred to as the EUT in this report) is a CONTROL BOX.

The test was performed at the antenna terminal, and since there was no difference between the case where the wireless module was inside the device and the case where the wireless module was taken out of the device, the wireless module was taken out from the device and carried out using a test jig.

The DFS Master device for this device is module 1PJ, which is certified by FCC ID: VPYLBEE5ZZ1PJ.

Therefore, this report uses the data of module 1PJ (FCC ID: VPYLBEE5ZZ1PJ).

The customers (Sony Corporation, Japan and Sony Group Companies and Murata Manufacturing Co., Ltd.) has also consented to the use of the following test data from module 1PJ for TMR-A9WT (FCC ID: AK8TMRA9WT).

Information of 1PJ FCC certification

- Applicant: Murata Manufacturing Co., Ltd.
- DFS Test Report No.: 13554188S-A-R2
- FCC ID: VPYLBEE5ZZ1PJ

Clock frequency of the EUT : 48 MHz (MAX) (Module A: WM-BAC-AT-49)
48 MHz (MAX) (Module B: 1PJ)

UL Japan, Inc.

Shonan EMC Lab.

1-22-3 Megumigaoka, Hiratsuka-shi, Kanagawa-ken, 259-1220 JAPAN

Telephone : +81 463 50 6400

Facsimile : +81 463 50 6401

Radio Specification

<Module A: model No. WM-BAC-AT-49>

	Bluetooth (BR/EDR) *1)	Bluetooth (Low Energy) *1)
Frequency of operation	2402 MHz - 2480 MHz	2402 MHz - 2480 MHz
Channel spacing	1 MHz	2 MHz
Modulation	FHSS: GFSK (* EDR: GFSK+ /4-DQPSK, GFSK+ 8DPSK)	
Antenna type	Dipole antenna	
Antenna Gain	3.54 dBi	
Antenna Connector type	U.FL connector	

*1) The Bluetooth part antenna and the Module B antenna are common antenna.

	IEEE802.11b	IEEE802.11g	IEEE802.11n (20 MHz band)	IEEE802.11n (40 MHz band)
Frequency of operation	2412 MHz - 2462 MHz	2412 MHz - 2462 MHz	2412 MHz - 2462 MHz 5180 MHz - 5240 MHz 5260 MHz - 5320 MHz 5500 MHz - 5720 MHz 5745 MHz - 5825 MHz	5190 MHz - 5230 MHz 5270 MHz - 5310 MHz 5510 MHz - 5710 MHz 5755 MHz - 5795 MHz
Channel spacing	5 MHz		2.4 GHz band 5 MHz 5 GHz band 20 MHz	5 GHz band 40 MHz
Modulation	DSSS: DBPSK, DQPSK, CCK		OFDM: BPSK, QPSK, 16QAM, 64QAM	
	IEEE802.11a	IEEE802.11ac (20 MHz band)	IEEE802.11ac (40 MHz band)	IEEE802.11ac (80 MHz band)
Frequency of operation	5180 MHz - 5240 MHz 5260 MHz - 5320 MHz 5500 MHz - 5720 MHz 5745 MHz - 5825 MHz	5180 MHz - 5240 MHz 5260 MHz - 5320 MHz 5500 MHz - 5720 MHz 5745 MHz - 5825 MHz	5190 MHz - 5230 MHz 5270 MHz - 5310 MHz 5510 MHz - 5710 MHz 5755 MHz - 5795 MHz	5210 MHz 5290 MHz 5530 MHz - 5610 MHz 5690 MHz 5775 MHz
Channel spacing	20 MHz		40 MHz	80 MHz
Modulation	OFDM BPSK, QPSK, 16QAM, 64QAM, 256QAM (*256QAM is only for IEEE802.11ac 80 MHz band)			
Antenna type	Dipole antenna			
Antenna Gain	ANT0 : 1.36 dBi (2.4 GHz), 3.71 dBi (U-NII-1), 2.60 dBi (U-NII-2A), 2.48 dBi (U-NII-2C), 3.09 dBi (U-NII-3) ANT1 : 1.90 dBi (2.4 GHz), 5.79 dBi (U-NII-1), 5.79 dBi (U-NII-2A), 5.12 dBi (U-NII-2C), 4.13 dBi (U-NII-3)			
Antenna Connector type	U.FL connector			

<Module B: Model No. 1PJ> (* The module covered by this report.)

	IEEE802.11a	IEEE802.11n (20 MHz band)	IEEE802.11n (40 MHz band)
Frequency of operation	5180 MHz - 5240 MHz 5260 MHz - 5320 MHz 5500 MHz - 5700 MHz 5745 MHz - 5825 MHz	5180 MHz - 5240 MHz 5260 MHz - 5320 MHz 5500 MHz - 5700 MHz 5745 MHz - 5825 MHz	5190 MHz - 5230 MHz 5270 MHz - 5310 MHz 5510 MHz - 5670 MHz 5755 MHz - 5795 MHz
Channel spacing	20 MHz	20 MHz	40 MHz
Modulation	DSSS: DBPSK, DQPSK, CCK	OFDM: BPSK, QPSK, 16QAM, 64QAM	
Antenna type	Dipole antenna		
Antenna Gain	ANT : 4.64 dBi (U-NII-1), 4.48 dBi (U-NII-2A), 4.76 dBi (U-NII-2C), 4.76 dBi (U-NII-3)		
Antenna Connector type	U.FL connector		

Additional information for specification:

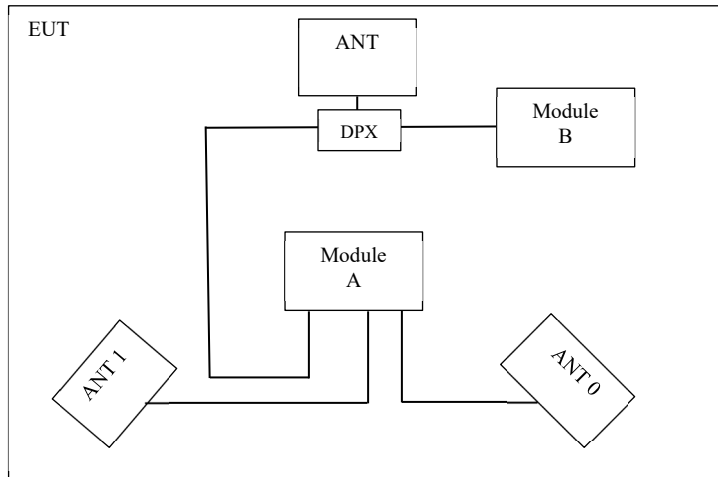

The EUT has module A and module B.

* DPX: Diplexer.

Combination of antennas used

	BT	BT LE	WLAN 2.4 GHz	WLAN 5 GHz
ANT	module A	module A	-	module B
ANT 0	-	-	module A	module A
ANT 1	-	-	module A	module A

UL Japan, Inc.

Shonan EMC Lab.

1-22-3 Megumigaoka, Hiratsuka-shi, Kanagawa-ken, 259-1220 JAPAN

Telephone : +81 463 50 6400

Facsimile : +81 463 50 6401

SECTION 3: Scope of Report

This report only covers DFS requirement, as specified by the following referenced procedures.

SECTION 4: Test specification, procedures & results

4.1 Test Specification

Test Specification	:	FCC Part 15 Subpart E FCC Part 15 final revised on January 12, 2021 and effective February 11, 2021 * The revision does not affect the test result conducted before its effective date.
Title	:	FCC 47CFR Part15 Radio Frequency Device Subpart E Unlicensed National Information Infrastructure Devices Section 15.407 General technical requirements
Test Specification	:	KDB905462 D02 UNII DFS Compliance Procedures New Rules v02
Title	:	COMPLIANCE MEASUREMENT PROCEDURES FOR UNLICENSED- NATIONAL INFORMATION INFRASTRUCTURE DEVICES OPERATING IN THE 5250-5350MHz AND 5470-5725MHz BANDS INCORPORATING DYNAMIC FREQUENCY SELECTION

FCC Part 15.31 (e)

This EUT provides stable voltage constantly to RF Module regardless of input voltage. Therefore, this EUT complies with the requirement.

FCC Part 15.203 Antenna requirement

It is impossible for end users to replace the antenna, because the antenna is mounted inside of the EUT. Therefore, the equipment complies with the antenna requirement of Section 15.203.

4.2 Procedures and results

Table 1: Applicability of DFS Requirements

<Master mode>

Requirement	Operating Mode	Test Procedures & Limits	Deviation	Results
	Master			
U-NII Detection Bandwidth	Yes	KDB905462 D02 UNII DFS Compliance Procedures New Rules v02	N/A	Complied a)
Initial Channel Availability Check Time	Yes	FCC15.407 (h)	N/A	Complied b)
		KDB905462 D02 UNII DFS Compliance Procedures New Rules v02		
		RSS-247 6.3		
Radar Burst at the Beginning of the Channel Availability Check Time	Yes	FCC15.407 (h)	N/A	Complied c)
		KDB905462 D02 UNII DFS Compliance Procedures New Rules v02		
		RSS-247 6.3		
Radar Burst at the End of the Channel Availability Check Time	Yes	FCC15.407 (h)	N/A	Complied d)
		KDB905462 D02 UNII DFS Compliance Procedures New Rules v02		
		RSS-247 6.3		
In-Service Monitoring for Channel Move Time, Channel Closing Transmission Time	Yes	FCC15.407 (h)	N/A	Complied e)
		KDB905462 D02 UNII DFS Compliance Procedures New Rules v02		
		RSS-247 6.3		
In-Service Monitoring for Non-Occupancy period	Yes	FCC15.407 (h)	N/A	Complied f)
		KDB905462 D02 UNII DFS Compliance Procedures New Rules v02		
		RSS-247 6.3		
Statistical Performance Check	Yes	FCC15.407 (h)	N/A	Complied g)
		KDB905462 D02 UNII DFS Compliance Procedures New Rules v02		
<p>Note: UL Japan, Inc.'s EMI Work Procedures No. 13-EM-W0422.</p> <p>a) Refer to SECTION 6, clause 6.3 b) Refer to SECTION 7, clause 7.3 c) Refer to SECTION 8, clause 8.3 d) Refer to SECTION 9, clause 9.3 e) Refer to SECTION 10, clause 10.3 f) Refer to SECTION 11, clause 11.3 g) Refer to SECTION 12, clause 12.3</p> <p>Symbols: Complied The data of this test item has enough margin, more than the measurement uncertainty. Complied# The data of this test item meets the limits unless the measurement uncertainty is taken into consideration.</p>				

UL Japan, Inc.

Shonan EMC Lab.

1-22-3 Megumigaoka, Hiratsuka-shi, Kanagawa-ken, 259-1220 JAPAN

Telephone : +81 463 50 6400

Facsimile : +81 463 50 6401

Table 2 DFS Detection Thresholds for Master Devices and Client Devices With Radar Detection

Maximum Transmit Power	Value (See Notes 1,2, and 3)
≥ 200 milliwatt	-64 dBm
< 200 milliwatt and power spectral density < 10 dBm/MHz	-62 dBm
< 200 milliwatt that do not meet the power spectral density requirement	-64 dBm
<p>Note 1: This is the level at the input of the receiver assuming a 0 dBi receive antenna.</p> <p>Note 2: Throughout these test procedures an additional 1 dB has been added to the amplitude of the test transmission waveforms to account for variations in measurement equipment. This will ensure that the test signal is at or above the detection threshold level to trigger a DFS response.</p> <p>Note 3: EIRP is based on the highest antenna gain. For MIMO devices refer to KDB Publication 662911 D01.</p>	

Table 3 DFS Response Requirement Values

Parameter	Value
Non-occupancy period	Minimum 30 minutes
Channel Availability Check Time	60 seconds
Channel Move Time	10 seconds See Note 1
Channel Closing Transmission Time	200 milliseconds + an aggregate of 60 milliseconds over remaining 10 second period. See Notes 1 and 2
U-NII Detection Bandwidth	Minimum 100 % of the U-NII 99 % transmission power bandwidth See Note 3
<p>Note 1: Channel Move Time and the Channel Closing Transmission Time should be performed with Radar Type 0. The measurement timing begins at the end of the Radar Type 0 burst.</p> <p>Note 2: The Channel Closing Transmission Time is comprised of 200 milliseconds starting at the beginning of the Channel Move Time plus any additional intermittent control signals required to facilitate a Channel move (an aggregate of 60 milliseconds) during the remainder of the 10 second period. The aggregate duration of control signal will not count quiet periods in between transmissions.</p> <p>Note 3: During the U-NII Detection Bandwidth detection test, radar type 0 should be used. For each frequency step the minimum percentage of detection is 90 percent. Measurements are performed with no data traffic.</p>	

Table 4 Short Pulse Radar Test Waveform

Radar Type	Pulse Width (μs)	PRI (μs)	Number of Pulses	Minimum Percentage of Successful Detection	Minimum Number of Trials
0	1	1428	18	See Note 1	See Note 1
1	1	Test A: 15 unique PRI values randomly selected from the list of 23 PRI values in Table 5a	Roundup $\{(1/360)^* (19*10^6/PRI_{us})\}$	60 %	30
		Test B: 15 unique PRI values randomly selected within the range of 518-3066 μs, with a minimum increment of 1 μs, excluding PRI values selected in Test A			
2	1-5	150-230	23-29	60 %	30
3	6-10	200-500	16-18	60 %	30
4	11-20	200-500	12-16	60 %	30
Aggregate (Rader Types 1-4)				80 %	120
Note 1: Short Pulse Radar Type 0 should be used for the detection bandwidth test, channel move time, and channel closing time tests.					

Table 5 Long Pulse Radar Test Waveform

Radar Type	Pulse Width (μs)	Chip Width (MHz)	PRI (μs)	Number of Pulses per Burst	Number of Burst	Minimum Percentage of Successful Detection	Minimum Number of Trials
5	50-100	5 - 20	1000-2000	1-3	8-20	80 %	30

Table 6 Frequency Hopping Radar Test Waveform

Radar Type	Pulse Width (μs)	PRI (μs)	Pulse per Hop (kHz)	Hopping Rate (kHz)	Hopping Sequence Length (ms)	Minimum Percentage of Successful Detection	Minimum Number of Trials
6	1	333	9	0.333	300	70 %	30

4.3 Addition to standard

No addition, exclusion nor deviation has been made from the standard.

UL Japan, Inc.

Shonan EMC Lab.

1-22-3 Megumigaoka, Hiratsuka-shi, Kanagawa-ken, 259-1220 JAPAN

Telephone : +81 463 50 6400

Facsimile : +81 463 50 6401

4.4 Test Location

UL Japan, Inc. Shonan EMC Lab.

1-22-3, Megumigaoka, Hiratsuka-shi, Kanagawa-ken 259-1220 JAPAN

Telephone: +81 463 50 6400, Facsimile: +81 463 50 6401

A2LA Certificate Number: 1266.03

(FCC test firm registration number: 626366, ISED lab company number: 2973D / CAB identifier: JP0001)

Test site	IC Registration Number	Width x Depth x Height (m)	Size of reference ground plane (m) / horizontal conducting plane	Maximum measurement distance
No.1 Semi-anechoic chamber	2973D-1	20.6 x 11.3 x 7.65	20.6 x 11.3	10 m
No.2 Semi-anechoic chamber	2973D-2	20.6 x 11.3 x 7.65	20.6 x 11.3	10 m
No.3 Semi-anechoic chamber	2973D-3	12.7 x 7.7 x 5.35	12.7 x 7.7	5 m
No.4 Semi-anechoic chamber	-	8.1 x 5.1 x 3.55	8.1 x 5.1	-
No.1 Shielded room	-	6.8 x 4.1 x 2.7	6.8 x 4.1	-
No.2 Shielded room	-	6.8 x 4.1 x 2.7	6.8 x 4.1	-
No.3 Shielded room	-	6.3 x 4.7 x 2.7	6.3 x 4.7	-
No.4 Shielded room	-	4.4 x 4.7 x 2.7	4.4 x 4.7	-
No.5 Shielded room	-	7.8 x 6.4 x 2.7	7.8 x 6.4	-
No.6 Shielded room	-	7.8 x 6.4 x 2.7	7.8 x 6.4	-
No.8 Shielded room	-	3.45 x 5.5 x 2.4	3.45 x 5.5	-
No.1 Measurement room	-	2.55 x 4.1 x 2.5	-	-

4.5 Uncertainty

The following uncertainties have been calculated to provide a confidence level of 95 % using a coverage factor $k = 2$.

Antenna terminal test	Uncertainty (+/-)
Spurious emission (Conducted) 3 GHz-18 GHz	2.9 dB
Bandwidth Measurement	0.07 %
Time Measurement	0.012 %

4.6 Test instruments of DFS and Test set up

Refer to APPENDIX.

SECTION 5: Operation of EUT during testing

5.1 Operating Modes

The EUT, which is a Master, operates over the W53 and W56 Band.

The highest power level is 16.12 dBm EIRP. (antenna gain: 4.76 dBi)

Power level(EIRP) of the EUT[dBm]		Power level(conducted) of the EUT[dBm]	
Output Power (Max)		Output Power (Max)	
20 MHz band	40 MHz band	20 MHz band	40 MHz band
16.12	15.80	11.36	11.04

The highest power spectral density level is 5.24 dBm EIRP.

Power spectral density level (EIRP)[dBm/MHz]		Power spectral density level (conducted)[dBm/MHz]	
Power spectral density level (Max)		Power spectral density level (Max)	
20 MHz band	40 MHz band	20 MHz band	40 MHz band
5.24	2.38	0.48	-2.38

*Power level(conducted) and power spectral density level(conducted) are refer to test report 13554183S-I-R1, FCC Part 15E (FCC 15.407) report for other parts than DFS.

The channel-loading of approximately 17 % or greater was used for testing, and its test data was transferred from the Master Device to the Client Device for all test configurations.

WLAN traffic is generated by LBEE5ZZ1PJ1 DFS Test Tool, from the Master to the Client in data packets.

The EUT utilizes the 802.11a/n architecture, with a 20 MHz and 40 MHz channel bandwidth.

The lowest antenna assembly gain of all available antenna assemblies is 4.48 dBi.

(In case of Master mode)

The rated output power of the Master unit is < 200 mW (23 dBm) and power spectral density is < 10 dBm. Therefore the required interference threshold level is -62 dBm. After correction for antenna gain and procedural adjustments, the required conducted threshold at the antenna port is $-62 + 1 + (4.48) = -56.52$ dBm (threshold level + additional 1 dB + antenna gain).

This test report was conducted as antenna gain of -5.03 dBi, since data of the test report (No.13554188S-A-R2) is diverted. $(-62 + 1 + (-5.03) = -66.03$ dBm)

It is more stringent than actual antenna gain of the EUT.

It is impossible for users to change DFS control, because the DFS function is written on the firmware and users cannot access it.

The EUT was set by the software as follows:

Software name & version: LBEE5ZZ1PJ1 DFS Test Tool v1.2 (for except Statistical performance check test)

Software name & version: LBEE5ZZ1PJ1 DFS Test Tool v1.3 (for Statistical performance check test)

UL Japan, Inc.

Shonan EMC Lab.

1-22-3 Megumigaoka, Hiratsuka-shi, Kanagawa-ken, 259-1220 JAPAN

Telephone : +81 463 50 6400

Facsimile : +81 463 50 6401

5.2 Configuration and peripherals

<Master mode>

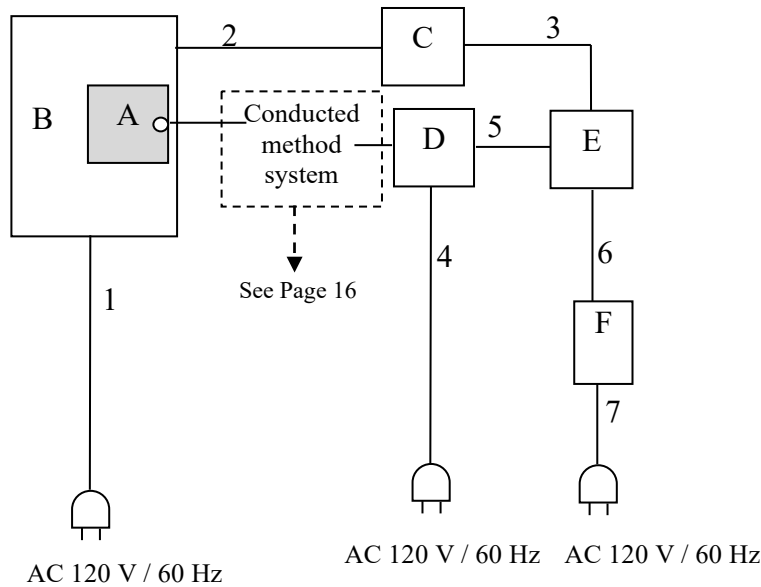

* This test has been conducted with a module.

Description of EUT and Support equipment

No.	Item	Model number	Serial number	Manufacturer	Remarks
A	WLAN+ Bluetooth combo module	1PJ	049 *1) 048 *2)	Murata Manufacturing Co., Ltd.	EUT
B	Jig Board	-	049 *1) 048 *2)	Sony Corporation	-
C	Jig Board (serial I/F)	-	-	Sony Corporation	-
D	Speaker	-	255	Sony Corporation	-
E	Laptop Computer	dynabook Satellite B453 M	ZE127581H	TOSHIBA	-
F	AC Adapter	PA3917U-1ACA	G71C000DP410	TOSHIBA	-

*1) Used for except Statistical performance check test.

*2) Used for Statistical performance check test.

List of cables used

No.	Cable name	Length (m)	Shield		Remarks
			Cable	Connector	
1	AC cable	1.8	Unshielded	Unshielded	-
2	Signal cable	0.2	Unshielded	Unshielded	-
3	USB cable	2.0	Shielded	Shielded	-
4	AC cable	1.8	Unshielded	Unshielded	-
5	Serial to USB cable	1.8	Shielded	Shielded	-
6	DC cable	1.7	Unshielded	Unshielded	-
7	AC cable	0.8	Unshielded	Unshielded	-

UL Japan, Inc.
Shonan EMC Lab.

1-22-3 Megumigaoka, Hiratsuka-shi, Kanagawa-ken, 259-1220 JAPAN
Telephone : +81 463 50 6400
Facsimile : +81 463 50 6401

5.3 Test and Measurement System

SYSTEM OVERVIEW

The measurement system is based on a conducted test method.

The software selects waveform parameters from within the bounds of the signal type on a random basis using uniform distribution. The short pulse types 1, 2, 3, and 4, the long pulse type 5, and the frequency hopping type 6 parameters are randomized at run-time.

The signal monitoring equipment consists of a spectrum analyzer with the capacity to display 8001 bins on the horizontal axis. A time-domain resolution of 2 ms/bin is achievable with a 16 second sweep time, meeting the 10 seconds short pulse reporting criteria. The aggregate ON time is calculated by multiplying the number of bins above a threshold during a particular observation period by the dwell time per bin, with the analyzer set to peak detection.

FREQUENCY HOPPING RADAR WAVEFORM GENERATING SUBSYSTEM

The first 100 frequencies are selected out of the hopping sequence of the randomized 475 hop frequencies.

Only a *Burst* that has the frequency falling within the receiver bandwidth of the tested U-NII device is selected among those frequencies. (Frequency-domain simulation). The radar waveform generated at the start time of the selected *Burst* (Time-domain simulation) is download to the Signal Generator.

If all of the randomly selected 100 frequencies do not fall within the receiver bandwidth of the U-NII device, the radar waveform is not used for the test.

CONDUCTED METHODS SYSTEM BLOCK DIAGRAM

<Master mode>

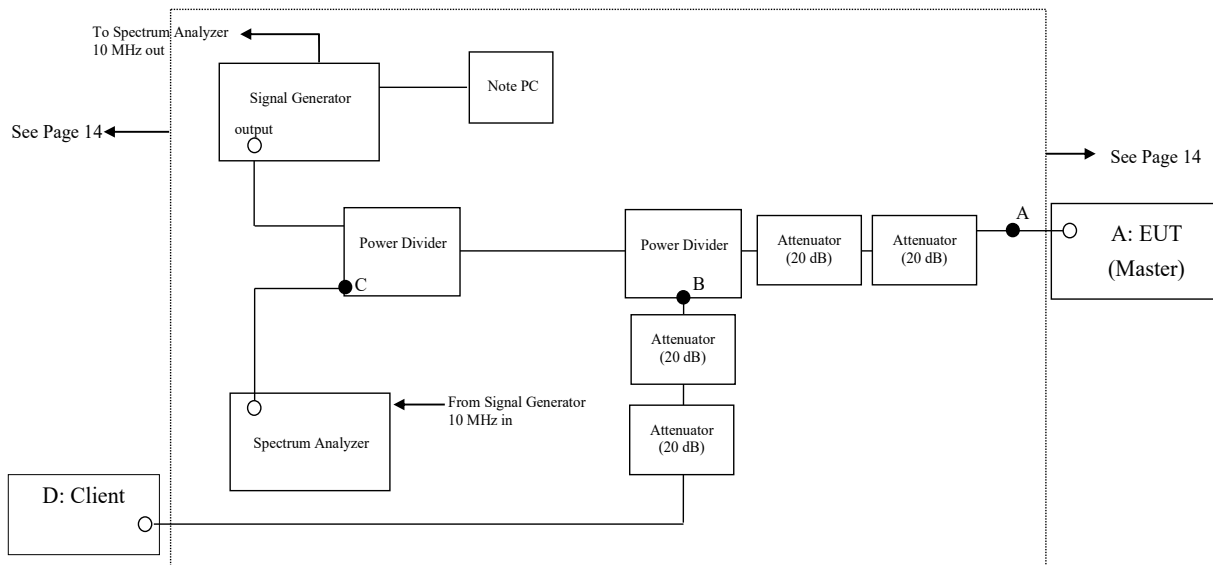

MEASUREMENT SYSTEM FREQUENCY REFERENCE

Lock the signal generator and the spectrum analyzer to the same reference sources as follows: Connect the 10 MHz OUT on the signal generator to the EXT REF IN on the spectrum analyzer and set the spectrum analyzer Ext to On.

UL Japan, Inc.

Shonan EMC Lab.

1-22-3 Megumigaoka, Hiratsuka-shi, Kanagawa-ken, 259-1220 JAPAN

Telephone : +81 463 50 6400

Facsimile : +81 463 50 6401

SYSTEM CALIBRATION

<Master mode>

Step 1: Set the system as shown in Figure 2 of KDB905462 D02 clause 7.2.1.

Step 2: Adjust each attenuator to fulfill the following three conditions:

- WLAN can be communicated, and
- Rader detection threshold level is bigger than Client Device traffic level on the spectrum analyzer, and
- Client Device traffic level is not displayed on the spectrum analyzer.

Step 3: Terminate 50 ohm at B and C points, and connect the spectrum analyzer to the point A. (See the figure of CONDUCTED METHODS SYSTEM BLOCK DIAGRM on Section 5, Clause 3)

At the point A, adjust the signal generator and spectrum analyzer to the center frequency of the channel to be measured.

Download the applicable radar waveforms to the signal generator. Select the radar waveform, trigger a burst manually and measure the amplitude on the spectrum analyzer. Readjust the amplitude of the signal generator as required so that the peak level of the waveform is at a displayed level equal to the required or desired interference detection threshold.

Separate signal generator amplitude settings are determined as required for each radar type.

Step 3: Terminate 50 ohm at B and C points, and connect the spectrum analyzer to the point A. (See the figure of CONDUCTED METHODS SYSTEM BLOCK DIAGRM on Section 5, Clause 3)

At the point A, adjust the signal generator and spectrum analyzer to the center frequency of the channel to be measured.

Download the applicable radar waveforms to the signal generator. Select the radar waveform, trigger a burst manually and measure the amplitude on the spectrum analyzer. Readjust the amplitude of the signal generator as required so that the peak level of the waveform is at a displayed level equal to the required or desired interference detection threshold.

Separate signal generator amplitude settings are determined as required for each radar type.

Step 4: Without changing any of the instrument settings, restore the system setting to Step 2 and adjust the Reference Level Offset of the spectrum analyzer to the level at Step 3.

By taking the above steps 1 to 4, the spectrum analyzer displays the level of the signal generator as received at the antenna ports of the Master Device.

See Clause 5.4 for Plots of Noise, Rader Waveforms, and WLAN signals.

5.4 Plots of Noise, Rader Waveforms, and WLAN signals

<Master mode>

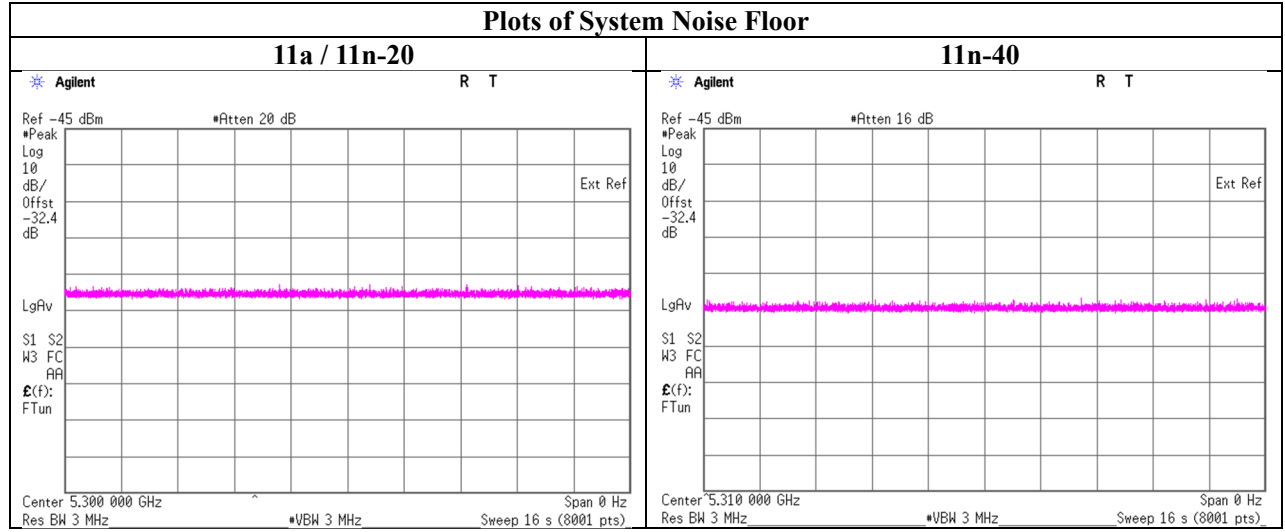

UL Japan, Inc.

Shonan EMC Lab.

1-22-3 Megumigaoka, Hiratsuka-shi, Kanagawa-ken, 259-1220 JAPAN

Telephone : +81 463 50 6400

Facsimile : +81 463 50 6401

Plots of Radar Waveforms

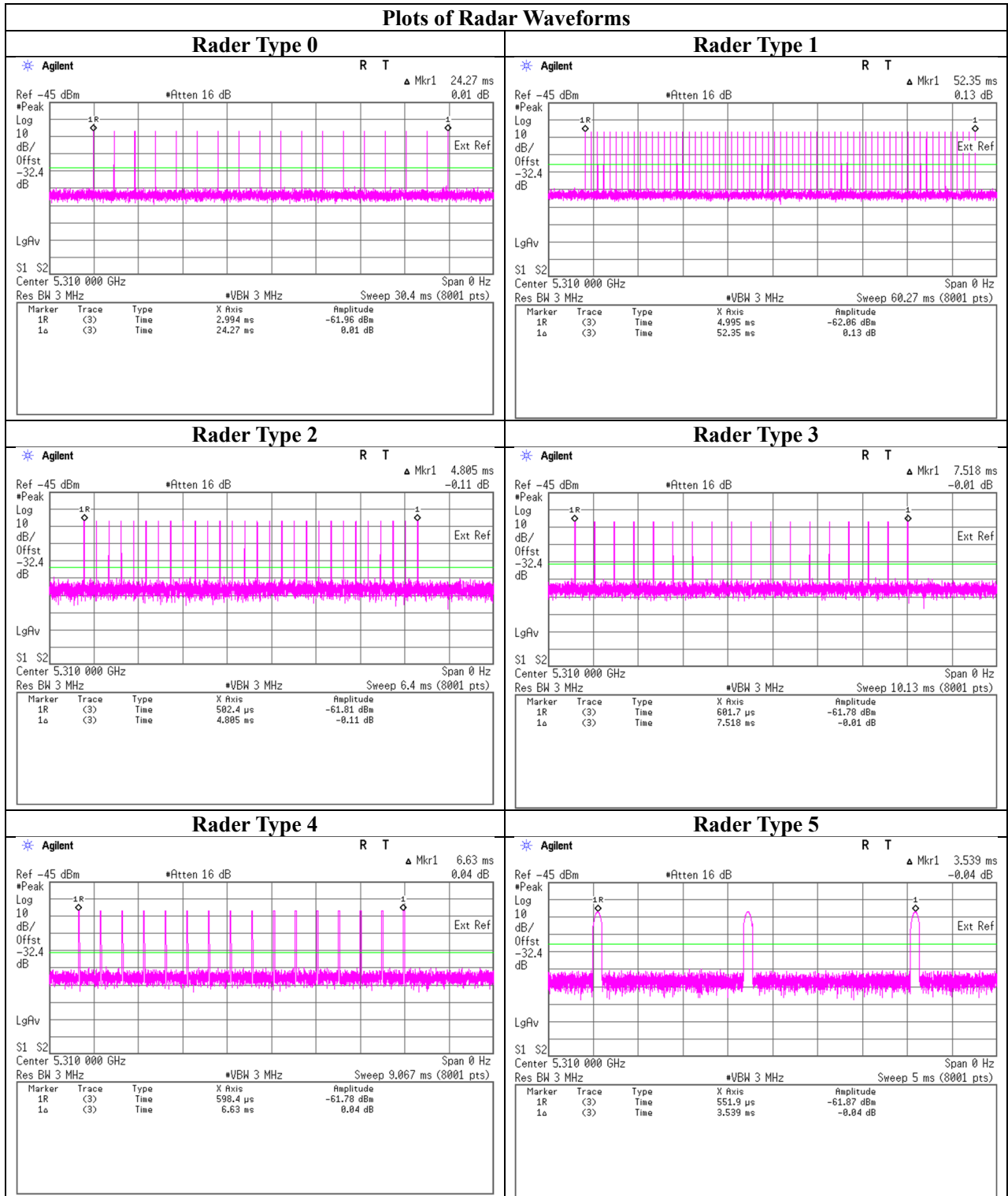

UL Japan, Inc.

Shonan EMC Lab.

1-22-3 Megumigaoka, Hiratsuka-shi, Kanagawa-ken, 259-1220 JAPAN

Telephone : +81 463 50 6400

Facsimile : +81 463 50 6401

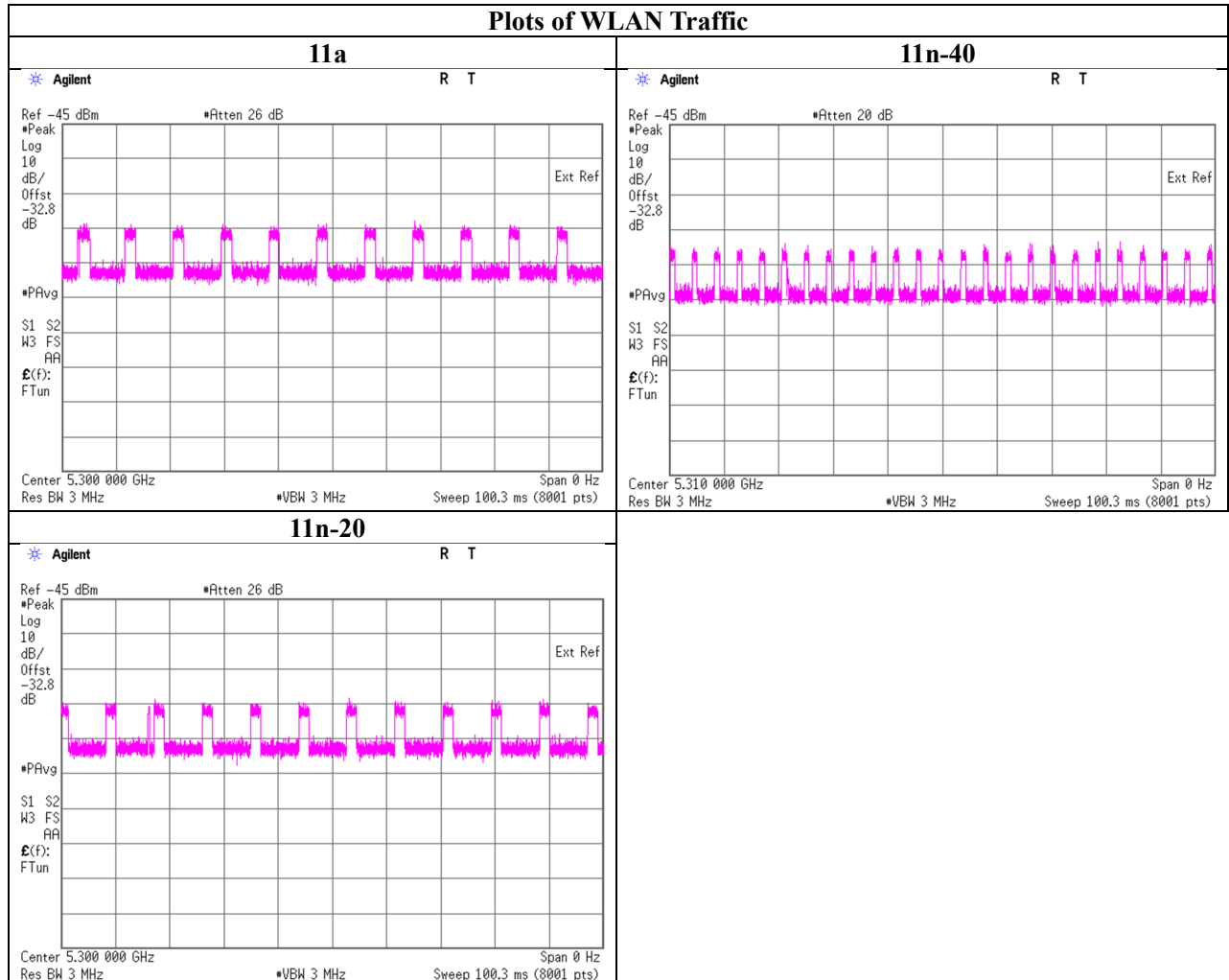
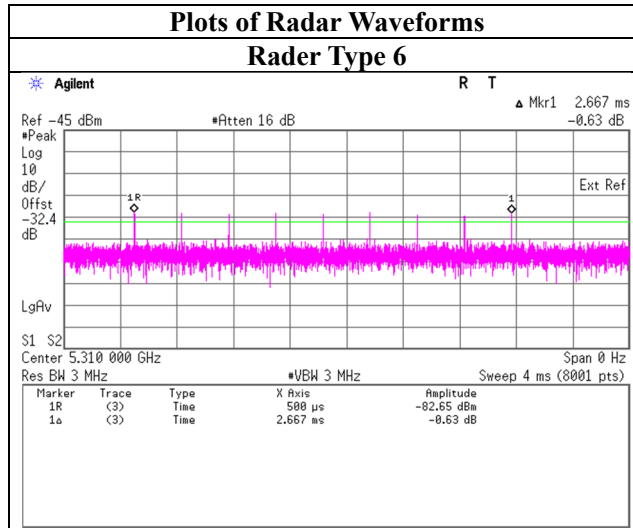

SECTION 6: U-NII Detection Bandwidth

6.1 Operating environment

Test place	Shonan EMC Lab.No.5 Shielded Room
Date	October 15, 2020
Temperature/ Humidity	23 deg. C / 57 % RH
Engineer	Kenichi Adachi
Mode	11a / 11n-20 / 11n-40

6.2 Test Procedure

Adjust the equipment to produce a single Burst of the Short Pulse Radar Type 0 at the center frequency of the EUT Operating Channel at the specified DFS Detection Threshold level. Set the EUT up as a standalone device (no associated Client or Master, as appropriate) and no traffic. Frame based systems will be set to a talk/listen ratio reflecting the worst case (maximum) that is user configurable during this test.

Generate a single radar Burst, and note the response of the EUT. Repeat for a minimum of 10 trials. The EUT must detect the Radar Waveform within the DFS band using the specified U-NII Detection Bandwidth criterion. In cases where the channel bandwidth may exceed past the DFS band edge on specific channels (i.e., 802.11ac or wideband frame based systems) select a channel that has the entire emission bandwidth within the DFS band. If this is not possible, test the detection BW to the DFS band edge.

Starting at the center frequency of the EUT operating Channel, increase the radar frequency in 5 MHz steps, repeating the above test sequence, until the detection rate falls below the U-NII Detection Bandwidth criterion. Repeat this measurement in 1 MHz steps at frequencies 5 MHz below where the detection rate begins to fall. Record the highest frequency (denote as FH) at which detection is greater than or equal to the U-NII Detection Bandwidth criterion. Recording the detection rate at frequencies above FH is not required to demonstrate compliance.

Starting at the center frequency of the EUT operating Channel, decrease the radar frequency in 5 MHz steps, repeating the above test sequence, until the detection rate falls below the U-NII Detection Bandwidth criterion. Repeat this measurement in 1 MHz steps at frequencies 5 MHz above where the detection rate begins to fall. Record the lowest frequency (denote as FL) at which detection is greater than or equal to the U-NII Detection Bandwidth criterion. Recording the detection rate at frequencies below FL is not required to demonstrate compliance.

The U-NII Detection Bandwidth is calculated as follows:

$$\text{U-NII Detection Bandwidth} = \text{FH} - \text{FL}$$

Radar detection is observed by two techniques.

- a). Monitoring LAN traffic with Spectrum Analyzer.
- b). Indicator of EUT and PC connected to EUT

6.3 Test data

5300MHz (11a)

Waveform: Radar Type 0

FL [MHz]	FH [MHz]	Detection Bandwidth [MHz]	99 % Power Bandwidth [MHz]	Ratio of Detection BW to 99 % Power BW [%]	Limit [%]	Results
5290	5310	20	16.3920	122.0	100	Pass

5300MHz (11n-20) (reference data)

Waveform: Radar Type 0

FL [MHz]	FH [MHz]	Detection Bandwidth [MHz]	99 % Power Bandwidth [MHz]	Ratio of Detection BW to 99 % Power BW [%]	Limit [%]	Results
5290	5310	20	17.4529	114.6	100	Pass

5310MHz (11n-40)

Waveform: Radar Type 0

FL [MHz]	FH [MHz]	Detection Bandwidth [MHz]	99 % Power Bandwidth [MHz]	Ratio of Detection BW to 99 % Power BW [%]	Limit [%]	Results
5291	5329	38	36.2626	104.8	100	Pass

99 % Occupied Bandwidth

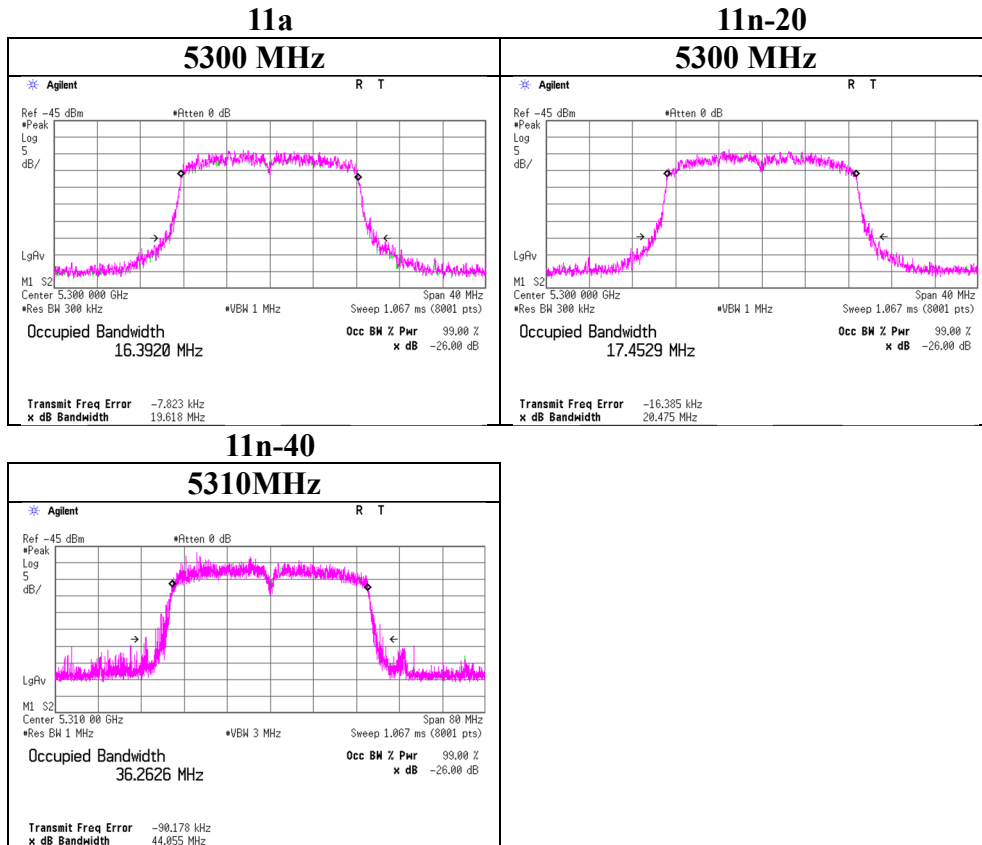

6.4 Test result

Test result: Pass

UL Japan, Inc.

Shonan EMC Lab.

1-22-3 Megumigaoka, Hiratsuka-shi, Kanagawa-ken, 259-1220 JAPAN

Telephone : +81 463 50 6400

Facsimile : +81 463 50 6401

SECTION 7: Initial Channel Availability Check Time

7.1 Operating environment

Test place : Shonan EMC Lab.No.5 Shielded Room
Date : October 15, 2020
Temperature/ Humidity : 23 deg. C / 57 % RH
Engineer : Kenichi Adachi
Mode : 11n-20 * / 11n-40 (* It tested with IEEE802.11n-20, since it cannot boot in IEEE802.11a mode.)

7.2 Test Procedure

The Initial Channel Availability Check Time tests that the EUT does not emit beacon, control, or data signals on the test Channel until the power-up sequence has been completed and the U-NII device checks for Radar Waveforms for one minute on the test Channel.

This test does not use any Radar Waveforms and only needs to be performed one time.

The U-NII devices will be powered on and be instructed to operate on the appropriate U-NII Channel that must incorporate DFS functions. At the same time the EUT is powered on, the spectrum analyzer will be set to zero span mode with a 3 MHz RBW and 3 MHz VBW on the Channel occupied by the radar (Chr) with a 2.5 minutes sweep time.

The spectrum analyzer's sweep will be started at the same time power is applied to the U-NII device.

The EUT should not transmit any beacon or data transmissions until at least 1 minute after the completion of the power-on cycle.

7.3 Test data

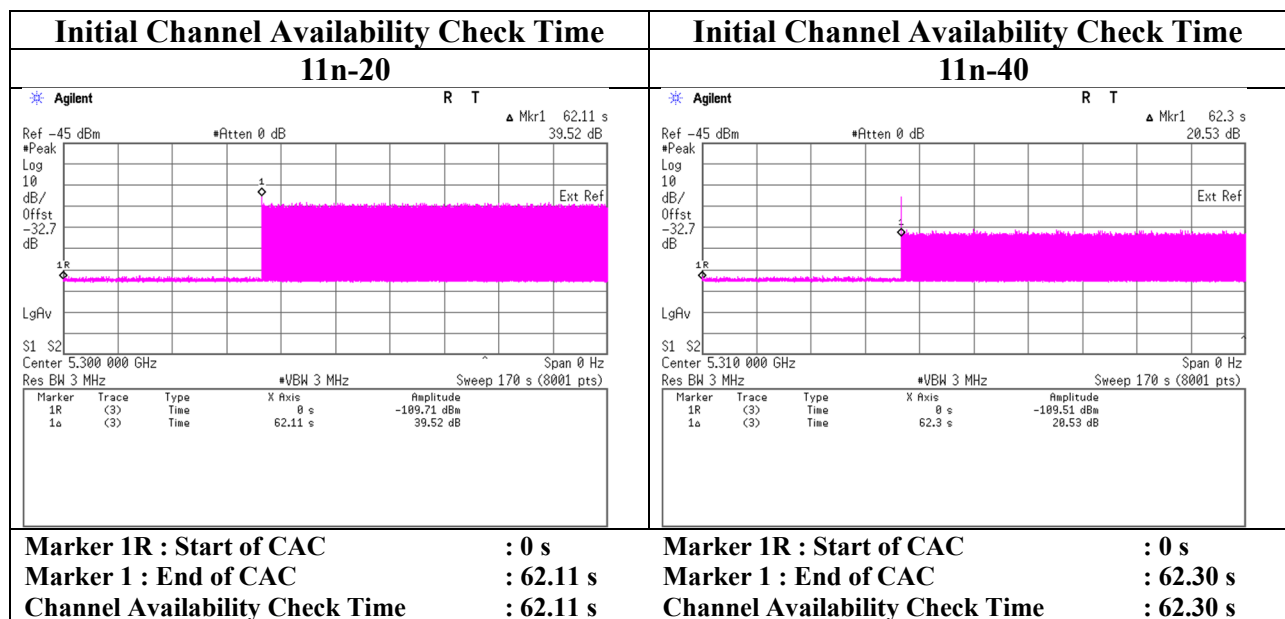

7.4 Test result

Test result: Pass

UL Japan, Inc.

Shonan EMC Lab.

1-22-3 Megumigaoka, Hiratsuka-shi, Kanagawa-ken, 259-1220 JAPAN

Telephone : +81 463 50 6400

Facsimile : +81 463 50 6401

SECTION 8: Radar Burst at the Beginning of the Channel Availability Check Time

8.1 Operating environment

Test place : Shonan EMC Lab.No.5 Shielded Room
Date : October 16, 2020
Temperature/ Humidity : 25 deg. C / 57 % RH
Engineer : Kenichi Adachi
Mode : 11n-40

8.2 Test Procedure

A single Burst of the Short Pulse Radar Types 0-4 will commence within a 6 second window starting at Start of CAC. An additional 1 dB is added to the radar test signal to ensure it is at or above the DFS Detection Threshold, accounting for equipment variations/errors. Verify that during the 2.5 minutes measurement window no EUT transmissions occurred on Chr.

8.3 Test data

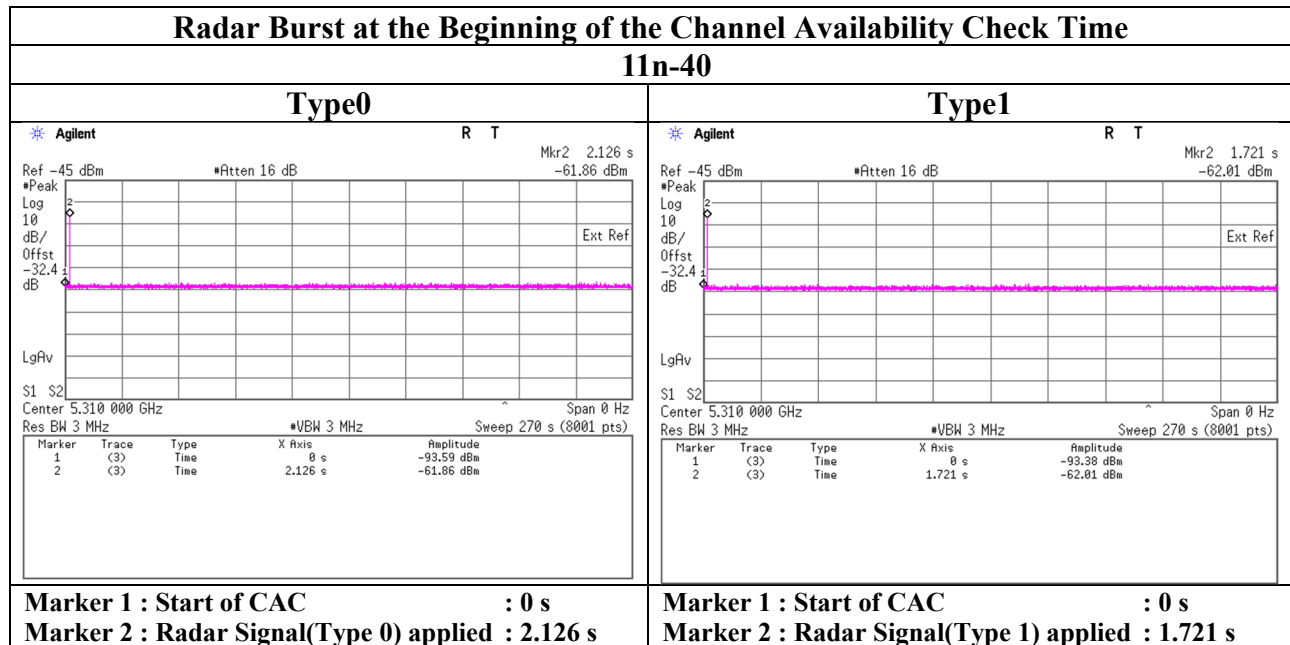

Radar Burst at the Beginning of the Channel Availability Check Time

11n-40

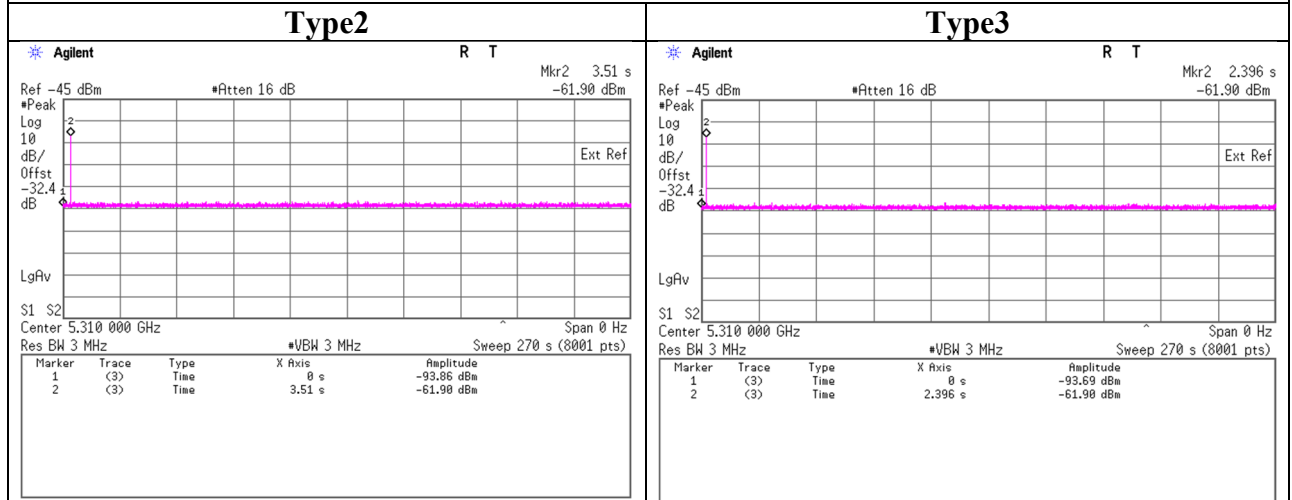

Marker 1 : Start of CAC : 0 s
Marker 2 : Radar Signal(Type 2) applied : 3.510 s

Marker 1 : Start of CAC : 0 s
Marker 2 : Radar Signal(Type 3) applied : 2.396 s

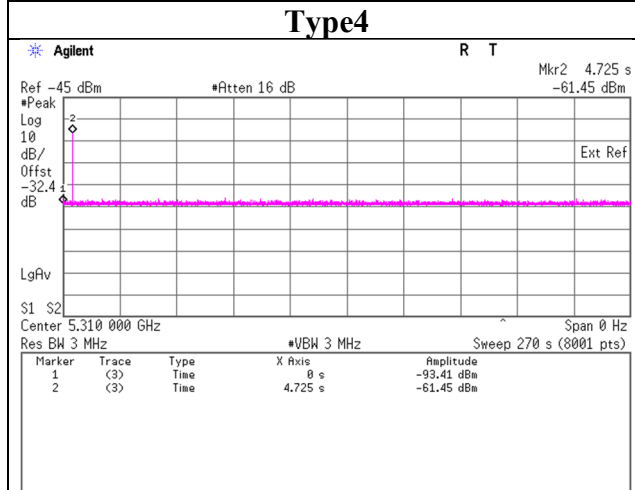

Marker 1 : Start of CAC : 0 s
Marker 2 : Radar Signal(Type 4) applied : 4.725 s

8.4 Test result

Test result: Pass

SECTION 9: Radar Burst at the End of the Channel Availability Check Time

9.1 Operating environment

Test place : Shonan EMC Lab.No.5 Shielded Room
Date : October 16, 2020
Temperature/ Humidity : 25 deg. C / 57 % RH
Engineer : Kenichi Adachi
Mode : 11n-40

9.2 Test Procedure

A single Burst of the Short Pulse Radar Types 0-4 will commence within a 6 second window starting at Start of CAC + 54 seconds. An additional 1 dB is added to the radar test signal to ensure it is at or above the DFS Detection Threshold, accounting for equipment variations/errors. Verify that during the 2.5 minutes measurement window no EUT transmissions occurred on Chr.

9.3 Test data

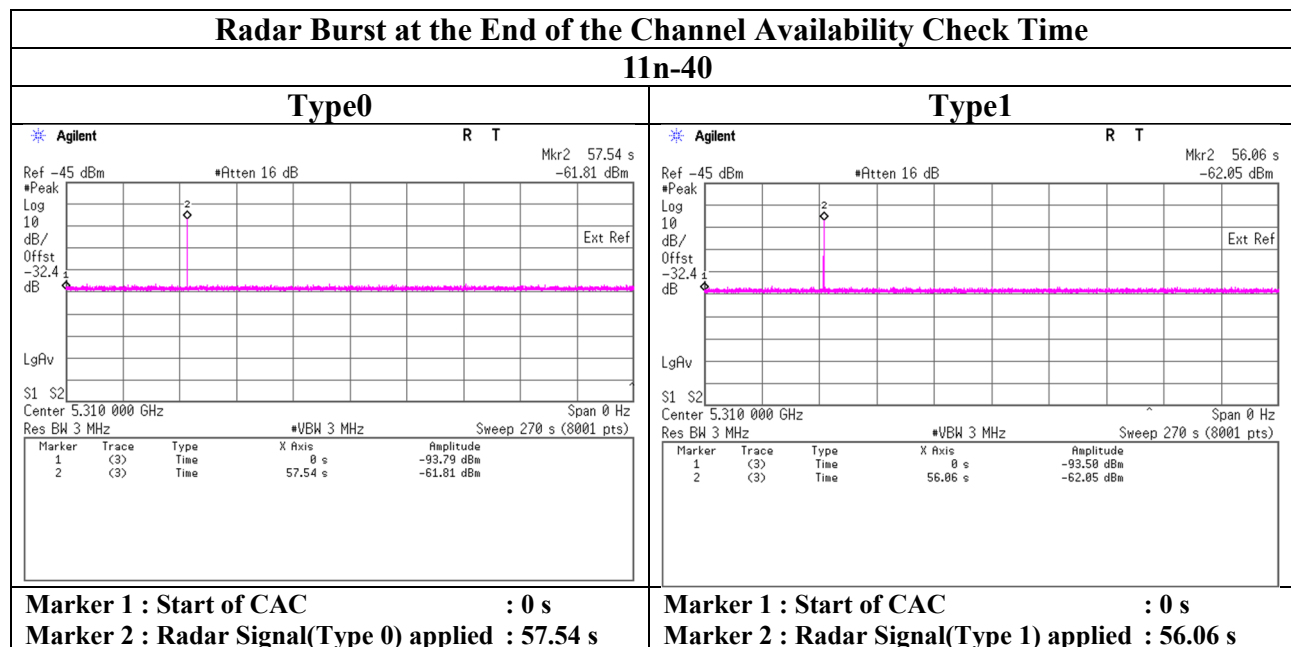

UL Japan, Inc.

Shonan EMC Lab.

1-22-3 Megumigaoka, Hiratsuka-shi, Kanagawa-ken, 259-1220 JAPAN

Telephone : +81 463 50 6400

Facsimile : +81 463 50 6401

Radar Burst at the End of the Channel Availability Check Time

11n-40

Type2

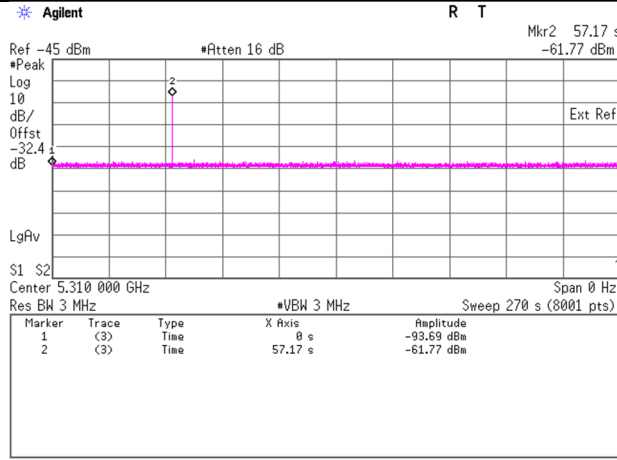

Marker 1 : Start of CAC : 0 s
Marker 2 : Radar Signal(Type 2) applied : 57.17 s

Type3

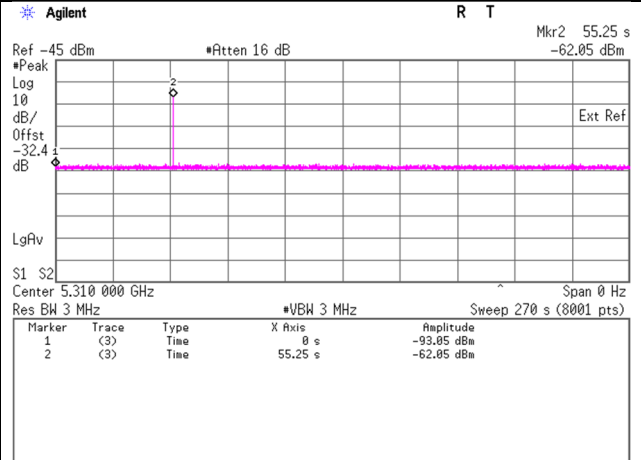

Marker 1 : Start of CAC : 0 s
Marker 2 : Radar Signal(Type 3) applied : 55.25 s

Type4

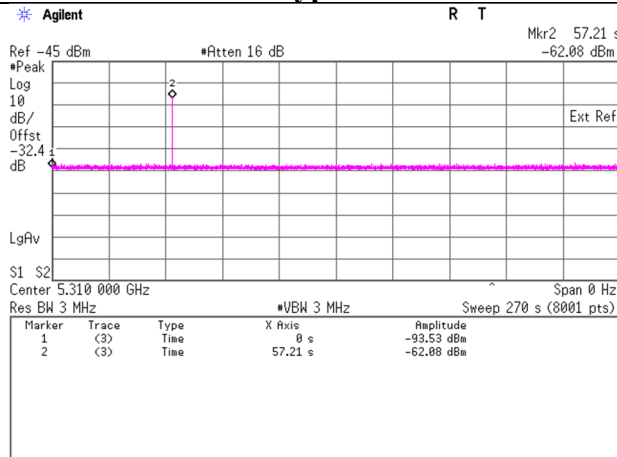

Marker 1 : Start of CAC : 0 s
Marker 2 : Radar Signal(Type 4) applied : 57.21 s

9.4 Test result

Test result: Pass

SECTION 10: Channel Move Time, Channel Closing Transmission Time

10.1 Operating environment

Test place Shonan EMC Lab.No.5 Shielded Room
Date November 29, 2020
Temperature/ Humidity 22 deg. C / 49 % RH
Engineer Kenichi Adachi
Mode 11n-40

10.2 Test Procedure

Transmit the data from the Master Device to the Client Device on the test Channel for the entire period of the test. The Radar Waveform generator sends a Burst of pulses for one of the Radar Types 0 at levels defined on the Operating Channel. An additional 1 dB is added to the radar test signal to ensure it is at or above the DFS Detection Threshold, accounting for equipment variations/errors. Observe the transmissions of the EUT at the end of the radar Burst on the Operating Channel for duration greater than 10 seconds.

10.3 Test data

<Master Device>

11n-40

Test Item	Unit	Measurement Time	Limit	Results
Channel Move Time *1)	[s]	0.836	10.000	Pass
Channel Closing Transmission Time *2)	[ms]	18	60	Pass

*1) Channel Move Time is calculated as follows:

$$(\text{Channel Move Time}) = (\text{End of Transmission}) - (\text{End of Burst}) = 1.356 - 0.52$$

*2) Channel Closing Transmission Time is calculated from (End of Burst + 200 ms) to (End of Burst + 10 s)

$$(\text{Channel Closing Transmission Time}) = (\text{Number of analyzer bins showing transmission}) \times (\text{dwell time per bin}) \\ = 9 \times 2 \text{ [ms]}$$

<Master mode>

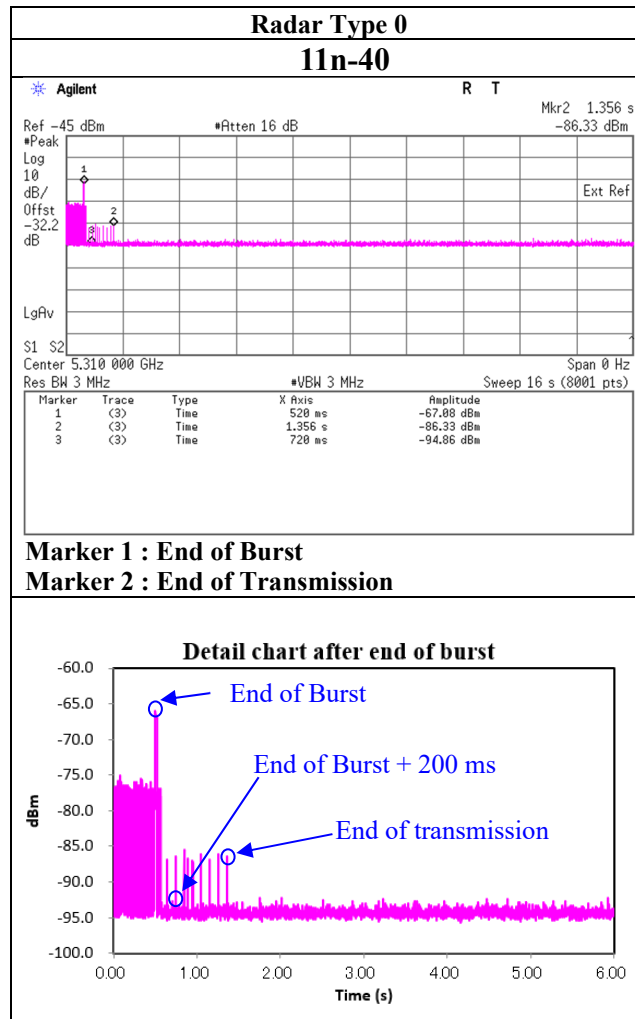

10.4 Test result

Test result: Pass

SECTION 11: Non-Occupancy Period

11.1 Operating environment

Test place	Shonan EMC Lab.No.5 Shielded Room
Date	October 15, 2020
Temperature/ Humidity	23 deg. C / 57 % RH
Engineer	Kenichi Adachi
Mode	11n-40

11.2 Test Procedure

The following two tests are performed:

1). Transmit the data from the Master Device to the Client Device on the test Channel for the entire period of the test. The Radar Waveform generator sends a Burst of pulses for one of the Radar Types 0-4(Master Device) or the Radar Types 0(Client Device) at levels defined on the Operating Channel. An additional 1 dB is added to the radar test signal to ensure it is at or above the DFS Detection Threshold, accounting for equipment variations/errors. Observe the transmissions of the EUT after the Channel Move Time on the Operating Channel for duration greater than 30 minutes.

11.3 Test data

<Master mode>

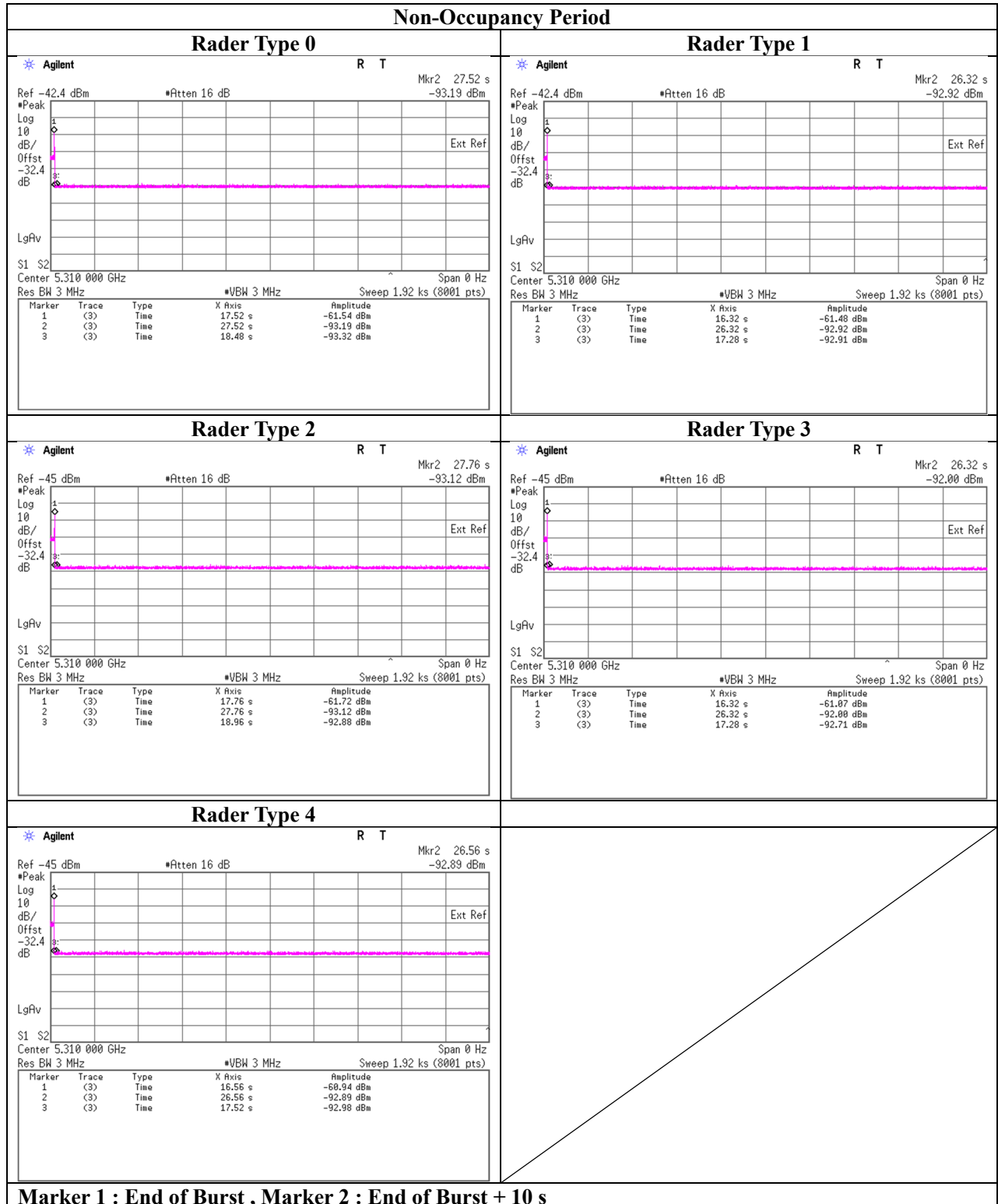

11.4 Test result

Test result: Pass

UL Japan, Inc.
Shonan EMC Lab.

1-22-3 Megumigaoka, Hiratsuka-shi, Kanagawa-ken, 259-1220 JAPAN
Telephone : +81 463 50 6400
Facsimile : +81 463 50 6401

SECTION 12: In-Service Monitoring (Statistical Performance Check)

12.1 Operating environment

Test place	Shonan EMC Lab.No.5 Shielded Room
Date	December 21, 2020
Temperature/ Humidity	23 deg. C / 30 % RH
Engineer	Kenichi Adachi
Mode	11a, 11n-40

12.2 Test Procedure

Transmit the data from the Master Device to the Client Device on the test Channel for the entire period of the test. Radar Waveform generator sends the individual waveform for each of the Radar Types 1-6, at levels defined, on the Operating Channel. An additional 1dB is added to the radar test signal to ensure it is at or above the DFS Detection Threshold, accounting for equipment variations/errors.

Observe the transmissions of the EUT at the end of the Burst on the Operating Channel for duration greater than 10 seconds for Short Pulse Radar Types 1-4 and 6 to ensure detection occurs.

Observe the transmissions of the EUT at the end of the Burst on the Operating Channel for duration greater than 22 seconds for Long Pulse Radar Type 5 to ensure detection occurs.

Radar detection is observed by two techniques.

- a). Monitoring LAN traffic with Spectrum Analyzer.
- b). Indicator of PC connected to EUT

12.3 Test data

5300MHz (11a)

Radar Type	Number of Trials	Number of Successful Detections	Percentage of Successful Detections [%]	Limit [%]	Results
1	30	30	100.00	60	Pass
2	30	30	100.00	60	Pass
3	30	30	100.00	60	Pass
4	30	30	100.00	60	Pass
Aggregate of 1 to 4	-	-	100.00	80	Pass
5	30	30	100.00	80	Pass
6	30	30	100.00	70	Pass

5310MHz (11n-40)

Radar Type	Number of Trials	Number of Successful Detections	Percentage of Successful Detections [%]	Limit [%]	Results
1	30	30	100.00	60	Pass
2	30	29	96.67	60	Pass
3	30	30	100.00	60	Pass
4	30	30	100.00	60	Pass
Aggregate of 1 to 4	-	-	99.17	80	Pass
5	30	28	93.33	80	Pass
6	30	30	100.00	70	Pass

12.4 Test result

Test result: Pass

APPENDIX 1: Data of DFS test

U-NII Detection Bandwidth

5300 MHz (11a)

Frequency [MHz]	Number of Trials [Times]	Number of Detected [Times]	Ratio of Detected [%]	Mark
5285	10	0	0	
5286	10	0	0	
5287	10	0	0	
5288	10	0	0	
5289	10	0	0	
5290	10	10	100	FL
5295	10	10	100	
5300	10	10	100	
5305	10	10	100	
5310	10	10	100	FH
5311	10	0	0	
5312	10	0	0	
5313	10	0	0	
5314	10	0	0	
5315	10	0	0	

5300 MHz (11n-20)

Frequency [MHz]	Number of Trials [Times]	Number of Detected [Times]	Ratio of Detected [%]	Mark
5285	10	0	0	
5286	10	0	0	
5287	10	0	0	
5288	10	0	0	
5289	10	0	0	
5290	10	10	100	FL
5295	10	10	100	
5300	10	10	100	
5305	10	10	100	
5310	10	10	100	FH
5311	10	0	0	
5312	10	0	0	
5313	10	0	0	
5314	10	0	0	
5315	10	0	0	

5510MHz (11n-40)

Frequency [MHz]	Number of Trials [Times]	Number of Detected [Times]	Ratio of Detected [%]	Mark
5290	10	1	10	
5291	10	10	100	FL
5295	10	10	100	
5300	10	10	100	
5305	10	10	100	
5310	10	10	100	
5315	10	10	100	
5320	10	10	100	
5325	10	10	100	
5329	10	10	100	FH
5330	10	0	0	

Statistical Performance Check

5300 MHz (11a)

Trial #	Radar Type1	Radar Type2	Radar Type3	Radar Type4	Radar Type5	Radar Type6
	Detection	Detection	Detection	Detection	Detection	Detection
	Yes/No	Yes/No	Yes/No	Yes/No	Yes/No	Yes/No
1	Yes	Yes	Yes	Yes	Yes	Yes
2	Yes	Yes	Yes	Yes	Yes	Yes
3	Yes	Yes	Yes	Yes	Yes	Yes
4	Yes	Yes	Yes	Yes	Yes	Yes
5	Yes	Yes	Yes	Yes	Yes	Yes
6	Yes	Yes	Yes	Yes	Yes	Yes
7	Yes	Yes	Yes	Yes	Yes	Yes
8	Yes	Yes	Yes	Yes	Yes	Yes
9	Yes	Yes	Yes	Yes	Yes	Yes
10	Yes	Yes	Yes	Yes	Yes	Yes
11	Yes	Yes	Yes	Yes	Yes	Yes
12	Yes	Yes	Yes	Yes	Yes	Yes
13	Yes	Yes	Yes	Yes	Yes	Yes
14	Yes	Yes	Yes	Yes	Yes	Yes
15	Yes	Yes	Yes	Yes	Yes	Yes
16	Yes	Yes	Yes	Yes	Yes	Yes
17	Yes	Yes	Yes	Yes	Yes	Yes
18	Yes	Yes	Yes	Yes	Yes	Yes
19	Yes	Yes	Yes	Yes	Yes	Yes
20	Yes	Yes	Yes	Yes	Yes	Yes
21	Yes	Yes	Yes	Yes	Yes	Yes
22	Yes	Yes	Yes	Yes	Yes	Yes
23	Yes	Yes	Yes	Yes	Yes	Yes
24	Yes	Yes	Yes	Yes	Yes	Yes
25	Yes	Yes	Yes	Yes	Yes	Yes
26	Yes	Yes	Yes	Yes	Yes	Yes
27	Yes	Yes	Yes	Yes	Yes	Yes
28	Yes	Yes	Yes	Yes	Yes	Yes
29	Yes	Yes	Yes	Yes	Yes	Yes
30	Yes	Yes	Yes	Yes	Yes	Yes
EUT Test Frequency: 5300 MHz						
Radar Frequency: 5300 MHz						

Statistical Performance Check

5310 MHz (11n-40)

Trial #	Radar Type1	Radar Type2	Radar Type3	Radar Type4	Radar Type5	Radar Type6
	Detection	Detection	Detection	Detection	Detection	Detection
	Yes/No	Yes/No	Yes/No	Yes/No	Yes/No	Yes/No
1	Yes	Yes	Yes	Yes	Yes	Yes
2	Yes	Yes	Yes	Yes	Yes	Yes
3	Yes	Yes	Yes	Yes	Yes	Yes
4	Yes	Yes	Yes	Yes	Yes	Yes
5	Yes	Yes	Yes	Yes	Yes	Yes
6	Yes	Yes	Yes	Yes	Yes	Yes
7	Yes	Yes	Yes	Yes	Yes	Yes
8	Yes	Yes	Yes	Yes	Yes	Yes
9	Yes	Yes	Yes	Yes	Yes	Yes
10	Yes	Yes	Yes	Yes	Yes	Yes
11	Yes	Yes	Yes	Yes	Yes	Yes
12	Yes	Yes	Yes	Yes	Yes	Yes
13	Yes	Yes	Yes	Yes	Yes	Yes
14	Yes	Yes	Yes	Yes	No	Yes
15	Yes	Yes	Yes	Yes	No	Yes
16	Yes	Yes	Yes	Yes	Yes	Yes
17	Yes	Yes	Yes	Yes	Yes	Yes
18	Yes	Yes	Yes	Yes	Yes	Yes
19	Yes	Yes	Yes	Yes	Yes	Yes
20	Yes	Yes	Yes	Yes	Yes	Yes
21	Yes	Yes	Yes	Yes	Yes	Yes
22	Yes	No	Yes	Yes	Yes	Yes
23	Yes	Yes	Yes	Yes	Yes	Yes
24	Yes	Yes	Yes	Yes	Yes	Yes
25	Yes	Yes	Yes	Yes	Yes	Yes
26	Yes	Yes	Yes	Yes	Yes	Yes
27	Yes	Yes	Yes	Yes	Yes	Yes
28	Yes	Yes	Yes	Yes	Yes	Yes
29	Yes	Yes	Yes	Yes	Yes	Yes
30	Yes	Yes	Yes	Yes	Yes	Yes

EUT Test Frequency: 5310 MHz
Radars Frequency: 5310 MHz

Parameter Data sheet for Radar Type 1

5300 MHz (11a)

Radar Type1				
Trial #	Pulse Repetition Frequency Number(1 to 23)	Pulse Repetition Frequency (Pulses Per Second)	Number of Pulses	Pulse Repetition Interval (Microseconds)
1	15	1253.1	67	798
2	11	1392.8	74	718
3	10	1432.7	76	698
4	9	1474.9	78	678
5	22	1066.1	57	938
6	3	1792.1	95	558
7	4	1730.1	92	578
8	21	1089.3	58	918
9	18	1165.5	62	858
10	19	1139.0	61	878
11	5	1672.2	89	598
12	20	1113.6	59	898
13	1	1930.5	102	518
14	14	1285.3	68	778
15	7	1567.4	83	638
16	-	550.1	30	1818
17	-	821.7	44	1217
18	-	376.6	20	2655
19	-	965.3	51	1036
20	-	472.8	25	2115
21	-	1481.5	79	675
22	-	397.5	21	2516
23	-	765.7	41	1306
24	-	627.0	34	1595
25	-	434.0	23	2304
26	-	450.2	24	2221
27	-	1434.7	76	697
28	-	1440.9	77	694
29	-	327.2	18	3056
30	-	568.8	31	1758

Parameter Data sheet for Radar Type 1

5310 MHz (11n-40)

Radar Type1				
Trial #	Pulse Repetition Frequency Number(1 to 23)	Pulse Repetition Frequency (Pulses Per Second)	Number of Pulses	Pulse Repetition Interval (Microseconds)
1	16	1222.5	65	818
2	14	1285.3	68	778
3	12	1355.0	72	738
4	8	1519.8	81	658
5	10	1432.7	76	698
6	3	1792.1	95	558
7	22	1066.1	57	938
8	6	1618.1	86	618
9	23	326.2	18	3066
10	17	1193.3	63	838
11	19	1139.0	61	878
12	9	1474.9	78	678
13	15	1253.1	67	798
14	20	1113.6	59	898
15	7	1567.4	83	638
16	-	914.1	49	1094
17	-	473.7	26	2111
18	-	734.2	39	1362
19	-	470.4	25	2126
20	-	718.4	38	1392
21	-	621.5	33	1609
22	-	753.0	40	1328
23	-	520.8	28	1920
24	-	424.6	23	2355
25	-	673.9	36	1484
26	-	1589.8	84	629
27	-	961.5	51	1040
28	-	1022.5	54	978
29	-	501.3	27	1995
30	-	1351.4	72	740

UL Japan, Inc.

Shonan EMC Lab.

1-22-3 Megumigaoka, Hiratsuka-shi, Kanagawa-ken, 259-1220 JAPAN

Telephone : +81 463 50 6400

Facsimile : +81 463 50 6401

Parameter Data sheet for Radar Type 2

5300 MHz (11a)

Radar Type2			
Trial #	Number Pulses per Burst	Pulse Width [us]	PRI [us]
1	28	4.1	200
2	23	1.1	201
3	28	4.2	166
4	25	2.7	223
5	28	4.3	197
6	25	2.1	154
7	29	4.5	199
8	28	4.1	163
9	28	4.2	187
10	24	1.9	173
11	25	2.3	183
12	26	3.1	159
13	27	3.8	175
14	29	5.0	157
15	26	3.3	204
16	24	1.8	168
17	27	3.7	227
18	24	1.8	171
19	28	3.9	193
20	26	3.0	182
21	26	3.1	185
22	26	3.2	228
23	25	2.6	169
24	28	4.1	220
25	24	1.8	180
26	27	3.5	155
27	27	3.5	191
28	28	4.3	153
29	27	3.9	158
30	29	4.5	205

Parameter Data sheet for Radar Type 2

5310 MHz (11n-40)

Radar Type2			
Trial #	Number Pulses per Burst	Pulse Width [us]	PRI [us]
1	28	4.4	178
2	24	2.0	160
3	23	1.4	224
4	26	3.3	207
5	25	2.5	203
6	28	4.3	166
7	26	3.0	182
8	24	2.0	183
9	27	3.7	191
10	25	2.4	227
11	23	1.1	209
12	29	4.6	210
13	29	4.7	204
14	25	2.4	218
15	24	2.1	154
16	23	1.4	190
17	29	4.5	213
18	28	4.3	181
19	26	3.0	229
20	26	3.2	195
21	29	4.8	153
22	27	3.4	199
23	24	1.6	221
24	26	3.0	194
25	26	3.0	157
26	25	2.4	223
27	27	3.5	192
28	27	3.8	217
29	24	2.0	228
30	26	2.8	169

Parameter Data sheet for Radar Type 3

5300 MHz (11a)

Radar Type3			
Trial #	Number Pulses per Burst	Pulse Width [us]	PRI [us]
1	18	9.1	336
2	16	6.1	433
3	18	9.2	267
4	17	7.7	492
5	18	9.3	318
6	16	7.1	351
7	18	9.5	356
8	18	9.1	397
9	18	9.2	257
10	16	6.9	223
11	16	7.3	240
12	17	8.1	275
13	18	8.8	280
14	18	10.0	409
15	17	8.3	361
16	16	6.8	375
17	18	8.7	216
18	16	6.8	329
19	18	8.9	250
20	17	8.0	239
21	17	8.1	352
22	17	8.2	487
23	17	7.6	478
24	18	9.1	364
25	16	6.8	276
26	17	8.5	272
27	17	8.5	307
28	18	9.3	224
29	18	8.9	373
30	18	9.5	411

Parameter Data sheet for Radar Type 3

5310 MHz (11n-40)

Radar Type3			
Trial #	Number Pulses per Burst	Pulse Width [us]	PRI [us]
1	18	9.4	442
2	16	7.0	498
3	16	6.4	430
4	17	8.3	277
5	17	7.5	223
6	18	9.3	454
7	17	8.0	435
8	16	7.0	208
9	18	8.7	424
10	17	7.4	214
11	16	6.1	395
12	18	9.6	212
13	18	9.7	348
14	17	7.4	289
15	16	7.1	405
16	16	6.4	270
17	18	9.5	402
18	18	9.3	465
19	17	8.0	428
20	17	8.2	288
21	18	9.8	232
22	17	8.4	217
23	16	6.6	418
24	17	8.0	381
25	17	8.0	341
26	17	7.4	444
27	17	8.5	500
28	18	8.8	320
29	16	7.0	461
30	17	7.8	200

Parameter Data sheet for Radar Type 4

5300 MHz (11a)

Radar Type4			
Trial #	Number Pulses per Burst	Pulse Width [us]	PRI [us]
1	15	18.0	336
2	12	11.2	433
3	16	18.3	267
4	14	14.8	492
5	16	18.5	318
6	13	13.6	351
7	16	18.9	356
8	15	18.0	397
9	15	18.1	257
10	13	13.2	223
11	13	14.0	240
12	14	15.7	275
13	15	17.3	280
14	16	19.9	409
15	14	16.1	361
16	13	12.8	375
17	15	17.0	216
18	12	12.7	329
19	15	17.5	250
20	14	15.5	239
21	14	15.7	352
22	14	16.0	487
23	13	14.5	478
24	15	18.0	364
25	13	12.8	276
26	15	16.5	272
27	15	16.7	307
28	16	18.5	224
29	15	17.4	373
30	16	18.8	411

Parameter Data sheet for Radar Type 4

5310 MHz (11n-40)

Radar Type4			
Trial #	Number Pulses per Burst	Pulse Width [us]	PRI [us]
1	16	18.6	442
2	13	13.4	498
3	12	12.0	430
4	14	16.1	277
5	13	14.5	223
6	16	18.4	454
7	14	15.4	435
8	13	13.4	208
9	15	17.1	424
10	13	14.2	214
11	12	11.2	395
12	16	19.0	212
13	16	19.3	348
14	13	14.1	289
15	13	13.5	405
16	12	12.0	270
17	16	18.9	402
18	16	18.4	465
19	14	15.5	428
20	14	16.0	288
21	16	19.5	232
22	15	16.4	217
23	12	12.4	418
24	14	15.6	381
25	14	15.5	341
26	13	14.1	444
27	15	16.7	500
28	15	17.2	320
29	13	13.3	461
30	14	15.1	200

Parameter Data sheet for Radar Type 5
5300 MHz (11a)

Trial #	Burst Number	Number of Pulses	Pulse Width [us]	Chirp Width [MHz]	Pulse 1-to-2 Spacing [us]	Pulse 2-to-3 Spacing [us]	Starting Location Within Interval [us]	Center Frequency [MHz]
1	0	2	78.6	14.0	1530.4	-	649703	5300
	1	1	64.6	14.0	-	-	46120	5300
	2	3	90.4	14.0	1376.6	1193.6	238859	5300
	3	2	80.1	14.0	1780.9	-	432301	5300
	4	3	91.6	14.0	1011.4	1688.4	624859	5300
	5	3	99.6	14.0	1691.4	1347.4	22144	5300
	6	3	95.5	14.0	1481.5	982.5	215084	5300
	7	3	88.6	14.0	979.4	1192.4	408302	5300
	8	3	89.7	14.0	1416.3	1118.3	600820	5300
	9	3	99.3	14.0	1579.7	1698.7	792970	5300
	10	1	52.4	14.0	-	-	191939	5300
	11	1	54.6	14.0	-	-	385661	5300
	12	1	57.7	14.0	-	-	579290	5300
	13	2	71.3	14.0	1367.7	-	771417	5300
14	1	63.8	14.0	-	-	168187	5300	

Trial #	Burst Number	Number of Pulses	Pulse Width [us]	Chirp Width [MHz]	Pulse 1-to-2 Spacing [us]	Pulse 2-to-3 Spacing [us]	Starting Location Within Interval [us]	Center Frequency [MHz]
2	0	2	73.6	9.0	1827.4	-	492985	5300
	1	3	99.1	9.0	1103.9	1492.9	755824	5300
	2	3	90.8	9.0	1373.2	1791.2	1019400	5300
	3	2	81.3	9.0	1808.7	-	196598	5300
	4	3	86.1	9.0	1699.9	1131.9	459701	5300
	5	3	90.0	9.0	1241.0	1218.0	723844	5300
	6	1	60.0	9.0	-	-	989412	5300
	7	3	93.0	9.0	1074.0	1505.0	163906	5300
	8	1	65.8	9.0	-	-	428627	5300
	9	3	94.9	9.0	1592.1	1231.1	690618	5300
10	1	64.9	9.0	-	-	957158	5300	

Trial #	Burst Number	Number of Pulses	Pulse Width [us]	Chirp Width [MHz]	Pulse 1-to-2 Spacing [us]	Pulse 2-to-3 Spacing [us]	Starting Location Within Interval [us]	Center Frequency [MHz]
3	0	2	77.8	17.0	1707.2	-	80222	5300
	1	2	78.3	17.0	1021.7	-	241414	5300
	2	1	56.2	17.0	-	-	403234	5300
	3	1	53.2	17.0	-	-	564065	5300
	4	1	62.1	17.0	-	-	60615	5300
	5	3	90.4	17.0	1710.6	1352.6	220844	5300
	6	3	87.3	17.0	1040.7	1172.7	381954	5300
	7	1	60.9	17.0	-	-	544942	5300
	8	1	62.8	17.0	-	-	40734	5300
	9	2	79.0	17.0	1384.0	-	201605	5300
	10	3	97.1	17.0	1797.9	1735.9	361597	5300
	11	3	86.8	17.0	1525.2	1790.2	521992	5300
	12	2	67.3	17.0	1120.7	-	20838	5300
	13	3	99.5	17.0	1027.5	1529.5	181490	5300
	14	1	66.4	17.0	-	-	343274	5300
	15	2	74.0	17.0	1522.0	-	503349	5300
	16	1	62.5	17.0	-	-	1004	5300
17	2	69.4	17.0	1521.6	-	162012	5300	

Trial #	Burst Number	Number of Pulses	Pulse Width [us]	Chirp Width [MHz]	Pulse 1-to-2 Spacing [us]	Pulse 2-to-3 Spacing [us]	Starting Location Within Interval [us]	Center Frequency [MHz]
4	0	1	52.7	14.0	-	-	388677	5300
	1	3	100.0	14.0	1542.0	1186.0	580368	5300
	2	1	53.7	14.0	-	-	776014	5300
	3	2	71.7	14.0	1689.3	-	170689	5300
	4	3	99.5	14.0	1309.5	931.5	363431	5300
	5	1	54.9	14.0	-	-	558628	5300
	6	3	97.7	14.0	1252.3	1335.3	749523	5300
	7	2	69.8	14.0	1210.2	-	146982	5300
	8	2	71.7	14.0	1235.3	-	340204	5300
	9	3	96.7	14.0	1216.3	972.3	533160	5300
	10	1	65.9	14.0	-	-	728449	5300
	11	2	68.5	14.0	1397.5	-	123044	5300
	12	2	71.7	14.0	1883.3	-	316287	5300
	13	2	74.6	14.0	976.4	-	510023	5300
14	3	85.3	14.0	1685.7	1434.7	701002	5300	

Trial #	Burst Number	Number of Pulses	Pulse Width [us]	Chirp Width [MHz]	Pulse 1-to-2 Spacing [us]	Pulse 2-to-3 Spacing [us]	Starting Location Within Interval [us]	Center Frequency [MHz]
5	0	2	76.7	18.0	1480.3	-	82702	5300
	1	2	71.8	18.0	1080.2	-	243658	5300
	2	2	67.1	18.0	1909.9	-	404519	5300
	3	2	82.4	18.0	1391.6	-	565957	5300
	4	3	86.5	18.0	1660.5	1514.5	62681	5300
	5	3	87.2	18.0	1893.8	1814.8	222986	5300
	6	1	62.0	18.0	-	-	385650	5300
	7	2	67.4	18.0	1511.6	-	545800	5300
	8	3	96.8	18.0	1411.2	1802.2	42875	5300
	9	1	58.5	18.0	-	-	204399	5300
	10	3	84.8	18.0	1385.2	1147.2	364252	5300
	11	2	76.5	18.0	1791.5	-	525648	5300
	12	1	62.3	18.0	-	-	23244	5300
	13	2	73.5	18.0	1924.5	-	183864	5300
	14	2	81.9	18.0	1308.1	-	345081	5300
	15	2	69.7	18.0	1019.3	-	506444	5300
	16	1	66.0	18.0	-	-	3356	5300
17	3	97.6	18.0	1513.4	1094.4	163999	5300	

Trial #	Burst Number	Number of Pulses	Pulse Width [us]	Chirp Width [MHz]	Pulse 1-to-2 Spacing [us]	Pulse 2-to-3 Spacing [us]	Starting Location Within Interval [us]	Center Frequency [MHz]
6	0	2	73.5	20.0	1117.5	-	292914	5300
	1	1	63.1	20.0	-	-	438491	5300
	2	3	95.0	20.0	1850.0	1645.0	580471	5300
	3	1	61.2	20.0	-	-	130305	5300
	4	1	56.1	20.0	-	-	275654	5300
	5	2	78.8	20.0	1187.2	-	419546	5300
	6	1	51.2	20.0	-	-	566105	5300
	7	1	55.5	20.0	-	-	112346	5300
	8	3	92.4	20.0	1865.6	994.6	256435	5300
	9	2	68.6	20.0	1567.4	-	401882	5300
	10	3	90.7	20.0	1711.3	1219.3	544821	5300
	11	3	95.1	20.0	1671.9	1796.9	93919	5300
	12	3	94.3	20.0	1611.7	993.7	238467	5300
	13	1	57.3	20.0	-	-	384550	5300
	14	2	72.5	20.0	1331.5	-	528934	5300
	15	1	51.5	20.0	-	-	76702	5300
	16	3	90.7	20.0	1650.3	1737.3	220533	5300
	17	2	77.7	20.0	1284.3	-	366067	5300
	18	3	99.3	20.0	1706.7	1140.7	509509	5300
19	3	91.6	20.0	927.4	1041.4	58545	5300	

Trial #	Burst Number	Number of Pulses	Pulse Width [us]	Chirp Width [MHz]	Pulse 1-to-2 Spacing [us]	Pulse 2-to-3 Spacing [us]	Starting Location Within Interval [us]	Center Frequency [MHz]
7	0	2	76.1	19.0	1438.9	-	214156	5300
	1	2	82.3	19.0	1601.7	-	366288	5300
	2	3	90.7	19.0	1043.3	1721.3	518067	5300
	3	2	82.5	19.0	1280.5	-	42989	5300
	4	1	56.9	19.0	-	-	195926	5300
	5	1	63.2	19.0	-	-	348421	5300
	6	1	64.7	19.0	-	-	501395	5300
	7	2	78.5	19.0	1152.5	-	24197	5300
	8	3	85.4	19.0	1468.6	1470.6	176258	5300
	9	3	96.3	19.0	1513.7	964.7	328336	5300
	10	3	89.9	19.0	1350.1	1617.1	480232	5300
	11	2	76.9	19.0	1587.1	-	5394	5300
	12	3	99.9	19.0	1110.1	1716.1	157397	5300
	13	2	71.0	19.0	1882.0	-	310035	5300
	14	3	98.3	19.0	983.7	981.7	462326	5300
	15	1	61.5	19.0	-	-	616199	5300
	16	3	90.3	19.0	1144.7	1245.7	138839	5300
	17	1	65.4	19.0	-	-	292229	5300
18	1	65.6	19.0	-	-	445169	5300	

Trial #	Burst Number	Number of Pulses	Pulse Width [us]	Chirp Width [MHz]	Pulse 1-to-2 Spacing [us]	Pulse 2-to-3 Spacing [us]	Starting Location Within Interval [us]	Center Frequency [MHz]
8	0	3	88.3	17.0	1766.7	1132.7	628521	5300
	1	2	81.1	17.0	1180.9	-	126985	5300
	2	2	80.9	17.0	1417.1	-	288113	5300
	3	3	94.9	17.0	1402.1	1852.1	447462	5300
	4	3	93.4	17.0	1335.6	1303.6	608521	5300
	5	2	76.8	17.0	1461.2	-	107199	5300
	6	1	51.7	17.0	-	-	268798	5300
	7	1	64.3	17.0	-	-	429903	5300
	8	2	77.5	17.0	1468.5	-	590327	5300
	9	1	54.0	17.0	-	-	87525	5300
	10	1	60.8	17.0	-	-	248939	5300
	11	2	82.9	17.0	1028.1	-	409294	5300
	12	1	54.1	17.0	-	-	571337	5300
	13	2	70.4	17.0	1323.6	-	67499	5300
	14	2	74.4	17.0	1244.6	-	228551	5300
	15	2	71.4	17.0	1193.6	-	389564	5300
	16	3	91.2	17.0	1122.8	1495.8	549418	5300
17	2	72.4	17.0	1873.6	-	47654	5300	

Trial #	Burst Number	Number of Pulses	Pulse Width [us]	Chirp Width [MHz]	Pulse 1-to-2 Spacing [us]	Pulse 2-to-3 Spacing [us]	Starting Location Within Interval [us]	Center Frequency [MHz]
9	0	1	62.4	17.0	-	-	209025	5300
	1	1	54.3	17.0	-	-	370516	5300
	2	3	92.9	17.0	1825.1	1096.1	528944	5300
	3	1	64.1	17.0	-	-	27940	5300
	4	2	72.8	17.0	1004.2	-	188990	5300
	5	2	70.2	17.0	1190.8	-	350180	5300
	6	3	96.1	17.0	1080.9	1812.9	509540	5300
	7	2	78.7	17.0	1497.3	-	8047	5300
	8	1	63.7	17.0	-	-	169444	5300
	9	3	95.2	17.0	1700.8	1492.8	328823	5300
	10	2	73.2	17.0	1194.8	-	491309	5300
	11	1	59.1	17.0	-	-	653097	5300
	12	1	61.0	17.0	-	-	149463	5300
	13	1	61.2	17.0	-	-	310749	5300
	14	2	75.2	17.0	1180.8	-	471098	5300
	15	1	62.0	17.0	-	-	633905	5300
	16	1	60.9	17.0	-	-	129737	5300
17	1	60.4	17.0	-	-	291104	5300	

Trial #	Burst Number	Number of Pulses	Pulse Width [us]	Chirp Width [MHz]	Pulse 1-to-2 Spacing [us]	Pulse 2-to-3 Spacing [us]	Starting Location Within Interval [us]	Center Frequency[MHz]
10	0	3	95.3	20.0	1427.7	1364.7	404759	5300
	1	3	87.5	20.0	1407.5	1066.5	549485	5300
	2	3	97.3	20.0	1333.7	1734.7	98204	5300
	3	1	55.7	20.0	-	-	243745	5300
	4	1	55.1	20.0	-	-	389000	5300
	5	3	99.0	20.0	1228.0	1816.0	531258	5300
	6	3	87.2	20.0	1242.8	935.8	80602	5300
	7	2	74.4	20.0	1011.6	-	225787	5300
	8	2	74.6	20.0	1600.4	-	370140	5300
	9	1	63.3	20.0	-	-	516143	5300
	10	3	85.8	20.0	1603.2	1763.2	62638	5300
	11	1	56.5	20.0	-	-	208003	5300
	12	2	75.5	20.0	1750.5	-	352192	5300
	13	3	99.7	20.0	1272.3	1039.3	495976	5300
	14	1	57.0	20.0	-	-	45116	5300
	15	3	89.1	20.0	1016.9	1740.9	189341	5300
	16	2	77.8	20.0	1348.2	-	334441	5300
	17	1	61.1	20.0	-	-	480647	5300
	18	2	72.8	20.0	1847.2	-	27166	5300
19	2	74.1	20.0	1480.9	-	172032	5300	

Trial #	Burst Number	Number of Pulses	Pulse Width [usec]	Chirp Width [MHz]	Pulse 1-to-2 Spacing [usec]	Pulse 2-to-3 Spacing [usec]	Starting Location Within Interval [usec]	Center Frequency[MHz]
11	0	1	58.3	5.0	-	-	795028	5293.8
	1	1	60.7	5.0	-	-	1158842	5293.8
	2	3	98.8	5.0	1137.2	1127.2	23416	5293.8
	3	1	64.7	5.0	-	-	386828	5293.8
	4	1	63.0	5.0	-	-	750328	5293.8
	5	1	56.6	5.0	-	-	1113821	5293.8
	6	3	91.1	5.0	1569.9	1228.9	1474466	5293.8
	7	2	68.4	5.0	1080.6	-	341832	5293.8

Trial #	Burst Number	Number of Pulses	Pulse Width [usec]	Chirp Width [MHz]	Pulse 1-to-2 Spacing [usec]	Pulse 2-to-3 Spacing [usec]	Starting Location Within Interval [usec]	Center Frequency[MHz]
12	0	3	93.1	6.0	1561.9	1644.9	625271	5294.2
	1	3	99.6	6.0	1141.4	1467.4	948375	5294.2
	2	1	57.6	6.0	-	-	1272695	5294.2
	3	3	92.1	6.0	1066.9	1094.9	263895	5294.2
	4	1	59.4	6.0	-	-	587387	5294.2
	5	1	63.9	6.0	-	-	910343	5294.2
	6	2	76.2	6.0	1328.8	-	1232208	5294.2
	7	1	53.7	6.0	-	-	224555	5294.2
	8	2	75.1	6.0	1788.9	-	546813	5294.2

UL Japan, Inc.

Shonan EMC Lab.

1-22-3 Megumigaoka, Hiratsuka-shi, Kanagawa-ken, 259-1220 JAPAN

Telephone : +81 463 50 6400

Facsimile : +81 463 50 6401

Trial #	Burst Number	Number of Pulses	Pulse Width [usec]	Chirp Width [MHz]	Pulse 1-to-2 Spacing [usec]	Pulse 2-to-3 Spacing [usec]	Starting Location Within Interval [usec]	Center Frequency [MHz]
13	0	1	56.7	7.0	-	-	870533	5294.6
	1	3	99.2	7.0	1776.8	1187.8	1190907	5294.6
	2	3	94.0	7.0	1030.0	1685.0	184253	5294.6
	3	2	77.0	7.0	1292.0	-	507118	5294.6
	4	3	98.5	7.0	1728.5	1498.5	828767	5294.6
	5	3	95.7	7.0	1613.3	1748.3	1150853	5294.6
	6	2	82.7	7.0	1155.3	-	144751	5294.6
	7	3	93.0	7.0	1102.0	1282.0	466997	5294.6
8	1	57.2	7.0	-	-	790754	5294.6	

Trial #	Burst Number	Number of Pulses	Pulse Width [usec]	Chirp Width [MHz]	Pulse 1-to-2 Spacing [usec]	Pulse 2-to-3 Spacing [usec]	Starting Location Within Interval [usec]	Center Frequency [MHz]
14	0	2	69.6	11.0	1087.4	-	769688	5296.2
	1	2	73.5	11.0	1892.5	-	72616	5296.2
	2	1	52.0	11.0	-	-	296215	5296.2
	3	2	71.9	11.0	1819.1	-	518505	5296.2
	4	3	83.5	11.0	971.5	1629.5	741435	5296.2
	5	1	64.1	11.0	-	-	45231	5296.2
	6	3	89.3	11.0	1390.7	1587.7	267861	5296.2
	7	3	86.8	11.0	1664.2	1337.2	490525	5296.2
	8	1	52.1	11.0	-	-	715646	5296.2
	9	3	84.5	11.0	1636.5	1094.5	17636	5296.2
	10	3	88.8	11.0	1732.2	1473.2	240432	5296.2
	11	2	82.6	11.0	1500.4	-	464138	5296.2
12	3	92.8	11.0	1803.2	1684.2	685686	5296.2	

Trial #	Burst Number	Number of Pulses	Pulse Width [usec]	Chirp Width [MHz]	Pulse 1-to-2 Spacing [usec]	Pulse 2-to-3 Spacing [usec]	Starting Location Within Interval [usec]	Center Frequency [MHz]
15	0	3	98.6	9.0	1721.4	1384.4	1074438	5295.4
	1	1	57.8	9.0	-	-	252541	5295.4
	2	2	68.8	9.0	938.2	-	516085	5295.4
	3	2	81.4	9.0	1768.6	-	779462	5295.4
	4	2	75.0	9.0	1859.0	-	1043370	5295.4
	5	1	55.7	9.0	-	-	220002	5295.4
	6	3	93.8	9.0	1258.2	1274.2	482856	5295.4
	7	3	97.1	9.0	1320.9	1135.9	746478	5295.4
	8	1	61.5	9.0	-	-	1013014	5295.4
	9	2	73.4	9.0	1532.6	-	187230	5295.4
10	1	53.3	9.0	-	-	451765	5295.4	

UL Japan, Inc.

Shonan EMC Lab.

1-22-3 Megumigaoka, Hiratsuka-shi, Kanagawa-ken, 259-1220 JAPAN

Telephone : +81 463 50 6400

Facsimile : +81 463 50 6401

Trial #	Burst Number	Number of Pulses	Pulse Width [usec]	Chirp Width [MHz]	Pulse 1-to-2 Spacing [usec]	Pulse 2-to-3 Spacing [usec]	Starting Location Within Interval [usec]	Center Frequency [MHz]
16	0	1	63.9	12.0	-	-	562405	5296.6
	1	2	71.1	12.0	1741.9	-	768083	5296.6
	2	1	61.9	12.0	-	-	121752	5296.6
	3	2	78.8	12.0	1026.2	-	328905	5296.6
	4	3	97.2	12.0	1317.8	1373.8	534994	5296.6
	5	1	59.9	12.0	-	-	744103	5296.6
	6	1	65.0	12.0	-	-	96174	5296.6
	7	1	66.0	12.0	-	-	303718	5296.6
	8	2	71.8	12.0	984.2	-	510734	5296.6
	9	1	55.8	12.0	-	-	718288	5296.6
	10	3	87.0	12.0	947.0	1835.0	70322	5296.6
	11	2	67.6	12.0	1465.4	-	277621	5296.6
	12	1	66.3	12.0	-	-	485682	5296.6
13	2	71.2	12.0	1469.8	-	691634	5296.6	

Trial #	Burst Number	Number of Pulses	Pulse Width [usec]	Chirp Width [MHz]	Pulse 1-to-2 Spacing [usec]	Pulse 2-to-3 Spacing [usec]	Starting Location Within Interval [usec]	Center Frequency [MHz]
17	0	1	66.1	20.0	-	-	31469	5299.8
	1	3	93.6	20.0	1272.4	1259.4	175706	5299.8
	2	1	52.7	20.0	-	-	321783	5299.8
	3	2	72.6	20.0	1924.4	-	465614	5299.8
	4	1	61.7	20.0	-	-	13615	5299.8
	5	3	91.7	20.0	1645.3	1892.3	157872	5299.8
	6	1	65.0	20.0	-	-	304140	5299.8
	7	3	92.6	20.0	1472.4	1009.4	446780	5299.8
	8	1	64.0	20.0	-	-	594088	5299.8
	9	1	50.6	20.0	-	-	140913	5299.8
	10	3	86.2	20.0	1255.8	1775.8	284689	5299.8
	11	1	58.1	20.0	-	-	431544	5299.8
	12	2	67.0	20.0	1527.0	-	574600	5299.8
	13	2	70.6	20.0	1276.4	-	122819	5299.8
	14	2	77.0	20.0	1494.0	-	267317	5299.8
	15	3	99.2	20.0	1530.8	1798.8	410833	5299.8
	16	1	60.2	20.0	-	-	558044	5299.8
	17	1	58.0	20.0	-	-	105090	5299.8
	18	1	50.1	20.0	-	-	250227	5299.8
19	3	98.8	20.0	1726.2	1874.2	392610	5299.8	

Trial #	Burst Number	Number of Pulses	Pulse Width [usec]	Chirp Width [MHz]	Pulse 1-to-2 Spacing [usec]	Pulse 2-to-3 Spacing [usec]	Starting Location Within Interval [usec]	Center Frequency [MHz]
18	0	1	57.9	18.0	-	-	600546	5299.0
	1	1	62.4	18.0	-	-	97012	5299.0
	2	1	52.2	18.0	-	-	258089	5299.0
	3	1	60.5	18.0	-	-	419349	5299.0
	4	3	89.7	18.0	1265.3	1442.3	578429	5299.0
	5	3	92.3	18.0	1050.7	1151.7	76865	5299.0
	6	2	69.4	18.0	1615.6	-	237783	5299.0
	7	2	72.7	18.0	1767.3	-	398619	5299.0
	8	1	60.8	18.0	-	-	561020	5299.0
	9	3	86.9	18.0	1573.1	1718.1	56946	5299.0
	10	1	61.5	18.0	-	-	218455	5299.0
	11	3	90.3	18.0	1806.7	1610.7	377939	5299.0
	12	1	52.5	18.0	-	-	540979	5299.0
	13	1	60.2	18.0	-	-	37360	5299.0
	14	1	58.9	18.0	-	-	198771	5299.0
	15	1	62.1	18.0	-	-	360039	5299.0
	16	3	91.0	18.0	1812.0	1693.0	518609	5299.0
17	2	74.4	18.0	1760.6	-	17428	5299.0	

Trial #	Burst Number	Number of Pulses	Pulse Width [usec]	Chirp Width [MHz]	Pulse 1-to-2 Spacing [usec]	Pulse 2-to-3 Spacing [usec]	Starting Location Within Interval [usec]	Center Frequency [MHz]
19	0	3	99.8	15.0	1394.2	1878.2	200338	5297.8
	1	2	81.8	15.0	1825.2	-	381918	5297.8
	2	3	88.3	15.0	1609.7	1674.7	561303	5297.8
	3	2	71.4	15.0	1573.6	-	744652	5297.8
	4	1	57.0	15.0	-	-	178769	5297.8
	5	1	61.3	15.0	-	-	360349	5297.8
	6	3	92.7	15.0	913.3	1365.3	540083	5297.8
	7	3	89.1	15.0	1261.9	934.9	721359	5297.8
	8	3	92.9	15.0	944.1	1118.1	155992	5297.8
	9	3	94.5	15.0	1244.5	918.5	337118	5297.8
	10	3	89.1	15.0	1578.9	1751.9	517200	5297.8
	11	2	72.6	15.0	1223.4	-	699596	5297.8
	12	3	95.6	15.0	1777.4	1787.4	133517	5297.8
	13	2	78.9	15.0	1299.1	-	315099	5297.8
	14	2	67.4	15.0	1539.6	-	495994	5297.8
15	2	67.5	15.0	1102.5	-	677824	5297.8	

UL Japan, Inc.
Shonan EMC Lab.

1-22-3 Megumigaoka, Hiratsuka-shi, Kanagawa-ken, 259-1220 JAPAN
Telephone : +81 463 50 6400
Facsimile : +81 463 50 6401

Trial #	Burst Number	Number of Pulses	Pulse Width [usec]	Chirp Width [MHz]	Pulse 1-to-2 Spacing [usec]	Pulse 2-to-3 Spacing [usec]	Starting Location Within Interval [usec]	Center Frequency [MHz]
20	0	1	63.2	16.0	-	-	105233	5298.2
	1	1	53.7	16.0	-	-	275969	5298.2
	2	3	91.3	16.0	954.7	938.7	445370	5298.2
	3	3	92.3	16.0	1877.7	1341.7	614260	5298.2
	4	2	83.0	16.0	1846.0	-	83834	5298.2
	5	2	69.5	16.0	1456.5	-	254289	5298.2
	6	2	72.2	16.0	1813.8	-	424692	5298.2
	7	3	92.3	16.0	1045.7	1137.7	594498	5298.2
	8	2	81.8	16.0	1375.2	-	62920	5298.2
	9	2	77.1	16.0	1338.9	-	233373	5298.2
	10	3	89.1	16.0	1385.9	1728.9	403119	5298.2
	11	3	96.0	16.0	1393.0	1365.0	573092	5298.2
	12	1	55.6	16.0	-	-	42019	5298.2
	13	1	56.8	16.0	-	-	212806	5298.2
	14	1	61.7	16.0	-	-	383912	5298.2
	15	1	64.8	16.0	-	-	554421	5298.2
16	1	58.2	16.0	-	-	21001	5298.2	

Trial #	Burst Number	Number of Pulses	Pulse Width [usec]	Chirp Width [MHz]	Pulse 1-to-2 Spacing [usec]	Pulse 2-to-3 Spacing [usec]	Starting Location Within Interval [usec]	Center Frequency [MHz]
21	0	3	85.8	17.0	932.2	1062.2	180660	5301.4
	1	1	58.2	17.0	-	-	342561	5301.4
	2	2	68.4	17.0	1572.6	-	502568	5301.4
	3	1	60.4	17.0	-	-	665330	5301.4
	4	3	86.6	17.0	1640.4	1007.4	160595	5301.4
	5	1	55.3	17.0	-	-	322762	5301.4
	6	3	91.0	17.0	1477.0	1044.0	482293	5301.4
	7	2	67.9	17.0	1632.1	-	643174	5301.4
	8	1	50.5	17.0	-	-	141335	5301.4
	9	3	99.5	17.0	979.5	1711.5	301376	5301.4
	10	2	75.0	17.0	1324.0	-	463127	5301.4
	11	3	83.7	17.0	1326.3	990.3	622573	5301.4
	12	3	88.2	17.0	1536.8	1325.8	120932	5301.4
	13	3	91.3	17.0	1293.7	928.7	281861	5301.4
	14	2	82.7	17.0	1763.3	-	443131	5301.4
	15	2	72.8	17.0	1478.2	-	603782	5301.4
	16	3	85.0	17.0	1313.0	1013.0	101354	5301.4
17	3	97.0	17.0	1152.0	939.0	262036	5301.4	

Trial #	Burst Number	Number of Pulses	Pulse Width [usec]	Chirp Width [MHz]	Pulse 1-to-2 Spacing [usec]	Pulse 2-to-3 Spacing [usec]	Starting Location Within Interval [usec]	Center Frequency [MHz]
22	0	1	55.2	8.0	-	-	764578	5305.0
	1	2	70.8	8.0	1678.2	-	1053414	5305.0
	2	3	98.8	8.0	1042.2	1718.2	146953	5305.0
	3	3	91.4	8.0	912.6	1182.6	437035	5305.0
	4	2	80.3	8.0	1177.7	-	728026	5305.0
	5	1	59.5	8.0	-	-	1019298	5305.0
	6	3	96.1	8.0	1182.9	1718.9	111239	5305.0
	7	3	89.6	8.0	1572.4	1086.4	401222	5305.0
	8	2	80.0	8.0	1523.0	-	692100	5305.0
9	2	72.2	8.0	1320.8	-	982602	5305.0	

Trial #	Burst Number	Number of Pulses	Pulse Width [usec]	Chirp Width [MHz]	Pulse 1-to-2 Spacing [usec]	Pulse 2-to-3 Spacing [usec]	Starting Location Within Interval [usec]	Center Frequency [MHz]
23	0	3	96.8	18.0	1345.2	987.2	39640	5301.0
	1	3	83.5	18.0	1809.5	1866.5	191463	5301.0
	2	3	86.0	18.0	1907.0	1777.0	343373	5301.0
	3	2	82.8	18.0	1419.2	-	497099	5301.0
	4	2	74.2	18.0	1001.8	-	20962	5301.0
	5	1	64.4	18.0	-	-	173912	5301.0
	6	1	59.8	18.0	-	-	326809	5301.0
	7	2	70.6	18.0	1311.4	-	478391	5301.0
	8	3	99.1	18.0	1825.9	1419.9	2171	5301.0
	9	1	57.1	18.0	-	-	155017	5301.0
	10	2	76.7	18.0	1566.3	-	306869	5301.0
	11	3	98.4	18.0	1128.6	1674.6	458321	5301.0
	12	1	50.3	18.0	-	-	613588	5301.0
	13	2	74.4	18.0	1810.6	-	135747	5301.0
	14	2	82.4	18.0	1583.6	-	288077	5301.0
	15	2	70.1	18.0	1704.9	-	440311	5301.0
	16	3	97.3	18.0	967.7	931.7	592453	5301.0
	17	1	58.6	18.0	-	-	117308	5301.0
18	3	93.6	18.0	950.4	1053.4	269234	5301.0	

Trial #	Burst Number	Number of Pulses	Pulse Width [usec]	Chirp Width [MHz]	Pulse 1-to-2 Spacing [usec]	Pulse 2-to-3 Spacing [usec]	Starting Location Within Interval [usec]	Center Frequency [MHz]
24	0	3	85.8	10.0	1540.2	1573.2	668115	5304.2
	1	1	56.4	10.0	-	-	912369	5304.2
	2	2	73.1	10.0	1826.9	-	155876	5304.2
	3	2	70.6	10.0	930.4	-	398107	5304.2
	4	1	59.8	10.0	-	-	640681	5304.2
	5	1	56.4	10.0	-	-	882714	5304.2
	6	3	94.0	10.0	1211.0	1163.0	125976	5304.2
	7	1	59.5	10.0	-	-	368311	5304.2
	8	3	94.5	10.0	916.5	1762.5	609001	5304.2
	9	2	78.0	10.0	1349.0	-	851695	5304.2
	10	1	58.8	10.0	-	-	96518	5304.2
11	1	64.4	10.0	-	-	338510	5304.2	

Trial #	Burst Number	Number of Pulses	Pulse Width [usec]	Chirp Width [MHz]	Pulse 1-to-2 Spacing [usec]	Pulse 2-to-3 Spacing [usec]	Starting Location Within Interval [usec]	Center Frequency [MHz]
25	0	3	97.0	19.0	1751.0	1589.0	364363	5300.6
	1	2	75.3	19.0	1461.7	-	518429	5300.6
	2	2	68.7	19.0	941.3	-	41967	5300.6
	3	2	71.2	19.0	1418.8	-	194274	5300.6
	4	2	67.1	19.0	1906.9	-	346828	5300.6
	5	1	63.4	19.0	-	-	500674	5300.6
	6	3	92.3	19.0	1407.7	1796.7	23124	5300.6
	7	1	59.4	19.0	-	-	176097	5300.6
	8	2	73.8	19.0	1016.2	-	328246	5300.6
	9	2	81.5	19.0	1686.5	-	480564	5300.6
	10	1	62.0	19.0	-	-	4414	5300.6
	11	2	73.7	19.0	1454.3	-	156935	5300.6
	12	2	77.9	19.0	1569.1	-	309299	5300.6
	13	2	70.3	19.0	1315.7	-	461874	5300.6
	14	1	56.8	19.0	-	-	615290	5300.6
	15	2	70.4	19.0	1142.6	-	138199	5300.6
	16	2	74.3	19.0	998.7	-	290837	5300.6
	17	1	58.9	19.0	-	-	443696	5300.6
18	1	60.2	19.0	-	-	597121	5300.6	

Trial #	Burst Number	Number of Pulses	Pulse Width [usec]	Chirp Width [MHz]	Pulse 1-to-2 Spacing [usec]	Pulse 2-to-3 Spacing [usec]	Starting Location Within Interval [usec]	Center Frequency [MHz]
26	0	1	62.3	9.0	-	-	206751	5304.6
	1	3	87.4	9.0	1904.6	979.6	469550	5304.6
	2	3	96.0	9.0	1012.0	1648.0	733253	5304.6
	3	3	94.3	9.0	1284.7	1159.7	997356	5304.6
	4	1	65.8	9.0	-	-	174248	5304.6
	5	2	73.6	9.0	1698.4	-	437665	5304.6
	6	1	62.8	9.0	-	-	702905	5304.6
	7	2	76.1	9.0	1567.9	-	965514	5304.6
	8	2	76.3	9.0	1323.7	-	141532	5304.6
	9	2	80.2	9.0	1669.8	-	405305	5304.6
10	1	54.9	9.0	-	-	670016	5304.6	

Trial #	Burst Number	Number of Pulses	Pulse Width [usec]	Chirp Width [MHz]	Pulse 1-to-2 Spacing [usec]	Pulse 2-to-3 Spacing [usec]	Starting Location Within Interval [usec]	Center Frequency [MHz]
27	0	1	65.3	13.0	-	-	684631	5303.0
	1	3	92.7	13.0	1019.3	1199.3	79735	5303.0
	2	3	90.2	13.0	1070.8	1478.8	272776	5303.0
	3	3	92.7	13.0	1263.3	1763.3	465352	5303.0
	4	2	79.8	13.0	1113.2	-	659815	5303.0
	5	2	73.1	13.0	1723.9	-	56031	5303.0
	6	2	81.7	13.0	1181.3	-	249332	5303.0
	7	1	53.2	13.0	-	-	443443	5303.0
	8	1	65.3	13.0	-	-	637352	5303.0
	9	1	56.6	13.0	-	-	32263	5303.0
	10	1	55.0	13.0	-	-	225899	5303.0
	11	3	99.3	13.0	1175.7	1202.7	418022	5303.0
	12	2	69.8	13.0	1858.2	-	611741	5303.0
	13	1	54.2	13.0	-	-	8420	5303.0
14	3	94.4	13.0	1390.6	1521.6	201352	5303.0	

Trial #	Burst Number	Number of Pulses	Pulse Width [usec]	Chirp Width [MHz]	Pulse 1-to-2 Spacing [usec]	Pulse 2-to-3 Spacing [usec]	Starting Location Within Interval [usec]	Center Frequency [MHz]
28	0	3	99.5	14.0	1217.5	1811.5	394064	5302.6
	1	3	92.7	14.0	1418.3	1124.3	587421	5302.6
	2	3	89.6	14.0	1156.4	1714.4	780341	5302.6
	3	3	99.7	14.0	1218.3	1860.3	177415	5302.6
	4	2	73.5	14.0	1402.5	-	371288	5302.6
	5	3	85.2	14.0	1774.8	1781.8	563160	5302.6
	6	3	85.5	14.0	1676.5	1190.5	756177	5302.6
	7	2	67.7	14.0	1648.3	-	154031	5302.6
	8	3	96.6	14.0	1492.4	1155.4	346819	5302.6
	9	2	77.1	14.0	1267.9	-	540628	5302.6
	10	1	50.9	14.0	-	-	735227	5302.6
	11	2	81.1	14.0	1090.9	-	130275	5302.6
	12	1	52.8	14.0	-	-	324161	5302.6
	13	3	97.6	14.0	1859.4	949.4	516155	5302.6
14	1	54.2	14.0	-	-	711293	5302.6	

UL Japan, Inc.

Shonan EMC Lab.

1-22-3 Megumigaoka, Hiratsuka-shi, Kanagawa-ken, 259-1220 JAPAN

Telephone : +81 463 50 6400

Facsimile : +81 463 50 6401

Trial #	Burst Number	Number of Pulses	Pulse Width [usec]	Chirp Width [MHz]	Pulse 1-to-2 Spacing [usec]	Pulse 2-to-3 Spacing [usec]	Starting Location Within Interval [usec]	Center Frequency [MHz]
29	0	3	87.3	6.0	1356.7	1334.7	177556	5305.8
	1	1	65.9	6.0	-	-	500881	5305.8
	2	2	79.3	6.0	1686.7	-	822733	5305.8
	3	2	68.9	6.0	983.1	-	1146197	5305.8
	4	1	66.2	6.0	-	-	138110	5305.8
	5	2	69.4	6.0	1610.6	-	460385	5305.8
	6	3	83.5	6.0	1860.5	1620.5	781909	5305.8
	7	3	85.3	6.0	1263.7	1431.7	1104427	5305.8
8	3	90.5	6.0	1462.5	925.5	98129	5305.8	

Trial #	Burst Number	Number of Pulses	Pulse Width [usec]	Chirp Width [MHz]	Pulse 1-to-2 Spacing [usec]	Pulse 2-to-3 Spacing [usec]	Starting Location Within Interval [usec]	Center Frequency [MHz]
30	0	3	83.8	6.0	1293.2	1604.2	472995	5305.8
	1	3	88.8	6.0	1668.2	1485.2	835800	5305.8
	2	2	71.1	6.0	1288.9	-	1199742	5305.8
	3	3	93.7	6.0	1312.3	1822.3	65713	5305.8
	4	1	53.6	6.0	-	-	429256	5305.8
	5	1	57.2	6.0	-	-	792584	5305.8
	6	3	88.1	6.0	936.9	946.9	1154438	5305.8
	7	2	76.2	6.0	1556.8	-	21066	5305.8

Parameter Data sheet for Radar Type 5

5310 MHz (11n-40)

Trial #	Burst Number	Number of Pulses	Pulse Width [us]	Chirp Width [MHz]	Pulse 1-to-2 Spacing [us]	Pulse 2-to-3 Spacing [us]	Starting Location Within Interval [us]	Center Frequency[MHz]
1	0	1	52.5	5.0	-	-	438822	5310
	1	3	100.0	5.0	1574.0	1764.0	800428	5310
	2	1	55.4	5.0	-	-	1165740	5310
	3	2	69.4	5.0	1277.6	-	30471	5310
	4	2	69.0	5.0	986.0	-	393582	5310
	5	1	55.9	5.0	-	-	757405	5310
	6	2	73.0	5.0	1775.0	-	1119060	5310
	7	1	63.5	5.0	-	-	1484263	5310

Trial #	Burst Number	Number of Pulses	Pulse Width [us]	Chirp Width [MHz]	Pulse 1-to-2 Spacing [us]	Pulse 2-to-3 Spacing [us]	Starting Location Within Interval [us]	Center Frequency[MHz]
2	0	3	83.5	20.0	1076.5	965.5	138861	5310
	1	2	80.8	20.0	1366.2	-	284063	5310
	2	1	65.5	20.0	-	-	430056	5310
	3	1	65.6	20.0	-	-	575251	5310
	4	2	73.3	20.0	1660.7	-	121223	5310
	5	3	95.3	20.0	1794.7	1707.7	265214	5310
	6	2	78.8	20.0	1054.2	-	411258	5310
	7	3	92.4	20.0	1013.6	1816.6	554338	5310
	8	2	78.0	20.0	1893.0	-	103282	5310
	9	1	59.8	20.0	-	-	248811	5310
	10	2	80.0	20.0	1636.0	-	392971	5310
	11	2	66.7	20.0	1179.3	-	538316	5310
	12	2	83.3	20.0	975.7	-	85674	5310
	13	3	97.9	20.0	1194.1	1661.1	229640	5310
	14	3	84.5	20.0	1514.5	1254.5	374520	5310
	15	3	98.4	20.0	1604.6	1129.6	518804	5310
	16	3	90.0	20.0	1252.0	1279.0	67640	5310
	17	2	82.8	20.0	1028.2	-	212818	5310
	18	3	84.9	20.0	1069.1	1755.1	356288	5310
19	3	97.3	20.0	1216.7	1098.7	501373	5310	

Trial #	Burst Number	Number of Pulses	Pulse Width [us]	Chirp Width [MHz]	Pulse 1-to-2 Spacing [us]	Pulse 2-to-3 Spacing [us]	Starting Location Within Interval [us]	Center Frequency[MHz]
3	0	3	92.5	6.0	1030.5	1308.5	111196	5310
	1	1	62.9	6.0	-	-	434339	5310
	2	3	93.7	6.0	1059.3	1624.3	755579	5310
	3	2	77.2	6.0	1621.8	-	1078905	5310
	4	2	67.2	6.0	1549.8	-	71539	5310
	5	1	59.6	6.0	-	-	394727	5310
	6	3	95.4	6.0	1543.6	1026.6	715891	5310
	7	2	76.8	6.0	1214.2	-	1039667	5310
	8	1	55.6	6.0	-	-	31835	5310

UL Japan, Inc.

Shonan EMC Lab.

1-22-3 Megumigaoka, Hiratsuka-shi, Kanagawa-ken, 259-1220 JAPAN

Telephone : +81 463 50 6400

Facsimile : +81 463 50 6401

Trial #	Burst Number	Number of Pulses	Pulse Width [us]	Chirp Width [MHz]	Pulse 1-to-2 Spacing [us]	Pulse 2-to-3 Spacing [us]	Starting Location Within Interval [us]	Center Frequency [MHz]
4	0	1	52.6	11.0	-	-	245484	5310
	1	1	58.7	11.0	-	-	469270	5310
	2	2	71.1	11.0	1617.9	-	691046	5310
	3	2	78.0	11.0	1200.0	-	914520	5310
	4	1	60.1	11.0	-	-	218099	5310
	5	3	84.0	11.0	1523.0	1371.0	439865	5310
	6	1	63.8	11.0	-	-	664968	5310
	7	2	76.3	11.0	1108.7	-	887631	5310
	8	1	55.8	11.0	-	-	190386	5310
	9	3	86.7	11.0	1065.3	1082.3	412889	5310
	10	2	70.9	11.0	1421.1	-	636718	5310
	11	3	94.6	11.0	1344.4	1568.4	857795	5310
12	3	98.4	11.0	1685.6	1634.6	162277	5310	

Trial #	Burst Number	Number of Pulses	Pulse Width [us]	Chirp Width [MHz]	Pulse 1-to-2 Spacing [us]	Pulse 2-to-3 Spacing [us]	Starting Location Within Interval [us]	Center Frequency [MHz]
5	0	3	91.9	11.0	1027.1	1198.1	417708	5310
	1	3	97.3	11.0	1204.7	1334.7	659081	5310
	2	3	85.4	11.0	1662.6	1268.6	900457	5310
	3	3	86.5	11.0	1349.5	1749.5	146245	5310
	4	1	55.8	11.0	-	-	388995	5310
	5	1	54.7	11.0	-	-	631160	5310
	6	1	65.5	11.0	-	-	873285	5310
	7	1	57.1	11.0	-	-	116842	5310
	8	2	79.5	11.0	1282.5	-	358379	5310
	9	3	86.3	11.0	1416.7	1400.7	599141	5310
	10	2	71.0	11.0	1548.0	-	842332	5310
11	2	75.7	11.0	1340.3	-	86933	5310	

Trial #	Burst Number	Number of Pulses	Pulse Width [us]	Chirp Width [MHz]	Pulse 1-to-2 Spacing [us]	Pulse 2-to-3 Spacing [us]	Starting Location Within Interval [us]	Center Frequency [MHz]
6	0	2	71.1	6.0	1782.9	-	438502	5310
	1	2	70.5	6.0	1138.5	-	761675	5310
	2	3	87.2	6.0	1071.8	1401.8	1082894	5310
	3	3	88.4	6.0	1469.6	1187.6	76152	5310
	4	3	98.5	6.0	985.5	983.5	398781	5310
	5	1	63.6	6.0	-	-	722537	5310
	6	3	100.0	6.0	1888.0	1677.0	1042519	5310
	7	1	51.9	6.0	-	-	36539	5310
8	3	86.7	6.0	1718.3	1876.3	358565	5310	

Trial #	Burst Number	Number of Pulses	Pulse Width [us]	Chirp Width [MHz]	Pulse 1-to-2 Spacing [us]	Pulse 2-to-3 Spacing [us]	Starting Location Within Interval [us]	Center Frequency [MHz]
7	0	2	75.4	12.0	1219.6	-	471492	5310
	1	1	51.0	12.0	-	-	695446	5310
	2	1	58.8	12.0	-	-	919478	5310
	3	3	88.7	12.0	977.3	1262.3	220721	5310
	4	2	73.2	12.0	1753.8	-	443687	5310
	5	1	63.8	12.0	-	-	667935	5310
	6	2	70.7	12.0	1156.3	-	890128	5310
	7	2	72.0	12.0	1162.0	-	193426	5310
	8	3	84.1	12.0	1619.9	1723.9	415687	5310
	9	3	96.1	12.0	1506.9	999.9	638825	5310
	10	1	63.9	12.0	-	-	864179	5310
	11	1	52.7	12.0	-	-	166114	5310
12	3	94.1	12.0	1749.9	931.9	388609	5310	

Trial #	Burst Number	Number of Pulses	Pulse Width [us]	Chirp Width [MHz]	Pulse 1-to-2 Spacing [us]	Pulse 2-to-3 Spacing [us]	Starting Location Within Interval [us]	Center Frequency [MHz]
8	0	2	71.1	9.0	1085.9	-	723872	5310
	1	3	96.4	9.0	1341.6	1471.6	986112	5310
	2	3	91.8	9.0	1197.2	1790.2	163449	5310
	3	2	80.7	9.0	1223.3	-	427524	5310
	4	1	53.7	9.0	-	-	692507	5310
	5	3	90.6	9.0	969.4	1670.4	954501	5310
	6	1	61.3	9.0	-	-	131354	5310
	7	3	98.6	9.0	1900.4	1176.4	394387	5310
	8	2	73.2	9.0	1272.8	-	658721	5310
	9	2	72.5	9.0	1207.5	-	922964	5310
10	1	50.0	9.0	-	-	98839	5310	

Trial #	Burst Number	Number of Pulses	Pulse Width [us]	Chirp Width [MHz]	Pulse 1-to-2 Spacing [us]	Pulse 2-to-3 Spacing [us]	Starting Location Within Interval [us]	Center Frequency [MHz]
9	0	1	52.2	15.0	-	-	249477	5310
	1	3	89.0	15.0	1135.0	1236.0	429261	5310
	2	1	63.4	15.0	-	-	612354	5310
	3	2	76.6	15.0	1590.4	-	45447	5310
	4	3	88.0	15.0	1670.0	987.0	226086	5310
	5	1	57.4	15.0	-	-	408820	5310
	6	2	73.0	15.0	1453.0	-	588655	5310
	7	2	71.0	15.0	1442.0	-	23129	5310
	8	3	92.7	15.0	1368.3	1717.3	203778	5310
	9	1	61.6	15.0	-	-	386051	5310
	10	1	66.5	15.0	-	-	567598	5310
	11	3	96.2	15.0	912.8	1389.8	817	5310
	12	2	76.5	15.0	1752.5	-	181792	5310
	13	3	97.8	15.0	1238.2	1097.2	362720	5310
	14	2	82.6	15.0	1674.4	-	544237	5310
15	3	90.9	15.0	1000.1	1335.1	724175	5310	

Trial #	Burst Number	Number of Pulses	Pulse Width [us]	Chirp Width [MHz]	Pulse 1-to-2 Spacing [us]	Pulse 2-to-3 Spacing [us]	Starting Location Within Interval [us]	Center Frequency[MHz]
10	0	3	94.8	14.0	1558.2	1249.2	159369	5310
	1	3	85.1	14.0	1736.9	1515.9	340115	5310
	2	3	95.4	14.0	1497.6	1563.6	520774	5310
	3	3	90.2	14.0	1550.8	1806.8	701654	5310
	4	1	57.1	14.0	-	-	137552	5310
	5	2	73.0	14.0	1773.0	-	318584	5310
	6	2	77.1	14.0	1616.9	-	499642	5310
	7	3	99.5	14.0	1024.5	910.5	680622	5310
	8	3	90.8	14.0	998.2	1881.2	114842	5310
	9	3	96.6	14.0	946.4	975.4	295799	5310
	10	2	67.7	14.0	1692.3	-	476995	5310
	11	1	59.9	14.0	-	-	659850	5310
	12	1	59.3	14.0	-	-	92910	5310
	13	3	90.6	14.0	985.4	1220.4	273638	5310
	14	3	88.2	14.0	1813.8	1702.8	453972	5310
15	1	52.1	14.0	-	-	637842	5310	

Trial #	Burst Number	Number of Pulses	Pulse Width [usec]	Chirp Width [MHz]	Pulse 1-to-2 Spacing [usec]	Pulse 2-to-3 Spacing [usec]	Starting Location Within Interval [usec]	Center Frequency[MHz]
11	0	2	78.6	9.0	1651.4	-	93998	5295.5
	1	1	58.8	9.0	-	-	336285	5295.5
	2	3	86.4	9.0	1796.6	1818.6	575993	5295.5
	3	3	84.3	9.0	1664.7	986.7	818432	5295.5
	4	1	50.4	9.0	-	-	64272	5295.5
	5	3	94.1	9.0	1455.9	955.9	305754	5295.5
	6	3	84.0	9.0	1621.0	1913.0	546657	5295.5
	7	2	76.7	9.0	1794.3	-	789638	5295.5
	8	2	73.1	9.0	988.9	-	34431	5295.5
	9	3	93.0	9.0	1215.0	1521.0	275775	5295.5
	10	1	60.1	9.0	-	-	518603	5295.5
11	2	82.4	9.0	1339.6	-	760014	5295.5	

Trial #	Burst Number	Number of Pulses	Pulse Width [usec]	Chirp Width [MHz]	Pulse 1-to-2 Spacing [usec]	Pulse 2-to-3 Spacing [usec]	Starting Location Within Interval [usec]	Center Frequency[MHz]
12	0	1	54.6	10.0	-	-	4626	5295.9
	1	1	50.2	10.0	-	-	246803	5295.9
	2	1	65.2	10.0	-	-	488985	5295.9
	3	2	83.0	10.0	1487.0	-	729882	5295.9
	4	2	71.1	10.0	1802.9	-	971209	5295.9
	5	3	99.8	10.0	1752.2	1554.2	216164	5295.9
	6	1	66.6	10.0	-	-	459177	5295.9
	7	1	63.4	10.0	-	-	701004	5295.9
	8	2	77.9	10.0	1382.1	-	942427	5295.9
	9	2	82.4	10.0	1398.6	-	186943	5295.9
	10	3	92.9	10.0	910.1	1886.1	428147	5295.9
11	2	79.3	10.0	1203.7	-	670833	5295.9	

UL Japan, Inc.

Shonan EMC Lab.

1-22-3 Megumigaoka, Hiratsuka-shi, Kanagawa-ken, 259-1220 JAPAN

Telephone : +81 463 50 6400

Facsimile : +81 463 50 6401

Trial #	Burst Number	Number of Pulses	Pulse Width [usec]	Chirp Width [MHz]	Pulse 1-to-2 Spacing [usec]	Pulse 2-to-3 Spacing [usec]	Starting Location Within Interval [usec]	Center Frequency [MHz]
13	0	1	61.9	12.0	-	-	782886	5296.7
	1	1	64.0	12.0	-	-	134855	5296.7
	2	3	85.9	12.0	1716.1	1153.1	341183	5296.7
	3	3	91.4	12.0	1676.6	1796.6	547501	5296.7
	4	3	89.7	12.0	1766.3	1210.3	754480	5296.7
	5	1	63.1	12.0	-	-	109251	5296.7
	6	1	61.6	12.0	-	-	316902	5296.7
	7	1	52.0	12.0	-	-	524465	5296.7
	8	2	73.5	12.0	1662.5	-	730142	5296.7
	9	1	64.3	12.0	-	-	83707	5296.7
	10	2	67.5	12.0	1495.5	-	290686	5296.7
	11	2	67.7	12.0	983.3	-	498385	5296.7
	12	1	61.3	12.0	-	-	706314	5296.7
13	3	98.4	12.0	932.6	1867.6	57940	5296.7	

Trial #	Burst Number	Number of Pulses	Pulse Width [usec]	Chirp Width [MHz]	Pulse 1-to-2 Spacing [usec]	Pulse 2-to-3 Spacing [usec]	Starting Location Within Interval [usec]	Center Frequency [MHz]
14	0	3	90.4	19.0	1161.6	1754.6	194500	5299.5
	1	1	50.7	19.0	-	-	348642	5299.5
	2	1	51.1	19.0	-	-	501312	5299.5
	3	2	68.6	19.0	1706.4	-	23906	5299.5
	4	2	67.1	19.0	1241.9	-	176424	5299.5
	5	1	64.2	19.0	-	-	329782	5299.5
	6	1	62.8	19.0	-	-	482625	5299.5
	7	3	94.7	19.0	1417.3	1348.3	5124	5299.5
	8	3	94.9	19.0	983.1	1622.1	157256	5299.5
	9	3	90.6	19.0	1542.4	1703.4	309112	5299.5
	10	2	81.3	19.0	1649.7	-	462433	5299.5
	11	3	84.7	19.0	1667.3	1141.3	613805	5299.5
	12	3	88.8	19.0	1634.2	1735.2	138247	5299.5
	13	1	59.5	19.0	-	-	291799	5299.5
	14	2	74.0	19.0	1149.0	-	443560	5299.5
	15	2	74.7	19.0	1290.3	-	596248	5299.5
	16	2	74.3	19.0	1821.7	-	119942	5299.5
	17	3	96.3	19.0	1493.7	911.7	271910	5299.5
18	1	65.9	19.0	-	-	425701	5299.5	

Trial #	Burst Number	Number of Pulses	Pulse Width [usec]	Chirp Width [MHz]	Pulse 1-to-2 Spacing [usec]	Pulse 2-to-3 Spacing [usec]	Starting Location Within Interval [usec]	Center Frequency [MHz]
15	0	1	57.1	14.0	-	-	733099	5297.5
	1	2	72.3	14.0	1314.7	-	128334	5297.5
	2	3	86.5	14.0	1055.5	1551.5	320993	5297.5
	3	1	58.2	14.0	-	-	516097	5297.5
	4	3	92.6	14.0	1156.4	1534.4	706966	5297.5
	5	3	87.1	14.0	1430.9	1400.9	104340	5297.5
	6	1	59.9	14.0	-	-	298410	5297.5
	7	2	81.3	14.0	1346.7	-	491429	5297.5
	8	1	58.0	14.0	-	-	685751	5297.5
	9	1	58.9	14.0	-	-	80897	5297.5
	10	3	90.3	14.0	945.7	1599.7	273493	5297.5
	11	2	82.7	14.0	1593.3	-	467415	5297.5
	12	3	97.6	14.0	1640.4	1317.4	659522	5297.5
	13	2	71.7	14.0	1197.3	-	56933	5297.5
14	2	72.8	14.0	1028.2	-	250450	5297.5	

Trial #	Burst Number	Number of Pulses	Pulse Width [usec]	Chirp Width [MHz]	Pulse 1-to-2 Spacing [usec]	Pulse 2-to-3 Spacing [usec]	Starting Location Within Interval [usec]	Center Frequency [MHz]
16	0	1	59.3	18.0	-	-	350719	5299.1
	1	1	65.9	18.0	-	-	503225	5299.1
	2	1	62.3	18.0	-	-	26195	5299.1
	3	1	59.2	18.0	-	-	179014	5299.1
	4	1	65.2	18.0	-	-	331795	5299.1
	5	2	78.7	18.0	1304.3	-	483489	5299.1
	6	1	66.5	18.0	-	-	7374	5299.1
	7	2	67.3	18.0	1400.7	-	159898	5299.1
	8	2	69.1	18.0	1444.9	-	312045	5299.1
	9	3	95.4	18.0	1284.6	1863.6	463145	5299.1
	10	1	60.1	18.0	-	-	618333	5299.1
	11	1	54.9	18.0	-	-	141409	5299.1
	12	2	74.4	18.0	1075.6	-	293775	5299.1
	13	1	52.0	18.0	-	-	447150	5299.1
	14	2	78.0	18.0	1641.0	-	598548	5299.1
	15	3	98.8	18.0	1682.2	1674.2	121795	5299.1
	16	3	90.1	18.0	1909.9	1452.9	273607	5299.1
	17	2	71.3	18.0	1480.7	-	427272	5299.1
18	1	51.7	18.0	-	-	581396	5299.1	

Trial #	Burst Number	Number of Pulses	Pulse Width [usec]	Chirp Width [MHz]	Pulse 1-to-2 Spacing [usec]	Pulse 2-to-3 Spacing [usec]	Starting Location Within Interval [usec]	Center Frequency [MHz]
17	0	1	54.2	13.0	-	-	131483	5297.1
	1	2	76.0	13.0	1529.0	-	324502	5297.1
	2	1	53.9	13.0	-	-	519089	5297.1
	3	3	92.5	13.0	1499.5	1234.5	710214	5297.1
	4	1	58.5	13.0	-	-	107567	5297.1
	5	2	81.6	13.0	1522.4	-	300715	5297.1
	6	1	57.1	13.0	-	-	495195	5297.1
	7	2	83.0	13.0	1082.0	-	687712	5297.1
	8	1	54.7	13.0	-	-	83768	5297.1
	9	3	85.7	13.0	1657.3	1295.3	276167	5297.1
	10	1	54.5	13.0	-	-	471313	5297.1
	11	1	57.8	13.0	-	-	664891	5297.1
	12	3	83.8	13.0	1816.2	1744.2	59575	5297.1
	13	1	63.0	13.0	-	-	253577	5297.1
14	1	65.9	13.0	-	-	447084	5297.1	

Trial #	Burst Number	Number of Pulses	Pulse Width [usec]	Chirp Width [MHz]	Pulse 1-to-2 Spacing [usec]	Pulse 2-to-3 Spacing [usec]	Starting Location Within Interval [usec]	Center Frequency [MHz]
18	0	1	50.2	8.0	-	-	961547	5295.1
	1	1	58.1	8.0	-	-	54089	5295.1
	2	1	62.4	8.0	-	-	344687	5295.1
	3	1	65.1	8.0	-	-	635452	5295.1
	4	2	81.0	8.0	1881.0	-	924463	5295.1
	5	3	87.3	8.0	1746.7	1708.7	18213	5295.1
	6	3	90.7	8.0	1672.3	1252.3	308126	5295.1
	7	1	55.0	8.0	-	-	599737	5295.1
	8	2	67.3	8.0	1384.7	-	889010	5295.1
9	1	62.9	8.0	-	-	1181114	5295.1	

Trial #	Burst Number	Number of Pulses	Pulse Width [usec]	Chirp Width [MHz]	Pulse 1-to-2 Spacing [usec]	Pulse 2-to-3 Spacing [usec]	Starting Location Within Interval [usec]	Center Frequency [MHz]
19	0	2	82.5	14.0	1482.5	-	181566	5297.5
	1	2	82.1	14.0	1395.9	-	375027	5297.5
	2	3	85.5	14.0	1394.5	1115.5	567716	5297.5
	3	2	79.2	14.0	1003.8	-	761723	5297.5
	4	2	80.1	14.0	1252.9	-	157854	5297.5
	5	1	60.2	14.0	-	-	351911	5297.5
	6	1	50.2	14.0	-	-	545505	5297.5
	7	1	61.4	14.0	-	-	739276	5297.5
	8	3	95.9	14.0	1264.1	1746.1	133708	5297.5
	9	2	67.5	14.0	1556.5	-	327130	5297.5
	10	3	96.8	14.0	1351.2	1894.2	519547	5297.5
	11	1	55.4	14.0	-	-	715679	5297.5
	12	2	73.4	14.0	1854.6	-	110098	5297.5
	13	1	53.7	14.0	-	-	303990	5297.5
14	2	77.6	14.0	1133.4	-	497030	5297.5	

Trial #	Burst Number	Number of Pulses	Pulse Width [usec]	Chirp Width [MHz]	Pulse 1-to-2 Spacing [usec]	Pulse 2-to-3 Spacing [usec]	Starting Location Within Interval [usec]	Center Frequency [MHz]
20	0	1	58.1	10.0	-	-	864238	5295.9
	1	3	95.7	10.0	1492.3	1331.3	107939	5295.9
	2	1	61.7	10.0	-	-	350253	5295.9
	3	2	81.6	10.0	1105.4	-	591872	5295.9
	4	1	64.6	10.0	-	-	834743	5295.9
	5	3	87.5	10.0	1457.5	1030.5	78176	5295.9
	6	2	76.3	10.0	1592.7	-	320201	5295.9
	7	3	92.0	10.0	960.0	1005.0	561356	5295.9
	8	1	58.4	10.0	-	-	804526	5295.9
	9	1	51.8	10.0	-	-	48570	5295.9
	10	2	69.9	10.0	1437.1	-	290322	5295.9
11	3	86.3	10.0	1779.7	1099.7	531360	5295.9	

Trial #	Burst Number	Number of Pulses	Pulse Width [usec]	Chirp Width [MHz]	Pulse 1-to-2 Spacing [usec]	Pulse 2-to-3 Spacing [usec]	Starting Location Within Interval [usec]	Center Frequency [MHz]
21	0	2	74.9	15.0	1778.1	-	579723	5322.1
	1	3	90.3	15.0	1592.7	1150.7	13993	5322.1
	2	1	64.4	15.0	-	-	195514	5322.1
	3	1	63.6	15.0	-	-	377312	5322.1
	4	2	71.0	15.0	1259.0	-	557503	5322.1
	5	3	86.7	15.0	1359.3	1668.3	736837	5322.1
	6	2	79.6	15.0	1601.4	-	172733	5322.1
	7	2	76.0	15.0	1418.0	-	353907	5322.1
	8	3	99.5	15.0	1549.5	1530.5	533925	5322.1
	9	2	71.6	15.0	1912.4	-	716347	5322.1
	10	1	53.7	15.0	-	-	150845	5322.1
	11	2	74.7	15.0	1586.3	-	331641	5322.1
	12	2	75.5	15.0	1509.5	-	512580	5322.1
	13	1	54.3	15.0	-	-	695793	5322.1
	14	3	96.5	15.0	1840.5	1262.5	127925	5322.1
15	3	88.0	15.0	1912.0	1416.0	308509	5322.1	

Trial #	Burst Number	Number of Pulses	Pulse Width [usec]	Chirp Width [MHz]	Pulse 1-to-2 Spacing [usec]	Pulse 2-to-3 Spacing [usec]	Starting Location Within Interval [usec]	Center Frequency [MHz]
22	0	3	95.5	20.0	1526.5	1666.5	390789	5320.1
	1	2	69.2	20.0	1015.8	-	537176	5320.1
	2	3	94.8	20.0	1830.2	1170.2	84489	5320.1
	3	3	84.8	20.0	1810.2	1686.2	228634	5320.1
	4	1	58.6	20.0	-	-	374914	5320.1
	5	3	87.5	20.0	1508.5	1155.5	518271	5320.1
	6	2	72.9	20.0	1647.1	-	66794	5320.1
	7	3	91.7	20.0	1444.3	1016.3	211320	5320.1
	8	2	78.9	20.0	1151.1	-	356695	5320.1
	9	2	73.5	20.0	1092.5	-	501121	5320.1
	10	1	52.7	20.0	-	-	49152	5320.1
	11	2	75.4	20.0	1247.6	-	193733	5320.1
	12	1	56.2	20.0	-	-	339454	5320.1
	13	3	90.2	20.0	1820.8	1813.8	481229	5320.1
	14	2	77.0	20.0	1140.0	-	31183	5320.1
	15	2	77.4	20.0	1715.6	-	175913	5320.1
	16	1	60.1	20.0	-	-	321569	5320.1
	17	2	73.9	20.0	1435.1	-	465806	5320.1
	18	2	75.3	20.0	1280.7	-	13333	5320.1
19	2	71.1	20.0	1805.9	-	157919	5320.1	

Trial #	Burst Number	Number of Pulses	Pulse Width [usec]	Chirp Width [MHz]	Pulse 1-to-2 Spacing [usec]	Pulse 2-to-3 Spacing [usec]	Starting Location Within Interval [usec]	Center Frequency [MHz]
23	0	2	81.4	16.0	1819.6	-	378854	5321.7
	1	1	53.9	16.0	-	-	561574	5321.7
	2	2	75.8	16.0	1378.2	-	741666	5321.7
	3	2	68.8	16.0	1824.2	-	175516	5321.7
	4	3	93.8	16.0	1090.2	1052.2	356274	5321.7
	5	2	77.7	16.0	951.3	-	537896	5321.7
	6	2	78.1	16.0	1266.9	-	719106	5321.7
	7	3	86.5	16.0	1845.5	1780.5	152737	5321.7
	8	3	92.0	16.0	1695.0	1682.0	333673	5321.7
	9	3	87.0	16.0	920.0	926.0	515396	5321.7
	10	1	56.0	16.0	-	-	697768	5321.7
	11	1	60.2	16.0	-	-	131094	5321.7
	12	3	91.1	16.0	1784.9	1029.9	311499	5321.7
	13	3	88.4	16.0	1342.6	1340.6	492297	5321.7
	14	3	96.5	16.0	1352.5	1208.5	673443	5321.7
15	3	89.3	16.0	963.7	1791.7	108387	5321.7	

UL Japan, Inc.

Shonan EMC Lab.

1-22-3 Megumigaoka, Hiratsuka-shi, Kanagawa-ken, 259-1220 JAPAN

Telephone : +81 463 50 6400

Facsimile : +81 463 50 6401

Trial #	Burst Number	Number of Pulses	Pulse Width [usec]	Chirp Width [MHz]	Pulse 1-to-2 Spacing [usec]	Pulse 2-to-3 Spacing [usec]	Starting Location Within Interval [usec]	Center Frequency [MHz]
24	0	1	57.0	20.0	-	-	232117	5320.1
	1	3	85.2	20.0	1387.8	946.8	375943	5320.1
	2	2	77.6	20.0	1568.4	-	520769	5320.1
	3	3	87.4	20.0	1797.6	1580.6	68753	5320.1
	4	2	67.4	20.0	1504.6	-	213778	5320.1
	5	2	72.8	20.0	1884.2	-	358236	5320.1
	6	3	84.7	20.0	953.3	1256.3	502881	5320.1
	7	3	97.5	20.0	1305.5	1655.5	50983	5320.1
	8	3	83.9	20.0	1132.1	1190.1	195437	5320.1
	9	1	54.1	20.0	-	-	341505	5320.1
	10	2	69.8	20.0	1233.2	-	485494	5320.1
	11	1	59.3	20.0	-	-	33332	5320.1
	12	3	94.6	20.0	1082.4	1804.4	177455	5320.1
	13	2	76.4	20.0	1163.6	-	322777	5320.1
	14	1	64.6	20.0	-	-	468688	5320.1
	15	1	51.6	20.0	-	-	15462	5320.1
	16	2	79.0	20.0	1581.0	-	160166	5320.1
	17	2	75.4	20.0	1130.6	-	304935	5320.1
	18	1	56.5	20.0	-	-	450603	5320.1
19	3	91.6	20.0	1404.4	1206.4	593301	5320.1	

Trial #	Burst Number	Number of Pulses	Pulse Width [usec]	Chirp Width [MHz]	Pulse 1-to-2 Spacing [usec]	Pulse 2-to-3 Spacing [usec]	Starting Location Within Interval [usec]	Center Frequency [MHz]
25	0	3	93.4	17.0	1899.6	1612.6	157653	5321.3
	1	2	76.0	17.0	1735.0	-	319169	5321.3
	2	3	91.0	17.0	1446.0	1535.0	479223	5321.3
	3	2	81.0	17.0	1470.0	-	641048	5321.3
	4	1	59.4	17.0	-	-	138738	5321.3
	5	3	86.4	17.0	913.6	1000.6	299167	5321.3
	6	3	99.8	17.0	1536.2	1312.2	459316	5321.3
	7	3	92.0	17.0	1239.0	1423.0	619861	5321.3
	8	2	67.4	17.0	1289.6	-	118735	5321.3
	9	3	92.5	17.0	1842.5	1398.5	278712	5321.3
	10	3	84.4	17.0	1243.6	1549.6	439388	5321.3
	11	2	67.8	17.0	971.2	-	601526	5321.3
	12	3	93.8	17.0	1068.2	1005.2	98732	5321.3
	13	3	87.8	17.0	1317.2	1026.2	259277	5321.3
	14	2	70.3	17.0	1577.7	-	420798	5321.3
	15	2	75.0	17.0	1105.0	-	582369	5321.3
	16	3	96.3	17.0	1327.7	1635.7	78760	5321.3
17	3	87.9	17.0	1769.1	1417.1	239423	5321.3	

UL Japan, Inc.

Shonan EMC Lab.

1-22-3 Megumigaoka, Hiratsuka-shi, Kanagawa-ken, 259-1220 JAPAN

Telephone : +81 463 50 6400

Facsimile : +81 463 50 6401

Trial #	Burst Number	Number of Pulses	Pulse Width [usec]	Chirp Width [MHz]	Pulse 1-to-2 Spacing [usec]	Pulse 2-to-3 Spacing [usec]	Starting Location Within Interval [usec]	Center Frequency [MHz]
26	0	1	53.6	15.0	-	-	452123	5322.1
	1	1	58.6	15.0	-	-	633984	5322.1
	2	2	69.3	15.0	1130.7	-	66652	5322.1
	3	2	78.3	15.0	1519.7	-	247601	5322.1
	4	3	84.9	15.0	1560.1	1323.1	428159	5322.1
	5	3	89.7	15.0	1030.3	1442.3	609411	5322.1
	6	1	57.8	15.0	-	-	44341	5322.1
	7	2	68.8	15.0	1639.2	-	225299	5322.1
	8	3	91.9	15.0	1452.1	1175.1	406066	5322.1
	9	1	65.5	15.0	-	-	589152	5322.1
	10	2	72.4	15.0	972.6	-	21972	5322.1
	11	1	54.4	15.0	-	-	203664	5322.1
	12	2	81.2	15.0	1375.8	-	384174	5322.1
	13	1	65.7	15.0	-	-	566366	5322.1
	14	2	81.8	15.0	1424.2	-	746326	5322.1
15	1	54.8	15.0	-	-	181105	5322.1	

Trial #	Burst Number	Number of Pulses	Pulse Width [usec]	Chirp Width [MHz]	Pulse 1-to-2 Spacing [usec]	Pulse 2-to-3 Spacing [usec]	Starting Location Within Interval [usec]	Center Frequency [MHz]
27	0	3	95.9	16.0	1457.1	1646.1	339966	5321.7
	1	2	81.1	16.0	1583.9	-	511299	5321.7
	2	3	94.3	16.0	927.7	940.7	680572	5321.7
	3	3	96.7	16.0	1644.3	1587.3	148811	5321.7
	4	2	78.0	16.0	1890.0	-	319376	5321.7
	5	2	81.0	16.0	1314.0	-	489812	5321.7
	6	2	73.1	16.0	1534.9	-	660586	5321.7
	7	3	92.8	16.0	1849.2	968.2	127797	5321.7
	8	2	80.1	16.0	1356.9	-	298632	5321.7
	9	3	91.5	16.0	1788.5	1192.5	468235	5321.7
	10	2	69.8	16.0	1316.2	-	639679	5321.7
	11	1	51.9	16.0	-	-	107362	5321.7
	12	1	65.5	16.0	-	-	278087	5321.7
	13	1	56.8	16.0	-	-	449307	5321.7
	14	1	56.1	16.0	-	-	620094	5321.7
	15	3	89.6	16.0	1535.4	1343.4	85907	5321.7
16	1	55.4	16.0	-	-	256977	5321.7	

Trial #	Burst Number	Number of Pulses	Pulse Width [usec]	Chirp Width [MHz]	Pulse 1-to-2 Spacing [usec]	Pulse 2-to-3 Spacing [usec]	Starting Location Within Interval [usec]	Center Frequency [MHz]
28	0	3	91.2	20.0	1604.8	1174.8	361779	5320.1
	1	2	71.7	20.0	1902.3	-	506771	5320.1
	2	3	98.0	20.0	1281.0	1081.0	55239	5320.1
	3	2	72.3	20.0	1787.7	-	199909	5320.1
	4	1	65.1	20.0	-	-	346004	5320.1
	5	3	91.2	20.0	1439.8	1457.8	488617	5320.1
	6	1	51.3	20.0	-	-	37613	5320.1
	7	2	73.1	20.0	1233.9	-	182412	5320.1
	8	3	90.6	20.0	1901.4	1538.4	326011	5320.1
	9	3	94.6	20.0	1695.4	1227.4	470802	5320.1
	10	3	84.2	20.0	961.8	1437.8	19619	5320.1
	11	2	69.5	20.0	1769.5	-	164308	5320.1
	12	1	62.9	20.0	-	-	309771	5320.1
	13	1	61.2	20.0	-	-	455120	5320.1
	14	2	68.7	20.0	1442.3	-	1823	5320.1
	15	3	86.1	20.0	1355.9	1453.9	146370	5320.1
	16	3	89.0	20.0	1620.0	990.0	290680	5320.1
	17	3	91.9	20.0	935.1	1370.1	435687	5320.1
	18	3	89.3	20.0	1165.7	1300.7	579858	5320.1
19	2	80.8	20.0	1566.2	-	128656	5320.1	

Trial #	Burst Number	Number of Pulses	Pulse Width [usec]	Chirp Width [MHz]	Pulse 1-to-2 Spacing [usec]	Pulse 2-to-3 Spacing [usec]	Starting Location Within Interval [usec]	Center Frequency [MHz]
29	0	3	99.6	18.0	1580.4	1466.4	287341	5320.9
	1	1	59.9	18.0	-	-	441415	5320.9
	2	2	72.6	18.0	1742.4	-	593007	5320.9
	3	3	85.6	18.0	1411.4	1643.4	116463	5320.9
	4	2	76.6	18.0	1864.4	-	269026	5320.9
	5	3	98.2	18.0	1472.8	1207.8	421115	5320.9
	6	3	93.5	18.0	1273.5	1033.5	572849	5320.9
	7	2	69.8	18.0	993.2	-	98152	5320.9
	8	1	55.8	18.0	-	-	251116	5320.9
	9	1	53.3	18.0	-	-	403962	5320.9
	10	3	85.0	18.0	1665.0	1637.0	553818	5320.9
	11	1	59.4	18.0	-	-	79418	5320.9
	12	2	82.8	18.0	1504.2	-	231817	5320.9
	13	3	99.1	18.0	915.9	1813.9	382981	5320.9
	14	3	90.1	18.0	1044.9	1498.9	535984	5320.9
	15	3	94.0	18.0	1557.0	1646.0	60309	5320.9
	16	3	83.9	18.0	1522.1	1084.1	212658	5320.9
	17	2	82.5	18.0	1610.5	-	365490	5320.9
18	2	80.8	18.0	1540.2	-	517709	5320.9	

Trial #	Burst Number	Number of Pulses	Pulse Width [usec]	Chirp Width [MHz]	Pulse 1-to-2 Spacing [usec]	Pulse 2-to-3 Spacing [usec]	Starting Location Within Interval [usec]	Center Frequency [MHz]
30	0	3	90.0	9.0	1295.0	1523.0	72085	5324.5
	1	3	93.0	9.0	1036.0	981.0	335684	5324.5
	2	2	73.6	9.0	1696.4	-	599503	5324.5
	3	3	87.4	9.0	1085.6	1556.6	862444	5324.5
	4	3	86.5	9.0	1390.5	1658.5	39597	5324.5
	5	3	88.9	9.0	1760.1	1081.1	303163	5324.5
	6	2	73.2	9.0	1721.8	-	567229	5324.5
	7	2	67.1	9.0	1884.9	-	830982	5324.5
	8	2	80.2	9.0	1597.8	-	7166	5324.5
	9	1	51.1	9.0	-	-	271500	5324.5
10	1	65.9	9.0	-	-	535393	5324.5	

Parameter Data sheet for Radar Type 6

5300 MHz (11a)

Trial #	Hopping Number	Start Time [ms]	Frequency [MHz]
1	29	84	5300
	34	99	5290
	45	132	5301
	49	144	5303
	67	198	5306
	78	231	5309
	80	237	5310
	84	249	5293
	99	294	5294

Trial #	Hopping Number	Start Time [ms]	Frequency [MHz]
2	2	3	5295
	47	138	5291
	53	156	5290
	55	162	5292
	57	168	5297
	59	174	5302
	82	243	5306
	95	282	5293

Trial #	Hopping Number	Start Time [ms]	Frequency [MHz]
3	9	24	5298
	36	105	5310
	49	144	5291
	72	213	5290
	89	264	5296

Trial #	Hopping Number	Start Time [ms]	Frequency [MHz]
4	2	3	5298
	25	72	5308
	31	90	5307
	78	231	5295
	90	267	5292

Trial #	Hopping Number	Start Time [ms]	Frequency [MHz]
5	19	54	5304
	39	114	5300
	59	174	5295
	75	222	5291
	96	285	5292

Trial #	Hopping Number	Start Time [ms]	Frequency [MHz]
7	16	45	5297
	34	99	5294
	39	114	5310
	51	150	5293
	52	153	5309
	57	168	5301
	84	249	5302

Trial #	Hopping Number	Start Time [ms]	Frequency [MHz]
8	2	3	5304
	14	39	5296
	51	150	5307
	60	177	5299
	85	252	5300
	89	264	5305

Trial #	Hopping Number	Start Time [ms]	Frequency [MHz]
9	40	117	5303
	53	156	5297
	71	210	5307
	83	246	5300
	85	252	5301

Trial #	Hopping Number	Start Time [ms]	Frequency [MHz]
10	2	3	5307
	9	24	5295
	64	189	5300
	75	222	5302
	97	288	5298

Trial #	Hopping Number	Start Time [ms]	Frequency [MHz]
11	14	39	5309
	19	54	5292
	96	285	5303

Trial #	Hopping Number	Start Time [ms]	Frequency [MHz]
12	3	6	5295
	6	15	5310
	61	180	5301
	82	243	5300

Trial #	Hopping Number	Start Time [ms]	Frequency [MHz]
13	9	24	5309
	13	36	5303
	40	117	5293
	64	189	5307
	97	288	5296

Trial #	Hopping Number	Start Time [ms]	Frequency [MHz]
14	24	69	5291
	44	129	5310
	77	228	5307
	95	282	5297

Trial #	Hopping Number	Start Time [ms]	Frequency [MHz]
15	46	135	5302
	56	165	5291
	65	192	5296
	70	207	5293

Trial #	Hopping Number	Start Time [ms]	Frequency [MHz]
16	11	30	5300
	20	57	5292
	36	105	5304
	49	144	5296
	82	243	5290

Trial #	Hopping Number	Start Time [ms]	Frequency [MHz]
17	12	33	5292
	29	84	5291
	80	237	5290

Trial #	Hopping Number	Start Time [ms]	Frequency [MHz]
18	5	12	5310
	38	111	5302

Trial #	Hopping Number	Start Time [ms]	Frequency [MHz]
19	23	66	5294
	33	96	5307
	55	162	5291
	72	213	5300
	82	243	5305
	83	246	5304
	96	285	5295

Trial #	Hopping Number	Start Time [ms]	Frequency [MHz]
20	9	24	5306
	23	66	5294

Trial #	Hopping Number	Start Time [ms]	Frequency [MHz]
21	3	6	5291
	32	93	5305
	56	165	5298
	63	186	5295
	90	267	5304

Trial #	Hopping Number	Start Time [ms]	Frequency [MHz]
22	7	18	5309
	11	30	5294
	13	36	5300
	51	150	5305
	58	171	5299
	69	204	5298

Trial #	Hopping Number	Start Time [ms]	Frequency [MHz]
23	4	9	5293
	20	57	5308
	33	96	5303
	62	183	5307

Trial #	Hopping Number	Start Time [ms]	Frequency [MHz]
24	30	87	5304
	59	174	5303

Trial #	Hopping Number	Start Time [ms]	Frequency [MHz]
25	1	0	5300
	6	15	5294

Trial #	Hopping Number	Start Time [ms]	Frequency [MHz]
26	60	177	5297
	71	210	5304
	81	240	5308

Trial #	Hopping Number	Start Time [ms]	Frequency [MHz]
27	5	12	5303
	46	135	5295
	74	219	5290

Trial #	Hopping Number	Start Time [ms]	Frequency [MHz]
28	61	180	5294
	70	207	5309
	74	219	5301
	98	291	5310

Trial #	Hopping Number	Start Time [ms]	Frequency [MHz]
29	2	3	5292
	36	105	5298
	43	126	5291
	47	138	5303
	57	168	5308

Trial #	Hopping Number	Start Time [ms]	Frequency [MHz]
30	30	87	5309
	32	93	5299
	36	105	5306
	84	249	5294

Parameter Data sheet for Radar Type 6

5310 MHz (11n-40)

Trial #	Hopping Number	Start Time [ms]	Frequency [MHz]
1	4	9	5319
	8	21	5301
	13	36	5329
	26	75	5303
	42	123	5299
	58	171	5323
	68	201	5294
	92	273	5317
	98	291	5298

Trial #	Hopping Number	Start Time [ms]	Frequency [MHz]
2	28	81	5330
	35	102	5311
	43	126	5317
	45	132	5303
	77	228	5328
	82	243	5307

Trial #	Hopping Number	Start Time [ms]	Frequency [MHz]
3	1	0	5313
	32	93	5320
	43	126	5290
	50	147	5309
	64	189	5327
	76	225	5303
	79	234	5301
	80	237	5295

Trial #	Hopping Number	Start Time [ms]	Frequency [MHz]
4	4	9	5327
	5	12	5329
	14	39	5294
	15	42	5317
	31	90	5315
	35	102	5296
	41	120	5302
	47	138	5306
	66	195	5312
	68	201	5305

Trial #	Hopping Number	Start Time [ms]	Frequency [MHz]
5	14	39	5296
	15	42	5315
	17	48	5319
	18	51	5318
	34	99	5327
	37	108	5325
	44	129	5295
	62	183	5305
	64	189	5316
	66	195	5317
	73	216	5299
	79	234	5298

Trial #	Hopping Number	Start Time [ms]	Frequency [MHz]
6	18	51	5324
	21	60	5310
	26	75	5296
	66	195	5302
	76	225	5297

Trial #	Hopping Number	Start Time [ms]	Frequency [MHz]
7	3	6	5324
	21	60	5318
	26	75	5290
	28	81	5298
	29	84	5293
	39	114	5313
	61	180	5317
	67	198	5316
	73	216	5304
	76	225	5309
	80	237	5322
	87	258	5319

Trial #	Hopping Number	Start Time [ms]	Frequency [MHz]
8	14	39	5309
	21	60	5326
	29	84	5327
	41	120	5316
	43	126	5325
	55	162	5320
	59	174	5312
	73	216	5307
	74	219	5321
	80	237	5303
	90	267	5313

Trial #	Hopping Number	Start Time [ms]	Frequency [MHz]
9	1	0	5321
	23	66	5323
	36	105	5322
	37	108	5311
	38	111	5329
	45	132	5328
	49	144	5327
	52	153	5299
	62	183	5304
	68	201	5291
	77	228	5330

Trial #	Hopping Number	Start Time [ms]	Frequency [MHz]
10	10	27	5295
	11	30	5317
	13	36	5320
	32	93	5318
	34	99	5302
	45	132	5325
	48	141	5329
	61	180	5303
	64	189	5301
	74	219	5297
	79	234	5299
	94	279	5292

Trial #	Hopping Number	Start Time [ms]	Frequency [MHz]
11	23	66	5302
	32	93	5304
	46	135	5322
	47	138	5325
	57	168	5303
	58	171	5312
	90	267	5291

Trial #	Hopping Number	Start Time [ms]	Frequency [MHz]
12	20	57	5292
	25	72	5318
	29	84	5327
	53	156	5326
	65	192	5311
	67	198	5302
	90	267	5323
	99	294	5316

Trial #	Hopping Number	Start Time [ms]	Frequency [MHz]
13	1	0	5294
	5	12	5322
	23	66	5291
	34	99	5312
	35	102	5297
	40	117	5293
	53	156	5295
	58	171	5323
	70	207	5328
	89	264	5316
	92	273	5300

Trial #	Hopping Number	Start Time [ms]	Frequency [MHz]
14	4	9	5318
	8	21	5326
	11	30	5322
	21	60	5295
	89	264	5328

Trial #	Hopping Number	Start Time [ms]	Frequency [MHz]
15	6	15	5304
	33	96	5330
	37	108	5294
	43	126	5322
	64	189	5313
	65	192	5302
	84	249	5296

Trial #	Hopping Number	Start Time [ms]	Frequency [MHz]
16	3	6	5314
	7	18	5326
	10	27	5308
	24	69	5319
	30	87	5321
	39	114	5295
	48	141	5323
	54	159	5304
	56	165	5292
	57	168	5302
	78	231	5290

Trial #	Hopping Number	Start Time [ms]	Frequency [MHz]
17	4	9	5326
	17	48	5313
	19	54	5302
	31	90	5307
	36	105	5290
	38	111	5316
	64	189	5291
	98	291	5329

Trial #	Hopping Number	Start Time [ms]	Frequency [MHz]
18	22	63	5290
	41	120	5325
	58	171	5303
	61	180	5312
	93	276	5317

Trial #	Hopping Number	Start Time [ms]	Frequency [MHz]
19	13	36	5311
	16	45	5299
	52	153	5317
	56	165	5294
	76	225	5292
	83	246	5304

Trial #	Hopping Number	Start Time [ms]	Frequency [MHz]
20	8	21	5301
	19	54	5293
	67	198	5299
	76	225	5292
	80	237	5296
	84	249	5324

Trial #	Hopping Number	Start Time [ms]	Frequency [MHz]
21	35	102	5293
	47	138	5292
	49	144	5294
	57	168	5305
	65	192	5315
	75	222	5314
	80	237	5290
	82	243	5316
	83	246	5324
87	258	5297	

Trial #	Hopping Number	Start Time [ms]	Frequency [MHz]
22	5	12	5315
	12	33	5318
	36	105	5316
	69	204	5290
	70	207	5298
	95	282	5291
	96	285	5327

Trial #	Hopping Number	Start Time [ms]	Frequency [MHz]
23	17	48	5317
	31	90	5310
	35	102	5311
	41	120	5330
	48	141	5307
	64	189	5304
	74	219	5294
	81	240	5312
	87	258	5302
	89	264	5308
	91	270	5320
	96	285	5291
	98	291	5303

Trial #	Hopping Number	Start Time [ms]	Frequency [MHz]
24	6	15	5315
	11	30	5291
	20	57	5318
	30	87	5299
	52	153	5316
	60	177	5314
	74	219	5317
	80	237	5307
	87	258	5305

Trial #	Hopping Number	Start Time [ms]	Frequency [MHz]
25	18	51	5324
	37	108	5303
	39	114	5297
	73	216	5306
	92	273	5307
	94	279	5298
	97	288	5291
	98	291	5315

Trial #	Hopping Number	Start Time [ms]	Frequency [MHz]
26	10	27	5292
	36	105	5300
	61	180	5324
	67	198	5293
	88	261	5328
	90	267	5325

Trial #	Hopping Number	Start Time [ms]	Frequency [MHz]
27	12	33	5310
	14	39	5301
	15	42	5302
	22	63	5318
	48	141	5315
	53	156	5300
	75	222	5292
	87	258	5309
	89	264	5312
	91	270	5316

Trial #	Hopping Number	Start Time [ms]	Frequency [MHz]
28	11	30	5296
	13	36	5302
	15	42	5323
	40	117	5316
	50	147	5318
	71	210	5290
	74	219	5322
	83	246	5314
	92	273	5312
	99	294	5310

Trial #	Hopping Number	Start Time [ms]	Frequency [MHz]
29	21	60	5290
	32	93	5313
	54	159	5327
	56	165	5322
	57	168	5315
	73	216	5293
	77	228	5330
	87	258	5314
	90	267	5317
	94	279	5324

Trial #	Hopping Number	Start Time [ms]	Frequency [MHz]
30	4	9	5325
	25	72	5307
	28	81	5304
	29	84	5309
	32	93	5299
	34	99	5317
	37	108	5290
	72	213	5320
	74	219	5318
	88	261	5303
97	288	5326	

APPENDIX 2: Test instruments

Test equipment

Test Item	Local ID	LIMS ID	Description	Manufacturer	Model	Serial	Last Calibration Date	Cal Int
DFS	COTS-SDFS-03	176615	Signal Studio for DFS Rader Profiles	Keysight Technologies Inc	N7607C	-	-	-
DFS	CSG-12	143677	Signal Generator	Keysight Technologies Inc	N5182B	MY53050599	2020/07/22	12
DFS	KSA-08	145089	Spectrum Analyzer	Keysight Technologies Inc	E4446A	MY46180525	2019/11/05	12
DFS	KTS-07	145111	Digital Tester	SANWA	PC500	7019232	2020/10/21	12
DFS	SAT20-06	145146	Attenuator	Weinschel Corp.	54A-20	31506	2020/04/01	12
DFS	SAT20-07	145155	Attenuator	Weinschel Corp.	54A-20	31484	2020/04/01	12
DFS	SAT20-12	160495	Attenuator	Weinschel Corp.	54A-20	86752	2019/12/12	12
DFS	SAT20-13	160496	Attenuator	Weinschel Corp.	54A-20	87636	2019/12/12	12
DFS	SCC-G66	196947	Coaxial Cable	HUBER+SUNER	SUCOFLEX 102	803478/2	2020/03/10	12
DFS	SCC-G67	196949	Coaxial Cable	HUBER+SUNER	SUCOFLEX 102	803480/2	2020/03/10	12
DFS	SCC-H18	155708	Microwave cable	Murata Manufacturing CO., LTD	MXHS83QE3000	-	2020/06/16	12
DFS	SOS-19	175823	Humidity Indicator	CUSTOM. Inc	CTH-201	-	2020/10/01	12
DFS	SPSC-08	146277	Power Splitters/Combiners	Mini-Circuits	ZFSC-2-10G+	-	2019/11/18	12
DFS	SPSC-08	146277	Power Splitters/Combiners	Mini-Circuits	ZFSC-2-10G+	-	2020/11/19	12
DFS	SPSC-14	157772	Power Splitters/Combiners	Mini-Circuits	ZFSC-2-10G-S+	-	2020/08/05	12
DFS	SAT20-02	145143	Attenuator	Keysight Technologies Inc	8493C-020	74890	2020/03/02	12
DFS	SAT20-03	145144	Attenuator	Keysight Technologies Inc	8493C-020	74891	2020/03/02	12
DFS	SCC-G12	145040	Coaxial Cable	Suhner	SUCOFLEX 102	30790/2	2020/03/02	12

*Hyphens for Last Calibration Date and Cal Int (month) are instruments that Calibration is not required (e.g. software), or instruments checked in advance before use.

*1) Signal generator is only used to generate radar test signal, and the wave form is confirmed with spectrum analyzer every time before the test.

The expiration date of the calibration is the end of the expired month.

As for some calibrations performed after the tested dates, those test equipment have been controlled by means of an unbroken chains of calibrations.

*2) This test equipment was used for the tests before the expiration date of the calibration.

All equipment is calibrated with valid calibrations. Each measurement data is traceable to the national or international standards.

Test item:

DFS: Dynamic Frequency Selection

UL Japan, Inc.

Shonan EMC Lab.

1-22-3 Megumigaoka, Hiratsuka-shi, Kanagawa-ken, 259-1220 JAPAN

Telephone : +81 463 50 6400

Facsimile : +81 463 50 6401