



FCC SAR Test Report

APPLICANT : Sony Corporation
EQUIPMENT : Tablet Device
BRAND NAME : VAIO
MODEL NAME : SVJ202B15L
FCC ID : AK8SVJ202B15L
STANDARD : FCC 47 CFR Part 2 (2.1093)
ANSI/IEEE C95.1-1992
IEEE 1528-2003
FCC OET Bulletin 65 Supplement C (Edition 01-01)

The product was completely tested on Mar. 07, 2013. We, SPORTON INTERNATIONAL INC., would like to declare that the tested sample has been evaluated in accordance with the procedures and shown the compliance with the applicable technical standards.

The test results in this report apply exclusively to the tested model / sample. Without written approval of SPORTON INTERNATIONAL INC., the test report shall not be reproduced except in full.

Reviewed by:

Jones Tsai / Manager



SPORTON INTERNATIONAL INC.

No. 52, Hwa Ya 1st Rd., Hwa Ya Technology Park, Kwei-Shan Hsiang, Tao Yuan Hsien, Taiwan, R.O.C.



Table of Contents

1. Statement of Compliance	4
2. Administration Data	5
2.1 Testing Laboratory	5
2.2 Applicant	5
2.3 Manufacturer	5
2.4 Application Details	5
3. General Information	6
3.1 Description of Equipment Under Test (EUT)	6
3.2 Maximum RF output power among production units	7
3.3 Applied Standard	8
3.4 Device Category and SAR Limits	8
3.5 Test Conditions	8
4. Specific Absorption Rate (SAR)	9
4.1 Introduction	9
4.2 SAR Definition	9
5. SAR Measurement System	10
5.1 E-Field Probe	11
5.2 Data Acquisition Electronics (DAE)	12
5.3 Robot	12
5.4 Measurement Server	12
5.5 Phantom	13
5.6 Device Holder	14
5.7 Data Storage and Evaluation	15
5.8 Test Equipment List	17
6. Tissue Simulating Liquids	18
7. SAR System Verification	20
7.1 Purpose of System Performance check	20
7.2 System Setup	20
7.3 SAR System Verification Results	21
8. EUT Testing Position	22
9. Measurement Procedures	22
9.1 Spatial Peak SAR Evaluation	23
9.2 Power Reference Measurement	23
9.3 Area & Zoom Scan Procedures	24
9.4 Volume Scan Procedures	25
9.5 SAR Averaged Methods	25
9.6 Power Drift Monitoring	25
10. Conducted RF Output Power (Unit: dBm)	26
11. Exposure Positions Consideration	34
12. SAR Test Results	36
12.1 Test Records for Body SAR Test	36
12.2 Repeated SAR Measurement	38
12.3 Highest SAR Plot	39
12.4 Simultaneous Multi-band Transmission Analysis	41
13. Uncertainty Assessment	42
14. References	45
Appendix A. Plots of System Performance Check	
Appendix B. Plots of SAR Measurement	
Appendix C. DASYS Calibration Certificate	
Appendix D. Test Setup Photos	



Revision History

REPORT NO.	VERSION	DESCRIPTION	ISSUED DATE
FA322001	Rev. 01	Initial issue of report	Mar. 21, 2013



1. Statement of Compliance

The maximum results of Specific Absorption Rate (SAR) found during testing for **Sony Corporation Tablet Device, VAIO, SVJ202B15L** are as follows.

<Highest Reported standalone SAR Summary>

Frequency Band	Exposure Position	Reported 1g-SAR (W/kg)	Equipment Class	Highest Reported 1g-SAR (W/kg)
WLAN 5.2GHz Band	Body (0 cm Gap)	0.63	NII	0.92
WLAN 5.3GHz Band	Body (0 cm Gap)	0.92		
WLAN 5.5GHz Band	Body (0 cm Gap)	0.70		
WLAN 5.8GHz Band	Body (0 cm Gap)	0.83	DTS	0.83
WLAN 2.4GHz Band	Body (0 cm Gap)	0.20		

This device is in compliance with Specific Absorption Rate (SAR) for general population/uncontrolled exposure limits (1.6 W/kg) specified in FCC 47 CFR part 2 (2.1093) and ANSI/IEEE C95.1-1992, and had been tested in accordance with the measurement methods and procedures specified in IEEE 1528-2003 and FCC OET Bulletin 65 Supplement C (Edition 01-01).



2. Administration Data

2.1 Testing Laboratory

Test Site	SPORTON INTERNATIONAL INC.
Test Site Location	No. 52, Hwa Ya 1 st Rd., Hwa Ya Technology Park, Kwei-Shan Hsiang, Tao Yuan Hsien, Taiwan, R.O.C. TEL: +886-3-327-3456 FAX: +886-3-328-4978

2.2 Applicant

Company Name	Sony Corporation
Address	1-7-1 Konan Minato-ku, Tokyo, 108-0075 JAPAN

2.3 Manufacturer

Company Name	Foxconn
Address	Foxconn Industrial District, Export Processing Zone, No. 50, Beijing Zhong Road, Yantai Economic And Technological Development Area, Shandong, P. R. China

2.4 Application Details

Date of Start during the Test	Mar. 01, 2013
Date of End during the Test	Mar. 07, 2013



3. General Information

3.1 Description of Equipment Under Test (EUT)

Product Feature & Specification	
EUT	Tablet Device
Brand Name	VAIO
Model Name	SVJ202B15L
FCC ID	AK8SVJ202B15L
Integrated WLAN Module	Brand Name : Intel Model Name : 6235ANHMW
Integrated NFC Module	Brand Name : SONY Model Name : RC-S634/UA
TX Frequency	WLAN 2.4GHz Band: 2412 MHz ~ 2462 MHz WLAN 5.2GHz Band: 5180 MHz ~ 5240 MHz WLAN 5.3GHz Band: 5260 MHz ~ 5320 MHz WLAN 5.5GHz Band:5500 MHz ~ 5700 MHz WLAN 5.8GHz Band: 5745 MHz ~ 5825 MHz Bluetooth: 2402 MHz ~ 2480 MHz NFC : 13.56 MHz
Antenna Type	WWAN: PIFA Antenna WLAN: PIFA Antenna Bluetooth: PIFA Antenna
Uplink Modulations	802.11b: DSSS (DBPSK / DQPSK / CCK) 802.11a/g/n: OFDM (BPSK / QPSK / 16QAM / 64QAM) Bluetooth : GFSK Bluetooth EDR : $\pi/4$ -DQPSK, 8-DPSK Bluetooth 4.0 LE: GFSK NFC : ASK
Remark:	<ol style="list-style-type: none">The above EUT's information was declared by manufacturer. Please refer to the specifications or user's manual for more detailed description.5600 MHz ~ 5650 MHz is notched.



3.2 Maximum RF output power among production units

IEEE 802.11 Average Power (dBm)											
Normal											
WLAN 2.4GHz	Ant 0				Ant 1				Ant 0+1		
Freq (MHz)	11b	11g	HT20	HT40	11b	11g	HT20	HT40	HT20	HT40	
2412	15	12	10		15	12	10.5		15		
2422				7				7			9
2437		15.5	15.5	11.5		15	15	11.5			14.5
2452				7				7			9.5
2462		12.5	11.5				12	11			

Mode / Band	Bluetooth average power(dBm)			
	1Mbps	2Mbps	3Mbps	BT4.0-LE
	(GFSK)	($\pi/4$ -DQPSK)	(8-DPSK)	(GFSK)
2.4 GHz Bluetooth	7	3	3	7

IEEE 802.11 Average Power (dBm)												
Normal												
WLAN 5GHz	Ant 0			Ant 1			Ant 0+1					
Freq (MHz)	11a	HT20	HT40	11a	HT20	HT40	HT20	HT40				
5180	14.5	13.0	12.5	14.5	13.5		15.0					
5190			10.0			10.0			12.0			
5200		14.5	14.5			14.5						
5220		14.5	14.5			14.5						
5230					14.0			14.0		14.5		
5240		14.5	14.5					14.5				
5260	14.5	14.5		14.5	14.5		15.0					
5270			14.0					14.0		15.0		
5280												
5300												
5310								10.0		10.0		12.5
5320												
5500	14.5	14.5		14.5	14.5		15.0					
5510			11.5					11.5		8.0		
5520												
5540												
5550			14.5					14.5		14.5		
5560												
5580												
5660												
5670								14.5		14.5		14.5
5680												
5700												
5745	15.0	15.0		14.5	14.5	14.5	14.0	14.5				
5755												
5765												
5785												
5795												
5805												
5825												



3.3 Applied Standard

The Specific Absorption Rate (SAR) testing specification, method, and procedure for this device is in accordance with the following standards:

- FCC 47 CFR Part 2 (2.1093)
- ANSI/IEEE C95.1-1992
- IEEE 1528-2003
- FCC OET Bulletin 65 Supplement C (Edition 01-01)
- FCC KDB 447498 D01 v05
- FCC KDB 248227 D01 v01r02
- FCC KDB 616217 D04 v01

3.4 Device Category and SAR Limits

This device belongs to portable device category because its radiating structure is allowed to be used within 20 centimeters of the body of the user. Limit for General Population/Uncontrolled exposure should be applied for this device, it is 1.6 W/kg as averaged over any 1 gram of tissue.

3.5 Test Conditions

3.5.1 Ambient Condition

Ambient Temperature	20 to 24 °C
Humidity	< 60 %

3.5.2 Test Configuration

During WLAN SAR testing EUT is configured with the WLAN continuous TX tool, and the transmission duty factor was monitored on the spectrum analyzer with zero-span setting

Duty factor observed as below:

802.11b, 1Mbps: 100%

802.11g, 6Mbps: 100%

802.11a, 6Mbps: 100%

802.11 HT20, MCS8: 100%

For WLAN SAR testing, WLAN engineering testing software installed on the EUT can provide continuous transmitting RF signal.

4. Specific Absorption Rate (SAR)

4.1 Introduction

SAR is related to the rate at which energy is absorbed per unit mass in an object exposed to a radio field. The SAR distribution in a biological body is complicated and is usually carried out by experimental techniques or numerical modeling. The standard recommends limits for two tiers of groups, occupational/controlled and general population/uncontrolled, based on a person's awareness and ability to exercise control over his or her exposure. In general, occupational/controlled exposure limits are higher than the limits for general population/uncontrolled.

4.2 SAR Definition

The SAR definition is the time derivative (rate) of the incremental energy (dW) absorbed by (dissipated in) an incremental mass (dm) contained in a volume element (dv) of a given density (ρ). The equation description is as below:

$$\text{SAR} = \frac{d}{dt} \left(\frac{dW}{dm} \right) = \frac{d}{dt} \left(\frac{dW}{\rho dv} \right)$$

SAR is expressed in units of Watts per kilogram (W/kg)

SAR measurement can be either related to the temperature elevation in tissue by

$$\text{SAR} = C \left(\frac{\delta T}{\delta t} \right)$$

Where: C is the specific heat capacity, δT is the temperature rise and δt is the exposure duration, or related to the electrical field in the tissue by

$$\text{SAR} = \frac{\sigma |E|^2}{\rho}$$

Where: σ is the conductivity of the tissue, ρ is the mass density of the tissue and E is the RMS electrical field strength.

However for evaluating SAR of low power transmitter, electrical field measurement is typically applied.

5. SAR Measurement System

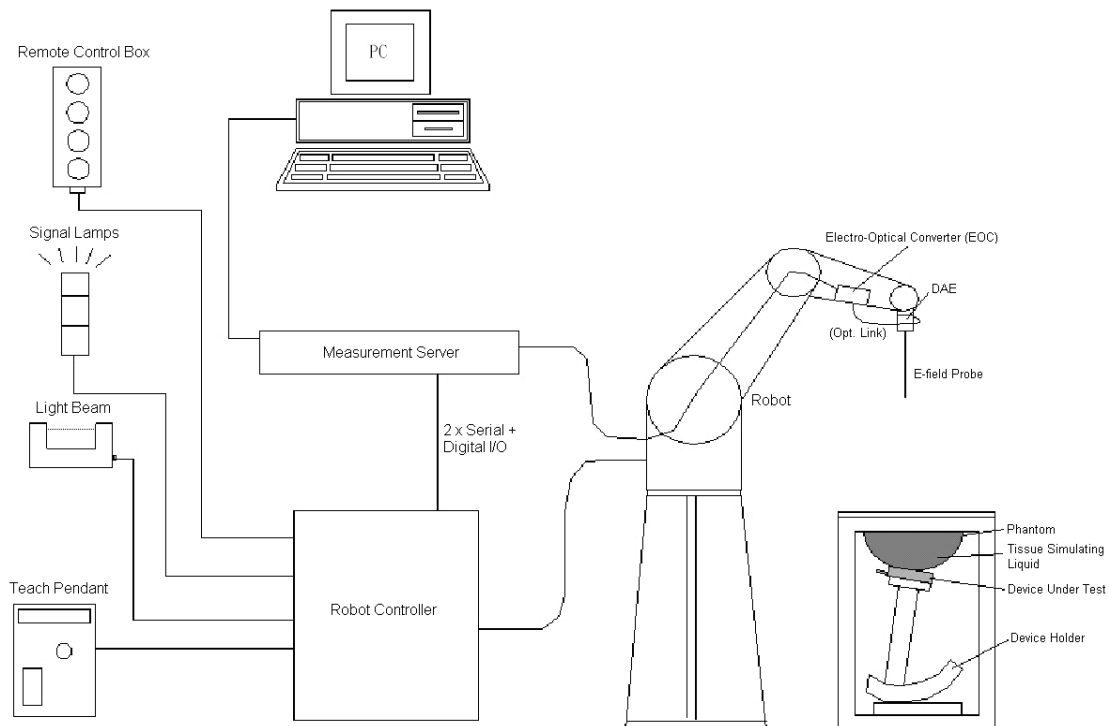

Fig 5.1 SPEAG DASY System Configurations

The DASY system for performance compliance tests is illustrated above graphically. This system consists of the following items:

- A standard high precision 6-axis robot with controller, a teach pendant and software
- A data acquisition electronic (DAE) attached to the robot arm extension
- A dosimetric probe equipped with an optical surface detector system
- The electro-optical converter (EOC) performs the conversion between optical and electrical signals
- A measurement server performs the time critical tasks such as signal filtering, control of the robot operation and fast movement interrupts.
- A probe alignment unit which improves the accuracy of the probe positioning
- A computer operating Windows XP
- DASY software
- Remote control with teach pendant and additional circuitry for robot safety such as warning lamps, etc.
- The SAM twin phantom
- A device holder
- Tissue simulating liquid
- Dipole for evaluating the proper functioning of the system

Component details are described in in the following sub-sections.

5.1 E-Field Probe

The SAR measurement is conducted with the dosimetric probe (manufactured by SPEAG). The probe is specially designed and calibrated for use in liquid with high permittivity. The dosimetric probe has special calibration in liquid at different frequency. This probe has a built in optical surface detection system to prevent from collision with phantom.

5.1.1 E-Field Probe Specification

<ES3DV3 Probe >

Construction	Symmetrical design with triangular core Built-in optical fiber for surface detection system. Built-in shielding against static charges. PEEK enclosure material (resistant to organic solvents, e.g., DGBE)
Frequency	10 MHz to 3 GHz; Linearity: ± 0.2 dB
Directivity	± 0.2 dB in HSL (rotation around probe axis) ± 0.4 dB in HSL (rotation normal to probe axis)
Dynamic Range	10 μ W/g to 100 mW/g; Linearity: ± 0.2 dB
Dimensions	Overall length: 337 mm (Tip: 10 mm) Tip diameter: 4 mm (Body: 10 mm) Distance from probe tip to dipole centers: 3 mm



Fig 5.2 Photo of ES3DV3

<EX3DV4 Probe>

Construction	Symmetrical design with triangular core Built-in shielding against static charges PEEK enclosure material (resistant to organic solvents, e.g., DGBE)
Frequency	10 MHz to 6 GHz; Linearity: ± 0.2 dB
Directivity	± 0.3 dB in HSL (rotation around probe axis) ± 0.5 dB in tissue material (rotation normal to probe axis)
Dynamic Range	10 μ W/g to 100 mW/g; Linearity: ± 0.2 dB (noise: typically < 1 μ W/g)
Dimensions	Overall length: 330 mm (Tip: 20 mm) Tip diameter: 2.5 mm (Body: 12 mm) Typical distance from probe tip to dipole centers: 1 mm



Fig 5.3 Photo of EX3DV4/ES3DV4

5.1.2 E-Field Probe Calibration

Each probe needs to be calibrated according to a dosimetric assessment procedure with accuracy better than $\pm 10\%$. The spherical isotropy shall be evaluated and within ± 0.25 dB. The sensitivity parameters (NormX, NormY, and NormZ), the diode compression parameter (DCP) and the conversion factor (ConvF) of the probe are tested. The calibration data can be referred to appendix C of this report.

5.2 Data Acquisition Electronics (DAE)

The data acquisition electronics (DAE) consists of a highly sensitive electrometer-grade preamplifier with auto-zeroing, a channel and gain-switching multiplexer, a fast 16 bit AD-converter and a command decoder and control logic unit. Transmission to the measurement server is accomplished through an optical downlink for data and status information as well as an optical uplink for commands and the clock. The input impedance of the DAE is 200 MOhm; the inputs are symmetrical and floating. Common mode rejection is above 80 dB.



Fig 5.4 Photo of DAE

5.3 Robot

The SPEAG DASY system uses the high precision robots (DASY4: RX90BL; DASY5: TX90XL) type from Stäubli SA (France). For the 6-axis controller system, the robot controller version (DASY4: CS7MB; DASY5: CS8c) from Stäubli is used. The Stäubli robot series have many features that are important for our application:

- High precision (repeatability ± 0.035 mm)
- High reliability (industrial design)
- Jerk-free straight movements
- Low ELF interference (the closed metallic construction shields against motor control fields)



Fig 5.5 Photo of DASY4



Fig 5.6 Photo of DASY5

5.4 Measurement Server

The measurement server is based on a PC/104 CPU board with CPU (DASY4: 166 MHz, Intel Pentium; DASY5: 400 MHz, Intel Celeron), chipdisk (DASY4: 32 MB; DASY5: 128 MB), RAM (DASY4: 64 MB, DASY5: 128 MB). The necessary circuits for communication with the DAE electronic box, as well as the 16 bit AD converter system for optical detection and digital I/O interface are contained on the DASY I/O board, which is directly connected to the PC/104 bus of the CPU board.

The measurement server performs all the real-time data evaluation for field measurements and surface detection, controls robot movements and handles safety operations.



Fig 5.7 Photo of Server for DASY4



Fig 5.8 Photo of Server for DASY5

5.5 Phantom

<SAM Twin Phantom>

Shell Thickness	2 ± 0.2 mm; Center ear point: 6 ± 0.2 mm
Filling Volume	Approx. 25 liters
Dimensions	Length: 1000 mm; Width: 500 mm; Height: adjustable feet
Measurement Areas	Left Hand, Right Hand, Flat Phantom



Fig 5.9 Photo of SAM Phantom

The bottom plate contains three pair of bolts for locking the device holder. The device holder positions are adjusted to the standard measurement positions in the three sections. A white cover is provided to tap the phantom during off-periods to prevent water evaporation and changes in the liquid parameters. On the phantom top, three reference markers are provided to identify the phantom position with respect to the robot.

<ELI4 Phantom>

Shell Thickness	2 ± 0.2 mm (sagging: <1%)
Filling Volume	Approx. 30 liters
Dimensions	Major ellipse axis: 600 mm Minor axis: 400 mm

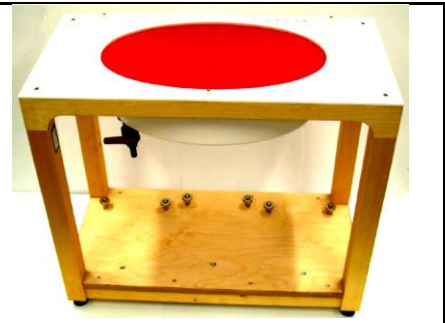

Fig 5.10 Photo of ELI4 Phantom

The ELI4 phantom is intended for compliance testing of handheld and body-mounted wireless devices in the frequency range of 30 MHz to 6 GHz. ELI4 is fully compatible with standard and all known tissue simulating liquids.

5.6 Device Holder

<Device Holder for SAM Twin Phantom>

The SAR in the phantom is approximately inversely proportional to the square of the distance between the source and the liquid surface. For a source at 5 mm distance, a positioning uncertainty of ± 0.5 mm would produce a SAR uncertainty of ± 20 %. Accurate device positioning is therefore crucial for accurate and repeatable measurements. The positions in which the devices must be measured are defined by the standards.

The DASY device holder is designed to cope with different positions given in the standard. It has two scales for the device rotation (with respect to the body axis) and the device inclination (with respect to the line between the ear reference points). The rotation center for both scales is the ear reference point (ERP). Thus the device needs no repositioning when changing the angles.

The DASY device holder is constructed of low-loss POM material having the following dielectric parameters: relative permittivity $\epsilon = 3$ and loss tangent $\delta = 0.02$. The amount of dielectric material has been reduced in the closest vicinity of the device, since measurements have suggested that the influence of the clamp on the test results could thus be lowered.



Fig 5.11 Device Holder

<Laptop Extension Kit>

The extension is lightweight and made of POM, acrylic glass and foam. It fits easily on the upper part of the mounting device in place of the phone positioned. The extension is fully compatible with the SAM Twin and ELI phantoms.

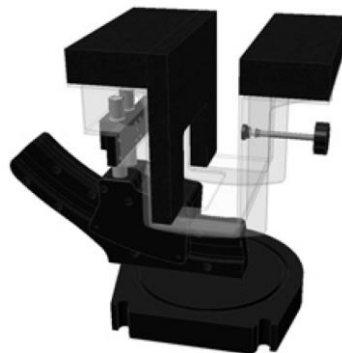

Fig 5.12 Laptop Extension Kit



5.7 Data Storage and Evaluation

5.7.1 Data Storage

The DASY software stores the assessed data from the data acquisition electronics as raw data (in microvolt readings from the probe sensors), together with all the necessary software parameters for the data evaluation (probe calibration data, liquid parameters and device frequency and modulation data) in measurement files. The post-processing software evaluates the desired unit and format for output each time the data is visualized or exported. This allows verification of the complete software setup even after the measurement and allows correction of erroneous parameter settings. For example, if a measurement has been performed with an incorrect crest factor parameter in the device setup, the parameter can be corrected afterwards and the data can be reevaluated.

The measured data can be visualized or exported in different units or formats, depending on the selected probe type (e.g., [V/m], [A/m], [mW/g]). Some of these units are not available in certain situations or give meaningless results, e.g., a SAR-output in a non-lose media, will always be zero. Raw data can also be exported to perform the evaluation with other software packages.

5.7.2 Data Evaluation

The DASY post-processing software (SEMCAD) automatically executes the following procedures to calculate the field units from the microvolt readings at the probe connector. The parameters used in the evaluation are stored in the configuration modules of the software :

Probe parameters :	- Sensitivity	Norm _i , a _{i0} , a _{i1} , a _{i2}
	- Conversion factor	ConvF _i
	- Diode compression point	dcp _i
Device parameters :	- Frequency	f
	- Crest factor	cf
Media parameters :	- Conductivity	σ
	- Density	ρ

These parameters must be set correctly in the software. They can be found in the component documents or they can be imported into the software from the configuration files issued for the DASY components. In the direct measuring mode of the multi-meter option, the parameters of the actual system setup are used. In the scan visualization and export modes, the parameters stored in the corresponding document files are used.

The first step of the evaluation is a linearization of the filtered input signal to account for the compression characteristics of the detector diode. The compensation depends on the input signal, the diode type and the DC-transmission factor from the diode to the evaluation electronics. If the exciting field is pulsed, the crest factor of the signal must be known to correctly compensate for peak power.

The formula for each channel can be given as :

$$V_i = U_i + U_i^2 \cdot \frac{cf}{dcp_i}$$

with V_i = compensated signal of channel i, (i = x, y, z)
 U_i = input signal of channel i, (i = x, y, z)
 cf = crest factor of exciting field (DASY parameter)
 dcp_i = diode compression point (DASY parameter)

From the compensated input signals, the primary field data for each channel can be evaluated :

$$\text{E-field Probes : } E_i = \sqrt{\frac{V_i}{\text{Norm}_i \cdot \text{ConvF}}}$$

$$\text{H-field Probes : } H_i = \sqrt{V_i} \cdot \frac{a_{i0} + a_{i1}f + a_{i2}f^2}{f}$$

with V_i = compensated signal of channel i, (i = x, y, z)
 Norm_i = sensor sensitivity of channel i, (i = x, y, z), $\mu\text{V}/(\text{V/m})^2$ for E-field Probes
 ConvF = sensitivity enhancement in solution
 a_{ij} = sensor sensitivity factors for H-field probes
 f = carrier frequency [GHz]
 E_i = electric field strength of channel i in V/m
 H_i = magnetic field strength of channel i in A/m

The RSS value of the field components gives the total field strength (Hermitian magnitude) :

$$E_{\text{tot}} = \sqrt{E_x^2 + E_y^2 + E_z^2}$$

The primary field data are used to calculate the derived field units.

$$\text{SAR} = E_{\text{tot}}^2 \cdot \frac{\sigma}{\rho \cdot 1000}$$

with SAR = local specific absorption rate in mW/g
 E_{tot} = total field strength in V/m
 σ = conductivity in [mho/m] or [Siemens/m]
 ρ = equivalent tissue density in g/cm^3

Note that the density is set to 1, to account for actual head tissue density rather than the density of the tissue simulating liquid.



5.8 Test Equipment List

Manufacturer	Name of Equipment	Type/Model	Serial Number	Calibration	
				Last Cal.	Due Date
SPEAG	2450MHz System Validation Kit	D2450V2	736	Jul. 25, 2011	Jul. 24, 2013
SPEAG	5GHz System Validation Kit	D5GHzV2	1006	Dec. 11, 2012	Dec. 10, 2013
SPEAG	Data Acquisition Electronics	DAE4	778	Aug. 27, 2012	Aug. 26, 2013
SPEAG	Data Acquisition Electronics	DAE4	1279	Jan. 28, 2013	Jan. 27, 2014
SPEAG	Data Acquisition Electronics	DAE4	1338	Jun. 12, 2012	Jun. 11, 2013
SPEAG	Dosimetric E-Field Probe	EX3DV4	3697	Sep. 28, 2012	Sep. 27, 2013
SPEAG	Dosimetric E-Field Probe	ES3DV3	3270	Sep. 28, 2012	Sep. 27, 2013
SPEAG	Dosimetric E-Field Probe	EX3DV4	3792	Jun. 21, 2012	Jun. 20, 2013
Wisewind	Thermometer	ETP-101	TM560	Nov. 13, 2012	Nov. 12, 2013
Wisewind	Thermometer	HTC-1	TM281	Nov. 13, 2012	Nov. 12, 2013
SPEAG	Device Holder	N/A	N/A	NCR	NCR
SPEAG	ELI4 Phantom	QD OVA 002 AA	1173	NCR	NCR
SPEAG	ELI4 Phantom	QD OVA 001 BB	1026	NCR	NCR
SPEAG	ELI4 Phantom	QD OVA 001 BA	1029	NCR	NCR
Agilent	ENA Network Analyzer	E5071C	MY46316648	Feb. 07, 2013	Feb. 06, 2014
Agilent	ESG Vector Series Signal Generator	E4438C	MY49070755	Oct. 02, 2012	Oct. 01, 2013
Anritsu	Power Meter	ML2495A	1132003	Aug. 14, 2012	Aug. 13, 2013
Agilent	Dual Directional Coupler	778D	50422	Note 4	
Woken	Attenuator 1	WK0602-XX	N/A	Note 4	
PE	Attenuator 2	PE7005-10	N/A	Note 4	
PE	Attenuator 3	PE7005- 3	N/A	Note 4	
Agilent	Dielectric Probe Kit	85070D	US01440205	Note 5	
AR	Power Amplifier	5S1G4M2	328767	Note 6	
R&S	Spectrum Analyzer	FSP	101131	Jul. 23, 2012	Jul. 22, 2013

Note:

1. The calibration certificate of DASY can be referred to appendix C of this report.
2. Referring to KDB 865664 D01v01, the dipole calibration interval can be extended to 3 years with justification. The dipoles are also not physically damaged, or repaired during the interval.
3. The justification data of dipole D2450V2, SN: 736, can be found in appendix C. The return loss is < -20dB, within 20% of prior calibration, the impedance is within 5 ohm of prior calibration.
4. The Insertion Loss calibration of Dual Directional Coupler and Attenuator were characterized via the network analyzer and compensated during system check.
5. The dielectric probe kit was calibrated via the network analyzer, with the specified procedure (calibrated in pure water) and calibration kit (standard) short circuit, before the dielectric measurement. The specific procedure and calibration kit are provided by Agilent.
6. In system check we need to monitor the level on the power meter, and adjust the power amplifier level to have precise power level to the dipole; the measured SAR will be normalized to 1W input power according to the ratio of 1W to the input power to the dipole. For system check, the calibration of the power amplifier is deemed not critically required for correct measurement; the power meter is critical and we do have calibration for it
7. Attenuator 1 insertion loss is calibrated by the network Analyzer, which the calibration is valid, before system check.

6. Tissue Simulating Liquids

For the measurement of the field distribution inside the SAM phantom with DASY, the phantom must be filled with around 25 liters of homogeneous body tissue simulating liquid. For head SAR testing, the liquid height from the ear reference point (ERP) of the phantom to the liquid top surface is larger than 15 cm, which is shown in Fig. 6.1. For body SAR testing, the liquid height from the center of the flat phantom to the liquid top surface is larger than 15 cm, which is shown in Fig. 6.2.

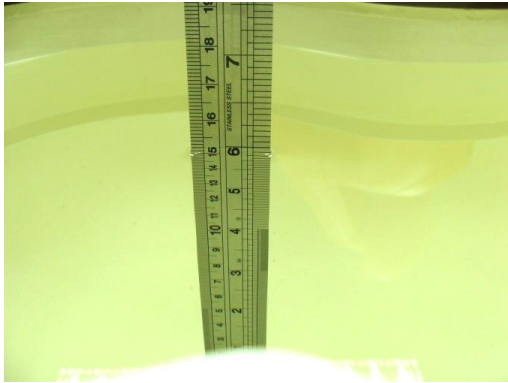

Fig 6.1 Photo of Liquid Height for Head SAR



Fig 6.2 Photo of Liquid Height for Body SAR

The following table gives the recipes for tissue simulating liquid.

Frequency (MHz)	Water (%)	Sugar (%)	Cellulose (%)	Salt (%)	Preventol (%)	DGBE (%)	Conductivity (σ)	Permittivity (ϵ_r)
For Body								
750	51.7	47.2	0	0.9	0.1	0	0.96	55.5
835	50.8	48.2	0	0.9	0.1	0	0.97	55.2
900	50.8	48.2	0	0.9	0.1	0	1.05	55.0
1800, 1900, 2000	70.2	0	0	0.4	0	29.4	1.52	53.3
2450	68.6	0	0	0	0	31.4	1.95	52.7

Table 6.1 Recipes of Tissue Simulating Liquid

Simulating Liquid for 5G, Manufactured by SPEAG

Ingredients	(% by weight)
Water	64~78%
Mineral oil	11~18%
Emulsifiers	9~15%
Additives and Salt	2~3%



The dielectric parameters of the liquids were verified prior to the SAR evaluation using an Agilent 85070D Dielectric Probe Kit and an Agilent Network Analyzer.

The following table shows the measuring results for simulating liquid.

Frequency (MHz)	Liquid Type	Liquid Temp. (°C)	Conductivity (σ)	Permittivity (ϵ_r)	Conductivity Target (σ)	Permittivity Target (ϵ_r)	Delta (σ) (%)	Delta (ϵ_r) (%)	Limit (%)	Date
2450	Body	21.6	1.963	52.895	1.95	52.7	0.67	0.37	±5	2013/3/1
5200	Body	21.3	5.268	47.552	5.3	49	-0.60	-2.96	±5	2013/3/4
5300	Body	21.3	5.405	47.298	5.30	49.0	1.98	-3.47	±5	2013/3/4
5300	Body	21.3	5.27	47.255	5.30	49.0	-0.57	-3.56	±5	2013/3/5
5300	Body	21.3	5.422	47.242	5.30	49.0	2.30	-3.59	±5	2013/3/7
5600	Body	21.2	5.653	46.801	5.65	48.6	0.05	-3.70	±5	2013/3/5
5800	Body	21.4	6.127	46.464	6	48.2	2.12	-3.60	±5	2013/3/6

Table 6.2 Measuring Results for Simulating Liquid

7. SAR System Verification

Each DASY system is equipped with one or more system validation kits. These units, together with the predefined measurement procedures within the DASY software, enable the user to conduct the system performance check and system validation. System validation kit includes a dipole, tripod holder to fix it underneath the flat phantom and a corresponding distance holder.

7.1 Purpose of System Performance check

The system performance check verifies that the system operates within its specifications. System and operator errors can be detected and corrected. It is recommended that the system performance check be performed prior to any usage of the system in order to guarantee reproducible results. The system performance check uses normal SAR measurements in a simplified setup with a well characterized source. This setup was selected to give a high sensitivity to all parameters that might fail or vary over time. The system check does not intend to replace the calibration of the components, but indicates situations where the system uncertainty is exceeded due to drift or failure.

7.2 System Setup

In the simplified setup for system evaluation, the EUT is replaced by a calibrated dipole and the power source is replaced by a continuous wave that comes from a signal generator. The calibrated dipole must be placed beneath the flat phantom section of the SAM twin phantom with the correct distance holder. The distance holder should touch the phantom surface with a light pressure at the reference marking and be oriented parallel to the long side of the phantom. The equipment setup is shown below:

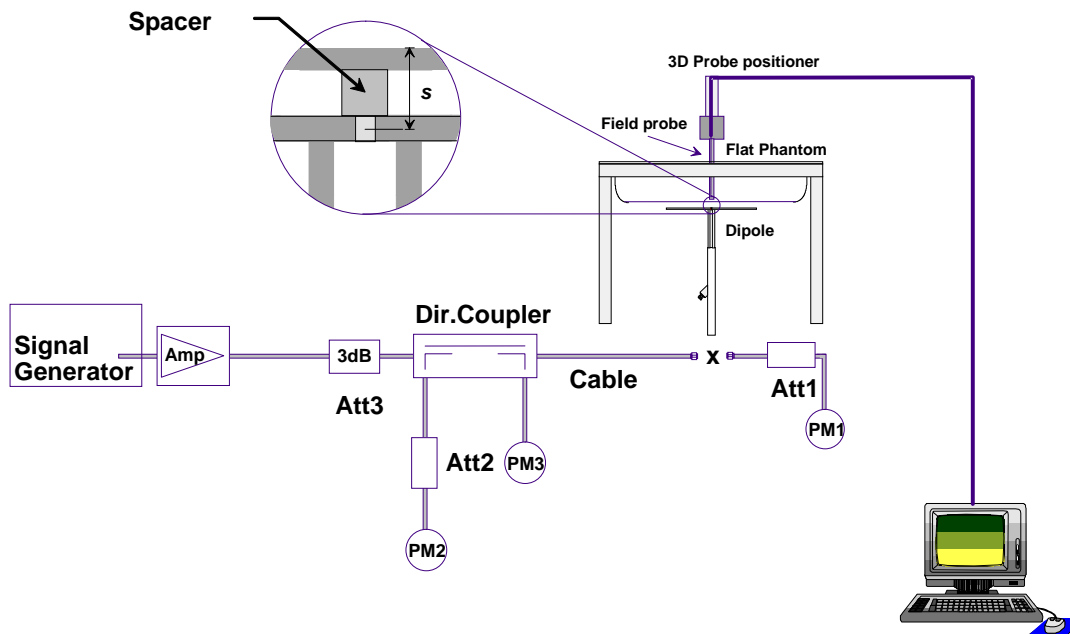

Fig 7.1 System Setup for System Evaluation

1. Signal Generator
2. Amplifier
3. Directional Coupler
4. Power Meter
5. Calibrated Dipole



Fig 7.2 Photo of Dipole Setup

7.3 SAR System Verification Results

Comparing to the original SAR value provided by SPEAG, the verification data should be within its specification of 10 %. Table 7.1 shows the target SAR and measured SAR after normalized to 1W input power. The table below indicates the system performance check can meet the variation criterion and the plots can be referred to Appendix A of this report.

Date	Frequency (MHz) ²	Liquid Type	Power fed onto reference dipole (mW)	Targeted SAR (W/kg)	Measured SAR (W/kg)	Normalized SAR (W/kg)	Deviation (%)
2013/3/1	2450	Body	250	52.3	12.9	51.6	-1.34
2013/3/4	5200	Body	100	71.40	7.32	73.2	2.52
2013/3/4	5300	Body	100	73.50	7.85	78.5	6.80
2013/3/5	5300	Body	100	73.50	7.65	76.5	4.08
2013/3/7	5300	Body	100	73.5	7.74	77.4	5.31
2013/3/5	5600	Body	100	76.80	7.6	76	-1.04
2013/3/6	5800	Body	100	71.7	7.09	70.9	-1.12

Table 7.1 Target and Measurement SAR after Normalized



8. EUT Testing Position

This EUT was tested in three different positions. They are bottom-face, Edge2 and Edge3 of tablet PC. In these positions, the surface of EUT is touching with phantom 0 cm. Please refer to Appendix D for the test setup photos.

9. Measurement Procedures

The measurement procedures are as follows:

<Conducted power measurement>

- (a) For WWAN power measurement, use base station simulator to configure EUT WWAN transmission in conducted connection with RF cable, at maximum power in each supported wireless interface and frequency band.
- (b) Read the WWAN RF power level from the base station simulator.
- (c) For WLAN/BT power measurement, use engineering software to configure EUT WLAN/BT continuously transmission, at maximum RF power in each supported wireless interface and frequency band
- (d) Connect EUT RF port through RF cable to the power meter, and measure WLAN/BT output power

<SAR measurement>

- (a) Use base station simulator to configure EUT WWAN transmission in radiated connection, and engineering software to configure EUT WLAN/BT continuously transmission, at maximum RF power, in the highest power channel.
- (b) Place the EUT in the positions as Appendix D demonstrates.
- (c) Set scan area, grid size and other setting on the DASY software.
- (d) Measure SAR results for the highest power channel on each testing position.
- (e) Find out the largest SAR result on these testing positions of each band
- (f) Measure SAR results for other channels in worst SAR testing position if the reported SAR of highest power channel is larger than 0.8 W/kg

According to the test standard, the recommended procedure for assessing the peak spatial-average SAR value consists of the following steps:

- (a) Power reference measurement
- (b) Area scan
- (c) Zoom scan
- (d) Power drift measurement



9.1 Spatial Peak SAR Evaluation

The procedure for spatial peak SAR evaluation has been implemented according to the test standard. It can be conducted for 1g and 10g, as well as for user-specific masses. The DASY software includes all numerical procedures necessary to evaluate the spatial peak SAR value.

The base for the evaluation is a "cube" measurement. The measured volume must include the 1g and 10g cubes with the highest averaged SAR values. For that purpose, the center of the measured volume is aligned to the interpolated peak SAR value of a previously performed area scan.

The entire evaluation of the spatial peak values is performed within the post-processing engine (SEMCAD). The system always gives the maximum values for the 1g and 10g cubes. The algorithm to find the cube with highest averaged SAR is divided into the following stages:

- (a) Extraction of the measured data (grid and values) from the Zoom Scan
- (b) Calculation of the SAR value at every measurement point based on all stored data (A/D values and measurement parameters)
- (c) Generation of a high-resolution mesh within the measured volume
- (d) Interpolation of all measured values from the measurement grid to the high-resolution grid
- (e) Extrapolation of the entire 3-D field distribution to the phantom surface over the distance from sensor to surface
- (f) Calculation of the averaged SAR within masses of 1g and 10g

9.2 Power Reference Measurement

The Power Reference Measurement and Power Drift Measurements are for monitoring the power drift of the device under test in the batch process. The minimum distance of probe sensors to surface determines the closest measurement point to phantom surface. This distance cannot be smaller than the distance of sensor calibration points to probe tip as defined in the probe properties.

9.3 Area & Zoom Scan Procedures

First Area Scan is used to locate the approximate location(s) of the local peak SAR value(s). The measurement grid within an Area Scan is defined by the grid extent, grid step size and grid offset. Next, in order to determine the EM field distribution in a three-dimensional spatial extension, Zoom Scan is required. The Zoom Scan is performed around the highest E-field value to determine the averaged SAR-distribution over 10 g. Area scan and zoom scan resolution setting follows KDB 865664 D01v01 quoted below.

For any secondary peaks found in the area scan which are within 2 dB of the maximum peak and are not within this zoom scan, the zoom scan should be repeated

		≤ 3 GHz	> 3 GHz
Maximum distance from closest measurement point (geometric center of probe sensors) to phantom surface		5 ± 1 mm	$\frac{1}{2} \cdot \delta \cdot \ln(2) \pm 0.5$ mm
Maximum probe angle from probe axis to phantom surface normal at the measurement location		$30^\circ \pm 1^\circ$	$20^\circ \pm 1^\circ$
Maximum area scan spatial resolution: $\Delta x_{Area}, \Delta y_{Area}$		≤ 2 GHz: ≤ 15 mm 2 – 3 GHz: ≤ 12 mm	3 – 4 GHz: ≤ 12 mm 4 – 6 GHz: ≤ 10 mm
		When the x or y dimension of the test device, in the measurement plane orientation, is smaller than the above, the measurement resolution must be \leq the corresponding x or y dimension of the test device with at least one measurement point on the test device.	
Maximum zoom scan spatial resolution: $\Delta x_{Zoom}, \Delta y_{Zoom}$		≤ 2 GHz: ≤ 8 mm 2 – 3 GHz: ≤ 5 mm*	3 – 4 GHz: ≤ 5 mm* 4 – 6 GHz: ≤ 4 mm*
Maximum zoom scan spatial resolution, normal to phantom surface	uniform grid: $\Delta z_{Zoom}(n)$	≤ 5 mm	3 – 4 GHz: ≤ 4 mm 4 – 5 GHz: ≤ 3 mm 5 – 6 GHz: ≤ 2 mm
	graded grid $\Delta z_{Zoom}(1)$: between 1 st two points closest to phantom surface	≤ 4 mm	3 – 4 GHz: ≤ 3 mm 4 – 5 GHz: ≤ 2.5 mm 5 – 6 GHz: ≤ 2 mm
	$\Delta z_{Zoom}(n>1)$: between subsequent points	$\leq 1.5 \cdot \Delta z_{Zoom}(n-1)$	
Minimum zoom scan volume	x, y, z	≥ 30 mm	3 – 4 GHz: ≥ 28 mm 4 – 5 GHz: ≥ 25 mm 5 – 6 GHz: ≥ 22 mm
<p>Note: δ is the penetration depth of a plane-wave at normal incidence to the tissue medium; see draft standard IEEE P1528-2011 for details.</p> <p>* When zoom scan is required and the <i>reported</i> SAR from the area scan based <i>1-g SAR estimation</i> procedures of KDB 447498 is ≤ 1.4 W/kg, ≤ 8 mm, ≤ 7 mm and ≤ 5 mm zoom scan resolution may be applied, respectively, for 2 GHz to 3 GHz, 3 GHz to 4 GHz and 4 GHz to 6 GHz.</p>			



9.4 Volume Scan Procedures

The volume scan is used for assess overlapping SAR distributions for antennas transmitting in different frequency bands. It is equivalent to an oversized zoom scan used in standalone measurements. The measurement volume will be used to enclose all the simultaneous transmitting antennas. For antennas transmitting simultaneously in different frequency bands, the volume scan is measured separately in each frequency band. In order to sum correctly to compute the 1g aggregate SAR, the EUT remain in the same test position for all measurements and all volume scan use the same spatial resolution and grid spacing. When all volume scan were completed, the software, SEMCAD postprocessor can combine and subsequently superpose these measurement data to calculating the multiband SAR.

9.5 SAR Averaged Methods

In DASy, the interpolation and extrapolation are both based on the modified Quadratic Shepard's method. The interpolation scheme combines a least-square fitted function method and a weighted average method which are the two basic types of computational interpolation and approximation.

Extrapolation routines are used to obtain SAR values between the lowest measurement points and the inner phantom surface. The extrapolation distance is determined by the surface detection distance and the probe sensor offset. The uncertainty increases with the extrapolation distance. To keep the uncertainty within 1% for the 1 g and 10 g cubes, the extrapolation distance should not be larger than 5 mm.

9.6 Power Drift Monitoring

All SAR testing is under the EUT install full charged battery and transmit maximum output power. In DASy measurement software, the power reference measurement and power drift measurement procedures are used for monitoring the power drift of EUT during SAR test. Both these procedures measure the field at a specified reference position before and after the SAR testing. The software will calculate the field difference in dB. If the power drifts more than 5%, the SAR will be retested.



10. Conducted RF Output Power (Unit: dBm)

<WLAN 2.4GHz SISO mode Conducted Power>

<Antenna A>

WLAN 2.4GHz 802.11b Average Power (dBm)						
Power vs. Channel			Power vs. Data Rate			
Channel	Frequency	Data Rate (bps)	Channel	Data Rate (bps)		
	(MHz)	1M		2M	5.5M	11M
CH 1	2412	13.64	CH 6	14.56	14.55	14.62
CH 6	2437	14.65				
CH 11	2462	14.19				

WLAN 2.4GHz 802.11g Average Power (dBm)										
Power vs. Channel			Power vs. Data Rate							
Channel	Frequency	Data Rate (bps)	Channel	Data Rate (bps)						
	(MHz)	6M		9M	12M	18M	24M	36M	48M	54M
CH 1	2412	11.76	CH 6	15.24	15.24	15.20	15.18	15.17	15.22	15.24
CH 6	2437	15.25								
CH 11	2462	12.31								

WLAN 2.4GHz 802.11n-HT20 Average Power (dBm)										
Power vs. Channel			Power vs. Data Rate							
Channel	Frequency	MCS Index	Channel	MCS Index						
	(MHz)	MCS8		MCS9	MCS10	MCS11	MCS12	MCS13	MCS14	MCS15
CH 1	2412	9.68	CH 6	15.02	15.10	15.09	15.11	15.11	15.10	15.09
CH 6	2437	15.12								
CH 11	2462	11.04								

WLAN 2.4GHz 802.11n-HT40 Average Power (dBm)										
Power vs. Channel			Power vs. Data Rate							
Channel	Frequency	MCS Index	Channel	MCS Index						
	(MHz)	MCS8		MCS9	MCS10	MCS11	MCS12	MCS13	MCS14	MCS15
CH 3	2422	6.67	CH 6	11.33	11.35	11.30	11.29	11.33	11.34	11.32
CH 6	2437	11.36								
CH 9	2452	6.89								

Note:

1. Per KDB 248227 D01 v01r02, choose the highest output power channel to test SAR and determine further SAR exclusion
2. For each frequency band, testing at higher data rates and higher order modulations is not required when the maximum average output power for each of these configurations is less than 1/4dB higher than those measured at the lowest data rate
3. Per KDB 248227 D01 v01r02, 11g and 11n-HT20 average output power is higher than 1/4dB higher than 11b mode, these modes SAR will be verified at the highest RF exposure position found in 802.11b SAR testing.
4. Per KDB 248227 D01 v01r02, 11n-HT40 output power is less than 1/4dB higher than 802.11b mode, thus the SAR can be excluded.

<Antenna B>

WLAN 2.4GHz 802.11b Average Power (dBm)						
Power vs. Channel			Power vs. Data Rate			
Channel	Frequency	Data Rate (bps)	Channel	Data Rate (bps)		
	(MHz)	1M		2M	5.5M	11M
CH 1	2412	13.52	CH 6	14.09	14.09	14.10
CH 6	2437	14.11				
CH 11	2462	13.92				

WLAN 2.4GHz 802.11g Average Power (dBm)										
Power vs. Channel			Power vs. Data Rate							
Channel	Frequency	Data Rate (bps)	Channel	Data Rate (bps)						
	(MHz)	6M		9M	12M	18M	24M	36M	48M	54M
CH 1	2412	11.84	CH 6	14.38	14.36	14.44	14.31	14.30	14.46	14.36
CH 6	2437	14.74								
CH 11	2462	11.89								

WLAN 2.4GHz 802.11n-HT20 Average Power (dBm)										
Power vs. Channel			Power vs. Data Rate							
Channel	Frequency	MCS Index	Channel	MCS Index						
	(MHz)	MCS8		MCS9	MCS10	MCS11	MCS12	MCS13	MCS14	MCS15
CH 1	2412	10.12	CH 6	14.51	14.52	14.24	14.23	14.29	14.28	14.30
CH 6	2437	14.56								
CH 11	2462	10.62								

WLAN 2.4GHz 802.11n-HT40 Average Power (dBm)										
Power vs. Channel			Power vs. Data Rate							
Channel	Frequency	MCS Index	Channel	MCS Index						
	(MHz)	MCS8		MCS9	MCS10	MCS11	MCS12	MCS13	MCS14	MCS15
CH 3	2422	6.65	CH 6	11.07	11.13	11.15	11.14	11.05	10.98	11.03
CH 6	2437	11.16								
CH 9	2452	6.88								

Note:

1. Per KDB 248227 D01 v01r02, choose the highest output power channel to test SAR and determine further SAR exclusion
2. For each frequency band, testing at higher data rates and higher order modulations is not required when the maximum average output power for each of these configurations is less than 1/4dB higher than those measured at the lowest data rate
3. Per KDB 248227 D01 v01r02, 11g and 11n-HT20 average output power is higher than 1/4dB higher than 11b mode, these modes SAR will be verified at the highest RF exposure position found in 802.11b SAR testing.
4. Per KDB 248227 D01 v01r02, 11n-HT40 output power is less than 1/4dB higher than 802.11b mode, thus the SAR can be excluded.



<WLAN 2.4GHz MIMO mode Conducted Power>

<Antenna 0+1>

WLAN 2.4GHz 802.11n-HT20 Average Power (dBm)										
Power vs. Channel			Power vs. Data Rate							
Channel	Frequency (MHz)	MCS Index MCS8	Channel	MCS Index						
				MCS9	MCS10	MCS11	MCS12	MCS13	MCS14	MCS15
CH 1	2412	13.59	CH 6	14.94	14.81	14.86	14.91	14.84	14.81	14.92
CH 6	2437	14.95								
CH 11	2462	13.00								

WLAN 2.4GHz 802.11n-HT40 Average Power (dBm)										
Power vs. Channel			Power vs. Data Rate							
Channel	Frequency (MHz)	MCS Index MCS8	Channel	MCS Index						
				MCS9	MCS10	MCS11	MCS12	MCS13	MCS14	MCS15
CH 3	2422	8.84	CH 6	13.94	14.00	14.02	14.02	14.01	14.01	14.07
CH 6	2437	14.10								
CH 9	2452	9.18								

Note:

1. Per KDB 248227 D01 v01r02, choose the highest output power channel to test SAR and determine further SAR exclusion
2. For each frequency band, testing at higher data rates and higher order modulations is not required when the maximum average output power for each of these configurations is less than 1/4dB higher than those measured at the lowest data rate
3. Per KDB 248227 D01 v01r02, 11n-HT40 output power is less than 1/4dB higher than 11n-HT20 mode, thus the SAR can be excluded.

<Bluetooth Conducted Power>

Channel	Frequency (MHz)	Average power (dBm)		
		Mode		
		GFSK	π/4-DQPSK	8-DPSK
CH 0	2402	5.95	1.62	1.72
CH 39	2441	6.10	2.22	2.29
CH 78	2480	6.06	2.54	2.61

Channel	Frequency (MHz)	Average power (dBm)
		Mode
		BT v4.0 LE, GFSK
CH 0	2402	5.82
CH 19	2440	6.27
CH 39	2480	6.17



<WLAN 5GHz SISO mode Conducted Power>

<Antenna A>

WLAN 5GHz 802.11a Average Power (dBm)										
Power vs. Channel			Power vs. Data Rate							
Channel	Frequency	Data Rate (bps)	Channel	Data Rate (bps)						
	(MHz)	6M		9M	12M	18M	24M	36M	48M	54M
CH 36	5180	12.92	CH 44	14.22	14.13	14.27	13.96	13.98	14.13	14.12
CH 40	5200	14.13								
CH 44	5220	14.32								
CH 48	5240	14.30								
CH 52	5260	14.29	CH 60	14.29	14.26	14.27	14.28	14.26	14.27	14.28
CH 56	5280	14.30								
CH 60	5300	14.31								
CH 64	5320	14.24								
CH 100	5500	14.48	CH 100	14.32	14.46	14.45	14.44	14.47	14.45	14.46
CH 104	5520	14.40								
CH 108	5540	14.34								
CH 112	5560	14.33								
CH 116	5580	14.46								
CH 132	5660	14.39								
CH 136	5680	14.20								
CH 140	5700	14.43								
CH 149	5745	14.52	CH 149	14.36	14.35	14.31	14.38	14.45	14.44	14.39
CH 153	5765	14.50								
CH 157	5785	14.19								
CH 161	5805	14.15								
CH 165	5825	14.18								

WLAN 5GHz 802.11n-HT20 Average Power (dBm)										
Power vs. Channel			Power vs. Data Rate							
Channel	Frequency	MCS Index	Channel	MCS Index						
	(MHz)	MCS0		MCS1	MCS2	MCS3	MCS4	MCS5	MCS6	MCS7
CH 36	5180	12.01	CH 44	14.31	14.26	14.19	14.20	14.22	14.25	14.27
CH 40	5200	14.34								
CH 44	5220	14.38								
CH 48	5240	14.32								
CH 52	5260	14.31	CH 60	14.28	14.31	14.22	14.20	14.17	14.19	14.20
CH 56	5280	14.28								
CH 60	5300	14.33								
CH 64	5320	13.88								
CH 100	5500	14.17	CH 116	13.99	13.89	13.87	13.86	13.85	13.86	13.85
CH 104	5520	14.01								
CH 108	5540	13.97								
CH 112	5560	14.07								
CH 116	5580	14.22								
CH 132	5660	14.21								
CH 136	5680	14.07								
CH 140	5700	14.18								
CH 149	5745	14.49	CH 149	14.35	14.37	14.43	14.46	14.48	14.33	14.16
CH 153	5765	14.42								
CH 157	5785	14.28								
CH 161	5805	14.49								
CH 165	5825	14.27								



WLAN 5GHz 802.11n-HT40 Average Power (dBm)										
Power vs. Channel			Power vs. Data Rate							
Channel	Frequency	MCS Index	Channel	MCS Index						
	(MHz)	MCS0		MCS1	MCS2	MCS3	MCS4	MCS5	MCS6	MCS7
CH 38	5190	9.82	CH 46	13.55	13.45	13.44	13.55	13.50	13.47	13.50
CH 46	5230	13.56								
CH 54	5270	13.77	CH 54	13.74	13.71	13.68	13.74	13.68	13.67	13.66
CH 62	5310	9.89								
CH 102	5510	11.18	CH 110	14.45	14.44	14.45	14.46	14.43	14.41	14.43
CH 110	5550	14.47								
CH 134	5670	14.41								
CH 151	5755	14.34	CH 159	14.41	14.41	14.40	14.38	14.41	14.42	14.43
CH 159	5795	14.44								

Note:

1. Per KDB 248227 D01 v01r02, choose the highest output power channel to test SAR and determine further SAR exclusion
2. For each frequency band, testing at higher data rates and higher order modulations is not required when the maximum average output power for each of these configurations is less than 1/4dB higher than those measured at the lowest data rate.
3. Per KDB 248227 D01 v01r02, 11n-HT20 and 11n-HT40 output power is less than 1/4dB higher than 802.11a mode, thus the SAR can be excluded.



<Antenna B>

WLAN 5GHz 802.11a Average Power (dBm)										
Power vs. Channel			Power vs. Data Rate							
Channel	Frequency	Data Rate (bps)	Channel	Data Rate (bps)						
	(MHz)	6M		9M	12M	18M	24M	36M	48M	54M
CH 36	5180	13.99	CH 40	14.19	14.21	14.18	14.13	14.17	14.18	14.18
CH 40	5200	14.23								
CH 44	5220	14.18								
CH 48	5240	14.14								
CH 52	5260	14.24	CH 60	14.34	14.32	14.33	14.22	14.25	14.33	14.29
CH 56	5280	14.15								
CH 60	5300	14.37								
CH 64	5320	14.31								
CH 100	5500	14.38								
CH 104	5520	14.00	CH 100	14.35	14.25	14.26	14.22	14.20	14.28	14.15
CH 108	5540	14.11								
CH 112	5560	13.90								
CH 116	5580	14.18								
CH 132	5660	14.14								
CH 136	5680	14.08								
CH 140	5700	14.36								
CH 149	5745	14.36	CH 165	14.39	14.39	14.36	14.37	14.38	14.36	14.37
CH 153	5765	14.36								
CH 157	5785	14.32								
CH 161	5805	14.37								
CH 165	5825	14.40								

WLAN 5GHz 802.11n-HT20 Average Power (dBm)										
Power vs. Channel			Power vs. Data Rate							
Channel	Frequency	MCS Index	Channel	MCS Index						
	(MHz)	MCS0		MCS1	MCS2	MCS3	MCS4	MCS5	MCS6	MCS7
CH 36	5180	13.33	CH 44	14.20	14.03	14.08	14.16	14.11	14.13	14.06
CH 40	5200	14.23								
CH 44	5220	14.25								
CH 48	5240	14.24								
CH 52	5260	14.10	CH 60	14.14	14.15	14.17	14.16	14.15	14.14	14.16
CH 56	5280	14.15								
CH 60	5300	14.18								
CH 64	5320	13.66								
CH 100	5500	14.00								
CH 104	5520	14.00	CH 140	14.03	13.86	13.90	13.92	14.00	14.02	14.01
CH 108	5540	14.11								
CH 112	5560	13.90								
CH 116	5580	14.11								
CH 132	5660	14.14								
CH 136	5680	14.08								
CH 140	5700	14.16								
CH 149	5745	14.21	CH 165	14.25	14.39	14.40	14.39	14.37	14.39	14.38
CH 153	5765	14.39								
CH 157	5785	14.19								
CH 161	5805	14.40								
CH 165	5825	14.41								



WLAN 5GHz 802.11n-HT40 Average Power (dBm)										
Power vs. Channel			Power vs. Data Rate							
Channel	Frequency	MCS Index	Channel	MCS Index						
	(MHz)	MCS0		MCS1	MCS2	MCS3	MCS4	MCS5	MCS6	MCS7
CH 38	5190	9.81	CH 46	13.51	13.48	13.39	13.48	13.45	13.49	13.46
CH 46	5230	13.52								
CH 54	5270	13.54	CH 54	13.53	13.53	13.52	13.48	13.45	13.47	13.40
CH 62	5310	9.48								
CH 102	5510	11.25	CH 110	14.23	14.22	14.18	14.19	14.21	14.17	14.16
CH 110	5550	14.24								
CH 134	5670	14.22								
CH 151	5755	14.30	CH 159	14.31	14.26	14.17	14.32	14.29	14.19	14.22
CH 159	5795	14.39								

Note:

1. Per KDB 248227 D01 v01r02, choose the highest output power channel to test SAR and determine further SAR exclusion
2. For each frequency band, testing at higher data rates and higher order modulations is not required when the maximum average output power for each of these configurations is less than 1/4dB higher than those measured at the lowest data rate.
3. Per KDB 248227 D01 v01r02, 11n-HT20 and 11n-HT40 output power is less than 1/4dB higher than 802.11a mode, thus the SAR can be excluded.



<WLAN 5GHz MIMO Mode Conducted Power>

<Antenna A+B>

WLAN 5GHz 802.11n-HT20 Average Power (dBm)										
Power vs. Channel			Power vs. Data Rate							
Channel	Frequency (MHz)	MCS Index MCS8	Channel	MCS Index						
				MCS9	MCS10	MCS11	MCS12	MCS13	MCS14	MCS15
CH 36	5180	14.19	CH 44	14.41	14.46	14.41	14.41	14.49	14.44	14.49
CH 40	5200	14.17								
CH 44	5220	14.53								
CH 48	5240	14.43								
CH 52	5260	14.33	CH 64	14.80	14.76	14.77	14.65	14.81	14.76	14.75
CH 56	5280	14.64								
CH 60	5300	14.58								
CH 64	5320	14.82								
CH 100	5500	14.89	CH 100	14.81	14.78	14.77	14.79	14.88	14.83	14.84
CH 104	5520	14.83								
CH 108	5540	14.88								
CH 112	5560	14.65								
CH 116	5580	14.67								
CH 132	5660	14.21								
CH 136	5680	14.86								
CH 140	5700	14.70								
CH 149	5745	13.53	CH 165	13.55	13.57	13.58	13.23	13.43	13.44	13.48
CH 153	5765	13.51								
CH 157	5785	13.42								
CH 161	5805	13.56								
CH 165	5825	13.59								

WLAN 5GHz 802.11n-HT40 Average Power (dBm)										
Power vs. Channel			Power vs. Data Rate							
Channel	Frequency (MHz)	MCS Index MCS8	Channel	MCS Index						
				MCS9	MCS10	MCS11	MCS12	MCS13	MCS14	MCS15
CH 38	5190	11.77	CH 46	14.27	14.21	14.14	14.21	14.29	14.26	14.38
CH 46	5230	14.44								
CH 54	5270	14.63	CH 54	14.52	14.54	14.55	14.62	14.62	14.56	14.60
CH 62	5310	12.07								
CH 102	5510	13.57	CH 110	14.41	14.39	14.30	14.42	14.41	14.39	14.41
CH 110	5550	14.43								
CH 134	5670	14.29								
CH 151	5755	14.12	CH 159	14.26	14.24	14.22	14.19	14.20	14.21	14.23
CH 159	5795	14.28								

Note:

1. Per KDB 248227 D01 v01r02, choose the highest output power channel to test SAR and determine further SAR exclusion
2. For each frequency band, testing at higher data rates and higher order modulations is not required when the maximum average output power for each of these configurations is less than 1/4dB higher than those measured at the lowest data rate.
3. Per KDB 248227 D01 v01r02, 11n-HT40 output power is less than 1/4dB higher than 802.11n-HT20 mode, thus the SAR can be excluded.

11. Exposure Positions Consideration

Edge 1

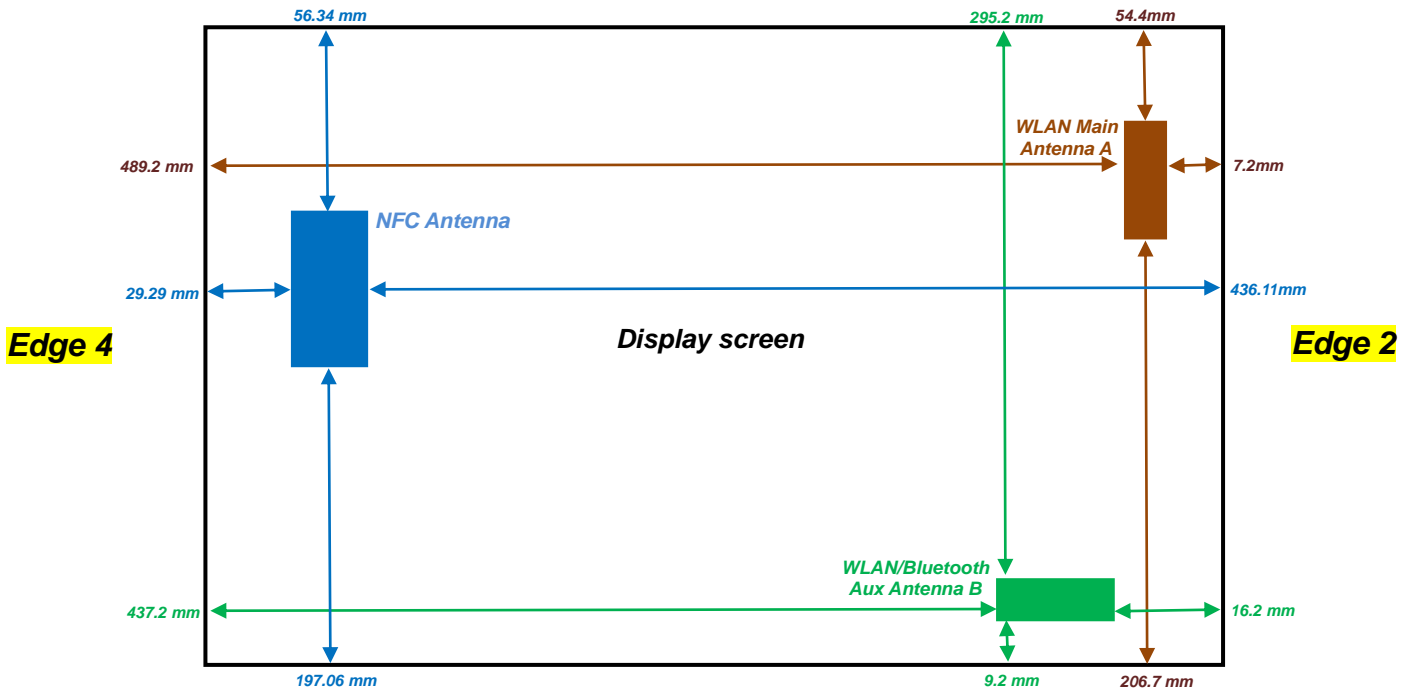

Edge 3

Front View

Antennas	Wireless Interface
WLAN Main Antenna A (Tx / Rx)	WLAN 2.4GHz WLAN5GHz
BT&WLAN Aux Antenna B (Tx / Rx)	WLAN 2.4GHz WLAN5GHz Bluetooth

<Standalone transmission configuration>

Wireless Interface	Antenna		
	SISO Mode Antenna A (Tx / Rx)	SISO Mode Antenna B (Tx / Rx)	MIMO Mode Antenna A+B (Tx / Rx)
2.4GHz Bluetooth		yes	
WLAN 2.4GHz 802.11b	yes	yes	
WLAN 2.4GHz 802.11g	yes	yes	
WLAN 2.4GHz 802.11 HT20/HT40	yes	yes	yes
WLAN 5GHz 802.11a	yes	yes	
WLAN 5GHz 802.11 HT20/HT40	yes	yes	yes



Exposure Position	Wireless Interface	802.11b Ant A	802.11b Ant B	802.11n Ant A+B	802.11a Ant A	802.11a Ant B	802.11a Ant A+B	Bluetooth Ant B
Exposure Position	Tune-up Maximum power (dBm)	15.5	15	15.5	14.5	14.5	15	7
	Tune-up Maximum rated power (mW)	35.48	31.62	35.48	28.18	28.18	31.62	5.01
Bottom Face	Antenna to user (mm)	5	5	5	5	5	5	5
	SAR exclusion threshold (mW)	10	10	10	6	6	6	10
	SAR testing required?	YES	YES	YES	YES	YES	YES	NO
Edge 1	Antenna to user (mm)	54.7	295.2	54.7	54.7	295.2	54.7	295.2
	SAR exclusion threshold (mW)	143	2548	143	109	2514	109	562
	SAR testing required?	NO	NO	NO	NO	NO	NO	NO
Edge 2	Antenna to user (mm)	7.2	16.2	7.2	7.2	16.2	7.2	16.2
	SAR exclusion threshold (mW)	14	31	14	9	20	9	31
	SAR testing required?	YES	YES	YES	YES	YES	YES	NO
Edge 3	Antenna to user (mm)	206.7	9.2	9.2	206.7	9.2	9.2	9.2
	SAR exclusion threshold (mW)	1663	18	18	1629	11	11	18
	SAR testing required?	NO	YES	YES	NO	YES	YES	NO
Edge 4	Antenna to user (mm)	489.2	437.2	437.2	489.2	437.2	437.2	437.2
	SAR exclusion threshold (mW)	4488	3968	3968	4454	3934	3934	833
	SAR testing required?	NO	NO	NO	NO	NO	NO	NO

Note:

- Maximum power is the source-based time-average power and represents the maximum RF output power among production units
- Per KDB 447498 D01v05, for larger devices, the *test separation distance* is determined by the closest separation between the antenna and the user.
- Per KDB 447498 D01v05, standalone SAR test exclusion threshold is applied; If the distance of the antenna to the user is < 5mm, 5mm is used to determine SAR exclusion threshold
- Per KDB 447498 D01v05, the 1-g and 10-g SAR test exclusion thresholds for 100 MHz to 6 GHz at *test separation distances* ≤ 50 mm are determined by:

$$[(\text{max. power of channel, including tune-up tolerance, mW}) / (\text{min. test separation distance, mm})] \cdot [\sqrt{f(\text{GHz})}] \leq 3.0$$
 for 1-g SAR and ≤ 7.5 for 10-g extremity SAR
 - f(GHz) is the RF channel transmit frequency in GHz
 - Power and distance are rounded to the nearest mW and mm before calculation
 - The result is rounded to one decimal place for comparison
- Per KDB 447498 D01v05, at 100 MHz to 6 GHz and for *test separation distances* > 50 mm, the SAR test exclusion threshold is determined according to the following
 - [Threshold at 50 mm in step 1) + (test separation distance - 50 mm) · (f(MHz)/150)] mW, at 100 MHz to 1500 MHz
 - [Threshold at 50 mm in step 1) + (test separation distance - 50 mm) · 10] mW at > 1500 MHz and ≤ 6 GHz

12. SAR Test Results

Note:

1. Per KDB 447498 D01v05, the reported SAR is the measured SAR value adjusted for maximum tune-up tolerance.
 $Scaling\ Factor = \frac{tune-up\ limit\ power\ (mW)}{EUT\ RF\ power\ (mW)}$, where tune-up limit is the maximum rated power among all production units.
 $Reported\ SAR(W/kg) = Measured\ SAR(W/kg) * Scaling\ Factor$
2. Per KDB 447498 D01v05, for each exposure position, if the highest output channel reported SAR $\leq 0.8W/kg$, other channels SAR testing is not necessary.
3. Per KDB 447498 D01v05, for each exposure position, testing of other required channels within the operating mode of a frequency band is not required when the reported 1-g or 10-g SAR for the mid-band or highest output power channel is:
 - $\leq 0.8\ W/kg$ or $2.0\ W/kg$, for 1-g or 10-g respectively, when the transmission band is $\leq 100\ MHz$
 - $\leq 0.6\ W/kg$ or $1.5\ W/kg$, for 1-g or 10-g respectively, when the transmission band is between $100\ MHz$ and $200\ MHz$
 - $\leq 0.4\ W/kg$ or $1.0\ W/kg$, for 1-g or 10-g respectively, when the transmission band is $\geq 200\ MHz$

Standalone SAR testing position					
Mode/Position	Bottom Face	Edge 1	Edge 2	Edge 3	Edge 4
SISO Mode Antenna A (Tx / Rx)	yes		yes		
SISO Mode Antenna B (Tx / Rx)	yes		yes	yes	
MIMO Mode Antenna A+B (Tx / Rx)	yes		yes	yes	

12.1 Test Records for Body SAR Test

<WLAN2.4GHz SAR>

Plot No.	Band	Mode	Test Position	Gap (cm)	Ant.	Ch.	Freq. (MHz)	Data Rate (bps)	Average Power (dBm)	Tune-Up Limit (dBm)	Tune-up Scaling Factor	Power Drift (dB)	Measured SAR 1g (W/kg)	Reported SAR 1g (W/kg)
1	WLAN2.4GHz	802.11b	Bottom Face	0cm	Ant A	6	2437	1M	14.65	15	1.083	0.07	0.046	0.050
2	WLAN2.4GHz	802.11b	Edge 2	0cm	Ant A	6	2437	1M	14.65	15	1.083	-0.03	0.153	0.166
3	WLAN2.4GHz	802.11g	Edge 2	0cm	Ant A	6	2437	6M	15.25	15.5	1.059	0.14	0.152	0.161
4	WLAN2.4GHz	802.11n-HT20	Edge 2	0cm	Ant A	6	2437	MCS0	15.12	15.5	1.090	0.04	0.145	0.158
7	WLAN2.4GHz	802.11b	Bottom Face	0cm	Ant B	6	2437	1M	14.11	14.5	1.093	0.12	0.016	0.017
8	WLAN2.4GHz	802.11b	Edge 2	0cm	Ant B	6	2437	1M	14.11	14.5	1.093	0.18	0.074	0.081
9	WLAN2.4GHz	802.11b	Edge 3	0cm	Ant B	6	2437	1M	14.11	14.5	1.093	-0.09	0.186	0.203
10	WLAN2.4GHz	802.11g	Edge 3	0cm	Ant B	6	2437	6M	14.74	15	1.062	-0.1	0.157	0.167
11	WLAN2.4GHz	802.11n-HT20	Edge 3	0cm	Ant B	6	2437	MCS0	14.56	15	1.106	-0.09	0.151	0.167
14	WLAN2.4GHz	802.11n-HT20	Bottom Face	0cm	Ant A+B	6	2437	MCS8	14.95	15	1.012	0.19	0.00516	0.005
15	WLAN2.4GHz	802.11n-HT20	Edge 2	0cm	Ant A+B	6	2437	MCS8	14.95	15	1.012	-0.04	0.071	0.072
16	WLAN2.4GHz	802.11n-HT20	Edge 3	0cm	Ant A+B	6	2437	MCS8	14.95	15	1.012	-0.13	0.08	0.081



<WLAN5GHz SAR>

Plot No.	Band	Mode	Test Position	Gap (cm)	Ant.	Ch.	Freq. (MHz)	Data Rate (bps)	Average Power (dBm)	Tune-Up Limit (dBm)	Tune-up Scaling Factor	Power Drift (dB)	Measured SAR 1g (W/kg)	Reported SAR 1g (W/kg)
19	WLAN5GHz	802.11a	Bottom Face	0cm	Ant A	44	5220	6M	14.32	14.5	1.043	-0.19	0.122	0.127
20	WLAN5GHz	802.11a	Edge 2	0cm	Ant A	44	5220	6M	14.32	14.5	1.043	-0.11	0.513	0.535
30	WLAN5GHz	802.11a	Bottom Face	0cm	Ant A	60	5300	6M	14.31	14.5	1.046	0.1	0.087	0.091
31	WLAN5GHz	802.11a	Edge 2	0cm	Ant A	60	5300	6M	14.31	14.5	1.046	-0.18	0.388	0.406
41	WLAN5GHz	802.11a	Bottom Face	0cm	Ant A	100	5500	6M	14.48	14.5	1.005	0.147	0.138	0.139
42	WLAN5GHz	802.11a	Edge 2	0cm	Ant A	100	5500	6M	14.48	14.5	1.005	0.05	0.475	0.478
43	WLAN5GHz	802.11a	Edge 2	0cm	Ant A	116	5580	6M	14.46	14.5	1.009	0.1	0.599	0.605
44	WLAN5GHz	802.11a	Edge 2	0cm	Ant A	140	5700	6M	14.43	14.5	1.016	0.18	0.666	0.677
55	WLAN5GHz	802.11a	Bottom Face	0cm	Ant A	149	5745	6M	14.52	15	1.118	0.154	0.167	0.187
56	WLAN5GHz	802.11a	Edge 2	0cm	Ant A	149	5745	6M	14.52	15	1.118	0.06	0.743	0.830
57	WLAN5GHz	802.11a	Edge 2	0cm	Ant A	157	5785	6M	14.19	15	1.206	0.07	0.669	0.807
58	WLAN5GHz	802.11a	Edge 2	0cm	Ant A	165	5825	6M	14.18	15	1.209	0.19	0.565	0.683
23	WLAN5GHz	802.11a	Bottom Face	0cm	Ant B	40	5200	6M	14.23	14.5	1.064	0.12	0.065	0.069
22	WLAN5GHz	802.11a	Edge 2	0cm	Ant B	40	5200	6M	14.23	14.5	1.064	-0.13	0.135	0.144
24	WLAN5GHz	802.11a	Edge 3	0cm	Ant B	40	5200	6M	14.23	14.5	1.064	0.152	0.596	0.634
33	WLAN5GHz	802.11a	Bottom Face	0cm	Ant B	60	5300	6M	14.37	14.5	1.031	-0.128	0.075	0.077
34	WLAN5GHz	802.11a	Edge 2	0cm	Ant B	60	5300	6M	14.37	14.5	1.031	-0.153	0.188	0.194
35	WLAN5GHz	802.11a	Edge 3	0cm	Ant B	60	5300	6M	14.37	14.5	1.031	-0.131	0.891	0.919
36	WLAN5GHz	802.11a	Edge 3	0cm	Ant B	52	5260	6M	14.24	14.5	1.062	0.1	0.698	0.741
45	WLAN5GHz	802.11a	Bottom Face	0cm	Ant B	100	5500	6M	14.38	14.5	1.029	0.12	0.056	0.058
46	WLAN5GHz	802.11a	Edge 2	0cm	Ant B	100	5500	6M	14.38	14.5	1.029	0.19	0.152	0.156
47	WLAN5GHz	802.11a	Edge 3	0cm	Ant B	100	5500	6M	14.38	14.5	1.029	0.04	0.435	0.448
48	WLAN5GHz	802.11a	Edge 3	0cm	Ant B	116	5580	6M	14.18	14.5	1.076	0.06	0.646	0.695
49	WLAN5GHz	802.11a	Edge 3	0cm	Ant B	140	5700	6M	14.36	14.5	1.033	0.05	0.617	0.637
59	WLAN5GHz	802.11a	Bottom Face	0cm	Ant B	165	5825	6M	14.40	14.5	1.024	0.1	0.092	0.094
60	WLAN5GHz	802.11a	Edge 2	0cm	Ant B	165	5825	6M	14.40	14.5	1.024	0.19	0.212	0.217
61	WLAN5GHz	802.11a	Edge 3	0cm	Ant B	165	5825	6M	14.40	14.5	1.024	-0.11	0.485	0.497
26	WLAN5GHz	802.11n-HT20	Bottom Face	0cm	Ant A+B	44	5220	MCS8	14.53	15	1.114	0.17	0.07	0.078
27	WLAN5GHz	802.11n-HT20	Edge 2	0cm	Ant A+B	44	5220	MCS8	14.53	15	1.114	-0.05	0.245	0.273
28	WLAN5GHz	802.11n-HT20	Edge 3	0cm	Ant A+B	44	5220	MCS8	14.53	15	1.114	0.12	0.357	0.398
37	WLAN5GHz	802.11n-HT20	Bottom Face	0cm	Ant A+B	64	5320	MCS8	14.82	15	1.042	0.18	0.097	0.101
38	WLAN5GHz	802.11n-HT20	Edge 2	0cm	Ant A+B	64	5320	MCS8	14.82	15	1.042	-0.1	0.336	0.350
39	WLAN5GHz	802.11n-HT20	Edge 3	0cm	Ant A+B	64	5320	MCS8	14.82	15	1.042	-0.07	0.496	0.517
50	WLAN5GHz	802.11n-HT20	Bottom Face	0cm	Ant A+B	100	5500	MCS8	14.89	15	1.027	0.123	0.131	0.134
51	WLAN5GHz	802.11n-HT20	Edge 2	0cm	Ant A+B	100	5500	MCS8	14.89	15	1.027	0.14	0.312	0.320
52	WLAN5GHz	802.11n-HT20	Edge 3	0cm	Ant A+B	100	5500	MCS8	14.89	15	1.027	0.04	0.378	0.388
64	WLAN5GHz	802.11n-HT20	Bottom Face	0cm	Ant A+B	165	5825	MCS8	13.59	14	1.098	0.135	0.076	0.083
65	WLAN5GHz	802.11n-HT20	Edge 2	0cm	Ant A+B	165	5825	MCS8	13.59	14	1.098	0.16	0.235	0.258
66	WLAN5GHz	802.11n-HT20	Edge 3	0cm	Ant A+B	165	5825	MCS8	13.59	14	1.098	0.18	0.245	0.269



12.2 Repeated SAR Measurement

Plot No.	Band	Mode	Test Position	Gap (cm)	Ant.	Ch.	Freq. (MHz)	Data Rate (bps)	Average Power (dBm)	Tune-Up Limit (dBm)	Tune-up Scaling Factor	Power Drift (dB)	Measured SAR 1g (W/kg)	Ratio	Reported SAR 1g (W/kg)
35	WLAN5GHz	802.11a	Edge 3	0cm	Ant B	60	5300	6M	14.37	14.5	1.031	-0.131	0.891	1	0.919
67	WLAN5GHz	802.11a	Edge 3	0cm	Ant B	60	5300	6M	14.37	14.5	1.031	-0.125	0.885	1.01	0.913

Note:

1. Per KDB 865664 D01v01, for each frequency band, repeated SAR measurement is required only when the measured SAR is $\geq 0.8W/kg$
2. Per KDB 865664 D01v01, if the ratio among the repeated measurement is ≤ 1.2 and the measured SAR $< 1.45W/kg$, only one repeated measurement is required.
3. The deviation is the difference in percentage between original and repeated *measured SAR*.
4. All measurement SAR result is scaled-up to account for tune-up tolerance and is compliant.

12.3 Highest SAR Plot

Test Laboratory: Sporton International Inc. SAR/HAC Testing Lab

Date: 2013/3/5

#35_WLAN5G_802.11a_Edge 3_0cm_Ch60;Ant B

DUT: 322001

Communication System: 802.11a; Frequency: 5300 MHz; Duty Cycle: 1:1
 Medium: MSL_5G_130305 Medium parameters used: $f = 5300$ MHz; $\sigma = 5.27$ S/m; $\epsilon_r = 47.255$; $\rho = 1000$ kg/m³
 Ambient Temperature : 22.3 °C; Liquid Temperature : 21.3 °C

DASY5 Configuration:

- Probe: EX3DV4 - SN3697; ConvF(4.29, 4.29, 4.29); Calibrated: 2012/9/28;
- Sensor-Surface: 1.4mm (Mechanical Surface Detection)
- Electronics: DAE4 Sn1279; Calibrated: 2013/1/28
- Phantom: ELI v4.0; Type: QDOVA001BB; Serial: 1173
- Measurement SW: DASY52, Version 52.8 (4); SEMCAD X Version 14.6.8 (7028)

Configuration/Ch60/Area Scan (81x201x1): Interpolated grid: dx=1.000 mm, dy=1.000 mm
 Maximum value of SAR (interpolated) = 2.00 W/kg

Configuration/Ch60/Zoom Scan (7x7x7)/Cube 0: Measurement grid: dx=4mm, dy=4mm, dz=1.4mm
 Reference Value = 18.069 V/m; Power Drift = -0.131 dB
 Peak SAR (extrapolated) = 3.26 W/kg
SAR(1 g) = 0.891 W/kg; SAR(10 g) = 0.323 W/kg
 Maximum value of SAR (measured) = 1.99 W/kg

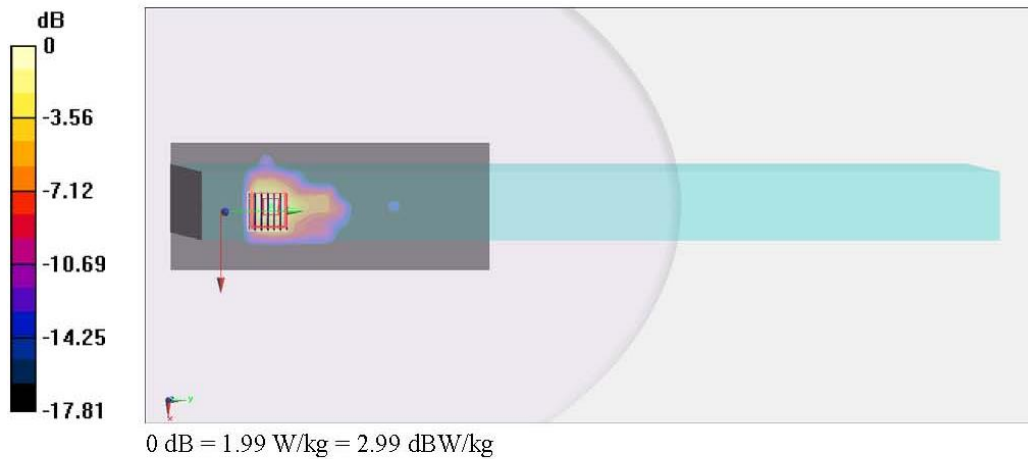

Test Laboratory: Sporton International Inc. SAR/HAC Testing Lab

Date: 2013/3/1

#09_WLAN2.4G_802.11b_Edge 3_0cm_Ch6;Ant B

DUT: 322001

Communication System: 802.11b; Frequency: 2437 MHz; Duty Cycle: 1:1
 Medium: MSL_2450_130301 Medium parameters used: $f = 2437$ MHz; $\sigma = 1.945$ mho/m; $\epsilon_r = 52.941$; $\rho = 1000$ kg/m³
 Ambient Temperature : 22.6 °C; Liquid Temperature : 21.6 °C

DASY5 Configuration:

- Probe: ES3DV3 - SN3270; ConvF(4.17, 4.17, 4.17); Calibrated: 2012/9/28;
- Sensor-Surface: 3mm (Mechanical Surface Detection)
- Electronics: DAE4 Sn778; Calibrated: 2012/8/27
- Phantom: ELI 4.0_Front; Type: QDOVA001BB; Serial: 1026
- Measurement SW: DASY52, Version 52.8 (2); SEMCAD X Version 14.6.6 (6477)

Configuration/Ch6/Area Scan (71x181x1): Measurement grid: dx=12mm, dy=12mm
 Maximum value of SAR (interpolated) = 0.238 mW/g

Configuration/Ch6/Zoom Scan (7x7x7)/Cube 0: Measurement grid: dx=5mm, dy=5mm, dz=5mm

Reference Value = 11.267 V/m; Power Drift = -0.09 dB

Peak SAR (extrapolated) = 0.363 mW/g

SAR(1 g) = 0.186 mW/g; SAR(10 g) = 0.098 mW/g

Maximum value of SAR (measured) = 0.234 mW/g

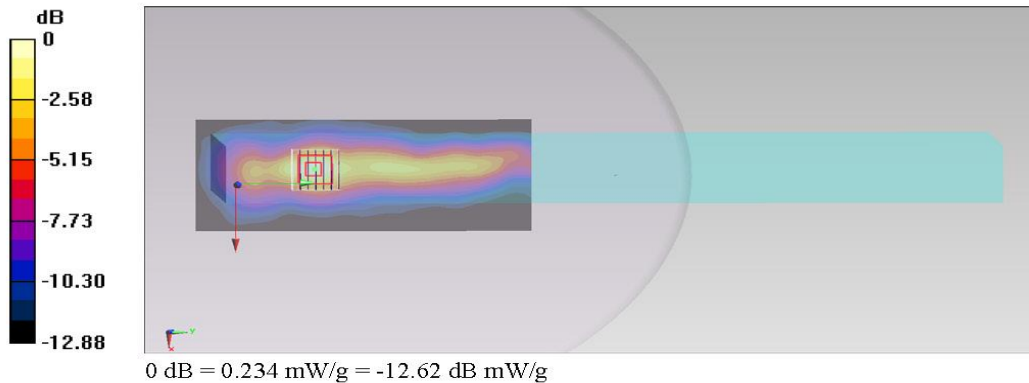



12.4 Simultaneous Multi-band Transmission Analysis

No.	Applicable Simultaneous Transmission Combination
1.	None

Note:

1. WLAN and Bluetooth share the same Aux antenna B, and cannot transmit simultaneously.
2. WLAN Main Antenna and Bluetooth Aux Antenna cannot transmit simultaneously.
3. EUT will choose either WLAN 2.4GHz or WLAN 5GHz according to the network signal condition; therefore, they will not transmit simultaneously.

Test Engineer : Michael Yang and Nick Yu

13. Uncertainty Assessment

The component of uncertainty may generally be categorized according to the methods used to evaluate them. The evaluation of uncertainty by the statistical analysis of a series of observations is termed a Type A evaluation of uncertainty. The evaluation of uncertainty by means other than the statistical analysis of a series of observations is termed a Type B evaluation of uncertainty. Each component of uncertainty, however evaluated, is represented by an estimated standard deviation, termed standard uncertainty, which is determined by the positive square root of the estimated variance.

A Type A evaluation of standard uncertainty may be based on any valid statistical method for treating data. This includes calculating the standard deviation of the mean of a series of independent observations; using the method of least squares to fit a curve to the data in order to estimate the parameter of the curve and their standard deviations; or carrying out an analysis of variance in order to identify and quantify random effects in certain kinds of measurement.

A type B evaluation of standard uncertainty is typically based on scientific judgment using all of the relevant information available. These may include previous measurement data, experience, and knowledge of the behavior and properties of relevant materials and instruments, manufacture’s specification, data provided in calibration reports and uncertainties assigned to reference data taken from handbooks. Broadly speaking, the uncertainty is either obtained from an outdoor source or obtained from an assumed distribution, such as the normal distribution, rectangular or triangular distributions indicated in Table 12.1

Uncertainty Distributions	Normal	Rectangular	Triangular	U-Shape
Multi-plying Factor ^(a)	1/k ^(b)	1/√3	1/√6	1/√2

(a) standard uncertainty is determined as the product of the multiplying factor and the estimated range of variations in the measured quantity

(b) κ is the coverage factor

Table 13.1 Standard Uncertainty for Assumed Distribution

The combined standard uncertainty of the measurement result represents the estimated standard deviation of the result. It is obtained by combining the individual standard uncertainties of both Type A and Type B evaluation using the usual “root-sum-squares” (RSS) methods of combining standard deviations by taking the positive square root of the estimated variances.

Expanded uncertainty is a measure of uncertainty that defines an interval about the measurement result within which the measured value is confidently believed to lie. It is obtained by multiplying the combined standard uncertainty by a coverage factor. Typically, the coverage factor ranges from 2 to 3. Using a coverage factor allows the true value of a measured quantity to be specified with a defined probability within the specified uncertainty range. For purpose of this document, a coverage factor two is used, which corresponds to confidence interval of about 95 %. The DASY uncertainty Budget is shown in the following tables.



Error Description	Uncertainty	Probability	Divisor	Ci	Ci	Standard	Standard
	Value	Distribution		(1g)	(10g)	Uncertainty	Uncertainty
	(±%)					(1g)	(10g)
Measurement System							
Probe Calibration	6.0	Normal	1	1	1	± 6.0 %	± 6.0 %
Axial Isotropy	4.7	Rectangular	√3	0.7	0.7	± 1.9 %	± 1.9 %
Hemispherical Isotropy	9.6	Rectangular	√3	0.7	0.7	± 3.9 %	± 3.9 %
Boundary Effects	1.0	Rectangular	√3	1	1	± 0.6 %	± 0.6 %
Linearity	4.7	Rectangular	√3	1	1	± 2.7 %	± 2.7 %
System Detection Limits	1.0	Rectangular	√3	1	1	± 0.6 %	± 0.6 %
Readout Electronics	0.3	Normal	1	1	1	± 0.3 %	± 0.3 %
Response Time	0.8	Rectangular	√3	1	1	± 0.5 %	± 0.5 %
Integration Time	2.6	Rectangular	√3	1	1	± 1.5 %	± 1.5 %
RF Ambient Noise	3.0	Rectangular	√3	1	1	± 1.7 %	± 1.7 %
RF Ambient Reflections	3.0	Rectangular	√3	1	1	± 1.7 %	± 1.7 %
Probe Positioner	0.4	Rectangular	√3	1	1	± 0.2 %	± 0.2 %
Probe Positioning	2.9	Rectangular	√3	1	1	± 1.7 %	± 1.7 %
Max. SAR Eval.	1.0	Rectangular	√3	1	1	± 0.6 %	± 0.6 %
Test Sample Related							
Device Positioning	2.9	Normal	1	1	1	± 2.9 %	± 2.9 %
Device Holder	3.6	Normal	1	1	1	± 3.6 %	± 3.6 %
Power Drift	5.0	Rectangular	√3	1	1	± 2.9 %	± 2.9 %
Phantom and Setup							
Phantom Uncertainty	4.0	Rectangular	√3	1	1	± 2.3 %	± 2.3 %
Liquid Conductivity (Target)	5.0	Rectangular	√3	0.64	0.43	± 1.8 %	± 1.2 %
Liquid Conductivity (Meas.)	2.5	Normal	1	0.64	0.43	± 1.6 %	± 1.1 %
Liquid Permittivity (Target)	5.0	Rectangular	√3	0.6	0.49	± 1.7 %	± 1.4 %
Liquid Permittivity (Meas.)	2.5	Normal	1	0.6	0.49	± 1.5 %	± 1.2 %
Combined Standard Uncertainty						± 11.0 %	± 10.8 %
Coverage Factor for 95 %						K=2	
Expanded Uncertainty						± 22.0 %	± 21.5 %

Table 13.2 Uncertainty Budget for frequency range 300 MHz to 3 GHz



Error Description	Uncertainty	Probability	Divisor	Ci	Ci	Standard	Standard
	Value	Distribution		(1g)	(10g)	Uncertainty	Uncertainty
	(±%)					(1g)	(10g)
Measurement System							
Probe Calibration	6.55	Normal	1	1	1	± 6.55 %	± 6.55 %
Axial Isotropy	4.7	Rectangular	√3	0.7	0.7	± 1.9 %	± 1.9 %
Hemispherical Isotropy	9.6	Rectangular	√3	0.7	0.7	± 3.9 %	± 3.9 %
Boundary Effects	2.0	Rectangular	√3	1	1	± 1.2 %	± 1.2 %
Linearity	4.7	Rectangular	√3	1	1	± 2.7 %	± 2.7 %
System Detection Limits	1.0	Rectangular	√3	1	1	± 0.6 %	± 0.6 %
Readout Electronics	0.3	Normal	1	1	1	± 0.3 %	± 0.3 %
Response Time	0.8	Rectangular	√3	1	1	± 0.5 %	± 0.5 %
Integration Time	2.6	Rectangular	√3	1	1	± 1.5 %	± 1.5 %
RF Ambient Noise	3.0	Rectangular	√3	1	1	± 1.7 %	± 1.7 %
RF Ambient Reflections	3.0	Rectangular	√3	1	1	± 1.7 %	± 1.7 %
Probe Positioner	0.8	Rectangular	√3	1	1	± 0.5 %	± 0.5 %
Probe Positioning	9.9	Rectangular	√3	1	1	± 5.7 %	± 5.7 %
Max. SAR Eval.	4.0	Rectangular	√3	1	1	± 2.3 %	± 2.3 %
Test Sample Related							
Device Positioning	2.9	Normal	1	1	1	± 2.9 %	± 2.9 %
Device Holder	3.6	Normal	1	1	1	± 3.6 %	± 3.6 %
Power Drift	5.0	Rectangular	√3	1	1	± 2.9 %	± 2.9 %
Phantom and Setup							
Phantom Uncertainty	4.0	Rectangular	√3	1	1	± 2.3 %	± 2.3 %
Liquid Conductivity (Target)	5.0	Rectangular	√3	0.64	0.43	± 1.8 %	± 1.2 %
Liquid Conductivity (Meas.)	2.5	Normal	1	0.64	0.43	± 1.6 %	± 1.1 %
Liquid Permittivity (Target)	5.0	Rectangular	√3	0.6	0.49	± 1.7 %	± 1.4 %
Liquid Permittivity (Meas.)	2.5	Normal	1	0.6	0.49	± 1.5 %	± 1.2 %
Combined Standard Uncertainty						± 12.8 %	± 12.6 %
Coverage Factor for 95 %						K=2	
Expanded Uncertainty						± 25.6 %	± 25.2 %

Table 13.3 Uncertainty Budget for frequency range 3 GHz to 6 GHz



14. References

- [1] FCC 47 CFR Part 2 “Frequency Allocations and Radio Treaty Matters; General Rules and Regulations”
- [2] ANSI/IEEE Std. C95.1-1992, “IEEE Standard for Safety Levels with Respect to Human Exposure to Radio Frequency Electromagnetic Fields, 3 kHz to 300 GHz”, September 1992
- [3] IEEE Std. 1528-2003, “Recommended Practice for Determining the Peak Spatial-Average Specific Absorption Rate (SAR) in the Human Head from Wireless Communications Devices: Measurement Techniques”, December 2003
- [4] FCC OET Bulletin 65 (Edition 97-01) Supplement C (Edition 01-01), “Evaluating Compliance with FCC Guidelines for Human Exposure to Radiofrequency Electromagnetic Fields”, June 2001
- [5] SPEAG DASY System Handbook
- [6] FCC KDB 248227 D01 v01r02, “SAR Measurement Procedures for 802.11 a/b/g Transmitters”, May 2007
- [7] FCC KDB 447498 D01 v05, “Mobile and Portable Device RF Exposure Procedures and Equipment Authorization Policies”, October 2012



Appendix A. Plots of System Performance Check

The plots are shown as follows.



Appendix B. Plots of SAR Measurement

The plots are shown as follows.



Appendix C. DASYS Calibration Certificate

The DASYS calibration certificates are shown as follows.