

## SRS-XB402G/SRS-XB402M 机铭牌

Image of the product bottom

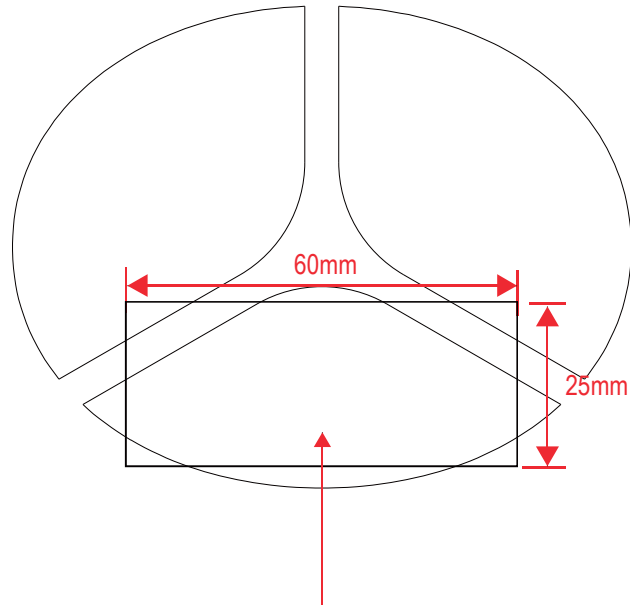

机铭牌信息丝印在硅胶垫表面

The nameplate information(FCC ID,IC, statement ect.)will be printed on the bottom of the product.

# XBH3机铭牌

SRS-XB402M(EU8/AU4/IN5)  
 NAMEPLATE  
 2018.12.25

(SONY EU住所変更済)

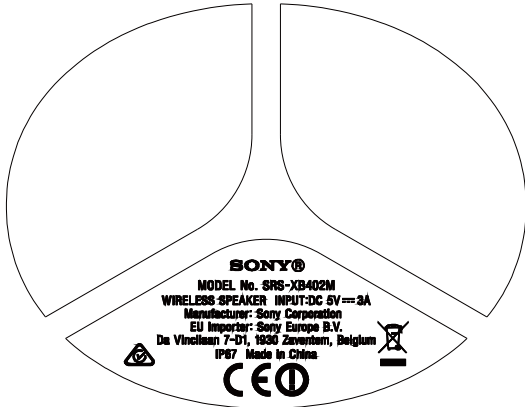

SRS-XB402M(J4)  
 NAMEPLATE  
 2018.12.20

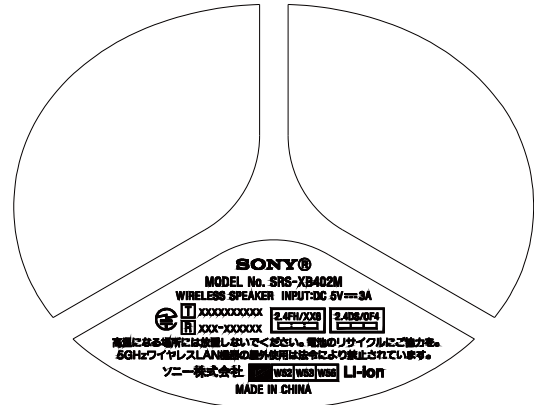

SRS-XB402M(UC\_LA)  
 NAMEPLATE  
 2018.12.20

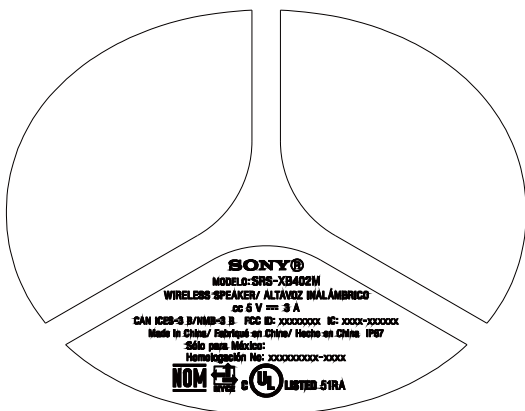

SRS-XB402M(UC)  
 NAMEPLATE  
 2018.12.20

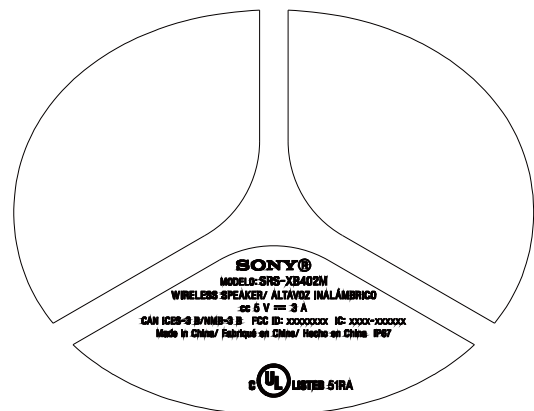

SRS-XB402G(J4)  
NAMEPLATE  
2018.12.25

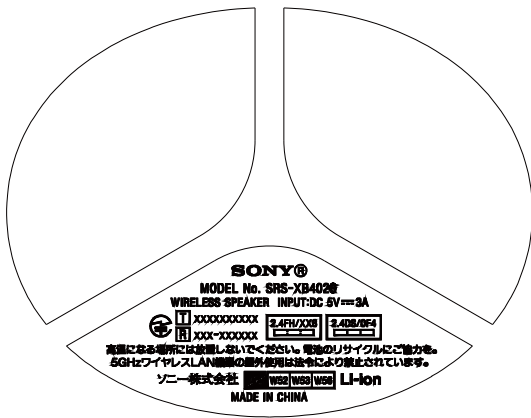

SRS-XB402G(UC)  
NAMEPLATE  
2018.12.25

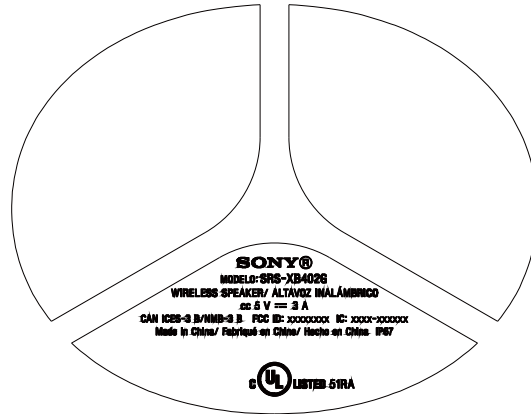

SRS-XB402G(UC\_LA7)  
NAMEPLATE  
2018.12.25

