

Support pages

Find information on software updates:

<https://www.sony.com/electronics/support>

Pages d'assistance

Trouvez des informations sur les mises à jour de logiciel :

Páginas de soporte

Encuentre información sobre las actualizaciones de software:

Smartphone app

Support by Sony app - Find information and get notification about your product:

Appli de téléphone intelligent

Appli Support by Sony - Trouvez des informations et obtenez des notifications au sujet de votre produit :

Aplicación para smartphone

Aplicación "Support by Sony" - Encuentre información y reciba notificaciones de su producto:



- News & Alerts / Nouvelles & Alertes / Noticias y alertas
- Software updates / Mises à jour de logiciel / Actualizaciones de software
- Tutorials / Tutoriels / Tutoriales
- Tips & Tricks / Trucs & Conseils / Sugerencias y trucos

<https://sony.net/SBS>



©2020 Sony Corporation Printed in China

5-013-058-11(1)

HT-G700
5-013-058-11(1)

SONY

Sound Bar

SONY®

Sound Bar

Operating Instructions US

Manuel d'instructions FR

Manual de instrucciones ES



HT-G700

HT-G700
5-013-058-11(1)

Owner's Record

The model and serial numbers are located on the bottom of the bar speaker. Record the serial numbers in the space provided below. Refer to them whenever you call upon your Sony dealer regarding the Sound Bar.

Model No. HT-G700 _____

Serial No. _____

WARNING

To reduce the risk of fire or electric shock, do not expose this system to rain or moisture.

The system is not disconnected from the mains as long as it is connected to the AC outlet, even if the system itself has been turned off.

To reduce the risk of fire, do not cover the ventilation opening of the system with newspapers, tablecloths, curtains, etc.

Do not expose the system to naked flame sources (for example, lighted candles).

To reduce the risk of fire or electric shock, do not expose this system to dripping or splashing, and do not place objects filled with liquids, such as vases, on the system.

As the main plug is used to disconnect the system from the mains, connect the system to an easily accessible AC outlet. Should you notice an abnormality in the system, disconnect the main plug from the AC outlet immediately.

Do not install the system in a confined space, such as a bookcase or built-in cabinet.

CAUTION

Risk of explosion if the battery is replaced by an incorrect type. Do not expose batteries or appliances with battery-installed to excessive heat, such as sunshine and fire.

Do not place this product close to medical devices.

This product (including accessories) has magnet(s) which may interfere with pacemakers, programmable shunt valves for hydrocephalus treatment, or other medical devices. Do not place this product close to persons who use such medical devices. Consult your doctor before using this product if you use any such medical device.

Indoor use only.

For the bar speaker

The nameplate is located on the bottom of the bar speaker.

For the customers in the U.S.A.

NOTE:

This system has been tested and found to comply with the limits for a Class B digital device, pursuant to Part 15 of the FCC Rules. These limits are designed to provide reasonable protection against harmful interference in a residential installation. This system generates, uses and can radiate radio frequency energy and, if not installed and used in accordance with the instructions, may cause harmful interference to radio communications.

However, there is no guarantee that interference will not occur in a particular installation. If this system does cause harmful interference to radio or television reception, which can be determined by turning the system off and on, the user is encouraged to try to correct the interference by one or more of the following measures:

- Reorient or relocate the receiving antenna.
- Increase the separation between the system and receiver.
- Connect the system into an outlet on a circuit different from that to which the receiver is connected.
- Consult the dealer or an experienced radio/TV technician for help.

Properly shielded and grounded cables and connectors must be used for connection to host computers and/or peripherals in order to meet FCC emission limits.

If you have any questions about this Sound Bar:

Visit: www.sony.com/support

Contact: Sony Customer Information Service Center at 1-800-222-SONY (7669)

Write: Sony Customer Information Service Center 12451 Gateway Blvd., Fort Myers, FL 33913

Supplier's Declaration of Conformity

Trade Name: SONY

Model No.: HT-G700

Responsible Party: Sony Electronics Inc.

Address: 16535 Via Esprillo, San Diego, CA 92127 USA

Telephone No.: 858-942-2230

This device complies with Part 15 of the FCC Rules. Operation is subject to the following two conditions: (1) This device may not cause harmful interference, and (2) this device must accept any interference received, including interference that may cause undesired operation.

CAUTION

You are cautioned that any changes or modifications not expressly approved in this manual could void your authority to operate this system.

This system must not be co-located or operated in conjunction with any other antenna or transmitter.

This system complies with FCC radiation exposure limits set forth for an uncontrolled environment and meets the FCC radio frequency (RF) Exposure Guidelines. This system should be installed and operated keeping the radiator at least 20cm or more away from person's body.

For the customers in Canada

Properly shielded and grounded cables and connectors must be used for connection to host computers and/or peripherals.

This system contains licence-exempt transmitter(s)/receiver(s) that comply with Innovation, Science and Economic Development Canada's license-exempt RSS(s). Operation is subject to the following two conditions:

- (1) This system may not cause interference; and
- (2) This system must accept any interference, including interference that may cause undesired operation of the system.

This system complies with ISED radiation exposure limits set forth for an uncontrolled environment and meets RSS-102 of the ISED radio frequency (RF) Exposure rules. This system should be installed and operated keeping the radiator at least 20cm or more away from person's body.

US

Table of Contents

About These Operating Instructions	5
What's in the Box	6
What You Can Do with the System	7
Guide to Parts and Controls	8

Installing the System

Installing the Bar Speaker and Subwoofer	Startup Guide (separate document)
Mounting the Bar Speaker on a Wall	13
Connecting the Subwoofer	15
When the TV Remote Control does not Work	16

Connecting to a TV or AV Device

Connecting to a TV or AV Device with the HDMI Cable	Startup Guide (separate document)
Connecting Sony TV with the BLUETOOTH Function Wirelessly	17
Connecting a 4K TV and 4K Devices	20

Listening to Music/Sound

Listening to a TV and Other Devices	22
Adjusting the Volume	23
Enjoying Multiplex Broadcast Sound (AUDIO)	23
Listening to Music/Sound with the BLUETOOTH® Function	24

Adjusting the Sound Quality

Enjoying Immersive Surround Experience (IMMERSIVE AE)	27
Setting the Sound Effect that is Tailored to Sound Sources (Sound Mode)	28
Making Dialogs Clearer (VOICE)	29
Enjoying Clear Sound with Low Volume at Midnight (NIGHT)	29
Checking the Current Sound Settings (DISPLAY)	30

Using the Control for HDMI Function

Using the Control for HDMI Function	31
Using the "BRAVIA" Sync Function	33

Changing the Settings

Using the Setting Menu	34
Changing the Brightness of the Front Panel Display and Indicators (DIMMER)	38
Saving Power in Standby Mode	38

Troubleshooting

Troubleshooting	39
Resetting the System	45

Additional Information

Specifications	46
Supported Input Audio	
Formats	48
Supported HDMI Video	
Formats	49
On BLUETOOTH	
Communication	51
END USER LICENSE	
AGREEMENT	52
Precautions	56
Index	59

About These Operating Instructions

- The instructions in these Operating Instructions describe the controls on the remote control.
- Some illustrations are presented as conceptual drawings, and may be different from the actual products.
- The default settings are underlined on each feature description.
- Characters in brackets [] appear on the front panel display.

What's in the Box

- Bar speaker (1)

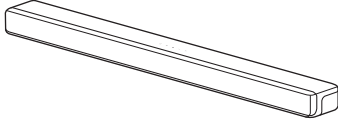

- Subwoofer (1)

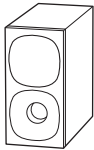

- Remote control (1)/
R03 (size AAA) battery (2)

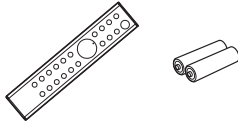

- HDMI cable (supports the specification
equal to Premium High Speed HDMI
Cable with Ethernet) (1)

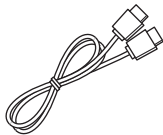

- AC power cord (mains lead) (2)

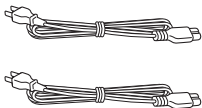

- WALL MOUNT TEMPLATE (1)

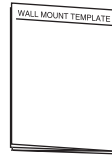

- Startup Guide



- Operating Instructions (this
document)



6^{US}

What You Can Do with the System

The system supports object-based audio formats such as Dolby Atmos and DTS:X as well as HDR video formats such as HDR10, HLG, and Dolby Vision.

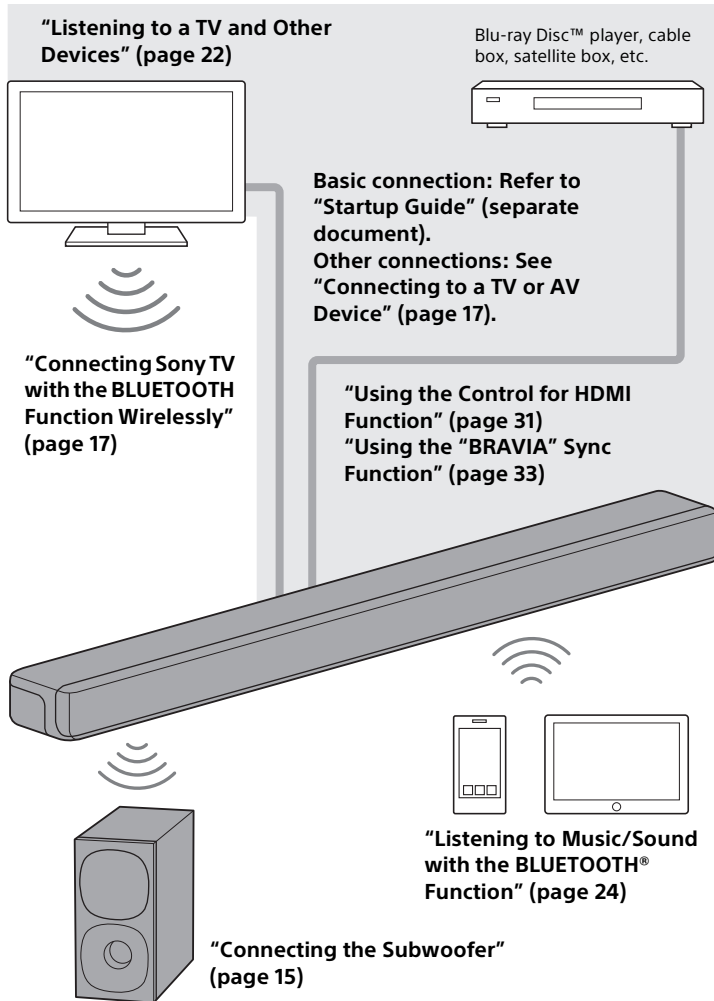

Guide to Parts and Controls

Details are omitted from the illustrations.

Bar Speaker (Main Unit)

Front

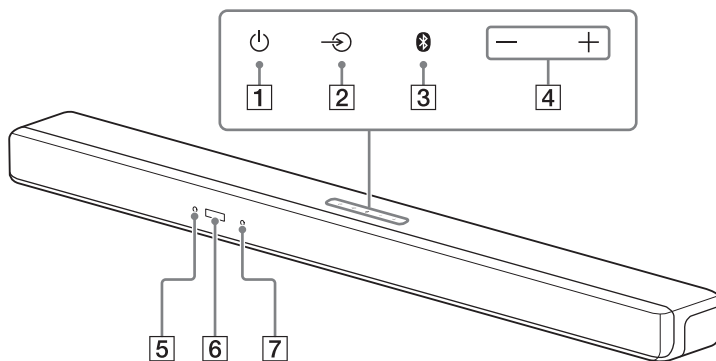

- 1** **(power) button**
Turns on the system or sets it to standby mode.
- 2** **(input select) button**
Selects the input for playback on the system.
- 3** **BLUETOOTH button (page 24)**
- 4** **+/- (volume) buttons**
- 5** **BLUETOOTH indicator**
 - Lights in blue: BLUETOOTH connection has been established.
 - Flashes slowly in blue repeatedly: BLUETOOTH connection is being attempted.
 - Flashes twice in blue repeatedly: During pairing standby status.
- 6** **Front panel display**
- 7** **Remote control sensor**
Point the remote control at the remote control sensor to operate the system.

Rear

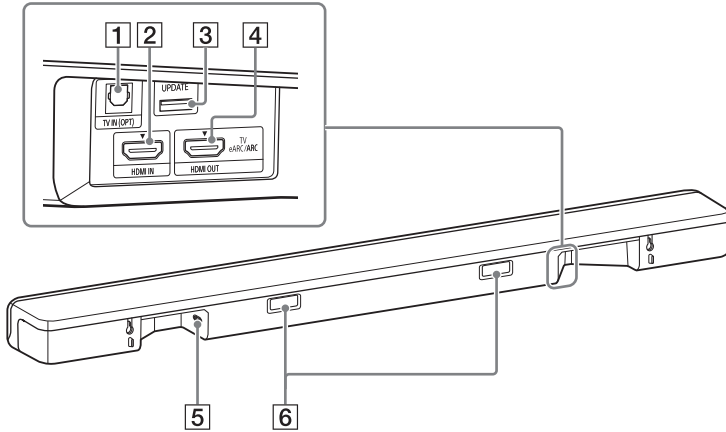

1 TV IN (OPT) jack

2 HDMI IN jack

For specifications and notes on connections, see “Supported HDMI Video Formats” (page 49).

3 UPDATE port (page 37)

Connect the USB memory when updating the system.

4 HDMI OUT (TV eARC/ARC) jack

Connect a TV that has an HDMI input jack with an HDMI cable. The system is compatible with eARC and ARC. ARC is the function that sends TV sound to an AV device such as the system from the TV’s HDMI jack. eARC is an extension of ARC and enables transmission of the object audio and multi-channel LPCM content that cannot be transmitted with ARC. For details of eARC, see “[eARC]” (page 36). For supported audio formats, see “Supported

Input Audio Formats” (page 48). For specifications and notes on connections, see “Supported HDMI Video Formats” (page 49).

5 AC inlet

6 IR repeater (page 16)

Transmits the remote signal of the TV remote control to the TV.

Subwoofer

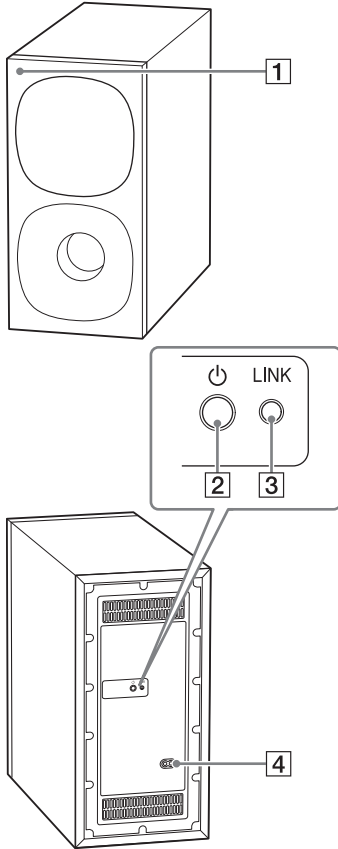

1 Power indicator

- Lights in green: The subwoofer is connected to the system.
- Lights in red: The subwoofer is in standby mode.
- Lights in amber: The subwoofer is connected to the system with the manual connection.
- Flashes slowly in green: The subwoofer is attempting to connect to the system.
- Flashes slowly in amber: The subwoofer is attempting to connect to the system with the manual connection./The software is updating.
- Flashes quickly in amber: The subwoofer is in pairing standby status with the manual connection.
- Turns off: The subwoofer is turned off.

2 (power) button

Turns on or off the subwoofer.

3 LINK button (page 15)

4 AC inlet

Remote Control

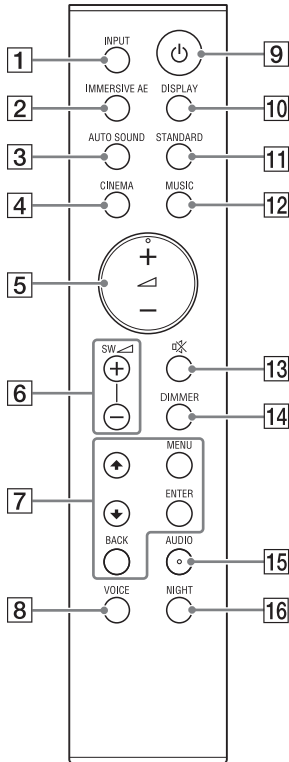

1 INPUT (page 22)

Selects the playback source. Each time you press INPUT, the selected input appears in the front panel display cyclically as follows. [TV] → [HDMI] → [BT]

2 IMMERSIVE AE (page 27)

Turns on/off the vertical surround function.

3 AUTO SOUND (page 28)

4 CINEMA (page 28)

5 ▲ (volume) +/- (page 23)

Adjusts the volume.

6 SW ▲ (subwoofer volume) +/- (page 23)

Adjusts the volume of the subwoofer.

7 MENU (page 34)

Enters/exits the setting menu mode.

▲/▼ (page 34)

Selects the setting menu items.

ENTER (page 34)

Enters the selection.

BACK (page 34)

Returns to the previous display.

8 VOICE (page 29)

9 ⏻ (power)

Turns on the system or sets it to standby mode.

10 DISPLAY (page 30)

Displays the settings of the sound mode, IMMERSIVE AE, voice mode, night mode, and current stream information.

11 STANDARD (page 28)

12 MUSIC (page 28)

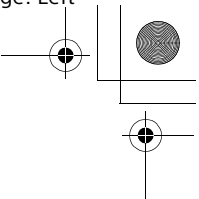
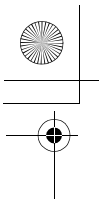

13  (muting)

Turns off the sound temporarily.

14 DIMMER (page 38)

15 AUDIO* (page 23)

16 NIGHT (page 29)

* The AUDIO and  + buttons have a tactile dot. Use it as a guide during operation.

About the replacement of batteries for the remote control

When the system does not respond by operating with the remote control, replace two batteries with new batteries.

Use R03 (size AAA) manganese batteries for replacement.



12^{US}

Installing the System

Installing the Bar Speaker and Subwoofer

Refer to Startup Guide (separate document).

Mounting the Bar Speaker on a Wall

You can mount the bar speaker on a wall.

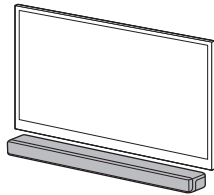

Notes

- Prepare screws (not supplied) that are suitable for the wall material and strength. As a plasterboard wall is especially fragile, attach the screws securely in the wall beam. Install the speakers horizontally, hung by screws in studs in a continuous flat section of the wall.
- Have the installation done by a Sony dealer or licensed contractor and pay special attention to safety during the installation.
- Sony shall not be held responsible for accidents or damage caused by improper installation, insufficient wall strength, improper screw installation or natural disaster, etc.

- 1 Prepare two screws (not supplied) that are suitable for the wall mount holes on the rear of the bar speaker.**

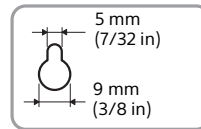
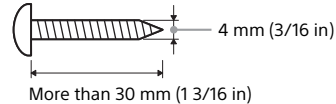

Hole on the rear of the bar speaker

- 2 Stick WALL MOUNT TEMPLATE (supplied) on a wall.**

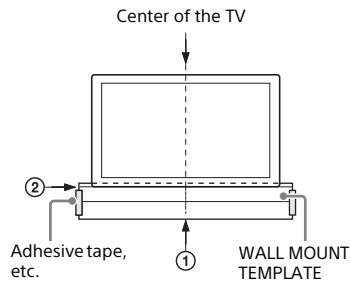

- 1 Align TV CENTER LINE (①) of WALL MOUNT TEMPLATE with the center line of your TV.**
- 2 Align TV BOTTOM LINE (②) of WALL MOUNT TEMPLATE with the bottom of your TV, then stick WALL MOUNT TEMPLATE on a wall by using a commercially available adhesive tape, etc.**

- 3** Fasten the screws into the marks (Ⓢ) on SCREW LINE (③) of WALL MOUNT TEMPLATE as in the illustration below.

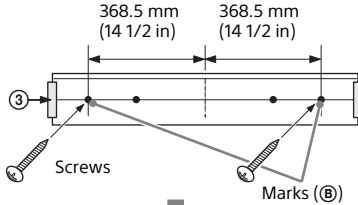

Notes

- When sticking WALL MOUNT TEMPLATE, smooth it out fully.
- Install the bar speaker apart from the TV by 70 mm (2 7/8 in) or more.

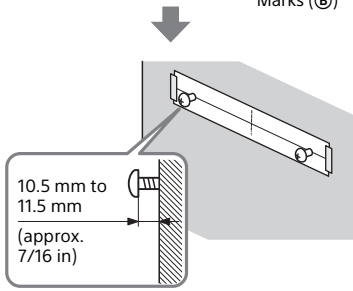

- 4** Remove WALL MOUNT TEMPLATE.

- 5** Hang the bar speaker on the screws.

Align the holes of the rear of the bar speaker with the screws, then hang the bar speaker on the two screws.

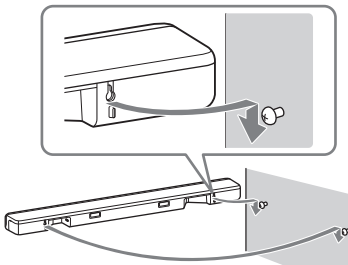

Connecting the Subwoofer

Connecting the Subwoofer Automatically

The subwoofer is connected to the system automatically when they are turned on.
For details, refer to Startup Guide (separate document) for the subwoofer connection.

Connecting the Subwoofer Manually

If you cannot connect the subwoofer to the system, or you use multiple wireless products and want to specify the wireless connection to link the system to the subwoofer, perform the manual connection.

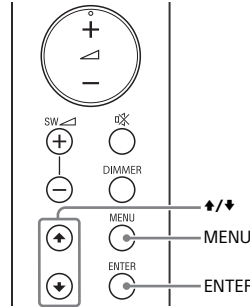
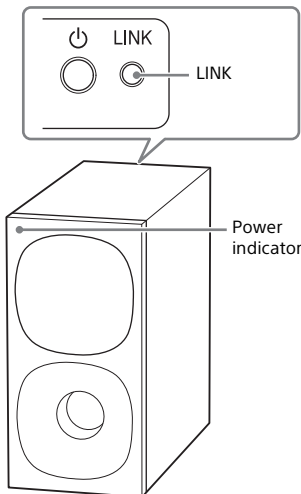

- 1 Press MENU.**
[SPEAKER] appears in the front panel display.
- 2 Press \uparrow/\downarrow to select [SPEAKER], then press ENTER.**
- 3 Press \uparrow/\downarrow to select [LINK], then press ENTER.**
- 4 Press \uparrow/\downarrow to select [START], then press ENTER.**
[LINK] flashes in the front panel display.
To cancel the manual connection, press BACK.
- 5 Press LINK on the subwoofer.**
The manual link starts.
The power indicator of the subwoofer flashes in amber.
- 6 When [DONE] appears in the front panel display, press MENU.**
The link is established and the power indicator of the subwoofer lights in amber.

Note

If [ERROR] appears in the front panel display, the connection of the subwoofer has not been established. Perform the manual connection again.

When the TV Remote Control does not Work

When the bar speaker obstructs the remote control sensor of the TV, the TV remote control may not work. In that case, enable the IR repeater function of the system.

You can control the TV with the TV remote control by sending the remote signal from the rear of the bar speaker.

- Even if [IR REPEATER] is set to [ON], this function may not work depending on your TV. Also, the remote controls of other devices such as an air conditioner may not work correctly. In this case, change the installation position of the system or TV.

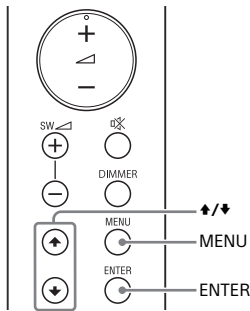

- 1 Press MENU.**
[SPEAKER] appears in the front panel display.
- 2 Press $\blacktriangle/\blacktriangledown$ to select [SYSTEM], then press ENTER.**
- 3 Press $\blacktriangle/\blacktriangledown$ to select [IR REPEATER], then press ENTER.**
- 4 Select [ON].**

Notes

- Be sure to check that the TV remote control cannot control the TV, and then set [IR REPEATER] to [ON]. If it is set to [ON] when the remote control can control the TV, appropriate operation may not be obtained because of the interference between the direct command from the remote control and command via the bar speaker.

Connecting to a TV or AV Device

Connecting to a TV or AV Device with the HDMI Cable

To connect a 4K TV or 4K devices

See "Connecting a 4K TV and 4K Devices" (page 20).

To connect a TV compatible with eARC

For the connection, refer to Startup Guide (separate document). For the settings, see "[eARC]" (page 36).

To connect to a TV other than the above, refer to Startup Guide (separate document).

Connecting Sony TV with the BLUETOOTH Function Wirelessly

When using Sony TV* with the BLUETOOTH function, you can listen to sound of the TV or device that is connected to the TV by connecting the system and TV wirelessly.

* The TV needs to be compatible with A2DP (Advanced Audio Distribution Profile) of the BLUETOOTH profile.

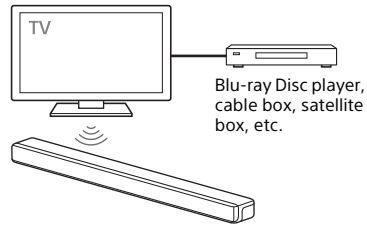

Listening to TV Sound by Connecting the System and TV Wirelessly

To connect the system and TV wirelessly, you need to perform pairing of the system and TV by using the BLUETOOTH function.

Pairing is the process required to mutually register the information on BLUETOOTH devices to be connected wirelessly in advance.

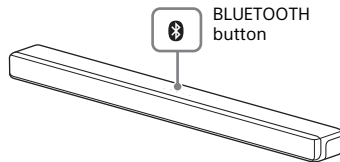
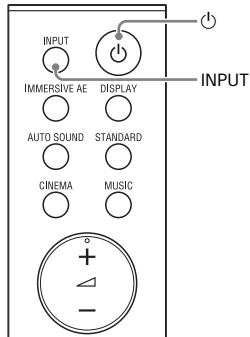

- 1 Turn on the TV.**
- 2 Turn on the system.**
- 3 Press and hold the BLUETOOTH button on the bar speaker and INPUT on the remote control simultaneously for 5 seconds.**

The system enters the pairing mode, [PAIRING] appears in the front panel display, and the BLUETOOTH indicator flashes twice repeatedly.

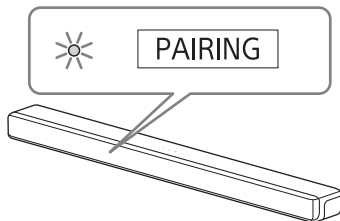

- 4 On the TV, search the system by performing the pairing operation.**

The list of the BLUETOOTH devices that are searched appears on the TV screen.

For the operation method to pair the BLUETOOTH device to the TV, refer to the operating instructions of the TV.

- 5 Pair the system and TV by selecting "HT-G700" from the list on the TV screen.**

- 6 Make sure that the BLUETOOTH indicator on the bar speaker lights in blue and [TV-BT] appears in the front panel display.**

A connection between the system and TV has been established.

- 7 Select the program or input of the device by using the TV remote control.**

The sound of the displayed image on the TV screen is output from the system.

- 8 Adjust the volume of the system by using the TV remote control.**

When pressing the muting button on the TV remote control, the sound is muted temporarily.

Notes

- If the TV sound is not output from the system, select the TV input by pressing INPUT and check the status of the front panel display and indicators on the bar speaker.
 - [TV-BT] appears in the front panel display: The system and TV are connected and TV sound is output from the system.
 - The BLUETOOTH indicator flashes twice repeatedly and [PAIRING] appears in the front panel display: Perform pairing on the TV.
 - [TV] appears in the front panel display: Perform steps from the start.

- When you connect the system and TV with the HDMI cable (supplied), the BLUETOOTH connection is canceled. To connect the system and TV with the BLUETOOTH function again, disconnect the HDMI cable, then perform the connecting operation from the start.
- While the system is connecting the TV with the BLUETOOTH function and [AUTO SOUND] is selected for the sound mode, [STANDARD] is selected for the sound mode.

Listening to Sound of the Paired TV

You can turn the system on/off, adjust the volume, and mute the sound by using the TV remote control when connecting the TV to the system wirelessly.

1 Turn on the TV with the TV remote control.

The system is turned on by interlocking with the TV power, and TV sound is output from the system.

2 Select the program or input of the device by using the TV remote control.

The sound of the displayed image on the TV screen is output from the system.

3 Adjust the volume of the system by using the TV remote control.

When pressing the muting button on the TV remote control, the sound is muted temporarily.

Note

If you select the input other than TV on the remote control supplied with the system, the TV sound is not output from the system. To output the TV sound, select the TV input by pressing INPUT.

Tip

When the TV is turned off, the system is also turned off by interlocking with the TV power.

Connecting a 4K TV and 4K Devices

All HDMI jacks on the system support 4K video format, HDCP2.2, and HDCP2.3 (High-bandwidth Digital Content Protection System Revision 2.2 and 2.3). To watch 4K video content, connect the 4K TV and 4K devices to the system via an HDCP2.2 or HDCP2.3-compatible HDMI jack on each device. You can only view 4K video content through the HDCP2.2 or HDCP2.3-compatible HDMI jack connection.

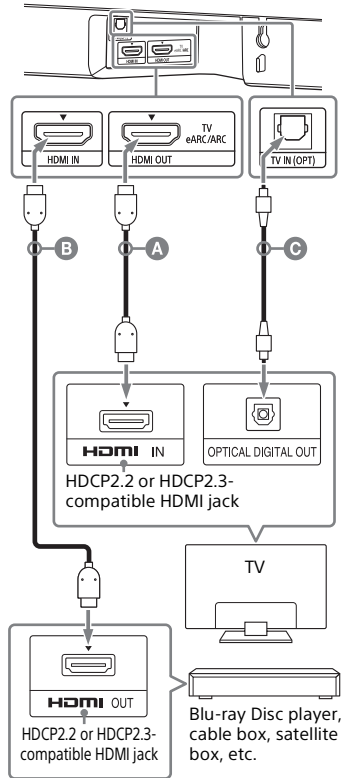

- A** HDMI cable (supplied)
- B** HDMI cable (not supplied)
Use an HDMI cable which supports the 4K video format that you want to watch. For details, see "Supported HDMI Video Formats" (page 49).
- C** Optical digital cable (not supplied)

1 Check which HDMI IN jack on your TV is compatible with HDCP2.2 or HDCP2.3.

Refer to the operating instructions of the TV.

2 Connect the HDCP2.2 or HDCP2.3-compatible HDMI IN jack on the TV and HDMI OUT (TV eARC/ARC) jack on the system with the HDMI cable (supplied).

If the HDCP2.2 or HDCP2.3-compatible HDMI IN jack on the TV supports eARC or ARC, TV connection is complete. Go to step 4.

3 If the HDCP2.2 or HDCP2.3-compatible HDMI IN jack on the TV does not support eARC or ARC, connect the optical digital output jack on the TV and the TV IN (OPT) jack on the system with an optical digital cable (not supplied).

When connecting the TV and system with the HDMI cable (supplied) only, the TV sound is not output from the system. Connect an optical digital cable (not supplied). TV connection is complete.

4 Connect the HDCP2.2 or HDCP2.3-compatible HDMI OUT jack of the 4K device and HDMI IN jack of the system with an HDMI cable (not supplied).

Refer to the operating instructions of the 4K device to check that the HDMI OUT jack of the 4K device is compatible with HDCP2.2 or HDCP2.3. 4K device connection is complete.

5 Turn on the TV.

6 Turn on the system.

Tip

4K content can be watched by a device compatible with HDCP2.2 or HDCP2.3 even though devices with different versions (ex. TV compatible with HDCP2.2 and 4K device compatible with HDCP2.3) are connected.

- If the picture is not displayed while [FORMAT] is set to [ENHANCED], set it to [STANDARD].

Setting the HDMI Signal Format to Watch 4K Video Content

To watch 4K video content, select the appropriate setting for the connected 4K TV and 4K device.

1 Press MENU.

[SPEAKER] appears in the front panel display.

2 Press $\blacktriangle/\blacktriangledown$ to select [HDMI], then press ENTER.

3 Press $\blacktriangle/\blacktriangledown$ to select [FORMAT], then press ENTER.

4 Press $\blacktriangle/\blacktriangledown$ repeatedly to select the setting you want.

- **[ENHANCED]**: Select when both the connected TV and devices support high bandwidth video formats such as 4K 60p 4:4:4, etc.
- **[STANDARD]**: Select when the connected TV and devices support standard bandwidth video formats.

For the relation of this setting, supported video format signals, and HDMI cables to be used, see "Supported HDMI Video Formats" (page 49).

Notes

- Depending on the TV, the TV setting for HDMI output may be required. Refer to the operating instructions of the TV.

Listening to Music/Sound

Listening to a TV and Other Devices

You can select the connected device and play the sound of that device.

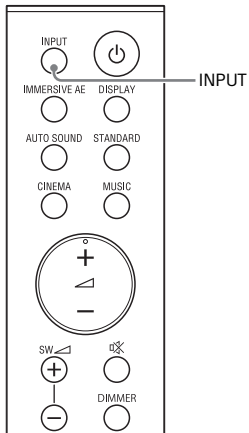

1 Press INPUT to select the input you want to play.

Each time you press INPUT, the selected input appears in the front panel display cyclically as follows.
[TV] → [HDMI] → [BT]

Front panel display

[TV]

Selects the sound of the TV that is connected to the TV IN (OPT) or HDMI OUT (TV eARC/ARC) jack on the system. You can set the playback input jack with [HDMI] - [TV AUDIO] in the setup menu (page 36).

Front panel display

[HDMI]

Selects the sound of the device that is connected to the HDMI IN jack on the system.

[BT]

Selects the sound of the device that is connected to the system with the BLUETOOTH function. For details, see "Listening to Music/Sound with the BLUETOOTH® Function" (page 24).

2 Adjust the volume (page 23).

Tip

You can also select the input by pressing  on the bar speaker.

Adjusting the Volume

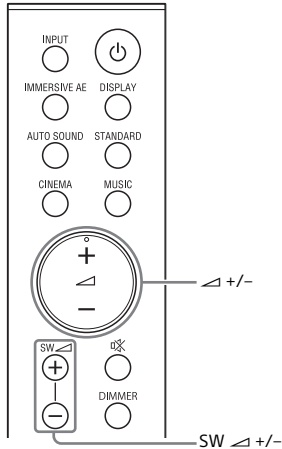

To adjust the system volume

Press \triangleleft +/-.
The volume level appears in the front panel display.

To adjust the subwoofer volume

Press SW \triangleleft (subwoofer volume) +/-.
The volume level appears in the front panel display.

The subwoofer is designed for playback of bass or low frequency sound.

Notes

- When the input source does not contain much bass sound, such as in TV programs, the bass sound from the subwoofer may be difficult to hear.
- SW \triangleleft +/- does not work when the subwoofer is not connected.

Enjoying Multiplex Broadcast Sound (AUDIO)

You can enjoy multiplex broadcast sound when the system receives a Dolby Digital multiplex broadcast signal.

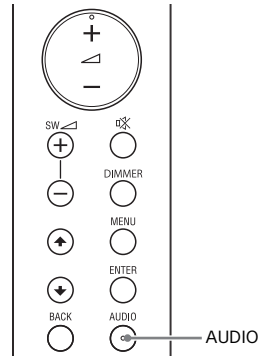

1 Press AUDIO repeatedly to select the desired audio signal.

Front panel display	Function
[MAIN]	Sound of the main language will be output.
[SUB]	Sound of the sub language will be output.
[M/S]	Mixed sound of both the main and sub languages will be output.

Notes

- To receive a Dolby Digital signal, you need to connect the TV that is compatible with eARC or ARC (page 32) to the HDMI OUT (TV eARC/ARC) jack with the HDMI cable (supplied), or other devices to the HDMI IN jack with an HDMI cable (not supplied).
- If your TV's HDMI IN jack is not compatible with eARC or ARC (page 32), connect the

TV to the TV IN (OPT) jack with an optical digital cable (not supplied) to receive a Dolby Digital signal.

- AUDIO does not work while connecting a TV or other device to the system with the BLUETOOTH function.

Listening to Music/ Sound with the BLUETOOTH® Function

You can listen to music by connecting the system and mobile device with the BLUETOOTH function.

Listening to Music by Pairing the Mobile Device that is Connected for the First Time

To use the BLUETOOTH function, you need to perform pairing of the system and mobile device in advance.

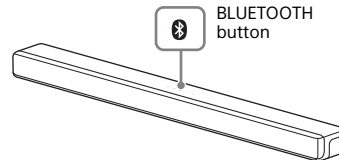

- 1 Press and hold the BLUETOOTH button on the bar speaker for 2 seconds.**

The system enters the pairing mode, [PAIRING] appears in the front panel display, and the BLUETOOTH indicator flashes twice repeatedly.

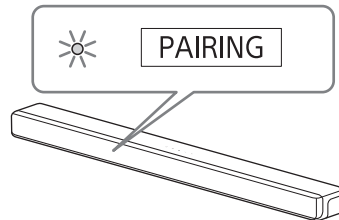

2 On the mobile device, search the system by performing the pairing operation.

The list of the BLUETOOTH devices that are searched appears on the screen of the mobile device. For the operation method to pair the BLUETOOTH device to the mobile device, refer to the operating instructions of the mobile device.

3 Pair the system and mobile device by selecting "HT-G700" from the list on the screen of the mobile device.

If a Passkey is requested, enter "0000."

4 Make sure that the BLUETOOTH indicator on the bar speaker lights in blue.

A connection between the system and mobile device has been established.

5 Start audio playback with the music app on the connected mobile device.

Sound is output from the system.

6 Adjust the volume (page 23).

To check the connection status of the BLUETOOTH function

Status	BLUETOOTH indicator
During pairing standby status	Flashes twice in blue repeatedly
Connection is being attempted	Flashes slowly in blue repeatedly
Connection has been established	Lights in blue

Note

You can pair the BLUETOOTH devices up to the following number.

- Mobile devices: 9
- Sony TV with the BLUETOOTH function: 1

If a new device is paired after pairing the above number of devices, the oldest connected device will be replaced by the new one.

Tips

- If there is no mobile device that has been paired (ex. immediately after the purchase of the system), the system goes into pairing mode simply by changing the input to the BT input.
- Perform pairing for the second and subsequent mobile devices.

Listening to Music from the Paired Device

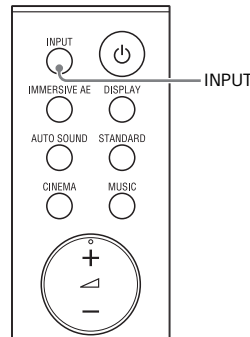

1 Turn the BLUETOOTH function of the mobile device to on.

2 Press INPUT repeatedly to select [BT].

The system automatically reconnects to the mobile device it was most recently connected to.

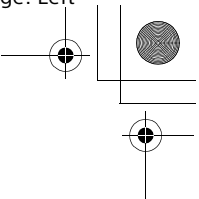
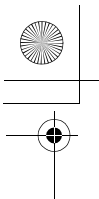

3 Make sure that the BLUETOOTH indicator on the bar speaker lights in blue.

A connection between the system and mobile device has been established.

4 Start audio playback with the music app on the connected mobile device.

Sound is output from the system.

5 Adjust the volume (page 23).

To disconnect the mobile device

Perform any of the following items.

- Disable the BLUETOOTH function on the mobile device.
- Set [BT] - [POWER] to [OFF] (page 37).
- Turn off the system or mobile device.

Tip

When the connection is not established, select "HT-G700" on the mobile device.

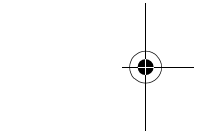
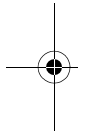

Adjusting the Sound Quality

Enjoying Immersive Surround Experience (IMMERSIVE AE)

You can feel immersed by the sound from not only the horizontal direction, but also from the upward direction by using Vertical Surround Engine* effectively for sound modes (page 28). This function also works for the 2.0 channel signal such as a TV program.

* Vertical Surround Engine is a highly precise digital sound field processing technology developed by Sony that produces the sound field in the height direction virtually in addition to a sound field in the horizontal direction by only using front speakers and without using top speakers.

You do not need to install speakers on a ceiling and you can enjoy the sound with rich presence regardless of the ceiling height. Also, this function is hardly affected by the shape of a room because it does not use the sound reflected from a wall and enables improved surround playback.

1 Press IMMERSIVE AE to set the function on or off.

Front panel display	Function
[IAE.ON]	Activates the vertical surround function.
[IAE.OFF]	Deactivates the vertical surround function.

Notes

- The surround effect from all directions differs depending on the sound source.
- A time gap between the sound and picture may occur depending on the sound source. If your TV has a function that delays the image, use it for adjustment.
- The IMMERSIVE AE function is available only when the [AUDIO] - [EFFECT] setting is set to [SOUND MODE ON] (page 35).

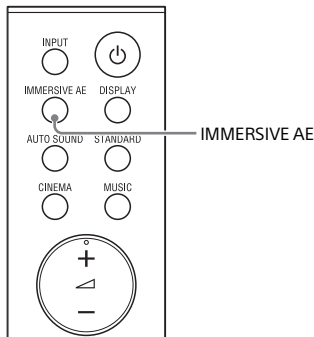

Setting the Sound Effect that is Tailored to Sound Sources (Sound Mode)

You can easily enjoy pre-programmed sound effects that are tailored to different kinds of sound sources.

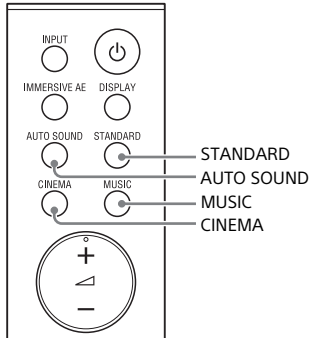

- 1 Press one of the sound mode selecting buttons (AUTO SOUND, STANDARD, CINEMA, MUSIC) to select the sound mode.

Button	Function
AUTO SOUND	[AUTO SOUND] appears in the front panel display. The appropriate sound mode setting is automatically selected from STANDARD, CINEMA, or MUSIC.
STANDARD	[STANDARD] appears in the front panel display. The sound of a TV program can be heard clearly.

Button	Function
CINEMA	[CINEMA] appears in the front panel display. You feel immersed by the sound that travels behind you and surrounds your entire body. This mode is suitable for watching movies.
MUSIC	[MUSIC] appears in the front panel display. Vividness and glossiness of the sound are expressed in detail. This mode is suitable for enjoying music in a way that moves you.

Notes

- The sound mode function is disabled when the [AUDIO] - [EFFECT] setting is set to a setting other than [SOUND MODE ON] (page 35).
- A time gap between the sound and picture may occur depending on the sound source. If your TV has a function that delays the image, use it for adjustment.

Making Dialogs Clearer (VOICE)

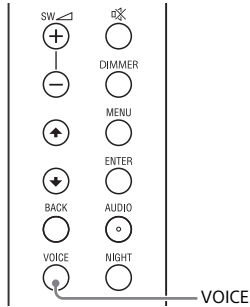

- 1 Press **VOICE** to set the function on or off.

Front panel display	Function
[Vo.ON]	Dialog is easily heard by enhancing dialog range.
[Vo.OFF]	Deactivates the voice mode function.

Enjoying Clear Sound with Low Volume at Midnight (NIGHT)

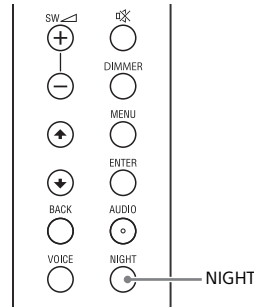

- 1 Press **NIGHT** to set the function on or off.

Front panel display	Function
[N.ON]	Outputs the sound at low volume with minimum loss of fidelity and clarity of dialog.
[N.OFF]	Deactivates the night mode function.

Note

When you turn the system off, this setting is set to [N.OFF] automatically.

Checking the Current Sound Settings (DISPLAY)

You can check the current settings of the sound mode, IMMERSIVE AE, voice mode, night mode, and current stream information.

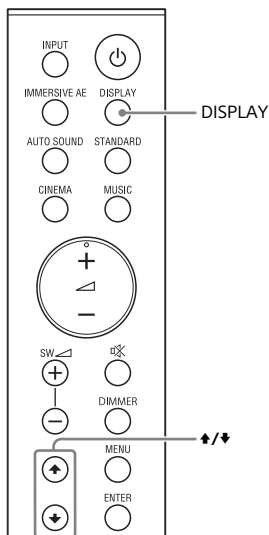

- 1 Press DISPLAY.**
The current sound mode appears in the front panel display.
- 2 Press \updownarrow repeatedly to select the sound setting you want to check.**
The current status of each sound setting appears in the following order.
Sound mode (page 28) → IMMERSIVE AE (page 27) → Voice mode (page 29) → Night mode (page 29) → Stream information
The current status of each sound setting appears in the reverse order by pressing \updownarrow .

Using the Control for HDMI Function

Using the Control for HDMI Function

Connecting a device such as a TV or Blu-ray Disc player compatible with the Control for HDMI function* using an HDMI cable enables you to easily operate the device by a TV remote control.

The following functions can be used with the Control for HDMI function.

- System Power Off function
- System Audio Control function
- eARC/ARC (Enhanced Audio Return Channel/Audio Return Channel)
- One-Touch Play function
- HDMI Standby Through power saving setting

Note

These functions may work with devices other than those manufactured by Sony, but operation is not guaranteed.

* Control for HDMI is a standard used by CEC (Consumer Electronics Control) for allowing HDMI (High-Definition Multimedia Interface) devices to control each other.

Preparing to Use the Control for HDMI Function

Set [HDMI] - [CONTROL FOR HDMI] to [ON] (page 36). The default setting is [ON].

Enable the Control for HDMI function settings for the TV and other device connected to the system.

Tip

If you enable the Control for HDMI ("BRAVIA" sync) function when using a TV manufactured by Sony, the Control for HDMI function of the system is also enabled automatically.

System Power Off Function

When you turn off the TV, the system will turn off automatically.

Note

The connected device may not turn off depending on the status of the device.

System Audio Control Function

If you turn on the system while you are watching the TV, the TV sound will be output from the speakers of the system. The volume of the system can be adjusted using the TV remote control. When you turn on the TV, the system is turned on automatically and the TV sound is output from the speakers of the system.

Operations can also be made by the TV's menu. For details, refer to the operating instructions of your TV.

Notes

- The number for the system's volume level is displayed on the TV screen depending on the TV. The volume number displayed on the TV may differ from the number on the front panel display of the system.
- Depending on the settings of the TV, the System Audio Control function may not be available. For details, refer to the operating instructions of your TV.
- Depending on the TV, if the TV sound was output from the speakers of the TV the previous time you watched the TV, the system may not turn on by interlocking with the TV power even if the TV is turned on.

eARC/ARC (Enhanced Audio Return Channel/Audio Return Channel)

If the system is connected to a TV's HDMI IN jack compatible with eARC or ARC, you can listen to TV sound from the speakers of the system without connecting an optical digital cable. On the system, set [HDMI] - [EARC] to [ON] (page 36). The default setting is [ON].

Notes

- Enable the eARC or ARC function of the TV. For details, refer to the operating instructions of the TV.
- If the TV is not compatible with eARC or ARC, an optical digital cable (not supplied) needs to be connected (refer to the supplied Startup Guide).

One-Touch Play Function

When you play content on a device (Blu-ray Disc player, "PlayStation®4," etc.) connected to the system, the system and TV are turned on automatically, the input of the system is switched to the HDMI input, and sound is output from the speakers of the system.

Notes

- If [HDMI] - [STANDBY THROUGH] is set to [ON] or [AUTO] and the TV sound was output from the speakers of the TV the previous time you watched the TV, the system may not turn on and the sound and picture may be output from the TV even if device content is played (page 36).
- Depending on the TV, the beginning part of content being played may not play correctly.

HDMI Standby Through Power Saving Setting

HDMI Standby Through is a function that allows you to enjoy the sound and picture of a connected device without turning on the system.

You can reduce system standby power consumption by setting [HDMI] - [STANDBY THROUGH] to [AUTO] (page 36). The default setting is [AUTO].

Note

If the picture of a device connected to the system is not displayed on the TV, set [HDMI] - [STANDBY THROUGH] to [ON]. If you connect a TV other than those manufactured by Sony, we recommend you to select this setting.

Using the “BRAVIA” Sync Function

In addition to the Control for HDMI function, you can also use the “BRAVIA” sync function such as the Sound mode/Scene Select function.

Note

This function is proprietary function of Sony. This function cannot operate with products other than those manufactured by Sony.

Sound mode/Scene Select Function

The sound mode of the system is automatically switched according to the setting of the TV’s Scene Select function or sound mode. For details, refer to the operating instructions of your TV. Set the sound mode to [AUTO SOUND] (page 28).

Changing the Settings

Using the Setting Menu

You can set the following items with the setting menu. Your settings are retained even if you disconnect the AC power cord (mains lead).

- 1 Press MENU to enter the setting menu mode.**
 The setting menu item appears in the front panel display.
- 2 Press \blacktriangle / \blacktriangledown repeatedly to select the item, then press ENTER.**
 You can select the following items.
 - [SPEAKER] (Speaker settings) (page 34)
 - [AUDIO] (Audio settings) (page 35)
 - [HDMI] (HDMI settings) (page 36)
 - [BT] (BLUETOOTH settings) (page 37)
 - [SYSTEM] (System settings) (page 37)
 - [RESET] (Resetting the system) (page 37)
 - [UPDATE] (Updating the system) (page 37)
- 3 Press \blacktriangle / \blacktriangledown repeatedly to select the setting, then press ENTER.**
 To return to the upper layer, press BACK.
- 4 Press MENU to exit the setting menu mode.**

Setting menu items

Items	Function
[SPEAKER] (Speaker settings)	[LINK] (Link mode) <ul style="list-style-type: none"> • [START]: Performs the manual connection of the subwoofer to the system. For details, see "Connecting the Subwoofer" (page 15). To cancel the manual connection, press BACK. • [CANCEL]: Returns to the upper layer [LINK].
[SUBWOOFER INFO] (Subwoofer version information)	Shows the version information of the subwoofer. <ul style="list-style-type: none"> • [LATEST]: The subwoofer is the latest version. • [PLEASE UPDATE]: The subwoofer is not the latest version. • [NOT CONNECTED]: The subwoofer is not connected to the system.

Items	Function
[AUDIO] (Audio settings)	[DRC] (Audio DRC) You can compress the dynamic range of the sound track. [AUTO]: Automatically compresses sound encoded in Dolby TrueHD. [ON]: Reproduces the dolby and DTS sound track with the kind of dynamic range that the recording engineer intended. [OFF]: No compression of dynamic range.
[SYNC] (A/V Sync)	When the sound does not match the pictures on the TV screen, you can adjust the delay between the picture and sound. You can adjust from 0 msec to 120 msec in 40 msec increments. The default setting is [0ms]. Note This function is available only when the HDMI input is selected.
[DIALOG] (DTS Dialog Control)	By adjusting the dialog volume, you can easily listen to dialog since it stands out from the ambient noise. This function works while playing content that is compatible with the DTS:X dialog control function. You can adjust from 0 dB to 6 dB in 1 dB increments. The default setting is [0dB].
[EFFECT] (Sound Effect)	You can select sound effects, including the sound mode. <ul style="list-style-type: none">• [SOUND MODE ON]: Vertical Surround Engine enhances the surround and height speaker channels to create an immersive and enveloping virtual surround effect such as sound mode (page 28) and vertical surround (page 27).• [DOLBY SPEAKER VIRTUALIZER]: Dolby Speaker Virtualizer enhances the surround and height speaker channels to create an immersive and enveloping virtual surround effect. Disables sound effects for the DTS format.• [DTS VITRUAL:X]: DTS Virtual:X is enabled. DTS Virtual:X Technology in the system puts you in the middle of multi speaker. Disables sound effects for the Dolby format.• [NO EFFECT]: Disables the sound effects.

Items	Function	
[HDMI] (HDMI settings)	[CONTROL FOR HDMI]	<ul style="list-style-type: none"> • [ON]: The Control for HDMI function is enabled. Devices connected with an HDMI cable can control each other. • [OFF]: Off
	[STANDBY THROUGH]	<p>This function is available when you set [CONTROL FOR HDMI] to [ON].</p> <ul style="list-style-type: none"> • [AUTO]: Signals are output from the system's HDMI OUT (TV eARC/ARC) jack when the TV is turned on while the system is not turned on. The system standby power consumption can be reduced more than when set to [ON] by turning off the connected TV. • [ON]: Signals are always output from the system's HDMI OUT (TV eARC/ARC) jack when the system is not turned on. If you connect a TV other than one manufactured by Sony, we recommend that you select this setting. • [OFF]: Signals are not output from the system's HDMI OUT (TV eARC/ARC) jack when the system is not turned on. Turn on the system to enjoy the TV content of a device connected to the system. The system standby power consumption can be reduced more than when set to [ON].
	[TV AUDIO]	<p>You can set the input jack for TV playback.</p> <ul style="list-style-type: none"> • [AUTO]: Plays the sound from the HDMI OUT (TV eARC/ARC) jack with priority when you connect the TV to both the HDMI OUT (TV eARC/ARC) and TV IN (OPT) jacks. • [OPTICAL]: Plays the sound from the TV IN (OPT) jack for the TV input.
	[EARC]	<p>You can transfer the signals of the object audio content, such as Dolby Atmos - Dolby TrueHD and DTS:X, or multi-channel LPCM content using an HDMI cable by connecting the system and a TV compatible with eARC.</p> <ul style="list-style-type: none"> • [ON]: Enables the eARC function. Use this setting when the system is connected to a TV compatible with eARC. • [OFF]: Use this setting when the system is not connected to a TV compatible with eARC. <p>Note When [EARC] is set to [ON], confirm the eARC setting of the connected TV. For details, refer to the operating instructions of the TV.</p>
	[FORMAT] (HDMI Signal Format)	<p>You can select the HDMI signal format for the input signal. For details, see "Setting the HDMI Signal Format to Watch 4K Video Content" (page 21).</p>

Items		Function
[BT] (BLUETOOTH settings)	[POWER] (BLUETOOTH Power)	<p>You can turn the BLUETOOTH function on or off.</p> <ul style="list-style-type: none"> • [ON]: Turns the BLUETOOTH function on. • [OFF]: Turns the BLUETOOTH function off. <p>Note When the BLUETOOTH function is set to off, the BLUETOOTH input is skipped while selecting input by pressing INPUT.</p>
	[STANDBY]	<p>When the system has pairing information, you can turn the system on and listen to music from a BLUETOOTH device, even when the system is in standby mode, by setting the BLUETOOTH standby mode to on.</p> <ul style="list-style-type: none"> • [ON]: BLUETOOTH standby mode is enabled. • [OFF]: BLUETOOTH standby mode is disabled. <p>Note While the BLUETOOTH standby mode is on, standby power consumption increases.</p>
	[AAC CODEC]	<p>You can enjoy high-quality sound if AAC is enabled and your device supports AAC.</p> <ul style="list-style-type: none"> • [ON]: Enables AAC codec. • [OFF]: Disables AAC codec.
[SYSTEM] (System settings)	[IR REPEATER]	<ul style="list-style-type: none"> • [ON]: Remote signals for the TV are sent from the rear of the bar speaker. • [OFF]: Turns off the function. <p>For details, see "When the TV Remote Control does not Work" (page 16).</p>
	[AUTO STANDBY]	<ul style="list-style-type: none"> • [ON]: Turns on the auto standby function. When you do not operate the system for about 20 minutes, the system enters standby mode automatically. • [OFF]: Off.
	[VERSION] (Version information)	<p>The current firmware version information of the system appears in the front panel display.</p>
[RESET] (Resetting the system)	[ALL RESET]	<p>You can reset the system settings to the factory default. For details, see "Resetting the System" (page 45).</p>
[UPDATE] (Updating the system)	[START]	<p>You can start a software update after connecting the USB memory on which the software update file is stored to the system. When there is a software update available, we will notify you on the following website: https://www.sony.com/am/support</p> <p>Notes</p> <ul style="list-style-type: none"> • Before updating, make sure that the subwoofer is turned on and connected to the system. • You can update the software of the system by pressing and holding  and the BLUETOOTH button on the bar speaker for 7 seconds.
	[CANCEL]	<p>Returns to the upper layer [UPDATE].</p>

Changing the Brightness of the Front Panel Display and Indicators (DIMMER)

You can change the brightness of the following.

- Front panel display
- BLUETOOTH indicator
- Power indicator on the subwoofer

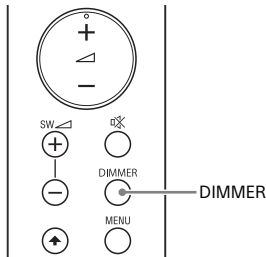

- 1 Press DIMMER repeatedly to select the desired setting.

Front panel display	Function
[BRIGHT]	The front panel display and BLUETOOTH indicator light brightly.
[DARK]	The front panel display and BLUETOOTH indicator light darkly.
[OFF]	The front panel display is turned off.

Note

The front panel display is turned off when [OFF] is selected. It turns on automatically when you press any button, then turns off again if you do not operate the system for about 10 seconds. However, in some cases, the front panel display may not turn off. In this case, the brightness of the front panel display is same as [DARK].

Saving Power in Standby Mode

Check that you have made the following settings:

- [SYSTEM] - [AUTO STANDBY] is set to [OFF] (page 37). (The default setting is [OFF].)
- [BT] - [STANDBY] is set to [OFF] (page 37). (The default setting is [ON].)

Troubleshooting

Troubleshooting

If the system does not work properly, handle it in the following order.

- 1 Search for the cause and solution of the issue using this troubleshooting.
- 2 Reset the system.
All the settings of the system return to their initial status. For details, see "Resetting the System" (page 45).

Should any problems persist, consult your nearest Sony dealer.
Be sure to bring your bar speaker and subwoofer, even if it seems as though only one has a problem, when you request to repair.

Power

The system does not power up.

- Check that the AC power cord (mains lead) is connected securely.
- Disconnect the AC power cord (mains lead) from the wall outlet (mains), and then reconnect after several minutes.

The system is turned off automatically.

- The auto standby function is working. Set [SYSTEM] - [AUTO STANDBY] to [OFF] (page 37).

The system does not turn on even when the TV is turned on.

- Set [HDMI] - [CONTROL FOR HDMI] to [ON] (page 36). The TV must support the Control for HDMI function. For details, refer to the operating instructions of your TV.
- Check the speaker settings of the TV. The system power syncs with the

speaker settings of the TV. For details, refer to the operating instructions of your TV.

- Depending on the TV, if the sound was output from the speakers of the TV the previous time, the system may not turn on by interlocking with the TV power even when the TV is turned on.

The system turns off when the TV is turned off.

- Check the setting of [HDMI] - [CONTROL FOR HDMI] (page 36). When the Control for HDMI function is set to on and the input of the system is the TV or HDMI input, the system turns off automatically when you turn off the TV.

The system does not turn off even when the TV is turned off.

- Check the setting of [HDMI] - [CONTROL FOR HDMI] (page 36). To turn the system off automatically by interlocking with the TV power, set the Control for HDMI function to on. This function works only if the input of the system is the TV or HDMI input. The system does not turn off automatically while the BLUETOOTH input is selected. The TV must support the Control for HDMI function. For details, refer to the operating instructions of your TV.

The system cannot be turned off.

- The system may be in demo mode. To cancel demo mode, reset the system. Press and hold  (power) and - (volume) on the bar speaker for more than 5 seconds (page 45).

Picture

There is no picture or the picture is not output correctly.

- Select the appropriate input (page 22).
- When there is no picture while the TV input is selected, select the TV

channel that you want using the TV remote control.

- When there is no picture while the HDMI input is selected, press the playback button of the connected device.
- Disconnect the HDMI cable, then connect it again. Make sure that the cable is firmly inserted.
- When there is no picture from the connected device or the picture from the connected device is not output correctly, set [HDMI] - [FORMAT] to [STANDARD] (page 36). Some pictures of an old type device may not displayed correctly while [HDMI] - [FORMAT] is set to [ENHANCED].
- If no picture appears while connecting the device with the HDMI cable, make sure that the device is connected to the HDMI IN jack and the TV is connected to the HDMI OUT (TV eARC/ARC) jack.
- The system is connected to an input device that is not HDCP (High-bandwidth Digital Content Protection) compliant. In this case, check the specifications of the connected device.

3D content from the HDMI IN jack does not appear on the TV screen.

- Depending on the TV or video device, 3D content may not appear. Check the supported HDMI video format (page 49).

4K video content from the HDMI IN jack does not appear on the TV screen.

- Depending on the TV or the video device, 4K video content may not appear. Check the video capability and settings of your TV and video device.
- The picture may not be displayed properly if [HDMI] - [FORMAT] is set to [ENHANCED]. In this case, set it to [STANDARD] (page 36).
- Use a Premium High Speed HDMI Cable with Ethernet that supports 18 Gbps or High Speed HDMI Cable with

Ethernet (page 49).

- If the system is connected to the HDMI jack that is not compatible with HDCP2.2 or HDCP2.3, [ERROR: TV DOES NOT SUPPORT HDCP2.2 OR 2.3] appears in the front panel display. Connect to the HDMI jack compatible with HDCP2.2 or HDCP2.3 of the 4K TV or 4K device.

An image is not displayed on the entire TV screen.

- The aspect ratio on the media is fixed.

Picture and sound of the device that is connected to the system are not output from the TV when the system is not turned on.

- Set [HDMI] - [STANDBY THROUGH] to [AUTO] or [ON] (page 36).
- Turn on the system, and then switch the input for the device playing.

HDR contents cannot show as high-dynamic range.

- Check the settings of the TV and connected device. For details, refer to the operating instructions of your TV and the connected device.
- Some devices may convert HDR contents to SDR if the bandwidth is not enough. In that case, be sure that [HDMI] - [FORMAT] is set to [ENHANCED] (page 36) if the TV and the connected device support a bandwidth of up to 18 Gbps. When [ENHANCED] is set, be sure to use a Premium High Speed HDMI Cable with Ethernet that supports 18 Gbps (page 49).

Sound

The system cannot connect to a TV with the BLUETOOTH function.

- When you connect the system and TV with the HDMI cable (supplied), the BLUETOOTH connection is canceled. Disconnect the HDMI cable, then perform the connecting operation from the start (page 17).

No TV sound is output from the system.

- Check the type and connection of the HDMI cable or optical digital cable that is connected to the system and the TV (refer to the supplied Startup Guide).
- Disconnect the cables that are connected between the TV and the system, then connect them firmly again. Disconnect the AC power cords (mains leads) of the TV and the system from the AC outlets (mains), then connect them again.
- When the system and TV are connected with the HDMI cable only, check the following.
 - The HDMI jack of the connected TV is labeled with "eARC" or "ARC."
 - The Control for HDMI function of the TV is set to on.
 - The eARC or ARC function of the TV is enabled.
 - [HDMI] - [EARC] is set to [ON] (page 36).
 - [HDMI] - [CONTROL FOR HDMI] is set to [ON] (page 36).
- If your TV is not compatible with eARC, set [HDMI] - [EARC] to [OFF] (page 36).
- If your TV is not compatible with eARC or ARC, connect an optical digital cable (not supplied) (refer to the supplied Startup Guide). If the TV is not compatible with eARC or ARC, TV sound will not be output from the system even if the system is connected to the TV's HDMI IN jack.
- Press INPUT repeatedly to select the TV input (page 22).
- Increase the volume on the system or cancel muting.
- If sound of a cable box/satellite box connected to the TV is not output, connect the device to a HDMI IN jack of the system and switch input of the system to HDMI (refer to the supplied Startup Guide).
- Depending on the order in which you turn on the TV and system, the

system may be muted. If this happens, turn on the TV first, then the system.

- Set the speakers setting of the TV (BRAVIA) to Audio System. Refer to the operating instructions of your TV regarding how to set the TV.

Picture and sound of the device that is connected to the system are not output from the TV when the system is not turned on.

- Set [HDMI] - [STANDBY THROUGH] to [AUTO] or [ON] (page 36).
- Turn on the system, and then switch the input for the device playing.

The sound is output from both the system and TV.

- Mute the sound of the system or TV.

The output sound of the system is not the same level as that of the TV even though the values of the volume level on the system and TV are set to the same value.

- If the Control for HDMI function is set to on, the value of the volume level on the system may appear on your TV as the TV volume. The output sound levels of the system and TV differ even though the values of the volume level on the system and TV are set to the same value. The output sound levels of the system and TV differ depending on the sound processing characteristics of each, and it is not a malfunction.

The sound is interrupted while watching a TV program or content on a Blu-ray Disc, etc.

- Check the sound mode setting (page 28). If the sound mode is set to [AUTO SOUND], the sound may be interrupted when the sound mode is changed automatically according to the information of the program that is being played. If you do not want to change the sound mode

automatically, set the sound mode to a setting other than [AUTO SOUND].

The TV sound from the system lags behind the image.

- Set [AUDIO] - [SYNC] to [0ms] if it is set to the range between 40 msec and 120 msec (page 35).
- A time gap between the sound and picture may occur depending on the sound source. If your TV has a function that delays the image, use it for adjustment.

No sound or only a very low-level sound of the device connected to the system is heard.

- Press \blacktriangleleft + on the remote control and check the volume level (page 11).
- Press Mute or \blacktriangleleft + on the remote control to cancel the muting function (page 11).
- Make sure the input source is selected correctly. You should try other input sources by pressing INPUT repeatedly (page 22).
- Check that all the cables and cords of the system and connected device are firmly inserted.
- When you play content compatible with copyright protection technology (HDCP), it may not be output from the system.
- Set [HDMI] - [FORMAT] to [STANDARD] (page 21).

The surround effect cannot be obtained.

- Depending on the input signal and the sound mode setting, surround sound processing may not work effectively. The surround effect may be subtle, depending on the program or disc.
- To play multi-channel audio, check the digital audio output setting on the device connected to the system. For details, refer to the operating instructions supplied with the connected device.

Subwoofer

No sound or only a very low-level sound is heard from the subwoofer.

- Make sure that the power indicator on the subwoofer is lit in green or amber.
- If the power indicator on the subwoofer does not light, try the following.
 - Make sure the AC power cord (mains lead) of the subwoofer is connected properly.
 - Press Power (power) of the subwoofer to turn on the power.
- If the power indicator on the subwoofer flashes slowly in green or amber, or lights in red, try the following.
 - Move the subwoofer to a location near the bar speaker so that the power indicator on the subwoofer lights in green or amber.
 - Follow the steps in "Connecting the Subwoofer" (page 15).
- If the power indicator on the subwoofer flashes in red, press Power (power) of the subwoofer to turn off the power and check whether the ventilation holes of the subwoofer is blocked or not.
- The subwoofer is designed for playback of bass or low frequency sound. If the input sources contain very little bass sound components (i.e., a TV broadcast), the sound from the subwoofer may be difficult to hear. Play the built-in demonstration music by following the steps below and check that the sound is output from the subwoofer.
 - ① Press and hold Demo on the bar speaker for 5 seconds. The built-in demonstration music is played.
 - ② Press Demo again. The built-in demonstration music

is canceled and the system returns to the previous status.

- Press SW \triangleleft + on the remote control to increase the subwoofer volume (page 11).
- Set the night mode to off (page 29).

Sound skips or has noise.

- If there is a device nearby that generates electromagnetic waves, such as a wireless LAN or a microwave oven in use, locate the system apart from it.
- If there is an obstacle between the bar speaker and the subwoofer, move or remove it.
- Do not cover the top of the bar speaker with metal objects such as TV frame, etc. Wireless functions may become unstable.
- Locate the bar speaker and the subwoofer as close as possible.
- Switch the wireless LAN frequency of any nearby wireless LAN router or PC to 5 GHz range.
- Switch the network connection of the TV or Blu-ray Disc player from wireless to wired.

USB Device Connection

The USB device is not recognized.

- Try the following:
 - ① Turn the system off.
 - ② Remove and reconnect the USB device.
 - ③ Turn the system on.
- Make sure that the USB device is securely connected to the UPDATE port.
- Check to see if the USB device or a cable is damaged.

Files stored on an USB memory are not played.

- The USB port of the system is for software updates only (page 37). The system does not support USB playback.

Mobile Device Connection

Pairing cannot be achieved.

- Bring the system and the BLUETOOTH device closer together.
- Make sure the system is not receiving interference from a wireless LAN device, other 2.4 GHz wireless devices, or a microwave oven. If a device that generates electromagnetic radiation is nearby, move the device away from the system.

BLUETOOTH connection cannot be completed.

- Make sure that the BLUETOOTH indicator on the bar speaker is lit (page 24).
- Make sure the BLUETOOTH device to be connected with is turned on and the BLUETOOTH function is enabled.
- Bring the system and the BLUETOOTH device closer together.
- Pair the system and BLUETOOTH device again. You may need to cancel the pairing with the system using your BLUETOOTH device first.
- Pairing information may be deleted. Perform pairing operation again (page 24).

Sound of the connected BLUETOOTH mobile device is not output from the system.

- Make sure that the BLUETOOTH indicator on the bar speaker is lit (page 24).
- Bring the system and the BLUETOOTH device closer together.
- If a device that generates electromagnetic radiation, such as a wireless LAN device, other BLUETOOTH devices, or a microwave oven is nearby, move the device away from the system.
- Remove any obstacle between the system and the BLUETOOTH device or move the system away from the obstacle.

- Reposition the connected BLUETOOTH device.
- Switch the wireless LAN frequency of any nearby wireless LAN router or PC to 5 GHz range.
- Increase the volume on the connected BLUETOOTH device.

Remote Control

The remote control of the system does not function.

- Point the remote control at the remote control sensor on the bar speaker (page 11).
- Remove any obstacles in the path between the remote control and the system.
- Replace both batteries in the remote control with new ones, if they are weak.
- Make sure you are pressing the correct button on the remote control.

TV remote control does not work.

- This problem might be solved by setting [SYSTEM] - [IR REPEATER] to [ON] (page 37).

Software Update

You cannot perform the software update.

- Use the USB memory on which the software update file is stored to perform the software update (page 37).

Others

The Control for HDMI function does not work properly.

- Check the connection with the system (refer to the supplied Startup Guide).
- Enable the Control for HDMI function on the TV. For details, refer to the operating instructions of your TV.

- Wait a while, and then try again. If you unplug the system, it will take a while before operations can be made. Wait for 15 seconds or longer, and then try again.
- Make sure the devices connected to the system support the Control for HDMI function.
- Enable the Control for HDMI function on the devices connected to the system. For details, refer to the operating instructions of your device.
- The type and number of devices that can be controlled by the Control for HDMI function is restricted by the HDMI CEC standard as follows:
 - Recording devices (Blu-ray Disc recorder, DVD recorder, etc.): up to 3 devices
 - Playback devices (Blu-ray Disc player, DVD player, etc.): up to 3 devices
 - Tuner-related devices: up to 4 devices
 - Audio system (receiver/headphones): up to 1 device (used by the system)

[PROTECT] flashes in the front panel display and the system is turned off.

- Disconnect the AC power cord (mains lead) and make sure nothing is obstructing the ventilation holes of the system.

Sensors of the TV do not work properly.

- The system may block some sensors (such as the brightness sensor), the remote control receiver of your TV or the emitter for 3D glasses (infrared transmission) of a 3D TV that supports the infrared 3D glass system, or wireless communication. Move the system away from the TV within a range that allows those parts to operate properly. For the locations of the sensors and remote control receiver, refer to the operating instructions supplied with the TV.



Wireless function (the BLUETOOTH function or subwoofer) is unstable.

→ Do not place metal objects other than a TV around the system.

Music that you are not familiar with suddenly plays.







→ The pre-installed sample music may have been played. Press  on the bar speaker to stop playback.

The system does not work properly.

→ The system may be in demo mode. To cancel demo mode, reset the system. Press and hold  (power) and  (volume) on the bar speaker for more than 5 seconds (page 45).

Resetting the System



If the system still does not operate properly, reset the system as follows.

- 1 Press MENU.**
[SPEAKER] appears in the front panel display.
- 2 Press / to select [RESET], then press ENTER.**
- 3 Press / to select [ALL RESET], then press ENTER.**
- 4 Press / to select [START], then press ENTER.**
All the settings return to their initial status.

To cancel resetting

Select [CANCEL] in step 4.

If You Cannot Perform Resetting Using the Setting Menu

Press and hold  (power) and  (volume) on the bar speaker for more than 5 seconds.

The settings return to their initial status.

Note

By resetting, the link with the subwoofer may be lost. In this case, perform "Connecting the Subwoofer" (page 15).

Additional Information

Specifications

Bar Speaker (SA-G700)

Amplifier section

U.S. models:

POWER OUTPUT AND TOTAL HARMONIC DISTORTION:
(FTC)

Front L + Front R:

With 4 ohms loads, both channels driven, from 200 - 20,000 Hz; rated 35 W per channel minimum RMS power, with no more than 1% total harmonic distortion from 250 mW to rated output.

POWER OUTPUT (reference)

Front L/Front R/Center speaker: 100 W (per channel at 4 ohms, 1 kHz)

Canadian models:

POWER OUTPUT (rated)

Front L + Front R: 60 W + 60 W (at 4 ohms, 1 kHz, 1% THD)

POWER OUTPUT (reference)

Front L/Front R/Center speaker: 100 W (per channel at 4 ohms, 1 kHz)

Inputs

HDMI IN*

TV IN (OPT)

Outputs

HDMI OUT (TV eARC/ARC)*

* HDMI IN and HDMI OUT (TV eARC/ARC) jacks support HDCP2.2 and HDCP2.3 protocol. HDCP2.2 and HDCP2.3 are newly enhanced copyright protection technology that is used to protect content such as 4K movies.

HDMI Section

Connector

Type A (19pin)

USB section

UPDATE port:

Type A (For software update only)

BLUETOOTH section

Communication system

BLUETOOTH Specification version 4.2

Output

BLUETOOTH Specification Power Class 1

Maximum communication range

Line of sight approx. 30 m¹⁾

Maximum number of devices to be registered

10 devices

Frequency band

2.4 GHz band (2.4000 GHz - 2.4835 GHz)

Modulation method

FHSS (Freq Hopping Spread Spectrum)

Compatible BLUETOOTH profiles²⁾

A2DP (Advanced Audio Distribution Profile)

AVRCP (Audio Video Remote Control Profile)

Supported Codecs³⁾

SBC⁴⁾, AAC⁵⁾

Transmission range (A2DP)

20 Hz - 20,000 Hz (Sampling frequency 32 kHz, 44.1 kHz, 48 kHz)

¹⁾ The actual range will vary depending on factors such as obstacles between devices, magnetic fields around a microwave oven, static electricity, cordless phone use, reception sensitivity, the operating system, software applications, etc.

²⁾ BLUETOOTH standard profiles indicate the purpose of BLUETOOTH communication between devices.

³⁾ Codec: Audio signal compression and conversion format

⁴⁾ Abbreviation for Subband Codec

⁵⁾ Abbreviation for Advanced Audio Coding

Front L/Front R/Center speaker block section

Speaker system

3 speaker system, Acoustic suspension

Speaker

45 mm × 100 mm (1 13/16 in × 4 in)
cone type

General

Power requirements

120 V AC, 60 Hz

Power consumption

On: 45 W

Standby mode: 0.5 W or less (Power
Saving mode)

(When [HDMI] - [CONTROL FOR HDMI]
and [BT] - [STANDBY] are set to [OFF])

Standby mode: 2 W or less*

(When [HDMI] - [CONTROL FOR HDMI]
and [BT] - [STANDBY] are set to [ON])

* The system will automatically enter
Power saving mode when there is no
HDMI connection and no
BLUETOOTH pairing history.

Dimensions* (approx.) (w/h/d)

980 mm × 64 mm × 108 mm (38 5/8 in
× 2 5/8 in × 4 3/8 in)

* Not including projection portion

Mass (approx.)

3.5 kg (7 lb 12 oz)

Subwoofer (SA-WG700)

POWER OUTPUT (reference)

100 W (at 4 ohms, 100 Hz)

Speaker system

Subwoofer speaker system, Bass
reflex

Speaker

160 mm (6 3/8 in.) cone type

Power requirements

120 V AC, 60 Hz

Power consumption

On: 20 W

Standby mode: 0.5 W or less

Dimensions (approx.) (w/h/d)

192 mm × 387 mm × 406 mm (7 5/8 in
× 15 1/4 in × 16 in)

* Not including projection portion

Mass (approx.)

7.5 kg (16 lb 9 oz)

Wireless Transmitter/ Receiver Section

Frequency band

2.4 GHz (2.404 GHz - 2.476 GHz)

Modulation method

GFSK

Design and specifications are subject to
change without notice.

[YIT]
下記に修正致します。

6 1/2

Supported Input Audio Formats

Audio formats supported by this system are as follows.

Format	Function			
	[HDMI]	[TV] (eARC)	[TV] (ARC)	[TV] (OPT)
LPCM 2ch	○	○	○	○
LPCM 5.1ch	○	○	-	-
LPCM 7.1ch	○	○	-	-
Dolby Digital	○	○	○	○
Dolby TrueHD	○	○	-	-
Dolby Digital Plus	○	○	○	-
Dolby Atmos	○	○	-	-
Dolby Atmos - Dolby TrueHD	○	○	-	-
Dolby Atmos - Dolby Digital Plus	○	○	○	-
DTS	○	○	○	○
DTS-ES Discrete 6.1, DTS-ES Matrix 6.1	○	○	○	○
DTS 96/24	○	○	○	○
DTS-HD High Resolution Audio	○	○	-	-
DTS-HD Master Audio	○	○	-	-
DTS-HD LBR	○	○	-	-
DTS:X	○	○	-	-

○: Supported format.

-: Unsupported format.

Note

The HDMI IN jack do not support audio format that contains copy protections, such as Super Audio CD or DVD-Audio.

Supported HDMI Video Formats

Video formats supported by this system are as follows.

Resolution	Frame Rate	3D	Color Space	Color Depth	[HDMI] - [FORMAT] setting
4K 4096 × 2160p 3840 × 2160p	50/59.94/60 Hz	–	RGB 4:4:4 YCbCr 4:4:4	8 bit	[ENHANCED] ¹⁾
		–	YCbCr 4:2:2	8/10/12 bit	
		–	YCbCr 4:2:0	10/12 bit	
	23.98/24/25/29.97/30 Hz	–	RGB 4:4:4 YCbCr 4:4:4	10/12 bit	
4K 4096 × 2160p 3840 × 2160p	50/59.94/60 Hz	–	YCbCr 4:2:0	8 bit	[STANDARD] ²⁾
	23.98/24/25/29.97/30 Hz	–	RGB 4:4:4 YCbCr 4:4:4	8 bit	
			–	YCbCr 4:2:2	
1920 × 1080p	25/29.97/30/50/ 59.94/60 Hz	–	RGB 4:4:4 YCbCr 4:4:4 YCbCr 4:2:2	8/10/12 bit	
	23.98/24 Hz	⊙			
1920 × 1080i	50/59.94/60 Hz	○			
1280 × 720p	50/59.94/60 Hz	⊙			
	23.98/24/29.97/30 Hz	–			
720 × 480p	59.94/60 Hz	–			
720 × 576p	50 Hz	–			
640 × 480p	59.94/60 Hz	–	RGB 4:4:4		

○: Compatible with 3D signal in Side-by-Side (Half) format

⊙: Compatible with 3D signal in Frame packing and Over-Under (Top-and-Bottom) format

¹⁾ Use a Premium High Speed HDMI Cable with Ethernet that supports 18 Gbps.

²⁾ Use a Premium High Speed HDMI Cable with Ethernet or Sony High Speed HDMI Cable with Ethernet with the Cable Type Logo.

Notes on HDMI Jack and HDMI Connections

- Use an HDMI-authorized cable.
- We do not recommend using an HDMI-DVI conversion cable.
- Audio signals (sampling frequency, bit length, etc.) transmitted from an HDMI jack may be suppressed by the connected device.
- Sound may be interrupted when the sampling frequency or the number of channels of audio output signals from the playback device is switched.
- When the TV input is selected, video signals via the HDMI IN jack are output from the HDMI OUT (TV eARC/ARC) jack.
- This system supports "TRILUMINOS."

- HDMI IN and HDMI OUT (TV eARC/ARC) jacks support bandwidth up to 18 Gbps, HDCP2.2 and HDCP2.3¹⁾, BT.2020 wide color spaces²⁾, and HDR (High Dynamic Range)³⁾ contents pass-through.
 - When connecting to a TV with a resolution that is different from that of the system, the system may restart to reset the picture output setting.
- 1) HDCP2.2 and HDCP2.3 are newly enhanced copyright protection technology that is used to protect content such as 4K movies.
 - 2) BT.2020 color space is new wider color standard that is defined for ultra-high definition television systems.
 - 3) HDR is an emerging video format that can display a wider range of brightness levels. The system is compatible with HDR10, HLG (Hybrid Log-Gamma), and Dolby Vision.

50^{US}

On BLUETOOTH Communication

- BLUETOOTH devices should be used within approximately 10 meters (33 feet) (unobstructed distance) of each other. The effective communication range may become shorter under the following conditions.
 - When a person, metal object, wall or other obstruction is between the devices with a BLUETOOTH connection
 - Locations where a wireless LAN is installed
 - Around microwave ovens that are in use
 - Locations where other electromagnetic waves occur
- BLUETOOTH devices and wireless LAN (IEEE 802.11 b/g/n) use the same frequency band (2.4 GHz). When using your BLUETOOTH device near a device with wireless LAN capability, electromagnetic interference may occur. This could result in lower data transfer rates, noise, or inability to connect. If this happens, try the following remedies:
 - Use this system at least 10 meters (33 feet) away from the wireless LAN device.
 - Turn off the power to the wireless LAN device when using your BLUETOOTH device within 10 meters (33 feet).
 - Install this system and BLUETOOTH device as close to each other as possible.
- The radio waves broadcast by this system may interfere with the operation of some medical devices. Since this interference may result in malfunction, always turn off the power on this system and BLUETOOTH device in the following locations:
 - In hospitals, on trains, in airplanes, at gas stations, and any place where flammable gasses may be present
 - Near automatic doors or fire alarms
- This system supports security functions that comply with the BLUETOOTH specification to ensure secure connection

during communication using BLUETOOTH technology. However, this security may be insufficient depending on the setting content and other factors, so always be careful when performing communication using BLUETOOTH technology.

- Sony cannot be held liable in any way for damages or other loss resulting from information leaks during communication using BLUETOOTH technology.
- BLUETOOTH communication is not necessarily guaranteed with all BLUETOOTH devices that have the same profile as this system.
- BLUETOOTH devices connected with this system must comply with the BLUETOOTH specification prescribed by the Bluetooth SIG, Inc., and must be certified to comply. However, even when a device complies with the BLUETOOTH specification, there may be cases where the characteristics or specifications of the BLUETOOTH device make it impossible to connect, or may result in different control methods, display or operation.
- Noise may occur or the audio may cut off depending on the BLUETOOTH device connected with this system, the communications environment, or surrounding conditions.

If you have any questions or problems concerning your system, please consult your nearest Sony dealer.

END USER LICENSE AGREEMENT

IMPORTANT:

BEFORE USING THE SOFTWARE, PLEASE READ THIS END USER LICENSE AGREEMENT ("EULA") CAREFULLY. BY USING THE SOFTWARE YOU ARE ACCEPTING THE TERMS OF THIS EULA. IF YOU DO NOT ACCEPT THE TERMS OF THIS EULA, YOU MAY NOT USE THE SOFTWARE.

This EULA is a legal agreement between you and Sony Electronics Inc. ("SONY"). This EULA governs your rights and obligations regarding the SONY software of SONY and/or its third party licensors (including SONY's affiliates) and their respective affiliates (collectively, the "THIRD-PARTY SUPPLIERS"), together with any updates/upgrades provided by SONY, any printed, on-line or other electronic documentation for such software, and any data files created by operation of such software (collectively, the "SOFTWARE").

Notwithstanding the foregoing, any software in the SOFTWARE having a separate end user license agreement (including, but not limited to, GNU General Public license and Lesser/Library General Public License) shall be covered by such applicable separate end user license agreement in lieu of the terms of this EULA to the extent required by such separate end user license agreement ("EXCLUDED SOFTWARE").

SOFTWARE LICENSE

The SOFTWARE is licensed, not sold. The SOFTWARE is protected by copyright and other intellectual property laws and international treaties.

COPYRIGHT

All right and title in and to the SOFTWARE (including, but not limited to, any images, photographs, animation, video, audio, music, text and "applets" incorporated into the SOFTWARE) is owned by SONY or one or more of the THIRD-PARTY SUPPLIERS.

GRANT OF LICENSE

SONY grants you a limited license to use the SOFTWARE solely in connection with your compatible device ("DEVICE") and only for your individual, non-commercial use. SONY and the THIRD-PARTY SUPPLIERS expressly reserve all rights, title and interest (including, but not limited to, all intellectual property rights) in and to the SOFTWARE that this EULA does not specifically grant to you.

REQUIREMENTS AND LIMITATIONS

You may not copy, publish, adapt, redistribute, attempt to derive source code, modify, reverse engineer, decompile, or disassemble any of the SOFTWARE, whether in whole or in part, or create any derivative works from or of the SOFTWARE unless such derivative works are intentionally facilitated by the SOFTWARE. You may not modify or tamper with any digital rights management functionality of the SOFTWARE. You may not bypass, modify, defeat or circumvent any of the functions or protections of the SOFTWARE or any mechanisms operatively linked to the SOFTWARE. You may not separate any individual component of the SOFTWARE for use on more than one DEVICE unless expressly authorized to do so by SONY. You may not remove, alter, cover or deface any trademarks or notices on the SOFTWARE. You may not share, distribute, rent, lease, sublicense, assign, transfer or sell the SOFTWARE.

The software, network services or other products other than SOFTWARE upon which the SOFTWARE'S performance depends might be interrupted or discontinued at the discretion of the suppliers (software suppliers, service suppliers, or SONY). SONY and such suppliers do not warrant that the SOFTWARE, network services, contents or other products will continue to be available, or will operate without interruption or modification.

USE OF SOFTWARE WITH COPYRIGHTED MATERIALS

The SOFTWARE may be capable of being used by you to view, store, process and/or use content created by you and/or third parties. Such content may be protected by copyright, other intellectual property laws, and/or agreements. You agree to use the SOFTWARE only in compliance with all such laws and agreements that apply to such content. You acknowledge and agree that SONY may take appropriate measures to protect the copyright of content stored, processed or used by the SOFTWARE. Such measures include, but are not limited to, counting the frequency of your backup and restoration through certain SOFTWARE features, refusal to accept your request to enable restoration of data, and termination of this EULA in the event of your illegitimate use of the SOFTWARE.

CONTENT SERVICE

PLEASE ALSO NOTE THAT THE SOFTWARE MAY BE DESIGNED TO BE USED WITH CONTENT AVAILABLE THROUGH ONE OR MORE CONTENT SERVICES ("CONTENT SERVICE"). USE OF THE SERVICE AND THAT CONTENT IS SUBJECT TO THE TERMS OF SERVICE OF THAT CONTENT SERVICE. IF YOU DECLINE TO ACCEPT THOSE TERMS, YOUR USE OF THE SOFTWARE WILL BE LIMITED. You acknowledge and agree

that certain content and services available through the SOFTWARE may be provided by third parties over which SONY has no control. USE OF THE CONTENT SERVICE REQUIRES AN INTERNET CONNECTION. THE CONTENT SERVICE MAY BE DISCONTINUED AT ANY TIME.

INTERNET CONNECTIVITY AND THIRD PARTY SERVICES

You acknowledge and agree that access to certain SOFTWARE features may require an Internet connection for which you are solely responsible. Further, you are solely responsible for payment of any third party fees associated with your Internet connection, including but not limited to Internet service provider or airtime charges. Operation of the SOFTWARE may be limited or restricted depending on the capabilities, bandwidth or technical limitations of your Internet connection and service. The provision, quality and security of such Internet connectivity are the sole responsibility of the third party providing such service.

EXPORT AND OTHER REGULATIONS

You agree to comply with all applicable export and re-export restrictions and regulations of the area or country in which you reside, and not to transfer, or authorize the transfer, of the SOFTWARE to a prohibited country or otherwise in violation of any such restrictions or regulations.

HIGH RISK ACTIVITIES

The SOFTWARE is not fault-tolerant and is not designed, manufactured or intended for use or resale as on-line control equipment in hazardous environments requiring fail-safe performance, such as in the operation of nuclear facilities, aircraft navigation or communication systems, air traffic

control, direct life support machines, or weapons systems, in which the failure of the SOFTWARE could lead to death, personal injury, or severe physical or environmental damage ("HIGH RISK ACTIVITIES"). SONY, each of the THIRD-PARTY SUPPLIERS, and each of their respective affiliates specifically disclaim any express or implied warranty, duty or condition of fitness for HIGH RISK ACTIVITIES.

EXCLUSION OF WARRANTY ON SOFTWARE

You acknowledge and agree that use of the SOFTWARE is at your sole risk and that you are responsible for use of the SOFTWARE. The SOFTWARE is provided "AS IS," without warranty, duty or condition of any kind.

SONY AND EACH OF THE THIRD-PARTY SUPPLIERS (for purposes of this Section, SONY and each of the THIRD-PARTY SUPPLIERS shall be collectively referred to as "SONY") EXPRESSLY DISCLAIM ALL WARRANTIES, DUTIES OR CONDITIONS, EXPRESS OR IMPLIED, INCLUDING, BUT NOT LIMITED TO, THE IMPLIED WARRANTIES OF MERCHANTABILITY, NONINFRINGEMENT AND FITNESS FOR A PARTICULAR PURPOSE. SONY DOES NOT WARRANT OR MAKE ANY CONDITIONS OR REPRESENTATIONS (A) THAT THE FUNCTIONS CONTAINED IN ANY OF THE SOFTWARE WILL MEET YOUR REQUIREMENTS OR THAT THEY WILL BE UPDATED, (B) THAT THE OPERATION OF ANY OF THE SOFTWARE WILL BE CORRECT OR ERROR-FREE OR THAT ANY DEFECTS WILL BE CORRECTED, (C) THAT THE SOFTWARE WILL NOT DAMAGE ANY OTHER SOFTWARE, HARDWARE OR DATA, (D) THAT ANY SOFTWARE, NETWORK SERVICES (INCLUDING THE INTERNET) OR PRODUCTS (OTHER THAN THE SOFTWARE) UPON WHICH THE SOFTWARE'S PERFORMANCE DEPENDS WILL CONTINUE TO BE AVAILABLE, UNINTERRUPTED OR UNMODIFIED, AND

(E) REGARDING THE USE OR THE RESULTS OF THE USE OF THE SOFTWARE IN TERMS OF ITS CORRECTNESS, ACCURACY, RELIABILITY, OR OTHERWISE.

NO ORAL OR WRITTEN INFORMATION OR ADVICE GIVEN BY SONY OR AN AUTHORIZED REPRESENTATIVE OF SONY SHALL CREATE A WARRANTY, DUTY OR CONDITION OR IN ANY WAY INCREASE THE SCOPE OF THIS WARRANTY. SHOULD THE SOFTWARE PROVE DEFECTIVE YOU ASSUME THE ENTIRE COST OF ALL NECESSARY SERVICING, REPAIR OR CORRECTION. SOME JURISDICTIONS DO NOT ALLOW THE EXCLUSION OF IMPLIED WARRANTIES, SO THESE EXCLUSIONS MAY NOT APPLY TO YOU.

LIMITATION OF LIABILITY

SONY AND EACH OF THE THIRD-PARTY SUPPLIERS (for purposes of this Section, SONY and each of the THIRD-PARTY SUPPLIERS shall be collectively referred to as "SONY") SHALL NOT BE LIABLE FOR ANY INCIDENTAL OR CONSEQUENTIAL DAMAGES FOR BREACH OF ANY EXPRESS OR IMPLIED WARRANTY, BREACH OF CONTRACT, NEGLIGENCE, STRICT LIABILITY OR UNDER ANY OTHER LEGAL THEORY RELATED TO THE SOFTWARE, INCLUDING, BUT NOT LIMITED TO, ANY DAMAGES ARISING OUT OF LOSS OF PROFITS, LOSS OF REVENUE, LOSS OF DATA, LOSS OF USE OF THE SOFTWARE OR ANY ASSOCIATED HARDWARE, DOWN TIME AND USER'S TIME, EVEN IF ANY OF THEM HAVE BEEN ADVISED OF THE POSSIBILITY OF SUCH DAMAGES. IN ANY CASE, EACH AND ALL OF THEIR AGGREGATE LIABILITY UNDER ANY PROVISION OF THIS EULA SHALL BE LIMITED TO THE AMOUNT ACTUALLY PAID FOR THE PRODUCT. SOME JURISDICTIONS DO NOT ALLOW THE EXCLUSION OR LIMITATION OF INCIDENTAL OR CONSEQUENTIAL DAMAGES, SO THE ABOVE EXCLUSION

OR LIMITATION MAY NOT APPLY TO YOU.

AUTOMATIC UPDATE FEATURE

From time to time, SONY or the THIRD-PARTY SUPPLIERS may automatically update or otherwise modify the SOFTWARE, including, but not limited to, for purposes of enhancement of security functions, error correction and improvement of functions, at such time as you interact with SONY's or third parties' servers, or otherwise. Such updates or modifications may delete or change the nature of features or other aspects of the SOFTWARE, including, but not limited to, functions you may rely upon. You acknowledge and agree that such activities may occur at SONY's sole discretion and that SONY may condition continued use of the SOFTWARE upon your complete installation or acceptance of such update or modifications. Any updates/modifications shall be deemed to be, and shall constitute part of, the SOFTWARE for purposes of this EULA. By acceptance of this EULA, you consent to such update/modification.

ENTIRE AGREEMENT, WAIVER, SEVERABILITY

This EULA and SONY's privacy policy, each as amended and modified from time to time, together constitute the entire agreement between you and SONY with respect to the SOFTWARE. The failure of SONY to exercise or enforce any right or provision of this EULA shall not constitute a waiver of such right or provision. If any part of this EULA is held invalid, illegal, or unenforceable, that provision shall be enforced to the maximum extent permissible so as to maintain the intent of this EULA, and the other parts will remain in full force and effect.

GOVERNING LAW AND JURISDICTION

The United Nations Convention on Contracts for the International Sale of Goods shall not apply to this EULA. This EULA shall be governed by the laws of Japan, without regards to conflict of laws provisions. Any dispute arising out of this EULA shall be subject to the exclusive venue of the Tokyo District Court in Japan, and the parties hereby consent to the venue and jurisdiction of such courts.

EQUITABLE REMEDIES

Notwithstanding anything contained in this EULA to the contrary, you acknowledge and agree that any violation of or non-compliance with this EULA by you will cause irreparable harm to SONY, for which monetary damages would be inadequate, and you consent to SONY obtaining any injunctive or equitable relief that SONY deems necessary or appropriate in such circumstances. SONY may also take any legal and technical remedies to prevent violation of and/or to enforce this EULA, including, but not limited to, immediate termination of your use of the SOFTWARE, if SONY believes in its sole discretion that you are violating or intend to violate this EULA. These remedies are in addition to any other remedies SONY may have at law, in equity or under contract.

TERMINATION

Without prejudice to any of its other rights, SONY may terminate this EULA if you fail to comply with any of its terms. In case of such termination, you must cease all use, and destroy any copies, of the SOFTWARE.

AMENDMENT

SONY RESERVES THE RIGHT TO AMEND ANY OF THE TERMS OF THIS EULA AT ITS

SOLE DISCRETION BY POSTING NOTICE ON A SONY DESIGNATED WEB SITE, BY EMAIL NOTIFICATION TO AN EMAIL ADDRESS PROVIDED BY YOU, BY PROVIDING NOTICE AS PART OF THE PROCESS IN WHICH YOU OBTAIN UPGRADES/UPDATES OR BY ANY OTHER LEGALLY RECOGNIZABLE FORM OF NOTICE. If you do not agree to the amendment, you should promptly contact SONY for instructions. Your continued use of the SOFTWARE after the effective date of any such notice shall be deemed your agreement to be bound by such amendment.

THIRD-PARTY BENEFICIARIES

Each THIRD-PARTY SUPPLIER is an express intended third-party beneficiary of, and shall have the right to enforce, each provision of this EULA with respect to the SOFTWARE of such party. Should you have any questions concerning this EULA, you may contact SONY by writing to SONY at applicable contact address of each area or country.

Copyright © 2020 Sony Electronics Inc.
All rights reserved.

Precautions

On safety

- Should any solid object or liquid fall into the system, unplug the system and have it checked by qualified personnel before operating it any further.
- Do not climb on the bar speaker and subwoofer, as you may fall down and injure yourself, or system damage may result.

On power sources

- Before operating the system, check that the operating voltage is identical to your local power supply. The operating voltage is indicated on the nameplate at the bottom of the bar speaker.
- If you are not going to use the system for a long time, be sure to disconnect the system from the wall outlet (mains). To disconnect the AC power cord (mains lead), grasp the plug itself; never pull the cord.
- One blade of the plug is wider than the other for the purpose of safety and will fit into the wall outlet (mains) only one way. If you are unable to insert the plug fully into the outlet, contact your dealer.
- AC power cord (mains lead) must be changed only at a qualified service shop.

On heat buildup

Although the system heats up during operation, this is not a malfunction. If you continuously use this system at high volume, the system temperature at the rear and bottom rises considerably. To avoid burning yourself, do not touch the system.

On placement

- Do not place the system near heat sources or in a place subject to direct sunlight, excessive dust, or mechanical shock.
- Do not place anything at the rear of the bar speaker and subwoofer that might

block the ventilation holes and cause malfunctions.

- Do not place metal objects other than a TV around the system. Wireless functions may be unstable.
- If the system is being used in combination with a TV, VCR, or tape deck, noise may result and picture quality may suffer. In such a case, place the system away from the TV, VCR, or tape deck.
- Use caution when placing the system on a surface that has been specially treated (with wax, oil, polish, etc.), as staining or discoloration of the surface may result.
- Take care to avoid any possible injury from the corners of the bar speaker and subwoofer.
- Keep 3 cm or more space under the bar speaker when you hang it on a wall.
- The speakers of this system are not of magnetically shielded type. Do not place magnetic cards on the system or near it.

On cleaning

Clean the system with a soft, dry cloth. Do not use any type of abrasive pad, scouring powder, or solvent such as alcohol or benzene.

If you have any question or problem concerning your system, please consult your nearest Sony dealer.

On handling the subwoofer

Do not place your hand into the slit of the subwoofer when lifting it. The speaker driver may be damaged. When lifting it, hold the bottom of the subwoofer.

On operation

Before connecting other devices, be sure to turn off and unplug the system.

If you encounter color irregularity on a nearby TV screen

Color irregularities may be observed on certain types of TV sets.

If color irregularity is observed...

Turn off the TV set, then turn it on again after 15 to 30 minutes.

If color irregularity is observed again...

Place the system further away from the TV set.

Copyrights and Trademarks

This system incorporates Dolby® Digital and the DTS® Digital Surround System.

* Manufactured under license from Dolby Laboratories. Dolby, Dolby Audio, Dolby Atmos, Dolby Vision, and the double-D symbol are trademarks of Dolby Laboratories.

**For DTS patents, see <https://patents.dts.com>. Manufactured under license from DTS, Inc. DTS, the Symbol, DTS and the Symbol together, DTS:X, Virtual:X, the DTS:X logo, and the DTS Virtual:X logo are registered trademarks or trademarks of DTS, Inc. in the United States and/or other countries. © DTS, Inc. All Rights Reserved.

The BLUETOOTH® word mark and logos are registered trademarks owned by Bluetooth SIG, Inc. and any use of such marks by Sony Corporation is under license. Other trademarks and trade names are those of their respective owners.

The terms HDMI, HDMI High-Definition Multimedia Interface, and the HDMI Logo are trademarks or registered trademarks of HDMI Licensing Administrator, Inc.

“BRAVIA” logo is a trademark of Sony Corporation.

“PlayStation” is a registered trademark or trademark of Sony Interactive Entertainment Inc.

MPEG Layer-3 audio coding technology and patents licensed from Fraunhofer IIS and Thomson.

Windows Media is either a registered trademark or trademark of Microsoft Corporation in the United States and/or other countries.

This product is protected by certain intellectual property rights of Microsoft Corporation. Use or distribution of such technology outside of this product is

prohibited without a license from Microsoft or an authorized Microsoft subsidiary.

“TRILUMINOS” and “TRILUMINOS” logo are a registered trademark of Sony Corporation.

All other trademarks are trademarks of their respective owners.

Index

Buttons

AUDIO 23
DIMMER 38
DISPLAY 30
IMMERSIVE AE 27
NIGHT 29
VOICE 29

A

A/V Sync 35
ARC 9, 32
Audio DRC 35
Audio format 7, 48
Audio Return Channel 9, 32
Audio settings 35
Auto Standby 37

B

BLUETOOTH
AAC 37
Pairing 24
Setting 37
Standby 37
"BRAVIA" sync 33
Brightness
Front panel display 38
Indicators 38
BT.2020 50

C

Connection (See "Wired connection"
or "Wireless connection" in
"Index")
Control for HDMI 31
Current settings 30

D

Dialog range 29
DTS Dialog control 35

E

eARC 9, 32, 36
Enhanced Audio Return Channel 9,
32, 36

F

Format
Audio 7, 48
Video 7, 49

H

HDCP 50
HDMI
Setting 36
Signal format 21
HDR 50

I

IMMERSIVE AE 27
Installation 13
IR repeater 16

M

Multiplex broadcast sound 23

N

Night mode 29

O

One-touch play 32

P

PROTECT 44

R

Remote control 11
Resetting 45

S

- Scene select 33
- Settings
 - Audio 35
 - BLUETOOTH 37
 - Brightness 38
 - Current status 30
 - HDMI 36
 - Menu 34
 - Resetting 45
 - Speaker 34
 - Surround 27
 - System 37
- Software
 - Update 37
 - Version 34, 37
- Sound Mode 28
- Sound mode Select 33
- Speaker settings 34
- Standby Through 32
- System audio control 31
- System power off 31
- System settings 37

V

- Vertical Surround Engine 27, 35
- Video format 7, 49
- Voice mode 29

W

- Wired connection
 - 4K TV and devices 20
 - AV devices 17
 - TV 17
- Wireless connection
 - BLUETOOTH devices 24
 - Subwoofer 15
 - TV 17

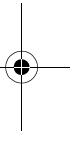
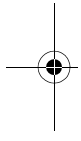
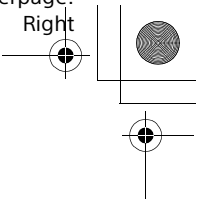
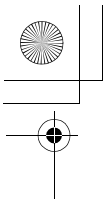

 **DOLBY ATMOS**®



HDMI



61^{US}

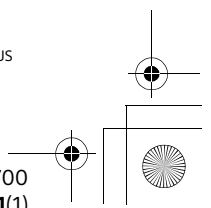
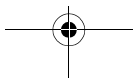
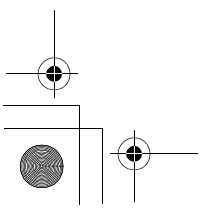

Enregistrement du propriétaire

Les numéros de modèle et de série sont situés sur la partie inférieure de la barre de haut-parleurs. Notez les numéros dans l'espace ci-dessous. Reportez-vous à ces numéros lorsque vous contactez votre détaillant Sony à propos de cet appareil.

N° de modèle HT-G700

N° de série _____

AVERTISSEMENT

Pour réduire les risques d'incendie ou d'électrocution, gardez ce système à l'abri de la pluie et de l'humidité.

Le système n'est pas déconnecté de la source d'alimentation tant qu'il reste branché à la prise CA, même si le système a été éteint.

Pour réduire le risque d'incendie, n'obstruez pas l'orifice de ventilation du système avec un journal, une nappe, une tenture, etc.

N'exposez pas le système à une source de flamme nue (par exemple, une bougie allumée).

Pour réduire le risque d'incendie ou d'électrocution, n'exposez pas ce système à des éclaboussures ou des gouttes d'eau et ne posez pas des objets remplis de liquides, notamment des vases, sur le système.

Comme la fiche principale est utilisée pour déconnecter le système de la prise électrique, connectez le système à une prise CA facilement accessible. Si vous constatez que le système ne fonctionne pas normalement, déconnectez immédiatement la fiche principale de la prise CA.

N'installez pas le système dans un espace confiné, tel qu'une bibliothèque ou un meuble encastré.

MISE EN GARDE

Risque d'explosion si la pile est remplacée par un type de pile inadéquat.

N'exposez pas les piles ou un appareil contenant des piles à une chaleur excessive, notamment aux rayons directs du soleil ou à des flammes.

Ne pas placer ce produit près d'appareils médicaux.

Ce produit (y compris les accessoires) est doté d'un ou plusieurs aimants qui peuvent interférer avec le fonctionnement des stimulateurs cardiaques, robinets de dérivation programmables pour traitement d'hydrocéphalie ou autres appareils médicaux. Ne placez pas ce produit près des personnes qui utilisent de tels appareils médicaux. Consultez votre médecin avant d'utiliser ce produit si vous utilisez de tels appareils médicaux.

Utilisation à l'intérieur seulement.

Pour la barre de haut-parleurs

La plaque signalétique est située sur la partie inférieure de la barre de haut-parleurs.

Pour les clients aux États-Unis

REMARQUE :

Ce système a été testé et s'est révélé conforme aux limites des appareils numériques de Classe B, conformément à l'alinéa 15 de la réglementation FCC. Ces limites sont conçues pour assurer une protection raisonnable contre les interférences nuisibles dans une installation résidentielle. Ce système génère, utilise et peut rayonner de l'énergie de fréquence radio qui, en cas d'installation et d'utilisation non conformes aux instructions, peut

engendrer des interférences nuisibles avec les communications radio. Il n'est toutefois pas garanti qu'aucune interférence ne surviendra dans une installation particulière. Si ce système altère effectivement la réception radio ou télévisée, ce qui peut être déterminé en mettant le système hors tension, puis à nouveau sous tension, nous vous encourageons à essayer de remédier à la situation en prenant une ou plusieurs des mesures ci-après :

- Réorientez ou repositionnez l'antenne de réception.
- Augmentez la distance qui sépare le système du récepteur.
- Raccordez le système à la prise d'un circuit différent de celui auquel le récepteur est raccordé.
- Sollicitez l'aide de votre revendeur ou d'un technicien en radio/télévision expérimenté.

Des câbles et connecteurs correctement blindés et mis à la terre doivent être utilisés pour le raccordement à des ordinateurs hôtes ou des périphériques afin de satisfaire aux limites d'émission du FCC.

Pour toute question au sujet de cette barre de son :
Visitez : www.sony.com/support
Contactez : Sony Customer Information Service Center au 1-800-222-SONY (7669)
Écrivez : Sony Customer Information Service Center 12451 Gateway Blvd., Fort Myers, FL 33913

Déclaration de conformité du fournisseur

Nom commercial : SONY
No de modèle : HT-G700
Responsable : Sony Electronics Inc.
Adresse : 16535 Via Esprillo, San Diego, CA 92127 É.-U.
No de téléphone : 858-942-2230

Cet appareil est conforme à la Partie 15 de la réglementation de la FCC des États-Unis. Son utilisation est sujette aux deux conditions suivantes : (1) Cet appareil ne doit pas générer d'interférences nuisibles et (2) il doit être en mesure d'accepter toute interférence reçue, y compris les interférences pouvant générer un fonctionnement indésirable.

ATTENTION

Vous êtes prévenu que toute modification ou tout changement non expressément approuvé dans ce manuel peut annuler votre autorisation à utiliser ce système.

Ce système ne doit pas se trouver à proximité d'un autre émetteur ou d'une autre antenne, ou encore être utilisé en même temps que ceux-ci.

Ce système est conforme aux limites d'exposition au rayonnement du FCC déterminées pour un environnement incontrôlé et rencontre les recommandations d'exposition aux radiofréquences (RF) du FCC. Ce système devrait être installé et utilisé en gardant le radiateur à au moins 20 cm ou plus du corps d'une personne.

Pour les clients au Canada

Il est impératif d'utiliser des câbles et des connecteurs correctement blindés et mis à la terre pour la connexion à des ordinateurs hôtes et/ou aux périphériques.

L'émetteur/récepteur exempt de licence contenu dans le présent système est conforme aux CNR d'Innovation, Sciences et Développement économique Canada applicables aux deux conditions suivantes :

FR

3FR

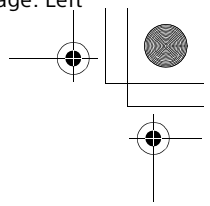
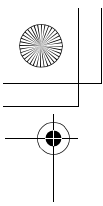

- (1) le système ne doit pas produire de brouillage;
- (2) l'utilisateur du système doit accepter tout brouillage radioélectrique subi, même si le brouillage est susceptible de compromettre le fonctionnement du système.

Ce système est conforme aux limites d'exposition aux rayonnements d'ISED énoncées pour un environnement non contrôlé et respecte les règles d'exposition aux fréquences radioélectriques (RF) CNR-102 d'ISED. Ce système doit être installé et utilisé en gardant une distance de 20 cm ou plus entre le radiateur et le corps humain.

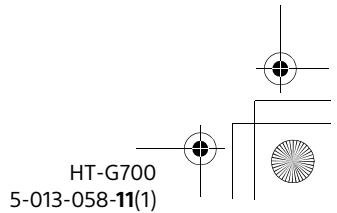
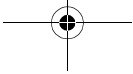
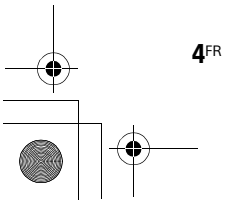
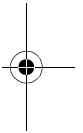
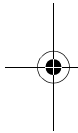

Table des matières

À propos de ce Manuel d'instructions	6
Que contient la boîte?	7
Possibilités offertes par le système	8
Guide des pièces et commandes	9

Installation du système

Installation de la barre de haut- parleurs et du caisson de graves	→	Manuel de démarrage (document distinct)
Fixation de la barre de haut-parleurs sur un mur	14	
Connexion du caisson de graves	16	
Lorsque la télécommande du téléviseur ne fonctionne pas ...	17	

Raccordement à un téléviseur ou appareil AV

Raccordement à un téléviseur ou appareil AV à l'aide du câble HDMI	→	Manuel de démarrage (document distinct)
Connexion sans fil d'un téléviseur Sony avec la fonction BLUETOOTH	19	
Raccordement d'un téléviseur 4K et d'appareils 4K	22	

Écoute de la musique/du son

Écoute d'un téléviseur et d'autres appareils	25
Réglage du volume	26
Apprécier un son diffusé en multiplex (AUDIO)	26
Écoute de la musique/du son avec la fonction BLUETOOTH®	27

Réglage de la qualité sonore

Apprécier une expérience ambiophonique immersive (IMMERSIVE AE)	30
Réglage de l'effet sonore adapté aux sources sonores (Mode sonore)	31
Améliorer la clarté des dialogues (VOICE)	32
Apprécier un son clair avec un volume faible pendant la nuit (NIGHT)	32
Vérifier les réglages sonores actuels (DISPLAY)	33

Utilisation de la fonction Contrôle pour HDMI

Utilisation de la fonction Contrôle pour HDMI	34
Utilisation de la fonction « BRAVIA » Sync	36

Modification des réglages

Utilisation du menu de réglage	37
Modification de la luminosité de l'affichage du panneau avant et des témoins (DIMMER)	41
Économie d'énergie en mode de veille	42

Dépannage

Dépannage	43
Réinitialisation du système	50

Informations complémentaires

Caractéristiques techniques	51
Formats audio d'entrée pris en charge	53
Formats vidéo HDMI pris en charge	54

À propos de la communication

BLUETOOTH	56
CONTRAT DE LICENCE	
D'UTILISATEUR FINAL	57
Précautions	62
Index	65

À propos de ce Manuel d'instructions

- Les instructions dans ce Manuel d'instructions décrivent les commandes de la télécommande.
- Certaines illustrations sont présentées sous forme de dessins conceptuels et peuvent différer des produits réels.
- Les réglages par défaut sont soulignés dans chaque description de fonction.
- Les caractères entre crochets [] apparaissent dans l'affichage du panneau avant.

Que contient la boîte?

- Barre de haut-parleurs (1)

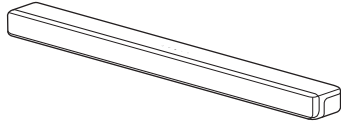

- Caisson de graves (1)



- Télécommande (1)/
Pile R03 (taille AAA) (2)

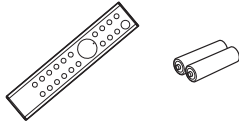

- Câble HDMI (prenant en charge la spécification équivalente au câble HDMI haute vitesse de qualité supérieure avec Ethernet) (1)

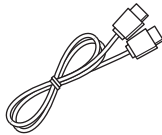

- Cordon d'alimentation CA (2)

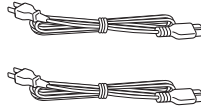

- CALIBRE DE MONTAGE MURAL (1)

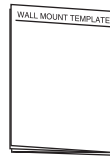

- Manuel de démarrage



- Manuel d'instructions (ce document)

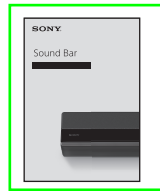

Possibilités offertes par le système

Le système prend en charge les formats audio basés sur objets tels que Dolby Atmos et DTS:X, ainsi que les formats vidéo HDR tels que HDR10, HLG et Dolby Vision.

« Écoute d'un téléviseur et d'autres appareils » (page 25)

Lecteur Blu-ray Disc™, décodeur de câblodistribution, récepteur satellite, etc.

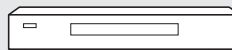
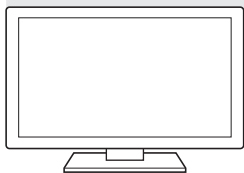

« Connexion sans fil d'un téléviseur Sony avec la fonction BLUETOOTH » (page 19)

Raccordement de base :
Reportez-vous au « Manuel de démarrage » (document distinct).
Autres raccords :
Consultez « Raccordement à un téléviseur ou appareil AV » (page 19).

« Utilisation de la fonction Contrôle pour HDMI » (page 34)
« Utilisation de la fonction « BRAVIA » Sync » (page 36)

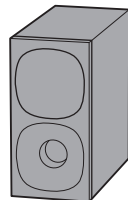
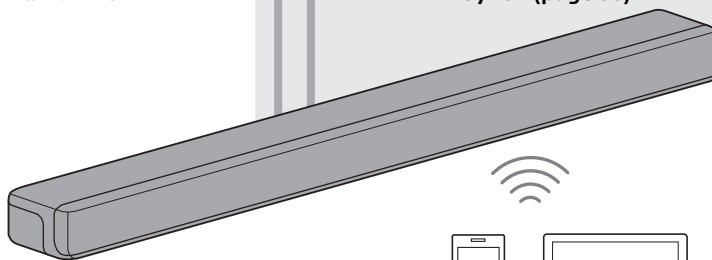

« Connexion du caisson de graves » (page 16)

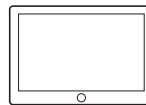

« Écoute de la musique/du son avec la fonction BLUETOOTH® » (page 27)

Guide des pièces et commandes

Les détails sont omis des illustrations.

Barre de haut-parleurs (Appareil principal)

Avant

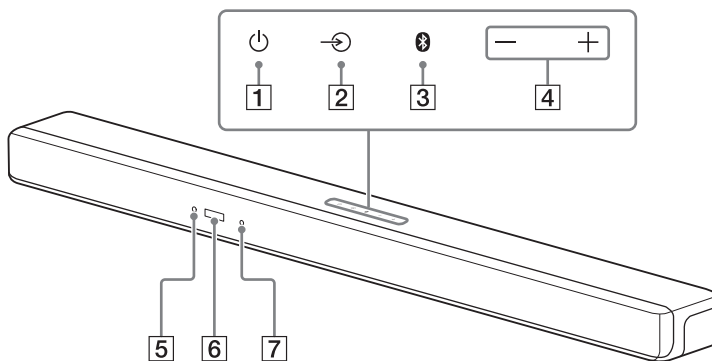

1 Touche  (alimentation)

Allume le système ou le règle en mode de veille.

2 Touche  (sélection d'entrée)

Permet de sélectionner l'entrée pour la lecture sur le système.

3 Touche **BLUETOOTH** (page 27)

4 Touches +/- (volume)

5 Témoin **BLUETOOTH**

- S'allume en bleu : Connexion BLUETOOTH établie.
- Clignote lentement en bleu à plusieurs reprises : Tentative de connexion BLUETOOTH en cours.
- Clignote deux fois en bleu à plusieurs reprises : Pendant l'état de veille de jumelage.

6 Affichage du panneau avant

7 Capteur de télécommande

Pointez la télécommande vers le capteur de télécommande pour faire fonctionner le système.

Arrière

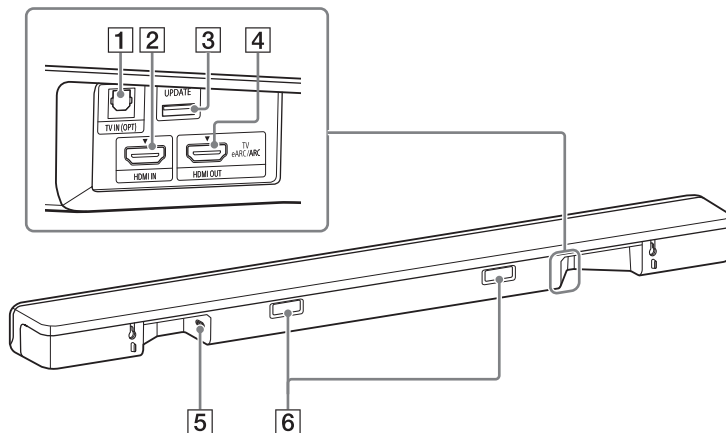

1 Prise TV IN (OPT)

2 Prise HDMI IN

Pour les caractéristiques et les remarques sur les raccordements, consultez « Formats vidéo HDMI pris en charge » (page 54).

3 Port UPDATE (page 40)

Connectez la mémoire USB lors de la mise à jour du système.

4 Prise HDMI OUT (TV eARC/ARC)

Raccordez un téléviseur muni d'une prise d'entrée HDMI avec un câble HDMI.
Le système est compatible avec eARC et ARC. ARC est la fonction permettant d'envoyer le son du téléviseur à un appareil AV, comme le système, à partir de la prise HDMI du téléviseur. eARC est une extension de la fonction ARC qui permet la transmission d'un contenu audio basé sur

objet ou LPCM multicanal qu'il n'est pas possible de transmettre avec ARC. Pour plus de détails sur la fonction eARC, consultez « [eARC] » (page 39). Pour les formats audio pris en charge, consultez « Formats audio d'entrée pris en charge » (page 53). Pour les caractéristiques et les remarques sur les raccordements, consultez « Formats vidéo HDMI pris en charge » (page 54).

5 Entrée CA

6 IR-Repeater (page 17)

Transmet le signal de la télécommande du téléviseur au téléviseur.

Caisson de graves

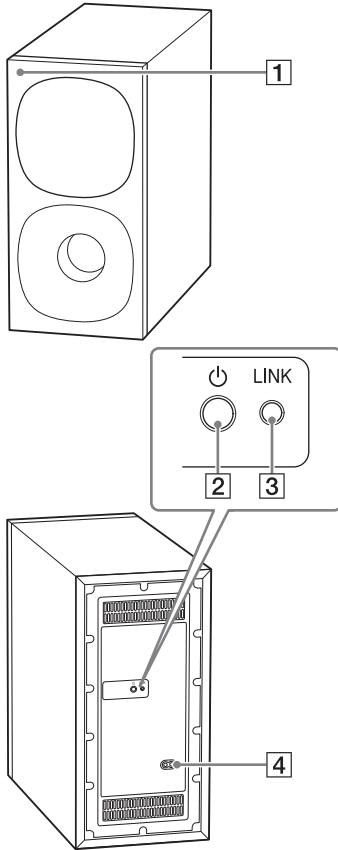

1 Témoin d'alimentation

- Clignote lentement en ambre : Tentative de connexion du caisson de graves au système avec la connexion manuelle./Mise à jour du logiciel.
- Clignote rapidement en ambre : Caisson de graves en état de veille de jumelage avec la connexion manuelle.
- S'allume en ambre : Caisson de graves connecté au système avec la connexion manuelle.
- Clignote lentement en vert : Tentative de connexion du caisson de graves au système.
- S'allume en vert : Caisson de graves connecté au système.
- S'allume en rouge : Caisson de graves en mode de veille.
- S'éteint : Caisson de graves éteint.

2 Touche (alimentation)

Allume ou éteint le caisson de graves.

3 Touche LINK (page 16)

4 Entrée CA

Télécommande

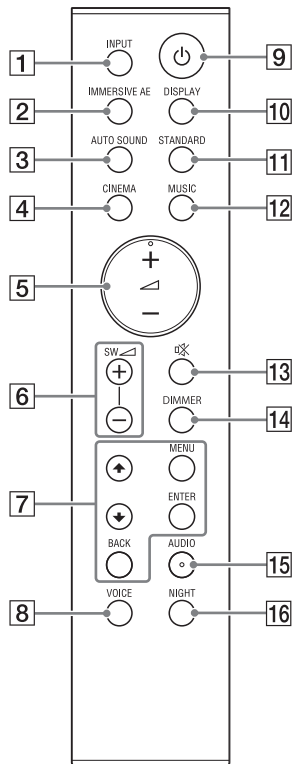

1 INPUT (page 25)

Sélectionne la source de lecture. Chaque fois que vous appuyez sur INPUT, l'entrée sélectionnée apparaît dans l'affichage du panneau avant de manière cyclique dans l'ordre suivant.
[TV] → [HDMI] → [BT]

2 IMMERSIVE AE (page 30)

Active/désactive la fonction ambiophonique verticale.

3 AUTO SOUND (page 31)

4 CINEMA (page 31)

5 \triangleleft (volume) +/- (page 26)

Règle le volume.

6 SW \triangleleft (volume du caisson de graves) +/- (page 26)

Règle le volume du caisson de graves.

7 MENU (page 37)

Permet d'afficher/de quitter le mode de menu de réglage.

\uparrow/\downarrow (page 37)

Sélectionne les options du menu de réglage.

ENTER (page 37)

Permet de valider la sélection.

BACK (page 37)

Permet de revenir à l'affichage précédent.

8 VOICE (page 32)

9 ⏻ (alimentation)

Allume le système ou le règle en mode de veille.



10 DISPLAY (page 33)

Affiche les réglages du mode sonore, de la fonction IMMERSIVE AE, du mode voix, du mode nuit et des informations de diffusion actuelles.

11 STANDARD (page 31)

12 MUSIC (page 31)

13 (coupure du son)

Désactive temporairement le son.

14 DIMMER (page 41)

15 AUDIO* (page 26)

16 NIGHT (page 32)

* Les touches AUDIO et  + comportent un point tactile. Utilisez ce point comme guide pendant l'utilisation.

À propos du remplacement des piles de la télécommande



Lorsque le système ne répond plus à la télécommande, remplacez les deux piles par des piles neuves. Utilisez des piles au manganèse R03 (taille AAA) pour le remplacement.



Installation du système

Installation de la barre de haut-parleurs et du caisson de graves

Reportez-vous au Manuel de démarrage (document distinct).

Fixation de la barre de haut-parleurs sur un mur

Vous pouvez fixer la barre de haut-parleurs sur un mur.

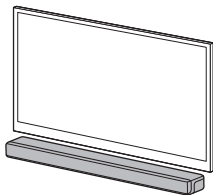

Remarques

- Préparez des vis (non fournies) adaptées au matériau et à la résistance du mur. Comme les plaques de plâtre sont particulièrement fragiles, fixez fermement les vis à une poutre du mur. Installez les enceintes à l'horizontale en les suspendant à des vis insérées dans des montants, sur une partie plate et continue du mur.
- Confiez l'installation à un détaillant Sony ou à un installateur agréé et portez une attention particulière aux consignes de sécurité pendant l'installation.
- Sony ne peut être tenu responsable des accidents ou dommages occasionnés par une installation incorrecte, une résistance insuffisante du mur, une installation

inappropriée des vis, une catastrophe naturelle, etc.

- 1 Préparez deux vis (non fournies) adaptées aux trous de fixation murale situés à l'arrière de la barre de haut-parleurs.

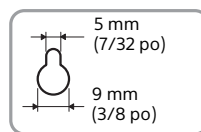
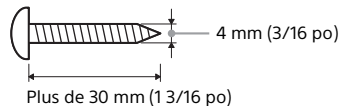

Trou à l'arrière de la barre de haut-parleurs

- 2 Collez le CALIBRE DE MONTAGE MURAL (fourni) sur le mur.

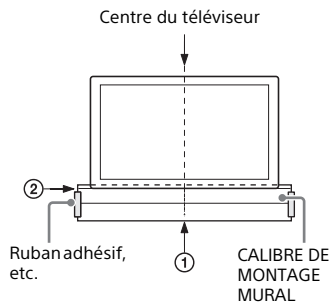

- 1 Aligned la LIGNE CENTRALE DU TÉLÉVISEUR (1) du CALIBRE DE MONTAGE MURAL avec la ligne centrale de votre téléviseur.
- 2 Aligned la LIGNE ARRIÈRE DU TÉLÉVISEUR (2) du CALIBRE DE MONTAGE MURAL avec le bas de votre téléviseur, puis collez le CALIBRE DE MONTAGE MURAL

sur le mur en utilisant un ruban adhésif disponible sur le marché, etc.

3 Fixez les vis dans les marques (Ⓞ) sur la LIGNE DE VIS (③) du CALIBRE DE MONTAGE MURAL de la manière indiquée dans l'illustration ci-dessous.

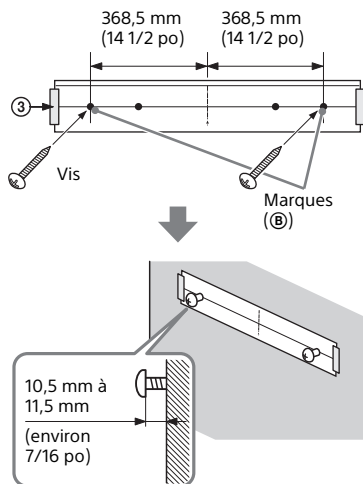

4 Retirez le CALIBRE DE MONTAGE MURAL.

5 Suspendez la barre de haut-parleurs aux vis.

Alignez les trous à l'arrière de la barre de haut-parleurs avec les vis, puis suspendez la barre de haut-parleurs aux deux vis.

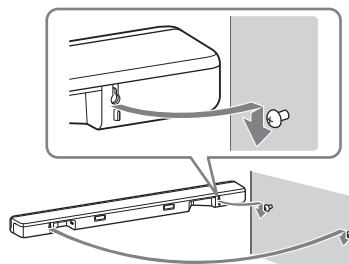

Remarques

- Au moment de coller le CALIBRE DE MONTAGE MURAL, lissez-le complètement.
- Installez la barre de haut-parleurs à une distance d'au moins 70 mm (2 7/8 po) du téléviseur.

Connexion du caisson de graves

Connexion automatique du caisson de graves

Le caisson de graves est connecté automatiquement au système lors de la mise en marche.

Pour plus de détails, reportez-vous au Manuel de démarrage (document distinct) pour la connexion du caisson de graves.

Connexion manuelle du caisson de graves

Si vous ne parvenez pas à connecter le caisson de graves au système, ou encore si vous utilisez plusieurs produits sans fil et souhaitez spécifier la connexion sans fil pour relier le système au caisson de graves, effectuez la connexion manuelle.

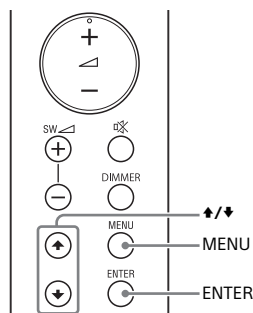
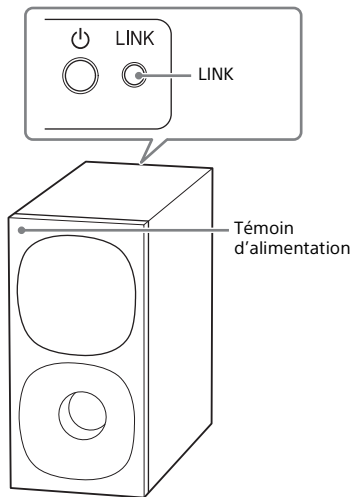

- 1 Appuyez sur MENU.**
[SPEAKER] apparaît dans l'affichage du panneau avant.
- 2 Appuyez sur $\blacktriangle/\blacktriangledown$ pour sélectionner [SPEAKER], puis appuyez sur ENTER.**
- 3 Appuyez sur $\blacktriangle/\blacktriangledown$ pour sélectionner [LINK], puis appuyez sur ENTER.**

- Appuyez sur **▲/▼** pour sélectionner [START], puis appuyez sur **ENTER**.
[LINK] clignote dans l'affichage du panneau avant.

Pour annuler la liaison manuelle, sélectionnez [CANCEL].

- Appuyez sur la touche **LINK** du caisson de graves.

La liaison manuelle démarre. Le témoin d'alimentation du caisson de graves clignote en ambre.

- Lorsque [DONE] apparaît dans l'affichage du panneau avant, appuyez sur **MENU**.

La liaison est établie et le témoin d'alimentation du caisson de graves s'allume en ambre.

Remarque

Si [ERROR] apparaît dans l'affichage du panneau avant, la connexion du caisson de graves n'est pas établie. Effectuez de nouveau la connexion manuelle.

Lorsque la télécommande du téléviseur ne fonctionne pas

Lorsque la barre de haut-parleurs bloque le capteur de télécommande du téléviseur, la télécommande du téléviseur pourrait ne pas fonctionner. Dans ce cas, activez la fonction IR-Repeater du système.

Vous pouvez contrôler le téléviseur à l'aide de la télécommande du téléviseur en envoyant le signal de télécommande depuis l'arrière de la barre de haut-parleurs.

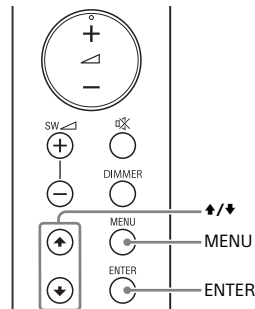

- Appuyez sur **MENU**.
[SPEAKER] apparaît dans l'affichage du panneau avant.
- Appuyez sur **▲/▼** pour sélectionner [SYSTEM], puis appuyez sur **ENTER**.
- Appuyez sur **▲/▼** pour sélectionner [IR REPEATER], puis appuyez sur **ENTER**.
- Sélectionnez [ON].

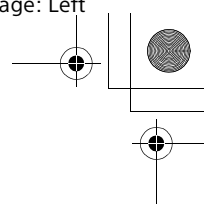
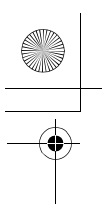

Remarques

- Assurez-vous que la télécommande du téléviseur ne peut pas contrôler le téléviseur, puis réglez [IR REPEATER] à [ON]. Si le paramètre est réglé à [ON] pendant que la télécommande peut contrôler le téléviseur, un problème de fonctionnement peut survenir en raison des interférences entre la commande directe de la télécommande et la commande via la barre de haut-parleurs.
- Même si [IR REPEATER] est réglé à [ON], cette fonction pourrait ne pas fonctionner, selon votre téléviseur. De plus, les télécommandes des autres appareils tels que les climatiseurs pourraient ne pas fonctionner correctement. Dans ce cas, changez la position d'installation du système ou du téléviseur.

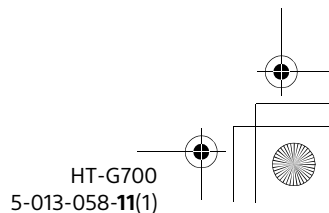
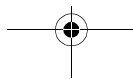
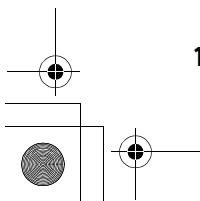
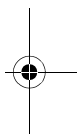
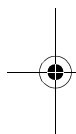

Raccordement à un téléviseur ou appareil AV

Raccordement à un téléviseur ou appareil AV à l'aide du câble HDMI

Pour raccorder un téléviseur 4K ou des appareils 4K

Consultez «Raccordement d'un téléviseur 4K et d'appareils 4K» (page 22).

Pour raccorder un téléviseur compatible avec eARC

Pour le raccordement, reportez-vous au Manuel de démarrage (document distinct). Pour les réglages, consultez «[EARC]» (page 39).

Pour le raccordement à un téléviseur autre que celui mentionné ci-dessus, reportez-vous au Manuel de démarrage (document distinct).

Connexion sans fil d'un téléviseur Sony avec la fonction BLUETOOTH

Lors de l'utilisation d'un téléviseur Sony* avec la fonction BLUETOOTH, vous pouvez écouter le son du téléviseur en établissant une connexion sans fil entre le système et le téléviseur.

* Le téléviseur doit être compatible avec A2DP (Advanced Audio Distribution Profile) du profil BLUETOOTH.

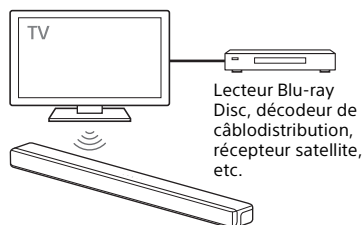

Écoute du son du téléviseur à l'aide d'une connexion sans fil entre le système et le téléviseur

Pour établir une connexion sans fil entre le système et le téléviseur, vous devez effectuer le jumelage du système et du téléviseur en utilisant la fonction BLUETOOTH.

Le jumelage est le processus requis pour l'enregistrement mutuel préalable des informations sur les appareils BLUETOOTH à connecter sans fil.

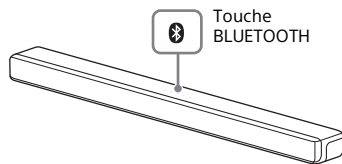
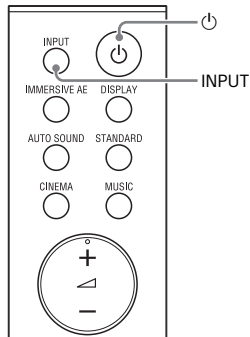

- 1 Allumez le téléviseur.**
- 2 Allumez le système.**
- 3 Maintenez enfoncées les touches BLUETOOTH de la barre de haut-parleurs et INPUT de la télécommande simultanément pendant 5 secondes.**

Le système passe en mode de jumelage, [PAIRING] apparaît dans l'affichage du panneau avant et le témoin BLUETOOTH clignote deux fois à plusieurs reprises.

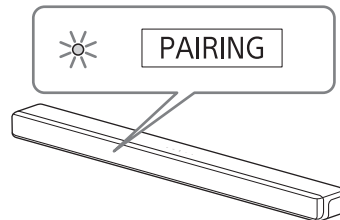

- 4 Sur le téléviseur, recherchez le système en effectuant l'opération de jumelage.**

La liste d'appareils BLUETOOTH recherchés apparaît à l'écran du téléviseur.

Pour la méthode de jumelage de l'appareil BLUETOOTH au téléviseur, reportez-vous au manuel d'instructions du téléviseur.

- 5 Jumelez le système et le téléviseur en sélectionnant « HT-G700 » dans la liste à l'écran du téléviseur.**

- 6 Assurez-vous que le témoin BLUETOOTH de la barre de haut-parleurs s'allume en bleu et que [TV-BT] apparaît dans l'affichage du panneau avant.**

Une connexion est établie entre le système et le téléviseur.

- 7 Sélectionnez l'émission ou l'entrée de l'appareil en utilisant la télécommande du téléviseur.**

Le son de l'image affichée à l'écran du téléviseur est émis par le système.

- 8 Réglez le volume du système en utilisant la télécommande du téléviseur.**

Lorsque vous appuyez sur la touche de coupure du son de la télécommande du téléviseur, le son est coupé temporairement.

Remarques

- Si le son du téléviseur n'est pas émis par le système, sélectionnez l'entrée TV en appuyant sur INPUT et vérifiez l'état de l'affichage du panneau avant et des témoins de la barre de haut-parleurs.
 - [TV-BT] apparaît dans l'affichage du panneau avant : Le système et le téléviseur sont connectés et le son du téléviseur est émis par le système.
 - Le témoin BLUETOOTH clignote deux fois à plusieurs reprises et [PAIRING] apparaît dans l'affichage du panneau avant : Effectuez le jumelage sur le téléviseur.
 - [TV] apparaît dans l'affichage du panneau avant : Suivez les étapes à partir du début.
- Lorsque vous raccordez le système et le téléviseur avec le câble HDMI (fourni), la connexion BLUETOOTH est annulée. Pour connecter de nouveau le système et le téléviseur avec la fonction BLUETOOTH, déconnectez le câble HDMI, puis effectuez la procédure de connexion depuis le début.
- Pendant que le système connecte le téléviseur avec la fonction BLUETOOTH et que [AUTO SOUND] est sélectionné comme mode sonore, [STANDARD] est sélectionné comme mode sonore.

Écoute du son du téléviseur jumelé

Vous pouvez allumer/éteindre le système, régler le volume et couper le son en utilisant la télécommande du téléviseur lorsqu'une connexion sans fil est établie entre le téléviseur et le système.

1 Allumez le téléviseur avec la télécommande du téléviseur.

Le système est mis en marche par interverrouillage avec l'alimentation du téléviseur, puis le son du téléviseur est émis par le système.

2 Sélectionnez l'émission ou l'entrée de l'appareil en utilisant la télécommande du téléviseur.

Le son de l'image affichée à l'écran du téléviseur est émis par le système.

3 Réglez le volume du système en utilisant la télécommande du téléviseur.

Lorsque vous appuyez sur la touche de coupure du son de la télécommande du téléviseur, le son est coupé temporairement.

Remarque

Si vous sélectionnez une entrée autre que TV sur la télécommande fournie avec le système, le son du téléviseur n'est pas émis par le système. Pour émettre le son du téléviseur, sélectionnez l'entrée TV en appuyant sur INPUT.

Conseil

Lorsque le téléviseur est éteint, le système est également éteint par interverrouillage avec l'alimentation du téléviseur.

Raccordement d'un téléviseur 4K et d'appareils 4K

Toutes les prises HDMI du système prennent en charge le format vidéo 4K et les protections HDCP2.2 et HDCP2.3 (High-bandwidth Digital Content Protection, révisions de système 2.2 et 2.3). Pour regarder un contenu vidéo 4K, raccordez le téléviseur 4K et les appareils 4K au système via une prise HDMI compatible HDCP2.2 ou HDCP2.3 sur chaque appareil. Vous pouvez visionner le contenu vidéo 4K uniquement à l'aide d'un raccordement par prise HDMI compatible HDCP2.2 ou HDCP2.3.

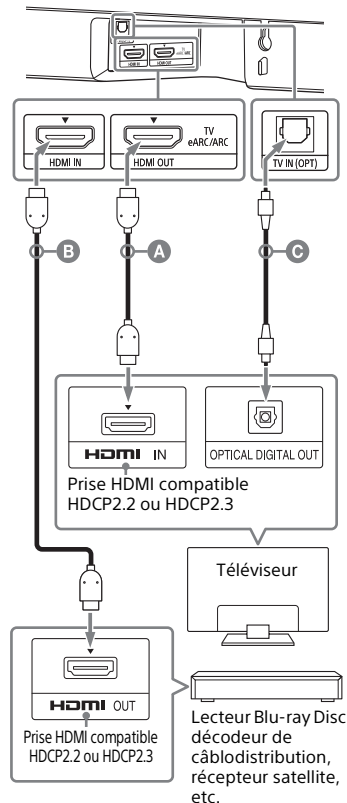

- A** Câble HDMI (fourni)
- B** Câble HDMI (non fourni)
Utilisez un câble HDMI prenant en charge le format vidéo 4K que vous souhaitez regarder. Pour plus de détails, consultez «Formats vidéo HDMI pris en charge» (page 54).
- C** Câble numérique optique (non fourni)

1 Identifiez la prise HDMI IN de votre téléviseur qui est compatible avec HDCP2.2 ou HDCP2.3.

Reportez-vous au manuel d'instructions du téléviseur.

2 Raccordez la prise HDMI IN compatible HDCP2.2 ou HDCP2.3 du téléviseur à la prise HDMI OUT (TV eARC/ARC) du système à l'aide du câble HDMI (fourni).

Si la prise HDMI IN compatible HDCP2.2 ou HDCP2.3 du téléviseur prend en charge eARC ou ARC, le raccordement du téléviseur est terminé. Passez à l'étape 4.

3 Si la prise HDMI IN compatible HDCP2.2 ou HDCP2.3 du téléviseur ne prend pas en charge eARC ou ARC, raccordez la prise de sortie numérique optique du téléviseur à la prise TV IN (OPT) du système à l'aide d'un câble numérique optique (non fourni).

Lors du raccordement du téléviseur et du système avec le câble HDMI (fourni) uniquement, le son du téléviseur n'est pas émis par le système. Raccordez un câble numérique optique (non fourni). Le raccordement du téléviseur est terminé.

4 Raccordez la prise HDMI OUT compatible HDCP2.2 ou HDCP2.3 de l'appareil 4K à la prise HDMI IN du système à l'aide d'un câble HDMI (non fourni).

Reportez-vous au manuel d'instructions de l'appareil 4K pour vérifier que la prise HDMI OUT de l'appareil 4K est compatible avec HDCP2.2 ou HDCP2.3. Le raccordement de l'appareil 4K est terminé.

5 Allumez le téléviseur.

6 Allumez le système.

Conseil

Le contenu 4K peut être regardé à l'aide d'un appareil compatible avec HDCP2.2 ou HDCP2.3, même si des appareils avec

différentes versions (par exemple, un téléviseur compatible avec HDCP2.2 et un appareil 4K compatible avec HDCP2.3) sont raccordés.

Réglage du format de signal HDMI pour regarder un contenu vidéo 4K

Pour regarder un contenu vidéo 4K, sélectionnez le réglage approprié pour le téléviseur 4K et l'appareil 4K raccordés.

1 Appuyez sur MENU.

[SPEAKER] apparaît dans l'affichage du panneau avant.

2 Appuyez sur $\blacktriangle/\blacktriangledown$ pour sélectionner [HDMI], puis appuyez sur ENTER.

3 Appuyez sur $\blacktriangle/\blacktriangledown$ pour sélectionner [FORMAT], puis appuyez sur ENTER.

4 Appuyez plusieurs fois sur $\blacktriangle/\blacktriangledown$ pour sélectionner le réglage souhaité.

- [ENHANCED] : Sélectionnez cette option lorsque le téléviseur et les appareils raccordés prennent en charge les formats vidéo à bande passante élevée comme 4K 60p 4:4:4, etc.
- [STANDARD] : Sélectionnez cette option lorsque le téléviseur et les appareils raccordés prennent en charge les formats vidéo à bande passante standard.

Pour connaître la relation entre ce réglage, les signaux de format vidéo pris en charge et les câbles HDMI à utiliser, consultez «Formats vidéo HDMI pris en charge» (page 54).

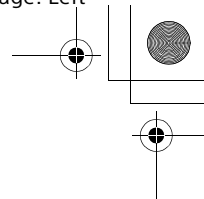
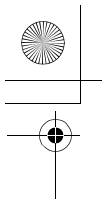

Remarques

- Selon le téléviseur, la configuration du téléviseur pour la sortie HDMI pourrait être requise. Reportez-vous au manuel d'instructions du téléviseur.
- Si l'image ne s'affiche pas pendant le réglage de [FORMAT] à [ENHANCED], réglez le format à [STANDARD].

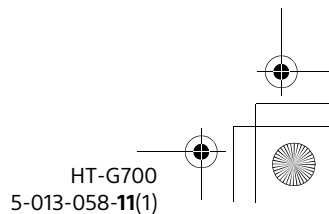
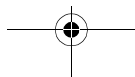
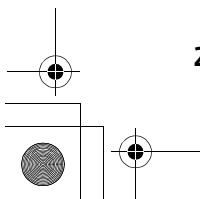
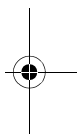
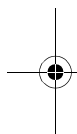

Écoute de la musique/du son

Écoute d'un téléviseur et d'autres appareils

Vous pouvez sélectionner l'appareil raccordé et écouter le son de cet appareil.

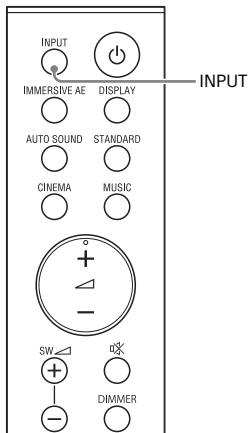

1 Appuyez sur INPUT pour sélectionner l'entrée de l'appareil dont vous souhaitez écouter le son.

Chaque fois que vous appuyez sur INPUT, l'entrée sélectionnée apparaît dans l'affichage du panneau avant de manière cyclique dans l'ordre suivant.
[TV] → [HDMI] → [BT]

Affichage du panneau avant

[TV]

Sélectionne le son du téléviseur raccordé à la prise TV IN (OPT) ou HDMI OUT (TV eARC/ARC) du système. Vous pouvez sélectionner la prise d'entrée utilisée pour l'écoute sonore avec [HDMI] - [TV AUDIO] dans le menu de configuration (page 39).

[HDMI]

Sélectionne le son de l'appareil raccordé à prise HDMI IN du système.

[BT]

Sélectionne le son de l'appareil connecté au système avec la fonction BLUETOOTH. Pour plus de détails, consultez «Écoute de la musique/du son avec la fonction BLUETOOTH®» (page 27).

2 Réglez le volume (page 26).

Conseil

Vous pouvez également sélectionner l'entrée en appuyant sur la touche de la barre de haut-parleurs.

Réglage du volume

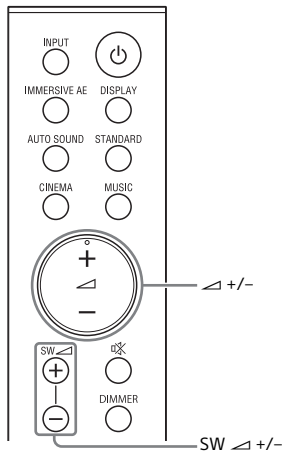

Pour régler le volume du système

Appuyez sur \triangle +/-.
Le niveau de volume apparaît dans l'affichage du panneau avant.

Pour régler le volume du caisson de graves

Appuyez sur SW \triangle (volume du caisson de graves) +/-.
Le niveau de volume apparaît dans l'affichage du panneau avant.

Le caisson de graves est conçu pour reproduire les sons graves ou basses fréquences.

Remarques

- Lorsque la source d'entrée ne contient pas beaucoup de sons graves, comme les émissions de télévision, les sons graves émis par le caisson de graves peuvent être difficiles à entendre.
- SW \triangle +/- ne fonctionne pas lorsque le caisson de graves n'est pas connecté.

Apprécier un son diffusé en multiplex (AUDIO)

Vous pouvez apprécier un son diffusé en multiplex lorsque le système reçoit un signal diffusé en multiplex Dolby Digital.

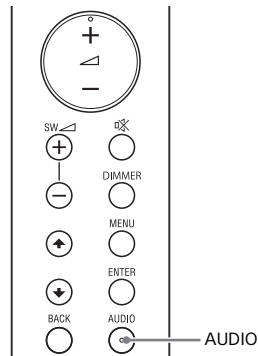

1 Appuyez plusieurs fois sur AUDIO pour sélectionner le signal audio souhaité.

Affichage du panneau avant	Fonction
[MAIN]	Le son de la langue principale est émis.
[SUB]	Le son de la langue secondaire est émis.
[M/S]	Un mélange des langues principale et secondaire est émis.

Remarques

- Pour recevoir un signal Dolby Digital, vous devez raccorder le téléviseur compatible avec eARC ou ARC (page 35) à la prise HDMI OUT (TV eARC/ARC) à l'aide du câble HDMI (fourni) ou d'autres appareils à la prise HDMI IN à l'aide d'un câble HDMI (non fourni).

- Si la prise HDMI IN de votre téléviseur n'est pas compatible avec eARC ou ARC (page 35), raccordez le téléviseur à la prise TV IN (OPT) à l'aide d'un câble numérique optique (non fourni) pour recevoir un signal Dolby Digital.
- AUDIO ne fonctionne pas pendant la connexion d'un téléviseur ou d'un autre appareil au système avec la fonction BLUETOOTH.

Écoute de la musique/du son avec la fonction BLUETOOTH®

Vous pouvez écouter de la musique en connectant le système et l'appareil mobile avec la fonction BLUETOOTH.

Écoute de la musique en jumelant l'appareil mobile connecté pour la première fois

Pour utiliser la fonction BLUETOOTH, vous devez effectuer au préalable le jumelage du système et de l'appareil mobile.

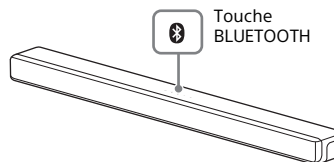

- 1 Maintenez enfoncée la touche BLUETOOTH de la barre de haut-parleurs pendant 2 secondes.**

Le système passe en mode de jumelage, [PAIRING] apparaît dans l'affichage du panneau avant et le témoin BLUETOOTH clignote deux fois à plusieurs reprises.

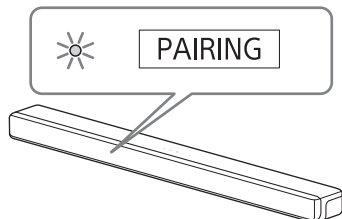

2 Sur l'appareil mobile, recherchez le système en effectuant l'opération de jumelage.

La liste d'appareils BLUETOOTH recherchés apparaît à l'écran de l'appareil mobile.

Pour la méthode de jumelage de l'appareil BLUETOOTH à l'appareil mobile, reportez-vous au manuel d'instructions de l'appareil mobile.

3 Jumelez le système et l'appareil mobile en sélectionnant « HT-G700 » dans la liste à l'écran de l'appareil mobile.

Si un code est demandé, entrez « 0000 ».

4 Assurez-vous que le témoin BLUETOOTH de la barre de haut-parleurs s'allume en bleu.

Une connexion est établie entre le système et l'appareil mobile.

5 Démarrez la lecture audio avec l'application musicale sur l'appareil mobile connecté.

Le son est émis par le système.

6 Réglez le volume (page 26).

Pour vérifier l'état de connexion de la fonction BLUETOOTH

État	Témoin BLUETOOTH
Pendant l'état de veille de jumelage	Clignote deux fois en bleu à plusieurs reprises
Tentative de connexion en cours	Clignote lentement en bleu à plusieurs reprises
Connexion établie	S'allume en bleu

Remarque

Vous pouvez jumeler le nombre suivant d'appareils BLUETOOTH.

- Appareils mobiles : 9
- Téléviseur Sony avec la fonction BLUETOOTH : 1

Si un nouvel appareil est jumelé après le jumelage du nombre d'appareils ci-dessus, l'appareil connecté le moins récemment est remplacé par le nouveau.

Conseils

- Si aucun appareil mobile n'a été jumelé (par exemple, immédiatement après l'achat du système), le système passe en mode de jumelage simplement en changeant l'entrée à l'entrée BT.
- Effectuez le jumelage pour le deuxième appareil mobile et les suivants.

Écoute de la musique à partir de l'appareil jumelé

- Éteignez le système ou l'appareil mobile.

Conseil

Lorsque la connexion n'est pas établie, sélectionnez « HT-G700 » sur l'appareil mobile.

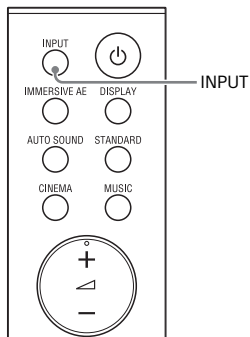

1 Activez la fonction **BLUETOOTH** de l'appareil mobile.

2 Appuyez plusieurs fois sur **INPUT** pour sélectionner **[BT]**.

Le système se reconnecte automatiquement à l'appareil mobile auquel il était connecté le plus récemment.

3 Assurez-vous que le témoin **BLUETOOTH** de la barre de haut-parleurs s'allume en bleu.

Une connexion est établie entre le système et l'appareil mobile.

4 Démarrez la lecture audio avec l'application musicale sur l'appareil mobile connecté.

Le son est émis par le système.

5 Réglez le volume (page 26).

Pour déconnecter l'appareil mobile

Effectuez l'une des actions suivantes.

- Désactivez la fonction **BLUETOOTH** de l'appareil mobile.
- Réglez **[BT]** - **[POWER]** à **[OFF]** (page 40).

Réglage de la qualité sonore

Apprécier une expérience ambiophonique immersive (IMMERSIVE AE)

Vous pouvez vous sentir immergé par le son restitué non seulement à l'horizontale, mais également depuis le haut en utilisant le Moteur ambiophonique vertical* efficacement pour les modes sonores (page 31). Cette fonction peut également fonctionner pour les signaux 2.0 canaux comme ceux des émissions de télévision.

* Le Moteur ambiophonique vertical propose une technologie de traitement de champ acoustique numérique de haute précision développée par Sony, qui produit virtuellement un champ acoustique dans le sens de la hauteur en plus d'un champ acoustique dans le sens horizontal en utilisant uniquement les enceintes avant, sans nécessiter d'enceintes supérieures.

Vous n'avez pas à installer d'enceintes au plafond pour apprécier un son avec une présence riche, indépendamment de la hauteur du plafond. En plus de permettre une écoute ambiophonique améliorée, cette fonction est très peu affectée par la forme de la pièce, car elle n'utilise pas le son réflétié par les murs.

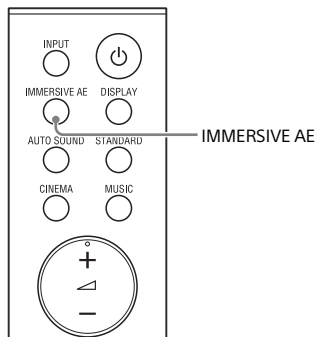

1 Appuyez sur IMMERSIVE AE pour activer ou désactiver la fonction.

Affichage du panneau avant	Fonction
----------------------------	----------

[IAE.ON]	Active la fonction ambiophonique verticale.
----------	---

[IAE.OFF]	Désactive la fonction ambiophonique verticale.
-----------	--

Remarques

- L'effet ambiophonique provenant de toutes les directions varie selon la source sonore.
- Un décalage peut se produire entre le son et l'image selon la source sonore. Si votre téléviseur est muni d'une fonction permettant de retarder l'image, utilisez-la pour effectuer l'ajustement.
- La fonction IMMERSIVE AE est disponible uniquement lorsque le réglage [AUDIO] - [EFFECT] est réglé à [SOUND MODE ON] (page 38).

Réglage de l'effet sonore adapté aux sources sonores (Mode sonore)

Vous pouvez facilement profiter des effets sonores préprogrammés adaptés à différents types de sources sonores.

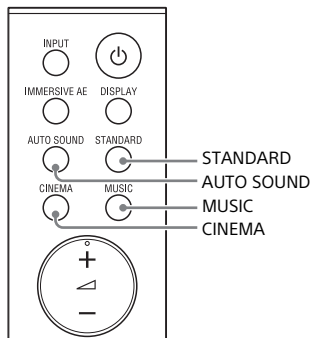

- 1** Appuyez sur l'une des touches de sélection de mode sonore (AUTO SOUND, STANDARD, CINEMA, MUSIC) pour sélectionner le mode sonore.

Touche	Fonction
AUTO SOUND	[AUTO SOUND] apparaît dans l'affichage du panneau avant. Le réglage de mode sonore approprié est automatiquement sélectionné parmi STANDARD, CINEMA ou MUSIC.
STANDARD	[STANDARD] apparaît dans l'affichage du panneau avant. Le son d'une émission de télévision est clairement audible.

Touche	Fonction
CINEMA	[CINEMA] apparaît dans l'affichage du panneau avant. Vous vous sentez immergé par le son qui voyage derrière vous et entoure tout votre corps. Ce mode est approprié pour le visionnement de films.
MUSIC	[MUSIC] apparaît dans l'affichage du panneau avant. La vivacité et la brillance sonores sont exprimées en détail. Ce mode est approprié pour l'écoute de la musique de manière à favoriser les mouvements.

Remarques

- La fonction de mode sonore est désactivée lorsque le réglage [AUDIO] - [EFFECT] est défini à un réglage autre que [SOUND MODE ON] (page 38).
- Un décalage peut se produire entre le son et l'image selon la source sonore. Si votre téléviseur est muni d'une fonction permettant de retarder l'image, utilisez-la pour effectuer l'ajustement.

Améliorer la clarté des dialogues (VOICE)

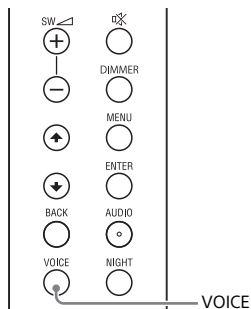

- 1 Appuyez sur **VOICE** pour activer ou désactiver la fonction.

Affichage du panneau avant	Fonction
[Vo.ON]	Les dialogues sont facilement audibles grâce à l'amélioration de la plage de dialogue.
[Vo.OFF]	Désactive la fonction de mode voix.

Apprécier un son clair avec un volume faible pendant la nuit (NIGHT)

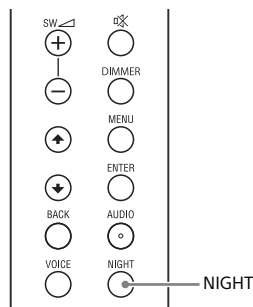

- 1 Appuyez sur **NIGHT** pour activer ou désactiver la fonction.

Affichage du panneau avant	Fonction
[N.ON]	Émet le son à un volume faible avec une perte minimale de fidélité et de clarté des dialogues.
[N.OFF]	Désactive la fonction de mode nuit.

Remarque

Lorsque vous éteignez le système, ce réglage passe automatiquement à [N.OFF].

Vérifier les réglages sonores actuels (DISPLAY)

(page 32) → Informations de diffusion
Le réglage actuel change dans l'ordre inverse lorsque vous appuyez sur **↕**.

Vous pouvez vérifier les réglages actuels du mode sonore, de la fonction IMMERSIVE AE, du mode voix, du mode nuit et des informations de diffusion actuelles.

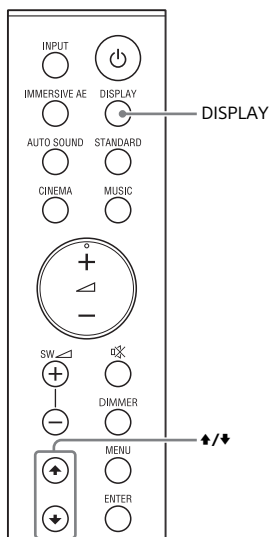

- 1 Appuyez sur DISPLAY.**
Le réglage actuel apparaît dans l'affichage du panneau avant.
- 2 Appuyez plusieurs fois sur **↕** pour sélectionner l'option souhaitée.**
Le réglage actuel affiché change dans l'ordre suivant.
Mode sonore (page 31) → IMMERSIVE AE (page 30) → Mode voix (page 32) → Mode nuit

Utilisation de la fonction Contrôle pour HDMI

Utilisation de la fonction Contrôle pour HDMI

Le raccordement d'un appareil tel qu'un téléviseur ou lecteur Blu-ray Disc compatible avec la fonction Contrôle pour HDMI* à l'aide d'un câble HDMI vous permet de contrôler facilement l'appareil en utilisant une télécommande de téléviseur. Les fonctions suivantes peuvent être utilisées avec la fonction Contrôle pour HDMI.

- Fonction de mise en arrêt du système
- Fonction de contrôle audio du système
- eARC/ARC (Enhanced Audio Return Channel/Audio Return Channel)
- Fonction de lecture à l'aide d'une touche
- Réglage d'économie d'énergie HDMI Standby Through

Remarque

Ces fonctions pourraient fonctionner avec des appareils autres que ceux fabriqués par Sony, mais le fonctionnement n'est pas garanti.

* Contrôle pour HDMI est une norme utilisée par CEC (Consumer Electronics Control) pour permettre aux appareils HDMI (High-Definition Multimedia Interface) de se contrôler entre eux.

Préparation pour l'utilisation de la fonction Contrôle pour HDMI

Réglez [HDMI] - [CONTROL FOR HDMI] à [ON] (page 39). Le réglage par défaut est [ON].

Activez les réglages de fonction Contrôle pour HDMI pour le téléviseur et l'autre appareil raccordé au système.

Conseil

Si vous activez la fonction Contrôle pour HDMI (« BRAVIA » Sync) pendant l'utilisation d'un téléviseur fabriqué par Sony, la fonction Contrôle pour HDMI du système est également activée automatiquement.

Fonction de mise en arrêt du système

Lorsque vous éteignez le téléviseur, le système s'éteint automatiquement.

Remarque

L'appareil raccordé pourrait ne pas s'éteindre, selon l'état de l'appareil.

Fonction de contrôle audio du système

Si vous mettez le système en marche pendant que vous regardez le téléviseur, le son du téléviseur sera émis par les enceintes du système. Le volume du système peut être réglé à l'aide de la télécommande du téléviseur.

Lorsque vous mettez le téléviseur en marche, le système s'allume automatiquement et le son du téléviseur est émis par les enceintes du système.

Les opérations peuvent également être effectuées à partir du menu du téléviseur. Pour plus de détails,

reportez-vous au manuel d'instructions du téléviseur.

Remarques

- Les chiffres indiquant le niveau de volume du système s'affichent à l'écran du téléviseur, selon le téléviseur. Les chiffres indiquant le volume sur le téléviseur peuvent être différents des chiffres indiqués sur l'affichage du panneau avant du système.
- Selon les réglages du téléviseur, la fonction de contrôle audio du système pourrait ne pas être disponible. Pour plus de détails, reportez-vous au manuel d'instructions du téléviseur.
- Selon le téléviseur, si le son du téléviseur était émis par les haut-parleurs du téléviseur la dernière fois que vous l'avez regardé, le système pourrait ne pas s'allumer par interverrouillage avec l'alimentation du téléviseur lorsque vous allumez le téléviseur.

eARC/ARC (Enhanced Audio Return Channel/Audio Return Channel)

Si le système est raccordé à une prise HDMI IN du téléviseur compatible avec eARC ou ARC, vous pouvez écouter le son du téléviseur à l'aide des enceintes du système sans raccorder de câble numérique optique.

Sur le système, réglez [HDMI] - [EARC] à [ON] (page 39). Le réglage par défaut est [ON].

Remarques

- Activez la fonction eARC ou ARC du téléviseur. Pour plus de détails, reportez-vous au manuel d'instructions du téléviseur.
- Si le téléviseur n'est pas compatible avec eARC ou ARC, un câble numérique optique (non fourni) doit être raccordé (reportez-vous au Manuel de démarrage fourni).

Fonction de lecture à l'aide d'une touche

Lors de la lecture d'un contenu sur un appareil (lecteur Blu-ray Disc, « PlayStation4 », etc.) raccordé au système, le système et le téléviseur s'allument automatiquement, l'entrée du système passe à l'entrée HDMI et le son est émis par les enceintes du système.

Remarques

- Si [HDMI] - [STANDBY THROUGH] est réglé à [ON] ou [AUTO] et que le son du téléviseur était émis par les haut-parleurs du téléviseur la dernière fois que vous l'avez regardé, le système pourrait ne pas s'allumer; le son et l'image pourraient être émis par le téléviseur, même si le contenu de l'appareil est en cours de lecture (page 39).
- Selon le téléviseur, le début du contenu en cours de lecture pourrait ne pas s'afficher correctement.

Réglage d'économie d'énergie HDMI Standby Through

HDMI Standby Through est une fonction vous permettant d'apprécier le son et l'image d'un appareil raccordé sans allumer le système.

Vous pouvez réduire la consommation en mode de veille du système en réglant [HDMI] - [STANDBY THROUGH] à [AUTO] (page 39). Le réglage par défaut est [AUTO].

Remarque

Si l'image d'un appareil raccordé au système ne s'affiche pas sur le téléviseur, réglez [HDMI] - [STANDBY THROUGH] à [ON]. Si vous raccordez un téléviseur qui n'est pas fabriqué par Sony, nous vous recommandons de sélectionner ce réglage.

Utilisation de la fonction « BRAVIA » Sync

En plus de la fonction Contrôle pour HDMI, vous pouvez également utiliser la fonction « BRAVIA » Sync, notamment le mode sonore/la fonction de sélection de scène.

Remarque

Cette fonction est une fonction exclusive de Sony. Cette fonction ne peut fonctionner qu'avec des produits fabriqués par Sony.

Sound mode/Fonction de sélection de scène

Le mode sonore du système est commuté automatiquement selon le réglage de la fonction de sélection de scène ou du mode sonore du téléviseur. Pour plus de détails, reportez-vous au manuel d'instructions du téléviseur. Réglez le mode sonore à [AUTO SOUND] (page 31).