

FCC PART 15C TEST REPORT FOR CERTIFICATION

On Behalf of

Sony Group Corporation

System Name: Sound Bar

Model No.: HT-SD40

Active Speaker System: SA-SD40

Active Subwoofer: SA-WSD40

EUT Name	EUT Model No.
Active Speaker System	SA-SD40

FCC ID: AK8SASD40

Prepared for : Sony Group Corporation

1-7-1 Konan Minato-ku Tokyo, 108-0075 Japan

Prepared By : Audix Technology (Shenzhen) Co., Ltd.

No. 6, Kefeng Road, Science & Technology Park,
Nanshan District , Shenzhen, Guangdong, China

Tel: (0755) 26639496

**TESTING****NVLAP LAB CODE 200372-0**

Report Number : ACS-F21279

Date of Test : Sep.15 ~ Oct.20, 2021

Date of Report : Oct.21, 2021

TABLE OF CONTENTS

Description	Page
1. SUMMARY OF STANDARDS AND RESULTS.....	5
1.1. Description of Standards and Results	5
2. GENERAL INFORMATION.....	6
2.1. Description of Equipment Under Test	6
2.2. Channel list of EUT	7
2.3. Tested Supporting System Details	8
2.4. Block Diagram of connection between EUT and simulators.....	8
2.5. Test information.....	8
2.6. Test Facility	9
2.7. Measurement Uncertainty (95% confidence levels, k=2).....	10
3. POWER LINE CONDUCTED EMISSION TEST	11
3.1. Test Equipments.....	11
3.2. Block Diagram of Test Setup.....	11
3.3. Power Line Conducted Emission Test Limits.....	11
3.4. Configuration of EUT on Test	12
3.5. Operating Condition of EUT.....	12
3.6. Test Procedure	12
3.7. Power Line Conducted Emission Test Results	12
4. RADIATED EMISSION MEASUREMENT	15
4.1. Test Equipment	15
4.2. Block Diagram of Test Setup.....	16
4.3. Radiated Emission Limit Standard:	17
4.4. EUT Configuration on Test	17
4.5. Operating Condition of EUT.....	17
4.6. Test Procedure	17
4.7. Radiated Emission Test Results.....	18
5. CONDUCTED SPURIOUS EMISSIONS	34
5.1. Test Equipment	34
5.2. Block Diagram of Test Setup.....	34
5.3. Limit.....	34
5.4. Test Procedure	34
5.5. Test result.....	34
6. 6dB & 99% BANDWIDTH TEST	37
6.1. Test Equipment	37
6.2. Limit.....	37
6.3. Test Procedure	37
6.4. Test Results.....	38
7. MAXIMUM PEAK OUTPUT POWER TEST.....	40
7.1. Test Equipment	40
7.2. Limit.....	40
7.3. Test Procedure	40
7.4. Test Results.....	40
8. BAND EDGE COMPLIANCE TEST	41
8.1. Test Equipment	41
8.2. Limit.....	41
8.3. Test Produce.....	41
8.4. Test Results	41

9.	POWER SPECTRAL DENSITY TEST.....	50
9.1.	Test Equipment	50
9.2.	Limit.....	50
9.3.	Test Procedure	50
9.4.	Test Results.....	50
10.	ANTENNA REQUIREMENT.....	52
10.1.	STANDARD APPLICABLE.....	52
10.2.	ANTENNA CONNECTED CONSTRUCTION.....	52
11.	DEVIATION TO TEST SPECIFICATIONS.....	53

Appendix A. Photograph of Test

Appendix B. Photo of the EUT

TEST REPORT

Applicant : Sony Group Corporation
 Manufacturer : Sony Group Corporation
 System Name : Sound Bar
 Model No. : HT-SD40
 Active Speaker System : SA-SD40
 Active Subwoofer : SA-WSD40
 FCC ID : AK8SASD40
 (A) EUT Name : Active Speaker System
 (B) EUT Model No. : SA-SD40
 (C) Test Voltage : AC 120V/60Hz

Tested for comply with:

FCC CFR47 Part 15 Subpart C
 Test procedure used: ANSI C63.10: 2013;
 KDB 558074 D01v05r01

The device described above is tested by AUDIX TECHNOLOGY (SHENZHEN) CO., LTD. to confirm comply with all the FCC Part 15 Subpart C requirements. The test results are contained in this test report and AUDIX TECHNOLOGY (SHENZHEN) CO., LTD. is assumed full responsibility for the accuracy and completeness of these tests. Also, this report shows that the Equipment Under Test (EUT) is to be technically compliant with the FCC requirements. This report contains data that are not covered by the NVLAP accreditation.

This Report is made under FCC Part 2.1074. No modifications were required during testing to bring this product into compliance.

This report applies to single evaluation of one sample of above mentioned product. And shall not be reproduced in part without written approval of Audix Technology (Shenzhen) Co., Ltd..

The report must not be used by the client to claim product certification, approval, or endorsement by NVLAP, NIST, or any agency of the federal government.

Date of Test : Sep.15 ~ Oct.20, 2021 Report of date: Oct.21, 2021

Prepared by : Brave Zhang Reviewed by : Sunny Lu
 Brave Zhang / Assistant Sunny Lu / Deputy Manager



Approved & Authorized Signer:

1. SUMMARY OF STANDARDS AND RESULTS

1.1. Description of Standards and Results

The EUT has been tested according to the applicable standards as referenced below.

EMISSION		
Description of Test Item	Standard	Results
Power Line Conducted Emission Test	FCC Part 15: 15.207 ANSI C63.10 :2013	PASS
Radiated Emission Test	FCC Part 15: 15.209 FCC Part 15: 15.205 FCC Part 15: 15.247(d) ANSI C63.10 : 2013	PASS
Conducted Spurious Emissions	FCC Part 15: 15.247(d) ANSI C63.10 : 2013	PASS
Carrier Frequency Separation Test	FCC Part 15: 15.247(a)(2) ANSI C63.10 : 2013	N/A
6dB & 99% Bandwidth Test	FCC Part 15: 15.247(b)(3) ANSI C63.10 : 2013	PASS
Maximum Peak Output Power Test	FCC Part 15: 15.247(d) ANSI C63.10 : 2013	PASS
Band Edge Compliance Test	FCC Part 15: 15.247(e) ANSI C63.10 : 2013	PASS
Power Spectral Density Test	FCC Part 15: 15.207 ANSI C63.10 :2013	PASS
Note: Measurement uncertainty affection to the result is considered, the EUT is technically compliant with standard requirements.		

2. GENERAL INFORMATION

2.1. Description of Equipment Under Test

Applicant	Sony Group Corporation
Applicant Address	1-7-1 Konan Minato-ku Tokyo, 108-0075 Japan
Manufacturer	Sony Group Corporation
Manufacturer Address	1-7-1 Konan Minato-ku Tokyo, 108-0075 Japan
System Name	Sound Bar
Model No.	HT-SD40
Active Speaker System	SA-SD40
Active Subwoofer	SA-WSD40
EUT Name	Active Speaker System
EUT Model No.	SA-SD40
FCC ID	AK8SASD40
Radio	General 2.4GHz wireless
Frequency Range	2404-2476MHz
Type of Modulation	GFSK
Channel Separation	2MHz
Remote Control	Manufacturer: Sony; Model: RMT-AH513U
Power Cable	Unshielded, Detachable, 1.5m (2 pins)
Optical Cable	Unshielded, Detachable, 1.5m
HDMI Cable	Shielded, Detachable, 1.5m (with two cores)
Hardware version	Bluetooth :1.01 2.4G SRD: V1
Software version	Bluetooth :B1.00 2.4G SRD: T1.01
Sample Type	Prototype production
Date of Receipt	Sep.13,2021
Date of Test	Sep.15 ~ Oct.20, 2021
The Product covered in this report is Active Speaker System; This product consists of Active Speaker System (SA-SD40) and Active Subwoofer (SA-WSD40).	

Antenna System	
Type of Antenna	PCB Antenna
Antenna Peak Gain	Sound Bar BT=2.1 dBi Subwoofer SRD=2.95 dBi Sound Bar SRD=4.23 dBi

2.2. Channel list of EUT

Channel list	Frequency	Channel list	Frequency
1	2404MHz	20	2442MHz
2	2406MHz	21	2444MHz
3	2408MHz	22	2446MHz
4	2410MHz	23	2448MHz
5	2412MHz	24	2450MHz
6	2414MHz	25	2452MHz
7	2416MHz	26	2454MHz
8	2418MHz	27	2456MHz
9	2420MHz	28	2458MHz
10	2422MHz	29	2460MHz
11	2424MHz	30	2462MHz
12	2426MHz	31	2464MHz
13	2428MHz	32	2466MHz
14	2430MHz	33	2468MHz
15	2432MHz	34	2470MHz
16	2434MHz	35	2472MHz
17	2436MHz	36	2474MHz
18	2438MHz	37	2476MHz
19	2440MHz	--	--

2.3. Tested Supporting System Details

No.	Description	ACS No.	Manufacturer	Model	Serial Number
1.	DVD Player	N/A	Pioneer	DV-310NC-K	MKTL011942CN
2.	LCD Monitor	N/A	Fujitsu	P27T-7 UHD	S26361-K1564-V140
3.	HDMI IN Cable: Shielded, Detachable, 1.5m. Optical Cable: Unshielded, Detachable, 1.5m.				

2.4. Block Diagram of connection between EUT and simulators

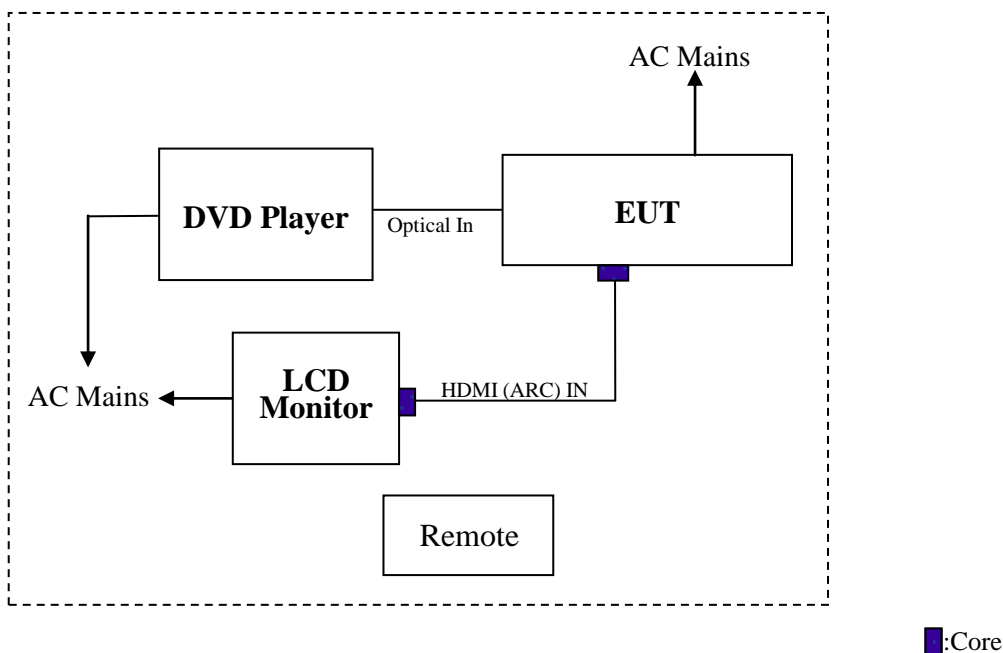

(EUT: Active Speaker System)

2.5. Test information

A Special Test Software(Syncomm Debug Tool v21.03.24) was used to control EUT work in Continuous TX mode(GFSK modulation), and select test channel.

Tested mode, channel, and Power setting information			
Mode	Channel	Power setting	Frequency (MHz)
Tx Mode GFSK modulation	Low :CH 1	RF Power=0x0F RF iCurrent=0xD9	2404
	Middle: CH19		2440
	High: CH37		2476

Remark: The radiated emission, power line conducted emission and bandedge compliance tested use the sample with serial number 000076, the conductive test items use the sample with serial number 000070.

2.6. Test Facility

Site Description

Name of Firm

Audix Technology (Shenzhen) Co., Ltd.
: No. 6, Kefeng Road, Science & Technology Park,
Nanshan District , Shenzhen, Guangdong, China

EMC Lab.

Certificated by ISED, Canada
: Company Number: 5183A
CAB identifier: CN0034
Valid Date: Mar.31, 2022

Certificated by FCC, USA
: Designation No.: CN5022
Valid Date: Mar.31, 2022

Accredited by NVLAP, USA
: NVLAP Code: 200372-0
Valid Date: Mar.31, 2022

2.7. Measurement Uncertainty (95% confidence levels, k=2)

Test Item	Uncertainty
Uncertainty for Conduction emission test in No. 1 Conduction	2.6dB(150kHz to 30MHz)
Uncertainty for Radiation Emission test in 3m chamber	3.2dB(30~200MHz, Polarization: H)
	3.6dB(30~200MHz, Polarization: V)
	3.4dB(200M~1GHz, Polarization: H)
	3.4dB(200M~1GHz, Polarization: V)
Uncertainty for Radiation Emission test in 3m chamber (1GHz~18GHz)	5.0dB(1GHz~6GHz)
	5.2dB(6GHz~18GHz)
Uncertainty for Conduction Spurious emission test	2.0dB
Uncertainty for Output power test	0.8dB
Uncertainty for Bandwidth test	83kHz
Uncertainty for DC power test	1.0%
Uncertainty for test site temperature and humidity	0.6°C
	3%

3. POWER LINE CONDUCTED EMISSION TEST

3.1. Test Equipments

Item	Equipment	Manufacturer	Model No.	Serial No.	Last Cal.	Cal. Interval
1.	1# Shielding Room	AUDIX	N/A	N/A	May.17,18	5 Year
2.	EMI Test Receiver	Rohde & Schwarz	ESCI	100842	Apr.07,21	1 Year
3.	L.I.S.N.#1	Rohde & Schwarz	ENV216	102160	Oct.11,20	1 Year
4.	L.I.S.N.#2	Kyoritsu	KNW-407	8-1636-1	Apr.06,21	1 Year
5.	Terminator	Hubersuhner	50Ω	No.1	Apr.06,21	1 Year
6.	Terminator	Hubersuhner	50Ω	No.2	Apr.06,21	1 Year
7.	RF Cable	EMCI	EMCCFD300-B M-NM-2000	190422	Apr.08,21	1 Year
8.	Test Software	AUDIX	e3	6.100913a	N/A	N/A

Note: N/A means Not applicable.

3.2. Block Diagram of Test Setup

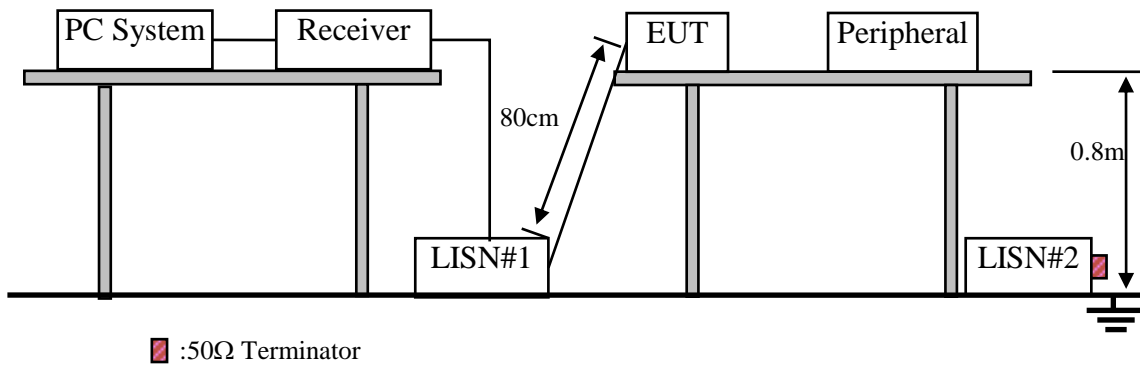

3.3. Power Line Conducted Emission Test Limits

Frequency	Maximum RF Line Voltage	
	Quasi-Peak Level dB(μV)	Average Level dB(μV)
150kHz ~ 500kHz	66 ~ 56*	56 ~ 46*
500kHz ~ 5MHz	56	46
5MHz ~ 30MHz	60	50

- Notes:
- * Decreasing linearly with logarithm of frequency.
 - The lower limit shall apply at the transition frequencies.
 - Emission Level (dBμV) = Factor (L.I.S.N.) (dB) + Cable Loss (dB) + Reading (Receiver) (dBμV)

3.4. Configuration of EUT on Test

The following equipment are installed on Power Line Conducted Emission Test to meet the commission requirement and operating regulations in a manner which tends to maximize its emission characteristics in a normal application.

3.4.1. Sound Bar (EUT)

Model Number : HT-SD40

Serial Number : N/A

3.4.2. Support Equipment: As Tested Supporting System Details, in Section 2.2.

3.5. Operating Condition of EUT

3.5.1. Setup the EUT and simulator as shown as Section 3.2.

3.5.2. Turn on the power of all equipments.

3.5.3. PC run test software to control EUT work in Tx mode.

3.6. Test Procedure

The EUT was placed on a non-metallic table, 80cm above the ground plane. The EUT Power Via AC unit connected to the power mains through a line impedance stabilization network (L.I.S.N. 1#). This provides a 50 ohm coupling impedance for the EUT (Please refer the block diagram of the test setup and photographs). The AC line are checked to find out the maximum conducted emission. In order to find the maximum emission levels, the relative positions of equipment and all of the interface cables shall be changed according to ANSI C63.10: 2013 on Conducted Emission Test.

The bandwidth of test receiver (R & S ESCI) is set at 9kHz.

The frequency range from 150kHz to 30MHz is checked.

3.7. Power Line Conducted Emission Test Results

PASS. (All emissions not reported below are too low against the prescribed limits.)

Data: 1 File: E:\1#CE\2021 Report Data\SONY\A1Z2108131-RF.EM6 (12) Date: 2021-10-08

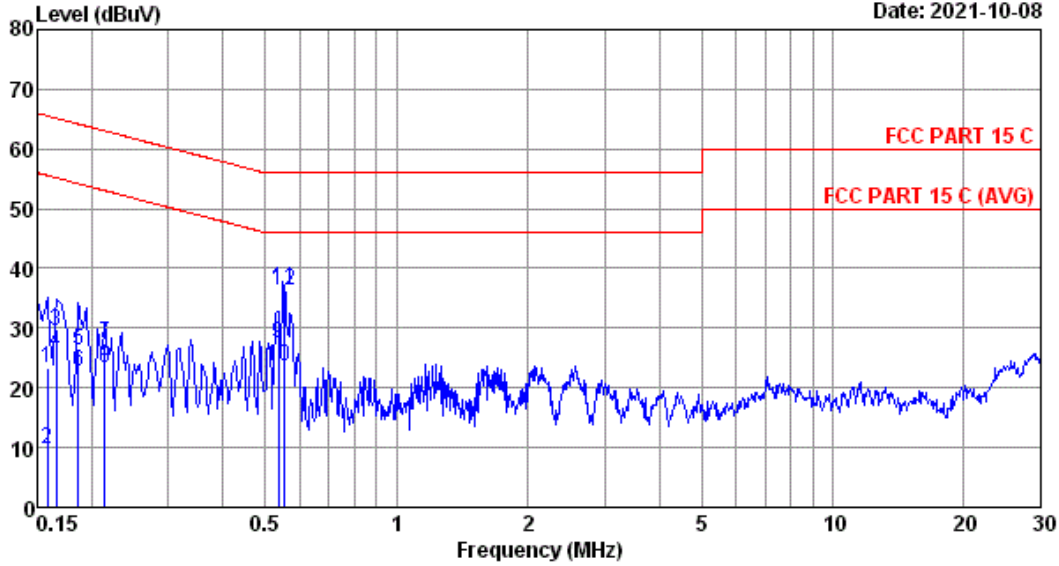

Site no :1# Conduction Data No :1
 Dis./Lisn :2020 ENV216-L LISN phase:
 Limit :FCC PART 15 C
 Env./Ins. :24.7°C/56% Engineer :Evan
 Power Rating :AC 120V/60Hz
 Test Mode :Soundbar:Generic 2.4G

No	Freq (MHz)	LISN Factor (dB)	Cable loss (dB)	Reading (dBUV)	Emission Level (dBUV)	Limits (dBUV)	Margin (dB)	Remark
1	0.158	9.70	0.01	13.50	23.21	65.56	42.35	QP
2	0.158	9.70	0.01	0.00	9.71	55.56	45.85	Average
3	0.166	9.70	0.01	19.70	29.41	65.16	35.75	QP
4	0.166	9.70	0.01	16.40	26.11	55.16	29.05	Average
5	0.186	9.70	0.01	16.50	26.21	64.20	37.99	QP
6	0.186	9.70	0.01	12.90	22.61	54.20	31.59	Average
7	0.214	9.70	0.01	17.80	27.51	63.05	35.54	QP
8	0.214	9.70	0.01	13.70	23.41	53.05	29.64	Average
9	0.535	9.70	0.01	17.60	27.31	56.00	28.69	QP
10	0.535	9.70	0.01	13.90	23.61	46.00	22.39	Average
11	0.550	9.70	0.01	27.00	36.71	56.00	19.29	QP
12	0.550	9.70	0.01	26.70	36.41	46.00	9.59	Average

Remarks: 1.Emission Level=LISN Factor+Cable Loss+Reading.
 2.If the average limit is met when using a quasi-peak detector, the EUT shall be deemed to meet both limits and measurement with average detector is unnecessary.

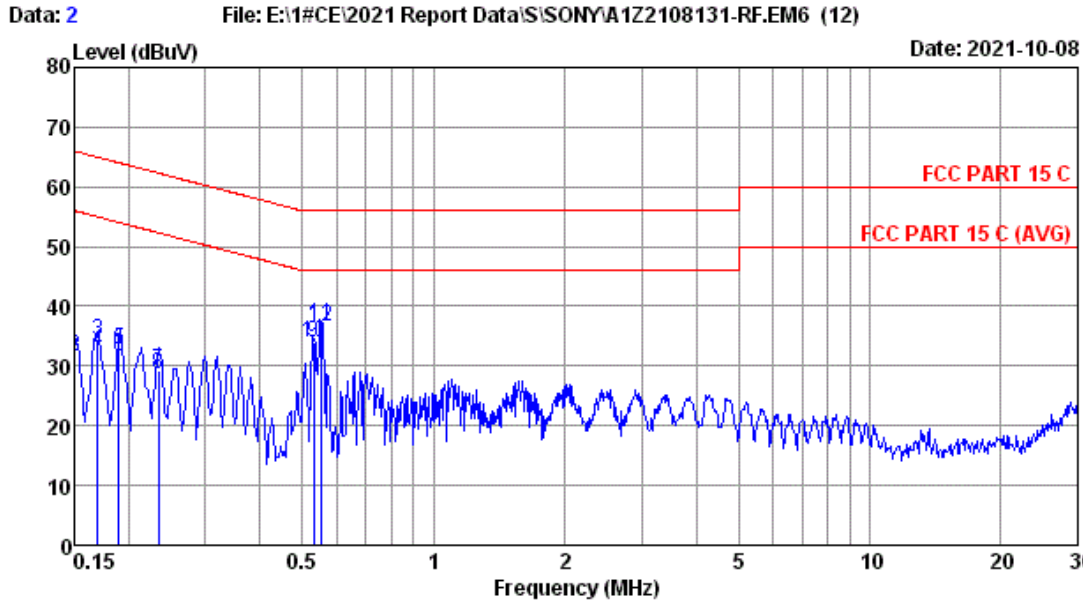

Site no :1# Conduction Data No :2
 Dis./Lisn :2020 ENV216-N LISN phase:
 Limit :FCC PART 15 C
 Env./Ins. :24.7°C/56% Engineer :Evan
 Power Rating :AC 120V/60Hz
 Test Mode :Soundbar:Generic 2.4G

No	Freq (MHz)	LISN Factor (dB)	Cable loss (dB)	Reading (dBuV)	Emission Level (dBuV)	Limits (dBuV)	Margin (dB)	Remark
1	0.150	9.70	0.01	25.10	34.81	66.00	31.19	QP
2	0.150	9.70	0.01	21.90	31.61	56.00	24.39	Average
3	0.170	9.70	0.01	24.60	34.31	64.96	30.65	QP
4	0.170	9.70	0.01	22.90	32.61	54.96	22.35	Average
5	0.190	9.70	0.01	23.20	32.91	64.04	31.13	QP
6	0.190	9.70	0.01	21.80	31.51	54.04	22.53	Average
7	0.234	9.70	0.01	19.60	29.31	62.31	33.00	QP
8	0.234	9.70	0.01	18.80	28.51	52.31	23.80	Average
9	0.530	9.70	0.01	24.30	34.01	56.00	21.99	QP
10	0.530	9.70	0.01	24.20	33.91	46.00	12.09	Average
11	0.550	9.70	0.01	27.20	36.91	56.00	19.09	QP
12	0.550	9.70	0.01	27.00	36.71	46.00	9.29	Average

Remarks: 1.Emission Level=LISN Factor+Cable Loss+Reading.
 2.If the average limit is met when using a quasi-peak detector.
 the EUT shall be deemed to meet both limits and measurement
 with average detector is unnecessary.

4. RADIATED EMISSION MEASUREMENT

4.1. Test Equipment

Frequency range: 30~1000MHz

Item	Equipment	Manufacturer	Model No.	Serial No.	Last Cal.	Cal. Interval
1.	3#Chamber(NSA)	AUDIX	N/A	N/A	May.02,21	1 Year
2.	3#Chamber(SE)	AUDIX	N/A	N/A	May.17,18	5 Year
3.	Signal Analyzer	Rohde & Schwarz	FSV30	104050	Apr.07,21	1 Year
4.	EMI Test Receiver	Rohde & Schwarz	ESR7	101547	Apr.07,21	1 Year
5.	Amplifier	HP	8447D	2648A04738	Apr.08,21	1 Year
6.	Bi log Antenna	TESEQ	CBL6112D	25237	Dec.22,20	1 Year
7.	NSA Cable	HUBER+SUHNER	CFD400NL-LW	No.3	Oct.11,20	1 Year
8.	Coaxial Switch	Anritsu	MP59B	6201397223	Apr.07,21	1 Year

Note: N/A means Not applicable.

Frequency range: above 1000MHz

Item	Equipment	Manufacturer	Model No.	Serial No.	Last Cal.	Cal. Interval
1.	3#Chamber(Svswr)	AUDIX	N/A	N/A	Apr.14,21	1 Year
2.	3#Chamber(SE)	AUDIX	N/A	N/A	May.17,18	5 Year
3.	Signal Analyzer	Rohde & Schwarz	FSV30	104050	Apr.07,21	1 Year
4.	Horn Antenna	ETC	MCTD 1209	DRH15F03006	Jul.26,21	1 Year
5.	Horn Antenna	ETS	3116	00060089	Dec.09,20	1 Year
6.	Amplifier	Agilent	83017A	MY53270084	Oct.11,20	1 Year
7.	Amplifier	Agilent	83017A	MY53270084	Oct.09,21	1 Year
8.	RF Cable	Hubersuhner	SUCOFLEX-106	505238/6	Apr.07,21	1 Year
9.	Test Software	AUDIX	e3	6.100913a	N/A	N/A

Note: N/A means Not applicable.

4.2. Block Diagram of Test Setup
For frequency range 30MHz-1000MHz

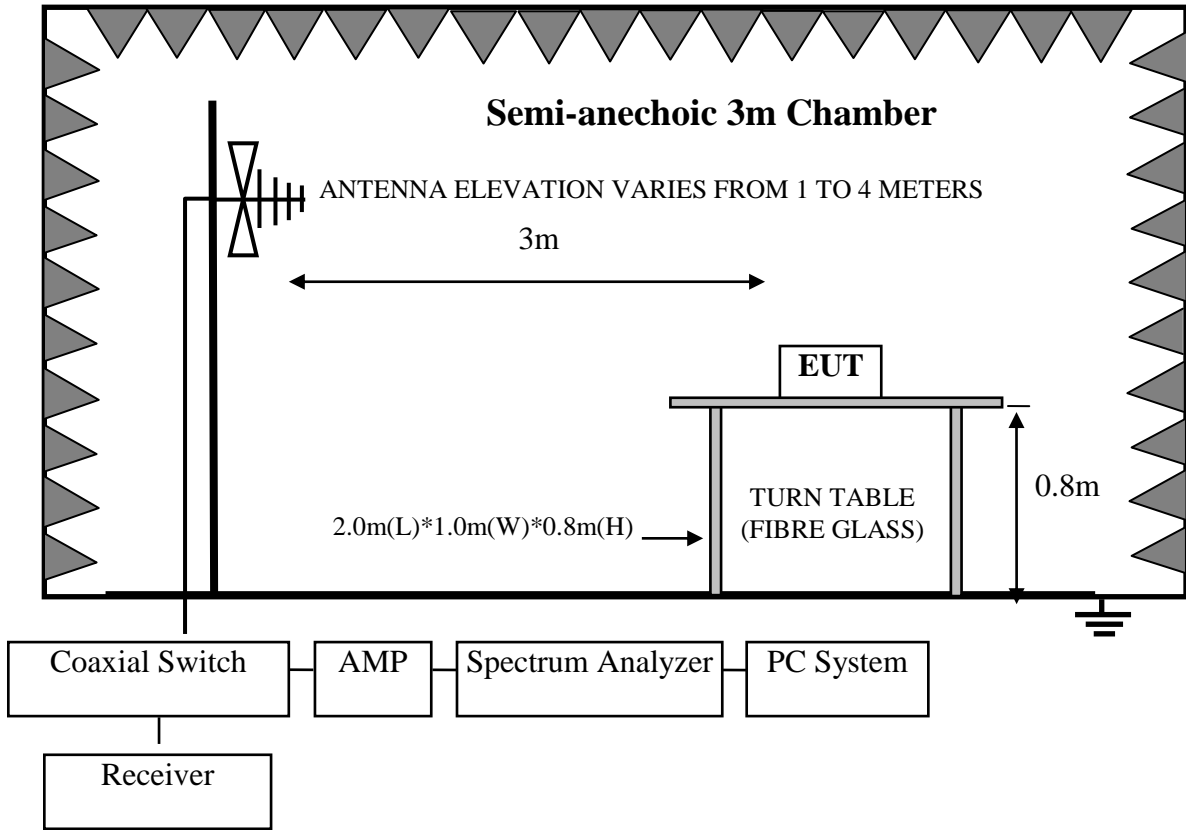

For frequency range 1GHz-25GHz

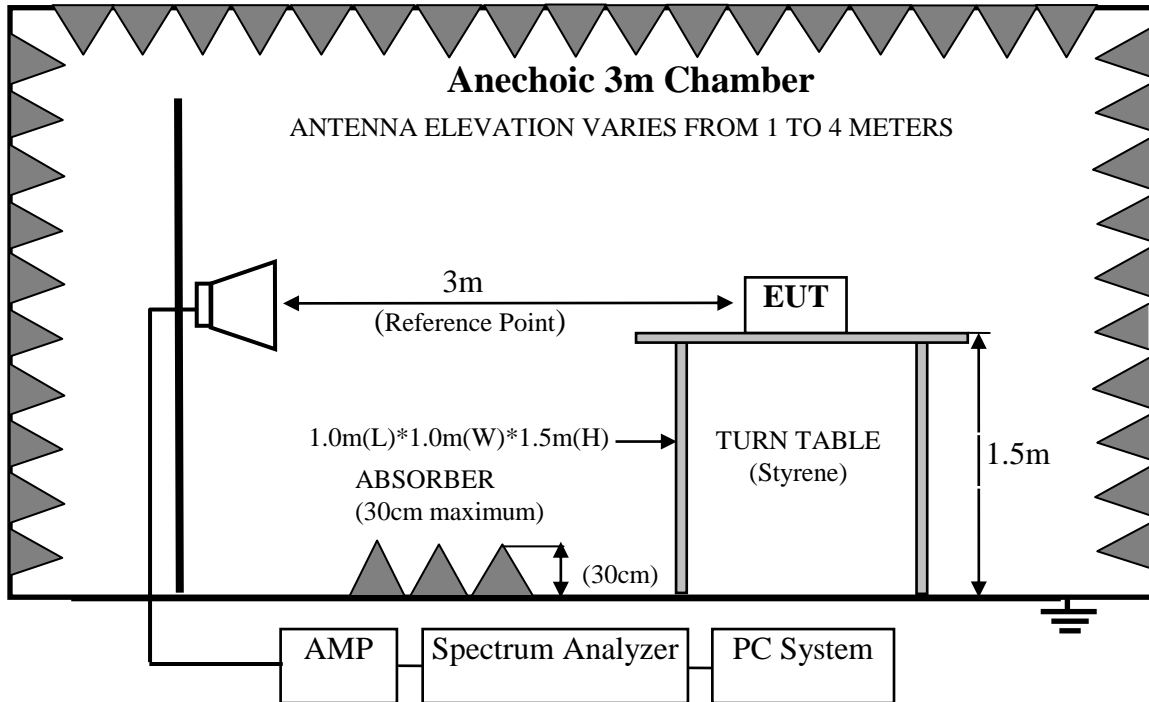

4.3. Radiated Emission Limit Standard:

FREQUENCY MHz	DISTANCE Meters	FIELD STRENGTHS LIMIT	
		μV/m	dB(μV)/m
30 ~ 88	3	100	40.0
88 ~ 216	3	150	43.5
216 ~ 960	3	200	46.0
960 ~ 1000	3	500	54.0
Above 1000MHz	3	74.0 dB(μV)/m (Peak) 54.0 dB(μV)/m (Average)	

- Remark :
- (1) Emission level dBμV = 20 log Emission level μV/m
 - (2) Emission Level (dBμV/m) = Reading (Receiver) (dBμV) + Antenna Factor (dB/m) + Cable Loss (dB)
Emission Level (dBμV/m) = Reading (Spectrum) (dBμV) + Antenna Factor (dB/m) – Amp Factor (dB) + Cable Loss (dB)(above 1000MHz)
 - (3) The smaller limit shall apply at the cross point between two frequency bands.
 - (4) Distance is the distance in meters between the measuring instrument, antenna and the closest point of any part of the device or system.
 - (5) The emission limits shown in the above table are based on measurements employing a CISPR quasi-peak detector except for the frequency bands 9-90 kHz, 110-490 kHz and above 1000 MHz. Radiated emission limits in these three bands are based on measurements employing an average detector.

4.4. EUT Configuration on Test

The following equipment are installed on Radiated Emission Test to meet the commission requirements and operating regulations in a manner which tends to maximize its emission characteristics in normal application.

4.4.1. Sound Bar (EUT)

Model Number : HT-SD40
Serial Number : N/A

4.5. Operating Condition of EUT

- 4.5.1. Setup the EUT and simulator as shown as Section 4.2.
- 4.5.2. Turn on the power of all equipments.
- 4.5.3. Let EUT work in Tx mode.

4.6. Test Procedure

Frequency below 30MHz:

The EUT setup on the turn table which has 0.8 m height to the ground. The turn table rotated 360 degrees and antenna fixed to 1 m to find the maximum emission level. In order to find the maximum emission, all of the interface cables were manipulated according to ANSI C63.10-2013 regulation.

EUT and its simulators are placed on a turn table, which is 0.8 meter high above ground for frequency 30MHz~1000MHz, 1.5 meter high above ground for frequency above 1GHz and put the absorbing with 2.4m(L)*2.4m(W)*0.3m(H) on the ground . The turn table can rotate 360 degrees to determine the position of the maximum emission level. Power on the EUT and let it working in test mode, then test it. EUT is set 3 meters away from the receiving antenna, which is mounted on a antenna tower. The antenna can be moved up and down between 1 meter and 4 meters to find out the maximum emission level. Broadband antenna (calibrated bilog antenna) is used as receiving antenna for frequency 30MHz~1000MHz, and the Horn antenna is used as receiving antenna for frequency above 1GHz. Both horizontal and vertical polarization of the

antenna is set on Test. In order to find the maximum emission levels, all of the interface cables must be manipulated according to ANSI C63.10-2013 on radiated emission Test.

This test was performed with EUT in X, Y, Z position, and the worse case was found when EUT in X position as the test photo indicated.

The bandwidth of the EMI test receiver (R&S ESR7) is set at 120kHz for frequency range from 30MHz to 1000 MHz.

The bandwidth of the Spectrum's RBW is set at 1MHz and VBW is set at 3MHz for peak emissions measurement above 1GHz.

The frequency range from 30MHz to 10th harmonic (25GHz) are checked. and no any emissions were found from 18GHz to 25 GHz, So the radiated emissions from 18GHz to 25GHz were not record.

4.7.Radiated Emission Test Results

PASS.

All the emissions from 30MHz to 25GHz were comply with the 15.209 Limit.

Duty cycle

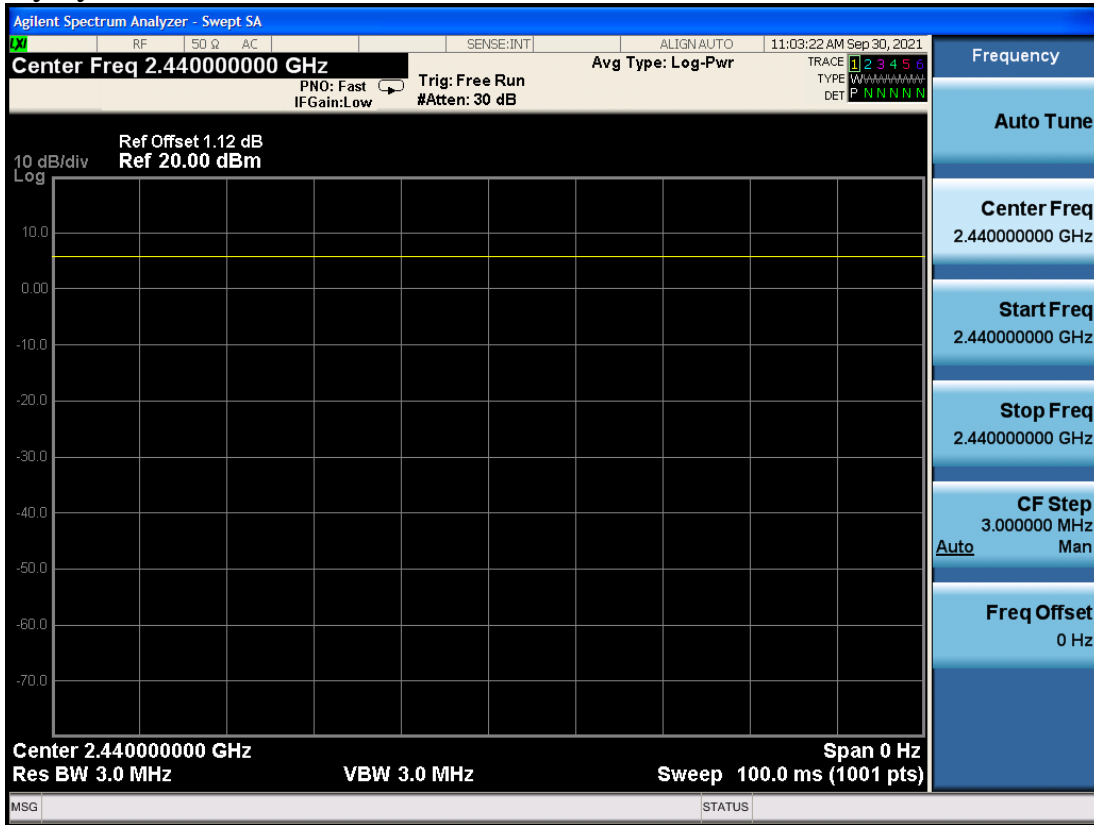

Note: The duty cycle of the test signal is 100%.

Frequency: 30MHz~1GHz

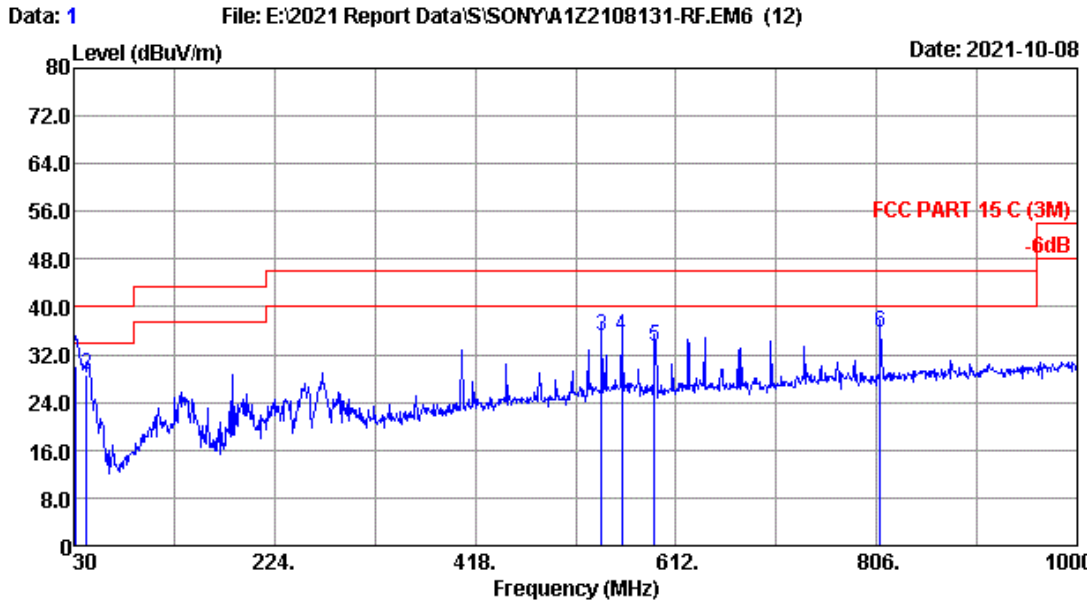

Site no. : 3m Chamber Data no. : 1
 Dis. / Ant. : 3m 2020 CBL6112D-25237 Ant. pol. : VERTICAL
 Limit : FCC PART 15 C (3M)
 Env. / Ins. : 23.5°C/52% Engineer : Jack
 Power rating : AC 120V/60Hz
 Test Mode : Soundbar: Generic 2.4G

No.	Freq. (MHz)	Ant. Factor (dB/m)	Cable Loss (dB)	Reading (dBuV)	Emission Level (dBuV/m)	Limits (dBuV/m)	Margin (dB)	Remark
1	30.872	24.26	0.64	5.20	30.10	40.00	9.90	QP
2	42.610	17.95	0.71	10.07	28.73	40.00	11.27	QP
3	540.220	24.39	2.43	8.24	35.06	46.00	10.94	QP
4	559.620	24.60	2.48	8.05	35.13	46.00	10.87	QP
5	591.630	24.29	2.55	6.65	33.49	46.00	12.51	QP
6	809.880	25.62	3.16	6.99	35.77	46.00	10.23	QP

Remarks: 1. Emission Level= Antenna Factor + Cable Loss + Reading.
 2. The emission levels that are 20dB below the official limit are not reported.

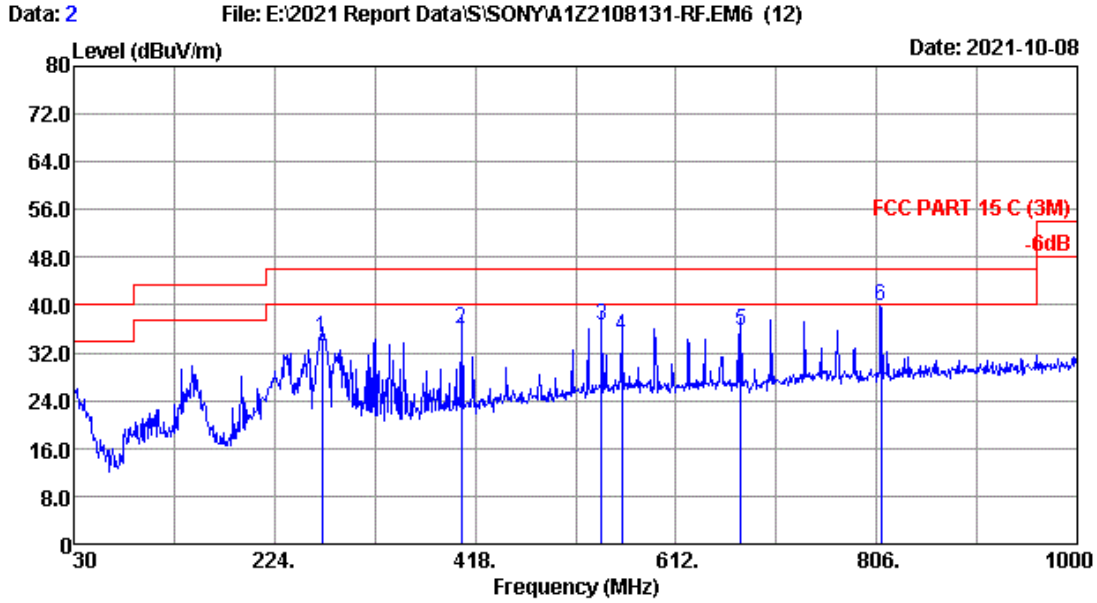

Site no. : 3m Chamber Data no. : 2
 Dis. / Ant. : 3m 2020 CBL6112D-25237 Ant. pol. : HORIZONTAL
 Limit : FCC PART 15 C (3M)
 Env. / Ins. : 23.5°C/52% Engineer : Jack
 Power rating : AC 120V/60Hz
 Test Mode : Soundbar: Generic 2.4G

No.	Freq. (MHz)	Ant. Factor (dB/m)	Cable Loss (dB)	Reading (dBuV)	Emission Level (dBuV/m)	Limits (dBuV/m)	Margin (dB)	Remark
1	269.590	18.54	1.64	14.26	34.44	46.00	11.56	QP
2	404.420	21.52	2.04	12.37	35.93	46.00	10.07	QP
3	540.220	24.39	2.43	9.76	36.58	46.00	9.42	QP
4	559.620	24.60	2.48	7.65	34.73	46.00	11.27	QP
5	675.050	24.70	2.74	8.34	35.78	46.00	10.22	QP
6	809.999	25.62	3.16	10.99	39.77	46.00	6.23	QP

Remarks: 1. Emission Level= Antenna Factor + Cable Loss + Reading.
 2. The emission levels that are 20dB below the official limit are not reported.

Frequency: 1GHz~18GHz

Data: 33

File: F:\2021 Report\SONYA1Z2108131-FCC.EM6 (92)

Date: 2021-10-06

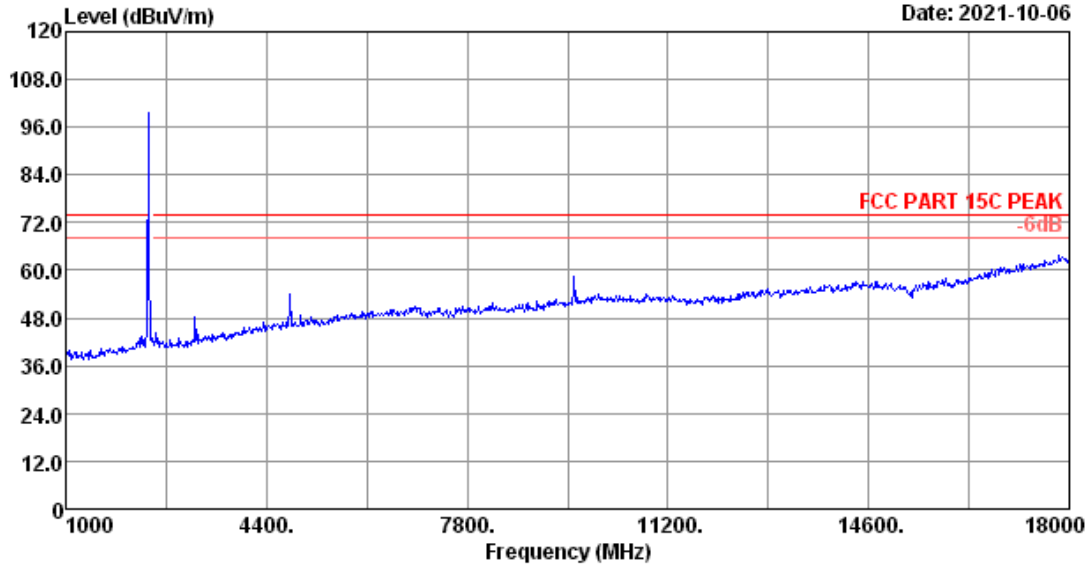

Site no.	: 3m Chamber	Data no.	: 33
Dis. / Ant.	: 3m 2021 MCTD1209-3006	Ant. pol.	: VERTICAL
Limit	: FCC PART 15C PEAK		
Env. / Ins.	: 23.8°C/53.5%	Engineer	: Winter
Power rating	: AC 120V/60Hz		
Test Mode	: Soundbar: SRD 2404MHz Tx		

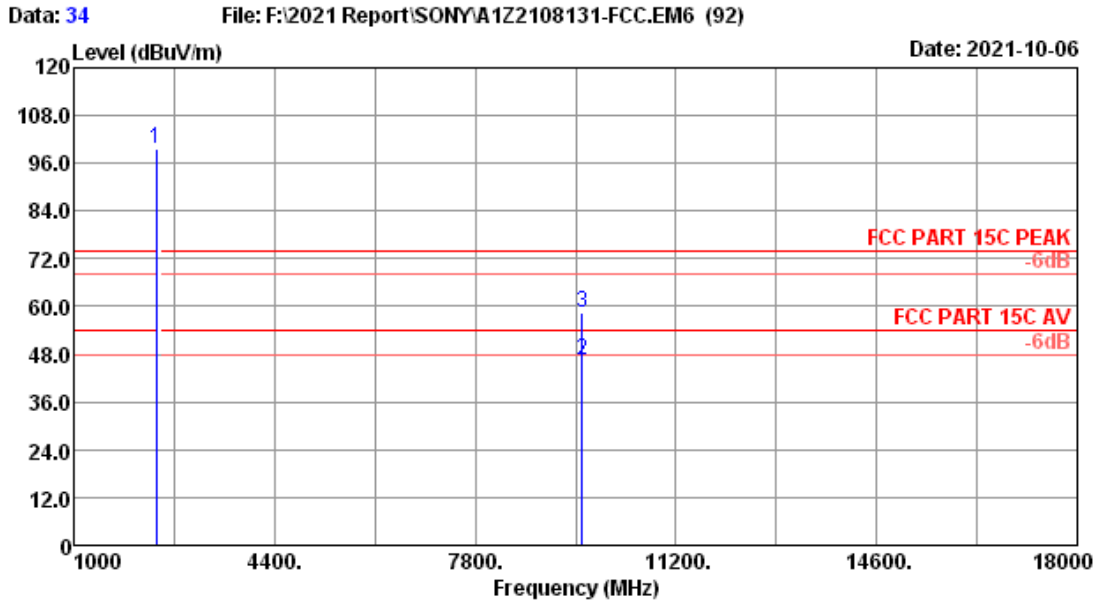

Site no. : 3m Chamber Data no. : 34
 Dis. / Ant. : 3m 2021 MCTD1209-3006 Ant. pol. : VERTICAL
 Limit : FCC PART 15C PEAK
 Env. / Ins. : 23.8°C/53.5% Engineer : Winter
 Power rating : AC 120V/60Hz
 Test Mode : Soundbar: SRD 2404MHz Tx

No.	Freq. (MHz)	Ant. Factor (dB/m)	Cable Loss (dB)	Reading (dBuV)	Amp factor (dB)	Emission Level (dBuV/m)	Limits (dBuV/m)	Margin (dB)	Remark
1	2404.00	27.93	1.66	105.14	35.24	99.49	-----	-----	Peak
2	9616.00	37.47	3.90	39.69	34.68	46.38	54.00	7.62	Average
3	9616.00	37.47	3.90	51.54	34.68	58.23	74.00	15.77	Peak

Remarks: 1. Emission Level= Antenna Factor + Cable Loss + Reading -Amp factor.
 2. The emission levels that are 20dB below the official limit are not reported.

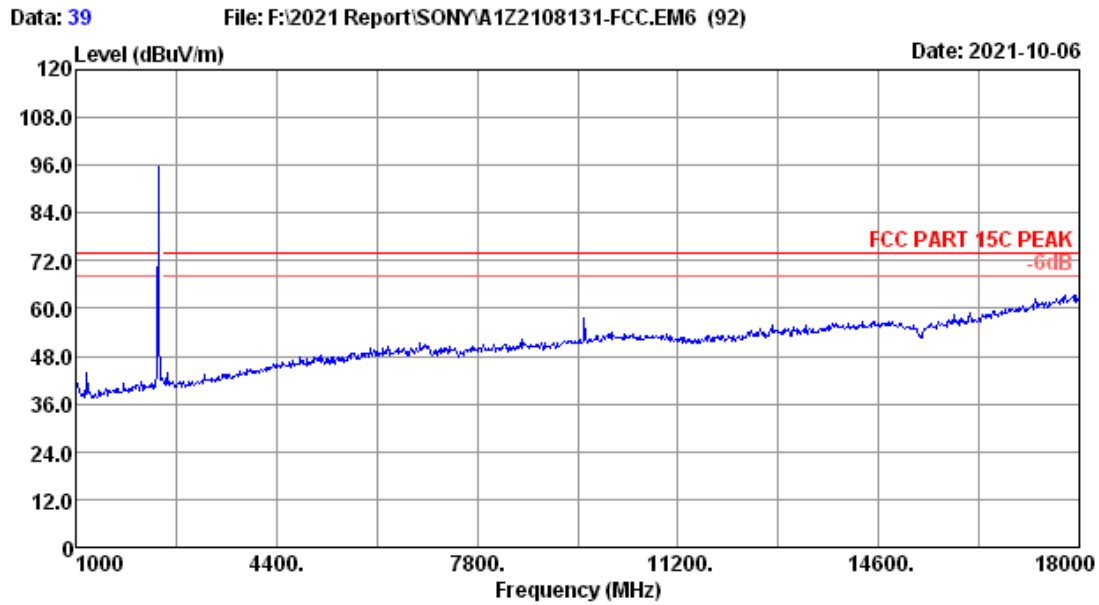

Site no.	: 3m Chamber	Data no.	: 39
Dis. / Ant.	: 3m 2021 MCTD1209-3006	Ant. pol.	: HORIZONTAL
Limit	: FCC PART 15C PEAK		
Env. / Ins.	: 23.8°C/53.5%	Engineer	: Winter
Power rating	: AC 120V/60Hz		
Test Mode	: Soundbar: SRD 2404MHz Tx		

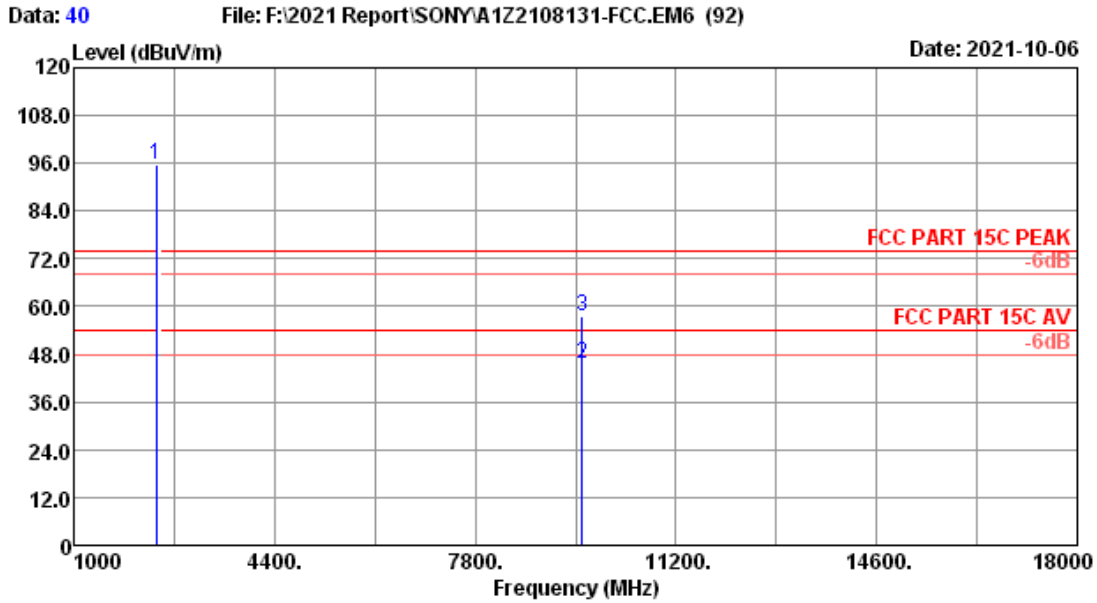

Site no. : 3m Chamber Data no. : 40
 Dis. / Ant. : 3m 2021 MCTD1209-3006 Ant. pol. : HORIZONTAL
 Limit : FCC PART 15C PEAK
 Env. / Ins. : 23.8°C/53.5% Engineer : Winter
 Power rating : AC 120V/60Hz
 Test Mode : Soundbar: SRD 2404MHz Tx

No.	Freq. (MHz)	Ant. Factor (dB/m)	Cable Loss (dB)	Reading (dBuV)	Amp factor (dB)	Emission Level (dBuV/m)	Limits (dBuV/m)	Margin (dB)	Remark
1	2404.00	27.93	1.66	101.20	35.24	95.55	-----	-----	Peak
2	9616.00	37.47	3.90	38.98	34.68	45.67	54.00	8.33	Average
3	9616.00	37.47	3.90	51.06	34.68	57.75	74.00	16.25	Peak

Remarks: 1. Emission Level= Antenna Factor + Cable Loss + Reading -Amp factor.
 2. The emission levels that are 20dB below the official limit are not reported.

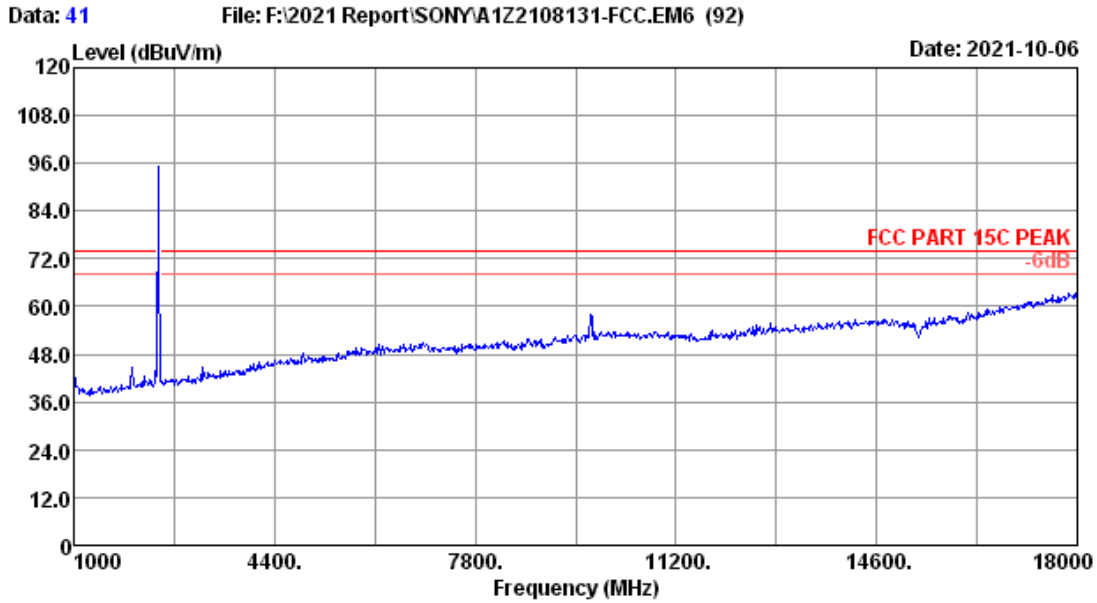

Site no.	: 3m Chamber	Data no.	: 41
Dis. / Ant.	: 3m 2021 MCTD1209-3006	Ant. pol.	: HORIZONTAL
Limit	: FCC PART 15C PEAK		
Env. / Ins.	: 23.8°C/53.5%	Engineer	: Winter
Power rating	: AC 120V/60Hz		
Test Mode	: Soundbar: SRD 2440MHz Tx		

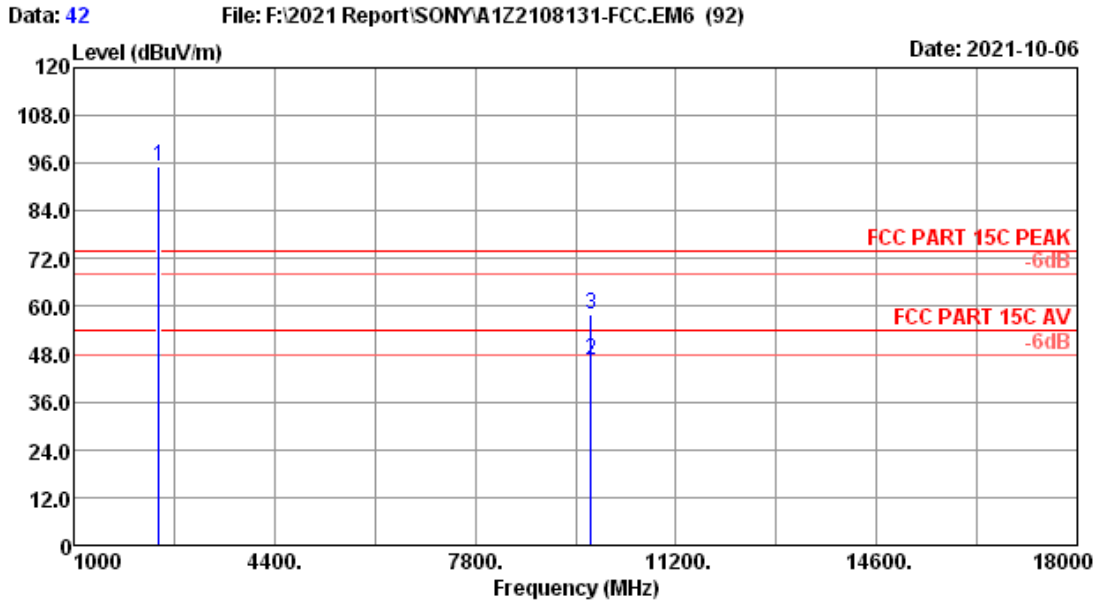

Site no. : 3m Chamber Data no. : 42
 Dis. / Ant. : 3m 2021 MCTD1209-3006 Ant. pol. : HORIZONTAL
 Limit : FCC PART 15C PEAK
 Env. / Ins. : 23.8°C/53.5% Engineer : Winter
 Power rating : AC 120V/60Hz
 Test Mode : Soundbar: SRD 2440MHz Tx

No.	Freq. (MHz)	Ant. Factor (dB/m)	Cable Loss (dB)	Reading (dBuV)	Amp factor (dB)	Emission Level (dBuV/m)	Limits (dBuV/m)	Margin (dB)	Remark
1	2440.00	28.00	1.68	100.82	35.24	95.26	-----	-----	Peak
2	9760.00	37.56	3.94	39.40	34.53	46.37	54.00	7.63	Average
3	9760.00	37.56	3.94	51.25	34.53	58.22	74.00	15.78	Peak

Remarks: 1. Emission Level= Antenna Factor + Cable Loss + Reading -Amp factor.
 2. The emission levels that are 20dB below the official limit are not reported.

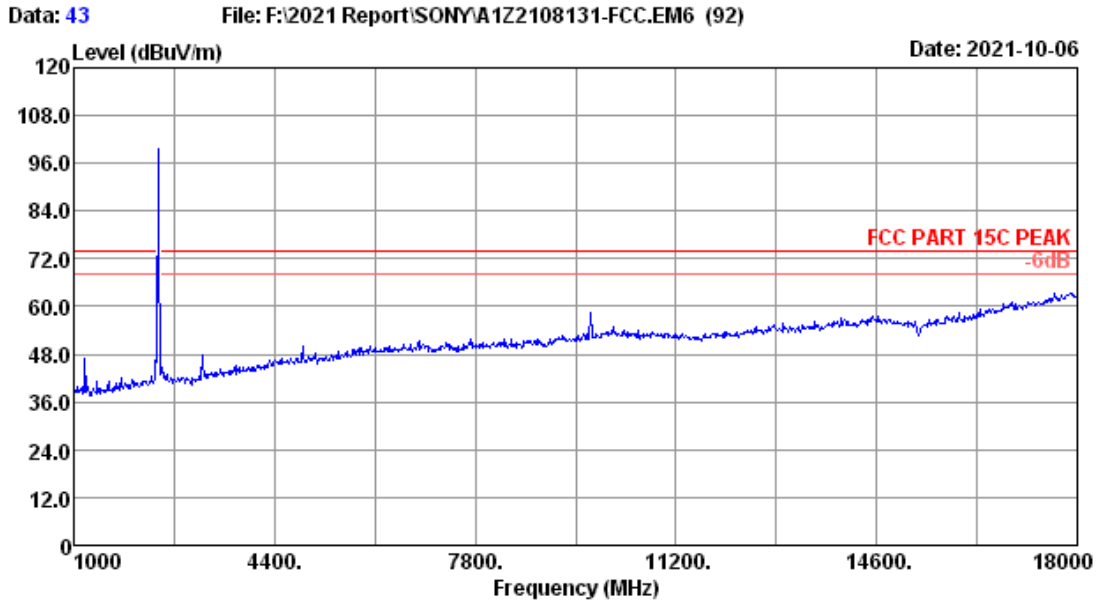

Site no.	: 3m Chamber	Data no.	: 43
Dis. / Ant.	: 3m 2021 MCTD1209-3006	Ant. pol.	: VERTICAL
Limit	: FCC PART 15C PEAK		
Env. / Ins.	: 23.8°C/53.5%	Engineer	: Winter
Power rating	: AC 120V/60Hz		
Test Mode	: Soundbar: SRD 2440MHz Tx		

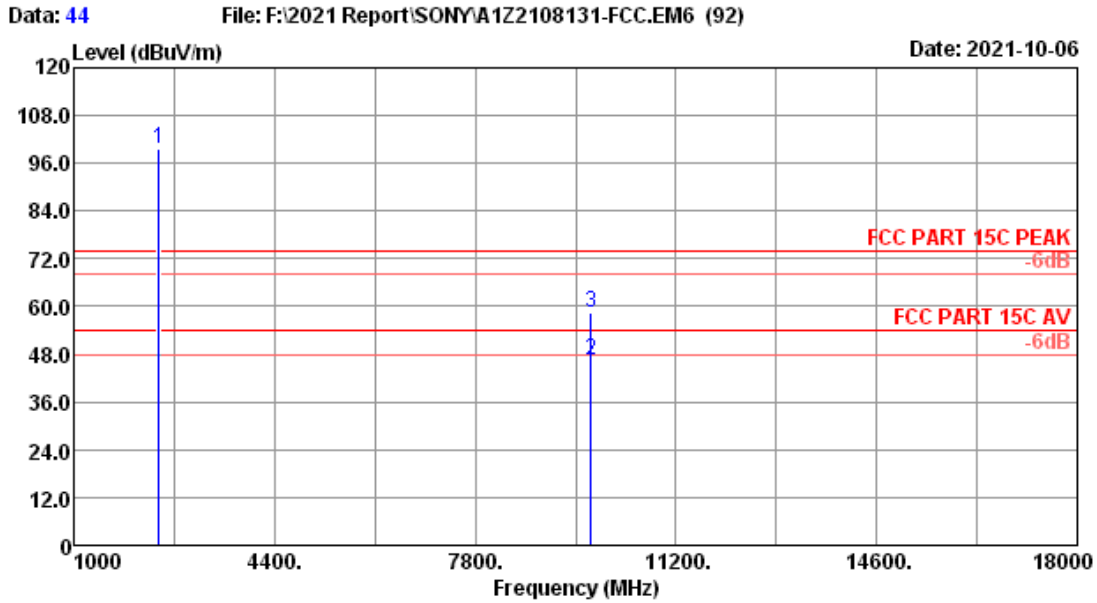

Site no. : 3m Chamber Data no. : 44
 Dis. / Ant. : 3m 2021 MCTD1209-3006 Ant. pol. : VERTICAL
 Limit : FCC PART 15C PEAK
 Env. / Ins. : 23.8°C/53.5% Engineer : Winter
 Power rating : AC 120V/60Hz
 Test Mode : Soundbar: SRD 2440MHz Tx

No.	Freq. (MHz)	Ant. Factor (dB/m)	Cable Loss (dB)	Reading (dBuV)	Amp factor (dB)	Emission Level (dBuV/m)	Limits (dBuV/m)	Margin (dB)	Remark
1	2440.00	28.00	1.68	105.07	35.24	99.51	-----	-----	Peak
2	9760.00	37.56	3.94	39.43	34.53	46.40	54.00	7.60	Average
3	9760.00	37.56	3.94	51.47	34.53	58.44	74.00	15.56	Peak

Remarks: 1. Emission Level= Antenna Factor + Cable Loss + Reading -Amp factor.
 2. The emission levels that are 20dB below the official limit are not reported.

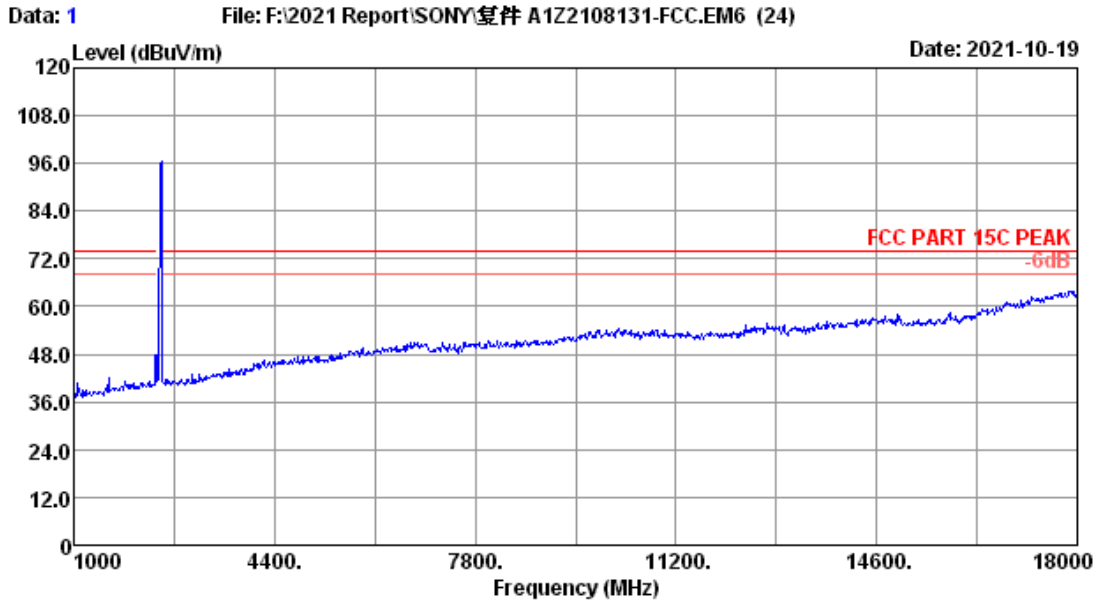

Site no.	: 3m Chamber	Data no.	: 1
Dis. / Ant.	: 3m 2021 MCTD1209-3006	Ant. pol.	: HORIZONTAL
Limit	: FCC PART 15C PEAK		
Env. / Ins.	: 23.8°C/53.5%	Engineer	: Winter
Test Mode	: Soundbar: SRD 2476MHz Tx		

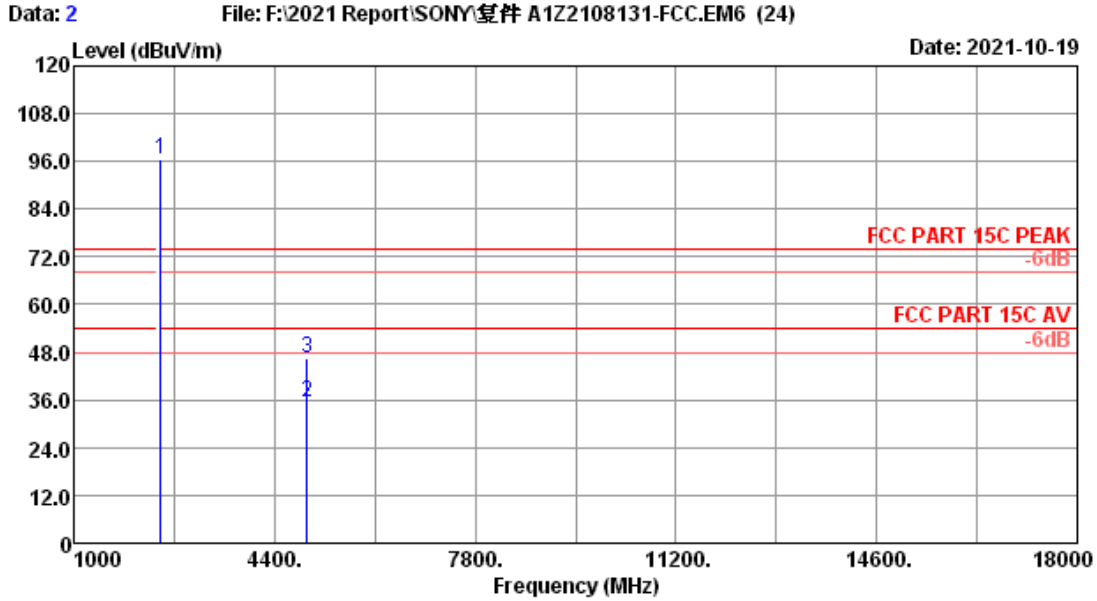

Site no. : 3m Chamber Data no. : 2
 Dis. / Ant. : 3m 2021 MCTD1209-3006 Ant. pol. : HORIZONTAL
 Limit : FCC PART 15C PEAK
 Env. / Ins. : 23.8°C/53.5% Engineer : Winter
 Test Mode : Soundbar: SRD 2476MHz Tx

No.	Freq. (MHz)	Ant. Factor (dB/m)	Cable Loss (dB)	Reading (dBuV)	Amp factor (dB)	Emission Level (dBuV/m)	Limits (dBuV/m)	Margin (dB)	Remark
1	2476.00	28.07	1.69	101.87	35.25	96.38	-----	-----	Peak
2	4952.00	32.77	2.73	34.29	34.49	35.30	54.00	18.70	Average
3	4952.00	32.77	2.73	45.49	34.49	46.50	74.00	27.50	Peak

Remarks: 1. Emission Level= Antenna Factor + Cable Loss + Reading -Amp factor.
 2. The emission levels that are 20dB below the official limit are not reported.

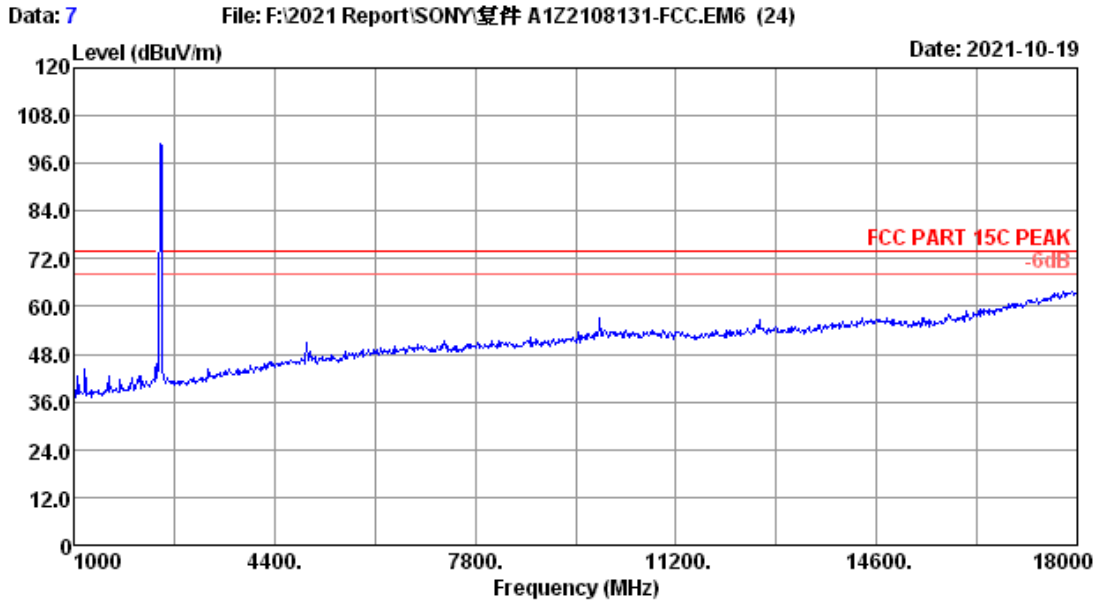

Site no.	: 3m Chamber	Data no.	: 7
Dis. / Ant.	: 3m 2021 MCTD1209-3006	Ant. pol.	: VERTICAL
Limit	: FCC PART 15C PEAK		
Env. / Ins.	: 23.8°C/53.5%	Engineer	: Winter
Test Mode	: Soundbar: SRD 2476MHz Tx		

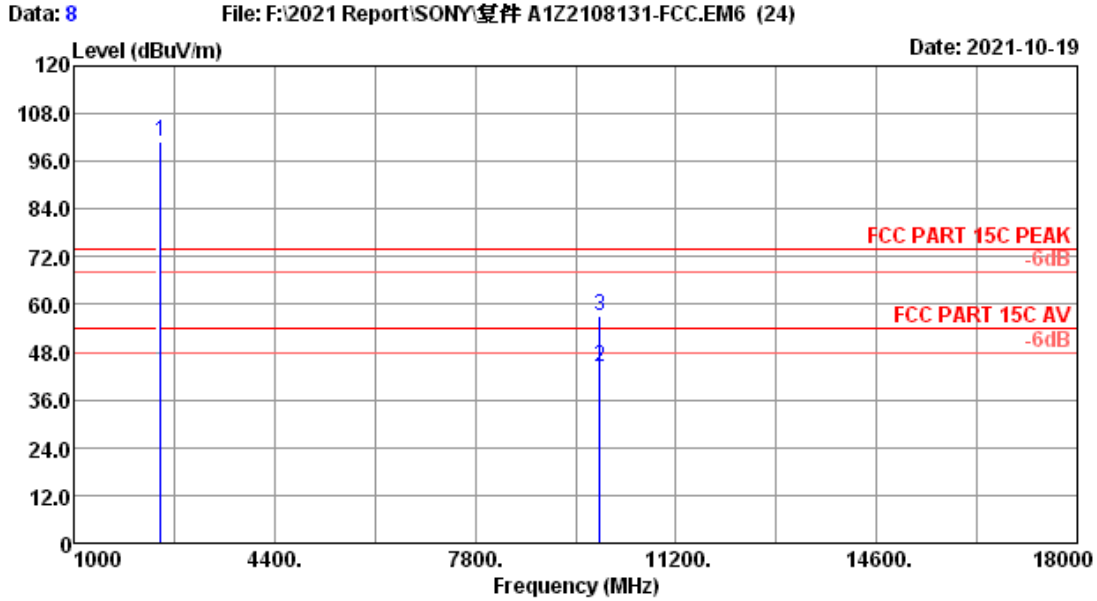

Site no. : 3m Chamber Data no. : 8
 Dis. / Ant. : 3m 2021 MCTD1209-3006 Ant. pol. : VERTICAL
 Limit : FCC PART 15C PEAK
 Env. / Ins. : 23.8°C/53.5% Engineer : Winter
 Test Mode : Soundbar: SRD 2476MHz Tx

No.	Freq. (MHz)	Ant. Factor (dB/m)	Cable Loss (dB)	Reading (dBuV)	Amp factor (dB)	Emission Level (dBuV/m)	Limits (dBuV/m)	Margin (dB)	Remark
1	2476.00	28.07	1.69	106.60	35.25	101.11	-----	-----	Peak
2	9904.00	37.65	3.98	37.20	34.40	44.43	54.00	9.57	Average
3	9904.00	37.65	3.98	49.95	34.40	57.18	74.00	16.82	Peak

Remarks: 1. Emission Level= Antenna Factor + Cable Loss + Reading -Amp factor.
 2. The emission levels that are 20dB below the official limit are not reported.

5. CONDUCTED SPURIOUS EMISSIONS

5.1. Test Equipment

Item	Equipment	Manufacturer	Model No.	Serial No.	Last Cal.	Cal. Interval
1.	PXA Signal Analyzer	Agilent	N9030A	MY51380221	Apr.07,21	1 Year
2.	Attenuator	Agilent	8491B	MY39269201	Oct.12,20	1 Year
3.	Attenuator	Agilent	8491B	MY39269201	Oct.09,21	1 Year
4.	RF Cable	Hubersuhner	SUCOFLEX-106	505238/6	Apr.07,21	1 Year

5.2. Block Diagram of Test Setup



5.3. Limit

In any 100kHz bandwidth outside the frequency bands in which the spread spectrum intentional radiator is operating, the radio frequency power that is produced by the intentional radiator shall be at least 20dB below that in the 100kHz bandwidth within the band that contains the highest level of the desired power.

5.4. Test Procedure

Use the test method described in ANSI C63.10:

The transmitter output was connected to a spectrum analyzer, The resolution bandwidth is set to 100 kHz, The video bandwidth is set to 300 kHz and measure all the emissions With peak detector.

5.5. Test result

PASS (The testing data was attached in the next pages.)

EUT: Active Speaker System		
M/N: SA-SD40		
Test date: 2021-09-27 ~ 10-19	Pressure: 102.1±1.0 kpa	Humidity: 53.2±3.0%
Tested by: Lynn	Test site: RF site	Temperature: 22.3±0.6°C

GFSK

2404MHz(30MHz-1GHz)

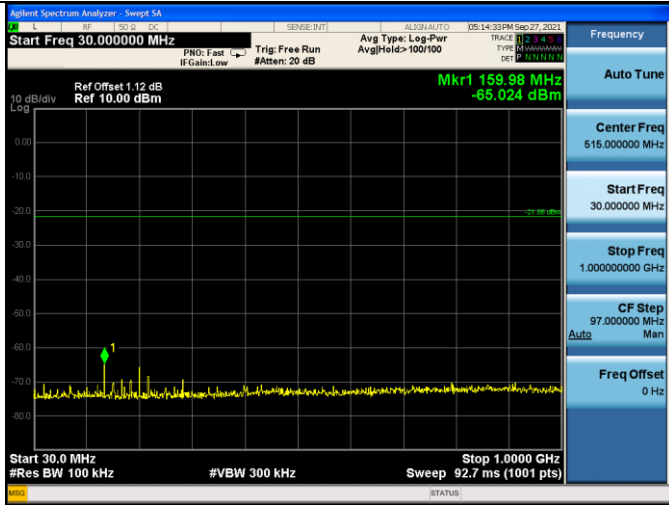

2404MHz(2.31GHz-2.405GHz)

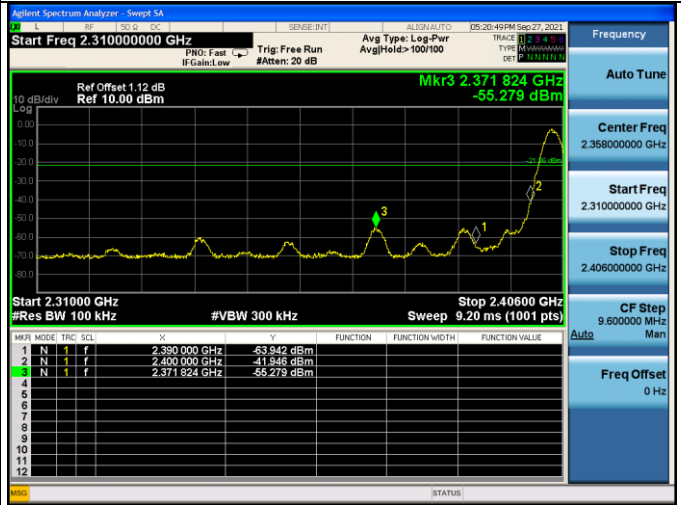

2404MHz(1GHz-10GHz)

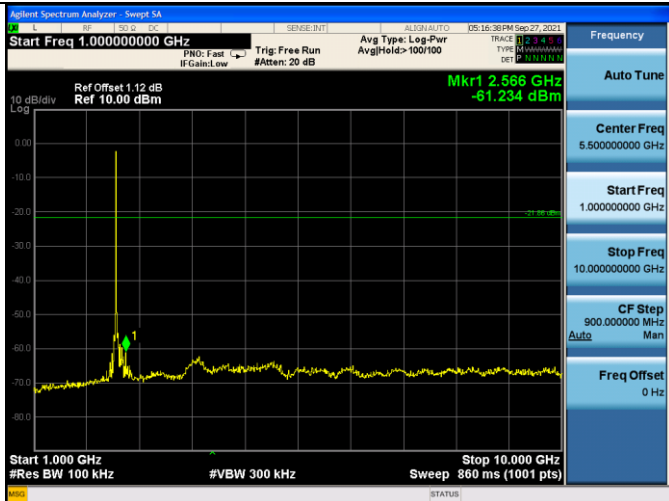

2440MHz(30MHz-1GHz)

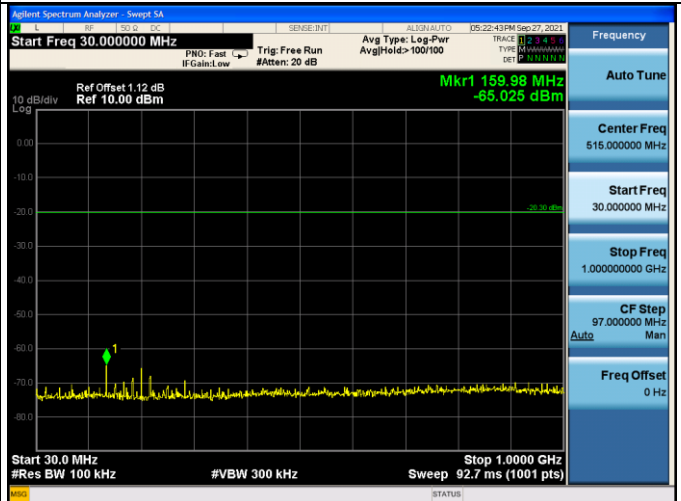

2404MHz(10GHz-26GHz)



2440MHz(1GHz-10GHz)

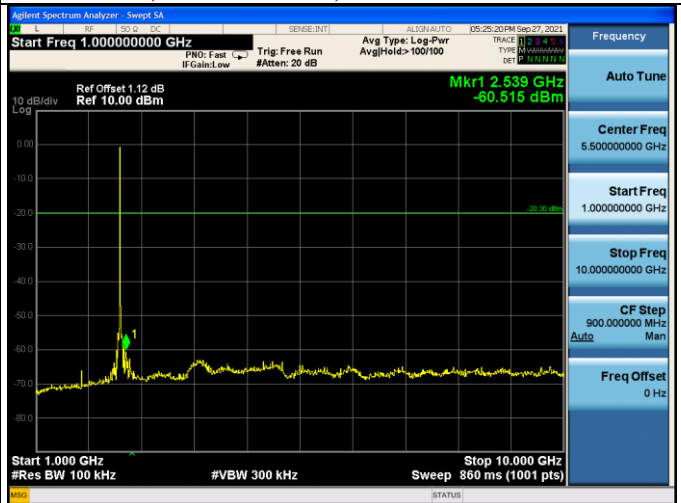

2440MHz(10GHz-26GHz)



2476MHz(10GHz-26GHz)



2476MHz(30MHz-1GHz)

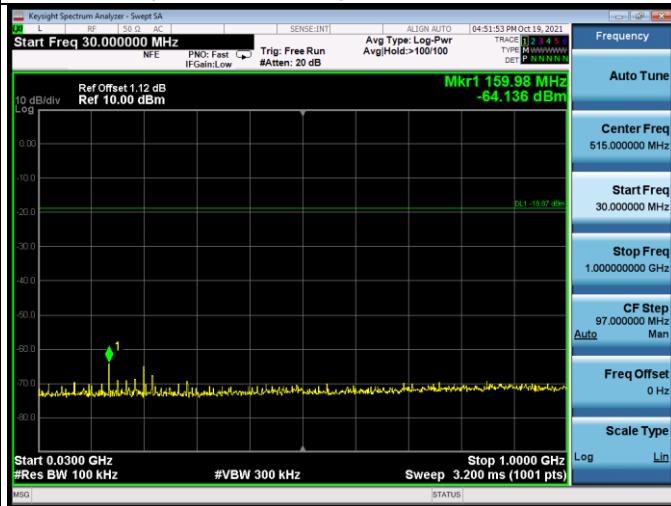

2476MHz(2.477GHz-2.51GHz)

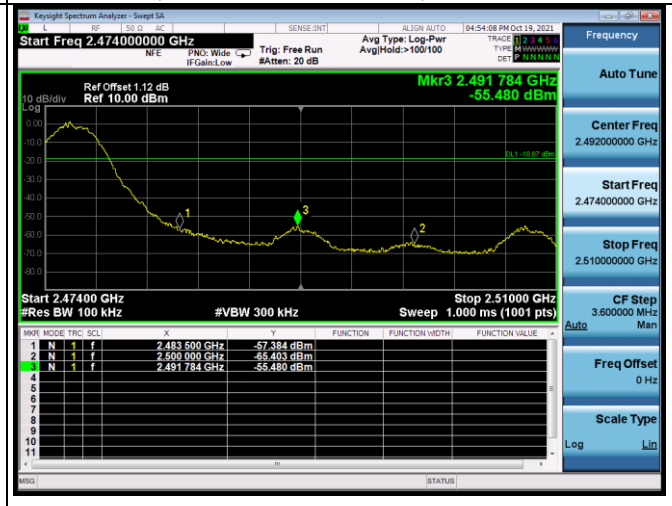

2476MHz(1GHz-10GHz)

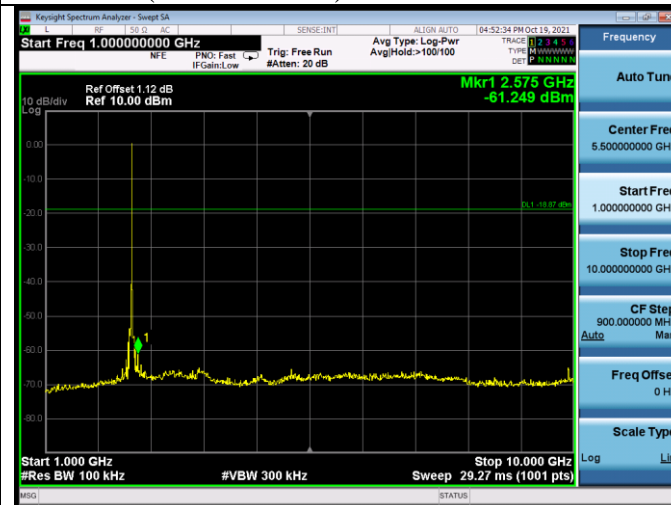

6. 6dB & 99% BANDWIDTH TEST

6.1. Test Equipment

Item	Equipment	Manufacturer	Model No.	Serial No.	Last Cal.	Cal. Interval
1.	PXA Signal Analyzer	Agilent	N9030A	MY51380221	Apr.07,21	1 Year
2.	Attenuator	Agilent	8491B	MY39269201	Oct.12,20	1 Year
3.	Attenuator	Agilent	8491B	MY39269201	Oct.09,21	1 Year
4.	RF Cable	Hubersuhner	SUCOFLEX-106	505238/6	Apr.07,21	1 Year

6.2. Limit

For direct sequence systems, the minimum 6dB bandwidth shall be at least 500kHz.

6.3. Test Procedure

Use the test method described in ANSI C63.10 clause 11.8.2:

The automatic bandwidth measurement capability of an instrument may be employed using the X dB bandwidth mode with X set to 6 dB, if the functionality described in 11.8.1 (i.e., RBW = 100 kHz, VBW $\geq 3 \times$ RBW, and peak detector with maximum hold) is implemented by the instrumentation function. When using this capability, care shall be taken so that the bandwidth measurement is not influenced by any intermediate power nulls in the fundamental emission that might be ≥ 6 dB.

Use the test method described in ANSI C63.10 clause 6.9.2:

The occupied bandwidth is the frequency bandwidth such that, below its lower and above its upper frequency limits, the mean powers are each equal to 0.5% of the total mean power of the given emission. The following procedure shall be used for measuring 99% power bandwidth:

- a) The instrument center frequency is set to the nominal EUT channel center frequency. The frequency span for the spectrum analyzer shall be between 1.5 times and 5.0 times the OBW.
- b) The nominal IF filter bandwidth (3 dB RBW) shall be in the range of 1% to 5% of the OBW, and VBW shall be approximately three times the RBW, unless otherwise specified by the applicable requirement.
- c) Set the reference level of the instrument as required, keeping the signal from exceeding the maximum input mixer level for linear operation. In general, the peak of the spectral envelope shall be more than $[10 \log (OBW/RBW)]$ below the reference level. Specific guidance is given in 4.1.5.2.
- d) Step a) through step c) might require iteration to adjust within the specified range.
- e) Video averaging is not permitted. Where practical, a sample detection and single sweep mode shall be used. Otherwise, peak detection and max hold mode (until the trace stabilizes) shall be used.
- f) Use the 99% power bandwidth function of the instrument (if available) and report the measured bandwidth.

- g) If the instrument does not have a 99% power bandwidth function, then the trace data points are recovered and directly summed in linear power terms. The recovered amplitude data points, beginning at the lowest frequency, are placed in a running sum until 0.5% of the total is reached; that frequency is recorded as the lower frequency. The process is repeated until 99.5% of the total is reached; that frequency is recorded as the upper frequency. The 99% power bandwidth is the difference between these two frequencies.
- h) The occupied bandwidth shall be reported by providing plot(s) of the measuring instrument display; the plot axes and the scale units per division shall be clearly labeled. Tabular data may be reported in addition to the plot(s).

6.4. Test Results

6 dB bandwidth:

EUT: Active Speaker System		
M/N: SA-SD40		
Test date: 2021-09-15 ~ 10-20	Pressure: 102.5±1.0 kpa	Humidity: 51.5±3.0%
Tested by: THOMAX	Test site: RF site	Temperature:22.5±0.6 °C

99% Occupied bandwidth:

EUT: Active Speaker System		
M/N: SA-SD40		
Test date: 2021-09-15 ~ 10-20	Pressure: 102.5±1.0 kpa	Humidity: 51.5±3.0%
Tested by: THOMAX	Test site: RF site	Temperature:22.5±0.6 °C

Test Mode	Frequency (MHz)	6 dB bandwidth (kHz)	Limit (KHz)
2.4G	2404	2275	≥ 500
	2440	2221	≥ 500
	2476	2512	≥ 500

Conclusion : PASS

Test Mode	Frequency (MHz)	99% bandwidth (MHz)	Limit (KHz)
2.4G	2404	4.4757	N/A
	2440	4.5717	N/A
	2476	4.8568	N/A

Conclusion: PASS

6dB and 99% Bandwidth

GFSK

2404MHz

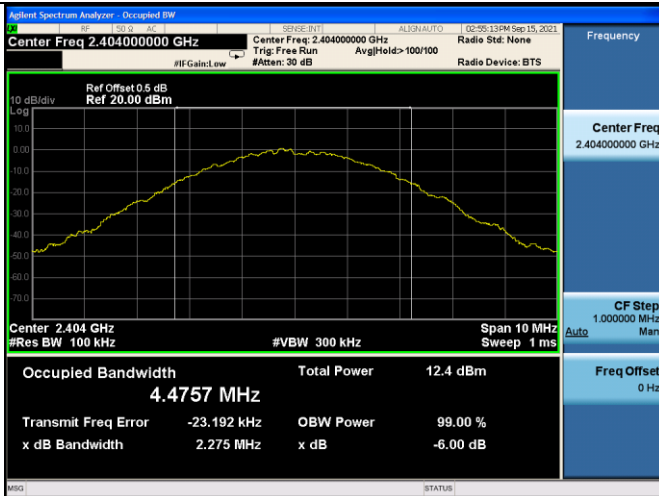

2440MHz

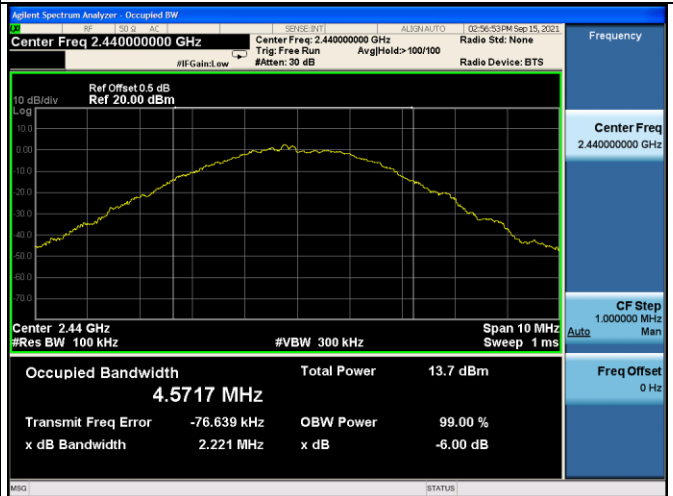

2476MHz

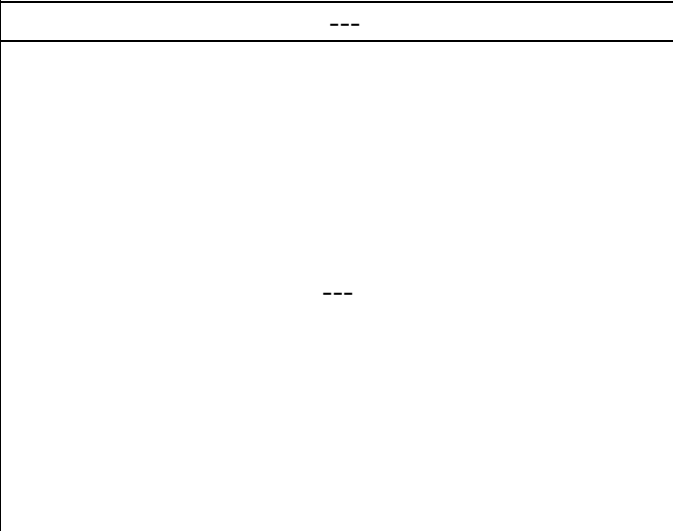
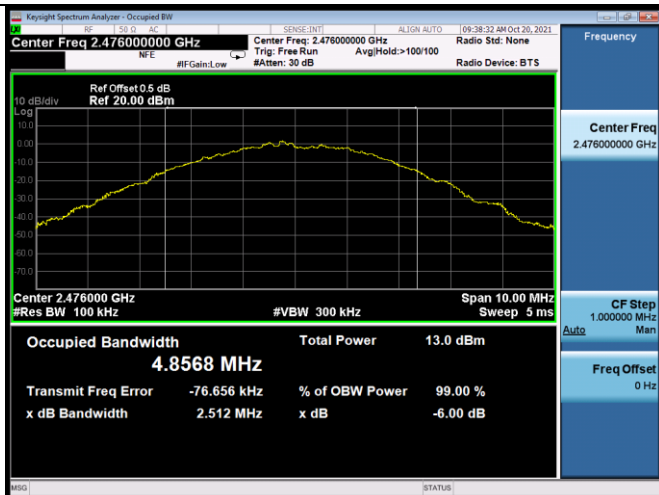

7. MAXIMUM PEAK OUTPUT POWER TEST

7.1. Test Equipment

Item	Equipment	Manufacturer	Model No.	Serial No.	Last Cal.	Cal. Interval
1.	PXA Signal Analyzer	Agilent	N9030A	MY51380221	Apr.07,21	1 Year
2.	Power meter	Anritsu	ML2487A	6K00002472	Apr.07,21	1 Year
3.	Power sensor	Anritsu	MA2491A	033005	Apr.06,21	1 Year
4.	Attenuator	Agilent	8491B	MY39269201	Oct.12,20	1 Year
5.	Attenuator	Agilent	8491B	MY39269201	Oct.09,21	1 Year
6.	RF Cable	HUBER+SUHN ER	SUCOFLE X-106	505238/6	Apr.07,21	1 Year

7.2. Limit

For systems using digital modulation in the 2400—2483.5MHz, The Peak output Power shall not exceed 1W(30dBm).

7.3. Test Procedure

Use the test method described in ANSI C63.10 clause 11.9.1.3:

Connected the EUT's antenna port to Power Sensor, and use power meter to test peak output power.

7.4. Test Results

EUT: Active Speaker System		
M/N: SA-SD40		
Test date: 2021-09-24	Pressure: 102.5±1.0 kpa	Humidity: 53.5±3.0%
Tested by: THOMAX	Test site: RF site	Temperature: 25.5±0.6°C

Test Mode	Frequency (MHz)	Power Set	Peak output Power (dBm)	Limit (dBm)
2.4G	2404	RF Power=0x0F RF iCurrent=0xD9	2.569	30
	2440		3.835	30
	2476		4.585	30
Conclusion: PASS				

8. BAND EDGE COMPLIANCE TEST

8.1. Test Equipment

Item	Equipment	Manufacturer	Model No.	Serial No.	Last Cal.	Cal. Interval
1.	PXA Signal Analyzer	Agilent	N9030A	MY51380221	Apr.07,21	1 Year
2.	Amplifier	Agilent	8449B	3008A02495	Apr.07,21	1 Year
3.	Horn Antenna	ETC	MCTD 1209	DRH15F03006	Jul.26,21	1 Year
4.	RF Cable	HUBER+SUHNER	SUCOFLEX-106	505238/6	Apr.07,21	1 Year

8.2. Limit

All the lower and upper band-edges emissions appearing within 2310MHz to 2390MHz and 2483.5MHz to 2500MHz restricted frequency bands shall not exceed the limits shown in 15.209, all the other emissions outside operation frequency band 2400MHz to 2483.5MHz shall be at least 20dB below the fundamental emissions, or comply with 15.209 limits.

8.3. Test Produce

Use the test method described in ANSI C63.10 clause 6.10:

For upper band emissions that are up to two bandwidths(2MHz) away (2483.5MHz to 2485.5MHz) from the band-edge use below produce:

1. Choose a spectrum analyzer span that encompasses both the peak of the fundamental emission and the band-edge emission under investigation. Set the analyzer RBW to 100KHz and with a video bandwidth 300KHz. Record the peak levels of the fundamental emission and the relevant band-edge emission, Observe the stored trace and measure the amplitude delta between the peak of the fundamental and the peak of the band-edge emission. This is not a field strength measurement, it is only a relative measurement to determine the amount by which the emission drops at the band edge relative to the highest fundamental emission level.
2. Subtract the delta measured in step (1) from the maximum field strengths measured in clause 4 .The resultant field strengths are then used to determine band-edge compliance as required by Section 15.205

For emissions above two bandwidths away from the band-edge use below produce:

1. The EUT is placed on a turntable, which is 0.8m above the ground plane and worked at highest radiated power.
2. The turntable was rotated for 360 degrees to determine the position of maximum emission level.
3. EUT is set 3m away from the receiving antenna, which is varied from 1m to 4m to find out the highest emission.
4. Set the spectrum analyzer in the following setting in order to capture the lower and upperband-edges of the emission:
 - (a) PEAK: RBW=1MHz ;VBW=3MHz, PK detector, Sweep=AUTO
 - (b) Average: RBW=1MHz , VBW=10Hz,Sweep time=Auto

8.4. Test Results

Pass (The testing data was attached in the next pages.)

Note: If the PK measured levels comply with average limit, then the average level were deemed to comply with average limit.

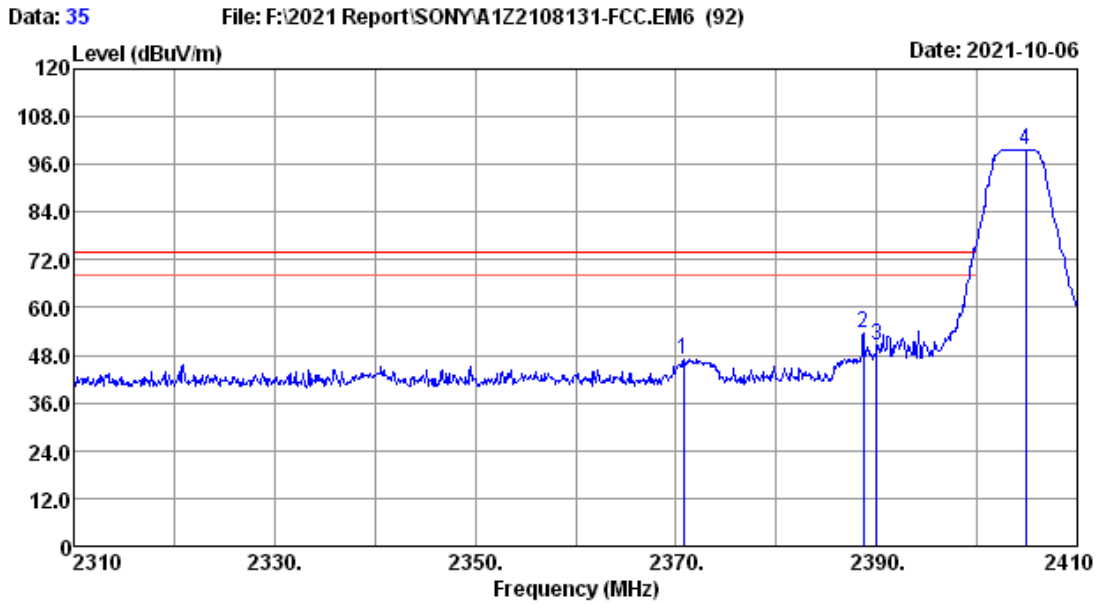

Site no. : 3m Chamber Data no. : 35
 Dis. / Ant. : 3m 2021 MCTD1209-3006 Ant. pol. : VERTICAL
 Limit : FCC PART 15C PEAK
 Env. / Ins. : 23.8*C/53.5% Engineer : Winter
 Power rating : AC 120V/60Hz
 Test Mode : Soundbar: SRD 2404MHz Tx

No.	Freq. (MHz)	Ant. Factor (dB/m)	Cable Loss (dB)	Reading (dBuV)	Amp factor (dB)	Emission Level (dBuV/m)	Limits (dBuV/m)	Margin (dB)	Remark
1	2370.80	27.86	1.64	52.61	35.24	46.87	74.00	27.13	Peak
2	2388.70	27.89	1.65	59.12	35.24	53.42	74.00	20.58	Peak
3	2390.00	27.89	1.65	56.36	35.24	50.66	74.00	23.34	Peak
4	2404.90	27.93	1.66	105.48	35.24	99.83	-----	-----	Peak

Remarks: 1. Emission Level= Antenna Factor + Cable Loss + Reading -Amp factor.
 2. The emission levels that are 20dB below the official limit are not reported.

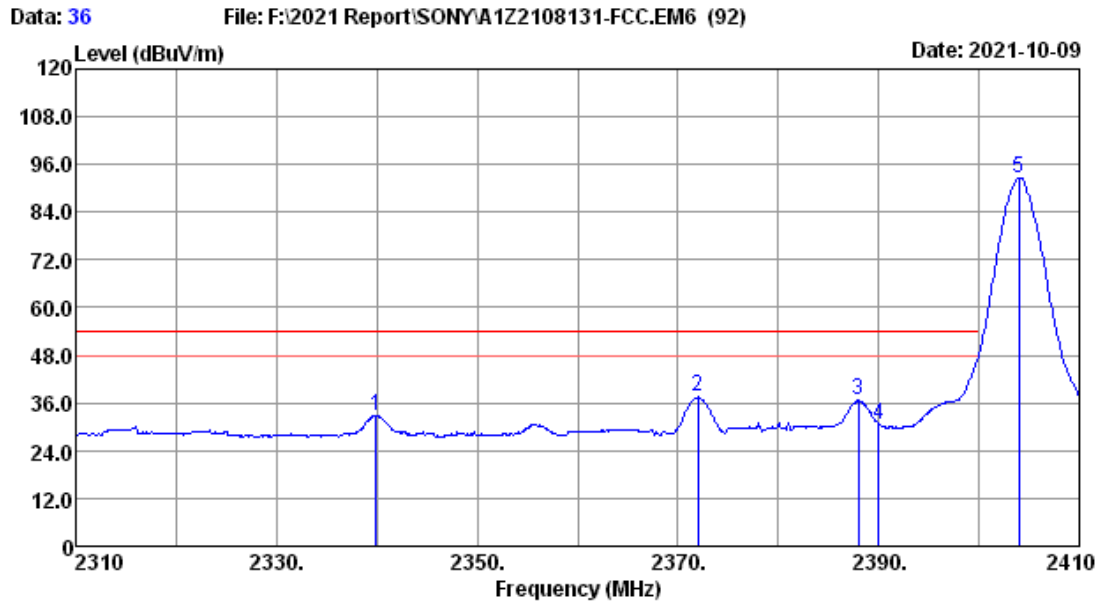

Site no. : 3m Chamber Data no. : 36
 Dis. / Ant. : 3m 2021 MCTD1209-3006 Ant. pol. : VERTICAL
 Limit : FCC PART 15C AV
 Env. / Ins. : 23.8*C/53.5% Engineer : Winter
 Power rating : AC 120V/60Hz
 Test Mode : Soundbar: SRD 2404MHz Tx

No.	Freq. (MHz)	Ant. Factor (dB/m)	Cable Loss (dB)	Reading (dBuV)	Amp factor (dB)	Emission Level (dBuV/m)	Limits (dBuV/m)	Margin (dB)	Remark
1	2339.90	27.79	1.64	38.53	35.24	32.72	54.00	21.28	Average
2	2372.00	27.86	1.64	43.17	35.24	37.43	54.00	16.57	Average
3	2388.00	27.89	1.65	42.32	35.24	36.62	54.00	17.38	Average
4	2390.00	27.89	1.65	36.39	35.24	30.69	54.00	23.31	Average
5	2404.00	27.93	1.66	98.40	35.24	92.75	-----	-----	Average

Remarks: 1. Emission Level= Antenna Factor + Cable Loss + Reading - Amp factor.
 2. The emission levels that are 20dB below the official limit are not reported.

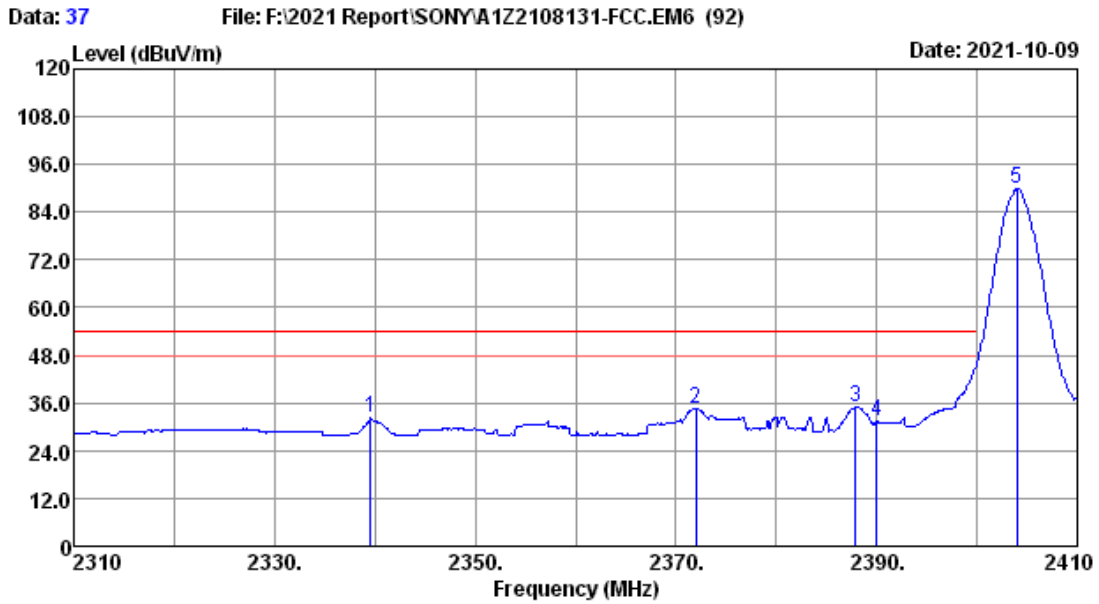

Site no. : 3m Chamber Data no. : 37
 Dis. / Ant. : 3m 2021 MCTD1209-3006 Ant. pol. : HORIZONTAL
 Limit : FCC PART 15C AV
 Env. / Ins. : 23.8*C/53.5% Engineer : Winter
 Power rating : AC 120V/60Hz
 Test Mode : Soundbar: SRD 2404MHz Tx

No.	Freq. (MHz)	Ant. Factor (dB/m)	Cable Loss (dB)	Reading (dBuV)	Amp factor (dB)	Emission Level (dBuV/m)	Limits (dBuV/m)	Margin (dB)	Remark
1	2339.60	27.79	1.64	38.01	35.24	32.20	54.00	21.80	Average
2	2372.00	27.86	1.64	40.45	35.24	34.71	54.00	19.29	Average
3	2387.90	27.89	1.65	40.71	35.24	35.01	54.00	18.99	Average
4	2390.00	27.89	1.65	37.07	35.24	31.37	54.00	22.63	Average
5	2404.00	27.93	1.66	95.59	35.24	89.94	-----	-----	Average

Remarks: 1. Emission Level= Antenna Factor + Cable Loss + Reading - Amp factor.
 2. The emission levels that are 20dB below the official limit are not reported.

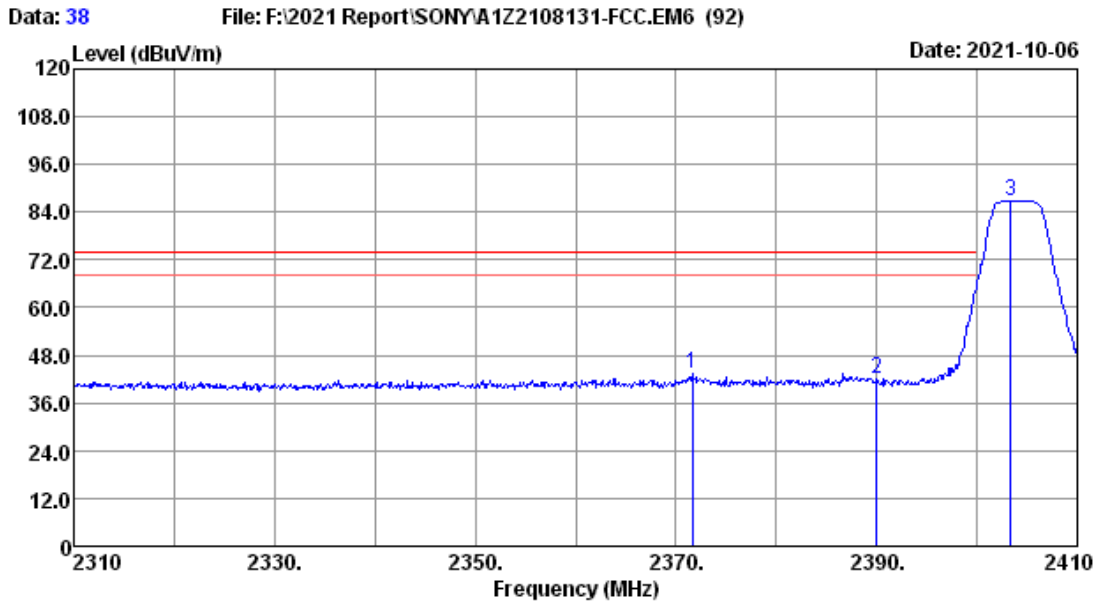

Site no. : 3m Chamber Data no. : 38
 Dis. / Ant. : 3m 2021 MCTD1209-3006 Ant. pol. : HORIZONTAL
 Limit : FCC PART 15C PEAK
 Env. / Ins. : 23.8°C/53.5% Engineer : Winter
 Power rating : AC 120V/60Hz
 Test Mode : Soundbar: SRD 2404MHz Tx

No.	Freq. (MHz)	Ant. Factor (dB/m)	Cable Loss (dB)	Reading (dBuV)	Amp factor (dB)	Emission Level (dBuV/m)	Limits (dBuV/m)	Margin (dB)	Remark
1	2371.60	27.86	1.64	49.09	35.24	43.35	74.00	30.65	Peak
2	2390.00	27.89	1.65	47.56	35.24	41.86	74.00	32.14	Peak
3	2403.40	27.93	1.66	92.35	35.24	86.70	-----	-----	Peak

Remarks: 1. Emission Level= Antenna Factor + Cable Loss + Reading -Amp factor.
 2. The emission levels that are 20dB below the official limit are not reported.

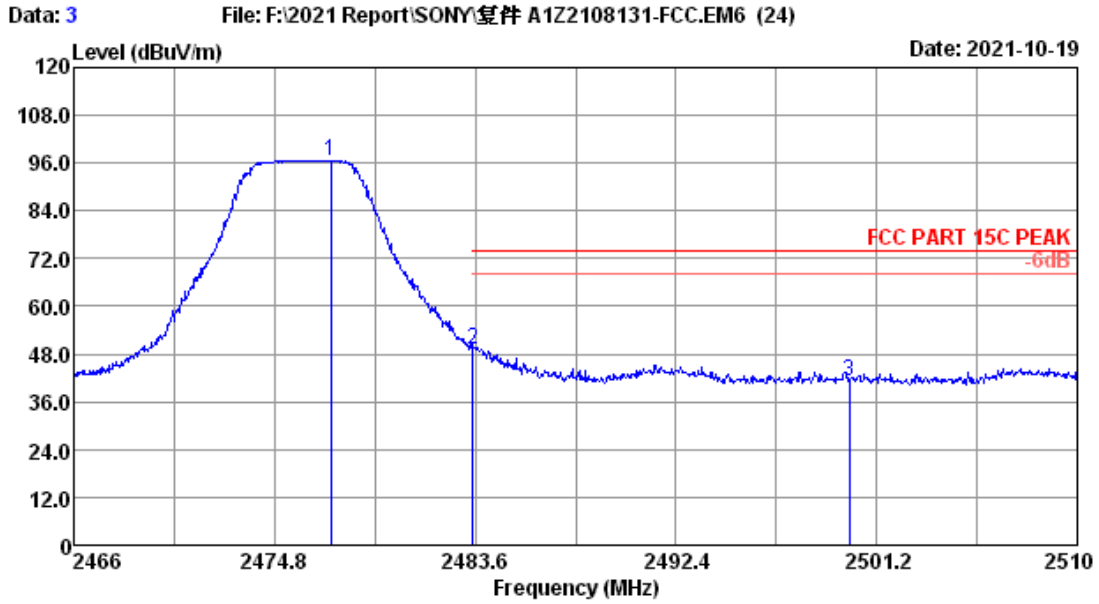

Site no. : 3m Chamber Data no. : 3
 Dis. / Ant. : 3m 2021 MCTD1209-3006 Ant. pol. : HORIZONTAL
 Limit : FCC PART 15C PEAK
 Env. / Ins. : 23.8°C/53.5% Engineer : Winter
 Test Mode : Soundbar: SRD 2476MHz Tx

No.	Freq. (MHz)	Ant. Factor (dB/m)	Cable Loss (dB)	Reading (dBuV)	Amp factor (dB)	Emission Level (dBuV/m)	Limits (dBuV/m)	Margin (dB)	Remark
1	2477.26	28.07	1.69	102.09	35.25	96.60	74.00	22.60	Peak
2	2483.50	28.07	1.69	54.80	35.25	49.31	74.00	24.69	Peak
3	2500.00	28.10	1.70	46.81	35.25	41.36	74.00	32.64	Peak

Remarks: 1. Emission Level= Antenna Factor + Cable Loss + Reading
 -Amp factor.
 2. The emission levels that are 20dB below the official
 limit are not reported.

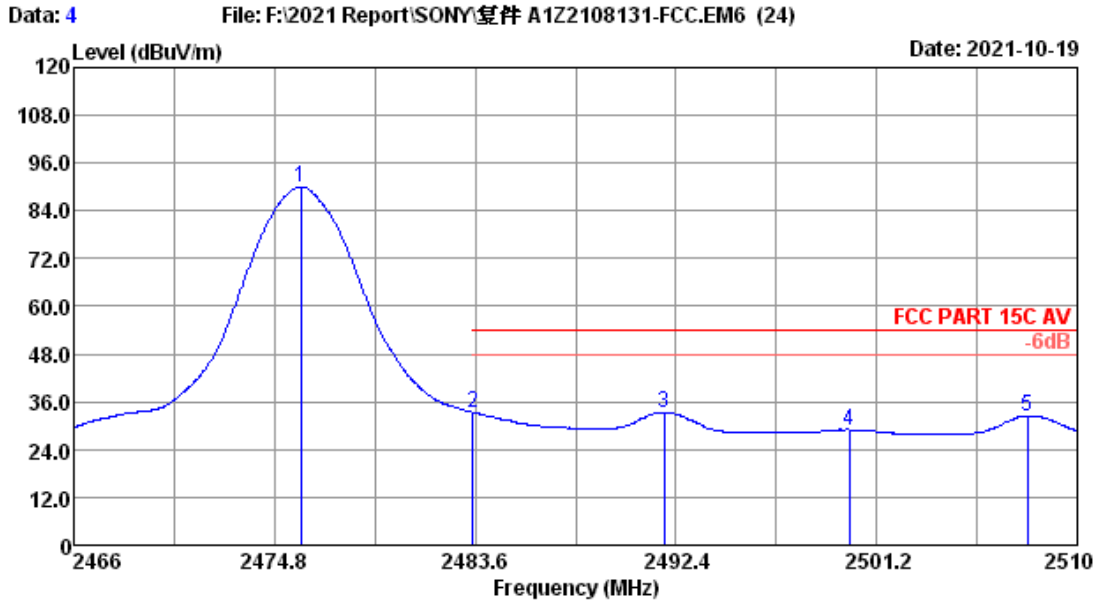

Site no. : 3m Chamber Data no. : 4
 Dis. / Ant. : 3m 2021 MCTD1209-3006 Ant. pol. : HORIZONTAL
 Limit : FCC PART 15C AV
 Env. / Ins. : 23.8°C/53.5% Engineer : Winter
 Test Mode : Soundbar: SRD 2476MHz Tx

No.	Freq. (MHz)	Ant. Factor (dB/m)	Cable Loss (dB)	Reading (dBuV)	Amp factor (dB)	Emission Level (dBuV/m)	Limits (dBuV/m)	Margin (dB)	Remark
1	2475.94	28.07	1.69	95.53	35.25	90.04	54.00	20.70	Average
2	2483.50	28.07	1.69	38.79	35.25	33.30	54.00	20.70	Average
3	2491.87	28.10	1.70	38.77	35.25	33.32	54.00	20.68	Average
4	2500.00	28.10	1.70	34.45	35.25	29.00	54.00	25.00	Average
5	2507.80	28.11	1.70	37.83	35.25	32.39	54.00	21.61	Average

Remarks: 1. Emission Level= Antenna Factor + Cable Loss + Reading - Amp factor.
 2. The emission levels that are 20dB below the official limit are not reported.

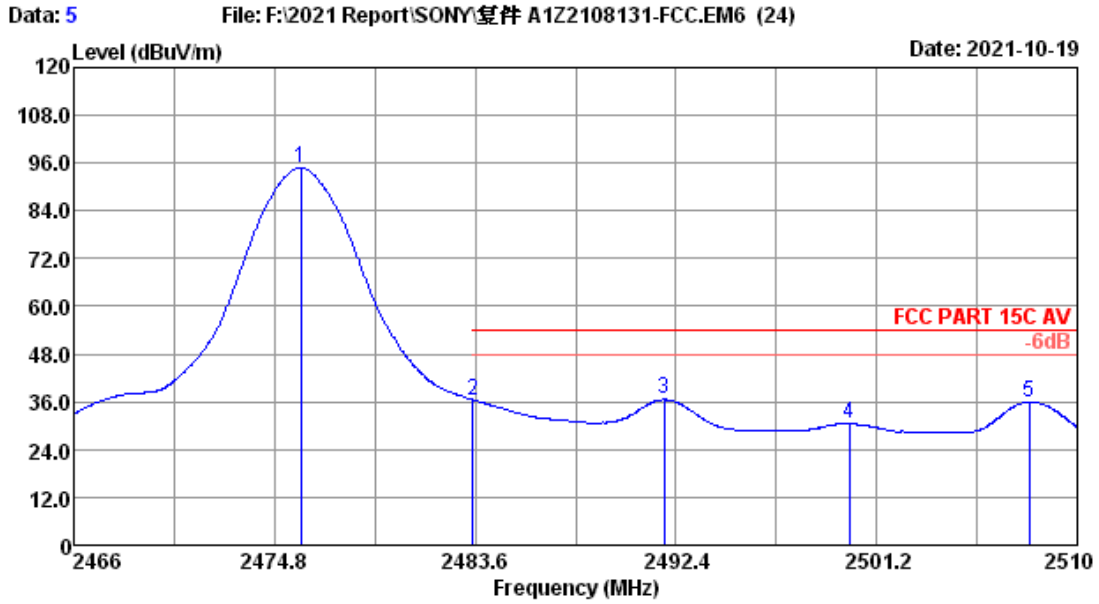

Site no. : 3m Chamber Data no. : 5
 Dis. / Ant. : 3m 2021 MCTD1209-3006 Ant. pol. : VERTICAL
 Limit : FCC PART 15C AV
 Env. / Ins. : 23.8°C/53.5% Engineer : Winter
 Test Mode : Soundbar: SRD 2476MHz Tx

No.	Freq. (MHz)	Ant. Factor (dB/m)	Cable Loss (dB)	Reading (dBuV)	Amp factor (dB)	Emission Level (dBuV/m)	Limits (dBuV/m)	Margin (dB)	Remark
1	2475.94	28.07	1.69	100.37	35.25	94.88	54.00	40.88	Average
2	2483.50	28.07	1.69	42.01	35.25	36.52	54.00	17.48	Average
3	2491.87	28.10	1.70	42.04	35.25	36.59	54.00	17.41	Average
4	2500.00	28.10	1.70	35.92	35.25	30.47	54.00	23.53	Average
5	2507.89	28.11	1.70	41.39	35.25	35.95	54.00	18.05	Average

Remarks: 1. Emission Level= Antenna Factor + Cable Loss + Reading -Amp factor.
 2. The emission levels that are 20dB below the official limit are not reported.

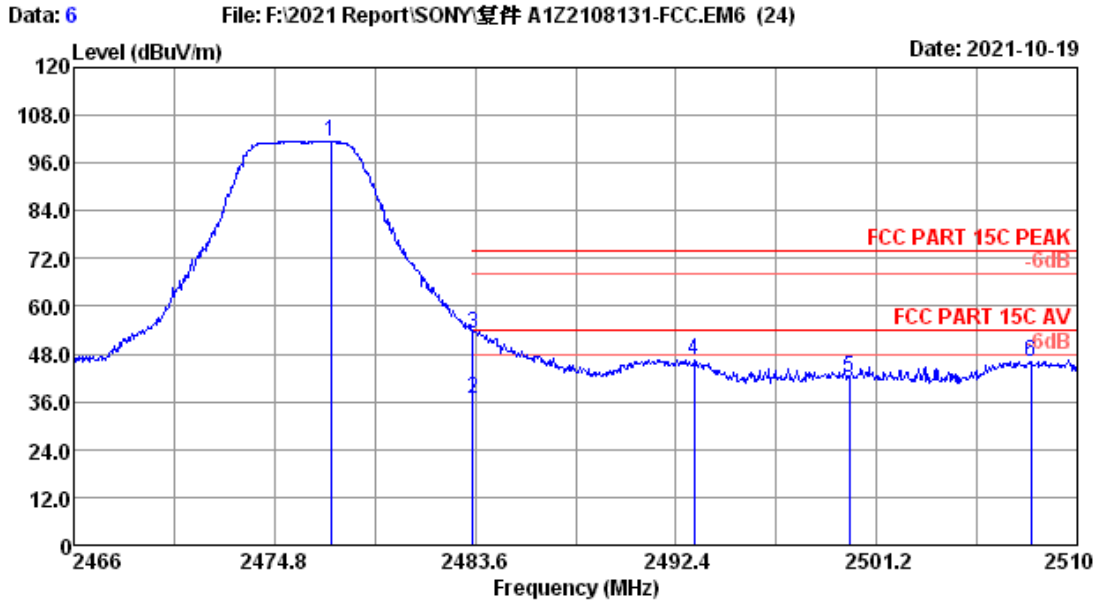

Site no. : 3m Chamber Data no. : 6
 Dis. / Ant. : 3m 2021 MCTD1209-3006 Ant. pol. : VERTICAL
 Limit : FCC PART 15C PEAK
 Env. / Ins. : 23.8°C/53.5% Engineer : Winter
 Test Mode : Soundbar: SRD 2476MHz Tx

No.	Freq. (MHz)	Ant. Factor (dB/m)	Cable Loss (dB)	Reading (dBuV)	Amp factor (dB)	Emission Level (dBuV/m)	Limits (dBuV/m)	Margin (dB)	Remark
1	2477.26	28.07	1.69	106.85	35.25	101.36	-----	-----	Peak
2	2483.50	28.07	1.69	42.28	35.25	36.79	54.00	17.21	Average
3	2483.50	28.07	1.69	58.45	35.25	52.96	74.00	21.04	Peak
4	2493.19	28.10	1.70	51.99	35.25	46.54	74.00	27.46	Peak
5	2500.00	28.10	1.70	47.31	35.25	41.86	74.00	32.14	Peak
6	2507.98	28.11	1.70	51.49	35.25	46.05	74.00	27.95	Peak

Remarks: 1. Emission Level= Antenna Factor + Cable Loss + Reading - Amp factor.
 2. The emission levels that are 20dB below the official limit are not reported.

9. POWER SPECTRAL DENSITY TEST

9.1. Test Equipment

Item	Equipment	Manufacturer	Model No.	Serial No.	Last Cal.	Cal. Interval
1.	PXA Signal Analyzer	Agilent	N9030A	MY51380221	Apr.07,21	1 Year
2.	Attenuator	Agilent	8491B	MY39269201	Oct.12,20	1 Year
3.	Attenuator	Agilent	8491B	MY39269201	Oct.09,21	1 Year
4.	RF Cable	HUBER+SUHNER	SUCOFLEX-106	505238/6	Apr.07,21	1 Year

9.2. Limit

For digitally modulated systems, the power spectral density conducted from the intentional radiator to the antenna shall not be greater than 8dBm in any 3kHz band during any time interval of continuous transmission.

9.3. Test Procedure

Use the test method described in ANSI C63.10 clause 11.10.2:

- a) Set analyzer center frequency to DTS channel center frequency.
- b) Set the span to 1.5 times the DTS bandwidth.
- c) Set the RBW to $3 \text{ kHz} \leq \text{RBW} \leq 100 \text{ kHz}$.
- d) Set the VBW $\geq [3 \times \text{RBW}]$.
- e) Detector = peak.
- f) Sweep time = auto couple.
- g) Trace mode = max hold.
- h) Allow trace to fully stabilize.
- i) Use the peak marker function to determine the maximum amplitude level within the RBW.
- j) If measured value exceeds requirement, then reduce RBW (but no less than 3 kHz) and repeat.

9.4. Test Results

EUT: Active Speaker System		
M/N: SA-SD40		
Test date: 2021-09-27 ~ 10-19	Pressure: 102.1±1.0 kpa	Humidity: 51.1±3.0%
Tested by: THOMAX	Test site: RF site	Temperature: 22.8±0.6 °C

Test Mode	Frequency (MHz)	Power density (dBm/3kHz)	Limit (dBm/3kHz)
2.4G	2404	-14.940	8
	2440	-14.800	8
	2476	-13.767	8

Conclusion : PASS

2404MHz

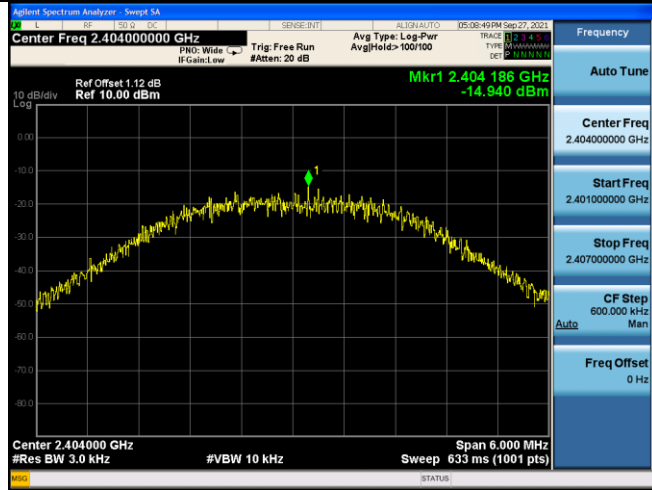

2440MHz

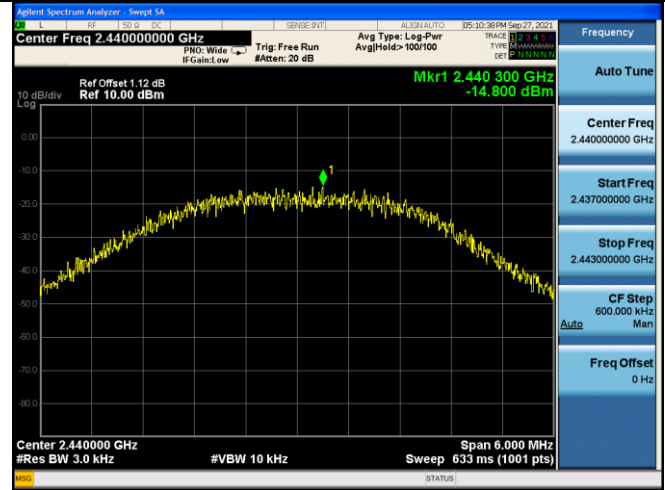

2476MHz

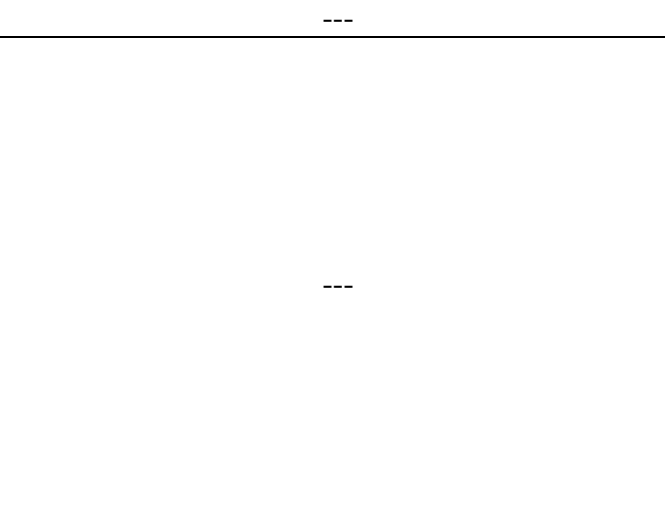
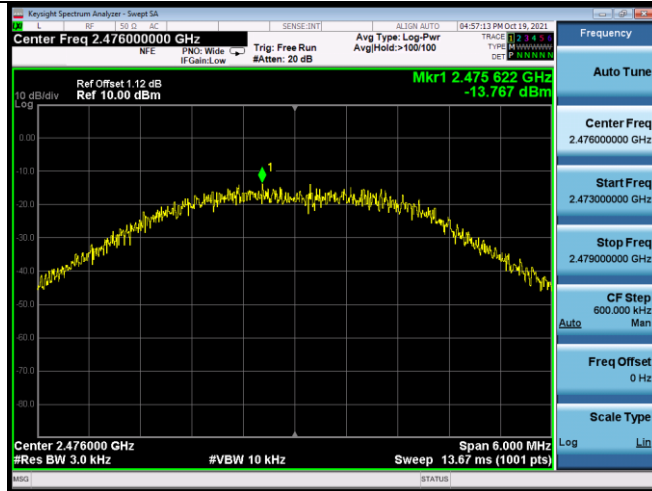

10. ANTENNA REQUIREMENT

10.1. STANDARD APPLICABLE

For intentional device, according to FCC 47 CFR Section 15.203, an intentional radiator shall be designed to ensure that no antenna other than that furnished by the responsible party shall be used with the device. And according to FCC 47 CFR Section 15.247 (b), if transmitting antennas of directional gain greater than 6dBi are used, the power shall be reduced by the amount in dB that the directional gain of the antenna exceeds 6dBi.

10.2. ANTENNA CONNECTED CONSTRUCTION

The antennas used for this product are Chip Antenna that no antenna other than that furnished by the responsible party shall be used with the device, the maximum peak gain of the transmit antenna Sound Bar BT is 2.1 dBi, Subwoofer SRD is 2.95 dBi and Sound Bar SRD is 4.23 dBi.

11. DEVIATION TO TEST SPECIFICATIONS

[NONE]