

**SONY**<sup>®</sup>

## Sound Bar

### Operating Instructions



HT-G700

### Owner's Record

The model and serial numbers are located on the bottom of the bar speaker. Record the serial numbers in the space provided below. Refer to them whenever you call upon your Sony dealer regarding the Sound Bar.

Model No. HT-G700 \_\_\_\_\_

Serial No. \_\_\_\_\_

### WARNING

**To reduce the risk of fire or electric shock, do not expose this system to rain or moisture.**

The system is not disconnected from the mains as long as it is connected to the AC outlet, even if the system itself has been turned off.

To reduce the risk of fire, do not cover the ventilation opening of the system with newspapers, tablecloths, curtains, etc.

Do not expose the system to naked flame sources (for example, lighted candles).

To reduce the risk of fire or electric shock, do not expose this system to dripping or splashing, and do not place objects filled with liquids, such as vases, on the system.

As the main plug is used to disconnect the system from the mains, connect the system to an easily accessible AC outlet. Should you notice an abnormality in the system, disconnect the main plug from the AC outlet immediately.

Do not install the system in a confined space, such as a bookcase or built-in cabinet.

### CAUTION

Risk of explosion if the battery is replaced by an incorrect type. Do not expose batteries or appliances with battery-installed to excessive heat, such as sunshine and fire.

### Do not place this product close to medical devices.

This product (including accessories) has magnet(s) which may interfere with pacemakers, programmable shunt valves for hydrocephalus treatment, or other medical devices. Do not place this product close to persons who use such medical devices. Consult your doctor before using this product if you use any such medical device.

Indoor use only.

### For the bar speaker

The nameplate is located on the bottom of the bar speaker.

### For the customers in the U.S.A.

#### NOTE:

This system has been tested and found to comply with the limits for a Class B digital device, pursuant to Part 15 of the FCC Rules. These limits are designed to provide reasonable protection against harmful interference in a residential installation. This system generates, uses and can radiate radio frequency energy and, if not installed and used in accordance with the instructions, may cause harmful interference to radio communications.

However, there is no guarantee that interference will not occur in a particular installation. If this system does cause harmful interference to radio or television reception, which can be determined by turning the system off and on, the user is encouraged to try to correct the interference by one or more of the following measures:

- Reorient or relocate the receiving antenna.
- Increase the separation between the system and receiver.
- Connect the system into an outlet on a circuit different from that to which the receiver is connected.
- Consult the dealer or an experienced radio/TV technician for help.

Properly shielded and grounded cables and connectors must be used for connection to host computers and/or peripherals in order to meet FCC emission limits.

If you have any questions about this Sound Bar:

Visit: [www.sony.com/support](http://www.sony.com/support)

Contact: Sony Customer Information Service Center at 1-800-222-SONY (7669)

Write: Sony Customer Information Service Center 12451 Gateway Blvd., Fort Myers, FL 33913

**Supplier's Declaration of Conformity**

Trade Name: SONY

Model No.: HT-G700

Responsible Party: Sony Electronics Inc. Address: 16535 Via Esprillo, San Diego, CA 92127 USA

Telephone No.: 858-942-2230

This device complies with Part 15 of the FCC Rules. Operation is subject to the following two conditions: (1) This device may not cause harmful interference, and (2) this device must accept any interference received, including interference that may cause undesired operation.

**CAUTION**

You are cautioned that any changes or modifications not expressly approved in this manual could void your authority to operate this system.

This system must not be co-located or operated in conjunction with any other antenna or transmitter.

This system complies with FCC radiation exposure limits set forth for an uncontrolled environment and meets the FCC radio frequency (RF) Exposure Guidelines. This system should be installed and operated keeping the radiator at least 20cm or more away from person's body.

**For the customers in Canada**

Properly shielded and grounded cables and connectors must be used for connection to host computers and/or peripherals.

This system contains licence-exempt transmitter(s)/receiver(s) that comply with Innovation, Science and Economic Development Canada's license-exempt RSS(s). Operation is subject to the following two conditions:

- (1) This system may not cause interference; and
- (2) This system must accept any interference, including interference that may cause undesired operation of the system.

This system complies with ISED radiation exposure limits set forth for an uncontrolled environment and meets RSS-102 of the ISED radio frequency (RF) Exposure rules. This system should be installed and operated keeping the radiator at least 20cm or more away from person's body.

US

## Table of Contents

About These Operating Instructions .....	5	<b>Adjusting the Sound Quality</b>	
What's in the Box .....	6	Enjoying Immersive Surround Experience (IMMERSIVE AE) .....	27
What You Can Do with the System .....	7	Setting the Sound Effect that is Tailored to Sound Sources (Sound Mode) .....	28
Guide to Parts and Controls .....	8	Making Dialogs Clearer (VOICE) .....	29
<b>Installing the System</b>		Enjoying Clear Sound with Low Volume at Midnight (NIGHT) .....	29
Installing the Bar Speaker and Subwoofer	→ Startup Guide (separate document)	Checking the Current Sound Settings .....	30
Mounting the Bar Speaker on a Wall .....	13	<b>Using the Control for HDMI Function</b>	
Connecting the Subwoofer .....	15	Using the Control for HDMI Function .....	31
When the TV Remote Control does not Work .....	16	Using the "BRAVIA" Sync Function .....	33
<b>Connecting to a TV or AV Device</b>		<b>Changing the Settings</b>	
Connecting to a TV or AV Device with the HDMI Cable	→ Startup Guide (separate document)	Using the Setting Menu .....	34
Connecting Sony TV with the BLUETOOTH Function Wirelessly .....	17	Changing the Brightness of the Front Panel Display and Indicators (DIMMER) .....	39
Connecting a 4K TV and 4K Devices .....	20	Saving Power in Standby Mode .....	40
<b>Listening to Music/Sound</b>		<b>Troubleshooting</b>	
Listening to a TV and Other Devices .....	22	Troubleshooting .....	41
Adjusting the Volume .....	23	Resetting the system .....	47
Enjoying Multiplex Broadcast Sound (AUDIO) .....	23	<b>Additional Information</b>	
Listening to Music/Sound with the BLUETOOTH® Function .....	24	Specifications .....	48
		Supported Input Audio Formats .....	50
		Supported HDMI Video Formats .....	51
		On BLUETOOTH Communication .....	53

END USER LICENSE	
AGREEMENT .....	54
Precautions .....	58
Index .....	61

## About These Operating Instructions

- The instructions in these Operating Instructions describe the controls on the remote control.
- Some illustrations are presented as conceptual drawings, and may be different from the actual products.
- The default settings are underlined on each feature description.
- Characters in brackets [ ] appear on the front panel display.

# What's in the Box

- Bar speaker (1)

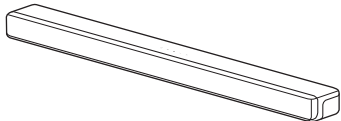

- WALL MOUNT TEMPLATE (1)

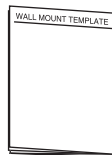

- Subwoofer (1)

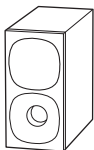

- Startup Guide



- Remote control (1)/  
R03 (size AAA) battery (2)

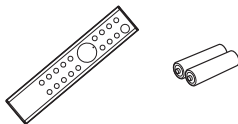

- Operating Instructions (this document)

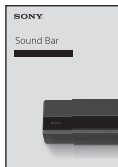

- HDMI cable (supports the specification equal to Premium High Speed HDMI Cable with Ethernet) (1)

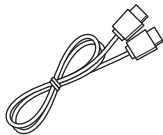

- AC power cord (mains lead) (2)



6<sup>US</sup>

## What You Can Do with the System

The system supports object-based audio formats such as Dolby Atmos and DTS:X as well as HDR video formats such as HDR10, HLG, and Dolby Vision.

**"Listening to a TV and Other Devices" (page 22)**

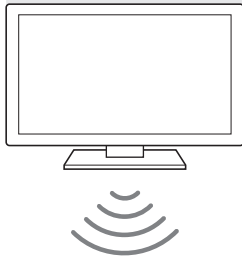

**"Connecting Sony TV with the BLUETOOTH Function Wirelessly" (page 17)**

Blu-ray Disc™ player, cable box, satellite box, etc.

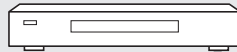

**Basic connection: Refer to "Startup Guide" (separate document).  
Other connections: See "Connecting to a TV or AV Device" (page 17).**

**"Using the Control for HDMI Function" (page 31)  
"Using the "BRAVIA" Sync Function" (page 33)**

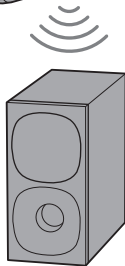
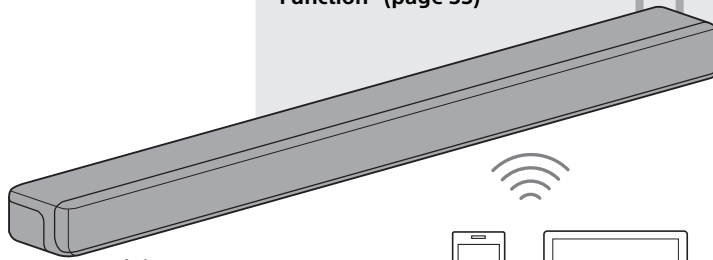

**"Connecting the Subwoofer" (page 15)**

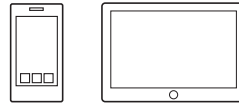

**"Listening to Music/Sound with the BLUETOOTH® Function" (page 24)**

## Guide to Parts and Controls

Details are omitted from the illustrations.

### Bar Speaker (Main Unit)

#### Front

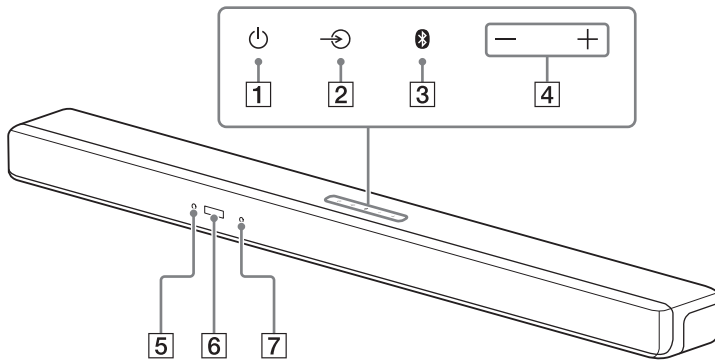

- |                                                                                                                                                                                                                                                                     |                                                                                                                                                                                                                                                                                                                                                                                                                                                                                                       |
|---------------------------------------------------------------------------------------------------------------------------------------------------------------------------------------------------------------------------------------------------------------------|-------------------------------------------------------------------------------------------------------------------------------------------------------------------------------------------------------------------------------------------------------------------------------------------------------------------------------------------------------------------------------------------------------------------------------------------------------------------------------------------------------|
| <p><b>1</b>  (power) button<br/>Turns on the system or sets it to standby mode.</p> <p><b>2</b>  (input select) button<br/>Selects the input for playback on the system.</p> <p><b>3</b> <b>BLUETOOTH</b> button (page 24)</p> <p><b>4</b> +/- (volume) buttons</p> | <p><b>5</b> <b>BLUETOOTH</b> indicator</p> <ul style="list-style-type: none"> <li>- Lights in blue: BLUETOOTH connection has been established.</li> <li>- Flashes slowly in blue repeatedly: BLUETOOTH connection is being attempted.</li> <li>- Flashes twice in blue repeatedly: During pairing standby status.</li> </ul> <p><b>6</b> <b>Front panel display</b></p> <p><b>7</b> <b>Remote control sensor</b><br/>Point the remote control at the remote control sensor to operate the system.</p> |
|---------------------------------------------------------------------------------------------------------------------------------------------------------------------------------------------------------------------------------------------------------------------|-------------------------------------------------------------------------------------------------------------------------------------------------------------------------------------------------------------------------------------------------------------------------------------------------------------------------------------------------------------------------------------------------------------------------------------------------------------------------------------------------------|



### Rear

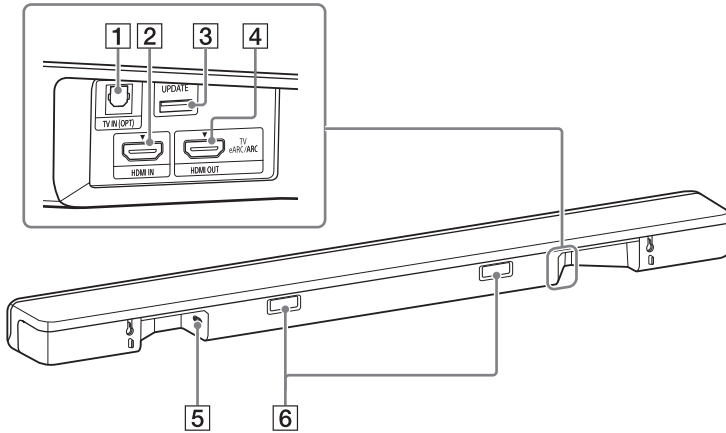

**1 TV IN (OPT) jack**

**2 HDMI IN jack**

For specifications and notes on connections, see “Supported HDMI Video Formats” (page 51).

**3 UPDATE port (page 38)**

Connect the USB memory when updating the system.

**4 HDMI OUT (TV eARC/ARC) jack**

Connect a TV that has an HDMI input jack with an HDMI cable. The system is compatible with eARC and ARC. ARC is the function that sends TV sound to an AV device such as the system from the TV’s HDMI jack. eARC is an extension of ARC and enables transmission of the object audio and multi-channel LPCM content that cannot be transmitted with ARC. For details of eARC, see “[eARC]” (page 36). For supported audio formats, see “Supported

Input Audio Formats” (page 50). For specifications and notes on connections, see “Supported HDMI Video Formats” (page 51).

**5 AC inlet**

**6 IR repeater (page 16)**

Transmits the remote signal of the TV remote control to the TV.

## Subwoofer

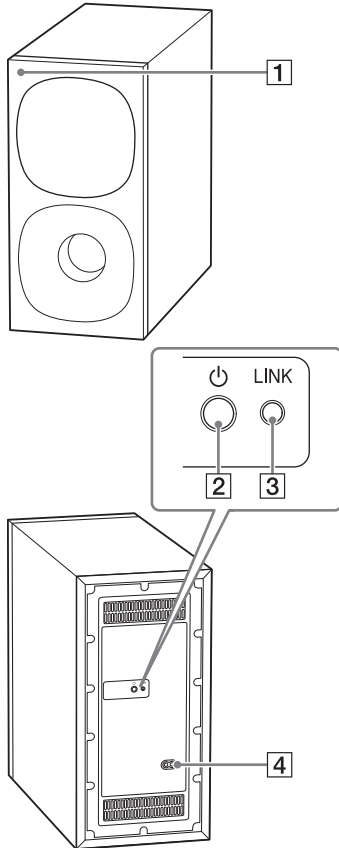

### 1 Power indicator

- Flashes quickly in green: The subwoofer is attempting to connect to the system with the manual connection.
- Flashes slowly in green: The subwoofer is attempting to connect to the system.
- Lights in green: The subwoofer is connected to the system.
- Flashes in amber: The software is updating.
- Lights in red: The subwoofer is in standby mode.
- Turns off: The subwoofer is turned off.

### 2 (power) button

Turns on or off the subwoofer.

### 3 LINK button (page 15)

### 4 AC inlet

## Remote Control

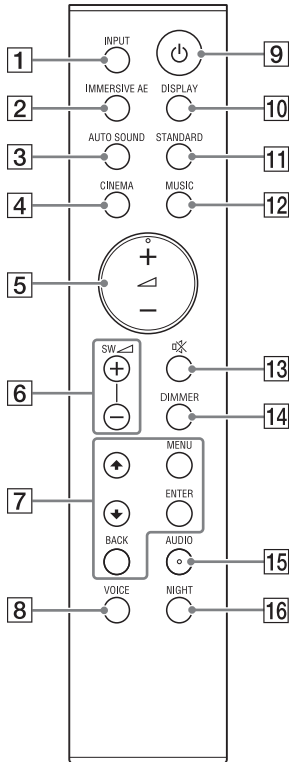

### 1 INPUT (page 22)

Selects the playback source. Each time you press INPUT, the selected input appears in the front panel display cyclically as follows. [TV] → [HDMI] → [BT]

### 2 IMMERSIVE AE (page 27)

Turns on/off the vertical surround function.

### 3 AUTO SOUND (page 28)

### 4 CINEMA (page 28)

### 5 ▲ (volume) +/- (page 23)

Adjusts the volume.

### 6 SW ▲ (subwoofer volume) +/- (page 23)

Adjusts the volume of the subwoofer.

### 7 MENU (page 34)

Turns on/off the setting menu in the front panel display.

### ▲/▼ (page 34)

Selects the menu items.

### ENTER (page 34)

Enters the selection.

### BACK (page 34)

Returns to the previous display.

### 8 VOICE (page 29)

### 9 ⏻ (power)

Turns on the system or sets it to standby mode.

### 10 DISPLAY (page 30)

Displays the settings of the sound mode, IMMERSIVE AE, voice mode, night mode, and current stream information.

### 11 STANDARD (page 28)

### 12 MUSIC (page 28)

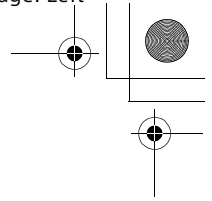
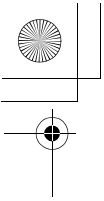

**13**  (muting)

Turns off the sound temporarily.

**14** DIMMER (page 39)

**15** AUDIO\* (page 23)

**16** NIGHT (page 29)

\* The AUDIO and  + buttons have a tactile dot. Use it as a guide during operation.

**About the replacement of batteries for the remote control**

When the system does not respond by operating with the remote control, replace two batteries with new batteries.  
Use R03 (size AAA) manganese batteries for replacement.

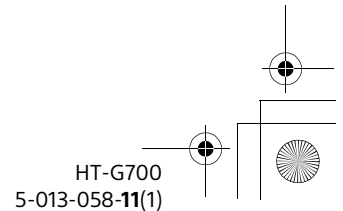
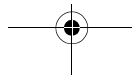
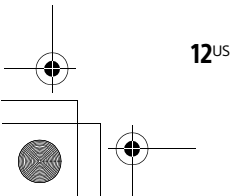
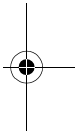
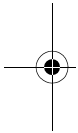

## Installing the System

# Installing the Bar Speaker and Subwoofer

Refer to Startup Guide (separate document).

## Mounting the Bar Speaker on a Wall

You can mount the bar speaker on a wall.

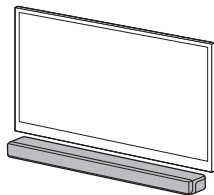

### Notes

- Prepare screws (not supplied) that are suitable for the wall material and strength. As a plasterboard wall is especially fragile, attach the screws securely in the wall beam. Install the speakers horizontally, hung by screws in studs in a continuous flat section of the wall.
- Have the installation done by a Sony dealer or licensed contractor and pay special attention to safety during the installation.
- Sony shall not be held responsible for accidents or damage caused by improper installation, insufficient wall strength, improper screw installation or natural disaster, etc.

- 1 Prepare two screws (not supplied) that are suitable for the wall mount holes on the rear of the bar speaker.

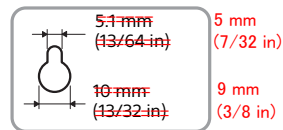
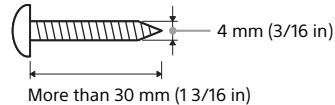

Hole on the rear of the bar speaker

- 2 Stick WALL MOUNT TEMPLATE (supplied) on a wall.

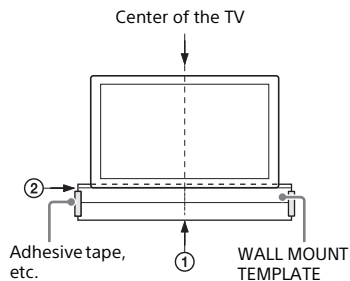

- 1 Align TV CENTER LINE (①) of WALL MOUNT TEMPLATE with the center line of your TV.
- 2 Align TV BOTTOM LINE (②) of WALL MOUNT TEMPLATE with the bottom of your TV, then stick WALL MOUNT TEMPLATE on a wall by using a commercially available adhesive tape, etc.

**3 Fasten the screws into the marks (Ⓢ) on SCREW LINE (③) of WALL MOUNT TEMPLATE as in the illustration below.**

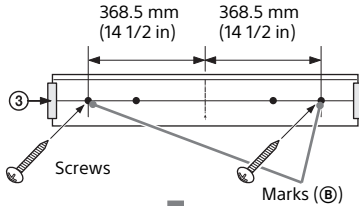

**Notes**

- When sticking WALL MOUNT TEMPLATE, smooth it out fully.
- When you do not use WALL MOUNT TEMPLATE, install the bar speaker apart from the TV by 70 mm (2 3/4 in) or more.

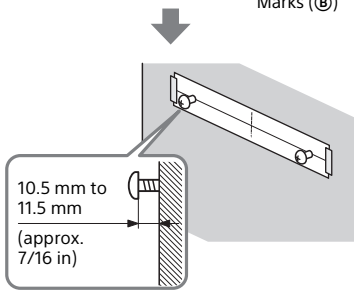

**4 Remove WALL MOUNT TEMPLATE.**

**5 Hang the bar speaker on the screws.**

Align the holes of the rear of the bar speaker with the screws, then hang the bar speaker on the two screws.

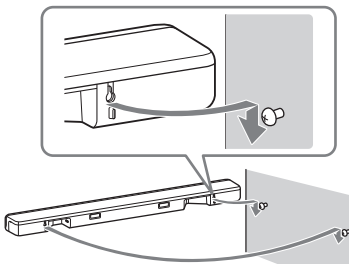

## Connecting the Subwoofer

### Connecting the Subwoofer Automatically

The subwoofer is connected to the system automatically when they are turned on.

For details, refer to Startup Guide (separate document) for the subwoofer connection.

### Connecting the Subwoofer Manually

If you cannot connect the subwoofer to the system, or you use multiple wireless products and want to specify the wireless connection to link the system to the subwoofer, perform the manual connection.

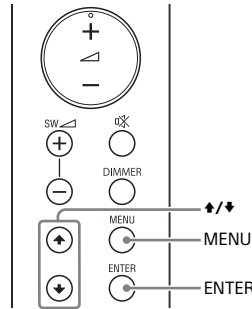
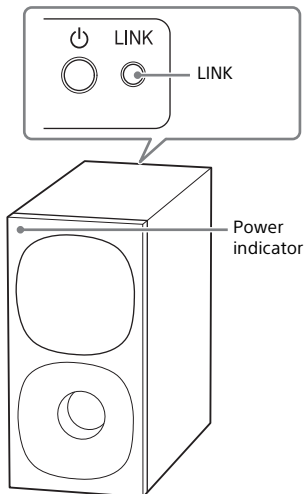

- 1 Press MENU.**  
The setting menu appears in the front panel display.
- 2 Press  $\uparrow/\downarrow$  to select [SPEAKER], then press ENTER.**
- 3 Press  $\uparrow/\downarrow$  to select [LINK], then press ENTER.**
- 4 Press  $\uparrow/\downarrow$  to select [START], then press ENTER.**  
[LINK] flashes in the front panel display.  
To cancel the manual link, select [CANCEL].
- 5 Press LINK on the subwoofer.**  
The manual link starts.  
The power indicator of the subwoofer flashes quickly in green.
- 6 When [DONE] appears in the front panel display, press MENU.**  
The link is established and the power indicator of the subwoofer lights in green.

#### Note

If [ERROR] flashes twice in the front panel display, the connection of the subwoofer is not established. Perform the manual connection again.

## When the TV Remote Control does not Work

When the bar speaker obstructs the remote control sensor of the TV, the TV remote control may not work. In that case, enable the IR repeater function of the system.

You can control the TV with the TV remote control by sending the remote signal from the rear of the bar speaker.

- Even if [IR REPEATER] is set to [ON], this function may not work depending on your TV. Also, the remote controls of other devices such as an air conditioner may not work correctly. In this case, change the installation position of the system or TV.

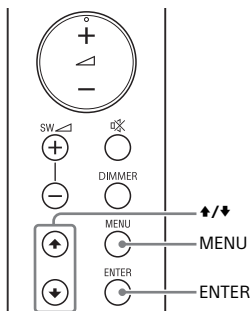

- 1 Press MENU.**  
The setting menu appears in the front panel display.
- 2 Press  $\updownarrow$  to select [SYSTEM], then press ENTER.**
- 3 Press  $\updownarrow$  to select [IR REPEATER], then press ENTER.**
- 4 Select [ON].**

### Notes

- Be sure to check that the TV remote control cannot control the TV, and then set [IR REPEATER] to [ON]. If it is set to [ON] when the remote control can control the TV, appropriate operation may not be obtained because of the interference between the direct command from the remote control and command via the bar speaker.



## Connecting to a TV or AV Device

### Connecting to a TV or AV Device with the HDMI Cable

#### To connect a 4K TV or 4K devices

See "Connecting a 4K TV and 4K Devices" (page 20).

#### To connect a TV compatible with eARC

For the connection, refer to Startup Guide (separate document). For the settings, see "[eARC]" (page 36).

To connect to a TV other than the above, refer to Startup Guide (separate document).

### Connecting Sony TV with the BLUETOOTH Function Wirelessly

When using Sony TV\* with the BLUETOOTH function, you can listen to sound of the TV or device that is connected to the TV by connecting the system and TV wirelessly.

\* The TV needs to be compatible with A2DP (Advanced Audio Distribution Profile) of the BLUETOOTH profile.

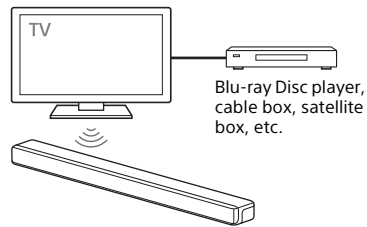

### Listening to TV Sound by Connecting the System and TV Wirelessly

To connect the system and TV wirelessly, you need to perform pairing of the system and TV by using the BLUETOOTH function.

Pairing is the process required to mutually register the information on BLUETOOTH devices to be connected wirelessly in advance.

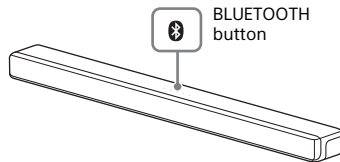
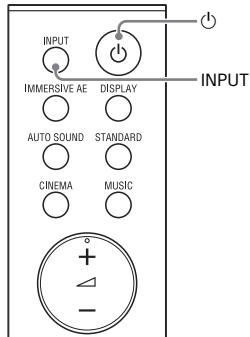

- 1 Turn on the TV.**
- 2 Turn on the system.**
- 3 Press and hold the BLUETOOTH button on the bar speaker and INPUT on the remote control simultaneously for 5 seconds.**

The system enters the pairing mode, [PAIRING] appears in the front panel display, and the BLUETOOTH indicator flashes twice repeatedly.

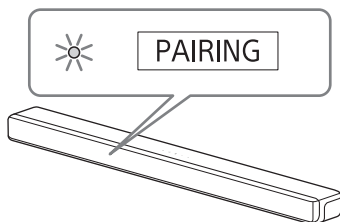

- 4 On the TV, search the system by performing the pairing operation.**

The list of the BLUETOOTH devices that are searched appears on the TV screen.

For the operation method to pair the BLUETOOTH device to the TV, refer to the operating instructions of the TV.

- 5 Pair the system and TV by selecting "HT-G700" from the list on the TV screen.**

- 6 Make sure that the BLUETOOTH indicator on the bar speaker lights in blue and [TV-BT] appears in the front panel display.**

A connection between the system and TV has been established.

- 7 Select the program or input of the device by using the TV remote control.**

The sound of the displayed image on the TV screen is output from the system.

- 8 Adjust the volume of the system by using the TV remote control.**

When pressing the muting button on the TV remote control, the sound is muted temporarily.

#### Notes

- If the TV sound is not output from the system, select the TV input by pressing INPUT and check the status of the front panel display and indicators on the bar speaker.
  - [TV-BT] appears in the front panel display: The system and TV are connected and TV sound is output from the system.
  - The BLUETOOTH indicator flashes twice repeatedly and [PAIRING] appears in the front panel display: Perform pairing on the TV.
  - [TV] appears in the front panel display: Perform steps from the start.

- When you connect the system and TV with the HDMI cable (supplied), the BLUETOOTH connection is canceled. To connect the system and TV with the BLUETOOTH function again, disconnect the HDMI cable, then perform the connecting operation from the start.
- While the system is connecting the TV with the BLUETOOTH function and [AUTO SOUND] is selected for the sound mode, [STANDARD] is selected for the sound mode.

## Listening to Sound of the Paired TV

You can turn the system on/off, adjust the volume, and mute the sound by using the TV remote control when connecting the TV to the system wirelessly.

### 1 Turn on the TV with the TV remote control.

The system is turned on by interlocking with the TV power, and TV sound is output from the system.

### 2 Select the program or input of the device by using the TV remote control.

The sound of the displayed image on the TV screen is output from the system.

### 3 Adjust the volume of the system by using the TV remote control.

When pressing the muting button on the TV remote control, the sound is muted temporarily.

#### Note

If you select the input other than TV on the remote control supplied with the system, the TV sound is not output from the system. To output the TV sound, select the TV input by pressing INPUT.

#### Tip

When the TV is turned off, the system is also turned off by interlocking with the TV power.

## Connecting a 4K TV and 4K Devices

All HDMI jacks on the system support 4K video format, HDCP2.2, and HDCP2.3 (High-bandwidth Digital Content Protection System Revision 2.2 and 2.3). To watch 4K video content, connect the 4K TV and 4K devices to the system via an HDCP2.2 or HDCP2.3-compatible HDMI jack on each device. You can only view 4K video content through the HDCP2.2 or HDCP2.3-compatible HDMI jack connection.

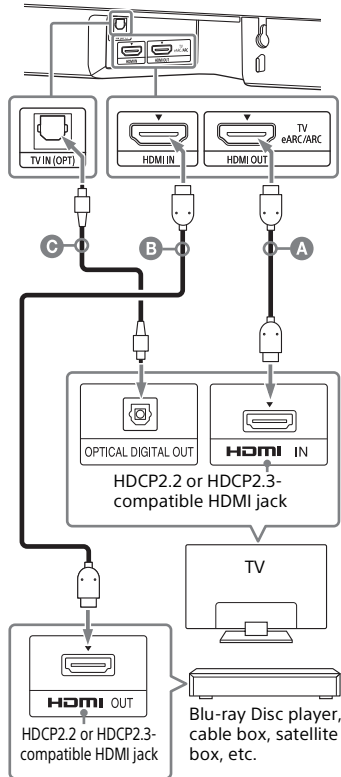

**A** HDMI cable (supplied)

**B** HDMI cable (not supplied)

Use an HDMI cable which supports the 4K video format that you want to watch. For details, see "Supported HDMI Video Formats" (page 51).

**C** Optical digital cable (not supplied)

### 1 Check which HDMI IN jack on your TV is compatible with HDCP2.2 or HDCP2.3.

Refer to the operating instructions of the TV.

### 2 Connect the HDCP2.2 or HDCP2.3-compatible HDMI IN jack on the TV and HDMI OUT (TV eARC/ARC) jack on the system with the HDMI cable (supplied).

If the HDCP2.2 or HDCP2.3-compatible HDMI IN jack on the TV supports eARC or ARC, TV connection is complete. Go to step 4.

### 3 If the HDCP2.2 or HDCP2.3-compatible HDMI IN jack on the TV does not support eARC or ARC, connect the optical digital output jack on the TV and the TV IN (OPT) jack on the system with an optical digital cable (not supplied).

When connecting the TV and system with the HDMI cable (supplied) only, the TV sound is not output from the system. Connect an optical digital cable (not supplied). TV connection is complete.

### 4 Connect the HDCP2.2 or HDCP2.3-compatible HDMI OUT jack of the 4K device and HDMI IN jack of the system with an HDMI cable (not supplied).

Refer to the operating instructions of the 4K device to check that the HDMI OUT jack of the 4K device is compatible with HDCP2.2 or HDCP2.3. 4K device connection is complete.

### 5 Turn on the TV.

## 6 Turn on the system.

### Tip

4K content can be watched by a device compatible with HDCP2.2 or HDCP2.3 even though devices with different versions (ex. TV compatible with HDCP2.2 and 4K device compatible with HDCP2.3) are connected.

- If the picture is not displayed while [FORMAT] is set to [ENHANCED], set it to [STANDARD].

## Setting the HDMI Signal Format to Watch 4K Video Content

To watch 4K video content, select the appropriate setting for the connected 4K TV and 4K device.

### 1 Press MENU.

The setting menu appears in the front panel display.

### 2 Press $\blacktriangle/\blacktriangledown$ to select [HDMI], then press ENTER.

### 3 Press $\blacktriangle/\blacktriangledown$ to select [FORMAT], then press ENTER.

### 4 Press $\blacktriangle/\blacktriangledown$ repeatedly to select the setting you want.

- **[ENHANCED]**: Select when both the connected TV and devices support high bandwidth video formats such as 4K 60p 4:4:4, etc.
- **[STANDARD]**: Select when the connected TV and devices support standard bandwidth video formats.

For the relation of this setting, supported video format signals, and HDMI cables to be used, see "Supported HDMI Video Formats" (page 51).

### Notes

- Depending on the TV, the TV setting for HDMI output may be required. Refer to the operating instructions of the TV.

## Listening to Music/Sound

# Listening to a TV and Other Devices

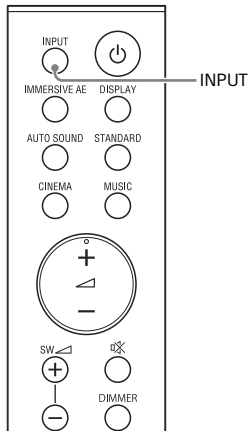

## 1 Press INPUT repeatedly.

Each time you press INPUT, the selected input appears in the front panel display cyclically as follows.  
[TV] → [HDMI] → [BT]

### TV input

- TV that is connected to the TV IN (OPT) jack on the system
- TV compatible with the eARC or ARC function that is connected to the HDMI OUT (TV eARC/ARC) jack on the system

When you connect the TV to both the HDMI OUT (TV eARC/ARC) and TV IN (OPT) jacks, the input of the HDMI OUT (TV eARC/ARC) jack has priority if the TV audio signal is input with the ARC or eARC function.

### HDMI input

Device that is connected to the HDMI IN jack on the bar speaker

### BT input

BLUETOOTH device that supports A2DP  
For details, see "Listening to Music/Sound with the BLUETOOTH® Function" (page 24).

## 2 Adjust the volume (page 23).

### Tip

You can also select the input by pressing  on the bar speaker.

## Adjusting the Volume

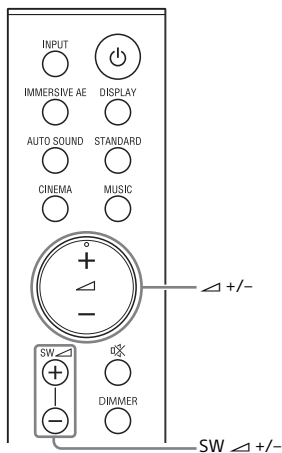

### To adjust the system volume

Press +/-.  
The volume level appears in the front panel display.

### To adjust the subwoofer volume

Press SW +/- (subwoofer volume) +/-.  
The volume level appears in the front panel display.

The subwoofer is designed for playback of bass or low frequency sound.

#### Notes

- When the input source does not contain much bass sound, such as in TV programs, the bass sound from the subwoofer may be difficult to hear.
- SW +/- does not work when the subwoofer is not connected.

## Enjoying Multiplex Broadcast Sound (AUDIO)

You can enjoy multiplex broadcast sound when the system receives a Dolby Digital multiplex broadcast signal.

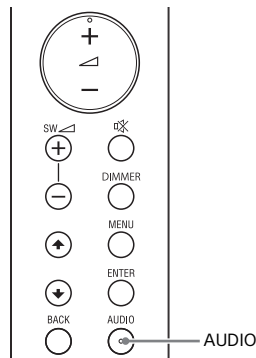

### 1 Press AUDIO.

The audio signal appears in the front panel display.

### 2 Press the button repeatedly to select the desired audio signal.

Audio signal	Explanation
[MAIN]	Sound of the main language will be output.
[SUB]	Sound of the sub language will be output.
[M/S]	Mixed sound of both the main and sub languages will be output.

#### Notes

- To receive a Dolby Digital signal, you need to connect the TV that is compatible with eARC or ARC (page 32) to the HDMI OUT (TV eARC/ARC) jack with the HDMI cable (supplied), or other devices to the

HDMI IN jack with an HDMI cable (not supplied).

- If your TV's HDMI IN jack is not compatible with eARC or ARC (page 32), connect the TV to the TV IN (OPT) jack with an optical digital cable (not supplied) to receive a Dolby Digital signal.

## Listening to Music/ Sound with the BLUETOOTH® Function

You can listen to music stored on a mobile device such as a smartphone or tablet via a wireless connection by connecting the system and mobile device with the BLUETOOTH function. When connecting to the mobile device with the BLUETOOTH function, you can operate by simply using the supplied remote control without turning the TV on.

### Listening to Music by Pairing the Mobile Device that is Connected for the First Time

To use the BLUETOOTH function, you need to perform pairing of the system and mobile device in advance.

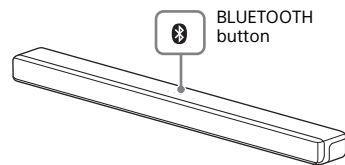

- 1 Press and hold the BLUETOOTH button on the bar speaker for 2 seconds.**

The system enters the pairing mode, [PAIRING] appears in the front panel display, and the BLUETOOTH indicator flashes twice repeatedly.



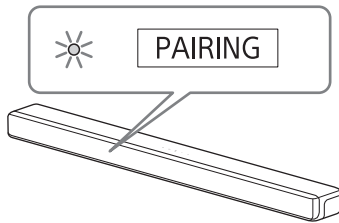

## 2 On the mobile device, search the system by performing the pairing operation.

The list of the BLUETOOTH devices that are searched appears on the screen of the mobile device. For the operation method to pair the BLUETOOTH device to the mobile device, refer to the operating instructions of the mobile device.

## 3 Pair the system and mobile device by selecting "HT-G700" from the list on the screen of the mobile device.

If a Passkey is requested, enter "0000."

## 4 Make sure that the BLUETOOTH indicator on the bar speaker lights in blue.

A connection between the system and mobile device has been established.

## 5 Start audio playback with the music app on the connected mobile device.

Sound is output from the system.

## 6 Adjust the volume (page 23).

### To check the connection status of the BLUETOOTH function

Status	BLUETOOTH indicator
<b>During pairing standby status</b>	Flashes twice in blue repeatedly
<b>Connection is being attempted</b>	Flashes slowly in blue repeatedly
<b>Connection has been established</b>	Lights in blue

#### Note

You can pair the BLUETOOTH devices up to the following number.

- Mobile devices: 9
- Sony TV with the BLUETOOTH function: 1

If a new device is paired after pairing the above number of devices, the oldest connected device will be replaced by the new one.

#### Tips

- If there is no mobile device that has been paired (ex. immediately after the purchase of the system), the system goes into pairing mode simply by changing the input to the BT input.
- Perform pairing for the second and subsequent mobile devices.

## Listening to Music from the Paired Device

### Tip

When the connection is not established, select "HT-G700" on the mobile device.

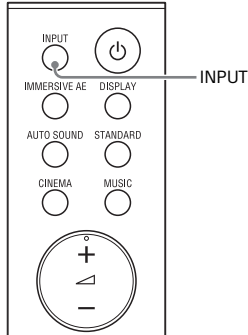

- 1 Turn the BLUETOOTH function of the mobile device to on.**
- 2 Press INPUT repeatedly to select [BT].**  
The system automatically reconnects to the mobile device it was most recently connected to.
- 3 Make sure that the BLUETOOTH indicator on the bar speaker lights in blue.**  
A connection between the system and mobile device has been established.
- 4 Start audio playback with the music app on the connected mobile device.**  
Sound is output from the system.
- 5 Adjust the volume (page 23).**

### To disconnect the mobile device

Perform any of the following items.

- Disable the BLUETOOTH function on the mobile device.
- Set [BT] - [POWER] to [OFF] (page 37).
- Turn off the system or mobile device.

## Adjusting the Sound Quality

# Enjoying Immersive Surround Experience (IMMERSIVE AE)

You can feel immersed by the sound from not only the horizontal direction, but also from the upward direction by using Vertical Surround Engine\* effectively for sound modes (page 28). This function also works for the 2.0 channel signal such as a TV program.

\* Vertical Surround Engine is a highly precise digital sound field processing technology developed by Sony that produces the sound field in the height direction virtually in addition to a sound field in the horizontal direction by only using front speakers and without using top speakers.

You do not need to install speakers on a ceiling and you can enjoy the sound with rich presence regardless of the ceiling height. Also, this function is hardly affected by the shape of a room because it does not use the sound reflected from a wall and enables improved surround playback.

### 1 Press IMMERSIVE AE.

The vertical surround setting appears in the front panel display.

### 2 Press the button repeatedly to select the setting.

Mode	Explanation
[IAE.ON]	Activates the vertical surround function.
[IAE.OFF]	Deactivates the vertical surround function.

#### Notes

- The surround effect from all directions differs depending on the sound source.
- The vertical surround setting does not appear on the TV screen while the TV input is selected.
- A time gap between the sound and picture may occur depending on the sound source. If your TV has a function that delays the image, use it for adjustment.

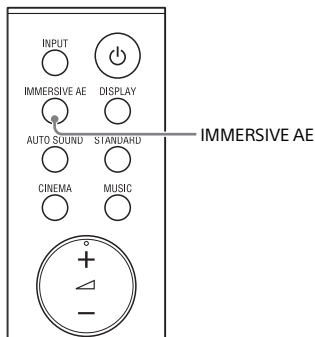

## Setting the Sound Effect that is Tailored to Sound Sources (Sound Mode)

You can easily enjoy pre-programmed sound effects that are tailored to different kinds of sound sources.

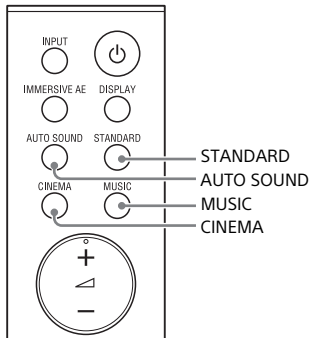

- 1 Press **AUTO SOUND**, **STANDARD**, **CINEMA**, or **MUSIC** to select the sound mode.

The selected sound mode appears in the front panel display.

Sound mode	Explanation
[ <b>AUTO SOUND</b> ]	The appropriate sound setting is automatically selected for the sound source.
[ <b>STANDARD</b> ]	The sound of a TV program can be heard clearly.

Sound mode	Explanation
[ <b>CINEMA</b> ]	You feel immersed by the sound that travels behind you and surrounds your entire body. This mode is suitable for watching movies.
[ <b>MUSIC</b> ]	Vividness and glossiness of the sound are expressed in detail. This mode is suitable for enjoying music in a way that moves you.

### Notes

- The sound mode function is disabled when the [AUDIO] - [EFFECT] setting is set to a setting other than [SOUND MODE ON] (page 35).
- The sound mode does not appear on the TV screen while the TV input is selected.
- A time gap between the sound and picture may occur depending on the sound source. If your TV has a function that delays the image, use it for adjustment.

## Making Dialogs Clearer (VOICE)

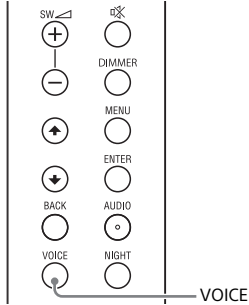

### 1 Press VOICE.

The voice mode appears in the front panel display.

### 2 Press the button repeatedly to select the voice mode.

Mode	Explanation
[Vo.ON]	Dialog is easily heard by enhancing dialog range.
[Vo.OFF]	Standard

## Enjoying Clear Sound with Low Volume at Midnight (NIGHT)

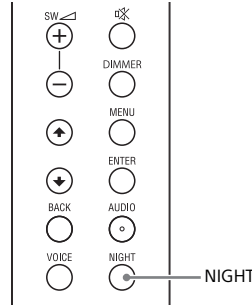

### 1 Press NIGHT.

The night mode appears in the front panel display.

### 2 Press the button repeatedly to select the night mode.

Mode	Explanation
[N.ON]	Outputs the sound at low volume with minimum loss of fidelity and clarity of dialog.
[N.OFF]	Standard

#### Note

When you turn the system off, this setting is set to [N.OFF] automatically.

## Checking the Current Sound Settings

You can check the current settings of the sound mode, IMMERSIVE AE, voice mode, night mode, and current stream information.

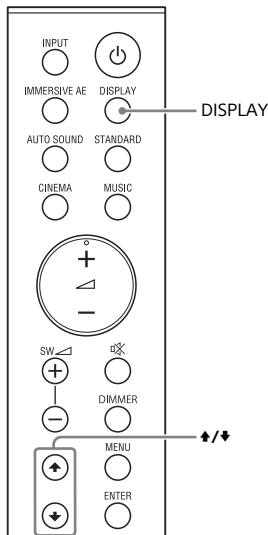

### 1 Press DISPLAY.

The current setting appears in the front panel display.

### 2 Press $\updownarrow$ repeatedly to select the item you want.

The current setting appears in the following order.

Sound mode → IMMERSIVE AE →

Voice mode → Night mode →

Stream information

The current setting appears in the reverse order by pressing  $\updownarrow$ .

## Using the Control for HDMI Function

### Using the Control for HDMI Function

Connecting a device such as a TV or Blu-ray Disc player compatible with the Control for HDMI function\* using an HDMI cable enables you to easily operate the device by a TV remote control.

The following functions can be used with the Control for HDMI function.

- System Power Off function
- System Audio Control function
- eARC/ARC (Enhanced Audio Return Channel/Audio Return Channel)
- One-Touch Play function
- HDMI Standby Through power saving setting

#### Note

These functions may work with devices other than those manufactured by Sony, but operation is not guaranteed.

\* Control for HDMI is a standard used by CEC (Consumer Electronics Control) for allowing HDMI (High-Definition Multimedia Interface) devices to control each other.

### Preparing to Use the Control for HDMI Function

Set [HDMI] - [CONTROL FOR HDMI] is set to [ON] (page 36). The default setting is [ON].

Enable the Control for HDMI function settings for the TV and other device connected to the system.

#### Tip

If you enable the Control for HDMI ("BRAVIA" sync) function when using a TV manufactured by Sony, the Control for HDMI function of the system is also enabled automatically.

When the Control for HDMI settings are changed to on, [DONE] appears in the front panel display.

### System Power Off Function

When you turn off the TV, the system will turn off automatically.

#### Note

The connected device may not turn off depending on the status of the device.

### System Audio Control Function

If you turn on the system while you are watching the TV, the TV sound will be output from the speakers of the system. The volume of the system can be adjusted using the TV remote control. When you turn on the TV, the system is turned on automatically and the TV sound is output from the speakers of the system.

Operations can also be made by the TV's menu. For details, refer to the operating instructions of your TV.

#### Notes

- The number for the system's volume level is displayed on the TV screen depending on the TV. The volume number displayed on the TV may differ from the number on the front panel display of the system.
- Depending on the settings of the TV, the System Audio Control function may not be available. For details, refer to the operating instructions of your TV.
- Depending on the TV, if the TV sound was output from the speakers of the TV the previous time you watched the TV, the system may not turn on by interlocking

with the TV power even if the TV is turned on.

### eARC/ARC (Enhanced Audio Return Channel/Audio Return Channel)

If the system is connected to a TV's HDMI IN jack compatible with eARC or ARC, you can listen to TV sound from the speakers of the system without connecting an optical digital cable. On the system, set [HDMI] - [EARC] to [ON] (page 36). The default setting is [ON].

#### Notes

- Enable the eARC or ARC function of the TV. For details, refer to the operating instructions of the TV.
- If the TV is not compatible with eARC or ARC, an optical digital cable (not supplied) needs to be connected (refer to the supplied Startup Guide).

### One-Touch Play Function

When you play content on a device (Blu-ray Disc player, "PlayStation®4," etc.) connected to the system, the system and TV are turned on automatically, the input of the system is switched to the HDMI input, and sound is output from the speakers of the system.

#### Notes

- If [HDMI] - [STANDBY THROUGH] is set to [ON] or [AUTO] and the TV sound was output from the speakers of the TV the previous time you watched the TV, the system may not turn on and the sound and picture may be output from the TV even if device content is played (page 36).
- Depending on the TV, the beginning part of content being played may not play correctly.

### HDMI Standby Through Power Saving Setting

HDMI Standby Through is a function that allows you to enjoy the sound and picture of a connected device without turning on the system.

You can reduce system standby power consumption by setting [HDMI] - [STANDBY THROUGH] to [AUTO] (page 36). The default setting is [AUTO].

#### Note

If the picture of a device connected to the system is not displayed on the TV, set [HDMI] - [STANDBY THROUGH] to [ON]. If you connect a TV other than those manufactured by Sony, we recommend you to select this setting.



## Using the “BRAVIA” Sync Function

In addition to the Control for HDMI function, you can also use the “BRAVIA” sync function such as the Sound mode/Scene Select function.

### Note

This function is proprietary functions of Sony. This function cannot operate with products other than those manufactured by Sony.

### Sound mode/Scene Select Function

The sound mode of the system is automatically switched according to the setting of the TV’s Scene Select function or sound mode. For details, refer to the operating instructions of your TV. Set the sound mode to [AUTO SOUND] (page 28).

## Changing the Settings

### Using the Setting Menu

You can set the following items with the setting menu. Your settings are retained even if you disconnect the AC power cord (mains lead).

**1 Press MENU to turn on the setting menu in the front panel display.**

**2 Press  $\blacktriangle$ / $\blacktriangledown$  repeatedly to select the item, then press ENTER.**

You can select the following items.

- [SPEAKER] (Speaker settings) (page 34)
- [AUDIO] (Audio settings) (page 35)
- [HDMI] (HDMI settings) (page 36)
- [BT] (BLUETOOTH settings) (page 37)
- [SYSTEM] (System settings) (page 37)
- [RESET] (Resetting the system) (page 37)
- [UPDATE] (Updating the system) (page 38)

**3 Press  $\blacktriangle$ / $\blacktriangledown$  repeatedly to select the setting, then press ENTER.**

To return to the upper layer, press BACK.

**4 Press MENU to turn off the setting menu.**

#### Setting menu items

Items	Function
[SPEAKER] (Speaker settings)	<ul style="list-style-type: none"> <li>• [LINK] (Link mode)</li> <li>• [START]: Performs the manual connection of the subwoofer to the system. For details, see "Connecting the Subwoofer" (page 15).</li> <li>• [CANCEL]: Cancel the manual connection of the subwoofer.</li> </ul>
[SUBWOOFER INFO] (Subwoofer version information)	<ul style="list-style-type: none"> <li>Shows the version information of the subwoofer.</li> <li>• [LATEST]: The subwoofer is the latest version.</li> <li>• [PLEASE UPDATE]: The subwoofer is not the latest version.</li> <li>• [NOT CONNECTED]: The subwoofer is not connected to the system.</li> </ul>

Items	Function
<b>[AUDIO] (Audio settings)</b>	<p>[DRC] (Audio DRC) You can compress the dynamic range of the sound track.</p> <p>[AUTO]: Automatically compresses sound encoded in Dolby TrueHD.</p> <p>[ON]: Reproduces the dolby and DTS sound track with the kind of dynamic range that the recording engineer intended.</p> <p>[OFF]: No compression of dynamic range.</p>
[SYNC] (A/V Sync)	<p>When the sound does not match the pictures on the TV screen, you can adjust the delay between the picture and sound. You can adjust from 0 msec to 120 msec in 40 msec increments.</p> <p>The default setting is [0ms].</p>
[DIALOG] (DTS Dialog Control)	<p>By adjusting the dialog volume, you can easily listen to dialog since it stands out from the ambient noise. This function works while playing content that is compatible with the DTS:X dialog control function.</p> <p>You can adjust from 0 dB to 6 dB in 1 dB increments.</p> <p>The default setting is [0dB].</p>
[EFFECT] (Sound Effect)	<p>You can select sound effects such as the sound mode.</p> <ul style="list-style-type: none"> <li>• [SOUND MODE ON]: Vertical Surround Engine enhances the surround and height speaker channels to create an immersive and enveloping virtual surround effect such as sound mode (page 28) and vertical surround (page 27).</li> <li>• [DOLBY SPEAKER VIRTUALIZER]: Dolby Speaker Virtualizer enhances the surround and height speaker channels to create an immersive and enveloping virtual surround effect when you play Dolby format. Disables sound effects other than Dolby format.</li> <li>• [DTS VITRUAL:X]: DTS Virtual:X is enabled. DTS Virtual:X Technology in the system puts you in the middle of multi speaker.</li> <li>• [OFF]: Disables the sound effects. Select this when you do not want to set the upper limit of sampling frequency.</li> </ul>

Items	Function
[HDMI] (HDMI settings)	<p>[CONTROL FOR HDMI]</p> <ul style="list-style-type: none"> <li>• [ON]: The Control for HDMI function is enabled. Devices connected with an HDMI cable can control each other.</li> <li>• [OFF]: Off</li> </ul> <hr/> <p>[STANDBY THROUGH]</p> <p>This function is available when you set [CONTROL FOR HDMI] to [ON].</p> <ul style="list-style-type: none"> <li>• [AUTO]: Signals are output from the system's HDMI OUT (TV eARC/ARC) jack when the TV is turned on while the system is not turned on. The system standby power consumption can be reduced more than when set to [ON] by turning off the connected TV.</li> <li>• [ON]: Signals are always output from the system's HDMI OUT (TV eARC/ARC) jack when the system is not turned on. If you connect a TV other than those manufactured by Sony, we recommend that you select this setting.</li> <li>• [OFF]: Signals are not output from the system's HDMI OUT (TV eARC/ARC) jack when the system is not turned on. Turn on the system to enjoy on the TV content of a device connected to the system. The system standby power consumption can be reduced more than when set to [ON].</li> </ul> <hr/> <p>[TV AUDIO]</p> <p>You can set the playback sound that is input from whether an HDMI cable or optical digital cable.</p> <ul style="list-style-type: none"> <li>• [AUTO]: Plays the sound by selecting the cable for the TV input automatically depending on which audio signal is input first when you connect both an HDMI cable and optical digital cable. When you connect either HDMI cable or optical digital cable, the system plays by selecting the connected cable for the TV input.</li> <li>• [OPTICAL]: Plays the sound from the TV IN(OPT) jack for the TV input.</li> </ul> <hr/> <p>[EARC]</p> <p>You can transfer the signals of the object audio content, such as Dolby Atmos - Dolby TrueHD and DTS:X, or multi-channel LPCM content using an HDMI cable by connecting the system and TV compatible with eARC.</p> <ul style="list-style-type: none"> <li>• [ON]: Enables the eARC function. Use this setting when the system is connected to a TV compatible with eARC.</li> <li>• [OFF]: Use this setting when the system is not connected to a TV compatible with eARC.</li> </ul> <p><b>Note</b> When [EARC] is set to [ON], make sure of the eARC setting of the connected TV. For details, refer to the operating instructions of the TV.</p> <hr/> <p>[FORMAT] (HDMI Signal Format)</p> <p>You can select the HDMI signal format for the input signal. For details, see "Setting the HDMI Signal Format to Watch 4K Video Content" (page 21).</p>

Items	Function	
<b>[BT] (BLUETOOTH settings)</b>	[POWER] (BLUETOOTH Power)	<p>You can turn the BLUETOOTH function on or off.</p> <ul style="list-style-type: none"> <li>• <b>[ON]</b>: Turns the BLUETOOTH function on.</li> <li>• <b>[OFF]</b>: Turns the BLUETOOTH function off.</li> </ul> <p><b>Note</b> When the BLUETOOTH function is set to off, the BLUETOOTH input is skipped while selecting input by pressing INPUT.</p>
	[STANDBY]	<p>When the system has pairing information, you can turn the system on and listen to music from a BLUETOOTH device, even when the system is in standby mode, by setting the BLUETOOTH standby mode to on.</p> <ul style="list-style-type: none"> <li>• <b>[ON]</b>: BLUETOOTH standby mode is enabled.</li> <li>• <b>[OFF]</b>: BLUETOOTH standby mode is disabled.</li> </ul> <p><b>Note</b> While the BLUETOOTH standby mode is on, standby power consumption increases.</p>
	[AAC CODEC]	<p>You can enjoy high-quality sound if AAC is enabled and your device supports AAC.</p> <ul style="list-style-type: none"> <li>• <b>[ON]</b>: Enables AAC codec.</li> <li>• <b>[OFF]</b>: Disables AAC codec.</li> </ul>
<b>[SYSTEM] (System settings)</b>	[IR REPEATER]	<ul style="list-style-type: none"> <li>• <b>[ON]</b>: Remote signals for the TV are sent from the rear of the bar speaker.</li> <li>• <b>[OFF]</b>: Turns off the function.</li> </ul> <p>For details, see "When the TV Remote Control does not Work" (page 16).</p>
	[AUTO STANDBY]	<ul style="list-style-type: none"> <li>• <b>[ON]</b>: Turns on the auto standby function. When you do not operate the system for about 20 minutes, the system enters standby mode automatically.</li> <li>• <b>[OFF]</b>: Off.</li> </ul>
	[VERSION] (Version information)	<p>The current firmware version information of the system appears in the front panel display.</p>
<b>[RESET] (Resetting the system)</b>	[ALL RESET]	<p>You can reset the system settings to the factory default. For details, see "Resetting the system" (page 47).</p>

Items		Function
<b>[UPDATE]</b> (Updating the system)	[START]	<p>Select this to start the software update after connecting the USB memory on which the software update file is stored to the system. For information about the software update, visit the following website:  <a href="https://www.sony.com/am/support">https://www.sony.com/am/support</a></p> <p><b>Notes</b></p> <ul style="list-style-type: none"> <li>• Before updating, make sure that the subwoofer is turned on and connected to the system.</li> <li>• You can update the software of the system by pressing and holding  and the BLUETOOTH button on the bar speaker for 7 seconds.</li> </ul> <p><b>If the USB device is not recognized</b></p> <ul style="list-style-type: none"> <li>• Try the following:             <ol style="list-style-type: none"> <li>① Turn the system off.</li> <li>② Remove and reconnect the USB device.</li> <li>③ Turn the system on.</li> </ol> </li> <li>• Make sure that the USB device is securely connected to the UPDATE port.</li> <li>• Check to see if the USB device or a cable is damaged.</li> </ul>
[CANCEL]		Cancels the software update.

## Changing the Brightness of the Front Panel Display and Indicators (DIMMER)

about 10 seconds. However, in some cases, the front panel display may not turn off. In this case, the brightness of the front panel display is same as [DARK].

You can change the brightness of the followings.

- Front panel display
- BLUETOOTH indicator
- Power indicator on the subwoofer.

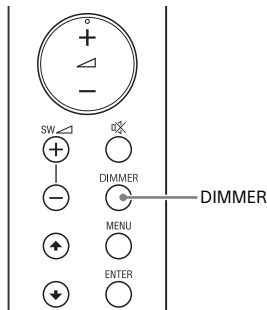

### 1 Press DIMMER.

The display mode appears in the front panel display.

### 2 Press the button repeatedly to select the desired display mode.

Mode	Explanation
[BRIGHT]	The front panel display and BLUETOOTH indicator light brightly.
[DARK]	The front panel display and BLUETOOTH indicator light darkly.
[OFF]	The front panel display is turned off.

#### Note

The front panel display is turned off when [OFF] is selected. It turns on automatically when you press any button, then turns off again if you do not operate the system for

---

## Saving Power in Standby Mode

Check that you have made the following settings:

- [SYSTEM] - [AUTO STANDBY] is set to [OFF] (page 37). (The default setting is [OFF].)
- [BT] - [STANDBY] is set to [OFF] (page 37). (The default setting is [ON].)

40<sup>US</sup>



## Troubleshooting

### Troubleshooting

If the system does not work properly, handle it in the following order.

- 1 Search for the cause and solution of the issue using this troubleshooting.
- 2 Reset the system.  
All the settings of the system return to their initial status. For details, see *Resetting the system* (page 47).

Should any problems persist, consult your nearest Sony dealer.  
Be sure to bring your bar speaker and subwoofer, even if it seems as though only one has a problem, when you request to repair.

## Power

### The system does not power up.

- Check that the AC power cord (mains lead) is connected securely.
- Disconnect the AC power cord (mains lead) from the wall outlet (mains), and then reconnect after several minutes.

### The system is turned off automatically.

- The auto standby function is working. Set [SYSTEM] - [AUTO STANDBY] to [OFF] (page 37).

### The system does not turn on even when the TV is turned on.

- Set [HDMI] - [CONTROL FOR HDMI] to [ON] (page 36). The TV must support the Control for HDMI function. For details, refer to the operating instructions of your TV.
- Check the speaker settings of the TV. The system power syncs with the

speaker settings of the TV. For details, refer to the operating instructions of your TV.

- Depending on the TV, if the sound was output from the speakers of the TV the previous time, the system may not turn on by interlocking with the TV power even when the TV is turned on.

### The system turns off when the TV is turned off.

- Check the setting of [HDMI] - [CONTROL FOR HDMI] (page 36). When the Control for HDMI function is set to on and the input of the system is the TV or HDMI input, the system turns off automatically when you turn off the TV.

### The system does not turn off even when the TV is turned off.

- Check the setting of [HDMI] - [CONTROL FOR HDMI] (page 36). To turn the system off automatically by interlocking with the TV power, set the Control for HDMI function to on. This function works only if the input of the system is the TV or HDMI input. The system does not turn off automatically while selecting the BLUETOOTH input. The TV must support the Control for HDMI function. For details, refer to the operating instructions of your TV.

### The system cannot be turned off.

- The system may be in demo mode. To cancel demo mode, reset the system. Press and hold  (power) and - (volume) on the bar speaker for more than 5 seconds (page 47).

## Picture

### There is no picture or the picture is not output correctly.

- Select the appropriate input (page 22).
- When there is no picture while the TV input is selected, select the TV

channel that you want using the TV remote control.

- When there is no picture while the HDMI input is selected, press the playback button of the connected device.
- Disconnect the HDMI cable, then connect it again. Make sure that the cable is firmly inserted.
- When there is no picture from the connected device or the picture from the connected device is not output correctly, set [HDMI] - [FORMAT] to [STANDARD] (page 36). Some pictures of an old type device may not displayed correctly while [HDMI] - [FORMAT] is set to [ENHANCED].
- If no picture appears while connecting the device with the HDMI cable, make sure that the device is connected to the HDMI IN jack and the TV is connected to the HDMI OUT (TV eARC/ARC) jack.
- The system is connected to an input device that is not HDCP (High-bandwidth Digital Content Protection) compliant. In this case, check the specifications of the connected device.

### **3D content from the HDMI IN jack does not appear on the TV screen.**

- Depending on the TV or video device, 3D content may not appear. Check the supported HDMI video format (page 51).

### **4K video content from the HDMI IN jack does not appear on the TV screen.**

- Depending on the TV or the video device, 4K video content may not appear. Check the video capability and settings of your TV and video device.
- The picture may not be displayed properly if [HDMI] - [FORMAT] is set to [ENHANCED]. In this case, set it to [STANDARD] (page 36).
- Use a Premium High Speed HDMI Cable with Ethernet that supports 18

Gbps or High Speed HDMI Cable with Ethernet (page 51).

- If the system is connected to the HDMI jack that is not compatible with HDCP2.2 or HDCP2.3, [ERROR: TV DOES NOT SUPPORT HDCP2.2 or 2.3] appears in the front panel display. Connect to the HDMI jack compatible with HDCP2.2 or HDCP2.3 of the 4K TV or 4K device.

### **An image is not displayed on the entire TV screen.**

- The aspect ratio on the media is fixed.

### **Picture and sound of the device that is connected to the system are not output from the TV when the system is not turned on.**

- Set [HDMI] - [STANDBY THROUGH] to [AUTO] or [ON] (page 36).
- Turn on the system, and then switch the input for the device playing.

### **HDR contents cannot show as high-dynamic range.**

- Check the settings of the TV and connected device. For details, refer to the operating instructions of your TV and the connected device.
- Some devices may convert HDR contents to SDR if the bandwidth is not enough. In that case, be sure that [HDMI] - [FORMAT] is set to [ENHANCED] (page 36) if the TV and the connected device support a bandwidth of up to 18 Gbps. When [ENHANCED] is set, be sure to use a Premium High Speed HDMI Cable with Ethernet that supports 18 Gbps (page 51).

## **Sound**

### **The system cannot connect to a TV with the BLUETOOTH function.**

- When you connect the system and TV with the HDMI cable (supplied), the BLUETOOTH connection is canceled. Disconnect the HDMI cable, then

perform the connecting operation from the start (page 17).

### **No TV sound is output from the system.**

- Check the type and connection of the HDMI cable or optical digital cable that is connected to the system and the TV (refer to the supplied Startup Guide).
- Disconnect the cables that are connected between the TV and the system, then connect them firmly again. Disconnect the AC power cords (mains leads) of the TV and the system from the AC outlets (mains), then connect them again.
- When the system and TV are connected with the HDMI cable only, check the following.
  - The HDMI jack of the connected TV is labeled with "eARC" or "ARC."
  - The Control for HDMI function of the TV is set to on.
  - The eARC or ARC function of the TV is enabled.
  - [HDMI] - [eARC] is set to [ON] (page 36).
  - [HDMI] - [CONTROL FOR HDMI] is set to [ON] (page 36).
- If your TV is not compatible with eARC, set [HDMI] - [eARC] to [OFF] (page 36).
- If your TV is not compatible with eARC or ARC, connect an optical digital cable (not supplied) (refer to the supplied Startup Guide). If the TV is not compatible with eARC or ARC, TV sound will not be output from the system even if the system is connected to the TV's HDMI IN jack.
- Press INPUT repeatedly to select the TV input (page 22).
- Increase the volume on the system or cancel muting.
- If sound of a cable box/satellite box connected to the TV is not output, connect the device to a HDMI IN jack of the system and switch input of the system to HDMI (refer to the supplied Startup Guide).

- Depending on the order in which you turn on the TV and system, the system may be muted and [MUTED] appears in the front panel display. If this happens, turn on the TV first, then the system.
- Set the speakers setting of the TV (BRAVIA) to Audio System. Refer to the operating instructions of your TV regarding how to set the TV.

### **Picture and sound of the device that is connected to the system are not output from the TV when the system is not turned on.**

- Set [HDMI] - [STANDBY THROUGH] to [AUTO] or [ON] (page 36).
- Turn on the system, and then switch the input for the device playing.

### **The sound is output from both the system and TV.**

- Mute the sound of the system or TV.

### **The output sound of the system is not the same level as that of the TV even though the values of the volume level on the system and TV are set to the same value.**

- If the Control for HDMI function is set to on, the value of the volume level on the system may appear on your TV as the TV volume. The output sound levels of the system and TV differ even though the values of the volume level on the system and TV are set to the same value. The output sound levels of the system and TV differ depending on the sound processing characteristics of each, and it is not a malfunction.

### **The sound is interrupted while watching a TV program or content on a Blu-ray Disc, etc.**

- Check the sound mode setting (page 28). If the sound mode is set to [AUTO SOUND], the sound may be interrupted when the sound mode is changed automatically according to the information of the program that is

being played. If you do not want to change the sound mode automatically, set the sound mode to a setting other than [AUTO SOUND].

#### The TV sound from the system lags behind the image.

- Set [AUDIO] - [SYNC] to [0ms] if it is set to the range between 40 msec and 120 msec (page 35).
- A time gap between the sound and picture may occur depending on the sound source. If your TV has a function that delays the image, use it for adjustment.

#### No sound or only a very low-level sound of the device connected to the system is heard.

- Press  $\blacktriangleleft$  + on the remote control and check the volume level (page 11).
- Press  $\text{Mute}$  or  $\blacktriangleleft$  + on the remote control to cancel the muting function (page 11).
- Make sure the input source is selected correctly. You should try other input sources by pressing INPUT repeatedly (page 22).
- Check that all the cables and cords of the system and connected device are firmly inserted.
- When you play content compatible with copyright protection technology (HDCP), it may not be output from the system.
- Set [HDMI] - [FORMAT] to [STANDARD] (page 36).

#### The surround effect cannot be obtained.

- Depending on the input signal and the sound mode setting, surround sound processing may not work effectively. The surround effect may be subtle, depending on the program or disc.
- To play multi-channel audio, check the digital audio output setting on the device connected to the system. For details, refer to the operating instructions supplied with the connected device.

## Subwoofer

### No sound or only a very low-level sound is heard from the subwoofer.

- Press SW  $\blacktriangleleft$  + on the remote control to increase the subwoofer volume (page 11).
- Make sure that the power indicator on the subwoofer is lit in green.
- If the power indicator on the subwoofer does not light, try the following.
  - Make sure the AC power cord (mains lead) of the subwoofer is connected properly.
  - Press  $\text{Power}$  of the subwoofer to turn on the power.
- If the power indicator on the subwoofer flashes slowly in green, or lights in red, try the following.
  - Move the subwoofer to a location near the bar speaker so that the power indicator on the subwoofer lights in green.
  - Follow the steps in “Connecting the Subwoofer” (page 15).
- If the power indicator on the subwoofer flashes in red, press  $\text{Power}$  of the subwoofer to turn off the power and check whether the ventilation holes of the subwoofer is blocked or not.
- The subwoofer is designed for playback of bass or low frequency sound. If the input sources contain very little bass sound components (i.e., a TV broadcast), the sound from the subwoofer may be difficult to hear. Play the built-in demonstration music by following the steps below and check that the sound is output from the subwoofer.
  - ① Press and hold  $\text{Mute}$  on the bar speaker for 5 seconds. The built-in demonstration music is played.
  - ② Press  $\text{Mute}$  again. The built-in demonstration music

- is canceled and the system returns to the previous status.
- Set the night mode to off (page 29).

#### **Sound skips or has noise.**

- If there is a device nearby that generates electromagnetic waves, such as a wireless LAN or a microwave oven in use, locate the system apart from it.
- If there is an obstacle between the bar speaker and the subwoofer, move or remove it.
- Do not cover the top of the bar speaker with metal objects such as TV frame, etc. Wireless functions may become unstable.
- Locate the bar speaker and the subwoofer as close as possible.
- Switch the wireless LAN frequency of any nearby wireless LAN router or PC to 5 GHz range.
- Switch the network connection of the TV or Blu-ray Disc player from wireless to wired.

### **Mobile Device Connection**

#### **Pairing cannot be achieved.**

- Bring the system and the BLUETOOTH device closer together.
- Make sure the system is not receiving interference from a wireless LAN device, other 2.4 GHz wireless devices, or a microwave oven. If a device that generates electromagnetic radiation is nearby, move the device away from the system.

#### **BLUETOOTH connection cannot be completed.**

- Make sure that the BLUETOOTH indicator on the bar speaker is lit (page 24).
- Make sure the BLUETOOTH device to be connected with is turned on and the BLUETOOTH function is enabled.
- Bring the system and the BLUETOOTH device closer together.

- Pair the system and BLUETOOTH device again. You may need to cancel the pairing with the system using your BLUETOOTH device first.
- Pairing information may be deleted. Perform pairing operation again (page 24).

#### **Sound of the connected BLUETOOTH mobile device is not output from the system.**

- Make sure that the BLUETOOTH indicator on the bar speaker is lit (page 24).
- Bring the system and the BLUETOOTH device closer together.
- If a device that generates electromagnetic radiation, such as a wireless LAN device, other BLUETOOTH devices, or a microwave oven is nearby, move the device away from the system.
- Remove any obstacle between the system and the BLUETOOTH device or move the system away from the obstacle.
- Reposition the connected BLUETOOTH device.
- Switch the wireless LAN frequency of any nearby wireless LAN router or PC to 5 GHz range.
- Increase the volume on the connected BLUETOOTH device.

### **Remote Control**

#### **The remote control of the system does not function.**

- Point the remote control at the remote control sensor on the bar speaker (page 11).
- Remove any obstacles in the path between the remote control and the system.
- Replace both batteries in the remote control with new ones, if they are weak.
- Make sure you are pressing the correct button on the remote control.

**TV remote control does not work.**

- This problem might be solved by setting [SYSTEM] - [IR REPEATER] to [ON] (page 37).

**Others****The Control for HDMI function does not work properly.**

- Check the connection with the system (refer to the supplied Startup Guide).
- Enable the Control for HDMI function on the TV. For details, refer to the operating instructions of your TV.
- Wait a while, and then try again. If you unplug the system, it will take a while before operations can be made. Wait for 15 seconds or longer, and then try again.
- Make sure the devices connected to the system support the Control for HDMI function.
- Enable the Control for HDMI function on the devices connected to the system. For details, refer to the operating instructions of your device.
- The type and number of devices that can be controlled by the Control for HDMI function is restricted by the HDMI CEC standard as follows:
  - Recording devices (Blu-ray Disc recorder, DVD recorder, etc.): up to 3 devices
  - Playback devices (Blu-ray Disc player, DVD player, etc.): up to 3 devices
  - Tuner-related devices: up to 4 devices
  - Audio system (receiver/headphones): up to 1 device (used by the system)

**[PROTECT] flashes in the front panel display and the system is turned off.**

- Disconnect the AC power cord (mains lead) and make sure nothing is

obstructing the ventilation holes of the system.

**Sensors of the TV do not work properly.**

- The system may block some sensors (such as the brightness sensor), the remote control receiver of your TV or the emitter for 3D glasses (infrared transmission) of a 3D TV that supports the infrared 3D glass system, or wireless communication. Move the system away from the TV within a range that allows those parts to operate properly. For the locations of the sensors and remote control receiver, refer to the operating instructions supplied with the TV.



**Wireless function (the BLUETOOTH function or subwoofer) is unstable.**

- Do not place metal objects other than a TV around the system.

**Music that you are not familiar with suddenly plays.**

- The pre-installed sample music may have been played. Press  on the bar speaker to stop playback.

**The system does not work properly.**

- The system may be in demo mode. To cancel demo mode, reset the system. Press and hold  (power) and  (volume) on the bar speaker for more than 5 seconds (page 47).

## Resetting the system

If the system still does not operate properly, reset the system as follows.

- 1 Press MENU.**  
The setting menu appears in the front panel display.
- 2 Press  $\blacktriangle/\blacktriangledown$  to select [RESET], then press ENTER.**
- 3 Press  $\blacktriangle/\blacktriangledown$  to select [ALL RESET], then press ENTER.**
- 4 Press  $\blacktriangle/\blacktriangledown$  to select [START], then press ENTER.**  
All the settings return to their initial status.

### To cancel resetting

Select [CANCEL] in step 4.

### If You Cannot Perform Resetting Using the Setting Menu

**Press and hold  $\text{⏻}$  (power) and – (volume) on the bar speaker for more than 5 seconds.**

The settings return to their initial status.

#### Note

By resetting, the link with the subwoofer may be lost. In this case, perform "Connecting the Subwoofer" (page 15).

## Additional Information

# Specifications

## Bar Speaker (SA-G700)

### Amplifier section

U.S. models:

POWER OUTPUT AND TOTAL HARMONIC DISTORTION:  
(FTC)

Front L + Front R:

With 4 ohms loads, both channels driven, from 200 - 20,000 Hz; rated

**35 W** ~~xx W~~ per channel minimum RMS power, with no more than 1% total harmonic distortion from 250 mW to rated output.

POWER OUTPUT (reference)

Front L/Front R/Center speaker: 100 W (per channel at 4 ohms, 1 kHz)

Canadian models:

POWER OUTPUT (rated)

Front L + Front R: 60 W + 60 W (at 4 ohms, 1 kHz, 1% THD)

POWER OUTPUT (reference)

Front L/Front R/Center speaker: 100 W (per channel at 4 ohms, 1 kHz)

Inputs

HDMI IN\*

TV IN (OPT)

Outputs

HDMI OUT (TV eARC/ARC)\*

\* HDMI IN and HDMI OUT (TV eARC/ARC) jacks support HDCP2.2 and HDCP2.3 protocol. HDCP2.2 and HDCP2.3 are newly enhanced copyright protection technology that is used to protect content such as 4K movies.

### HDMI Section

Connector

Type A (19pin)

### BLUETOOTH section

Communication system

BLUETOOTH Specification version 4.2

Output

BLUETOOTH Specification Power Class 1

Maximum communication range

Line of sight approx. 30 m<sup>1)</sup>

Maximum number of devices to be registered

10 devices

Frequency band

2.4 GHz band (2.4000 GHz - 2.4835 GHz)

Modulation method

FHSS (Freq Hopping Spread Spectrum)

Compatible BLUETOOTH profiles<sup>2)</sup>

A2DP (Advanced Audio Distribution Profile)

AVRCP (Audio Video Remote Control Profile)

Supported Codecs<sup>3)</sup>

SBC<sup>4)</sup>, AAC<sup>5)</sup>

Transmission range (A2DP)

20 Hz - 20,000 Hz (Sampling frequency 32 kHz, 44.1 kHz, 48 kHz)

- 1) The actual range will vary depending on factors such as obstacles between devices, magnetic fields around a microwave oven, static electricity, cordless phone use, reception sensitivity, the operating system, software applications, etc.
- 2) BLUETOOTH standard profiles indicate the purpose of BLUETOOTH communication between devices.
- 3) Codec: Audio signal compression and conversion format
- 4) Abbreviation for Subband Codec
- 5) Abbreviation for Advanced Audio Coding

### Front L/Front R/Center speaker block section

Speaker system

3 speaker system, Acoustic suspension

Speaker

45 mm × 100 mm (1 13/16 in × 4 in) cone type



**General**

Power requirements

120 V AC, 60 Hz

Power consumption

On: ~~XX W~~ **45 W**

Standby mode: 0.5 W or less (Power Saving mode)

(When [HDMI] - [CONTROL FOR HDMI] and [BT] - [STANDBY] are set to [OFF])

Standby mode: 2 W or less\*

(When [HDMI] - [CONTROL FOR HDMI] and [BT] - [STANDBY] are set to [ON])

\* The system will automatically enter Power saving mode when there is no HDMI connection and no BLUETOOTH pairing history.

Dimensions\* (approx.) (w/h/d)

980 mm × 64 mm × 108 mm (38 5/8 in × 2 5/8 in × 4 3/8 in)

\* Not including projection portion

Mass (approx.)

3.5 kg (7 lb 12 oz)

**Subwoofer (SA-WG700)**

POWER OUTPUT (reference)

100 W (at 4 ohms, 100 Hz)

Speaker system

Subwoofer speaker system, Bass reflex

Speaker

160 mm (6 3/8 in.) cone type

Power requirements

120 V AC, 60 Hz

Power consumption

On: ~~XX W~~ **20 W**

Standby mode: 0.5 W or less

Dimensions (approx.) (w/h/d)

192 mm × 387 mm × 406 mm (7 5/8 in × 15 1/4 in × 16 in)

\* Not including projection portion

Mass (approx.)

~~XX kg (XX lb XX oz)~~ **7.5 kg (16 lb 9 oz)**

**Wireless Transmitter/ Receiver Section**

Frequency band **(2.404 GHz – 2.476 GHz)**

2.4 GHz ~~(2.4000 GHz – 2.4835 GHz)~~

Modulation method

~~FHSS (Freq Hopping Spread Spectrum)~~ **GFSK**

Design and specifications are subject to change without notice.

## Supported Input Audio Formats

Audio formats supported by this system are as follows.

Format	Function			
	[HDMI]	[TV] (eARC)	[TV] (ARC)	[TV] (OPT)
LPCM 2ch	○	○	○	○
LPCM 5.1ch	○	○	-	-
LPCM 7.1ch	○	○	-	-
Dolby Digital	○	○	○	○
Dolby TrueHD	○	○	-	-
Dolby Digital Plus	○	○	○	-
Dolby Atmos	○	○	-	-
Dolby Atmos - Dolby TrueHD	○	○	-	-
Dolby Atmos - Dolby Digital Plus	○	○	○	-
DTS	○	○	○	○
DTS-ES Discrete 6.1, DTS-ES Matrix 6.1	○	○	○	○
DTS 96/24	○	○	○	○
DTS-HD High Resolution Audio	○	○	-	-
DTS-HD Master Audio	○	○	-	-
DTS-HD LBR	○	○	-	-
DTS:X	○	○	-	-

○: Supported format.

-: Unsupported format.

### Note

The HDMI IN jack do not support audio format that contains copy protections, such as Super Audio CD or DVD-Audio.

## Supported HDMI Video Formats

Video formats supported by this system are as follows.

Resolution	Frame Rate	3D	Color Space	Color Depth	[HDMI] - [FORMAT] setting
4K 4096 × 2160p 3840 × 2160p	50/59.94/60 Hz	–	RGB 4:4:4 YCbCr 4:4:4	8 bit	[ENHANCED] <sup>1)</sup>
		–	YCbCr 4:2:2	8/10/12 bit	
		–	YCbCr 4:2:0	10/12 bit	
	23.98/24/25/29.97/30 Hz	–	RGB 4:4:4 YCbCr 4:4:4	10/12 bit	
4K 4096 × 2160p 3840 × 2160p	50/59.94/60 Hz	–	YCbCr 4:2:0	8 bit	[STANDARD] <sup>2)</sup>
		–	RGB 4:4:4 YCbCr 4:4:4	8 bit	
		–	YCbCr 4:2:2	8/10/12 bit	
1920 × 1080p	25/29.97/30/50/ 59.94/60 Hz	–	RGB 4:4:4 YCbCr 4:4:4 YCbCr 4:2:2	8/10/12 bit	[STANDARD] <sup>2)</sup>
		⊙			
1920 × 1080i	50/59.94/60 Hz	○			
1280 × 720p	50/59.94/60 Hz	⊙			
		–			
720 × 480p	59.94/60 Hz	–			
720 × 576p	50 Hz	–			
640 × 480p	59.94/60 Hz	–	RGB 4:4:4		

○: Compatible with 3D signal in Side-by-Side (Half) format

⊙: Compatible with 3D signal in Frame packing and Over-Under (Top-and-Bottom) format

1) Use a Premium High Speed HDMI Cable with Ethernet that supports 18 Gbps.

2) Use a Premium High Speed HDMI Cable with Ethernet or Sony High Speed HDMI Cable with Ethernet with the Cable Type Logo.

### Notes on HDMI Jack and HDMI Connections

- Use an HDMI-authorized cable.
- We do not recommend using an HDMI-DVI conversion cable.
- Audio signals (sampling frequency, bit length, etc.) transmitted from an HDMI jack may be suppressed by the connected device.
- Sound may be interrupted when the sampling frequency or the number of channels of audio output signals from the playback device is switched.
- When the TV input is selected, video signals via the HDMI IN jack are output from the HDMI OUT (TV eARC/ARC) jack.
- This system supports "TRILUMINOS."

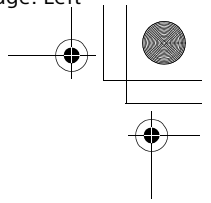
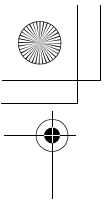

- HDMI IN and HDMI OUT (TV eARC/ARC) jacks support bandwidth up to 18 Gbps, HDCP2.2 and HDCP2.3<sup>1)</sup>, BT.2020 wide color spaces<sup>2)</sup>, and HDR (High Dynamic Range)<sup>3)</sup> contents pass-through.
- When connecting to a TV with a resolution that is different from that of the system, the system may restart to reset the picture output setting.
  - <sup>1)</sup> HDCP2.2 and HDCP2.3 are newly enhanced copyright protection technology that is used to protect content such as 4K movies.
  - <sup>2)</sup> BT.2020 color space is new wider color standard that is defined for ultra-high definition television systems.
  - <sup>3)</sup> HDR is an emerging video format that can display a wider range of brightness levels. The system is compatible with HDR10, HLG (Hybrid Log-Gamma), and Dolby Vision.

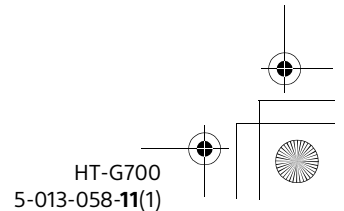
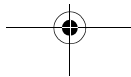
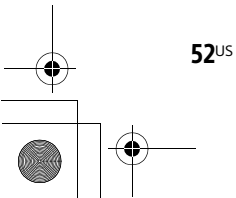
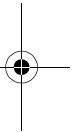
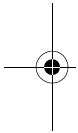

## On BLUETOOTH Communication

- BLUETOOTH devices should be used within approximately 10 meters (33 feet) (unobstructed distance) of each other. The effective communication range may become shorter under the following conditions.
  - When a person, metal object, wall or other obstruction is between the devices with a BLUETOOTH connection
  - Locations where a wireless LAN is installed
  - Around microwave ovens that are in use
  - Locations where other electromagnetic waves occur
- BLUETOOTH devices and wireless LAN (IEEE 802.11 b/g/n) use the same frequency band (2.4 GHz). When using your BLUETOOTH device near a device with wireless LAN capability, electromagnetic interference may occur. This could result in lower data transfer rates, noise, or inability to connect. If this happens, try the following remedies:
  - Use this system at least 10 meters (33 feet) away from the wireless LAN device.
  - Turn off the power to the wireless LAN device when using your BLUETOOTH device within 10 meters (33 feet).
  - Install this system and BLUETOOTH device as closer to each other as possible.
- The radio waves broadcast by this system may interfere with the operation of some medical devices. Since this interference may result in malfunction, always turn off the power on this system and BLUETOOTH device in the following locations:
  - In hospitals, on trains, in airplanes, at gas stations, and any place where flammable gasses may be present
  - Near automatic doors or fire alarms
- This system supports security functions that comply with the BLUETOOTH specification to ensure secure connection

during communication using BLUETOOTH technology. However, this security may be insufficient depending on the setting content and other factors, so always be careful when performing communication using BLUETOOTH technology.

- Sony cannot be held liable in any way for damages or other loss resulting from information leaks during communication using BLUETOOTH technology.
- BLUETOOTH communication is not necessarily guaranteed with all BLUETOOTH devices that have the same profile as this system.
- BLUETOOTH devices connected with this system must comply with the BLUETOOTH specification prescribed by the Bluetooth SIG, Inc., and must be certified to comply. However, even when a device complies with the BLUETOOTH specification, there may be cases where the characteristics or specifications of the BLUETOOTH device make it impossible to connect, or may result in different control methods, display or operation.
- Noise may occur or the audio may cut off depending on the BLUETOOTH device connected with this system, the communications environment, or surrounding conditions.

If you have any questions or problems concerning your system, please consult your nearest Sony dealer.

## END USER LICENSE AGREEMENT

### IMPORTANT:

BEFORE USING THE SOFTWARE, PLEASE READ THIS END USER LICENSE AGREEMENT ("EULA") CAREFULLY. BY USING THE SOFTWARE YOU ARE ACCEPTING THE TERMS OF THIS EULA. IF YOU DO NOT ACCEPT THE TERMS OF THIS EULA, YOU MAY NOT USE THE SOFTWARE.

This EULA is a legal agreement between you and Sony Electronics Inc. ("SONY"). This EULA governs your rights and obligations regarding the SONY software of SONY and/or its third party licensors (including SONY's affiliates) and their respective affiliates (collectively, the "THIRD-PARTY SUPPLIERS"), together with any updates/upgrades provided by SONY, any printed, on-line or other electronic documentation for such software, and any data files created by operation of such software (collectively, the "SOFTWARE").

Notwithstanding the foregoing, any software in the SOFTWARE having a separate end user license agreement (including, but not limited to, GNU General Public license and Lesser/Library General Public License) shall be covered by such applicable separate end user license agreement in lieu of the terms of this EULA to the extent required by such separate end user license agreement ("EXCLUDED SOFTWARE").

### SOFTWARE LICENSE

The SOFTWARE is licensed, not sold. The SOFTWARE is protected by copyright and other intellectual property laws and international treaties.

### COPYRIGHT

All right and title in and to the SOFTWARE (including, but not limited to, any images, photographs, animation, video, audio, music, text and "applets" incorporated into the SOFTWARE) is owned by SONY or one or more of the THIRD-PARTY SUPPLIERS.

### GRANT OF LICENSE

SONY grants you a limited license to use the SOFTWARE solely in connection with your compatible device ("DEVICE") and only for your individual, non-commercial use. SONY and the THIRD-PARTY SUPPLIERS expressly reserve all rights, title and interest (including, but not limited to, all intellectual property rights) in and to the SOFTWARE that this EULA does not specifically grant to you.

### REQUIREMENTS AND LIMITATIONS

You may not copy, publish, adapt, redistribute, attempt to derive source code, modify, reverse engineer, decompile, or disassemble any of the SOFTWARE, whether in whole or in part, or create any derivative works from or of the SOFTWARE unless such derivative works are intentionally facilitated by the SOFTWARE. You may not modify or tamper with any digital rights management functionality of the SOFTWARE. You may not bypass, modify, defeat or circumvent any of the functions or protections of the SOFTWARE or any mechanisms operatively linked to the SOFTWARE. You may not separate any individual component of the SOFTWARE for use on more than one DEVICE unless expressly authorized to do so by SONY. You may not remove, alter, cover or deface any trademarks or notices on the SOFTWARE. You may not share, distribute, rent, lease, sublicense, assign, transfer or sell the SOFTWARE.

The software, network services or other products other than SOFTWARE upon which the SOFTWARE'S performance depends might be interrupted or discontinued at the discretion of the suppliers (software suppliers, service suppliers, or SONY). SONY and such suppliers do not warrant that the SOFTWARE, network services, contents or other products will continue to be available, or will operate without interruption or modification.

**USE OF SOFTWARE WITH COPYRIGHTED MATERIALS**

The SOFTWARE may be capable of being used by you to view, store, process and/or use content created by you and/or third parties. Such content may be protected by copyright, other intellectual property laws, and/or agreements. You agree to use the SOFTWARE only in compliance with all such laws and agreements that apply to such content. You acknowledge and agree that SONY may take appropriate measures to protect the copyright of content stored, processed or used by the SOFTWARE. Such measures include, but are not limited to, counting the frequency of your backup and restoration through certain SOFTWARE features, refusal to accept your request to enable restoration of data, and termination of this EULA in the event of your illegitimate use of the SOFTWARE.

**CONTENT SERVICE**

PLEASE ALSO NOTE THAT THE SOFTWARE MAY BE DESIGNED TO BE USED WITH CONTENT AVAILABLE THROUGH ONE OR MORE CONTENT SERVICES ("CONTENT SERVICE"). USE OF THE SERVICE AND THAT CONTENT IS SUBJECT TO THE TERMS OF SERVICE OF THAT CONTENT SERVICE. IF YOU DECLINE TO ACCEPT THOSE TERMS, YOUR USE OF THE SOFTWARE WILL BE LIMITED. You acknowledge and agree

that certain content and services available through the SOFTWARE may be provided by third parties over which SONY has no control. USE OF THE CONTENT SERVICE REQUIRES AN INTERNET CONNECTION. THE CONTENT SERVICE MAY BE DISCONTINUED AT ANY TIME.

**INTERNET CONNECTIVITY AND THIRD PARTY SERVICES**

You acknowledge and agree that access to certain SOFTWARE features may require an Internet connection for which you are solely responsible. Further, you are solely responsible for payment of any third party fees associated with your Internet connection, including but not limited to Internet service provider or airtime charges. Operation of the SOFTWARE may be limited or restricted depending on the capabilities, bandwidth or technical limitations of your Internet connection and service. The provision, quality and security of such Internet connectivity are the sole responsibility of the third party providing such service.

**EXPORT AND OTHER REGULATIONS**

You agree to comply with all applicable export and re-export restrictions and regulations of the area or country in which you reside, and not to transfer, or authorize the transfer, of the SOFTWARE to a prohibited country or otherwise in violation of any such restrictions or regulations.

**HIGH RISK ACTIVITIES**

The SOFTWARE is not fault-tolerant and is not designed, manufactured or intended for use or resale as on-line control equipment in hazardous environments requiring fail-safe performance, such as in the operation of nuclear facilities, aircraft navigation or communication systems, air traffic

control, direct life support machines, or weapons systems, in which the failure of the SOFTWARE could lead to death, personal injury, or severe physical or environmental damage ("HIGH RISK ACTIVITIES"). SONY, each of the THIRD-PARTY SUPPLIERS, and each of their respective affiliates specifically disclaim any express or implied warranty, duty or condition of fitness for HIGH RISK ACTIVITIES.

**EXCLUSION OF WARRANTY ON SOFTWARE**

You acknowledge and agree that use of the SOFTWARE is at your sole risk and that you are responsible for use of the SOFTWARE. The SOFTWARE is provided "AS IS," without warranty, duty or condition of any kind.

SONY AND EACH OF THE THIRD-PARTY SUPPLIERS (for purposes of this Section, SONY and each of the THIRD-PARTY SUPPLIERS shall be collectively referred to as "SONY") EXPRESSLY DISCLAIM ALL WARRANTIES, DUTIES OR CONDITIONS, EXPRESS OR IMPLIED, INCLUDING, BUT NOT LIMITED TO, THE IMPLIED WARRANTIES OF MERCHANTABILITY, NONINFRINGEMENT AND FITNESS FOR A PARTICULAR PURPOSE. SONY DOES NOT WARRANT OR MAKE ANY CONDITIONS OR REPRESENTATIONS (A) THAT THE FUNCTIONS CONTAINED IN ANY OF THE SOFTWARE WILL MEET YOUR REQUIREMENTS OR THAT THEY WILL BE UPDATED, (B) THAT THE OPERATION OF ANY OF THE SOFTWARE WILL BE CORRECT OR ERROR-FREE OR THAT ANY DEFECTS WILL BE CORRECTED, (C) THAT THE SOFTWARE WILL NOT DAMAGE ANY OTHER SOFTWARE, HARDWARE OR DATA, (D) THAT ANY SOFTWARE, NETWORK SERVICES (INCLUDING THE INTERNET) OR PRODUCTS (OTHER THAN THE SOFTWARE) UPON WHICH THE SOFTWARE'S PERFORMANCE DEPENDS WILL CONTINUE TO BE AVAILABLE, UNINTERRUPTED OR UNMODIFIED, AND

(E) REGARDING THE USE OR THE RESULTS OF THE USE OF THE SOFTWARE IN TERMS OF ITS CORRECTNESS, ACCURACY, RELIABILITY, OR OTHERWISE.

NO ORAL OR WRITTEN INFORMATION OR ADVICE GIVEN BY SONY OR AN AUTHORIZED REPRESENTATIVE OF SONY SHALL CREATE A WARRANTY, DUTY OR CONDITION OR IN ANY WAY INCREASE THE SCOPE OF THIS WARRANTY. SHOULD THE SOFTWARE PROVE DEFECTIVE YOU ASSUME THE ENTIRE COST OF ALL NECESSARY SERVICING, REPAIR OR CORRECTION. SOME JURISDICTIONS DO NOT ALLOW THE EXCLUSION OF IMPLIED WARRANTIES, SO THESE EXCLUSIONS MAY NOT APPLY TO YOU.

**LIMITATION OF LIABILITY**

SONY AND EACH OF THE THIRD-PARTY SUPPLIERS (for purposes of this Section, SONY and each of the THIRD-PARTY SUPPLIERS shall be collectively referred to as "SONY") SHALL NOT BE LIABLE FOR ANY INCIDENTAL OR CONSEQUENTIAL DAMAGES FOR BREACH OF ANY EXPRESS OR IMPLIED WARRANTY, BREACH OF CONTRACT, NEGLIGENCE, STRICT LIABILITY OR UNDER ANY OTHER LEGAL THEORY RELATED TO THE SOFTWARE, INCLUDING, BUT NOT LIMITED TO, ANY DAMAGES ARISING OUT OF LOSS OF PROFITS, LOSS OF REVENUE, LOSS OF DATA, LOSS OF USE OF THE SOFTWARE OR ANY ASSOCIATED HARDWARE, DOWN TIME AND USER'S TIME, EVEN IF ANY OF THEM HAVE BEEN ADVISED OF THE POSSIBILITY OF SUCH DAMAGES. IN ANY CASE, EACH AND ALL OF THEIR AGGREGATE LIABILITY UNDER ANY PROVISION OF THIS EULA SHALL BE LIMITED TO THE AMOUNT ACTUALLY PAID FOR THE PRODUCT. SOME JURISDICTIONS DO NOT ALLOW THE EXCLUSION OR LIMITATION OF INCIDENTAL OR CONSEQUENTIAL DAMAGES, SO THE ABOVE EXCLUSION



OR LIMITATION MAY NOT APPLY TO YOU.

### **AUTOMATIC UPDATE FEATURE**

From time to time, SONY or the THIRD-PARTY SUPPLIERS may automatically update or otherwise modify the SOFTWARE, including, but not limited to, for purposes of enhancement of security functions, error correction and improvement of functions, at such time as you interact with SONY's or third parties' servers, or otherwise. Such updates or modifications may delete or change the nature of features or other aspects of the SOFTWARE, including, but not limited to, functions you may rely upon. You acknowledge and agree that such activities may occur at SONY's sole discretion and that SONY may condition continued use of the SOFTWARE upon your complete installation or acceptance of such update or modifications. Any updates/modifications shall be deemed to be, and shall constitute part of, the SOFTWARE for purposes of this EULA. By acceptance of this EULA, you consent to such update/modification.

### **ENTIRE AGREEMENT, WAIVER, SEVERABILITY**

This EULA and SONY's privacy policy, each as amended and modified from time to time, together constitute the entire agreement between you and SONY with respect to the SOFTWARE. The failure of SONY to exercise or enforce any right or provision of this EULA shall not constitute a waiver of such right or provision. If any part of this EULA is held invalid, illegal, or unenforceable, that provision shall be enforced to the maximum extent permissible so as to maintain the intent of this EULA, and the other parts will remain in full force and effect.

### **GOVERNING LAW AND JURISDICTION**

The United Nations Convention on Contracts for the International Sale of Goods shall not apply to this EULA. This EULA shall be governed by the laws of Japan, without regards to conflict of laws provisions. Any dispute arising out of this EULA shall be subject to the exclusive venue of the Tokyo District Court in Japan, and the parties hereby consent to the venue and jurisdiction of such courts.

### **EQUITABLE REMEDIES**

Notwithstanding anything contained in this EULA to the contrary, you acknowledge and agree that any violation of or non-compliance with this EULA by you will cause irreparable harm to SONY, for which monetary damages would be inadequate, and you consent to SONY obtaining any injunctive or equitable relief that SONY deems necessary or appropriate in such circumstances. SONY may also take any legal and technical remedies to prevent violation of and/or to enforce this EULA, including, but not limited to, immediate termination of your use of the SOFTWARE, if SONY believes in its sole discretion that you are violating or intend to violate this EULA. These remedies are in addition to any other remedies SONY may have at law, in equity or under contract.

### **TERMINATION**

Without prejudice to any of its other rights, SONY may terminate this EULA if you fail to comply with any of its terms. In case of such termination, you must cease all use, and destroy any copies, of the SOFTWARE.

### **AMENDMENT**

SONY RESERVES THE RIGHT TO AMEND ANY OF THE TERMS OF THIS EULA AT ITS

SOLE DISCRETION BY POSTING NOTICE ON A SONY DESIGNATED WEB SITE, BY EMAIL NOTIFICATION TO AN EMAIL ADDRESS PROVIDED BY YOU, BY PROVIDING NOTICE AS PART OF THE PROCESS IN WHICH YOU OBTAIN UPGRADES/UPDATES OR BY ANY OTHER LEGALLY RECOGNIZABLE FORM OF NOTICE. If you do not agree to the amendment, you should promptly contact SONY for instructions. Your continued use of the SOFTWARE after the effective date of any such notice shall be deemed your agreement to be bound by such amendment.

### THIRD-PARTY BENEFICIARIES

Each THIRD-PARTY SUPPLIER is an express intended third-party beneficiary of, and shall have the right to enforce, each provision of this EULA with respect to the SOFTWARE of such party. Should you have any questions concerning this EULA, you may contact SONY by writing to SONY at applicable contact address of each area or country.

Copyright © 2018 Sony Electronics Inc.  
All rights reserved.

## Precautions

### On safety

- Should any solid object or liquid fall into the system, unplug the system and have it checked by qualified personnel before operating it any further.
- Do not climb on the bar speaker and subwoofer, as you may fall down and injure yourself, or system damage may result.

### On power sources

- Before operating the system, check that the operating voltage is identical to your local power supply. The operating voltage is indicated on the nameplate at the bottom of the bar speaker.
- If you are not going to use the system for a long time, be sure to disconnect the system from the wall outlet (mains). To disconnect the AC power cord (mains lead), grasp the plug itself; never pull the cord.
- One blade of the plug is wider than the other for the purpose of safety and will fit into the wall outlet (mains) only one way. If you are unable to insert the plug fully into the outlet, contact your dealer.
- AC power cord (mains lead) must be changed only at a qualified service shop.

### On heat buildup

Although the system heats up during operation, this is not a malfunction. If you continuously use this system at high volume, the system temperature at the rear and bottom rises considerably. To avoid burning yourself, do not touch the system.

### On placement

- Do not place the system near heat sources or in a place subject to direct sunlight, excessive dust, or mechanical shock.
- Do not place anything at the rear of the bar speaker and subwoofer that might

block the ventilation holes and cause malfunctions.

- Do not place metal objects other than a TV around the system. Wireless functions may be unstable.
- If the system is being used in combination with a TV, VCR, or tape deck, noise may result and picture quality may suffer. In such a case, place the system away from the TV, VCR, or tape deck.
- Use caution when placing the system on a surface that has been specially treated (with wax, oil, polish, etc.), as staining or discoloration of the surface may result.
- Take care to avoid any possible injury from the corners of the bar speaker and subwoofer.
- Keep 3 cm or more space under the bar speaker when you hang it on a wall.
- The speakers of this system are not of magnetically shielded type. Do not place magnetic cards on the system or near it.

### On cleaning

Clean the system with a soft, dry cloth. Do not use any type of abrasive pad, scouring powder, or solvent such as alcohol or benzene.

If you have any question or problem concerning your system, please consult your nearest Sony dealer.

### On handling the subwoofer

Do not place your hand into the slit of the subwoofer when lifting it. The speaker driver may be damaged. When lifting it, hold the bottom of the subwoofer.

### On operation

Before connecting other devices, be sure to turn off and unplug the system.

### If you encounter color irregularity on a nearby TV screen

Color irregularities may be observed on certain types of TV sets.

### If color irregularity is observed...

Turn off the TV set, then turn it on again after 15 to 30 minutes.

### If color irregularity is observed again...

Place the system further away from the TV set.

## Copyrights and Trademarks

This system incorporates Dolby® Digital and the DTS® Digital Surround System.

\* Manufactured under license from Dolby Laboratories. Dolby, Dolby Audio, Dolby Atmos, Dolby Vision, and the double-D symbol are trademarks of Dolby Laboratories.

\*\*For DTS patents, see <https://patents.dts.com>. Manufactured under license from DTS, Inc. DTS, the Symbol, DTS and the Symbol together, DTS:X, Virtual:X, the DTS:X logo, and the DTS Virtual:X logo are registered trademarks or trademarks of DTS, Inc. in the United States and/or other countries. © DTS, Inc. All Rights Reserved.

The BLUETOOTH® word mark and logos are registered trademarks owned by Bluetooth SIG, Inc. and any use of such marks by Sony Corporation is under license. Other trademarks and trade names are those of their respective owners.

The terms HDMI, HDMI High-Definition Multimedia Interface, and the HDMI Logo are trademarks or registered trademarks of HDMI Licensing Administrator, Inc.

“BRAVIA” logo is a trademark of Sony Corporation.

“PlayStation” is a registered trademark or trademark of Sony Interactive Entertainment Inc.

MPEG Layer-3 audio coding technology and patents licensed from Fraunhofer IIS and Thomson.

Windows Media is either a registered trademark or trademark of Microsoft Corporation in the United States and/or other countries.

This product is protected by certain intellectual property rights of Microsoft Corporation. Use or distribution of such technology outside of this product is

prohibited without a license from Microsoft or an authorized Microsoft subsidiary.

This product contains software that is subject to the GNU General Public License (“GPL”) or GNU Lesser General Public License (“LGPL”). These establish that customers have the right to acquire, modify, and redistribute the source code of said software in accordance with the terms of the GPL or the LGPL.

Please note that Sony cannot answer or respond to any inquiries regarding the content of this source code.

“TRILUMINOS” and “TRILUMINOS” logo are a registered trademark of Sony Corporation.

All other trademarks are trademarks of their respective owners.

---

## Index

### A

ARC (Audio Return Channel) 9, 32  
AUTO STANDBY 37

### B

BT.2020 52

### C

Control for HDMI 31

### D

DIMMER 39

### E

eARC (Enhanced Audio Return  
Channel) 9, 32, 36

### H

HDCP2.2 and HDCP2.3 52  
HDR 52

### I

IMMERSIVE AE 27

### M

Multiplex broadcast sound 23

### N

NIGHT 29

### P

PROTECT 46

### R

Remote control 11  
Resetting 47

### S

Setting menu 34  
Sound Mode 28  
Standby Through 32  
Subwoofer 15, 23, 44

### V

VOICE 29

### Support pages

Find information on software updates:

<http://www.sony.com/soundbarsupport>

### Pages d'assistance

Trouvez des informations sur les mises à jour de logiciel :

### Páginas de soporte

Encuentre información sobre las actualizaciones de software:

### Smartphone app

Support by Sony app - Find information and get notification about your product:

### Appli de téléphone intelligent

Appli Support by Sony - Trouvez des informations et obtenez des notifications au sujet de votre produit :

### Aplicación para smartphone

Aplicación "Support by Sony" - Encuentre información y reciba notificaciones de su producto:



- News & Alerts / Nouvelles & Alertes / Noticias y alertas
- Software updates / Mises à jour de logiciel / Actualizaciones de software
- Tutorials / Tutoriels / Tutoriales
- Tips & Tricks / Trucs & Conseils / Sugerencias y trucos

<https://sony.net/SBS>

 DOLBY ATMOS®



HDMI



\* 5 0 1 3 0 5 8 1 1 \* (1)

©2020 Sony Corporation Printed in China

5-013-058-11(1)

HT-G700

5-013-058-11(1)