

## FCC 47 CFR PART 15 SUBPART C AND ANSI C63.10: 2013

### TEST REPORT

For

**Stereo Turntable System**

**Model: PS-LX310BT**

**Brand: SONY**

Issued for

**SONY Corporation**

**1-7-1 Konan Minato-ku Tokyo, 108-0075 Japan**

Issued by

**Compliance Certification Services Inc.**

**Tainan Lab.**

**No. 168, Ln. 523, Sec. 3, Zhongzheng Rd.,  
Rende Dist., Tainan City, 717017, Taiwan**

**Issued Date: August 04, 2023**

---

**Note:** This report shall not be reproduced except in full, without the written approval of Compliance Certification Services Inc. Ltd. This document may be altered or revised by Compliance Certification Services Inc. personnel only, and shall be noted in the revision section of the document

Unless otherwise stated the results shown in this test report refer only to the sample(s) tested and such sample(s) are retained for 90 days only.  
除非另有說明，此報告結果僅對測試之樣品負責，同時此樣品僅保留 90 天。本報告未經本公司書面許可，不可部份複製。

This document is issued by the Company subject to its General Conditions of Service printed overleaf, available on request or accessible at <http://www.sgs.com.tw/Terms-and-Conditions> and, for electronic format documents, subject to Terms and Conditions for Electronic Documents at <http://www.sgs.com.tw/Terms-and-Conditions>. Attention is drawn to the limitation of liability, indemnification and jurisdiction issues defined therein. Any holder of this document is advised that information contained hereon reflects the Company's findings at the time of its intervention only and within the limits of client's instruction, if any. The Company's sole responsibility is to its Client and this document does not exonerate parties to a transaction from exercising all their rights and obligations under the transaction documents. This document cannot be reproduced, except in full, without prior written approval of the Company. Any unauthorized alteration, forgery or falsification of the content or appearance of this document is unlawful and offenders may be prosecuted to the fullest extent of the law.

W

### REVISION HISTORY

| Rev. | Issue Date      | Revisions     | Effect Page | Revised By |
|------|-----------------|---------------|-------------|------------|
| 00   | August 04, 2023 | Initial Issue | ALL         | Gina Lin   |
|      |                 |               |             |            |
|      |                 |               |             |            |
|      |                 |               |             |            |



## TABLE OF CONTENTS

|   |            |
|---|------------|
| <b>1. TEST REPORT CERTIFICATION .....</b>         | <b>4</b>   |
| <b>2. TEST RESULT SUMMARY .....</b>               | <b>5</b>   |
| <b>3. EUT DESCRIPTION .....</b>                   | <b>6</b>   |
| 3.1 DESCRIPTION OF EUT & POWER .....              | 6          |
| <b>4. DESCRIPTION OF TEST MODES .....</b>         | <b>7</b>   |
| <b>5. TEST METHODOLOGY .....</b>                  | <b>8</b>   |
| <b>6. FACILITIES AND ACCREDITATIONS.....</b>      | <b>8</b>   |
| 6.1 FACILITIES .....                              | 8          |
| 6.2 EQUIPMENT .....                               | 8          |
| 6.3 LABORATORY ACCREDITATIONS LISTINGS.....       | 8          |
| 6.4 TABLE OF ACCREDITATIONS AND LISTINGS .....    | 9          |
| 6.5 MEASUREMENT EQUIPMENT USED .....              | 10         |
| <b>7. CALIBRATION AND UNCERTAINTY.....</b>        | <b>11</b>  |
| 7.1 MEASURING INSTRUMENT CALIBRATION .....        | 11         |
| 7.2 MEASUREMENT UNCERTAINTY .....                 | 11         |
| <b>8. SETUP OF EQUIPMENT UNDER TEST.....</b>      | <b>12</b>  |
| 8.1 SETUP CONFIGURATION OF EUT .....              | 12         |
| 8.2 SUPPORT EQUIPMENT.....                        | 14         |
| 8.3 EUT OPERATING CONDITION.....                  | 15         |
| <b>9. APPLICABLE LIMITS AND TEST RESULTS.....</b> | <b>17</b>  |
| 9.1 6DB BANDWIDTH.....                            | 17         |
| 9.2 MAXIMUM PEAK OUTPUT POWER .....               | 23         |
| 9.3 DUTY CYCLE.....                               | 35         |
| 9.4 POWER SPECTRAL DENSITY .....                  | 41         |
| 9.5 CONDUCTED SPURIOUS EMISSION .....             | 47         |
| 9.6 RADIATED EMISSIONS .....                      | 58         |
| 9.7 POWERLINE CONDUCTED EMISSIONS .....           | 83         |
| <b>10. ANTENNA REQUIREMENT .....</b>              | <b>93</b>  |
| 10.1 STANDARD APPLICABLE.....                     | 93         |
| 10.2 ANTENNA CONNECTED CONSTRUCTION.....          | 93         |
| <b>APPENDIX I SETUP PHOTOS .....</b>              | <b>94</b>  |
| <b>APPENDIX II PHOTOGRPHS OF EUT .....</b>        | <b>100</b> |

## 1. TEST REPORT CERTIFICATION

**Applicant** : **SONY Corporation**  
 1-7-1 Konan Minato-ku Tokyo, 108-0075 Japan  
**Manufacturer** : **SONY Corporation**  
 1-7-1 Konan Minato-ku Tokyo, 108-0075 Japan  
**Equipment Under Test** : Stereo Turntable System  
**Model Number** : PS-LX310BT  
**Brand Name** : SONY  
**Date of Test** : May 29, 2023 ~ June 07, 2023

| APPLICABLE STANDARD                            |                         |
|--|-------------------------|
| STANDARD                                       | TEST RESULT             |
| FCC Part 15 Subpart C AND<br>ANSI C63.10: 2013 | No non-compliance noted |

| Statements of Conformity   |
|--|
| Determining compliance shall be based on the results of the compliance measurement, not taking into account measurement instrumentation uncertainty. |

Approved by:

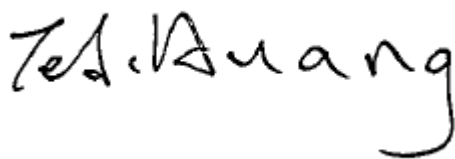

---

**Ted Huang**  
Sr. Engineer

## 2. TEST RESULT SUMMARY

| FCC Standard Section | Report Section | Test Item                     | Result |
|----------------------|----------------|-------------------------------|--------|
| 15.247(a)            | 9.1            | 6dB BANDWIDTH                 | Pass   |
| 15.247(b)            | 9.2            | MAXIMUM PEAK OUTPUT POWER     | Pass   |
| -                    | 9.3            | DUTY CYCLE                    | -      |
| 15.247(e)            | 9.4            | POWER SPECTRAL DENSITY        | Pass   |
| 15.247(d)            | 9.5            | CONDUCTED SPURIOUS EMISSION   | Pass   |
| 15.209(a)            | 9.6            | RADIATED EMISSIONS            | Pass   |
| 15.207(a)            | 9.7            | POWERLINE CONDUCTED EMISSIONS | Pass   |
| 15.203               | 10             | ANTENNA REQUIREMENT           | Pass   |

### 3. EUT DESCRIPTION

#### 3.1 DESCRIPTION OF EUT & POWER

|                                  |   |
|----------------------------------|---|
| <b>Product Name</b>              | Stereo Turntable System   |
| <b>Model Number</b>              | PS-LX310BT  |
| <b>Brand Name</b>                | SONY  |
| <b>Received Date</b>             | May 23, 2023  |
| <b>Reported Date</b>             | June 27, 2023   |
| <b>Operating Frequency Range</b> | GFSK(5.0) Mode: 2402MHz~2480MHz   |
| <b>Transmit Power</b>            | GFSK(4.0) Mode: -6.109dBm (0.245mW)<br>GFSK(5.0) Mode: -6.069dBm (0.247mW)        |
| <b>Channel Spacing</b>           | GFSK(5.0) Mode: 2 MHz   |
| <b>Channel Number</b>            | GFSK(5.0) Mode: 40 Channels   |
| <b>Transmit Data Rate</b>        | GFSK(4.0) Mode: 1 Mbps<br>GFSK(5.0) Mode: 2 Mbps                                  |
| <b>Type of Modulation</b>        | GFSK  |
| <b>Antenna Type</b>              | Manufacturer: Sunitec<br>Type: PCB Antenna<br>Model: PS-LX310BT<br>Gain: 3.51 dBi |
| <b>Power Source</b>              | DC 12V(Power by AC/DC ADAPTOR)  |
| <b>Firmware Version</b>          | V1.0  |
| <b>Software Version</b>          | V1.0  |

#### Motor

|                  | <b>Manufacturer</b>                            | <b>Model No.</b> |
|------------------|--|------------------|
| New product      | SHEN ZHEN MING ZHENG YANG ELECTRONICS CO., LTD | EG-530SD-3F      |
| Original product | SANKO ELECTRIC CO.,LTD                         | M09S             |

#### Power Adaptor :

| <b>No.</b> | <b>Manufacturer</b> | <b>Model No.</b>  | <b>Power Input</b>        | <b>Power Output</b> |
|------------|---------------------|-------------------|---------------------------|---------------------|
| 1          | SONY                | FJ-SW7261200800DU | 100-240Vac, 50/60Hz, 0.4A | 12Vdc, 0.8A         |

#### REMARK:

1. The sample selected for test was engineering sample that approximated to production product and was provided by manufacturer.
2. This submittal(s) (test report) is intended for FCC ID: **AK8PSLX310BTM2** filing to comply with Section 15.207, 15.209 and 15.247 of the FCC Part 15, Subpart C Rules.
3. For more details, please refer to the user manual.

## 4. DESCRIPTION OF TEST MODES

The EUT is a Stereo Turntable System.

The RF Chip is manufactured by Sunitec Enterprise Co., LTD.

The antenna peak gain 3.51 dBi (highest gain) were chosen for full testing.

### GFSK(5.0) mode

The EUT had been tested under operating condition.

There are three channels have been tested as following:

| Channel | Frequency (MHz) |
|---------|-----------------|
| Low     | 2402            |
| Middle  | 2442            |
| High    | 2480            |

GFSK(5.0) mode: 1Mbps long data rates (worst case) were chosen for full testing.

## 5. TEST METHODOLOGY

The tests documented in this report were performed in accordance with ANSI C63.10 and FCC CFR 47 15.207, 15.209 and 15.247 and KdB 558074.

## 6. FACILITIES AND ACCREDITATIONS

### 6.1 FACILITIES

All measurement facilities used to collect the measurement data are located at

- No.8, Jiucengling, Xinhua Dist., Tainan City 712, Taiwan (R.O.C.)
- No. 168, Ln. 523, Sec. 3, Zhongzheng Rd., Rende Dist., Tainan City 717, Taiwan (R.O.C.)

The sites are constructed in conformance with the requirements of ANSI C63.7:1992, ANSI C63.10: 2013 and CISPR Publication 22.

### 6.2 EQUIPMENT

Radiated emissions are measured with one or more of the following types of linearly polarized antennas: tuned dipole, biconical, log periodic, bi-log, and/or ridged waveguide, horn. Spectrum analyzers with preselectors and quasi-peak detectors are used to perform radiated measurements.

Conducted emissions are measured with Line Impedance Stabilization Networks and EMI Test Receivers.

Calibrated wideband preamplifiers, coaxial cables, and coaxial attenuators are also used for making measurements.

All receiving equipment conforms to CISPR Publication 16-1, "Radio Interference Measuring Apparatus and Measurement Methods."

### 6.3 LABORATORY ACCREDITATIONS LISTINGS

The test facilities used to perform radiated and conducted emissions tests are accredited by Taiwan Accreditation Foundation for the specific scope of accreditation under Lab Code: 1109 to perform Electromagnetic Interference tests according to FCC PART 15 AND CISPR 22 requirements. No part of this report may be used to claim or imply product endorsement by TAF or any agency of the Government. In addition, the test facilities are listed with Federal Communications Commission (registration no: TW1109).



## 6.4 TABLE OF ACCREDITATIONS AND LISTINGS

Our laboratories are accredited and approved by the following accreditation body according to ISO/IEC 17025.

|               |     |
|---------------|-----|
| <b>Taiwan</b> | TAF |
|---------------|-----|

The measuring facility of laboratories has been authorized or registered by the following approval agencies.

|                |                                |
|----------------|--------------------------------|
| <b>Canada</b>  | Industry Canada (ISED#: 2324H) |
| <b>Germany</b> | TUV NORD                       |
| <b>Taiwan</b>  | BSMI                           |
| <b>USA</b>     | FCC                            |

## 6.5 MEASUREMENT EQUIPMENT USED

### For §9.7

| Chamber 1166 Room (Radiation Test) |   |              |                    |                  |                 |
|------------------------------------|---|--------------|--------------------|------------------|-----------------|
| Name of Equipment                  | Manufacturer                            | Model        | Serial Number      | Calibration Date | Calibration Due |
| Active Loop Antenna                | ETS-LINDREN                             | 6502         | 8905-2356          | 08/29/2022       | 08/28/2023      |
| Attenuator                         | MCL                                     | BW-S15W5     | 0535               | 01/19/2023       | 01/18/2024      |
| Band Reject Filter                 | MICRO-TRONICS                           | HPM13525     | 006                | 01/19/2023       | 01/18/2024      |
| Band Reject Filter                 | MICRO-TRONICS                           | HP50107-01   | 001                | 01/19/2023       | 01/18/2024      |
| Bilog Antenna With 6dB Attenuator  | SUNOL SCIENCES & EMCI                   | JB1 & N-6-06 | A021306 & AT-N0682 | 10/11/2022       | 10/10/2023      |
| Cable                              | EMCI                                    | EM102-KMKM   | CB1166-01          | 06/20/2022       | 06/19/2023      |
| Double Ridged Guide Horn Antenna   | ETS-LINDGREN                            | 3116         | 00078900           | 03/25/2023       | 03/24/2024      |
| EMI Test Receiver                  | R&S                                     | ESCI 7       | 100856             | 06/15/2023       | 06/14/2024      |
| EXA Spectrum Analyzer              | KEYSIGHT                                | N9010A       | MY54430216         | 08/11/2022       | 08/10/2023      |
| Double Ridged Guide Horn Antenna   | SCHWARZBECK                             | BBHA 9120D   | 9120D-788(98006)   | 04/18/2023       | 04/17/2024      |
| Notch Filter                       | MICRO-TRONICS                           | BRM50702-01  | 018                | 01/19/2023       | 01/18/2024      |
| Pre-Amplifier                      | EMCI                                    | EMC012645    | 980098             | 01/19/2023       | 01/18/2024      |
| Pre-Amplifier                      | Com-Power                               | PAM-840A     | 461378             | 06/28/2022       | 06/27/2023      |
| Software                           | Excel(ccs-o6-2020 v1.1) · e3(v6.101222) |              |                    |                  |                 |

### For §9.1~9.6

| Chamber 1166 Room (Conducted Test) |                         |              |               |                  |                 |
|------------------------------------|-------------------------|--------------|---------------|------------------|-----------------|
| Name of Equipment                  | Manufacturer            | Model        | Serial Number | Calibration Date | Calibration Due |
| EXA Spectrum Analyzer              | KEYSIGHT                | N9010A       | MY54430216    | 08/11/2022       | 08/10/2023      |
| SMA Cable+10dB Attenuator          | CCS                     | SMA+10dB ATT | SMA/10dB      | 01/19/2023       | 01/18/2024      |
| Software                           | Excel(ccs-o6-2020 v1.1) |              |               |                  |                 |

### For §9.8

| Conducted Emission room #1 |               |                  |               |                  |                 |
|----------------------------|---------------|------------------|---------------|------------------|-----------------|
| Name of Equipment          | Manufacturer  | Model            | Serial Number | Calibration Date | Calibration Due |
| BNC Coaxial Cable          | CCS           | BNC50            | 11            | 01/19/2023       | 01/18/2024      |
| EMI Test Receiver          | R&S           | ESCI             | 100960        | 01/11/2023       | 01/10/2024      |
| LISN                       | FCC           | FCC-LISN-50-32-2 | 08009         | 07/15/2022       | 07/14/2023      |
| LISN                       | SCHWARZBECK   | NNLK8130         | 8130124       | 01/18/2023       | 01/17/2024      |
| Pulse Limiter              | SCHWARZBECK   | VTSD 9561-F      | 797           | 01/19/2023       | 01/18/2024      |
| Test S/W                   | e3(v6.101222) |                  |               |                  |                 |

## 7. CALIBRATION AND UNCERTAINTY

### 7.1 MEASURING INSTRUMENT CALIBRATION

The measuring equipment utilized to perform the tests documented in this report has been calibrated in accordance with the manufacturer’s recommendations, and is traceable to recognized national standards.

### 7.2 MEASUREMENT UNCERTAINTY

Where relevant, the following measurement uncertainty levels have been estimated for tests performed on the apparatus:

| PARAMETER   | UNCERTAINTY |
|---|-------------|
| Radiated Emission, 9kHz~30MHz<br>Test Site : CB1166   | ±2.7dB      |
| Radiated Emission, 30 MHz ~1GHz<br>Test Site : CB1166 | ±3.76dB     |
| Radiated Emission, 1GHz ~18GHz<br>Test Site : CB1166  | ±4.43dB     |
| Radiated Emission, 18GH~26.5GHz<br>Test Site : CB1166 | ±4.79dB     |
| Radiated Emission, 26.5GH~40GHz<br>Test Site : CB1166 | ±4.72dB     |
| Power Line Conducted Emission,<br>9kHz~30MHz          | ±1.83dB     |
| Band Width  | 0.025%      |
| Peak Output Power MU                                  | ±1.9dB      |
| Band Edge MU  | ±0.264dBuV  |
| Channel Separation MU                                 | ±361.69Hz   |
| Duty Cycle MU   | ±0.2%       |
| Frequency Stability MU                                | ±0.493Hz    |
| Temperature   | ±0.5        |
| Humidity  | ±3%         |

This measurement uncertainty is confidence of approximately 95%, k=2

## 8. SETUP OF EQUIPMENT UNDER TEST

### 8.1 SETUP CONFIGURATION OF EUT

#### EMI

##### 【Line】

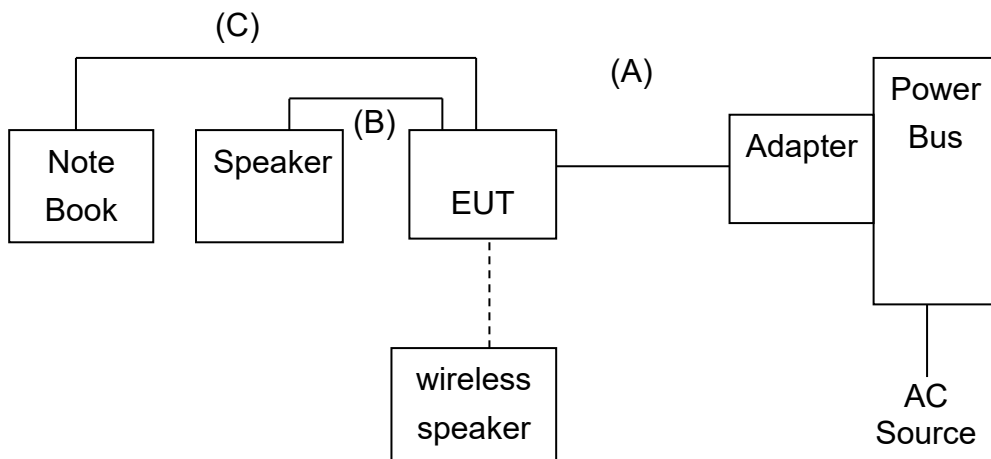

##### 【Phono】

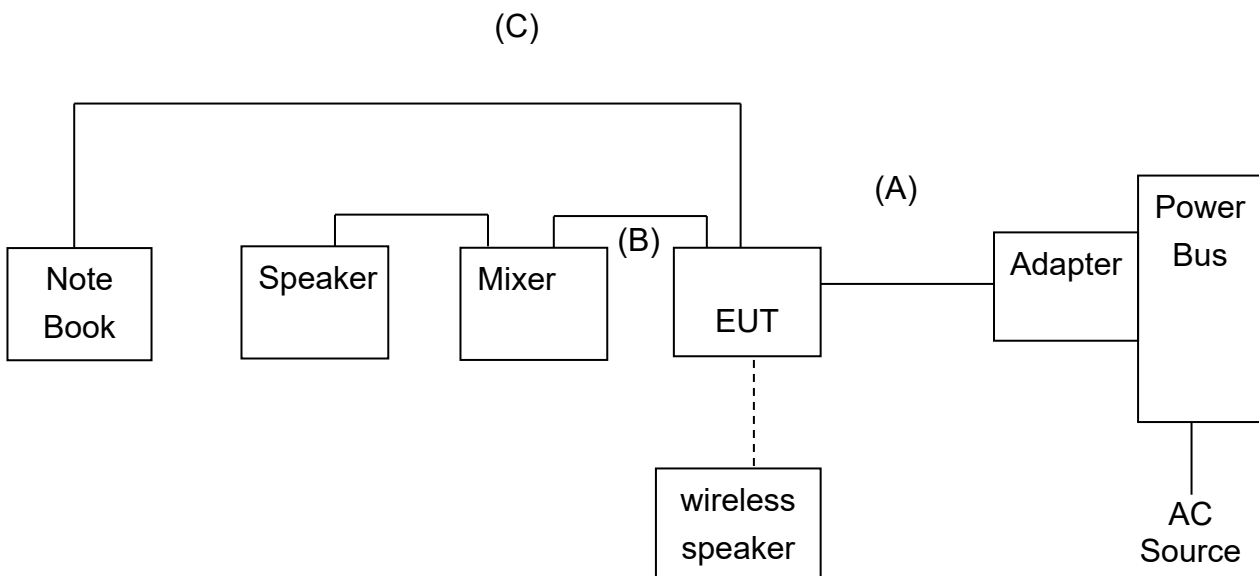

RF

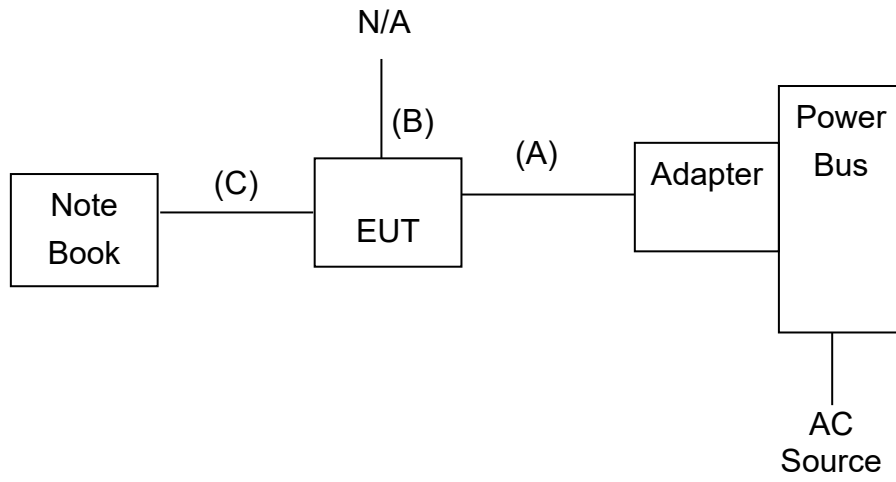

## 8.2 SUPPORT EQUIPMENT

### For EMI test

| No. | Product          | Manufacturer | Model No.     | Certify No. | Signal cable |
|-----|------------------|--------------|---------------|-------------|--------------|
| 1   | MIXER            | HANPIN       | HP-MU1        | N/A         | N/A          |
| 2   | NoteBook         | TOSHIBA      | PORTEGE R30-A | N/A         | N/A          |
| 3   | Wireless speaker | PHILIPS      | TAS1505       | N/A         | N/A          |
| 4   | Speaker system   | infotec      | Sp-102        | N/A         | N/A          |

| No. | Signal cable description |                          |
|-----|--------------------------|--------------------------|
| A   | DC Power                 | Unshielded, 1.5m, 1 pcs. |
| B   | AUDIO                    | Shielded, 1.0m, 1 pcs.   |
| C   | USB                      | Shielded, 1.5m, 1 pcs.   |

### For RF test

| No. | Product  | Manufacturer | Model No. | Certify No. | Signal cable         |
|-----|----------|--------------|-----------|-------------|----------------------|
| 1   | NoteBook | ACER         | Z5WEI     | N/A         | Non-shd, 1.8m, 1core |

| No. | Signal cable description |                                    |
|-----|--------------------------|------------------------------------|
| A   | DC Power                 | Unshielded, 1.5m, 1 pcs.           |
| B   | AUDIO                    | Shielded, 1.3m, 1 pcs.             |
| C   | USB                      | Shielded, 2.0m, 1 pcs. with 1 core |

#### Note:

- 1) All the equipment/cables were placed in the worst-case configuration to maximize the emission during the test.
- 2) Grounding was established in accordance with the manufacturer's requirements and conditions for the intended use.
- 3) shd. = shielded; unshd. = unshielded

Report No.: TMTN2305000660NR

## 8.3 EUT OPERATING CONDITION

### RF Setup

1. Set up all computers like the setup diagram.
2. The “Blue Test 3 V3.3.9.1137” software was used for testing
3. Choose Transport “DEBUG” and Device “USB DBG(100)”

### BT1.0 、 3.0

#### TX Mode:

PACKET TX

Channel 1~5: 0,39,78

GFSK(DH1):

Packet Type:DH1 > Packet Length 27

Power(0-9) : 6

GFSK(DH3):

Packet Type:DH3 > Packet Length 183

Power(0-9) : 6

GFSK(DH5):

Packet Type:DH5 > Packet Length 339

Power(0-9) : 6

8-DPSK(3DH1):

Packet Type:3DH1 > Packet Length 83

Power(0-9) : 6

8-DPSK(3DH3):

Packet Type:3DH3 > Packet Length 552

Power(0-9) : 6

8-DPSK(3DH5):

Packet Type:3DH5 > Packet Length 1021

Power(0-9) : 6

#### RX Mode:

PACKET TX

**BT4.0 、 5.0**

**TX Mode:**

BLE TEST TX

Channel > 0,20,39 (0-39)

Length > 37

Bit pattern > Pseudo-rdm 9

PHY > 1M (2M)

**RX Mode:**

BLE TEST RX

Channel > 0 (0-39)

PHY > 1M (2M)

4. All of the function are under run.
5. Start test.



## 9. APPLICABLE LIMITS AND TEST RESULTS

### 9.1 6dB BANDWIDTH

#### LIMIT

§ 15.207(a) (2) For direct sequence systems, the minimum 6dB bandwidth shall be at least 500kHz

#### TEST SETUP

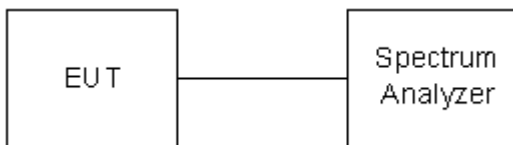

#### TEST PROCEDURE

- a) Set RBW = 100 kHz.
- b) Set the video bandwidth (VBW)  $\geq 3 \times$  RBW.
- c) Detector = Peak.
- d) Trace mode = max hold.
- e) Sweep = auto couple.
- f) Allow the trace to stabilize.
- g) Measure the maximum width of the emission that is constrained by the frequencies associated with the two outermost amplitude points (upper and lower frequencies) that are attenuated by 6 dB relative to the maximum level measured in the fundamental emission.

**TEST RESULTS**

No non-compliance noted.

|                            |             |                  |            |
|----------------------------|-------------|------------------|------------|
| <b>Model Name</b>          | PS-LX310BT  | <b>Test By</b>   | Peter Chu  |
| <b>Temp &amp; Humidity</b> | 25.5°C, 51% | <b>Test Date</b> | 2023/05/31 |

**GFSK(4.0) mode**

| Channel | Channel Frequency (MHz) | 6dB Bandwidth (kHz) | Minimum Limit (kHz) | Pass / Fail |
|---------|-------------------------|---------------------|---------------------|-------------|
| Low     | 2402                    | 723.00              | 500                 | PASS        |
| Middle  | 2442                    | 716.00              | 500                 | PASS        |
| High    | 2480                    | 714.00              | 500                 | PASS        |

**NOTE :**

1. At final test to get the worst-case emission at 1Mbps long.
2. The cable assembly insertion loss of 11.1dB (including 10 dB pad and 1.1 dB cable) was entered as an offset in the spectrum analyzer to allow for direct reading of power.

**GFSK(5.0) mode**

| Channel | Channel Frequency (MHz) | 6dB Bandwidth (kHz) | Minimum Limit (kHz) | Pass / Fail |
|---------|-------------------------|---------------------|---------------------|-------------|
| Low     | 2402                    | 1250.00             | 500                 | PASS        |
| Middle  | 2442                    | 1250.00             | 500                 | PASS        |
| High    | 2480                    | 1290.00             | 500                 | PASS        |

**NOTE :**

1. At final test to get the worst-case emission at 1Mbps long.
2. The cable assembly insertion loss of 11.1dB (including 10 dB pad and 1.1 dB cable) was entered as an offset in the spectrum analyzer to allow for direct reading of power.

## 6dB BANDWIDTH ( GFSK(4.0) MODE )

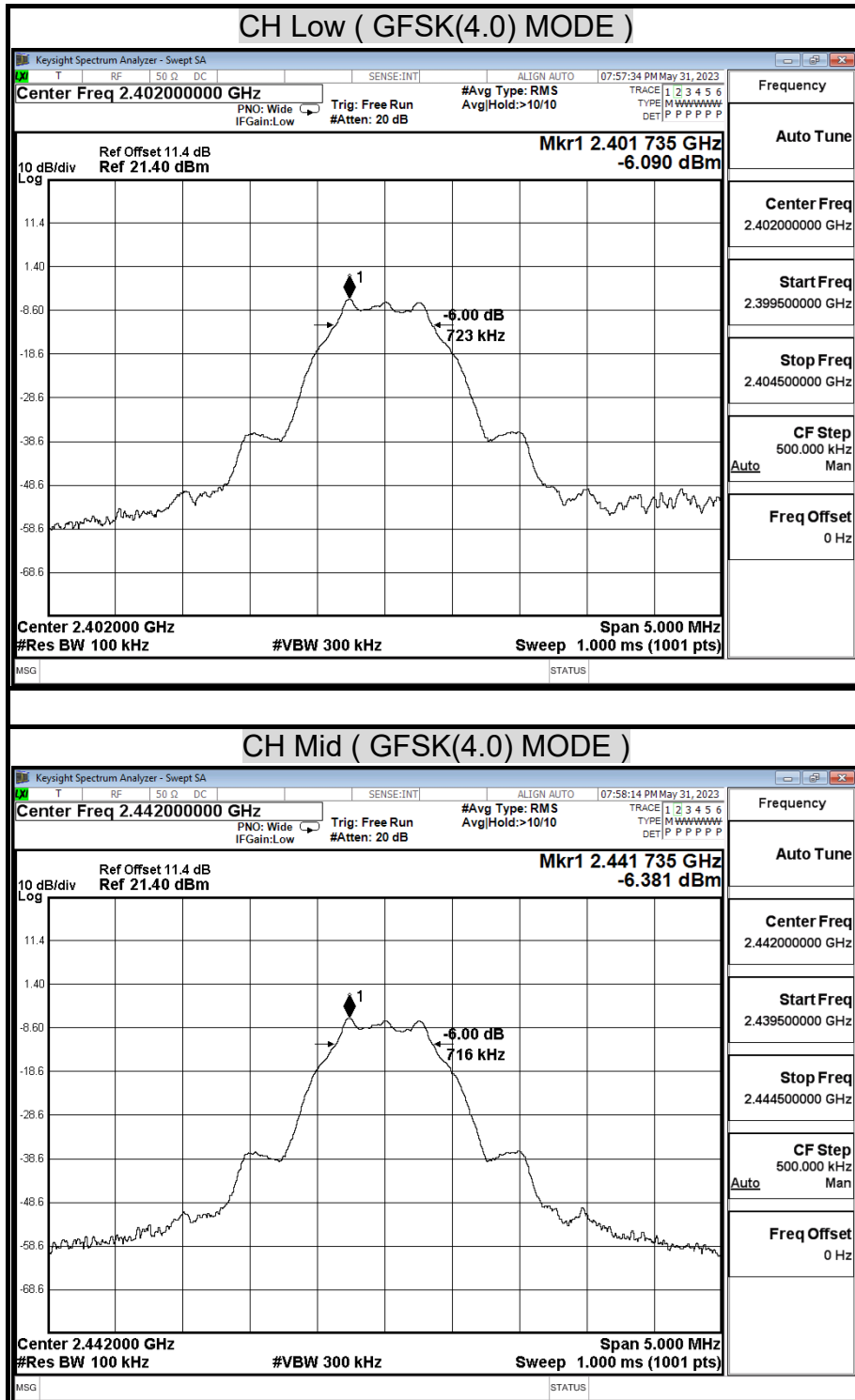

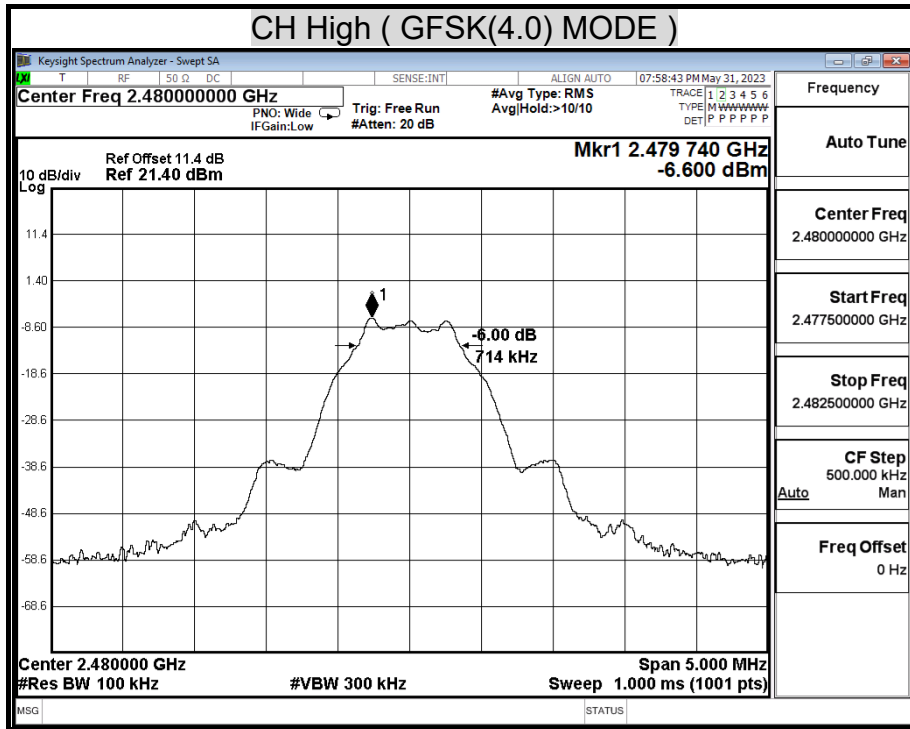

## 6dB BANDWIDTH ( GFSK(5.0) MODE)

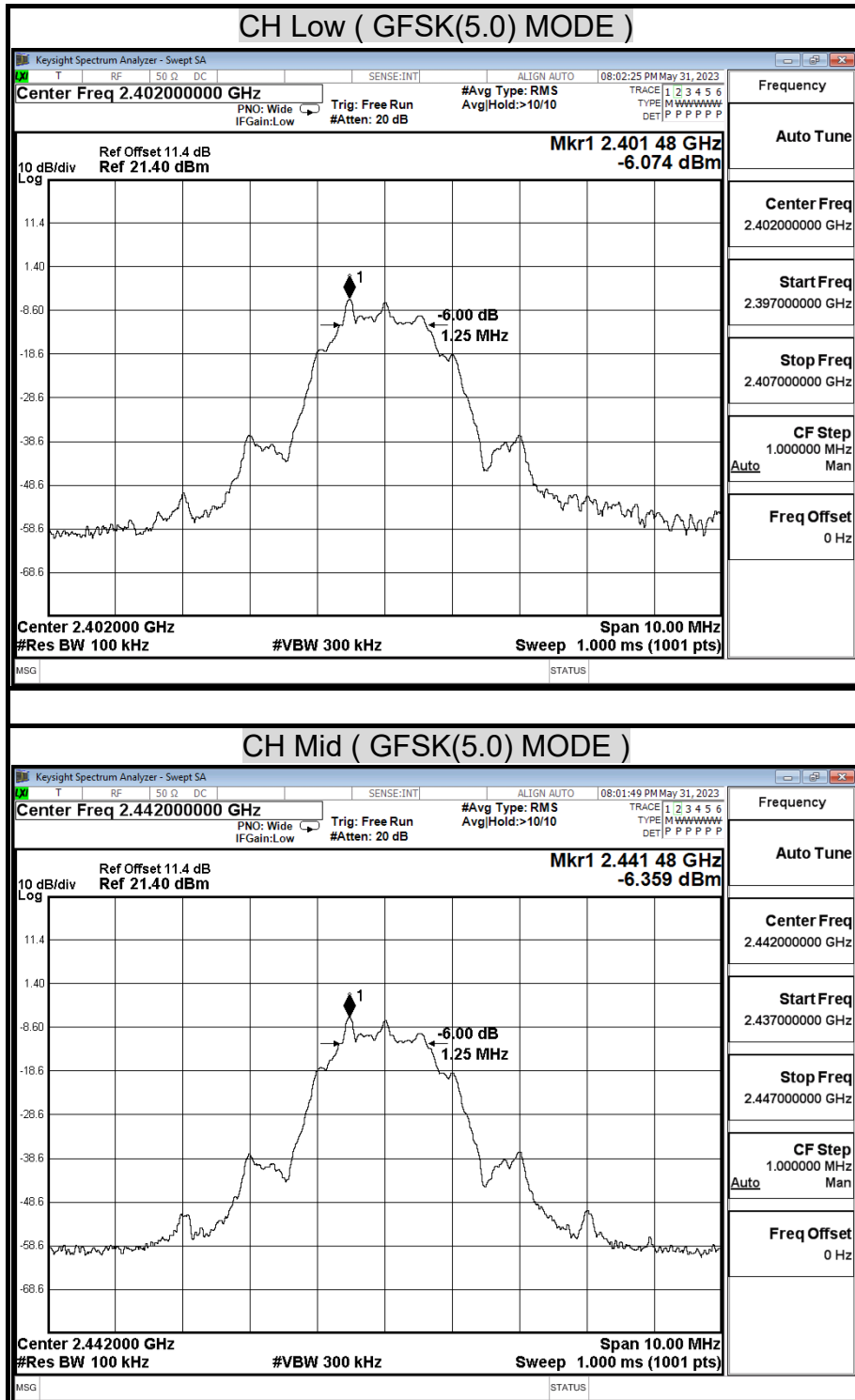

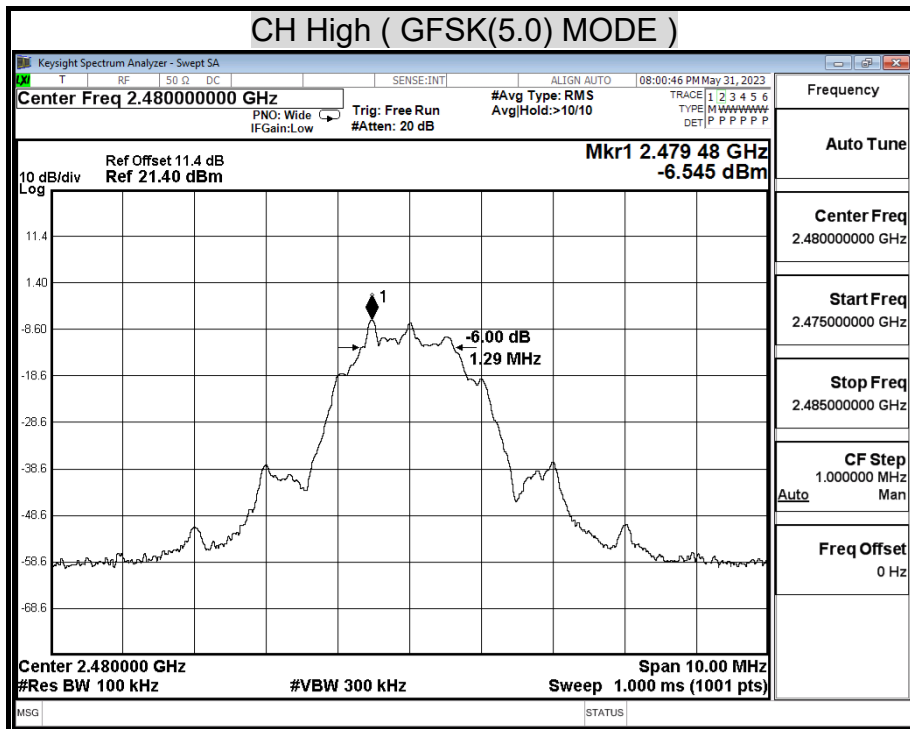

## 9.2 MAXIMUM PEAK OUTPUT POWER

### LIMIT

§ 15.247(b) The maximum peak output power of the intentional radiator shall not exceed the following :

§ 15.247(b) (3) For systems using digital modulation in the 902-928 MHz, 2400-2483.5 MHz, and 5725-5850 MHz bands : 1 watt.

§ 15.247(b) (4) Except as shown in paragraphs (c) of this section , if transmitting antennas of directional gain greater than 6 dBi are used the peak output power from the intentional radiator shall be reduced below the stated values in paragraphs (b)(1) or (b)(2), and (b)(3) of this section , as appropriate, by the amount in dB that the directional gain of the antenna exceeds 6 dBi.

### TEST SETUP

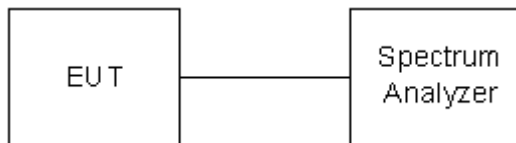

## **TEST PROCEDURE**

The tests were performed in accordance with KDB 558074 9.1.1

### **9.2.1 Measurement Procedure PK2:**

Peak Power set:

1. Set the RBW = 1 MHz.
2. Set the VBW  $\geq [3 \times \text{RBW}]$ .
3. Set the span  $\geq [1.5 \times \text{DTS bandwidth}]$ .
4. Detector = peak.
5. Sweep time = auto couple.
6. Trace mode = max hold.
7. Allow trace to fully stabilize.
8. Use the instrument's band/channel power measurement function with the band limits set equal to the DTS bandwidth edges (for some instruments, this may require a manual override to select the peak detector). If the instrument does not have a band power function, then sum the spectrum levels (in linear power units) at intervals equal to the RBW extending across the DTS channel bandwidth.

### **Average Power**

Connect the EUT to power meter, set the center frequency of the power meter to the channel center frequency.

Average power set:

1. Measure the duty cycle  $D$  of the transmitter output signal
2. Set span to at least 1.5 times the OBW.
3. Set RBW = 1% to 5% of the OBW, not to exceed 1 MHz.
4. Set VBW  $\geq [3 \times \text{RBW}]$ .
5. Number of points in sweep  $\geq [2 \times \text{span} / \text{RBW}]$ . (This gives bin-to-bin spacing  $\leq \text{RBW} / 2$ , so that narrowband signals are not lost between frequency bins.)
6. Manually set sweep time  $\geq [10 \times (\text{number of points in sweep}) \times (\text{total ON/OFF period of the transmitted signal})]$ .
7. Set detector = RMS (power averaging).
8. Perform a single sweep.
9. Compute power by integrating the spectrum across the OBW of the signal using the instrument's band power measurement function with band limits set equal to the OBW band edges. If the instrument does not have a band power function, then sum the spectrum levels (in power units) at intervals equal to the RBW extending across the entire OBW.
10. Add  $[10 \log (1 / D)]$ , where  $D$  is the duty cycle, to the measured power to compute the average power during the actual transmission times.



**TEST RESULTS**

No non-compliance noted.

|                            |             |                  |            |
|----------------------------|-------------|------------------|------------|
| <b>Model Name</b>          | PS-LX310BT  | <b>Test By</b>   | Peter Chu  |
| <b>Temp &amp; Humidity</b> | 25.5°C, 51% | <b>Test Date</b> | 2023/05/31 |

**GFSK(4.0) mode**

| Channel | Channel Frequency (MHz) | Peak Power (dBm) | Peak Power Limit (dBm) | Pass / Fail |
|---------|-------------------------|------------------|------------------------|-------------|
| Low     | 2402                    | -6.109           | 30.00                  | PASS        |
| Middle  | 2442                    | -6.360           | 30.00                  | PASS        |
| High    | 2480                    | -6.538           | 30.00                  | PASS        |

**NOTE :** 1. At final test to get the worst-case emission at 1Mbps long.  
2. The cable assembly insertion loss of 11.45dB was entered as an offset in the power meter to allow for direct reading of power.

**GFSK(5.0) mode**

| Channel | Channel Frequency (MHz) | Peak Power (dBm) | Peak Power Limit (dBm) | Pass / Fail |
|---------|-------------------------|------------------|------------------------|-------------|
| Low     | 2402                    | -6.069           | 30.00                  | PASS        |
| Middle  | 2442                    | -6.357           | 30.00                  | PASS        |
| High    | 2480                    | -6.552           | 30.00                  | PASS        |

**NOTE :** 1. At final test to get the worst-case emission at 2Mbps long.  
2. The cable assembly insertion loss of 11.45dB was entered as an offset in the power meter to allow for direct reading of power.

### Average Power Data

|                            |             |                  |            |
|----------------------------|-------------|------------------|------------|
| <b>Model Name</b>          | PS-LX310BT  | <b>Test By</b>   | Peter Chu  |
| <b>Temp &amp; Humidity</b> | 25.5°C, 51% | <b>Test Date</b> | 2023/05/31 |

#### GFSK(4.0) mode

| Channel | Channel Frequency (MHz) | Average Power (dBm) |
|---------|-------------------------|---------------------|
| Low     | 2402                    | -6.560              |
| Middle  | 2442                    | -6.803              |
| High    | 2480                    | -6.978              |

#### GFSK(5.0) mode

| Channel | Channel Frequency (MHz) | Average Power (dBm) |
|---------|-------------------------|---------------------|
| Low     | 2402                    | -6.616              |
| Middle  | 2442                    | -6.945              |
| High    | 2480                    | -7.102              |

## MAXIMUM PEAK OUTPUT POWER ( GFSK(4.0) MODE )

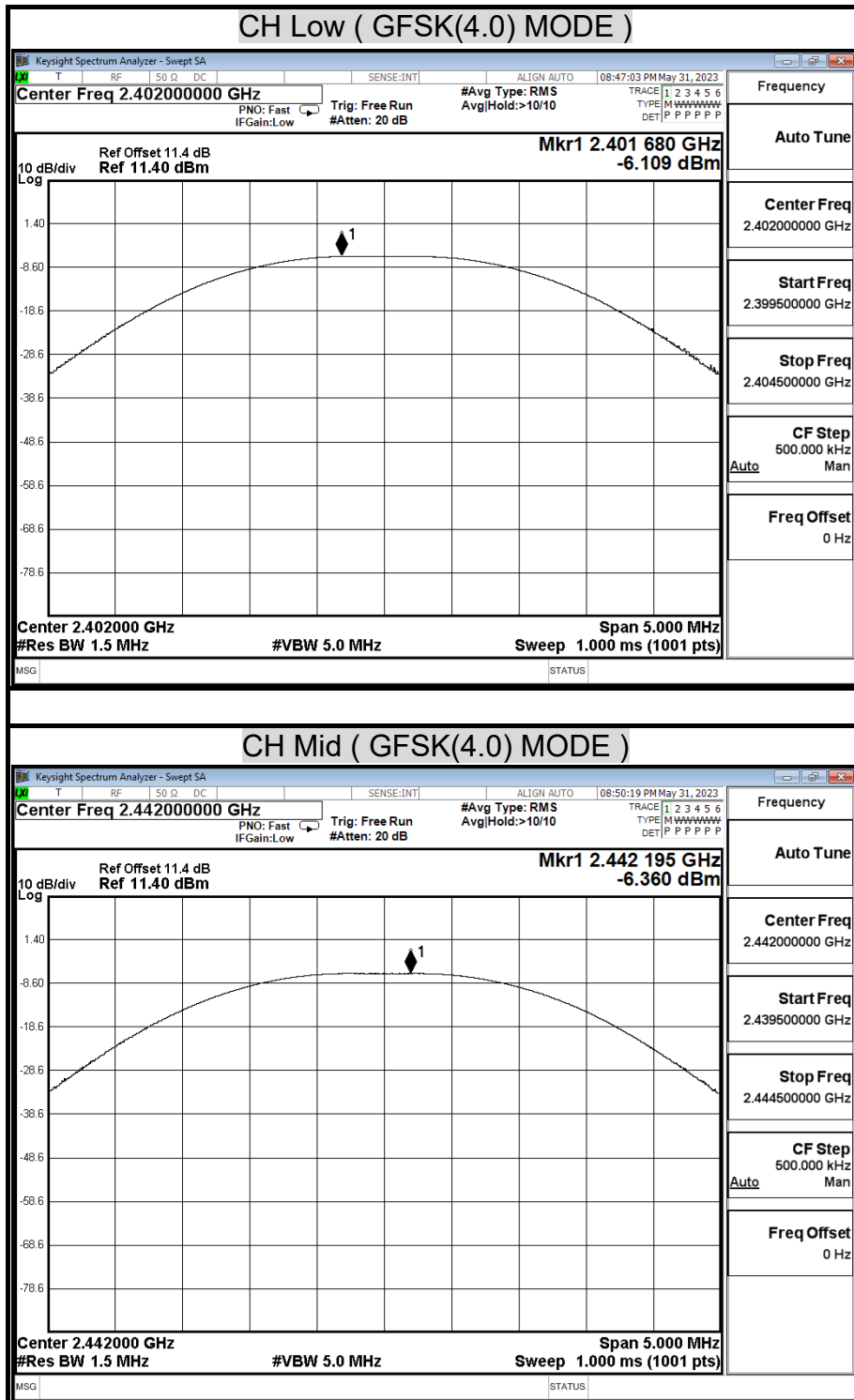

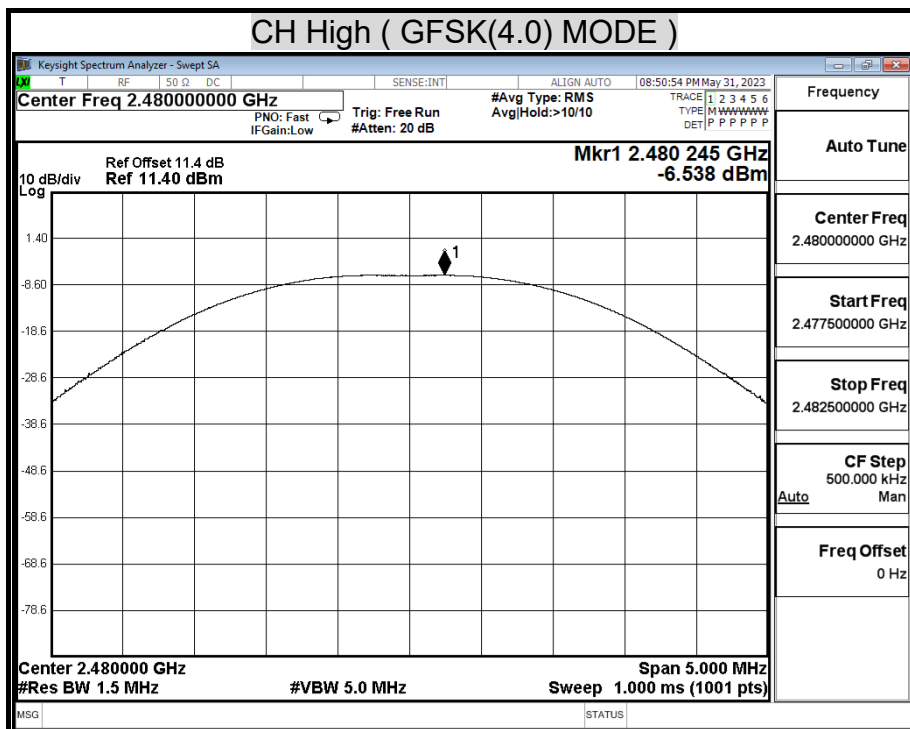

## MAXIMUM PEAK OUTPUT POWER ( GFSK(5.0) MODE)

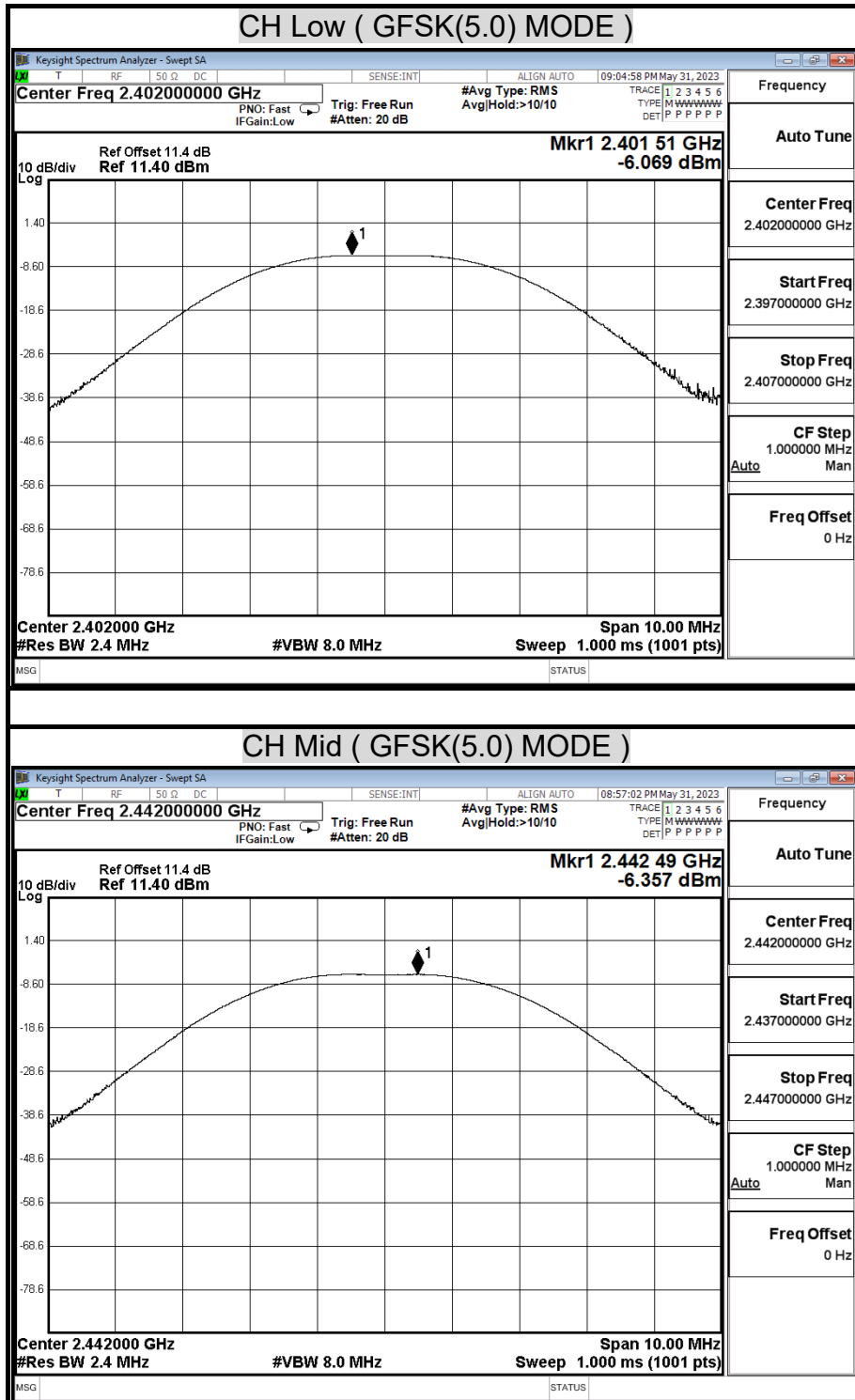

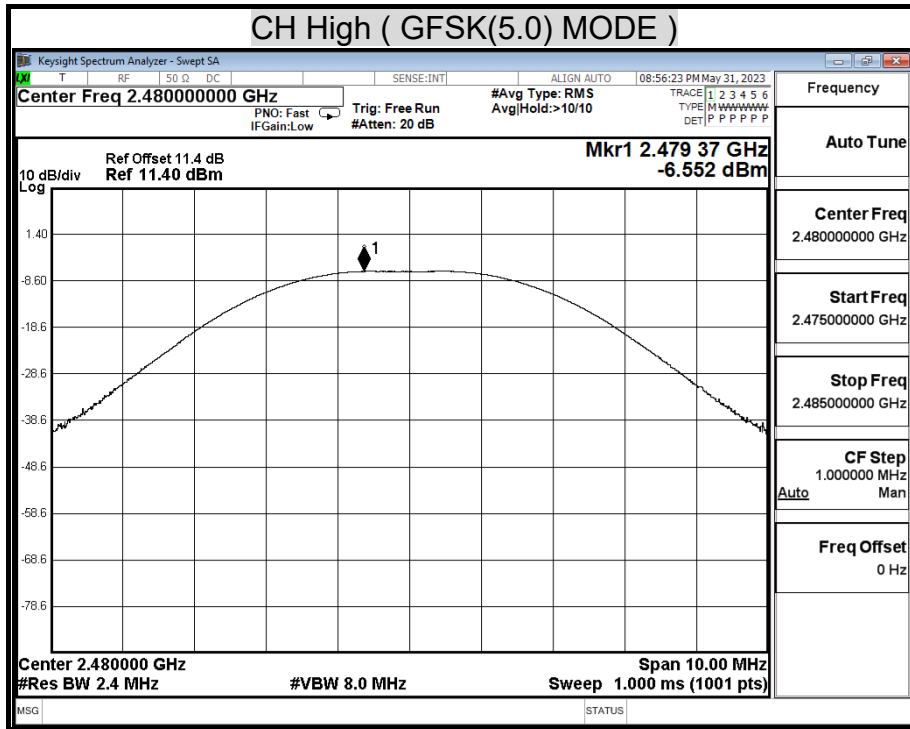

**MAXIMUM AVERAGE OUTPUT POWER ( GFSK(4.0) MODE )**

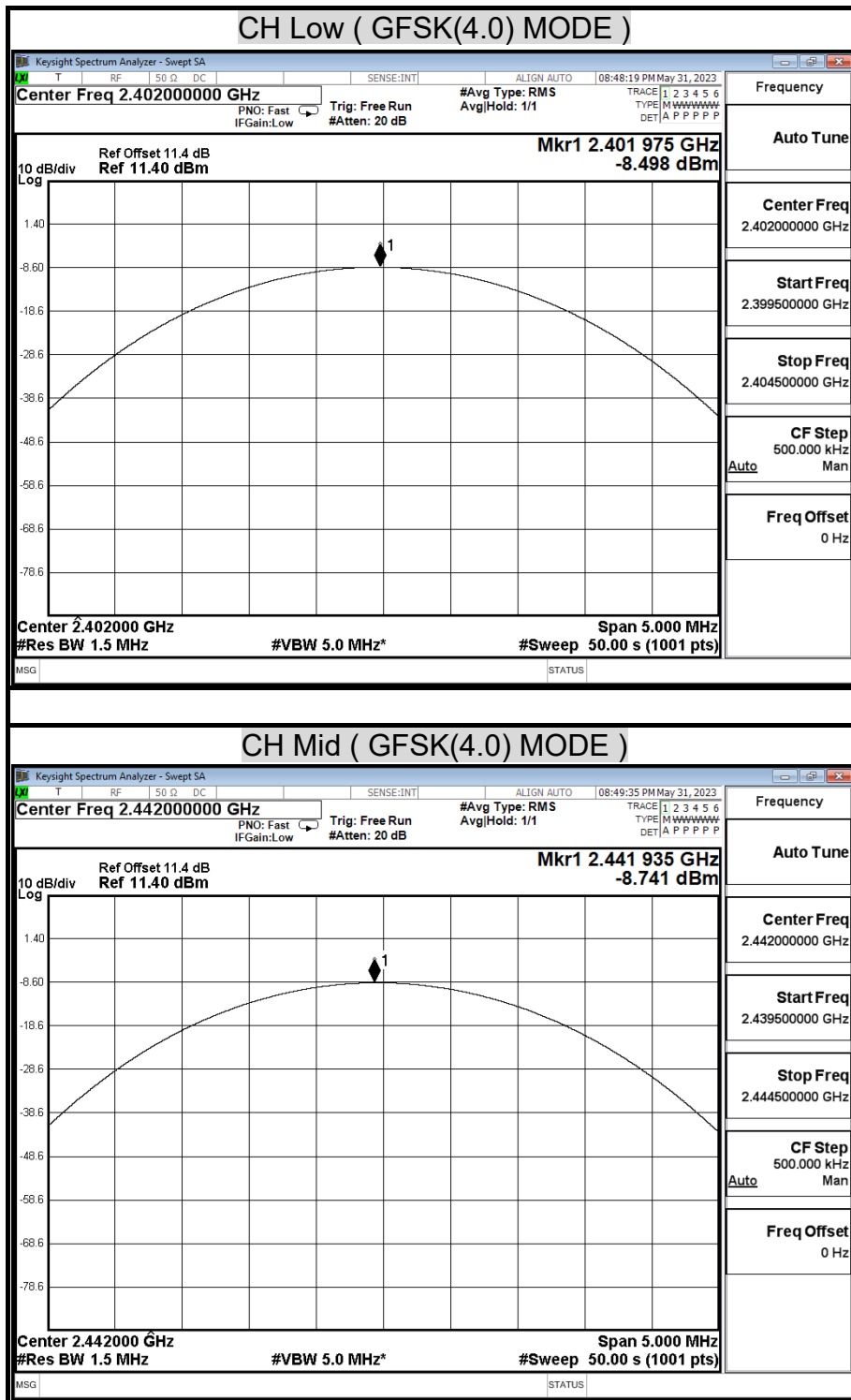

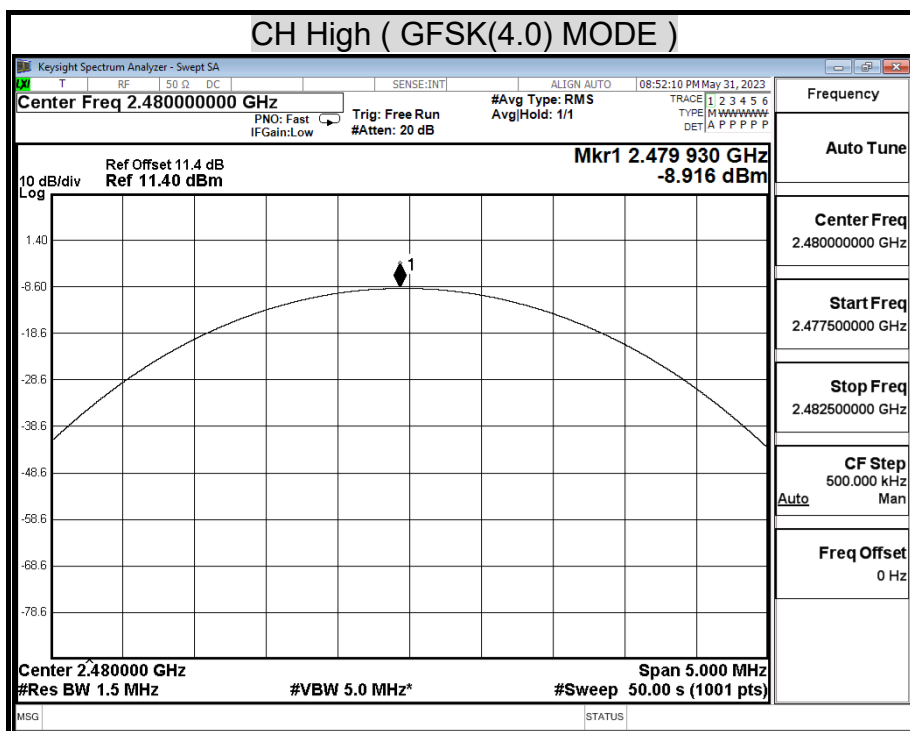



**MAXIMUM AVERAGE OUTPUT POWER ( GFSK(5.0) MODE )**

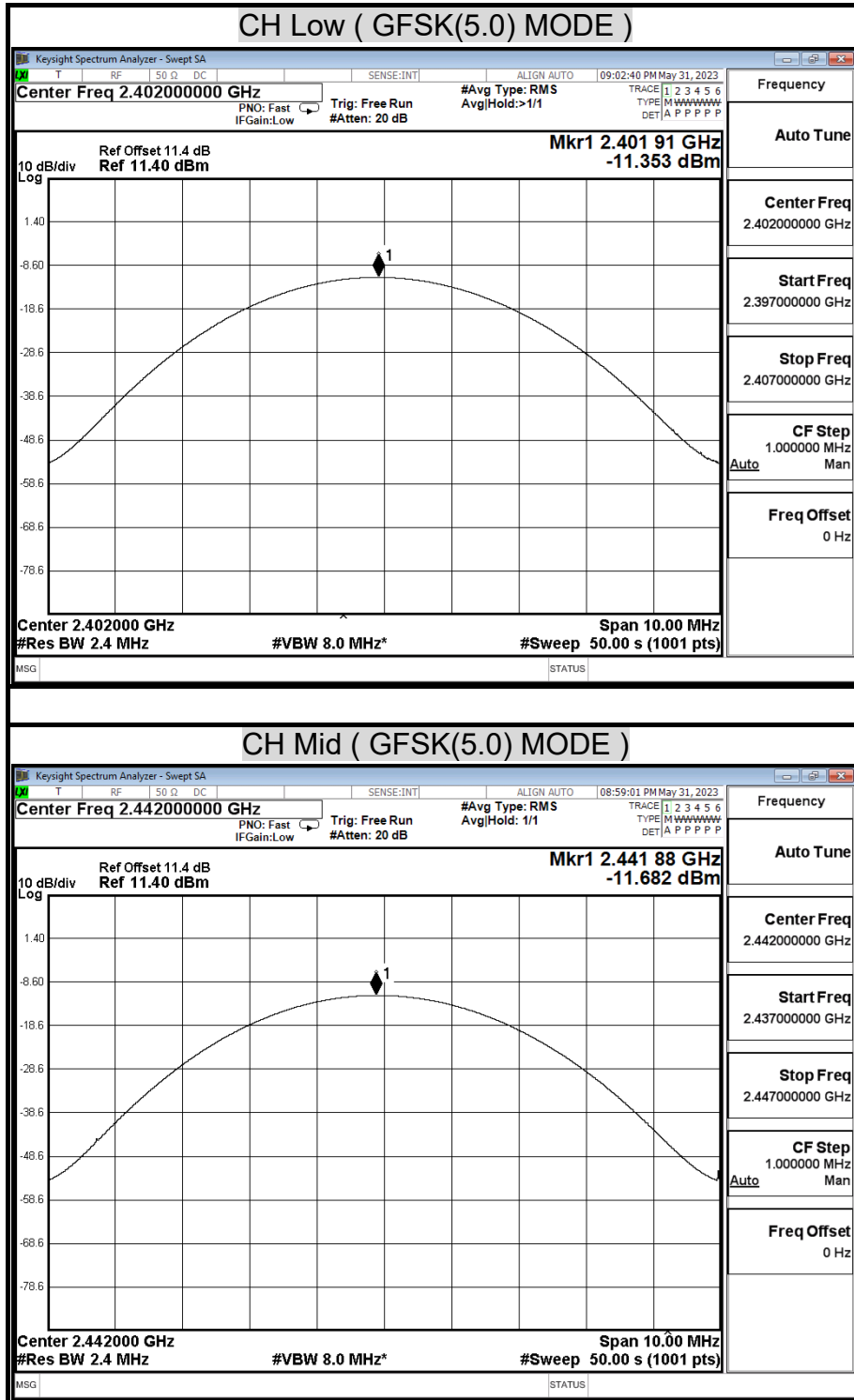

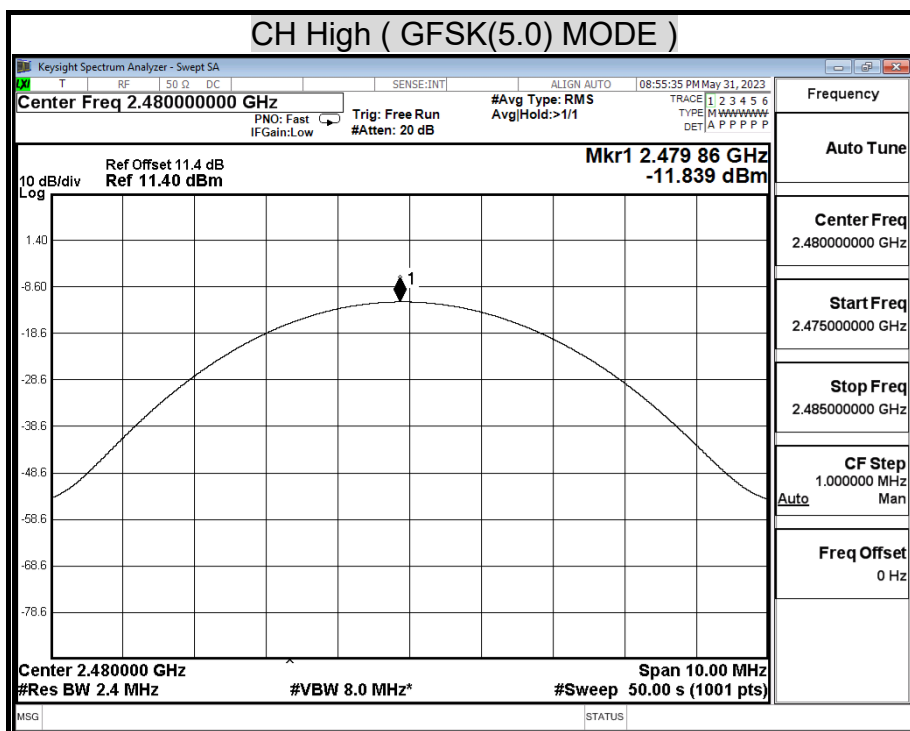

## 9.3 DUTY CYCLE

### LIMIT

Nil (No dedicated limit specified in the Rules)

### TEST SETUP

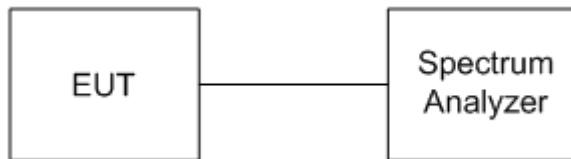

### TEST PROCEDURE

1. Place the EUT on the table and set it in transmitting mode.
2. Remove the antenna from the EUT and then connect a low loss RF cable from the antenna port to the spectrum analyzer.
3. The zero-span mode on a spectrum analyzer or EMI receiver if the response time and spacing between bins on the sweep are sufficient to permit accurate measurements of the on and off times of the transmitted signal. Set the center frequency of the instrument to the center frequency of the transmission. Set  $RBW \geq OBW$  if possible; otherwise, set RBW to the largest available value. Set  $VBW \geq RBW$ . Set detector = peak or average. The zero-span measurement method shall not be used unless both RBW and VBW are  $> 50/T$  and the number of sweep points across duration T exceeds 100. (For example, if VBW and/or RBW are limited to 3 MHz, then the zero-span method of measuring duty cycle shall not be used if  $T \leq 16.7$  microseconds.)

**TEST RESULTS**

No non-compliance noted.

|                            |             |                  |            |
|----------------------------|-------------|------------------|------------|
| <b>Model Name</b>          | PS-LX310BT  | <b>Test By</b>   | Peter Chu  |
| <b>Temp &amp; Humidity</b> | 25.5°C, 51% | <b>Test Date</b> | 2023/05/31 |

**GFSK(5.0) Mode**

|      | us      | Times | Ton Time(us) | Total Ton time(ms) |
|------|---------|-------|--------------|--------------------|
| Ton1 | 400.000 | 1     | 400          |                    |
| Ton2 |         | 0     | 0            |                    |
| Ton3 |         |       | 0            | 0.4                |
| Tp   |         |       |              | 0.625              |

|              |       |
|--------------|-------|
| Ton          | 0.400 |
| Tp(Ton+Toff) | 0.625 |
| Duty Cycle   | 0.640 |
| Duty Factor  | 1.938 |

**GFSK(5.0) Mode**

|      | us      | Times | Ton Time(us) | Total Ton time(ms) |
|------|---------|-------|--------------|--------------------|
| Ton1 | 210.000 | 1     | 210          |                    |
| Ton2 |         | 0     | 0            |                    |
| Ton3 |         |       | 0            | 0.21               |
| Tp   |         |       |              | 0.625              |

|              |       |
|--------------|-------|
| Ton          | 0.210 |
| Tp(Ton+Toff) | 0.625 |
| Duty Cycle   | 0.336 |
| Duty Factor  | 4.737 |

## TEST PLOT

### Duty Cycle

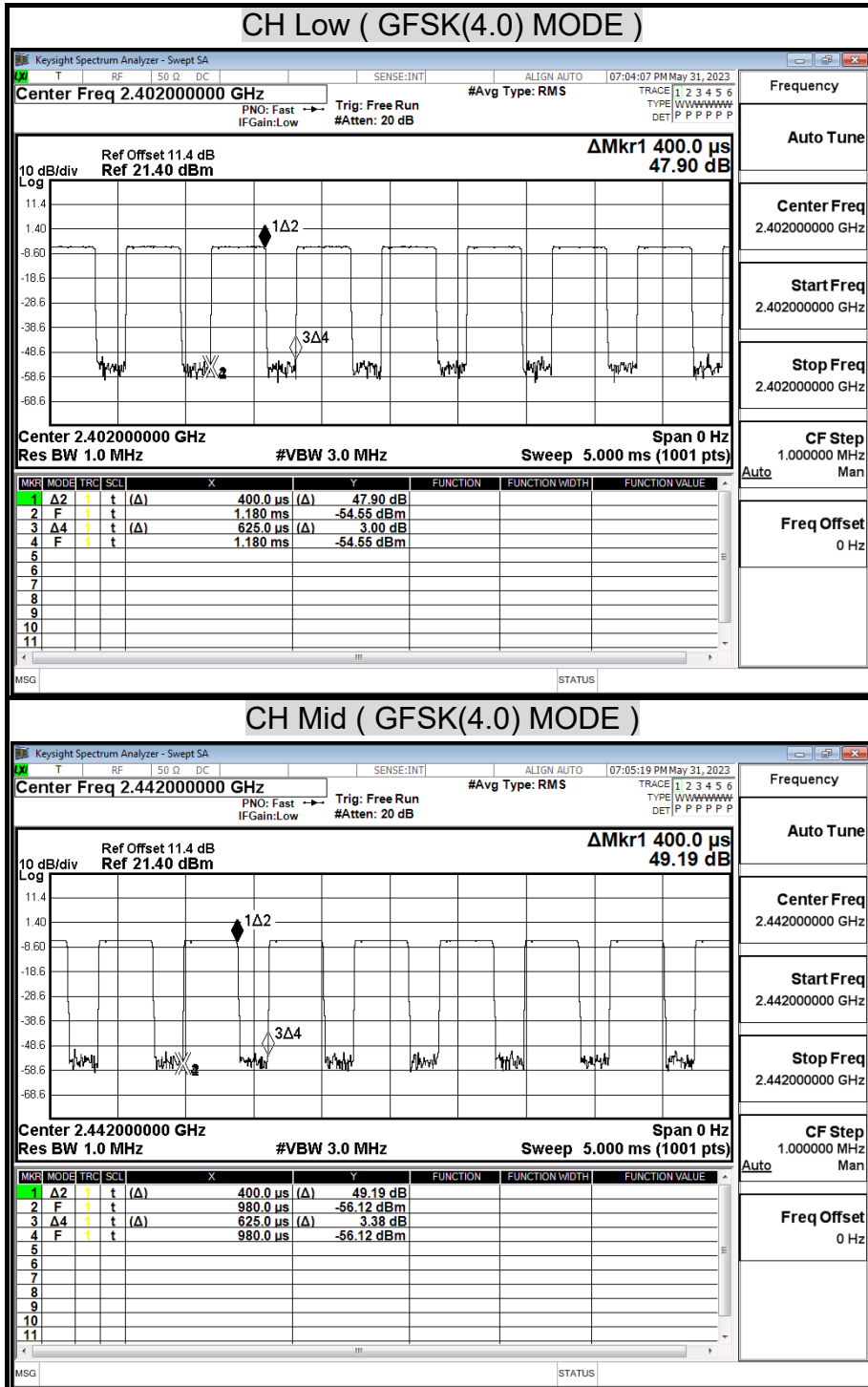

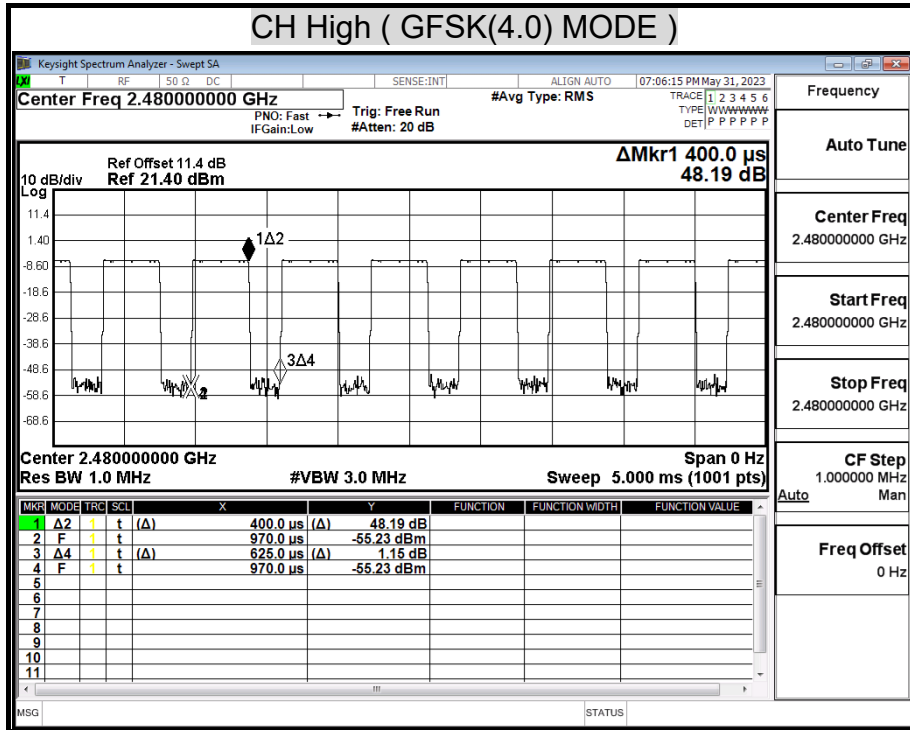

## Duty Cycle

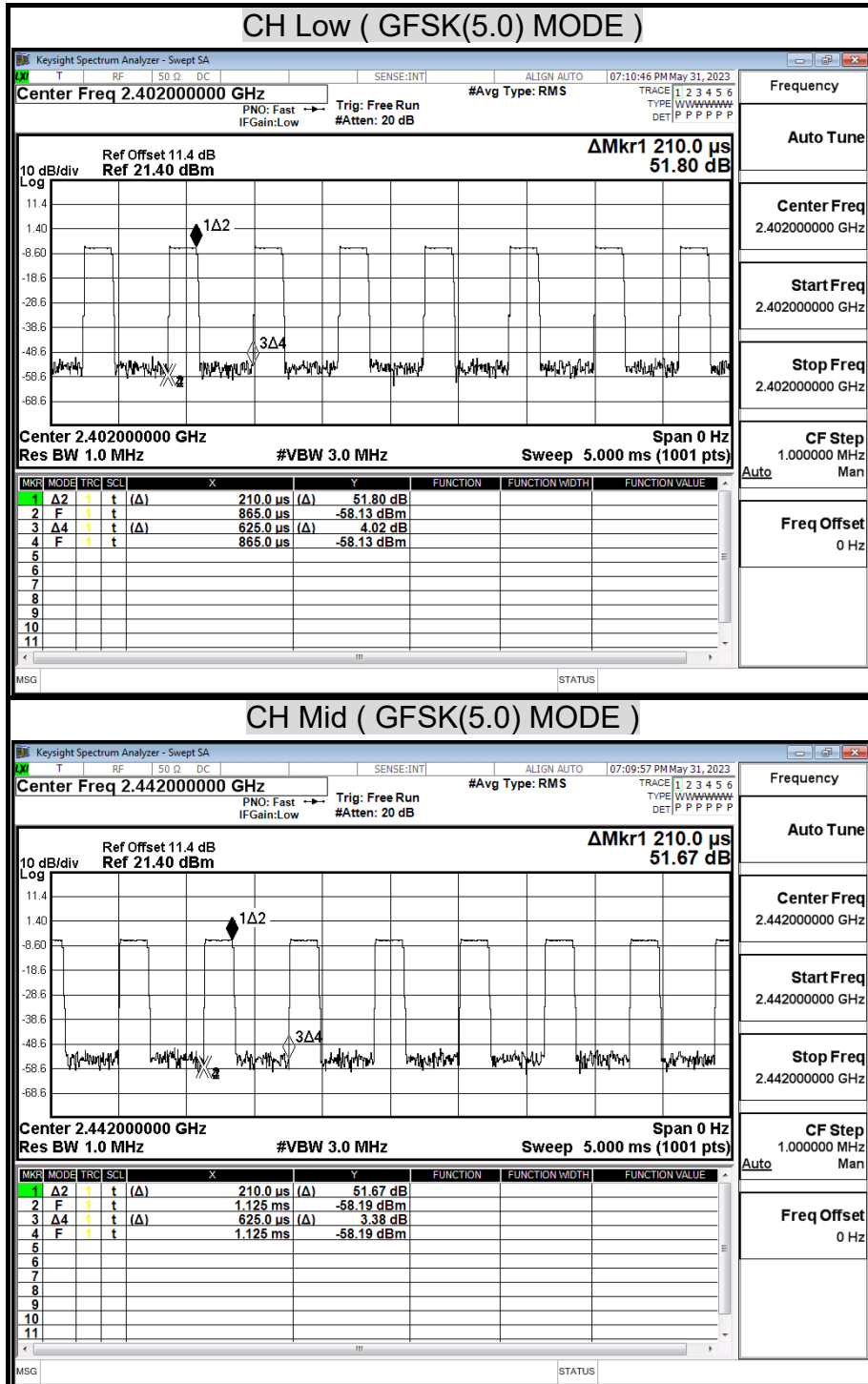

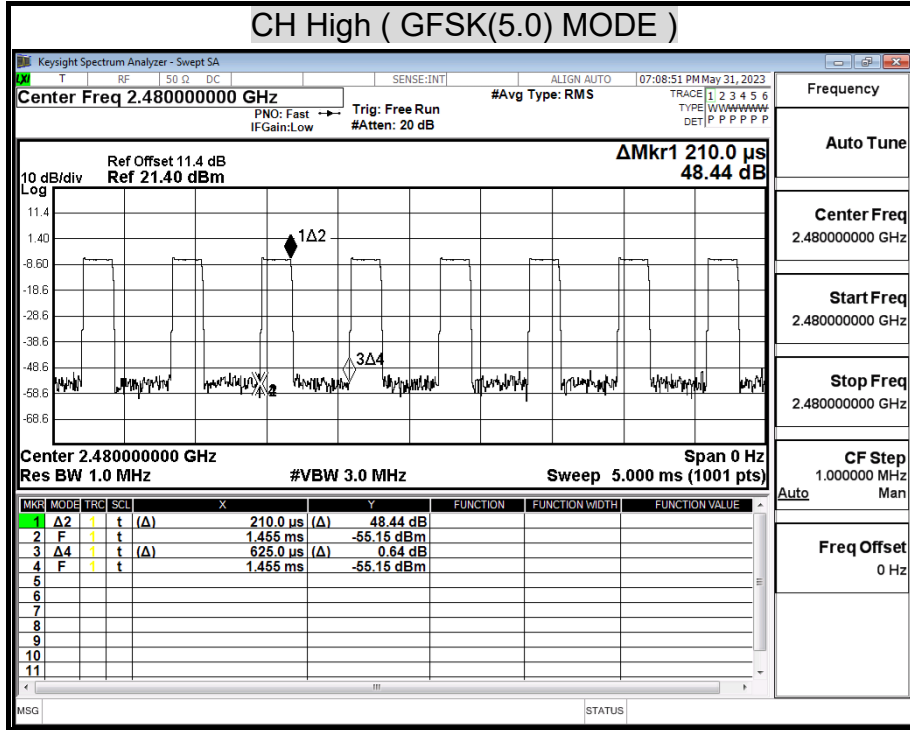



## 9.4 POWER SPECTRAL DENSITY

### LIMIT

§ 15.247(e) For digitally modulated systems, the power spectral density conducted from the intentional radiator to the antenna shall not greater than 8 dBm in any 3 kHz band during any time interval of continuous transmission.

### TEST SETUP

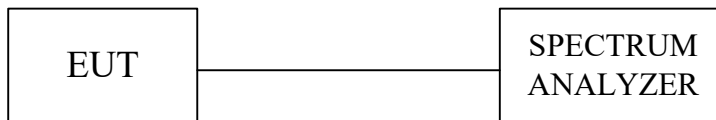

### TEST PROCEDURE

The tests were performed in accordance with 558074 D01 15.247 Meas Guidance v05

#### 10.2 Method PKPSD (peak PSD):

1. Set analyzer center frequency to DTS channel center frequency.
2. Set the span to 1.5 times the DTS bandwidth.
3. Set the RBW to:  $3 \text{ kHz} \leq \text{RBW} \leq 100 \text{ kHz}$ .
4. Set the VBW  $\geq 3 \times \text{RBW}$ .
5. Detector = peak.
6. Sweep time = auto couple.
7. Trace mode = max hold.
8. Allow trace to fully stabilize.
9. Use the peak marker function to determine the maximum amplitude level within the RBW.
10. If measured value exceeds limit, reduce RBW (no less than 3 kHz) and repeat.

**TEST RESULTS**

No non-compliance noted.

|                            |             |                  |            |
|----------------------------|-------------|------------------|------------|
| <b>Model Name</b>          | PS-LX310BT  | <b>Test By</b>   | Peter Chu  |
| <b>Temp &amp; Humidity</b> | 25.5°C, 51% | <b>Test Date</b> | 2023/05/31 |

**GFSK(4.0) mode**

| Channel | Frequency (MHz) | PPSD/3kHz (dBm) | Limit (dBm) | Margin (dB) | Result |
|---------|-----------------|-----------------|-------------|-------------|--------|
| Low     | 2402            | -21.79          | 8.00        | -29.79      | PASS   |
| Middle  | 2442            | -22.08          | 8.00        | -30.08      | PASS   |
| High    | 2480            | -22.23          | 8.00        | -30.23      | PASS   |

- NOTE :**
1. At final test to get the worst-case emission at 1Mbps long.
  2. The cable assembly insertion loss of 11.45dB was Entered as an offset in the spectrum analyzer to allow for direct reading of power.

**GFSK(5.0) mode**

| Channel | Frequency (MHz) | PPSD/3kHz (dBm) | Limit (dBm) | Margin (dB) | Result |
|---------|-----------------|-----------------|-------------|-------------|--------|
| Low     | 2402            | -25.25          | 8.00        | -33.25      | PASS   |
| Middle  | 2442            | -25.67          | 8.00        | -33.67      | PASS   |
| High    | 2480            | -25.82          | 8.00        | -33.82      | PASS   |

- NOTE :**
1. At final test to get the worst-case emission at 2Mbps long.
  2. The cable assembly insertion loss of 11.45dB was Entered as an offset in the spectrum analyzer to allow for direct reading of power.

## POWER SPECTRAL DENSITY ( GFSK(4.0) MODE)

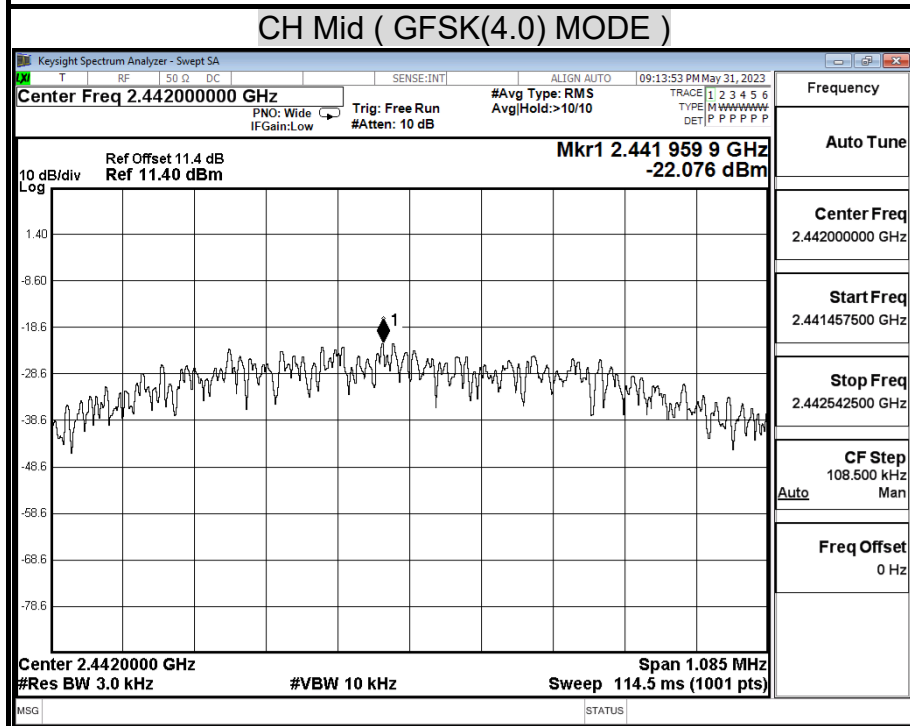
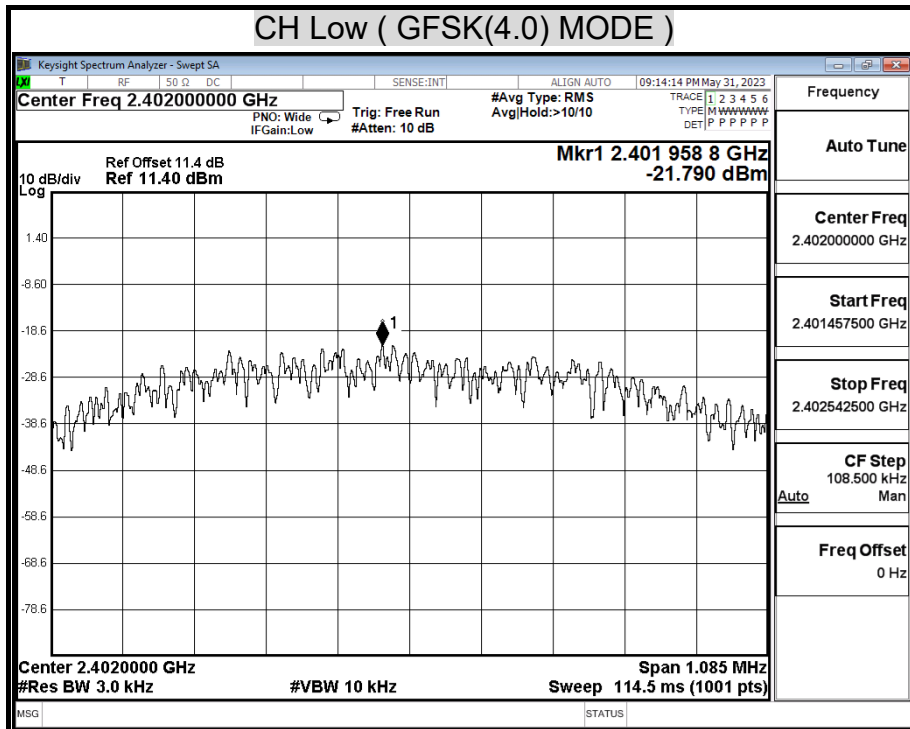

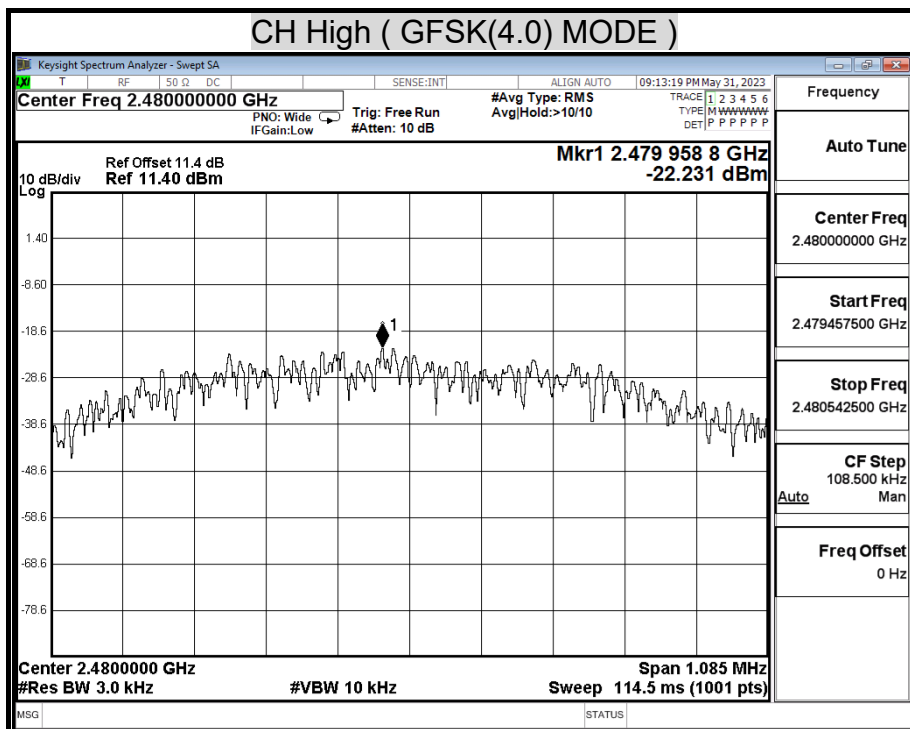

## POWER SPECTRAL DENSITY ( GFSK(5.0) MODE)

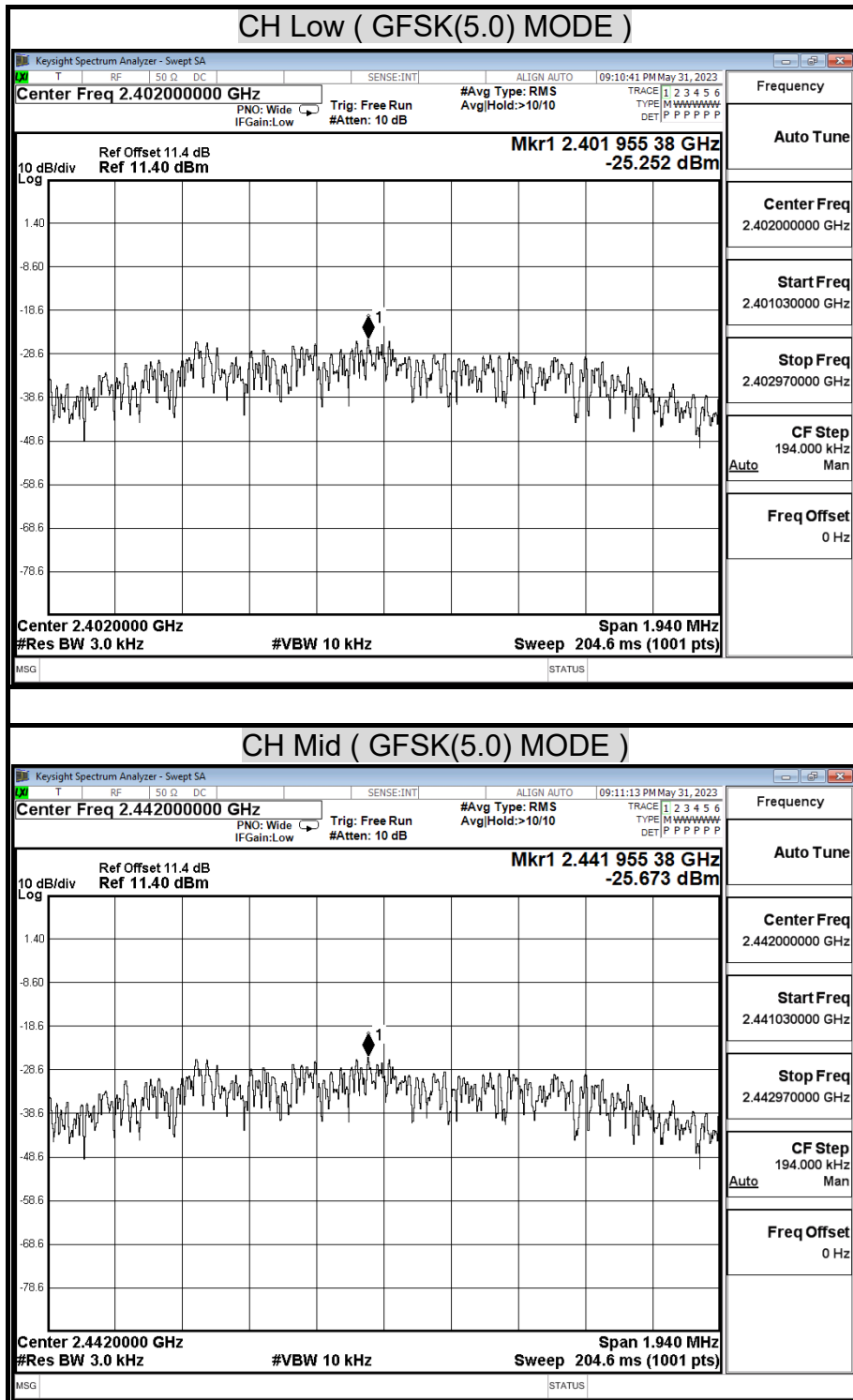

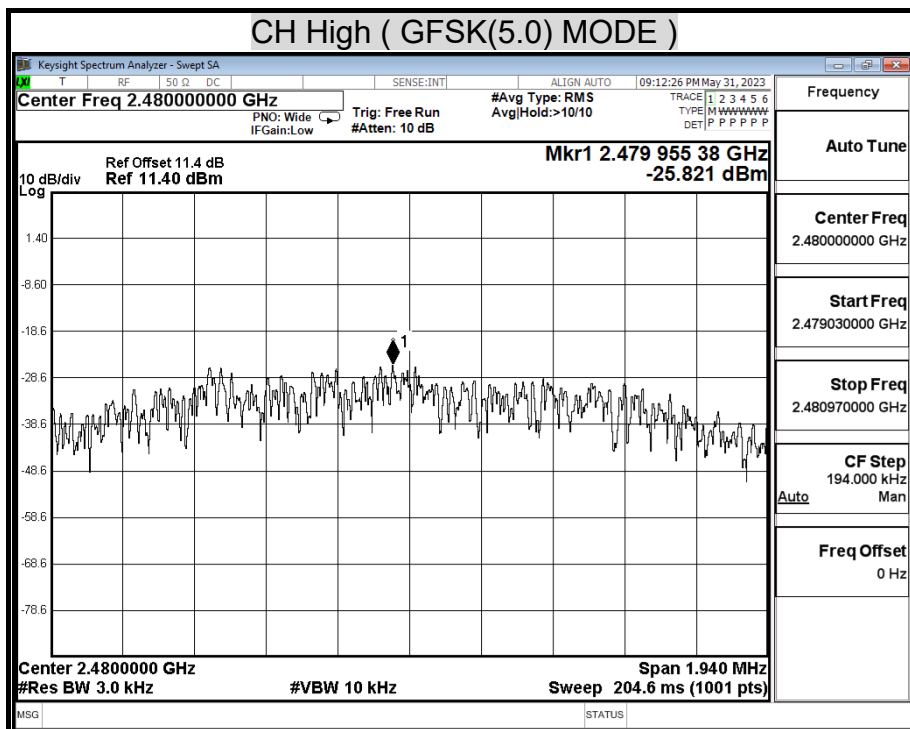

## 9.5 CONDUCTED SPURIOUS EMISSION

### LIMITS

§ 15.247(d) In any 100 kHz bandwidth outside the frequency band in which the spread spectrum intentional radiator is operating, the radio frequency power that is produced by the intentional radiator shall be at least 20 dB below that in the 100 kHz bandwidth within the and that contains the highest level of the desired power, based on either an RF conducted or a radiated measurement. Attenuation below the general limits specified in § 15.209(a) is not required. In addition, radiated emissions which fall in the restricted bands, as defined in § 15.205(a), must also comply with the radiated emission limits specified in § 15.209(a) (see § 15.205(c)).

### TEST SETUP



### TEST PROCEDURE

The transmitter output is connected to a spectrum analyzer. The resolution bandwidth is set to 100kHz, the video bandwidth is set to 300kHz.

The spectrum from 30 MHz to 26.5 GHz is investigated with the transmitter set to the lowest, middle, and highest channels in the 2.4 GHz band.

### TEST RESULTS

No non-compliance noted.

**TEST DATA**

|                            |             |                  |            |
|----------------------------|-------------|------------------|------------|
| <b>Model Name</b>          | PS-LX310BT  | <b>Test By</b>   | Peter Chu  |
| <b>Temp &amp; Humidity</b> | 25.5°C, 51% | <b>Test Date</b> | 2023/05/31 |

**OUT-OF-BAND SPURIOUS EMISSIONS-CONDUCTED MEASUREMENT**

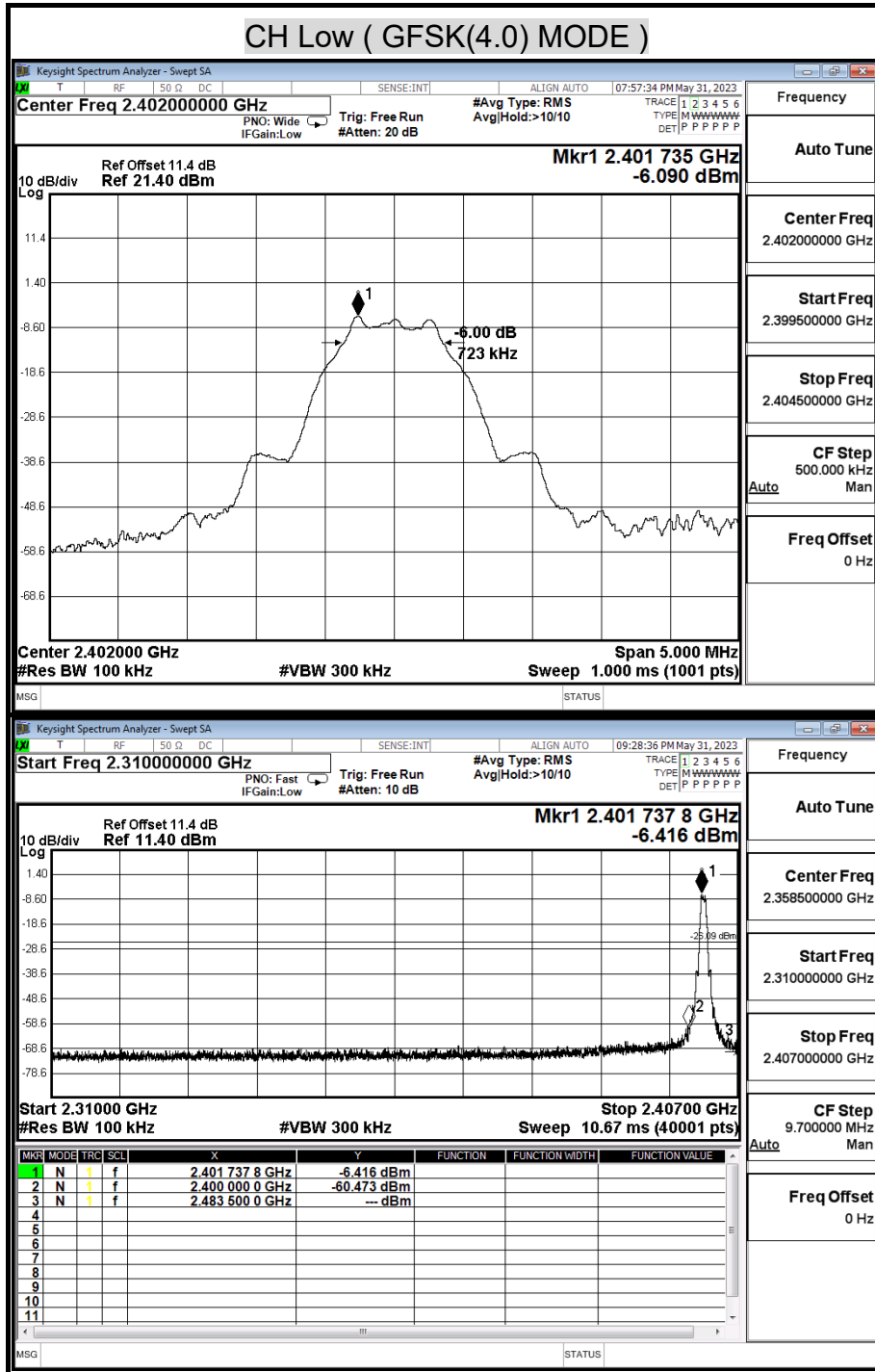



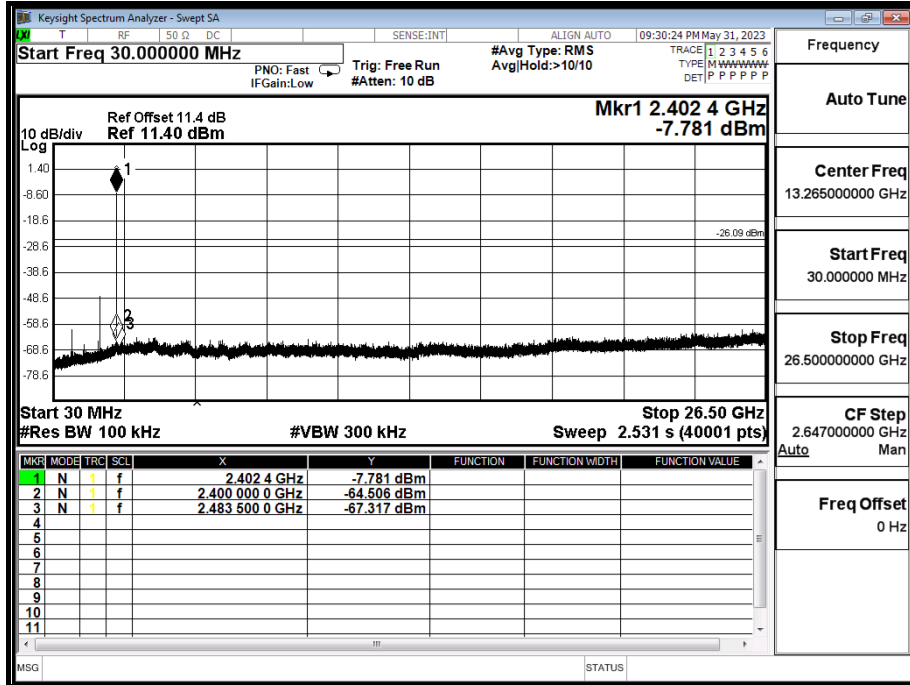

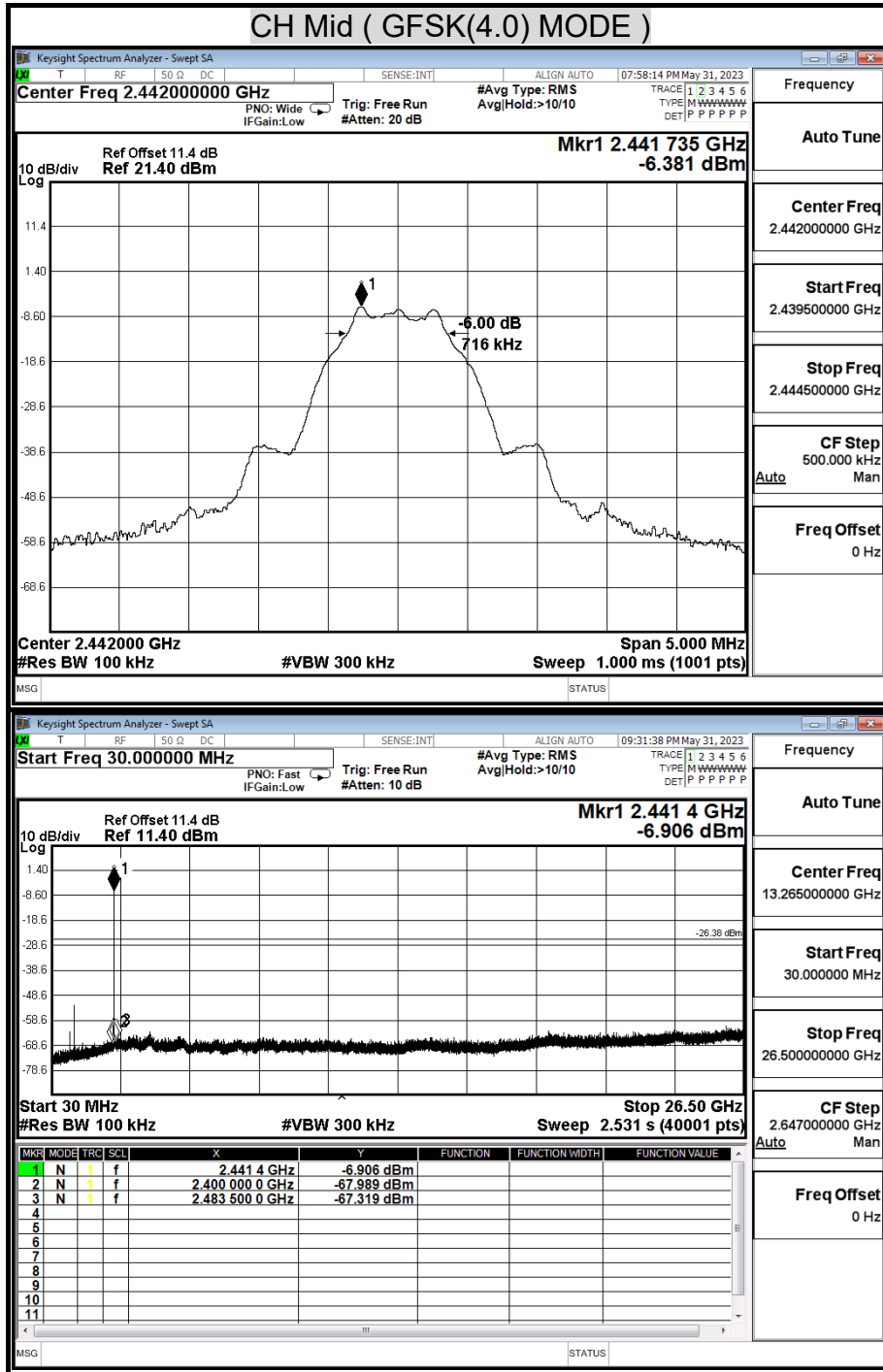

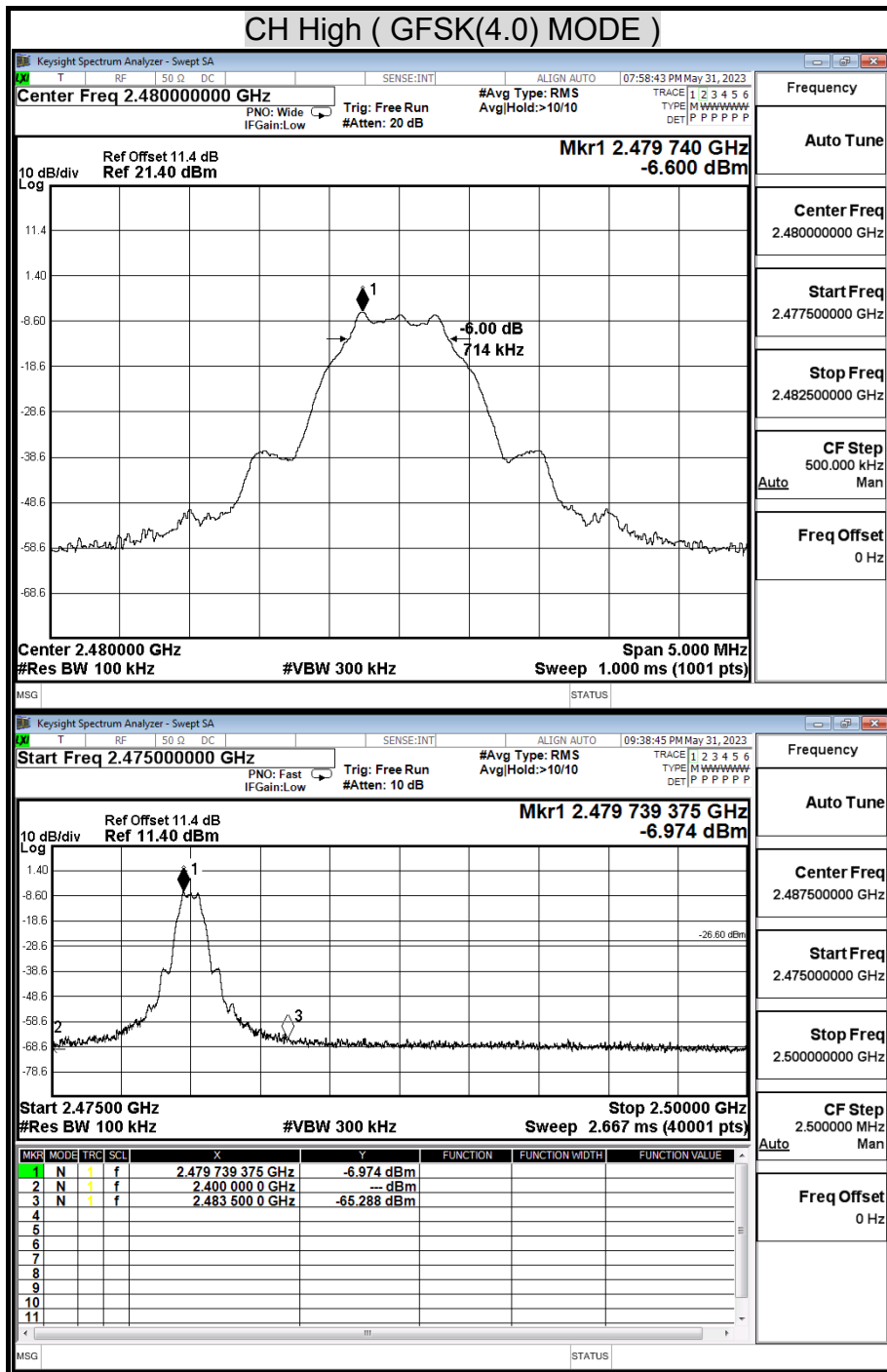

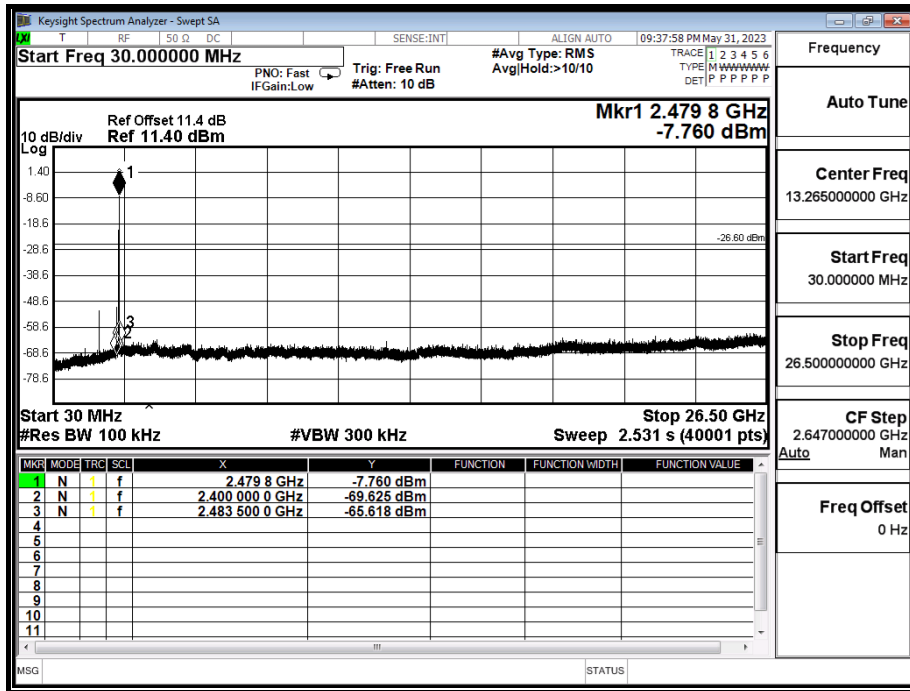

Report No.: TMTN2305000660NR

|                            |             |                  |            |
|----------------------------|-------------|------------------|------------|
| <b>Model Name</b>          | PS-LX310BT  | <b>Test By</b>   | Peter Chu  |
| <b>Temp &amp; Humidity</b> | 25.5°C, 51% | <b>Test Date</b> | 2023/05/31 |

## OUT-OF-BAND SPURIOUS EMISSIONS-CONDUCTED MEASUREMENT

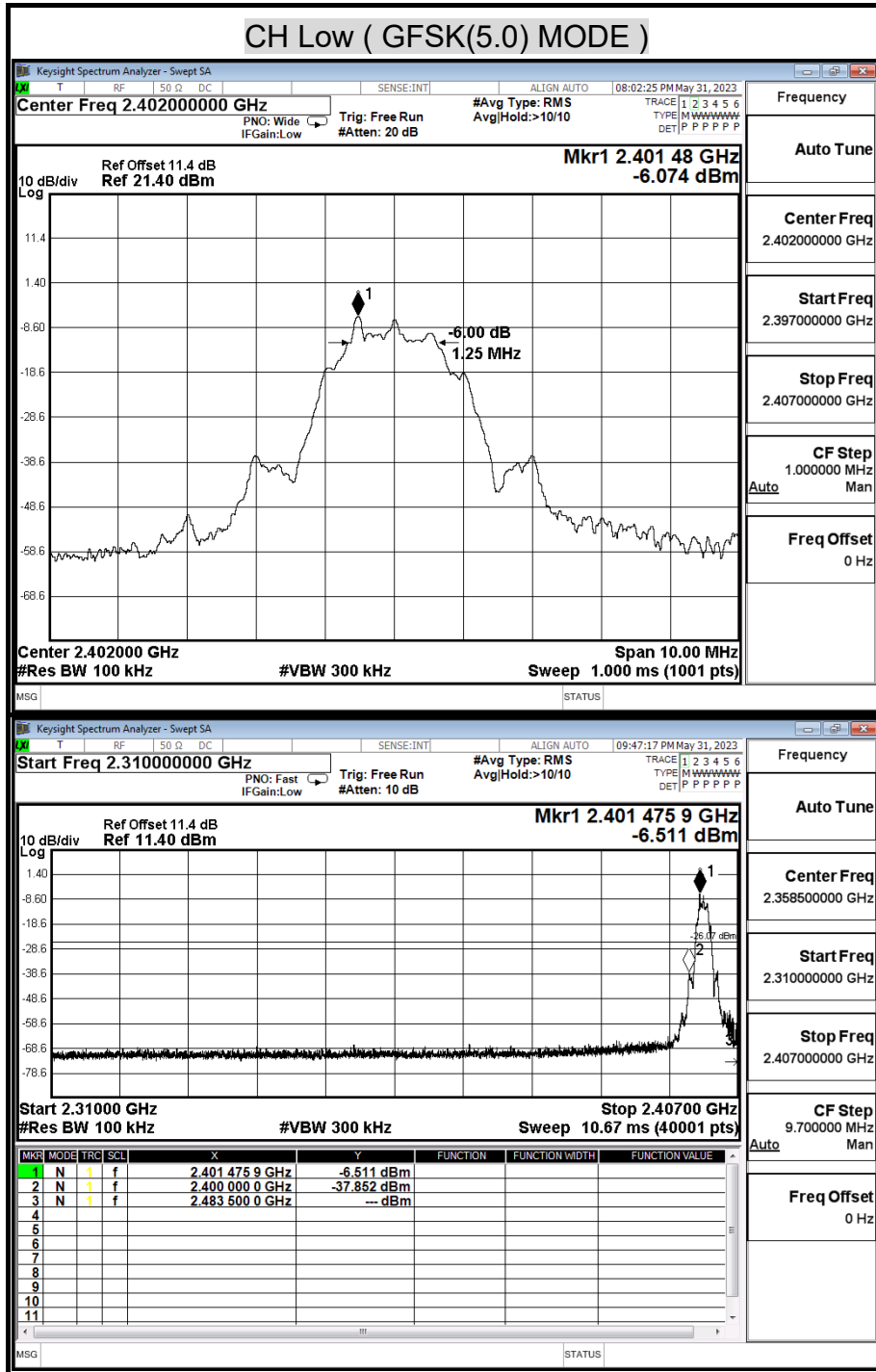

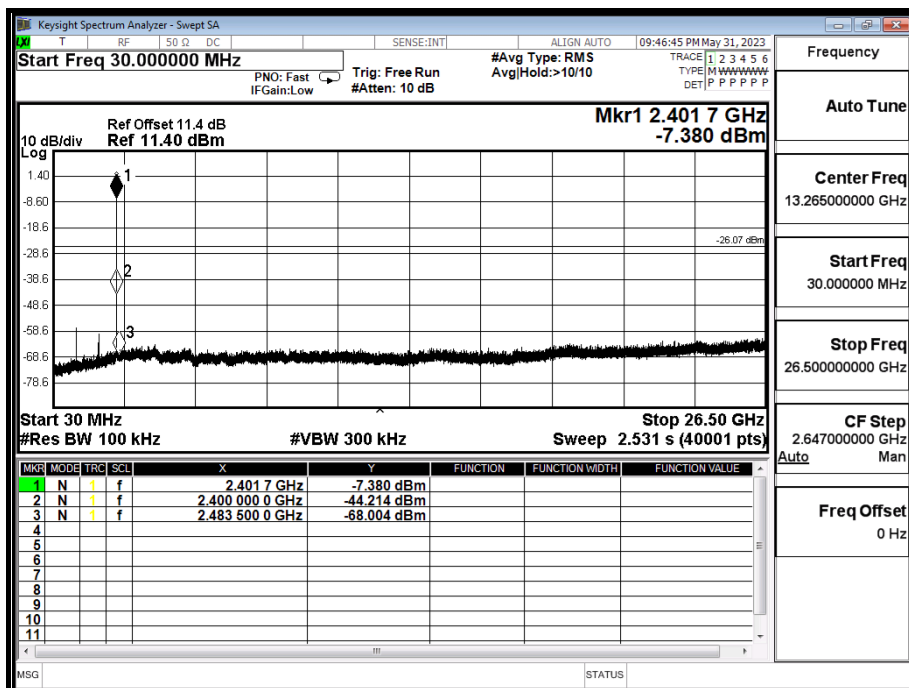

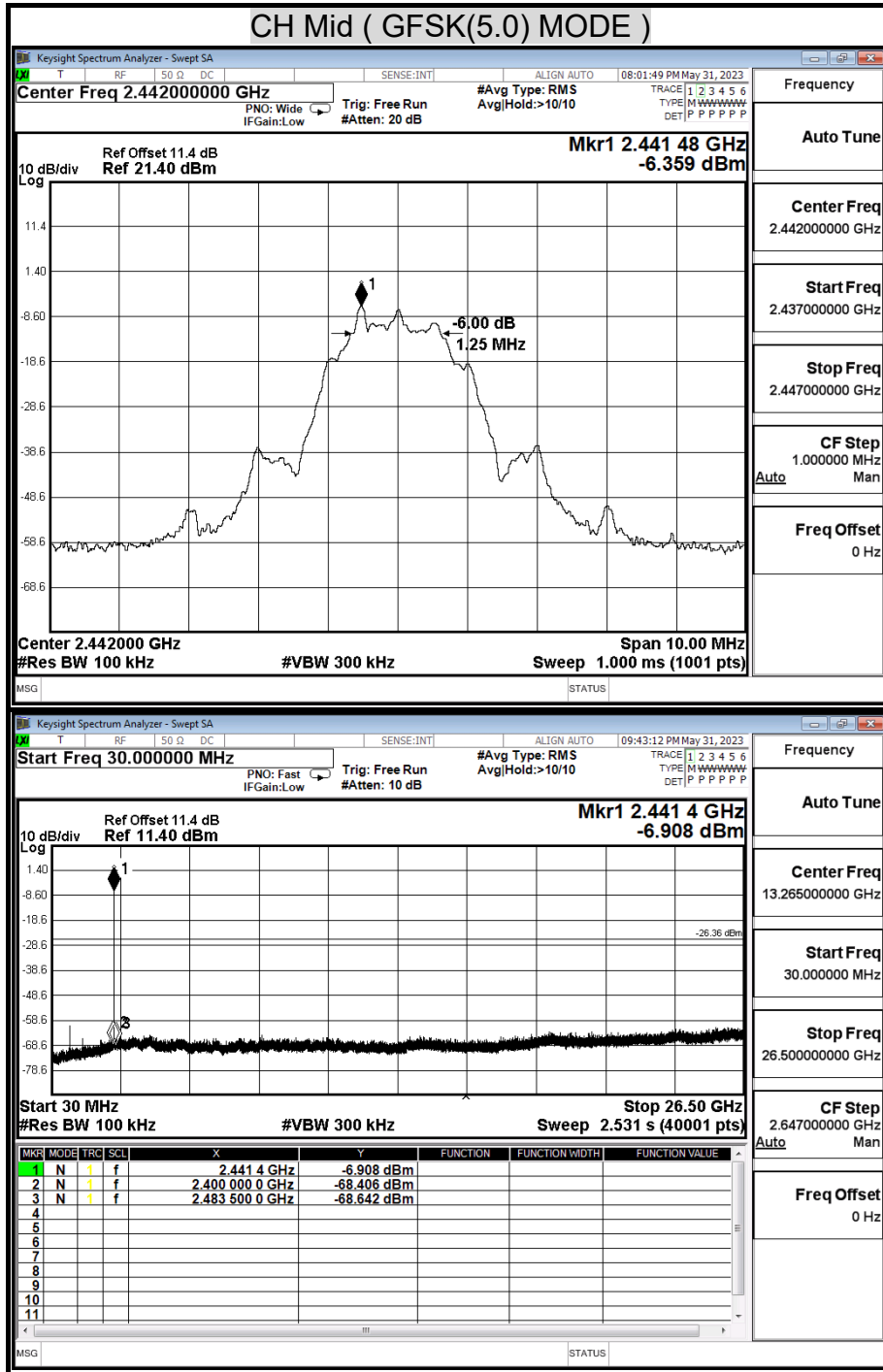

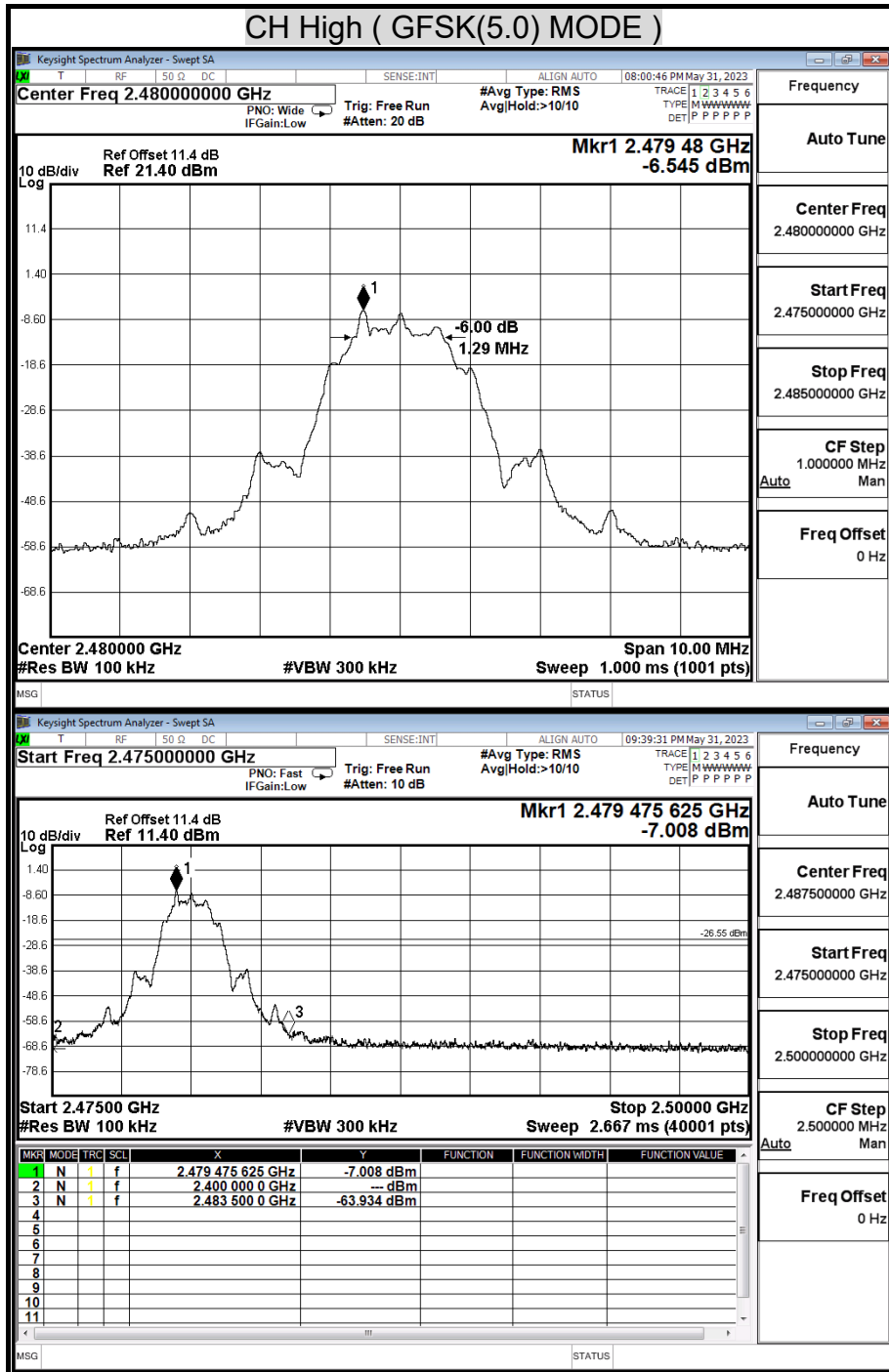



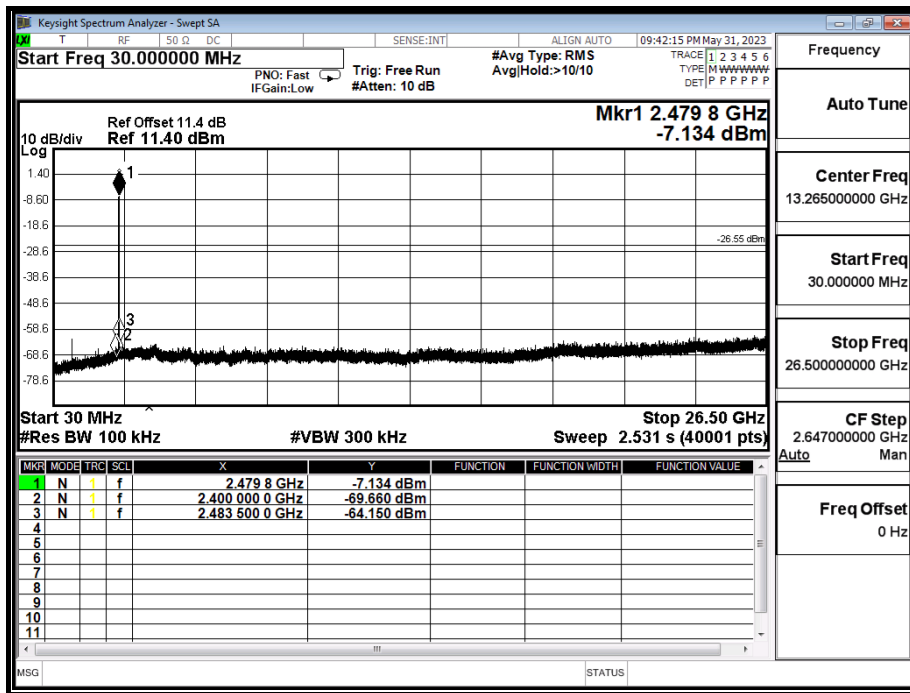

## 9.6 RADIATED EMISSIONS

### 9.6.1 TRANSMITTER RADIATED SUPURIOUS EMISSIONS

#### LIMITS

§ 15.205 (a) Except as shown in paragraph (d) of this section, only spurious emissions are permitted in any of the frequency bands listed below:

| MHz                 | MHz                      | MHz             | GHz              |
|---------------------|--------------------------|-----------------|------------------|
| 0.090 - 0.110       | 16.42 - 16.423           | 399.9 - 410     | 4.5 - 5.15       |
| 10.495 - 0.505      | 16.69475 - 16.69525      | 608 - 614       | 5.35 - 5.46      |
| 2.1735 - 2.1905     | 16.80425 - 16.80475      | 960 - 1240      | 7.25 - 7.75      |
| 4.125 - 4.128       | 25.5 - 25.67             | 1300 - 1427     | 8.025 - 8.5      |
| 4.17725 - 4.17775   | 37.5 - 38.25             | 1435 - 1626.5   | 9.0 - 9.2        |
| 4.20725 - 4.20775   | 73 - 74.6                | 1645.5 - 1646.5 | 9.3 - 9.5        |
| 6.215 - 6.218       | 74.8 - 75.2              | 1660 - 1710     | 10.6 - 12.7      |
| 6.26775 - 6.26825   | 108 - 121.94             | 1718.8 - 1722.2 | 13.25 - 13.4     |
| 6.31175 - 6.31225   | 123 - 138                | 2200 - 2300     | 14.47 - 14.5     |
| 8.291 - 8.294       | 149.9 - 150.05           | 2310 - 2390     | 15.35 - 16.2     |
| 8.362 - 8.366       | 156.52475 -<br>156.52525 | 2483.5 - 2500   | 17.7 - 21.4      |
| 8.37625 - 8.38675   | 156.7 - 156.9            | 2655 - 2900     | 22.01 - 23.12    |
| 8.41425 - 8.41475   | 162.0125 - 167.17        | 3260 - 3267     | 23.6 - 24.0      |
| 12.29 - 12.293      | 167.72 - 173.2           | 3332 - 3339     | 31.2 - 31.8      |
| 12.51975 - 12.52025 | 240 - 285                | 3345.8 - 3338   | 36.43 - 36.5     |
| 12.57675 - 12.57725 | 322 - 335.4              | 3600 - 4400     | ( <sup>2</sup> ) |
| 13.36 - 13.41       |                          |                 |                  |

<sup>1</sup> Until February 1, 1999, this restricted band shall be 0.490-0.510 MHz.

<sup>2</sup> Above 38.6

§ 15.205 (b) Except as provided in paragraphs (d) and (e), the field strength of emissions appearing within these frequency bands shall not exceed the limits shown in Section 15.209. At frequencies equal to or less than 1000 MHz, compliance with the limits in Section 15.209 shall be demonstrated using measurement instrumentation employing a CISPR quasi-peak detector. Above 1000 MHz, compliance with the emission limits in Section 15.209 shall be demonstrated based on the average value of the measured emissions. The provisions in Section 15.35 apply to these measurements.

**Report No.:** TMTN2305000660NR

§ 15.209 (a) Except as provided elsewhere in this Subpart, the emissions from an intentional radiator shall not exceed the field strength levels specified in the following table :

| <b>Frequency (MHz)</b> | <b>Field Strength (microvolts/meter)</b> | <b>Measurement Distance (meters)</b> |
|------------------------|--|--------------------------------------|
| 30 - 88                | 100 **                                   | 3                                    |
| 88 - 216               | 150 **                                   | 3                                    |
| 216 - 960              | 200 **                                   | 3                                    |
| Above 960              | 500                                      | 3                                    |

\*\* Except as provided in paragraph (g), fundamental emissions from intentional radiators operating under this Section shall not be located in the frequency bands 54-72 MHz, 76-88 MHz, 174-216 MHz or 470-806 MHz, However, operation within these frequency bands is permitted under other sections of this Part, e-g, Sections 15.231 and 15.241.

§ 15.209 (b) In the emission table above, the tighter limit applies at the band edges.

## TEST SETUP

The diagram below shows the test setup that is utilized to make the measurements for emission from below 1GHz.

### 9kHz ~ 30MHz

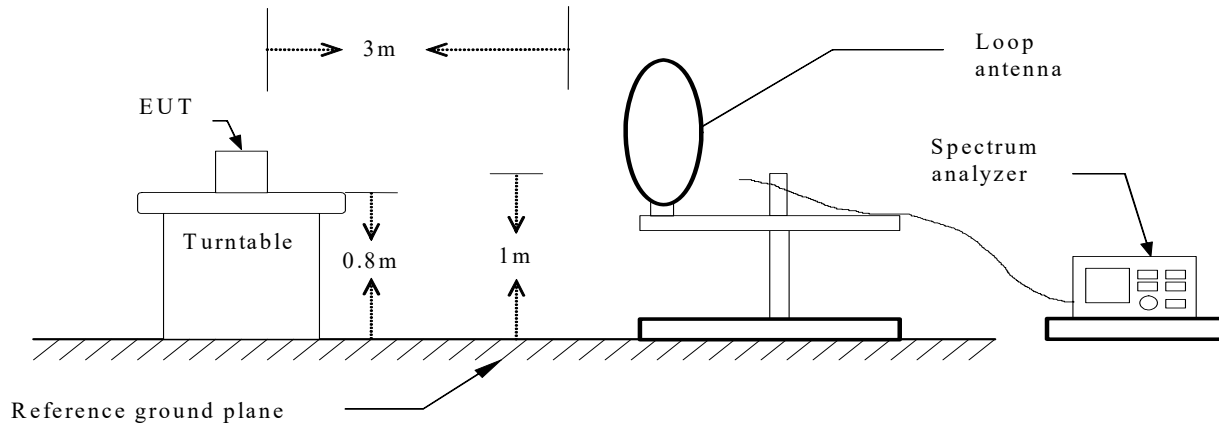

### 30MHz ~ 1GHz

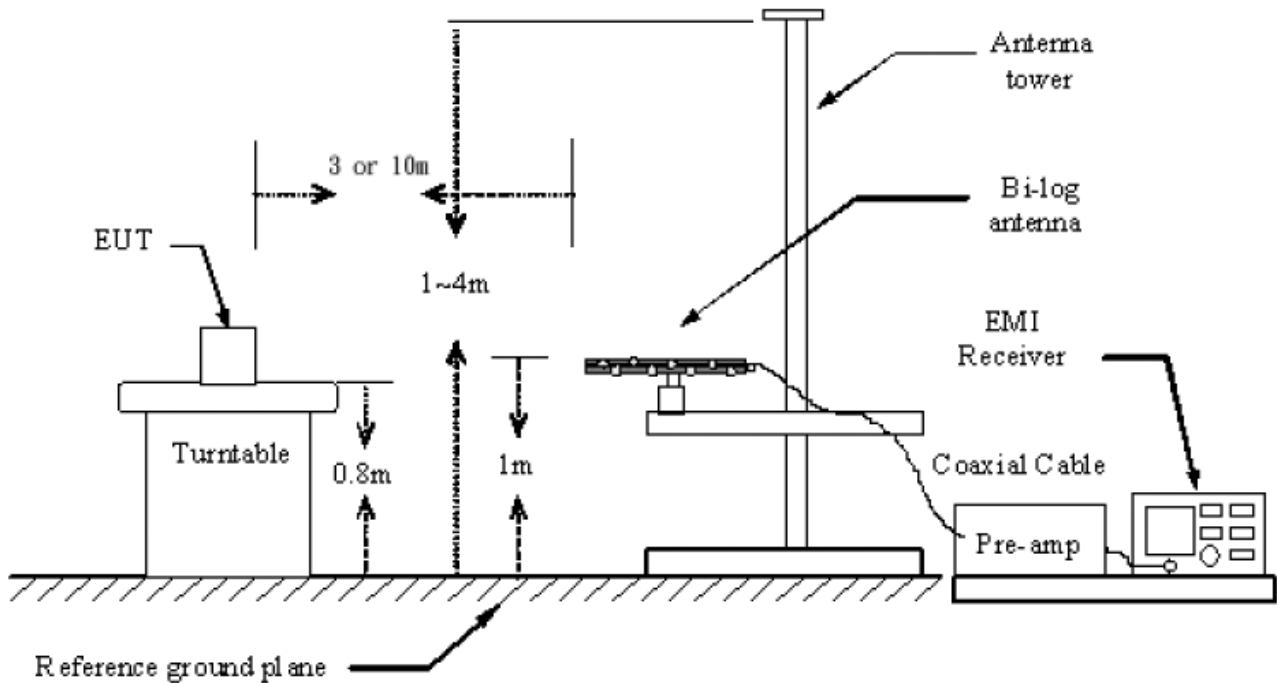

Report No.: TMTN2305000660NR

The diagram below shows the test setup that is utilized to make the measurements for emission above 1GHz.

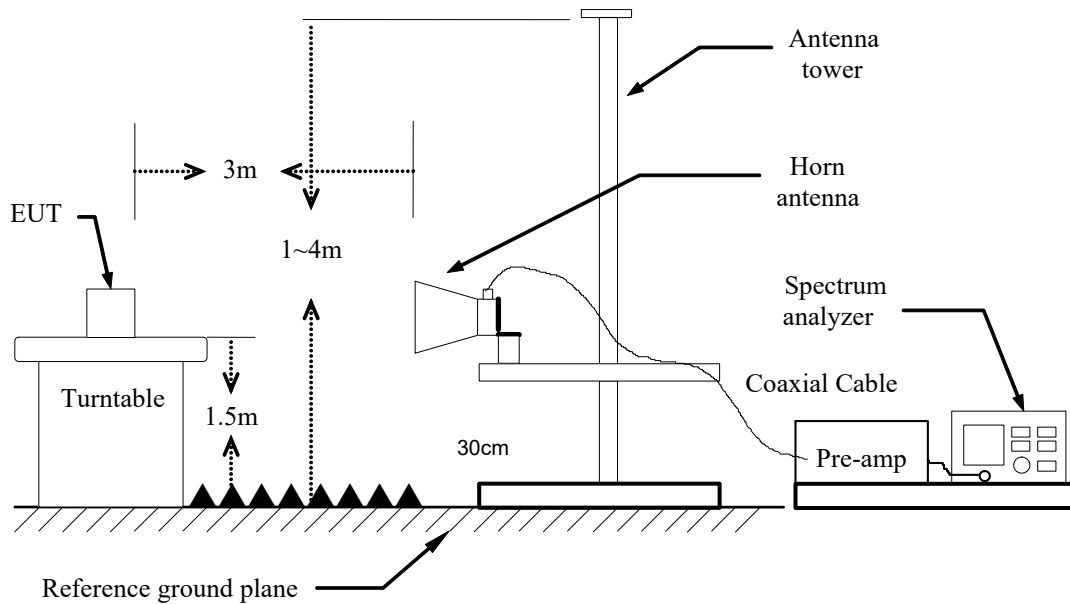

## TEST PROCEDURE

- a. The EUT was placed on the top of a rotating table 0.8/1.5 meters above the ground at a 3 meter chamber test site. The table was rotated 360 degrees to determine the position of the highest radiation.
- b. While measuring the radiated emission below 1GHz, the EUT was set 3 meters away from the interference-receiving antenna, which was mounted on the top of a variable-height antenna tower. While measuring the radiated emission above 1GHz, the EUT was set 3 meters away from the interference-receiving antenna
- c. The antenna is a broadband antenna, and its height is varied from one meter to four meters above the ground to determine the maximum value of the field strength. Both horizontal and vertical polarization of the antenna are set to make the measurement.
- d. For each suspected emission, the EUT was arranged to its worst case and then the antenna was tuned to heights from 1 meter to 4 meters and the table was turned from 0 degrees to 360 degrees to find the maximum reading.
- e. The spectrum analyzer was set to Peak Detect Function and Specified Bandwidth with Maximum Hold Mode.
- f. If the emission level of the EUT in peak mode was 10 dB lower than the limit specified, then testing could be stopped and the peak values of the EUT would be reported. Otherwise the emissions that did not have 10 dB margin would be re-tested one by one using peak, quasi-peak or average method as specified and then reported in a data sheet.
- g. The tests were performed in accordance with 558074 D01 15.247 Meas Guidance v05

**NOTE:**

1. The resolution bandwidth and video bandwidth of test receiver is 120 KHz for Quasi-peak detection (QP) at frequency below 1GHz.
2. The resolution bandwidth of test spectrum analyzer is 1MHz, the video bandwidth is 3MHz and detector is Peak for Peak detection and frequency above 1GHz.
3. The resolution bandwidth of test spectrum analyzer is 1 MHz and the video bandwidth is more than 1/T for Average detection (AV) at frequency above 1GHz.
4. No emission is found between lowest internal used/generated frequency to 30MHz (9kHz~30MHz)

**TEST RESULTS**

No non-compliance noted.

Report No.: TMTN2305000660NR

## 9.6.2 WORST-CASE RADIATED EMISSION BELOW 1 GHz

Motor: EG-530SD-3F

Test Voltage: AC 120V, 60Hz

|                     |                         |                            |             |
|---------------------|-------------------------|----------------------------|-------------|
| <b>Product Name</b> | Stereo Turntable System | <b>Test Date</b>           | 2023/05/30  |
| <b>Model Name</b>   | PS-LX310BT              | <b>Test By</b>             | Peter Chu   |
| <b>Test Mode</b>    | TX                      | <b>Temp &amp; Humidity</b> | 24.3°C, 52% |

Vertical

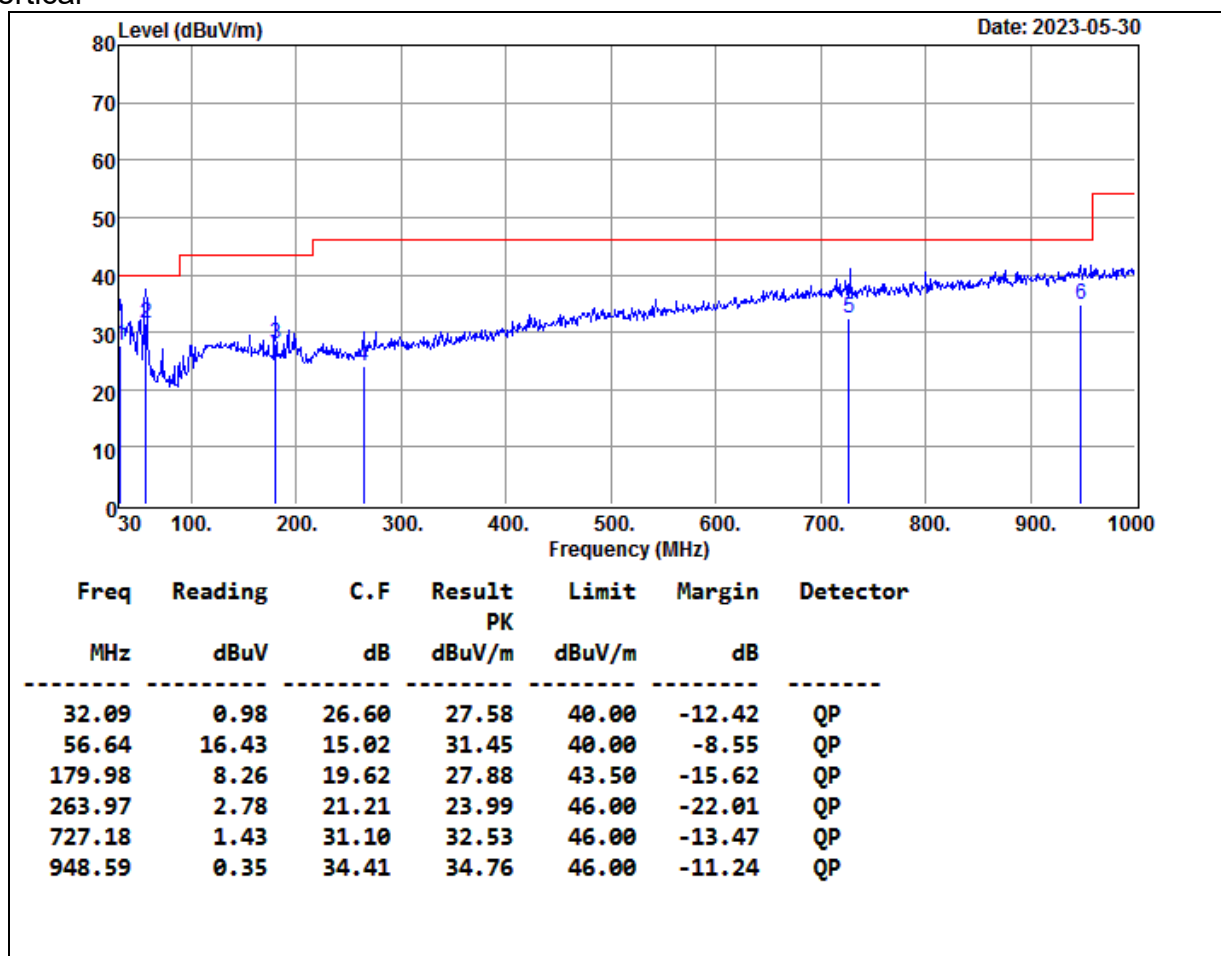

- Note: 1. QP= Quasi-peak Reading.  
2. The other emission levels were very low against the limit

|                     |                         |                            |             |
|---------------------|-------------------------|----------------------------|-------------|
| <b>Product Name</b> | Stereo Turntable System | <b>Test Date</b>           | 2023/05/30  |
| <b>Model Name</b>   | PS-LX310BT              | <b>Test By</b>             | Peter Chu   |
| <b>Test Mode</b>    | TX                      | <b>Temp &amp; Humidity</b> | 24.3°C, 52% |

Horizontal

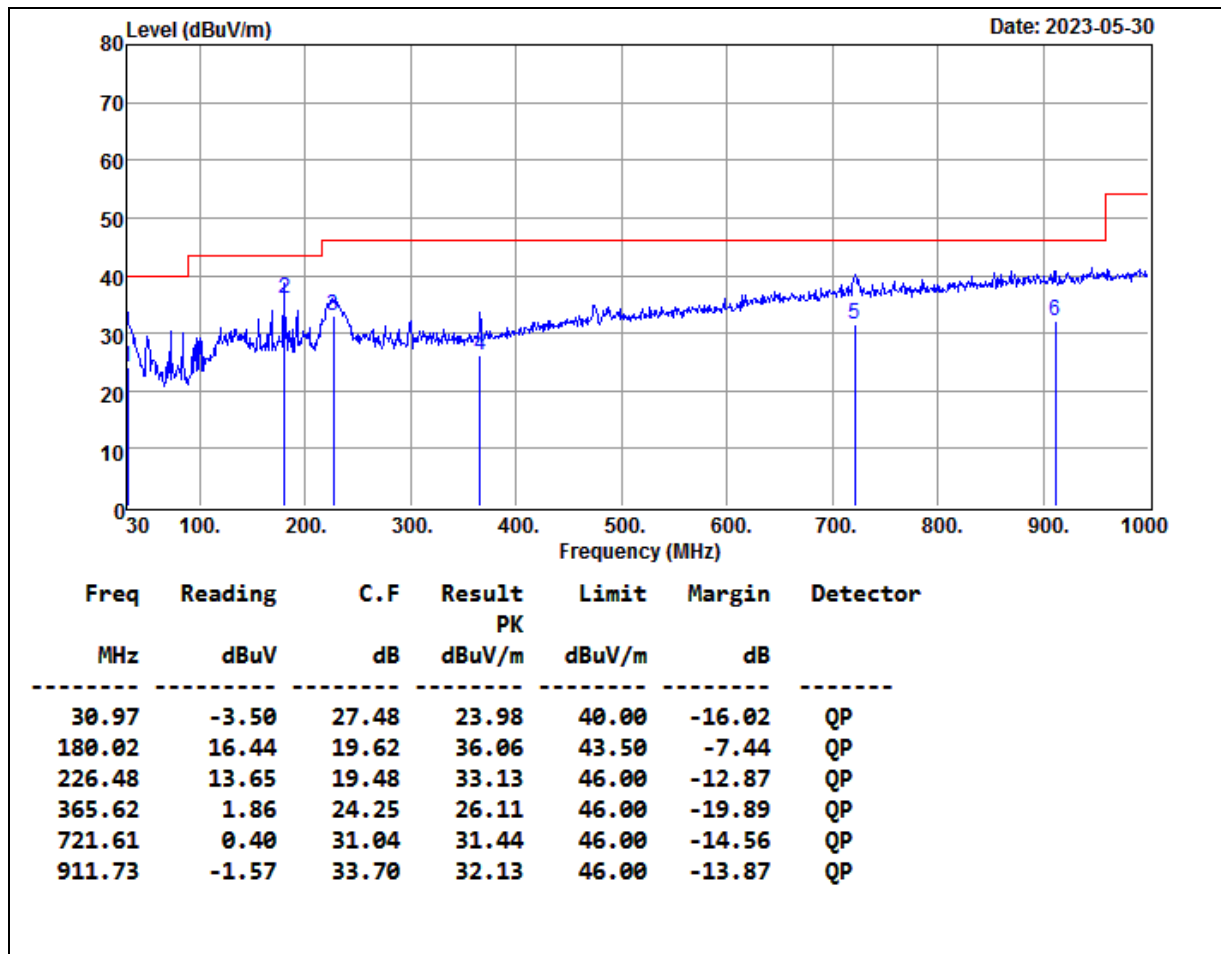

- Note: 1. QP= Quasi-peak Reading.  
2. The other emission levels were very low against the limit



**Motor: M09S**  
**Test Voltage: AC 120V, 60Hz**

|                     |                         |                            |             |
|---------------------|-------------------------|----------------------------|-------------|
| <b>Product Name</b> | Stereo Turntable System | <b>Test Date</b>           | 2023/06/07  |
| <b>Model Name</b>   | PS-LX310BT              | <b>Test By</b>             | Peter Chu   |
| <b>Test Mode</b>    | TX                      | <b>Temp &amp; Humidity</b> | 24.3°C, 52% |

Vertical

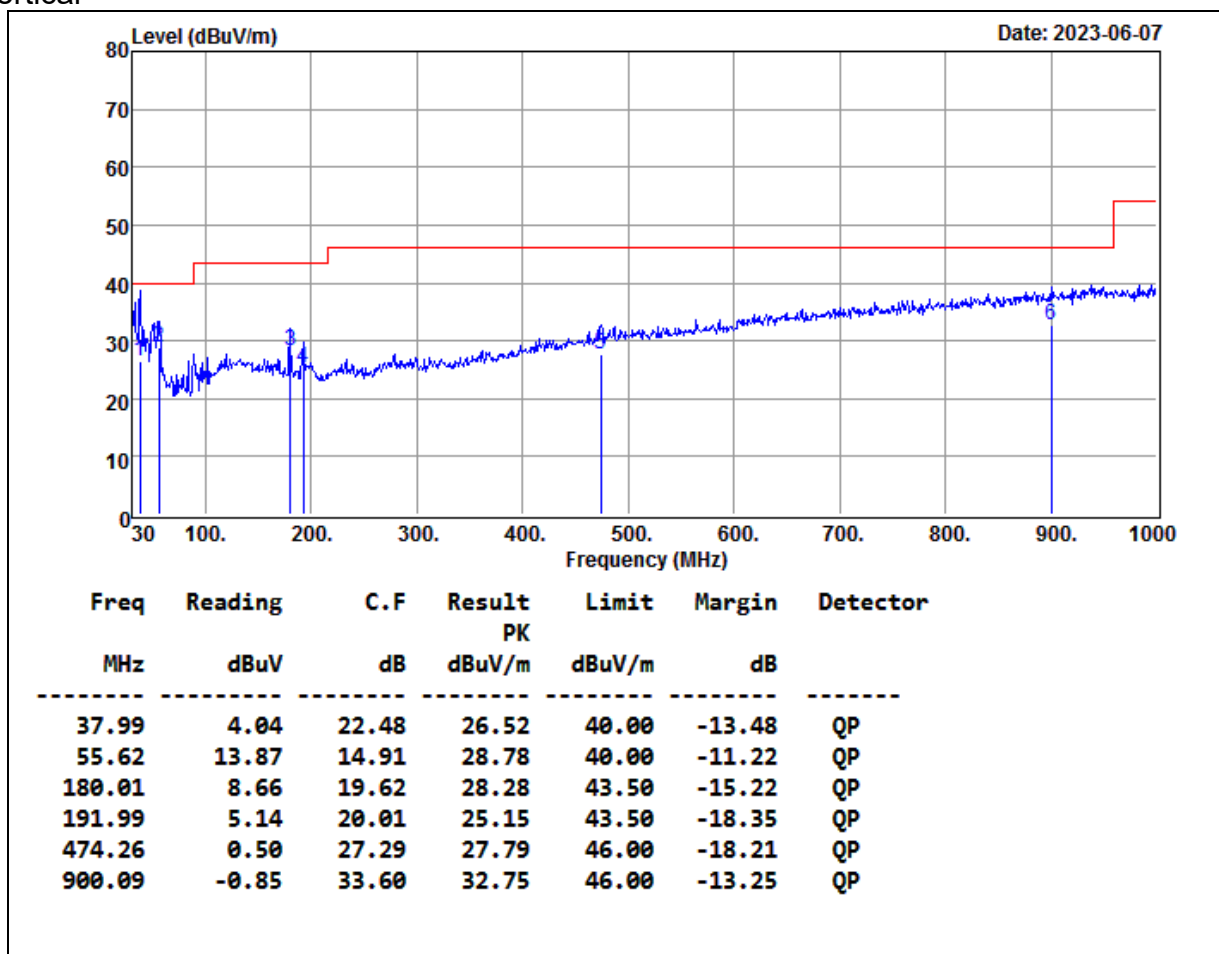

- Note: 1. QP= Quasi-peak Reading.  
2. The other emission levels were very low against the limit

|                     |                         |                            |             |
|---------------------|-------------------------|----------------------------|-------------|
| <b>Product Name</b> | Stereo Turntable System | <b>Test Date</b>           | 2023/06/07  |
| <b>Model Name</b>   | PS-LX310BT              | <b>Test By</b>             | Peter Chu   |
| <b>Test Mode</b>    | TX                      | <b>Temp &amp; Humidity</b> | 24.3°C, 52% |

Horizontal

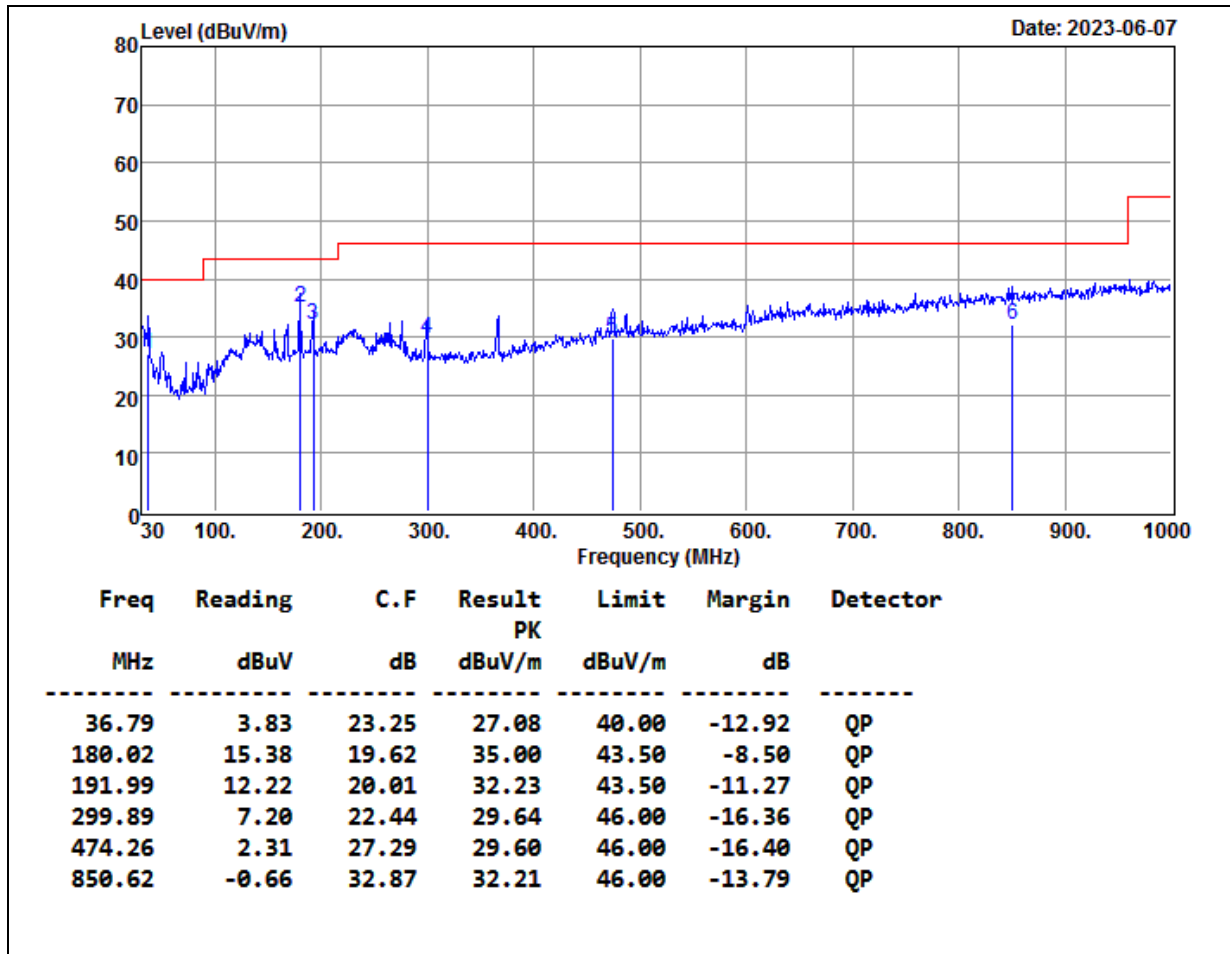

- Note: 1. QP= Quasi-peak Reading.  
2. The other emission levels were very low against the limit

Report No.: TMTN2305000660NR

## 9.6.3 TRANSMITTER RADIATED EMISSION ABOVE 1 GHz

Test Voltage: AC 120V, 60Hz

|              |                         |                |             |
|--------------|-------------------------|----------------|-------------|
| Product Name | Stereo Turntable System | Test Date      | 2023/05/29  |
| Model        | PS-LX310BT              | Test By        | Peter Chu   |
| Test Mode    | GFSK(4.0) TX (CH Low)   | TEMP& Humidity | 24.3°C, 52% |

Horizontal

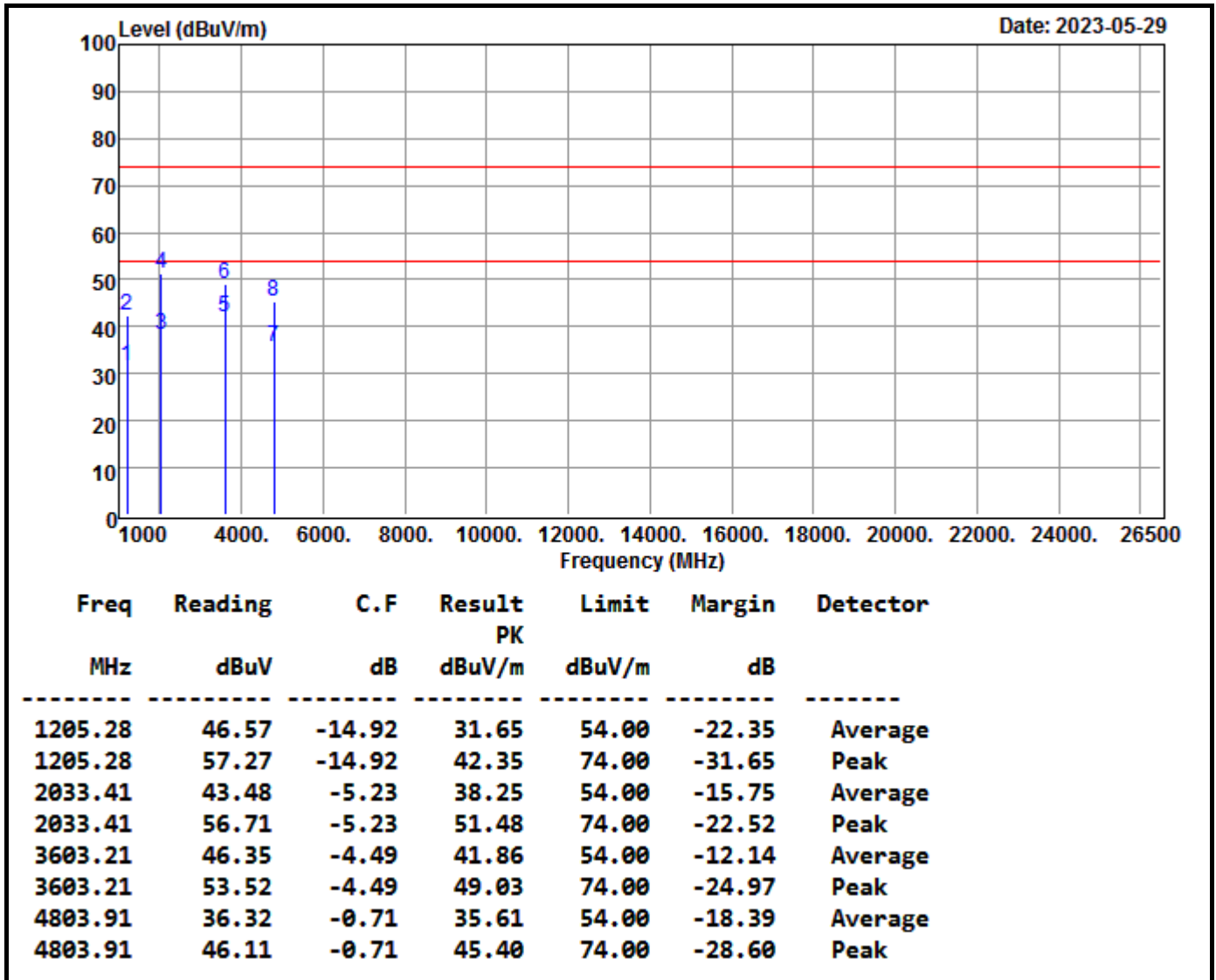

**REMARK:**

1. AF: Antenna Factor, Cable: Cable Loss, Pre-Amp: Preamplifier gain, Filter: High Pass Filter Insertion Loss (3.5GHz)
2. Spectrum analyzer setting P(Peak): RBW=1MHz, VBW=3MHz,A(Average): RBW=1MHz, VBW ≥ 1/T
3. The result basic equation calculation is as follow:  
Level = Reading + AF + Cable – Preamp + Filter, Margin = Level-Limit
4. The other emission levels were 10dB below the limit
5. The test distance is 3m.
6. \*=Restricted bands of operation

Report No.: TMTN2305000660NR

|                     |                         |                           |             |
|---------------------|-------------------------|---------------------------|-------------|
| <b>Product Name</b> | Stereo Turntable System | <b>Test Date</b>          | 2023/05/29  |
| <b>Model</b>        | PS-LX310BT              | <b>Test By</b>            | Peter Chu   |
| <b>Test Mode</b>    | GFSK(4.0) TX (CH Low)   | <b>TEMP&amp; Humidity</b> | 24.3°C, 52% |

Vertical

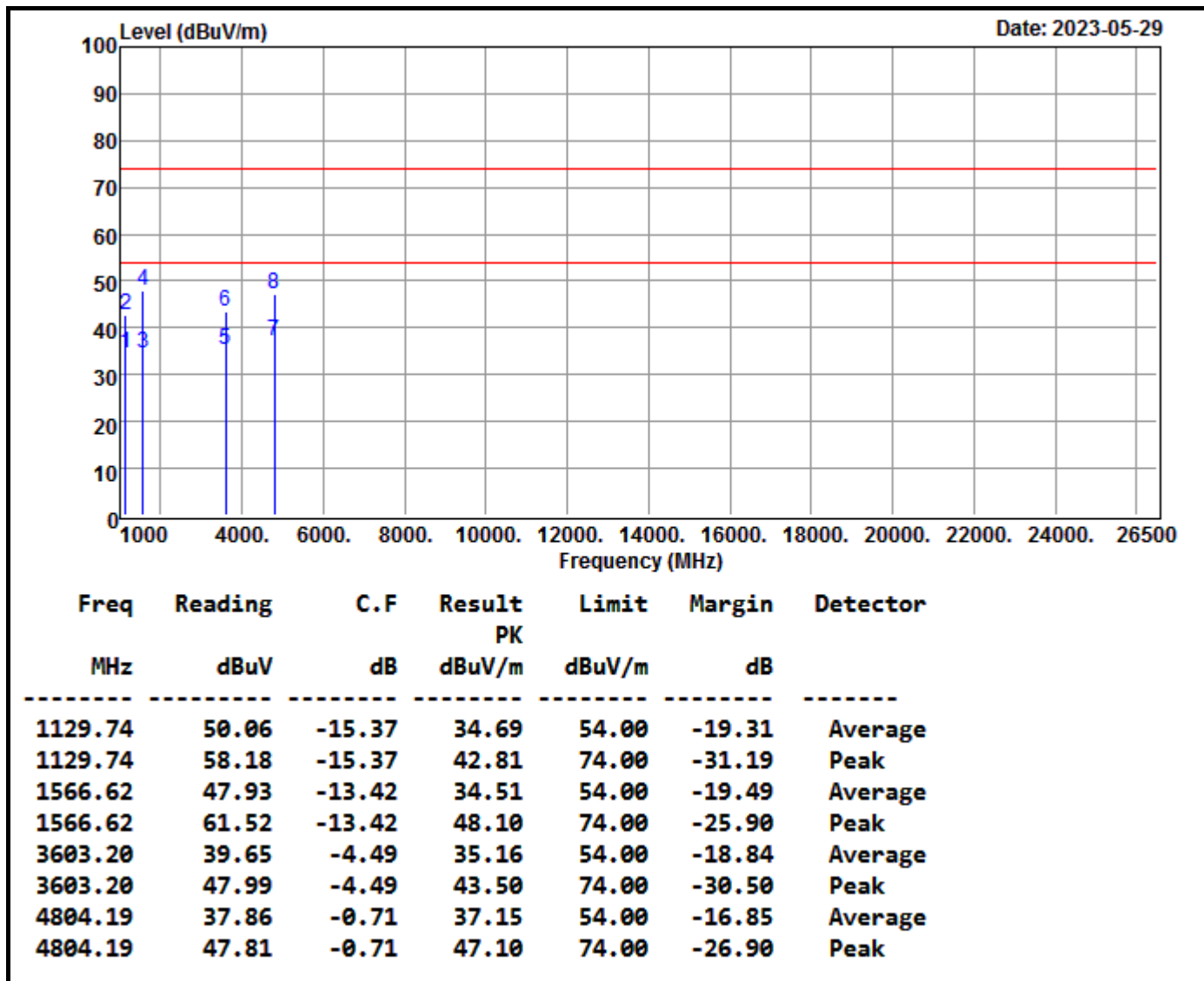

**REMARK:**

1. AF: Antenna Factor, Cable: Cable Loss, Pre-Amp: Preamplifier gain, Filter: High Pass Filter Insertion Loss (3.5GHz)
2. Spectrum analyzer setting P(Peak): RBW=1MHz, VBW=3MHz,A(Average): RBW=1MHz, VBW ≥ 1/T
3. The result basic equation calculation is as follow:  
Level = Reading + AF + Cable – Preamp + Filter, Margin = Level-Limit
4. The other emission levels were 10dB below the limit
5. The test distance is 3m.
6. \*=Restricted bands of operation

|                     |                          |                           |             |
|---------------------|--------------------------|---------------------------|-------------|
| <b>Product Name</b> | Stereo Turntable System  | <b>Test Date</b>          | 2023/05/29  |
| <b>Model</b>        | PS-LX310BT               | <b>Test By</b>            | Peter Chu   |
| <b>Test Mode</b>    | GFSK(4.0) TX (CH Middle) | <b>TEMP&amp; Humidity</b> | 24.3°C, 52% |

Horizontal

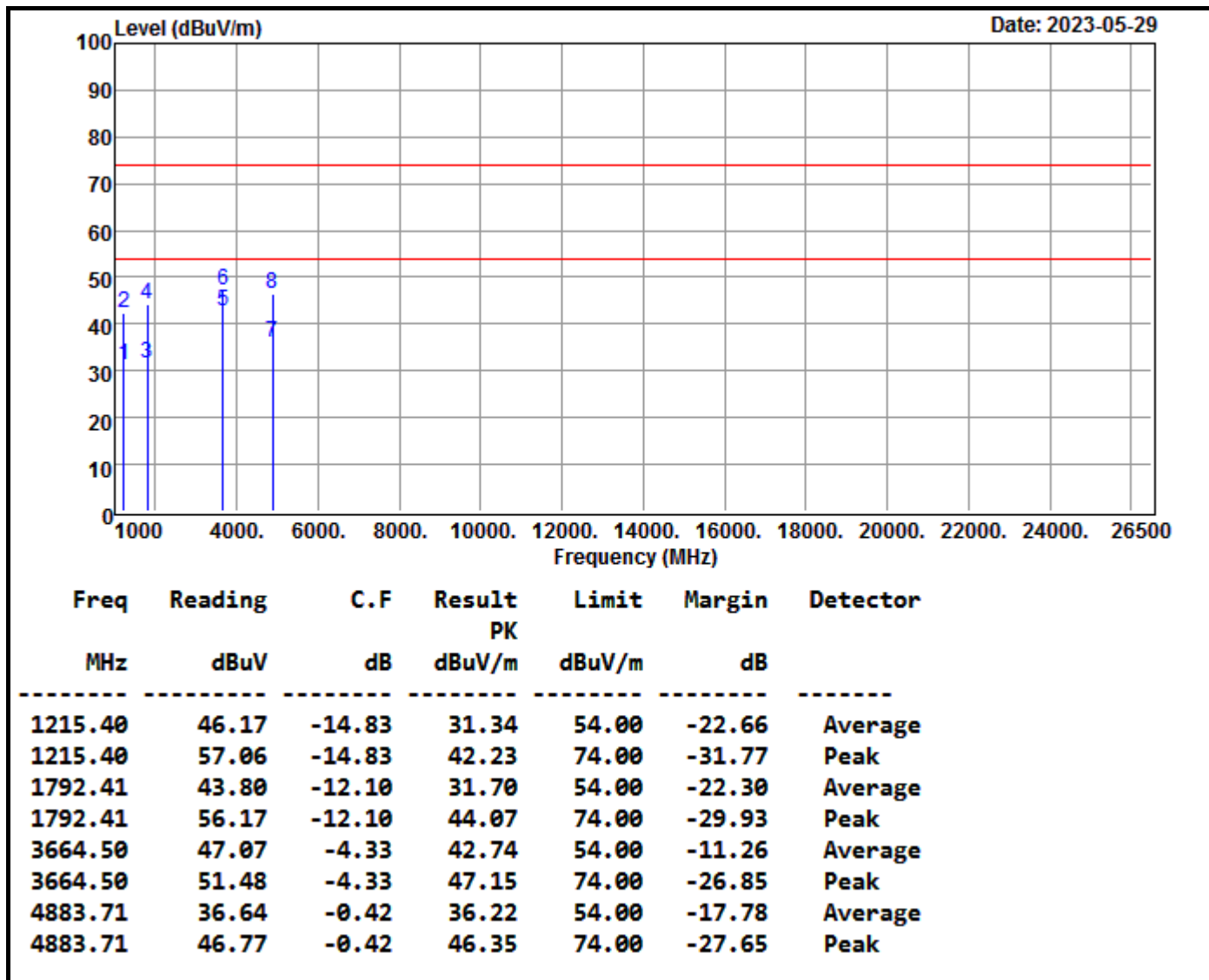

**Remark:**

1. AF: Antenna Factor, Cable: Cable Loss, Pre-Amp: Preamplifier gain, Filter: High Pass Filter Insertion Loss (3.5GHz)
2. Spectrum analyzer setting P(Peak): RBW=1MHz, VBW=3MHz, A(Average): RBW=1MHz, VBW ≥ 1/T
3. The result basic equation calculation is as follow:  
Level = Reading + AF + Cable – Preamp + Filter, Margin = Level-Limit
4. The other emission levels were 10dB below the limit
5. The test distance is 3m.
6. \*=Restricted bands of operation

|                     |                          |                           |             |
|---------------------|--------------------------|---------------------------|-------------|
| <b>Product Name</b> | Stereo Turntable System  | <b>Test Date</b>          | 2023/05/29  |
| <b>Model</b>        | PS-LX310BT               | <b>Test By</b>            | Peter Chu   |
| <b>Test Mode</b>    | GFSK(4.0) TX (CH Middle) | <b>TEMP&amp; Humidity</b> | 24.3°C, 52% |

Vertical

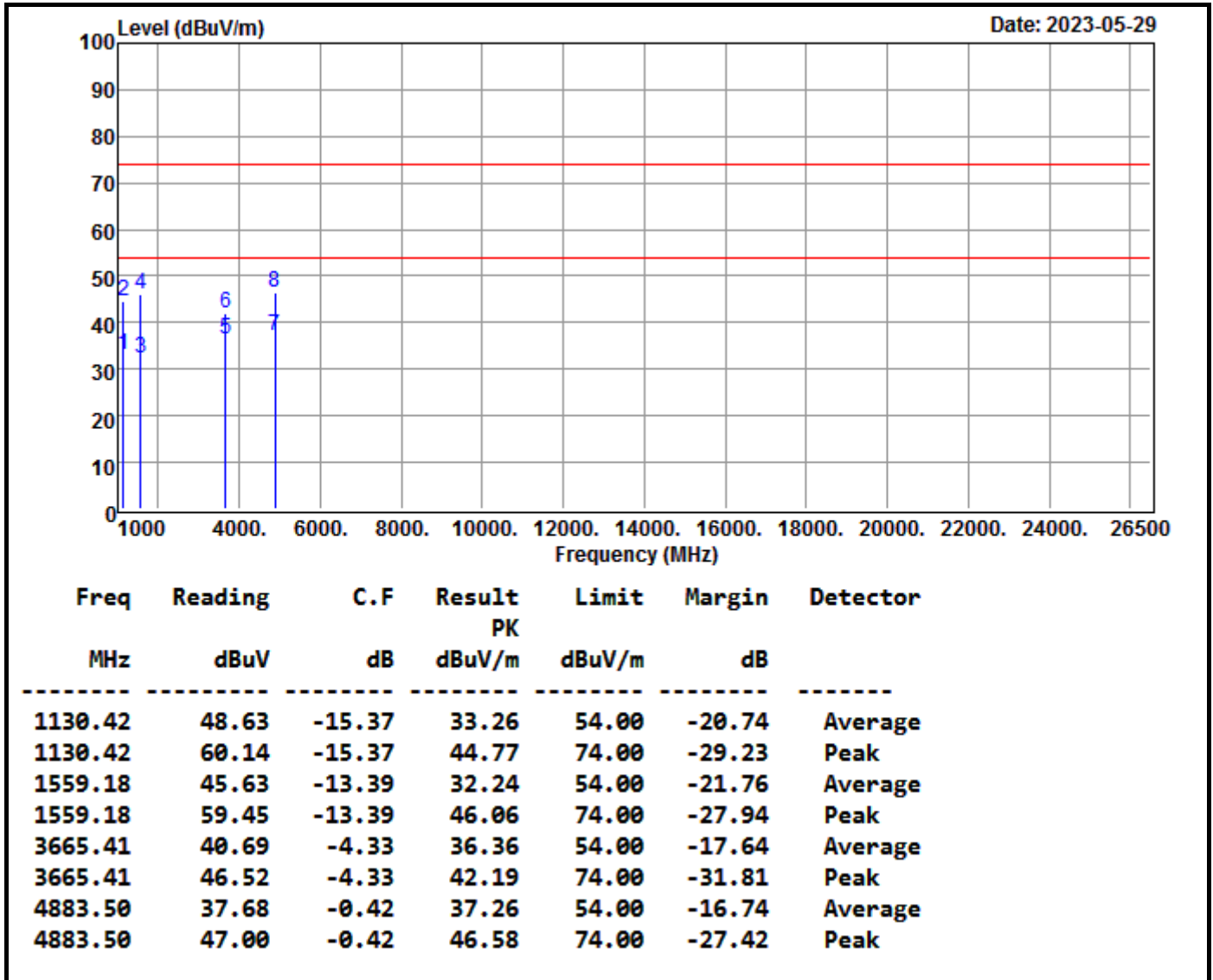

**Remark:**

1. AF: Antenna Factor, Cable: Cable Loss, Pre-Amp: Preamplifier gain, Filter: High Pass Filter Insertion Loss (3.5GHz)
2. Spectrum analyzer setting P(Peak): RBW=1MHz, VBW=3MHz, A(Average): RBW=1MHz, VBW ≥ 1/T
3. The result basic equation calculation is as follow:  
Level = Reading + AF + Cable – Preamp + Filter, Margin = Level-Limit
4. The other emission levels were 10dB below the limit
5. The test distance is 3m.
6. \*=Restricted bands of operation

|                     |                         |                           |             |
|---------------------|-------------------------|---------------------------|-------------|
| <b>Product Name</b> | Stereo Turntable System | <b>Test Date</b>          | 2023/05/29  |
| <b>Model</b>        | PS-LX310BT              | <b>Test By</b>            | Peter Chu   |
| <b>Test Mode</b>    | GFSK(4.0) TX (CH High)  | <b>TEMP&amp; Humidity</b> | 24.3°C, 52% |

Horizontal

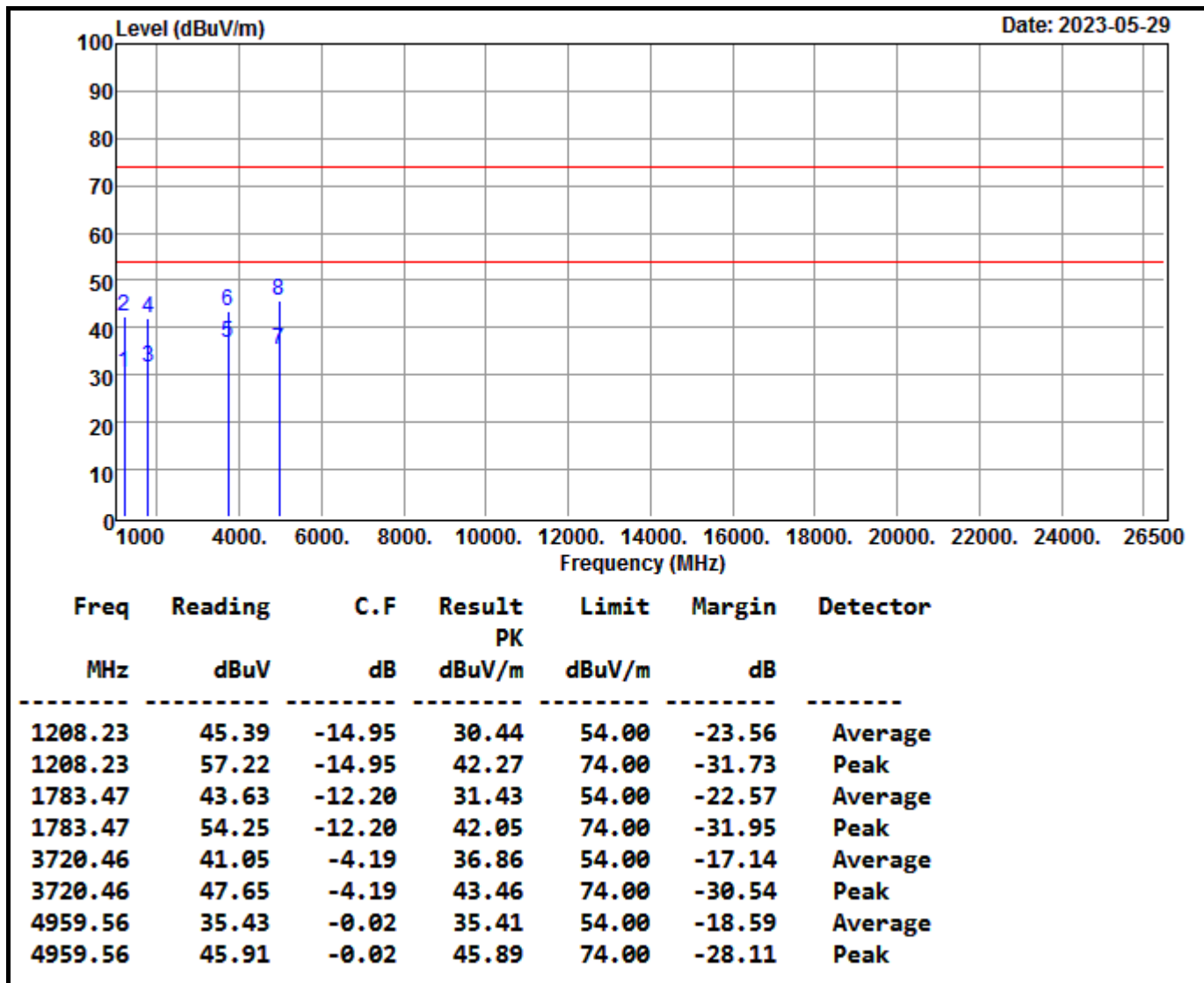

**Remark:**

1. AF: Antenna Factor, Cable: Cable Loss, Pre-Amp: Preamplifier gain, Filter: High Pass Filter Insertion Loss (3.5GHz)
2. Spectrum analyzer setting P(Peak): RBW=1MHz, VBW=3MHz, A(Average): RBW=1MHz, VBW ≥ 1/T
3. The result basic equation calculation is as follow:  
Level = Reading + AF + Cable – Preamp + Filter, Margin = Level-Limit
4. The other emission levels were 10dB below the limit
5. The test distance is 3m.
6. \*=Restricted bands of operation

|                     |                         |                           |             |
|---------------------|-------------------------|---------------------------|-------------|
| <b>Product Name</b> | Stereo Turntable System | <b>Test Date</b>          | 2023/05/29  |
| <b>Model</b>        | PS-LX310BT              | <b>Test By</b>            | Peter Chu   |
| <b>Test Mode</b>    | GFSK(4.0) TX (CH High)  | <b>TEMP&amp; Humidity</b> | 24.3°C, 52% |

Vertical

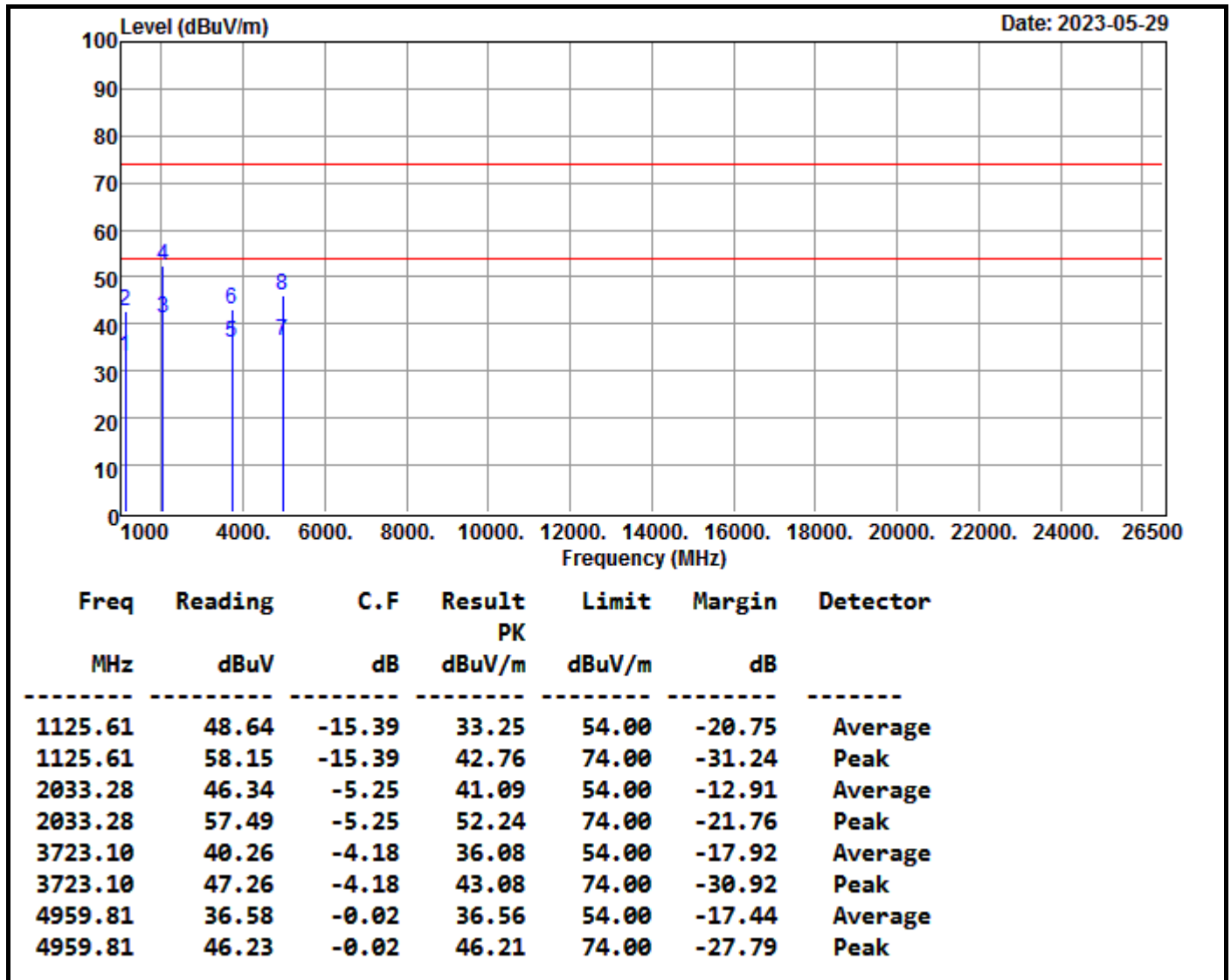

**Remark:**

1. AF: Antenna Factor, Cable: Cable Loss, Pre-Amp: Preamplifier gain, Filter: High Pass Filter Insertion Loss (3.5GHz)
2. Spectrum analyzer setting P(Peak): RBW=1MHz, VBW=3MHz, A(Average): RBW=1MHz, VBW ≥ 1/T
3. The result basic equation calculation is as follow:  
Level = Reading + AF + Cable – Preamp + Filter, Margin = Level-Limit
4. The other emission levels were 10dB below the limit
5. The test distance is 3m.
6. \*=Restricted bands of operation



|                     |                         |                           |             |
|---------------------|-------------------------|---------------------------|-------------|
| <b>Product Name</b> | Stereo Turntable System | <b>Test Date</b>          | 2023/05/29  |
| <b>Model</b>        | PS-LX310BT              | <b>Test By</b>            | Peter Chu   |
| <b>Test Mode</b>    | GFSK(5.0) TX (CH Low)   | <b>TEMP&amp; Humidity</b> | 24.3°C, 52% |

Horizontal

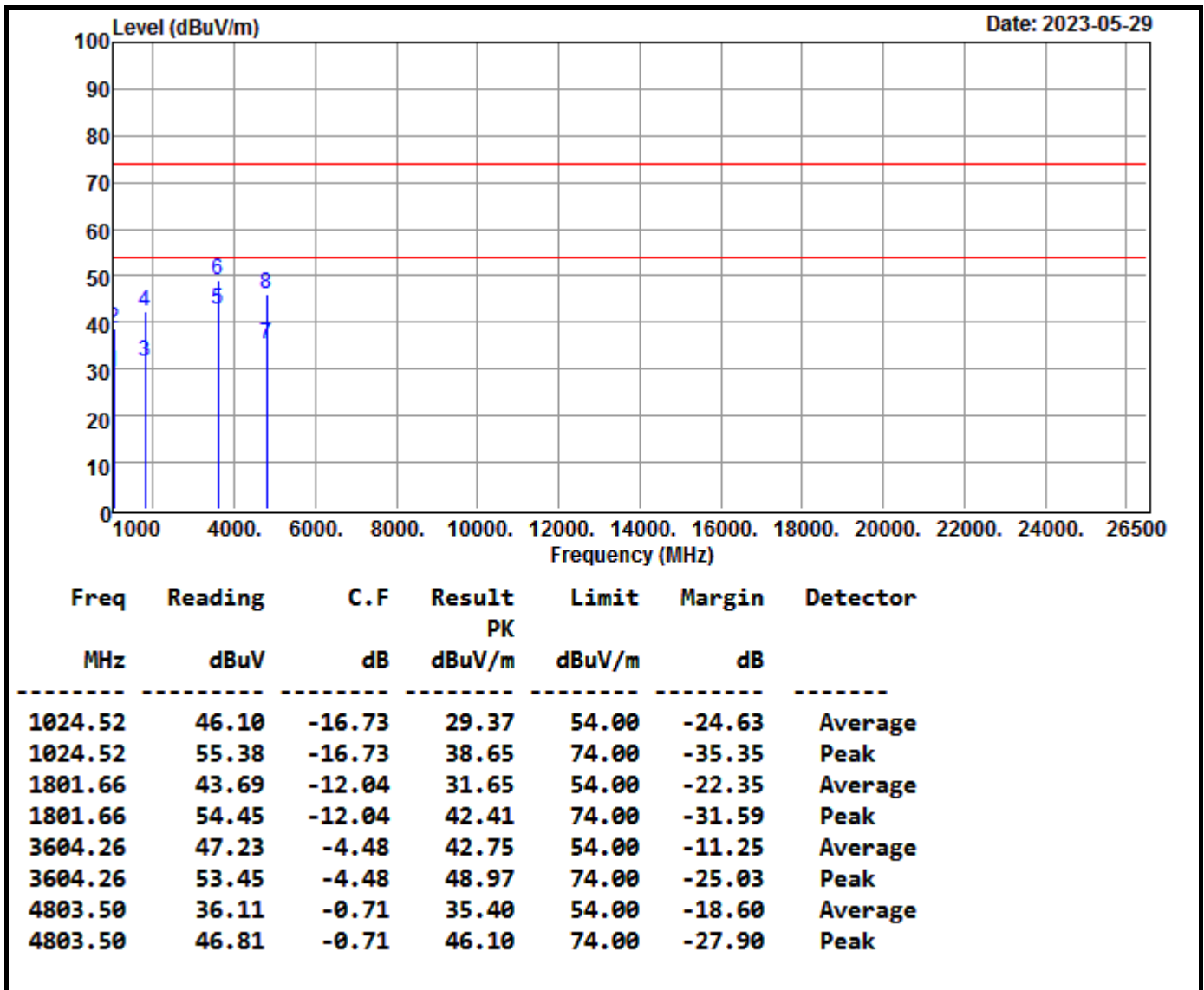

**Remark:**

1. AF: Antenna Factor, Cable: Cable Loss, Pre-Amp: Preamplifier gain, Filter: High Pass Filter Insertion Loss (3.5GHz)
2. Spectrum analyzer setting P(Peak): RBW=1MHz, VBW=3MHz, A(Average): RBW=1MHz, VBW ≥ 1/T
3. The result basic equation calculation is as follow:  
Level = Reading + AF + Cable – Preamp + Filter, Margin = Level-Limit
4. The other emission levels were 10dB below the limit
5. The test distance is 3m.
6. \*=Restricted bands of operation

|                     |                         |                           |             |
|---------------------|-------------------------|---------------------------|-------------|
| <b>Product Name</b> | Stereo Turntable System | <b>Test Date</b>          | 2023/05/29  |
| <b>Model</b>        | PS-LX310BT              | <b>Test By</b>            | Peter Chu   |
| <b>Test Mode</b>    | GFSK(5.0) TX (CH Low)   | <b>TEMP&amp; Humidity</b> | 24.3°C, 52% |

Vertical

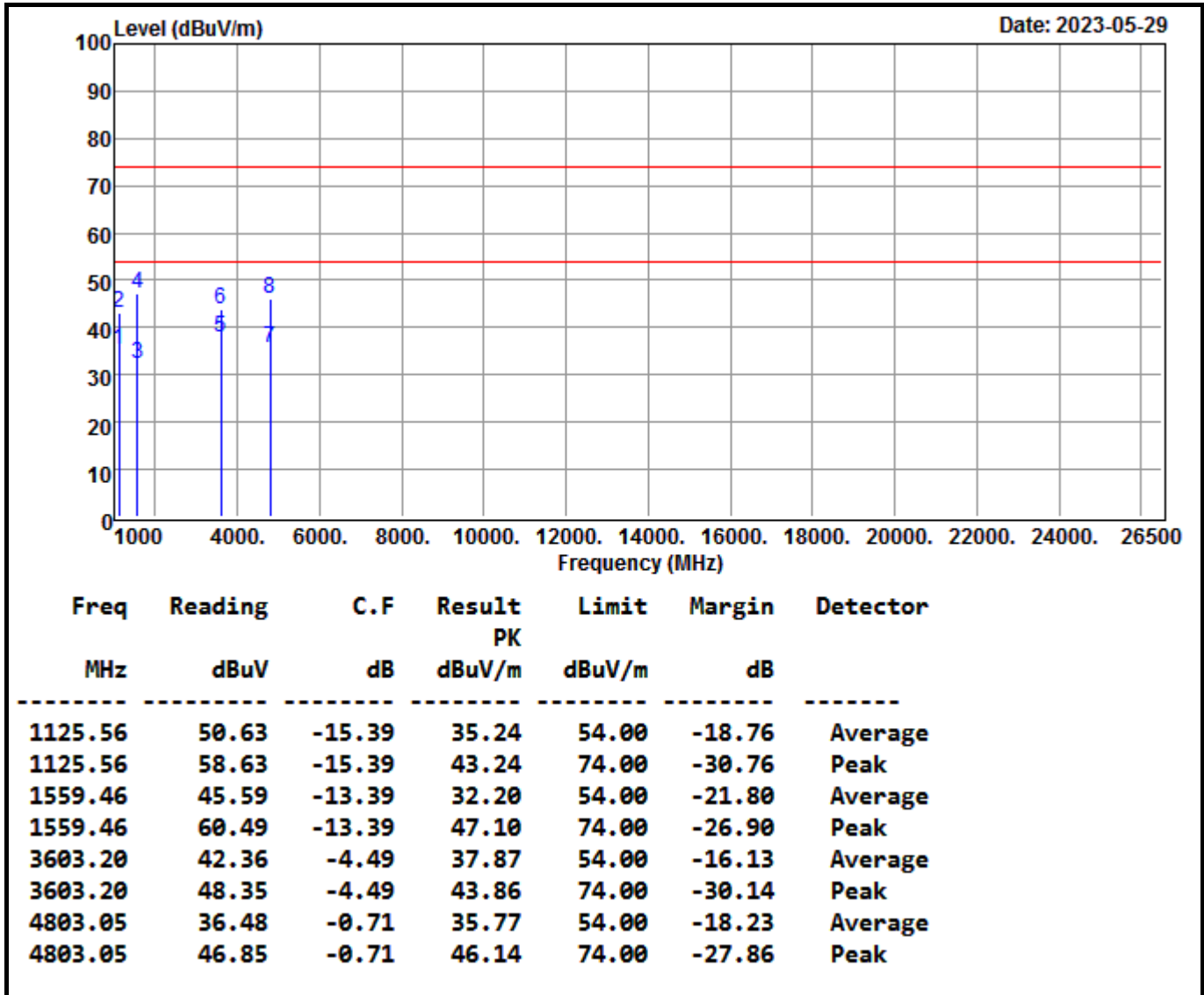

**Remark:**

1. AF: Antenna Factor, Cable: Cable Loss, Pre-Amp: Pre-amplifier gain, Filter: High Pass Filter Insertion Loss (3.5GHz)
2. Spectrum analyzer setting P(Peak): RBW=1MHz, VBW=3MHz, A(Average): RBW=1MHz, VBW ≥ 1/T
3. The result basic equation calculation is as follow:  
Level = Reading + AF + Cable – Preamp + Filter, Margin = Level-Limit
4. The other emission levels were 10dB below the limit
5. The test distance is 3m.
6. \*=Restricted bands of operation

|                     |                          |                           |             |
|---------------------|--------------------------|---------------------------|-------------|
| <b>Product Name</b> | Stereo Turntable System  | <b>Test Date</b>          | 2023/05/29  |
| <b>Model</b>        | PS-LX310BT               | <b>Test By</b>            | Peter Chu   |
| <b>Test Mode</b>    | GFSK(5.0) TX (CH Middle) | <b>TEMP&amp; Humidity</b> | 24.3°C, 52% |

Horizontal

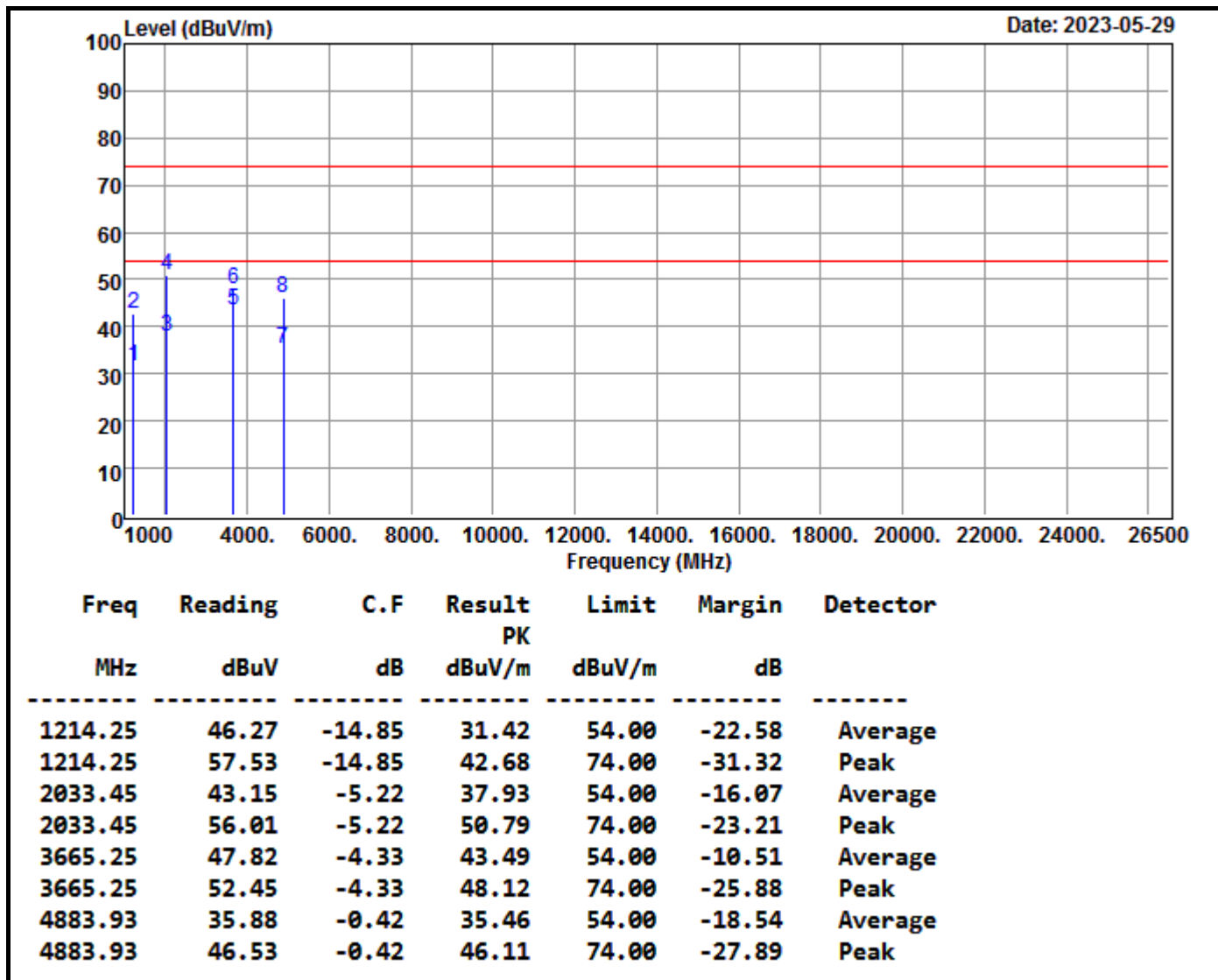

**Remark:**

1. AF: Antenna Factor, Cable: Cable Loss, Pre-Amp: Preamplifier gain, Filter: High Pass Filter Insertion Loss (3.5GHz)
2. Spectrum analyzer setting P(Peak): RBW=1MHz, VBW=3MHz, A(Average): RBW=1MHz, VBW ≥ 1/T
3. The result basic equation calculation is as follow:  
Level = Reading + AF + Cable – Preamp + Filter, Margin = Level-Limit
4. The other emission levels were 10dB below the limit
5. The test distance is 3m.
6. \*=Restricted bands of operation

|                     |                          |                           |             |
|---------------------|--------------------------|---------------------------|-------------|
| <b>Product Name</b> | Stereo Turntable System  | <b>Test Date</b>          | 2023/05/29  |
| <b>Model</b>        | PS-LX310BT               | <b>Test By</b>            | Peter Chu   |
| <b>Test Mode</b>    | GFSK(5.0) TX (CH Middle) | <b>TEMP&amp; Humidity</b> | 24.3°C, 52% |

Vertical

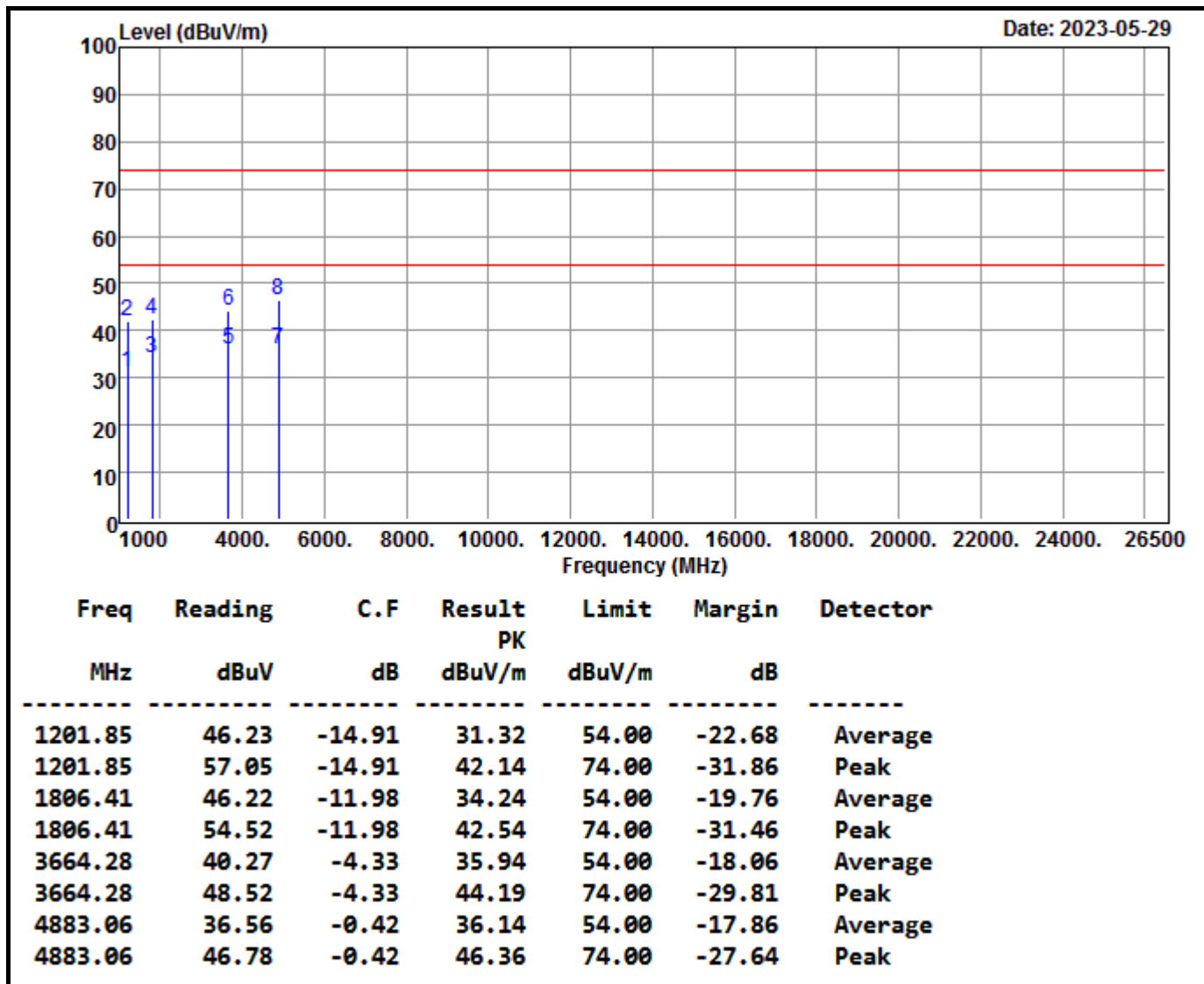

**Remark:**

1. AF: Antenna Factor, Cable: Cable Loss, Pre-Amp: Preamplifier gain, Filter: High Pass Filter Insertion Loss (3.5GHz)
2. Spectrum analyzer setting P(Peak): RBW=1MHz, VBW=3MHz, A(Average): RBW=1MHz, VBW ≥ 1/T
3. The result basic equation calculation is as follow:  
Level = Reading + AF + Cable – Preamp + Filter, Margin = Level-Limit
4. The other emission levels were 10dB below the limit
5. The test distance is 3m.
6. \*=Restricted bands of operation

|                     |                         |                           |             |
|---------------------|-------------------------|---------------------------|-------------|
| <b>Product Name</b> | Stereo Turntable System | <b>Test Date</b>          | 2023/05/29  |
| <b>Model</b>        | PS-LX310BT              | <b>Test By</b>            | Peter Chu   |
| <b>Test Mode</b>    | GFSK(5.0) TX (CH High)  | <b>TEMP&amp; Humidity</b> | 24.3°C, 52% |

Horizontal

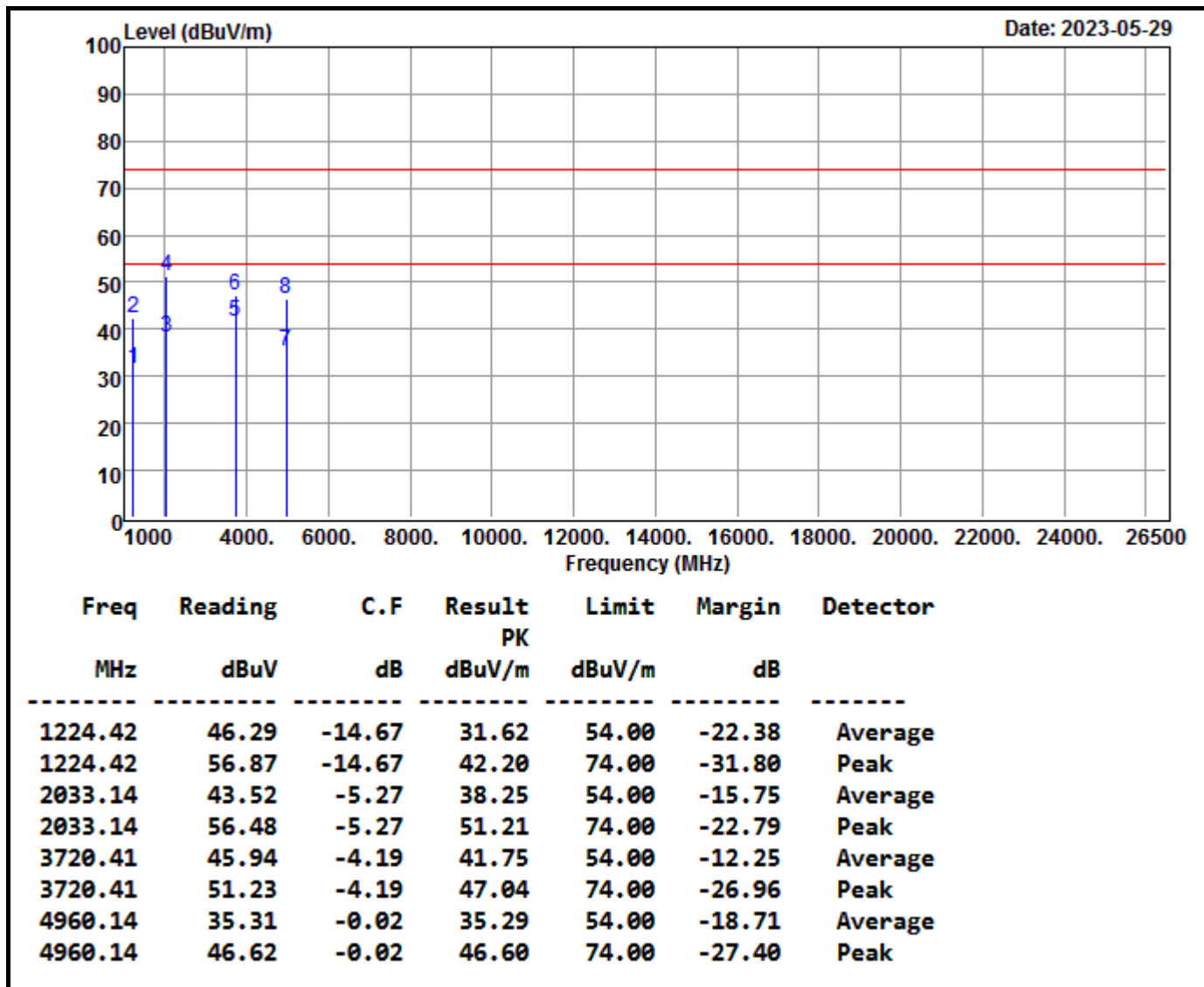

**Remark:**

1. AF: Antenna Factor, Cable: Cable Loss, Pre-Amp: Preamplifier gain, Filter: High Pass Filter Insertion Loss (3.5GHz)
2. Spectrum analyzer setting P(Peak): RBW=1MHz, VBW=3MHz, A(Average): RBW=1MHz, VBW ≥ 1/T
3. The result basic equation calculation is as follow:  
Level = Reading + AF + Cable – Preamp + Filter, Margin = Level-Limit
4. The other emission levels were 10dB below the limit
5. The test distance is 3m.
6. \*=Restricted bands of operation

|                     |                         |                           |             |
|---------------------|-------------------------|---------------------------|-------------|
| <b>Product Name</b> | Stereo Turntable System | <b>Test Date</b>          | 2023/05/29  |
| <b>Model</b>        | PS-LX310BT              | <b>Test By</b>            | Peter Chu   |
| <b>Test Mode</b>    | GFSK(5.0) TX (CH High)  | <b>TEMP&amp; Humidity</b> | 24.3°C, 52% |

Vertical

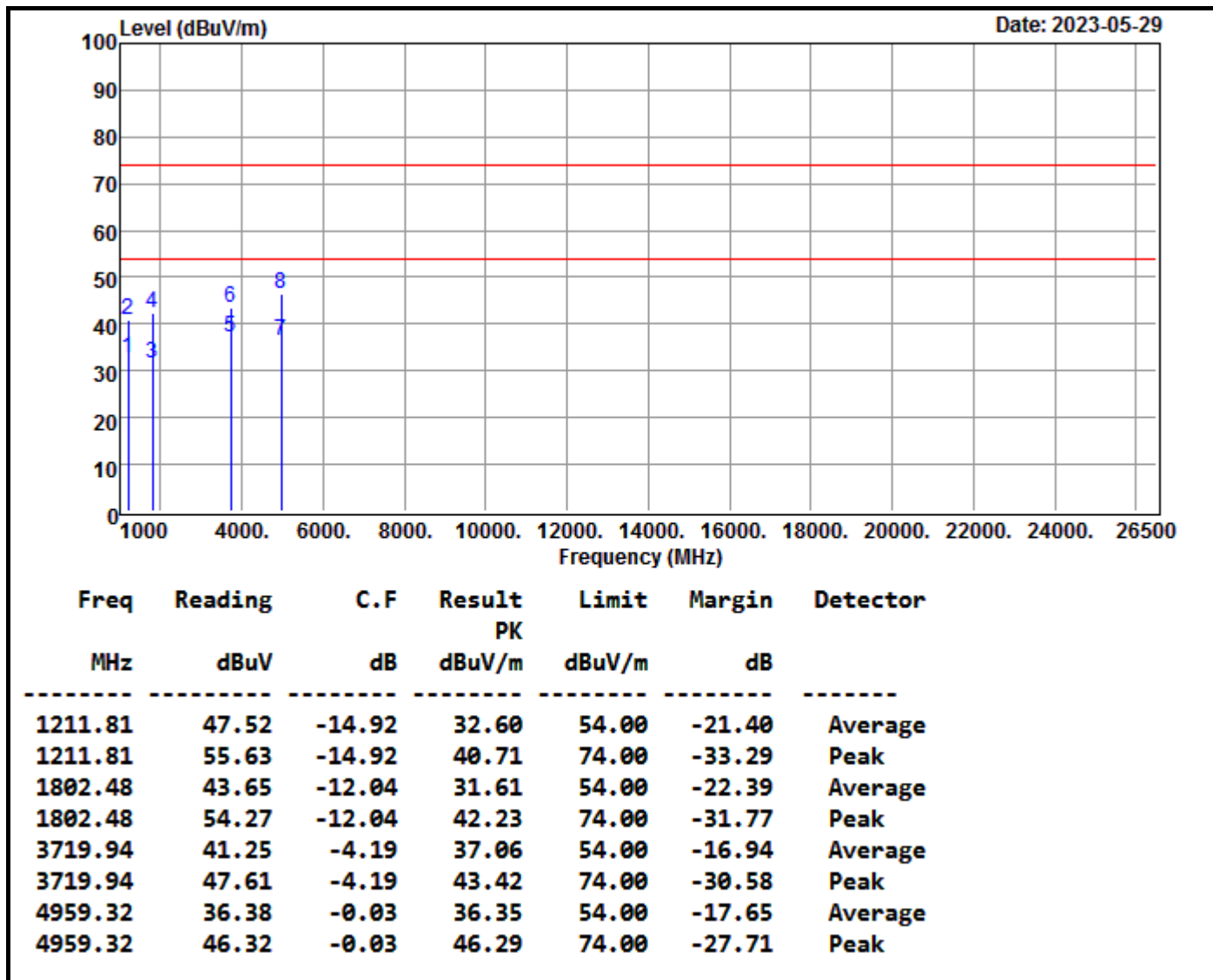

**Remark:**

1. AF: Antenna Factor, Cable: Cable Loss, Pre-Amp: Preamplifier gain, Filter: High Pass Filter Insertion Loss (3.5GHz)
2. Spectrum analyzer setting P(Peak): RBW=1MHz, VBW=3MHz, A(Average): RBW=1MHz, VBW ≥ 1/T
3. The result basic equation calculation is as follow:  
Level = Reading + AF + Cable – Preamp + Filter, Margin = Level-Limit
4. The other emission levels were 10dB below the limit
5. The test distance is 3m.
6. \*=Restricted bands of operation

Report No.: TMTN2305000660NR

## 9.6.4 RESTRICTED BAND EDGES

|                     |                         |                            |             |
|---------------------|-------------------------|----------------------------|-------------|
| <b>Product Name</b> | Stereo Turntable System | <b>Test Date</b>           | 2023/05/29  |
| <b>Model Name</b>   | PS-LX310BT              | <b>Test By</b>             | Peter Chu   |
| <b>Test Mode</b>    | GFSK(4.0) TX (CH Low)   | <b>Temp &amp; Humidity</b> | 24.3°C, 52% |

Horizontal

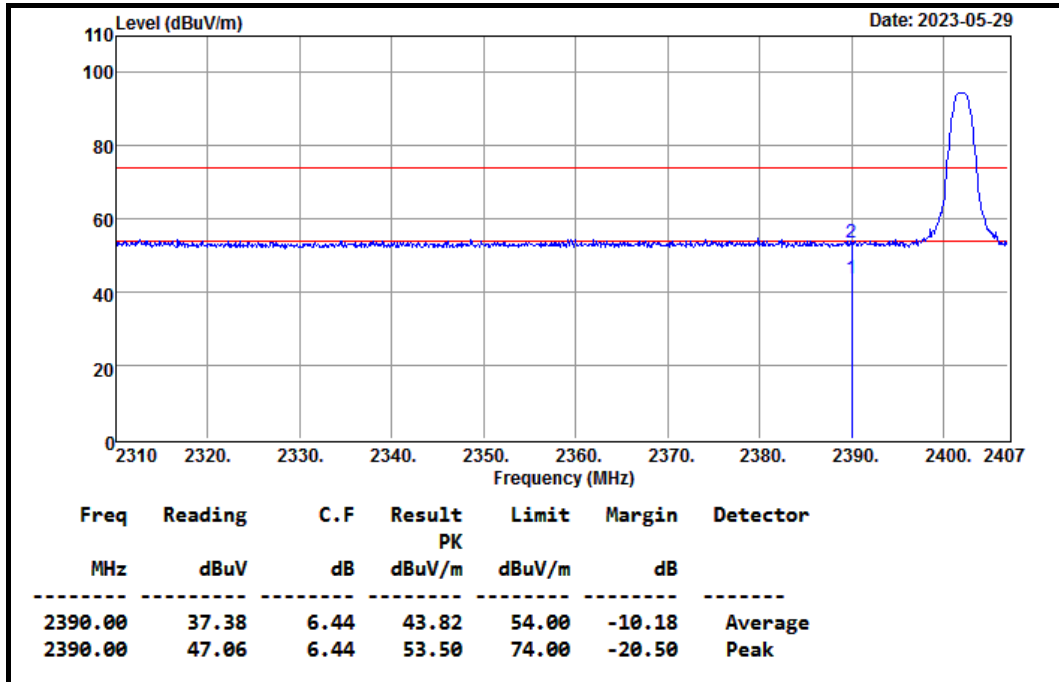

Vertical

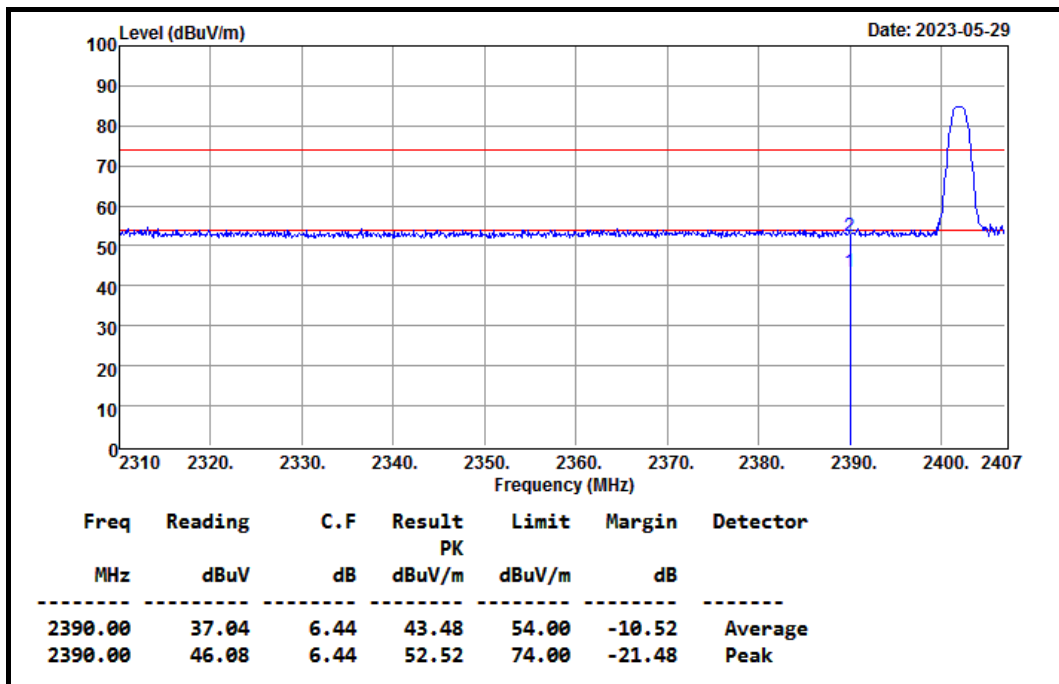

|                     |                         |                            |             |
|---------------------|-------------------------|----------------------------|-------------|
| <b>Product Name</b> | Stereo Turntable System | <b>Test Date</b>           | 2023/05/29  |
| <b>Model Name</b>   | PS-LX310BT              | <b>Test By</b>             | Peter Chu   |
| <b>Test Mode</b>    | GFSK(4.0) TX (CH High)  | <b>Temp &amp; Humidity</b> | 24.3°C, 52% |

Horizontal

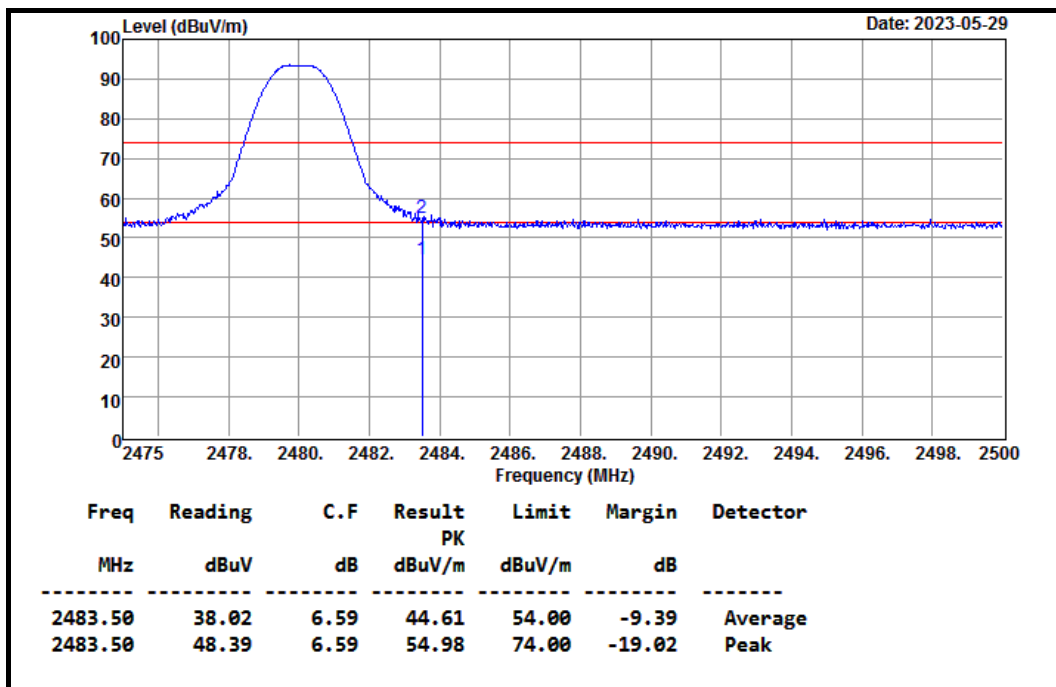

Vertical

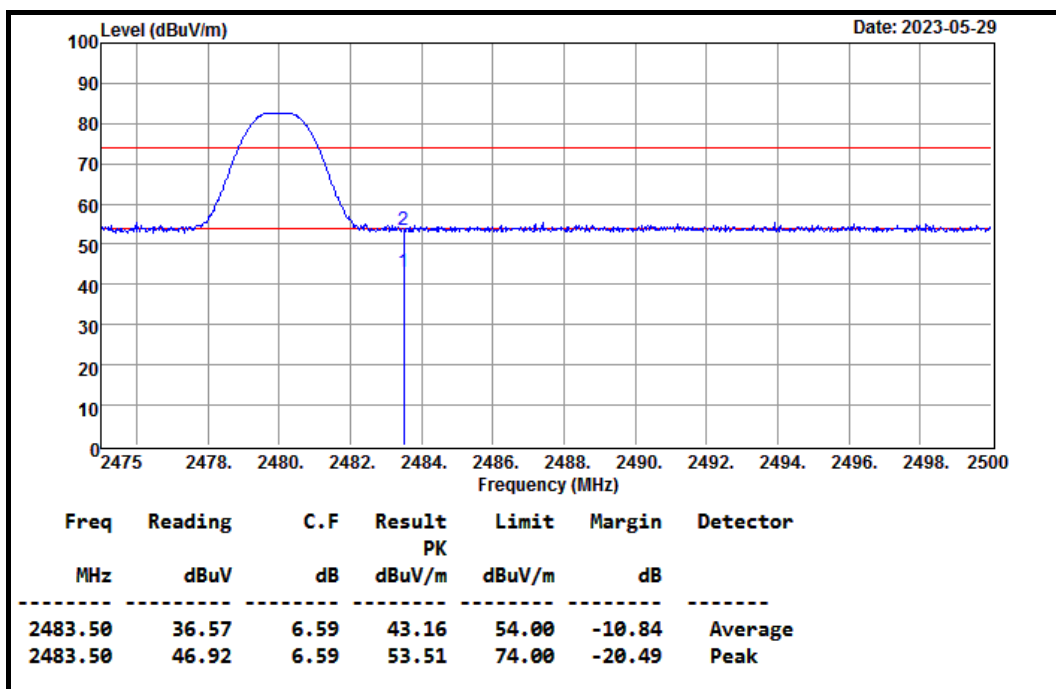



Report No.: TMTN2305000660NR

|                     |                         |                            |             |
|---------------------|-------------------------|----------------------------|-------------|
| <b>Product Name</b> | Stereo Turntable System | <b>Test Date</b>           | 2023/05/29  |
| <b>Model Name</b>   | PS-LX310BT              | <b>Test By</b>             | Peter Chu   |
| <b>Test Mode</b>    | GFSK(5.0) TX (CH Low)   | <b>Temp &amp; Humidity</b> | 24.3°C, 52% |

Horizontal

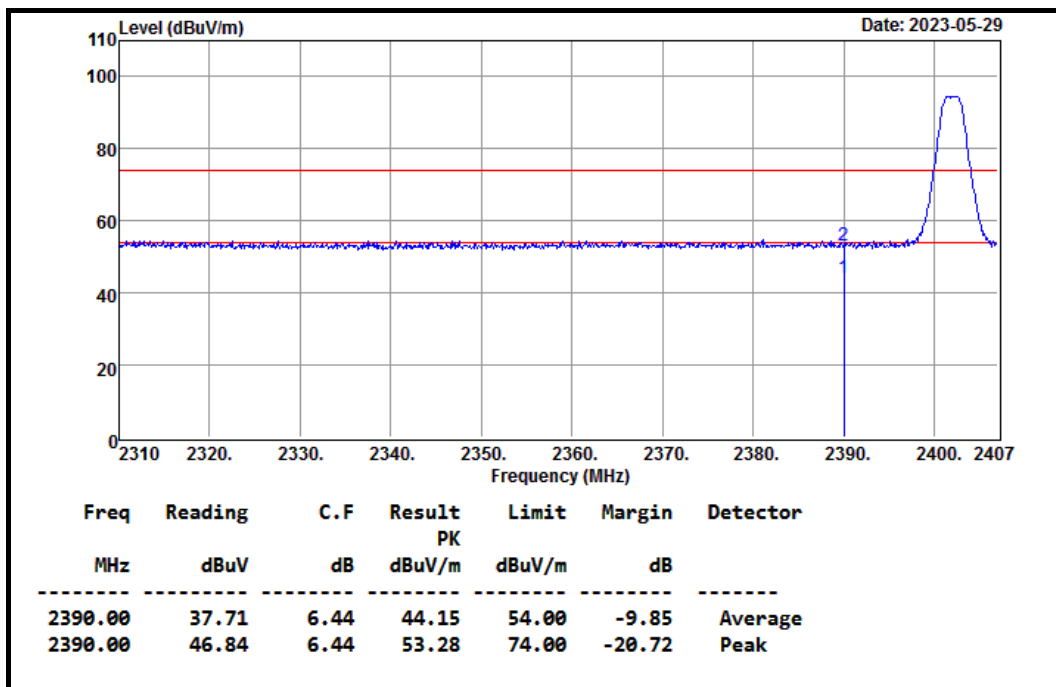

Vertical

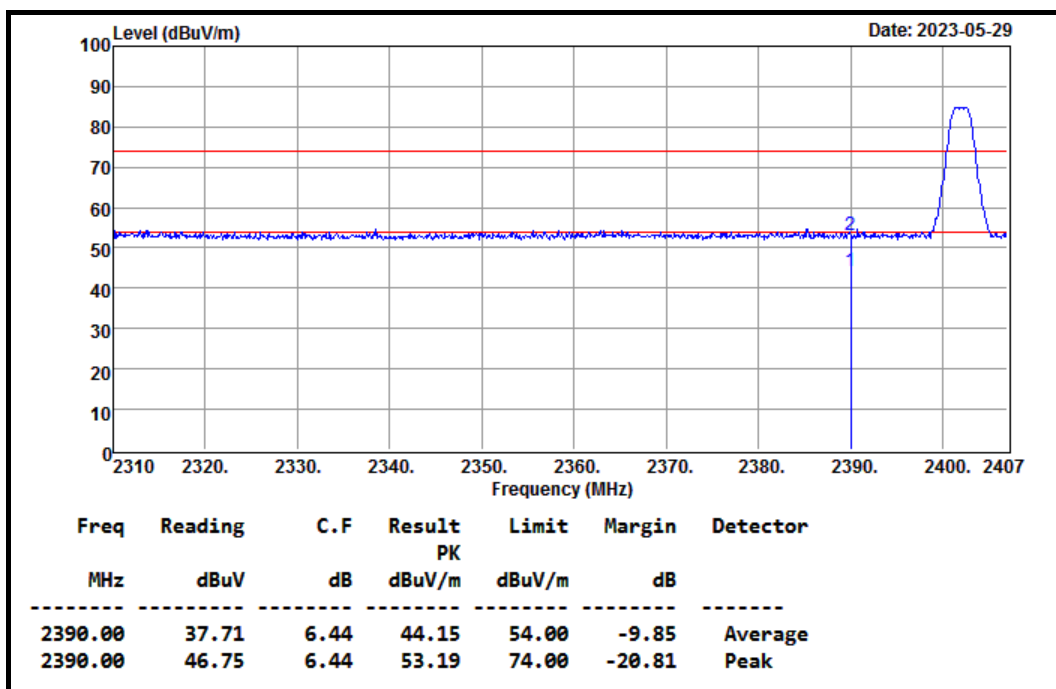

|                     |                         |                            |             |
|---------------------|-------------------------|----------------------------|-------------|
| <b>Product Name</b> | Stereo Turntable System | <b>Test Date</b>           | 2023/05/29  |
| <b>Model Name</b>   | PS-LX310BT              | <b>Test By</b>             | Peter Chu   |
| <b>Test Mode</b>    | GFSK(5.0) TX (CH High)  | <b>Temp &amp; Humidity</b> | 24.3°C, 52% |

Horizontal

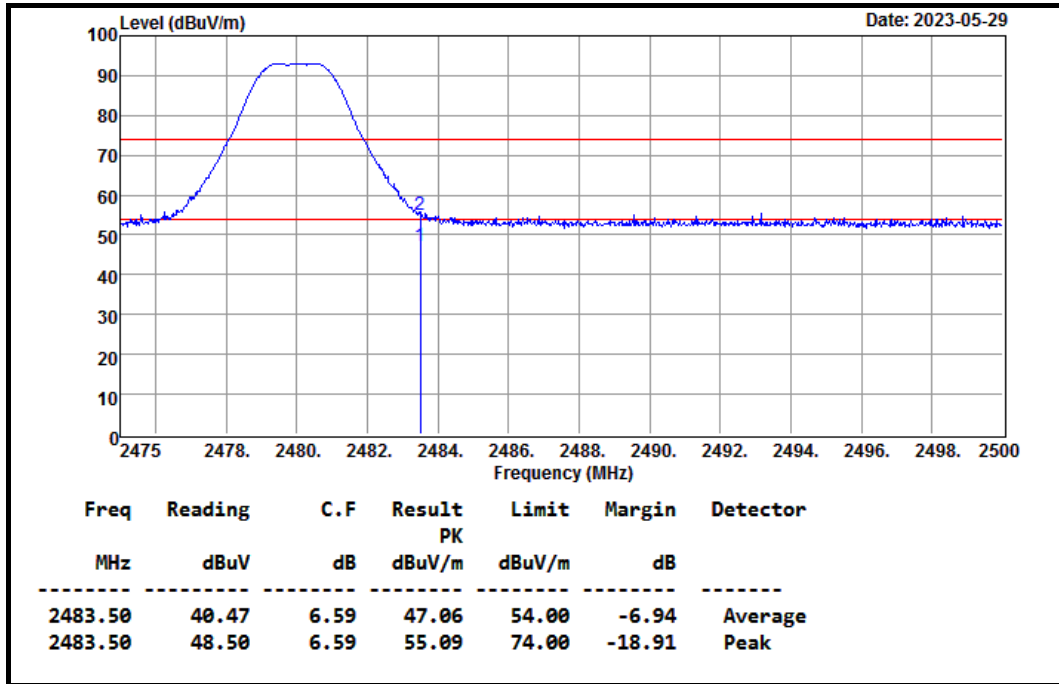

Vertical

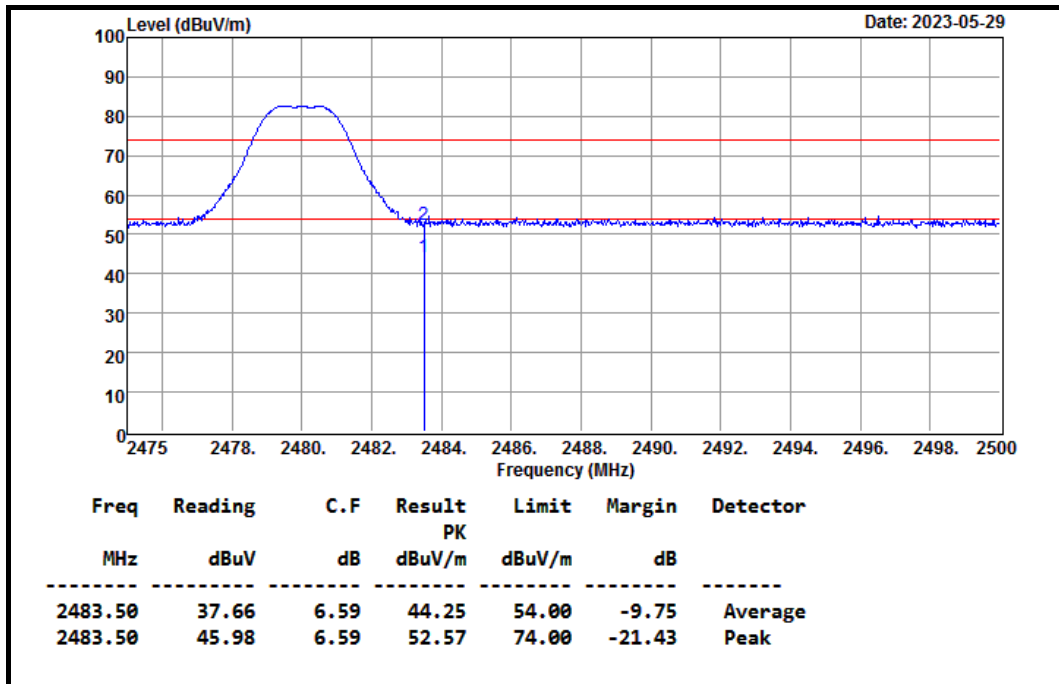

## 9.7 POWERLINE CONDUCTED EMISSIONS

### LIMITS

§ 15.207 (a) Except as shown in paragraph (b) and (c) this section, for an intentional radiator that is designed to be connected to the public utility (AC) power line, the radio frequency voltage that is conducted back onto the AC power line on any frequency or frequencies within the band 150 kHz to 30 MHz shall not exceed the limits in the following table, as measured using a 50  $\mu$ H/50 ohms line impedance stabilization network (LISN). Compliance with the provisions of this paragraph shall be based on the measurement of the radio frequency voltage between each power line and ground at the power terminal.

The lower limit applies at the boundary between the frequency ranges.

| Frequency of Emission (MHz) | Conducted limit (dB $\mu$ v) |          |
|-----------------------------|------------------------------|----------|
|                             | Quasi-peak                   | Average  |
| 0.15 - 0.5                  | 66 to 56                     | 56 to 46 |
| 0.5 - 5                     | 56                           | 46       |
| 5 - 30                      | 60                           | 50       |

Report No.: TMTN2305000660NR

## TEST SETUP

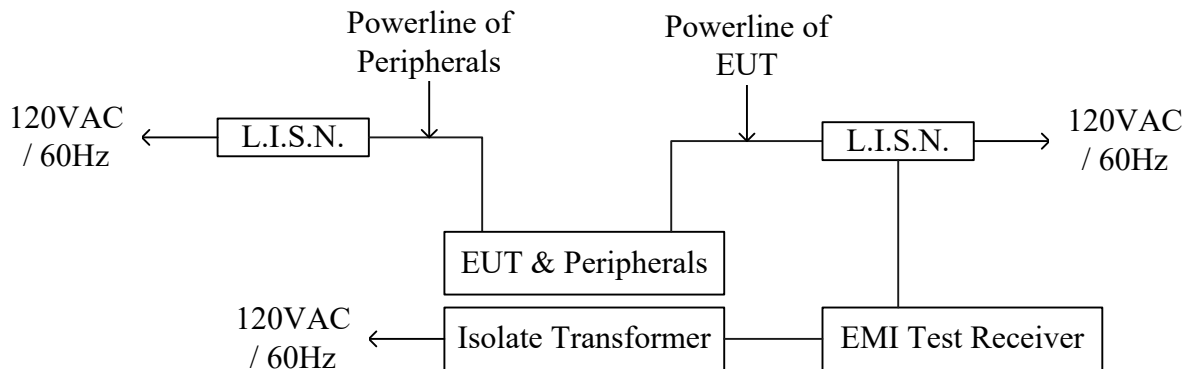
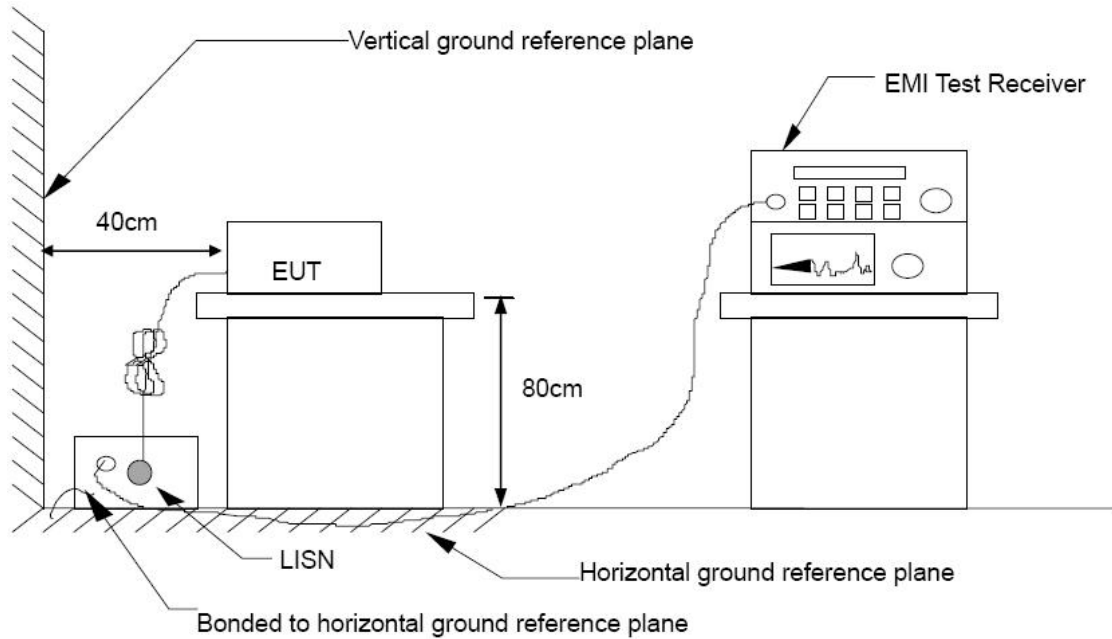

## TEST PROCEDURE

The EUT is placed on a non-conducting table 40 cm from the vertical ground plane and 80cm above the horizontal ground plane. The EUT IS CONFIGURED IN ACCORDANCE WITH ANSI C63.10.

The resolution bandwidth is set to 9 kHz for both quasi-peak detection and average detection measurements.

Line conducted data is recorded for both NEUTRAL and LINE.

Report No.: TMTN2305000660NR

## TEST RESULTS

No non-compliance noted.

Motor: EG-530SD-3F

Test Voltage: AC 120V, 60Hz

|                          |                |                      |       |
|--------------------------|----------------|----------------------|-------|
| Model No.                | PS-LX310BT     | Test Mode            | LINE  |
| Environmental Conditions | 20.3°C, 75% RH | Resolution Bandwidth | 9 kHz |
| Tested by                | Jeremy Zhong   |                      |       |

## LINE

(The chart below shows the highest readings taken from the final data.)

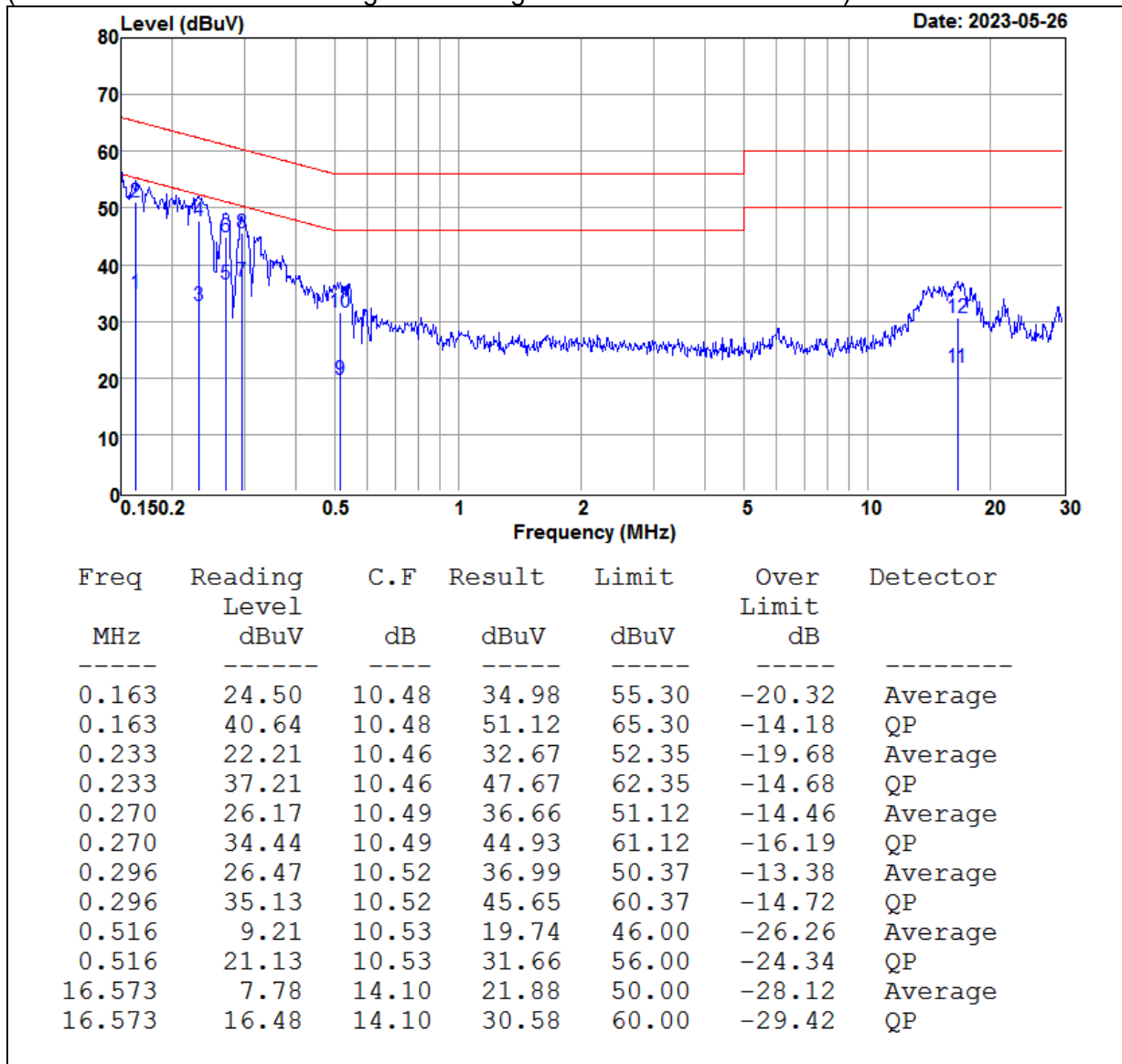

Report No.: TMTN2305000660NR

|                          |                |                      |       |
|--------------------------|----------------|----------------------|-------|
| Model No.                | PS-LX310BT     | Test Mode            | LINE  |
| Environmental Conditions | 20.3°C, 75% RH | Resolution Bandwidth | 9 kHz |
| Tested by                | Jeremy Zhong   |                      |       |

## NEUTRAL

(The chart below shows the highest readings taken from the final data.)

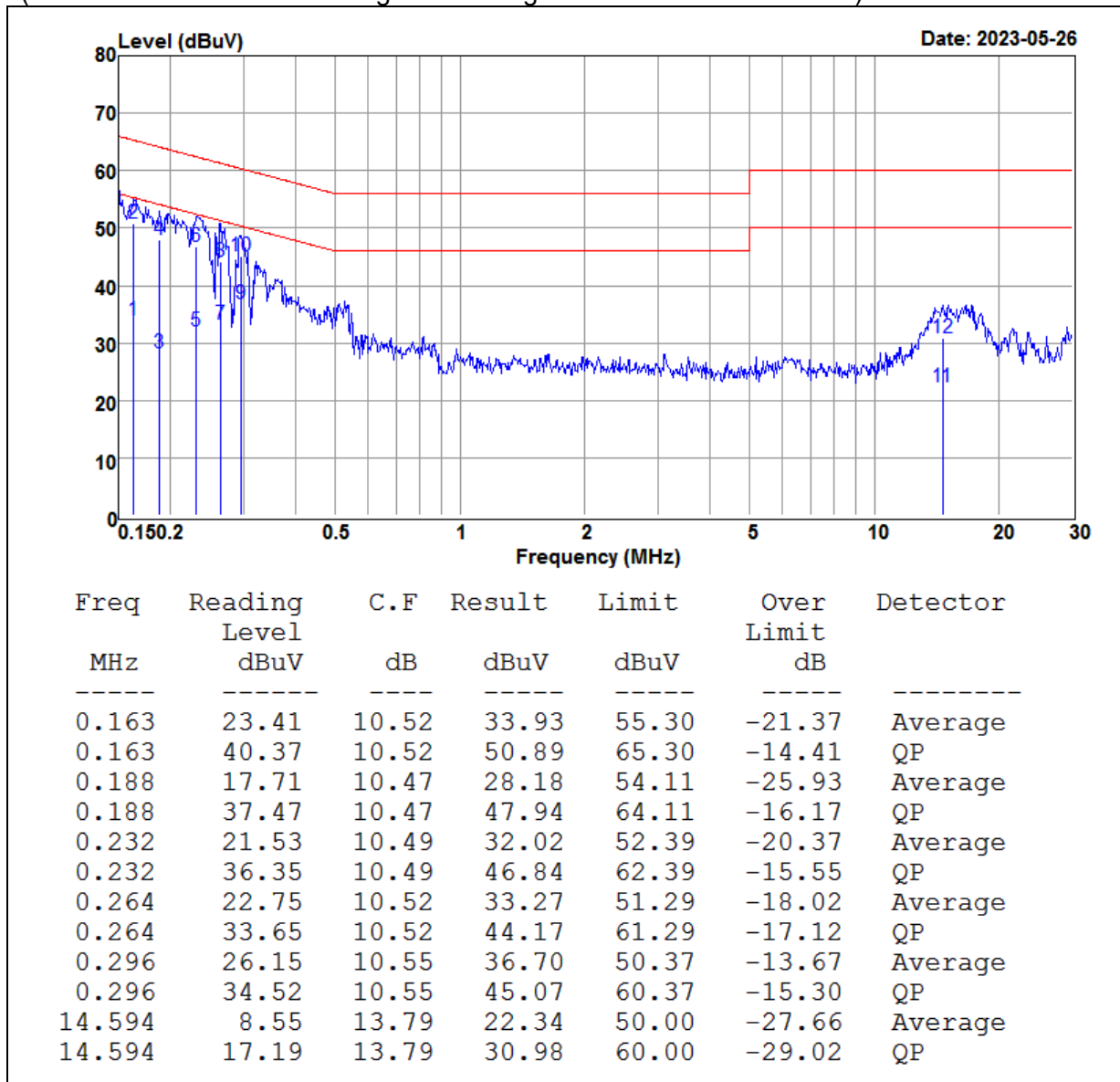

Report No.: TMTN2305000660NR

**Test Voltage: AC 120V, 60Hz**

|                                 |                |                             |       |
|---------------------------------|----------------|-----------------------------|-------|
| <b>Model No.</b>                | PS-LX310BT     | <b>Test Mode</b>            | PHONO |
| <b>Environmental Conditions</b> | 20.3°C, 75% RH | <b>Resolution Bandwidth</b> | 9 kHz |
| <b>Tested by</b>                | Jeremy Zhong   |                             |       |

**LINE**

(The chart below shows the highest readings taken from the final data.)

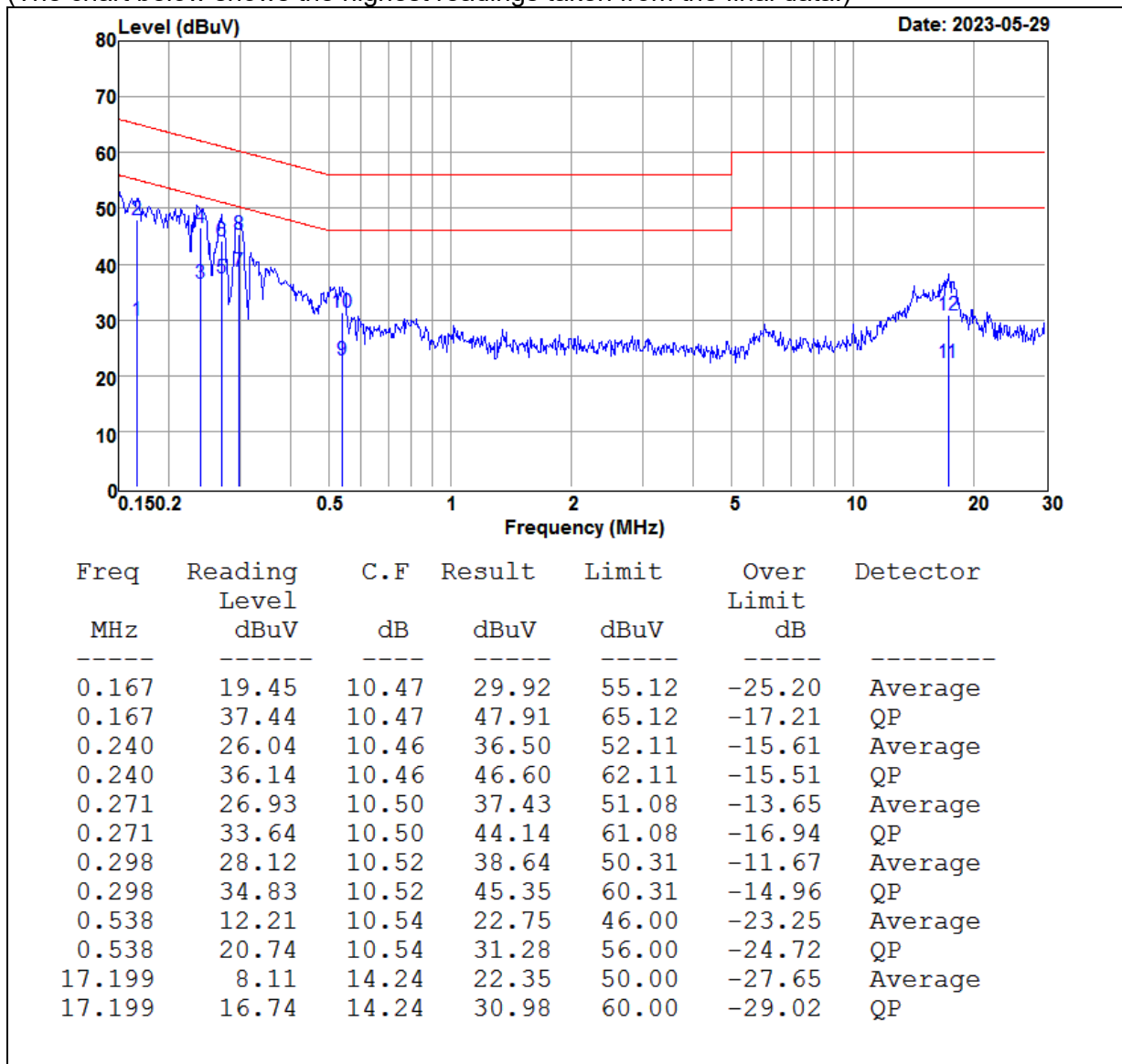

Report No.: TMTN2305000660NR

|                          |                |                      |       |
|--------------------------|----------------|----------------------|-------|
| Model No.                | PS-LX310BT     | Test Mode            | PHONO |
| Environmental Conditions | 20.3°C, 75% RH | Resolution Bandwidth | 9 kHz |
| Tested by                | Jeremy Zhong   |                      |       |

## NEUTRAL

(The chart below shows the highest readings taken from the final data.)

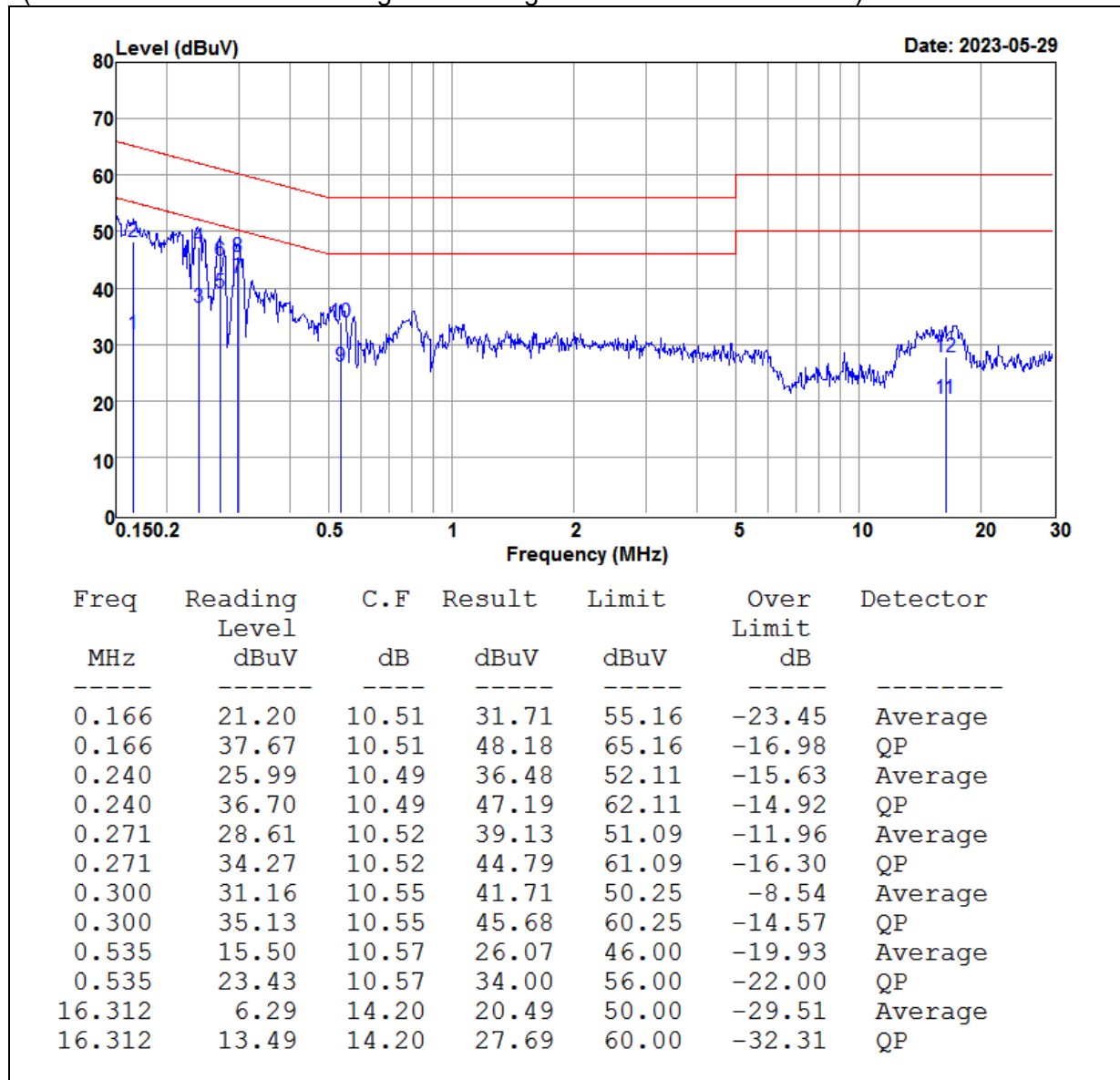



Report No.: TMTN2305000660NR

Motor: M09S

Test Voltage: AC 120V, 60Hz

|                          |                |                      |       |
|--------------------------|----------------|----------------------|-------|
| Model No.                | PS-LX310BT     | Test Mode            | LINE  |
| Environmental Conditions | 20.3°C, 75% RH | Resolution Bandwidth | 9 kHz |
| Tested by                | Jeremy Zhong   |                      |       |

## LINE

(The chart below shows the highest readings taken from the final data.)

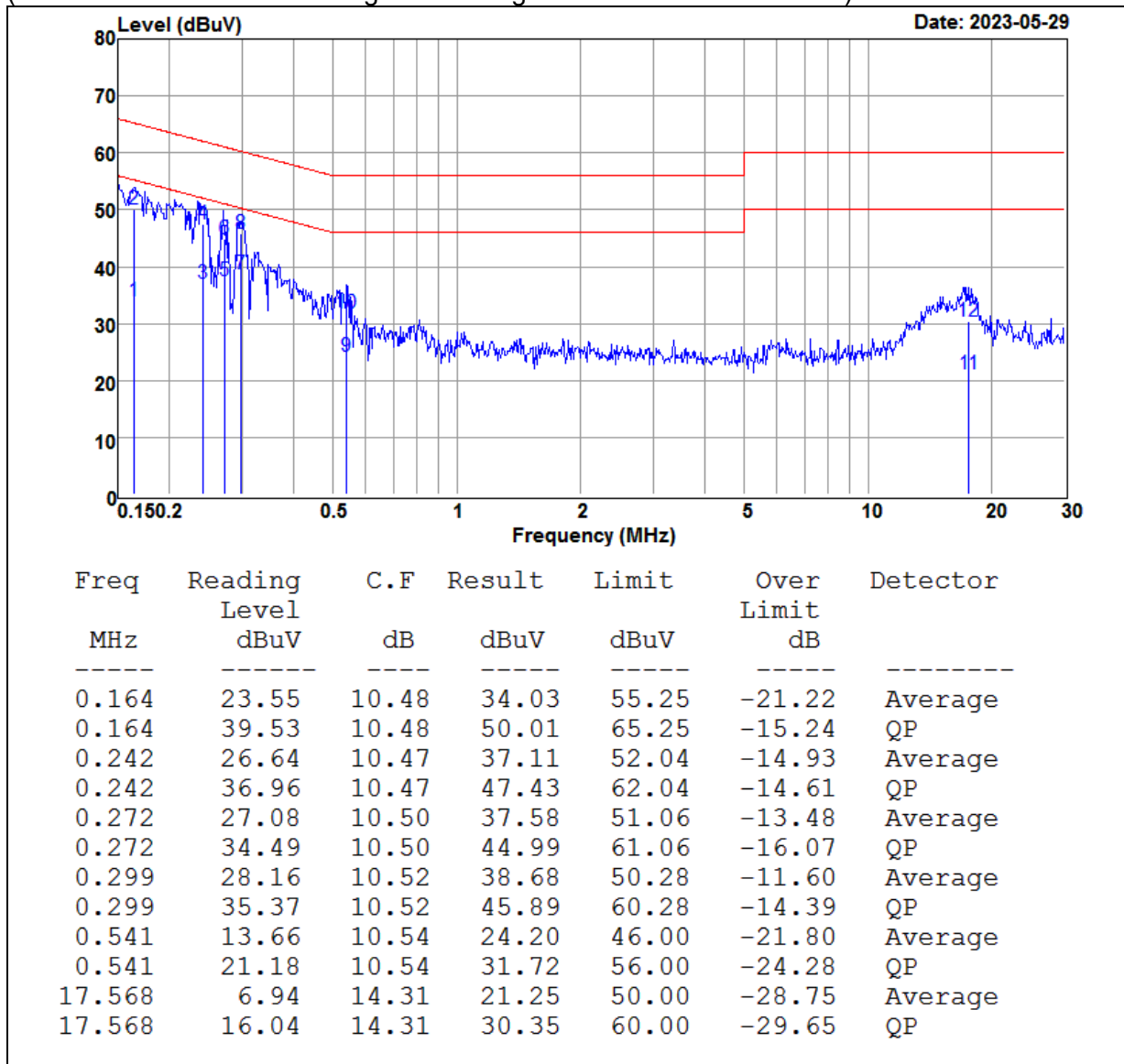

Report No.: TMTN2305000660NR

|                          |                |                      |       |
|--------------------------|----------------|----------------------|-------|
| Model No.                | PS-LX310BT     | Test Mode            | LINE  |
| Environmental Conditions | 20.3°C, 75% RH | Resolution Bandwidth | 9 kHz |
| Tested by                | Jeremy Zhong   |                      |       |

## NEUTRAL

(The chart below shows the highest readings taken from the final data.)

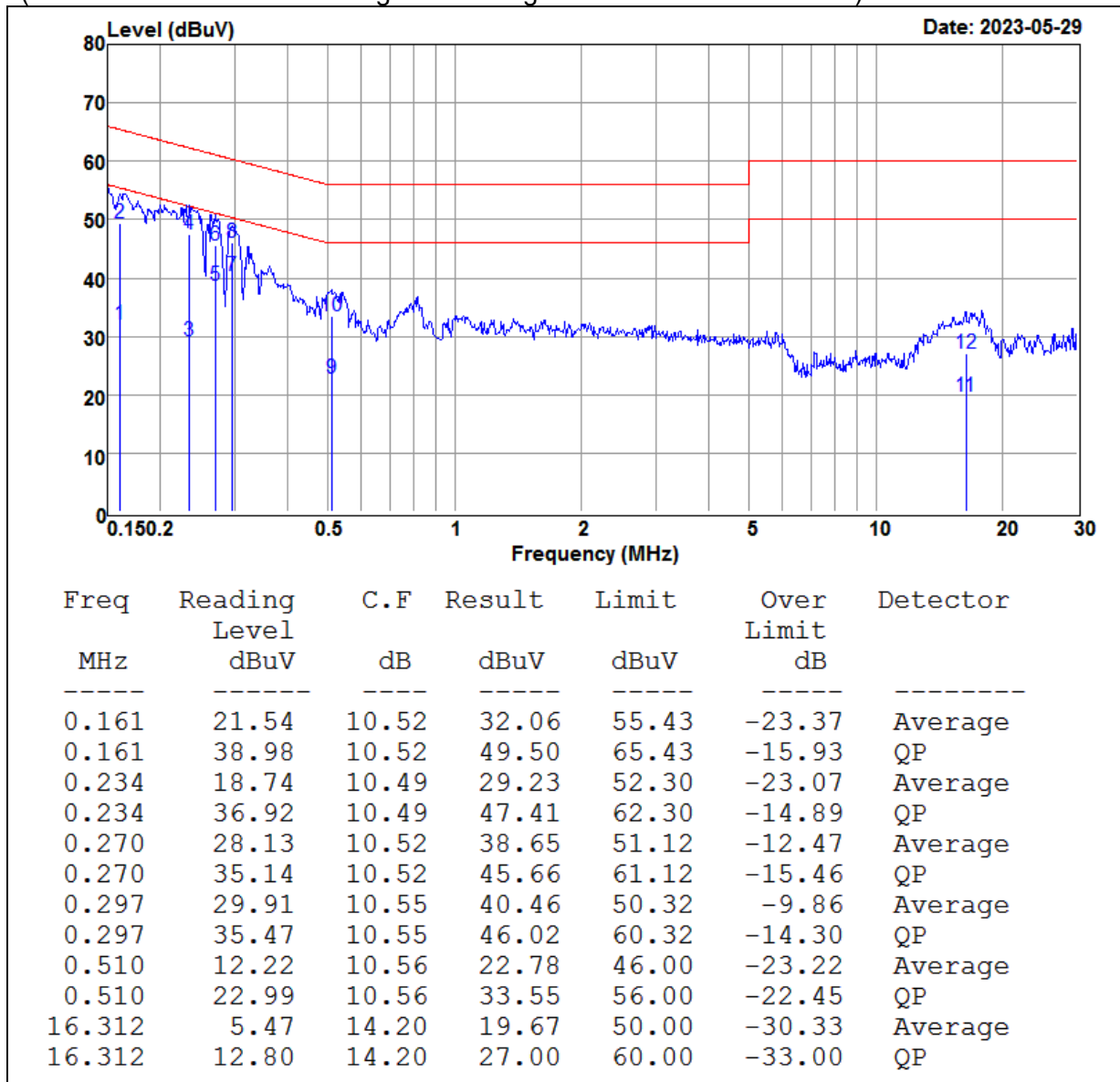

Report No.: TMTN2305000660NR

**Test Voltage: AC 120V, 60Hz**

|                                 |                |                             |       |
|---------------------------------|----------------|-----------------------------|-------|
| <b>Model No.</b>                | PS-LX310BT     | <b>Test Mode</b>            | PHONO |
| <b>Environmental Conditions</b> | 20.3°C, 75% RH | <b>Resolution Bandwidth</b> | 9 kHz |
| <b>Tested by</b>                | Jeremy Zhong   |                             |       |

**LINE**

(The chart below shows the highest readings taken from the final data.)

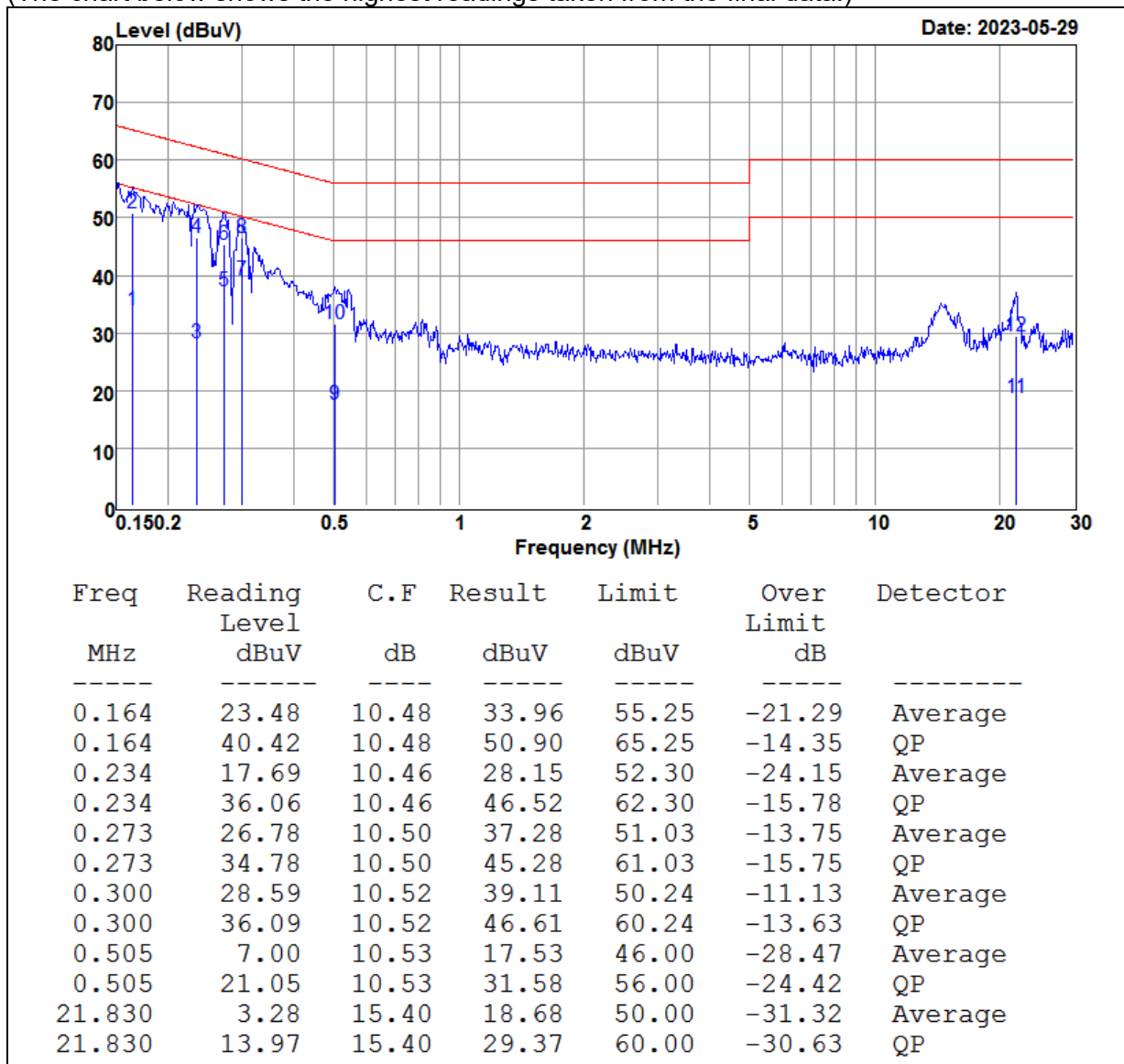

Report No.: TMTN2305000660NR

|                          |                |                      |       |
|--------------------------|----------------|----------------------|-------|
| Model No.                | PS-LX310BT     | Test Mode            | PHONO |
| Environmental Conditions | 20.3°C, 75% RH | Resolution Bandwidth | 9 kHz |
| Tested by                | Jeremy Zhong   |                      |       |

## NEUTRAL

(The chart below shows the highest readings taken from the final data.)

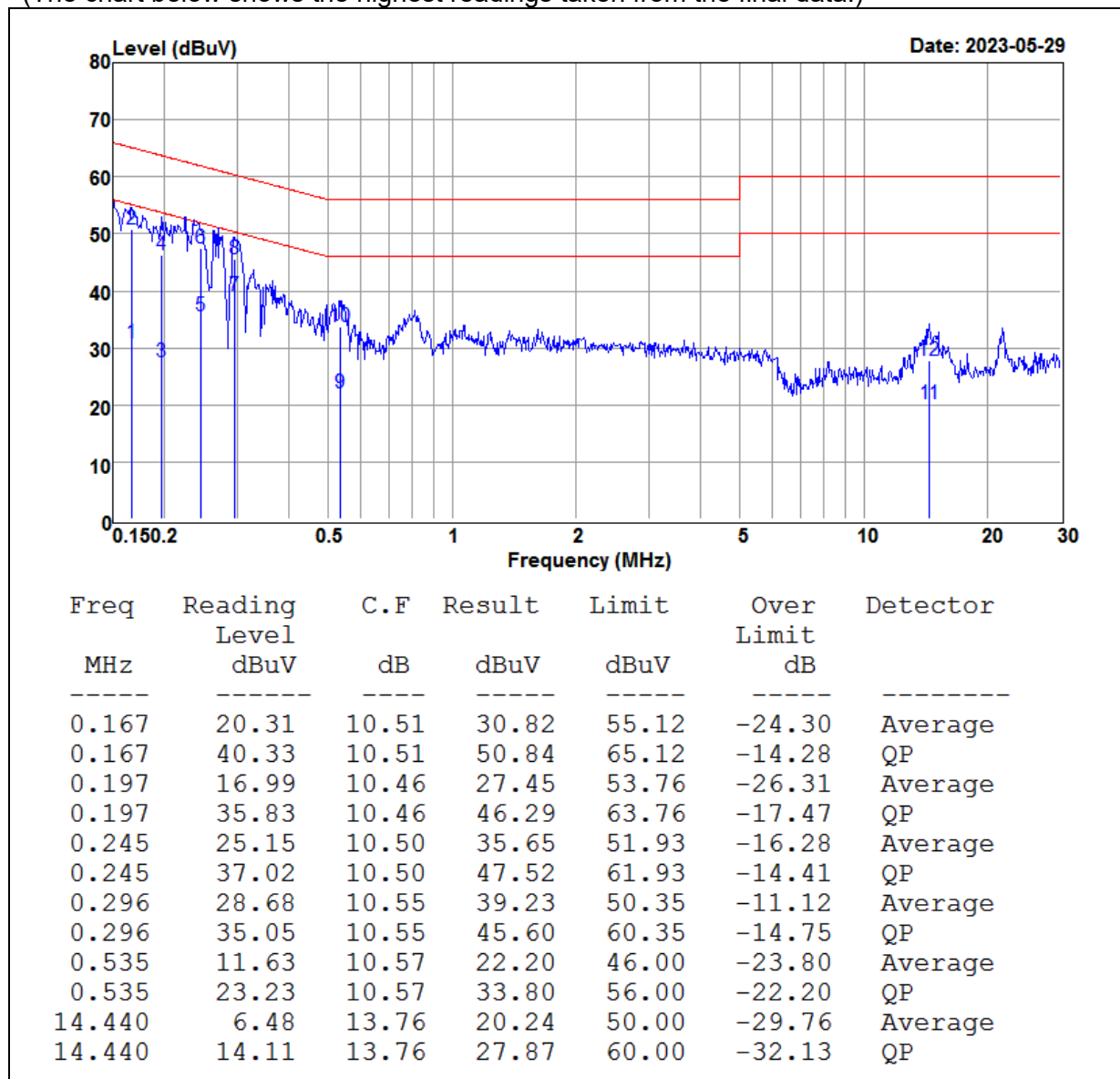

## 10. ANTENNA REQUIREMENT

### 10.1 STANDARD APPLICABLE

For intentional device, according to FCC 47 CFR Section 15.203, an intentional radiator shall be designed to ensure that no antenna other than that furnished by the responsible party shall be used with the device.

And according to FCC 47 CFR Section 15.247 (b), if transmitting antennas of directional gain greater than 6dBi are used, the power shall be reduced by the amount in dB that the directional gain of the antenna exceeds 6dBi.

### 10.2 ANTENNA CONNECTED CONSTRUCTION

Manufacturer: Sunitec  
Type: PCB Antenna  
Model: PS-LX310BT  
Gain: 3.51 dBi

**=== END of Report ===**