

APPENDIX 1: Photographs of test setup

Appendix 1-1: Photograph of EUT and antenna position

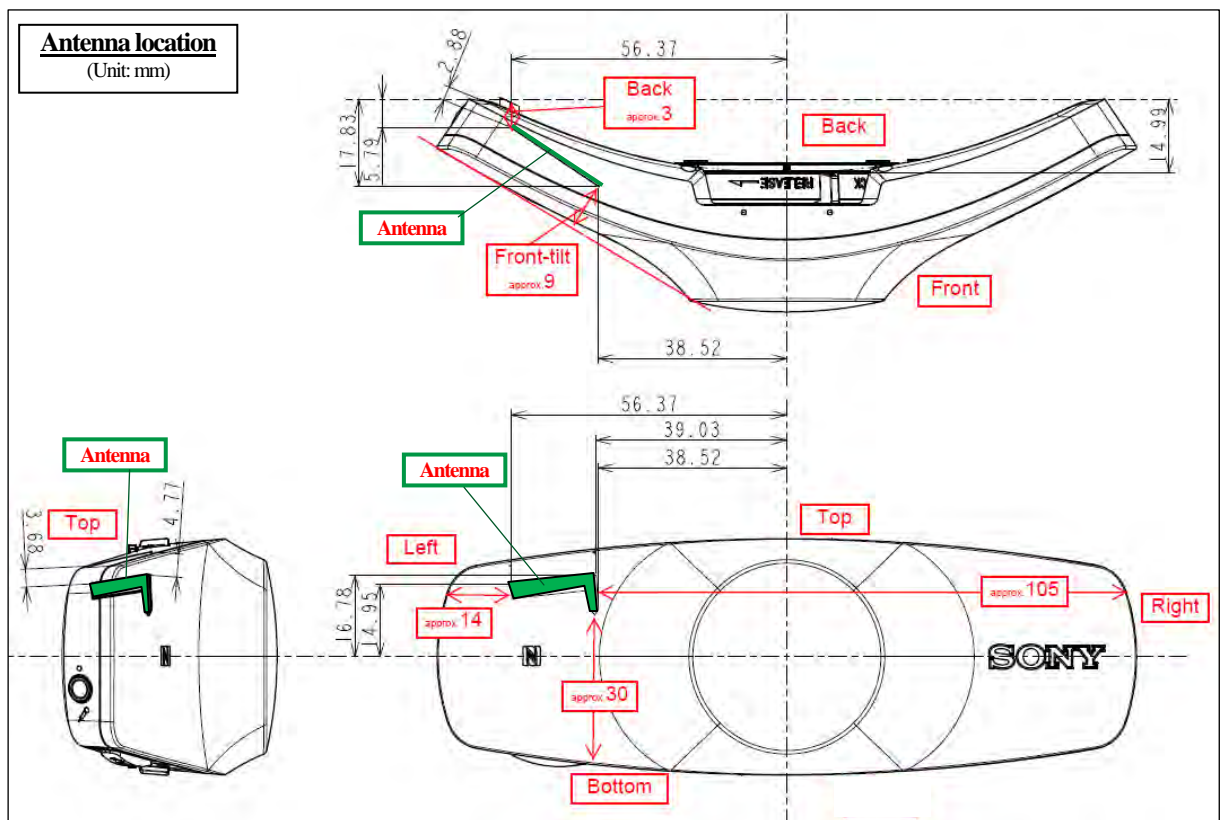

Appendix 1-2: EUT and support equipment

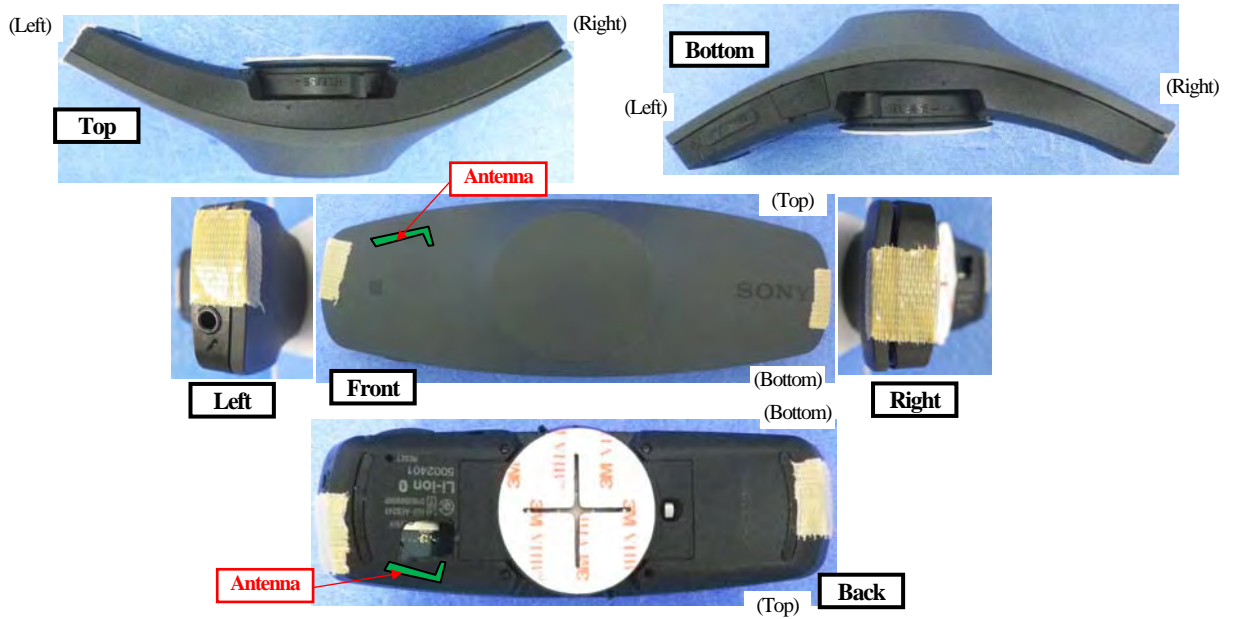
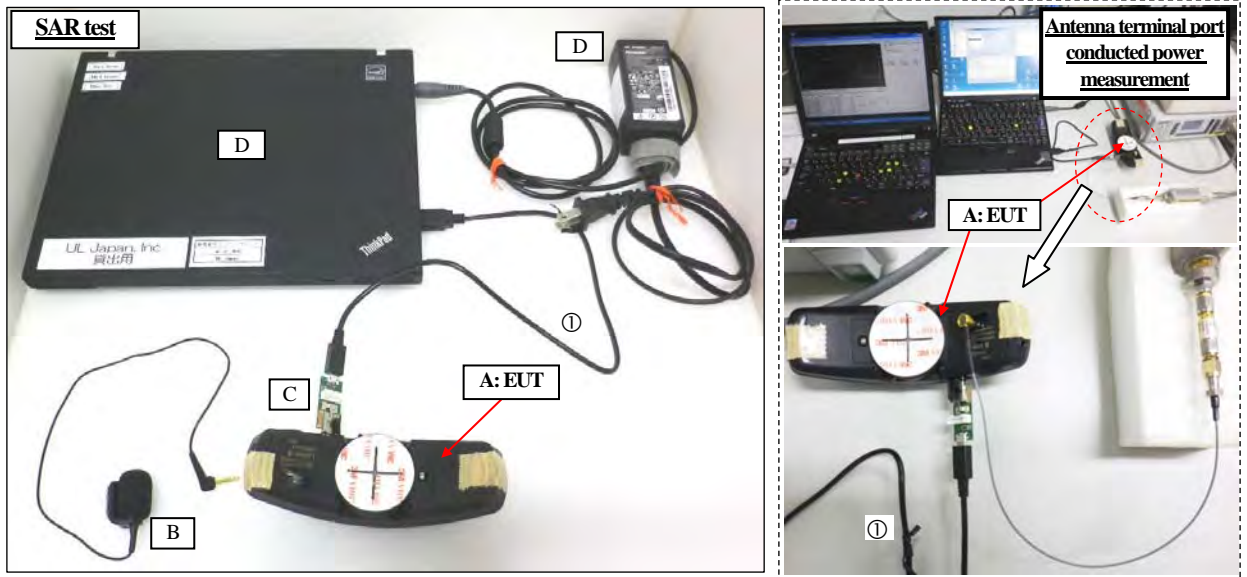

Description of EUT and Support Equipment

No.	Item	Model number	Serial number	Manufacturer	Remark
A	Helmet Mounted Wireless Headset	NYSNO-10	5002401	Sony Corporation	EUT
B	Microphone	-	-	Sony Corporation	Accessory of EUT. With detachable headphone cable: 0.38m (Unshielded).
C	USB I/F jig PCB	-	-	Sony Corporation	Support equipment.
D	Laptop PC (#SRE-124)	7666-77J	LV-B8R1X 08/05	Lenovo	Support equipment.
	AC Adaptor	M/N: 92P1154	-	Lenovo	DC cable: 1.4m (Unshielded). AC cable: 0.8m (Unshielded).

List of cables used

No.	Name	Length (m)	Shield
①	Micro USB cable (*.Accessory of EUT)	0.45	Shielded









Appendix 1-3: Usage example

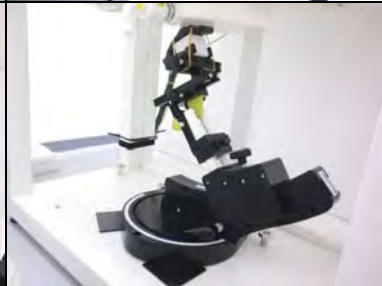

Appendix 1-4: Photograph of test setup

Position	Setup photographs		
Back (Gap=4mm) *. With a microphone			
Front-tilt (Touch) *. With a microphone			
Top (Touch) *. With a microphone			

Appendix 1-4: Photograph of test setup (cont'd)

Position	Setup photographs		
Back (Gap=4mm) *. no microphone			
Front-tilt (Touch) *. no microphone			
Top (Touch) *. no microphone			
Left (Touch) *. no microphone	