APPENDIX 3: Photographs of Test Setup

Radiated Spurious Emission

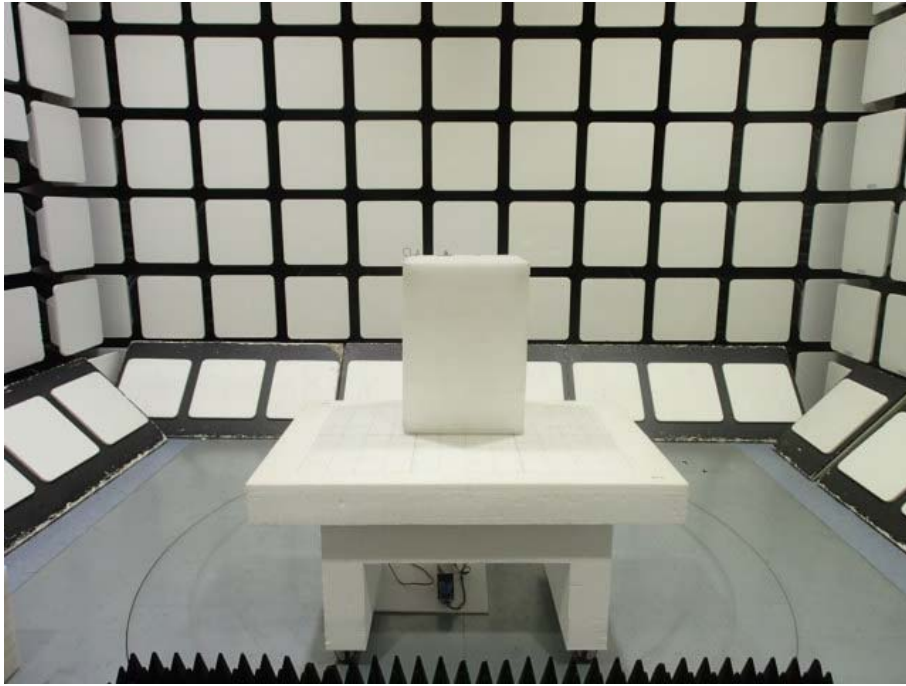

Photo 1

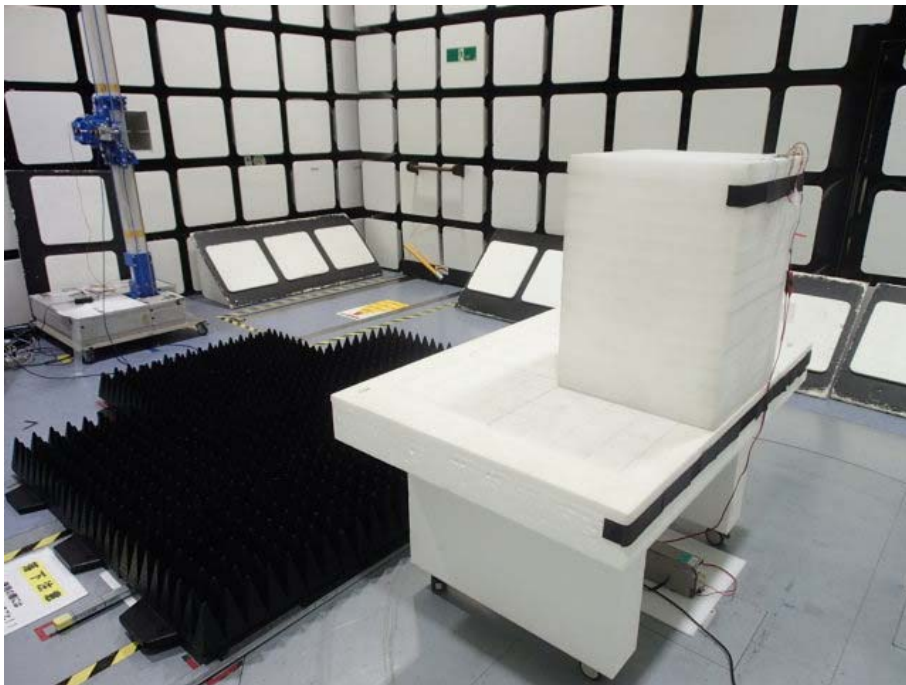
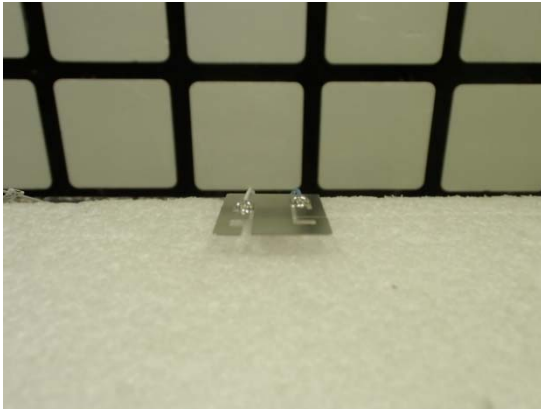

Photo 2

Worst Case Position

Range	Antenna	Horizontal	Vertical
Below 1 GHz	Antenna 1	X-axis	X-axis
	Antenna 3 / Module	X-axis	X-axis
1 GHz – 10 GHz	Antenna 1	X-axis	Z-axis
	Antenna 3 / Module	X-axis	Z-axis
Above 10 GHz	Antenna 1	X-axis	X-axis
	Antenna 3 / Module	Z-axis	Y-axis

**Antenna 1
X-axis**



Y-axis

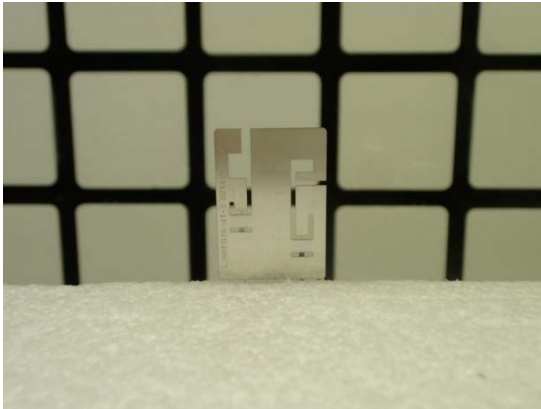

Z-axis

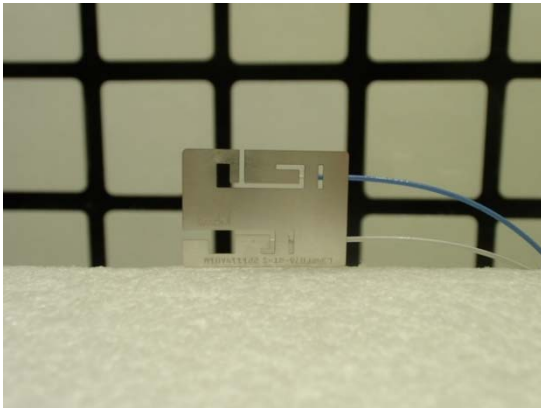

**Antenna 3 / Module
X-axis**

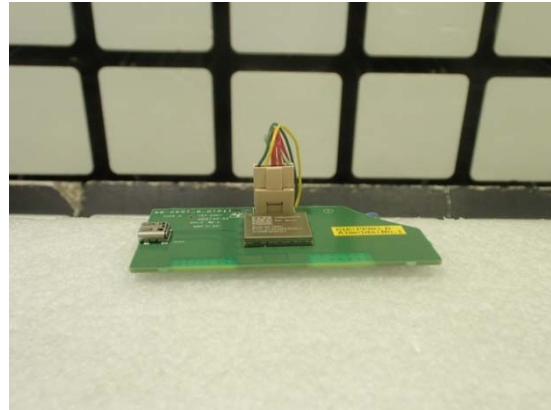

Y-axis



Z-axis



Test Configuration and peripherals

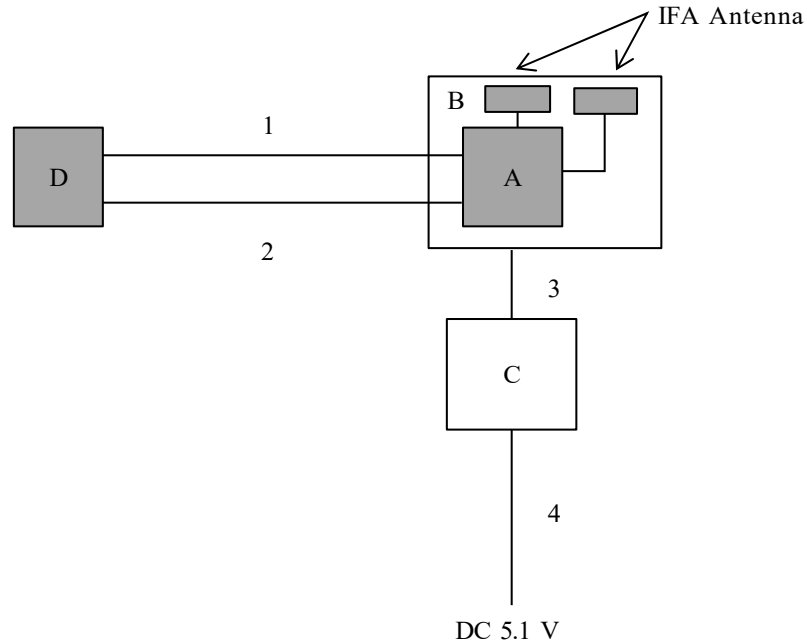

* Cabling and setup(s) were taken into consideration and test data was taken under worse case conditions.

Description of EUT and Support Equipment

No.	Item	Model number	Serial Number	Manufacturer	Remarks
A	Wireless communication module	AW-XM501	Almeida:No.1	AzureWave	EUT
B	Jig Board	WB-CERT-6-D(P1)	Almeida:No.1	Sony Interactive Entertainment Inc.	Antenna 3 and 4
C	Jig Board	WLAN_JIG_Power_B	P-JIG No.2	Sony Interactive Entertainment Inc.	-
D	PIFA Antenna	L34RF078	221114A01W	LUXSHARE-ICT	EUT Antenna 1 and 2

List of Cables Used

No.	Name	Length (m)	Shield		Remarks
			Cable	Connector	
1	Antenna Cable	0.3	Shielded	Shielded	-
2	Antenna Cable	0.3	Shielded	Shielded	-
3	DC Cable	0.4	Unshielded	Unshielded	-
4	DC Cable	2.5	Unshielded	Unshielded	-

End of Report