



RADIO TEST REPORT

Test Report No. : 13671144H-D-R2

Applicant : Sony Interactive Entertainment Inc.
Type of EUT : Wireless communication module
Model Number of EUT : AW-XM501
FCC ID : AK8M20DAL1
Test regulation : FCC Part 15 Subpart E: 2021
(DFS test only)
*Client without radar detection
Test Result : Complied (Refer to SECTION 3)

1. This test report shall not be reproduced in full or partial, without the written approval of UL Japan, Inc.
2. The results in this report apply only to the sample tested.
3. This sample tested is in compliance with the limits of the above standard.
4. The test results in this test report are traceable to the national or international standards.
5. This test report must not be used by the customer to claim product certification, approval, or endorsement by the A2LA accreditation body.
6. This test report covers Radio technical requirements.
It does not cover administrative issues such as Manual or non-Radio test related Requirements. (if applicable)
7. The all test items in this test report are conducted by UL Japan, Inc. Ise EMC Lab.
8. The opinions and the interpretations to the result of the description in this report are outside scopes where UL Japan has been accredited.
9. The information provided from the customer for this report is identified in Section 1.
10. This report is a revised version of 13671144H-D-R1. 13671144H-D-R1 is replaced with this report.

Date of test: February 22, 2021

Representative test engineer:

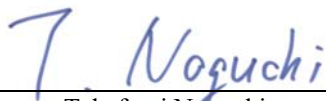

Takafumi Noguchi
Engineer
Consumer Technology Division

Approved by:

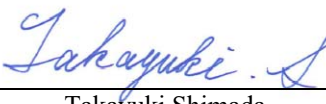

Takayuki Shimada
Leader
Consumer Technology Division



CERTIFICATE 5107.02

- The testing in which "Non-accreditation" is displayed is outside the accreditation scopes in UL Japan.
 There is no testing item of "Non-accreditation".

UL Japan, Inc.
Ise EMC Lab.

4383-326 Asama-cho, Ise-shi, Mie-ken 516-0021 JAPAN
Telephone : +81 596 24 8999
Facsimile : +81 596 24 8124

REVISION HISTORY

Original Test Report No.: 13671144H-D

Revision	Test report No.	Date	Page revised	Contents
- (Original)	13671144H-D	March 23, 2021	-	-
1	13671144H-D-R1	April 12, 2021	P25	Deleted explanatory note *1)
2	13671144H-D-R2	April 19, 2021	P25	Added Item K

UL Japan, Inc.

Ise EMC Lab.

4383-326 Asama-cho, Ise-shi, Mie-ken 516-0021 JAPAN

Telephone : +81 596 24 8999

Facsimile : +81 596 24 8124

Reference: Abbreviations (Including words undescribed in this report)

A2LA	The American Association for Laboratory Accreditation	MCS	Modulation and Coding Scheme
AC	Alternating Current	MRA	Mutual Recognition Arrangement
AFH	Adaptive Frequency Hopping	N/A	Not Applicable
AM	Amplitude Modulation	NIST	National Institute of Standards and Technology
Amp, AMP	Amplifier	NS	No signal detect.
ANSI	American National Standards Institute	NSA	Normalized Site Attenuation
Ant, ANT	Antenna	NVLAP	National Voluntary Laboratory Accreditation Program
AP	Access Point	OBW	Occupied Band Width
ASK	Amplitude Shift Keying	OFDM	Orthogonal Frequency Division Multiplexing
Atten., ATT	Attenuator	P/M	Power meter
AV	Average	PCB	Printed Circuit Board
BPSK	Binary Phase-Shift Keying	PER	Packet Error Rate
BR	Bluetooth Basic Rate	PHY	Physical Layer
BT	Bluetooth	PK	Peak
BT LE	Bluetooth Low Energy	PN	Pseudo random Noise
BW	BandWidth	PRBS	Pseudo-Random Bit Sequence
Cal Int	Calibration Interval	PSD	Power Spectral Density
CCK	Complementary Code Keying	QAM	Quadrature Amplitude Modulation
Ch., CH	Channel	QP	Quasi-Peak
CISPR	Comite International Special des Perturbations Radioelectriques	QPSK	Quadri-Phase Shift Keying
CW	Continuous Wave	RBW	Resolution Band Width
DBPSK	Differential BPSK	RDS	Radio Data System
DC	Direct Current	RE	Radio Equipment
D-factor	Distance factor	RF	Radio Frequency
DFS	Dynamic Frequency Selection	RMS	Root Mean Square
DQPSK	Differential QPSK	RSS	Radio Standards Specifications
DSSS	Direct Sequence Spread Spectrum	Rx	Receiving
EDR	Enhanced Data Rate	SA, S/A	Spectrum Analyzer
EIRP, e.i.r.p.	Equivalent Isotropically Radiated Power	SG	Signal Generator
EMC	ElectroMagnetic Compatibility	SVSWR	Site-Voltage Standing Wave Ratio
EMI	ElectroMagnetic Interference	TR	Test Receiver
EN	European Norm	Tx	Transmitting
ERP, e.r.p.	Effective Radiated Power	VBW	Video BandWidth
EU	European Union	Vert.	Vertical
EUT	Equipment Under Test	WLAN	Wireless LAN
Fac.	Factor		
FCC	Federal Communications Commission		
FHSS	Frequency Hopping Spread Spectrum		
FM	Frequency Modulation		
Freq.	Frequency		
FSK	Frequency Shift Keying		
GFSK	Gaussian Frequency-Shift Keying		
GNSS	Global Navigation Satellite System		
GPS	Global Positioning System		
Hori.	Horizontal		
ICES	Interference-Causing Equipment Standard		
IEC	International Electrotechnical Commission		
IEEE	Institute of Electrical and Electronics Engineers		
IF	Intermediate Frequency		
ILAC	International Laboratory Accreditation Conference		
ISED	Innovation, Science and Economic Development Canada		
ISO	International Organization for Standardization		
JAB	Japan Accreditation Board		
LAN	Local Area Network		
LIMS	Laboratory Information Management System		

UL Japan, Inc.

Ise EMC Lab.

4383-326 Asama-cho, Ise-shi, Mie-ken 516-0021 JAPAN

Telephone : +81 596 24 8999

Facsimile : +81 596 24 8124

CONTENTS **PAGE**

SECTION 1: Customer information..... 5
SECTION 2: Equipment under test (EUT)..... 5
SECTION 3: Scope of Report..... 8
SECTION 4: Test specification, procedures & results..... 8
SECTION 5: Operation of EUT during testing 13
SECTION 6: Channel Move Time, Channel Closing Transmission Time..... 19
SECTION 7: Non-Occupancy Period 21
APPENDIX 1: Test instruments 23
APPENDIX 2: Photographs of test setup 24
 Test Configuration and peripherals25

UL Japan, Inc.

Ise EMC Lab.

4383-326 Asama-cho, Ise-shi, Mie-ken 516-0021 JAPAN

Telephone : +81 596 24 8999

Facsimile : +81 596 24 8124

SECTION 1: Customer information

Company Name	Sony Interactive Entertainment Inc.
Brand Name	SONY
Address	1-7-1 Konan, Minato-ku, Tokyo, 108-0075 Japan
Telephone Number	+81-50-3807-5639
Facsimile Number	+81-50-3807-9594
Contact Person	Miho Nakamura

***Remarks:**

Sony Interactive Entertainment Inc. designates AzureWave Technologies, Inc. as manufacturer of the product (Wireless communication module).

The information provided from the customer is as follows;

- Applicant, Type of EUT, Model Number of EUT, FCC ID on the cover and other relevant pages
- Operating/Test Mode(s) (Mode(s)) on all the relevant pages
- SECTION 1: Customer information
- SECTION 2: Equipment under test (EUT) other than the Receipt Date
- SECTION 4: Operation of EUT during testing

* The laboratory is exempted from liability of any test results affected from the above information in SECTION 2 and 4.

SECTION 2: Equipment under test (EUT)

2.1 Identification of EUT

Type	Wireless communication module
Model Number	AW-XM501
Serial Number	Refer to SECTION 4.2
Country of Manufacture	China
Receipt Date	January 12, 2021
Condition	Engineering prototype (Not for Sale: This sample is equivalent to mass-produced items.)
Modification	No modification by the test lab.

2.2 Product Description

Model: AW-XM501 (referred to as the EUT in this report) is a Wireless communication module.

Product Specification

Operating Temperature	-5 deg. C to 85 deg. C
Power Supply	DC 3.3 V, DC 1.8 V

UL Japan, Inc.

Ise EMC Lab.

4383-326 Asama-cho, Ise-shi, Mie-ken 516-0021 JAPAN

Telephone : +81 596 24 8999

Facsimile : +81 596 24 8124

Radio Specification

WLAN (IEEE802.11b/11g/11n-20/11ax-20)

Equipment Type	Transceiver	
Frequency of Operation	2412 MHz to 2462 MHz	
Type of Modulation	DSSS, OFDM	
	OFDMA (IEEE802.11ax only)	20 MHz: 26/52/106/242-tone RU
Bandwidth & Channel spacing	Less than 20 MHz & 5 MHz	
Method of frequency generation	Synthesizer	
Antenna Type	IFA	
Antenna Gain: G_{ANT}	Antenna 1: 4.0 dBi Antenna 2: 3.5 dBi	
Directional Gain *1)	6.76 dBi	
Maximum clock frequency	320 MHz	

WLAN (IEEE802.11a/11n-20/11ac-20/11ax-20/11n-40/11ac-40/11ax-40/11ac-80/11ax-80)

Equipment Type	Transceiver	
Frequency of Operation	20 M Band: 5180 MHz to 5240 MHz 5260 MHz to 5320 MHz 5500 MHz to 5720 MHz 5745 MHz to 5825 MHz	
	40 M Band: 5190 MHz to 5230 MHz 5270 MHz to 5310 MHz 5510 MHz to 5710 MHz 5755 MHz to 5795 MHz	
	80 M Band: 5210 MHz 5290 MHz 5530 MHz to 5690 MHz 5775 MHz	
Type of Modulation	OFDM	
	OFDMA (IEEE802.11ax only)	20 MHz: 26/52/106/242-tone RU
		40 MHz: 26/52/106/242/484-tone RU
80 MHz: 26/52/106/242/484/996-tone RU		
Bandwidth & Channel spacing	Less than 20 MHz / 40 MHz / 80 MHz & 20 MHz / 40 MHz / 80 MHz	
Method of frequency generation	Synthesizer	
Antenna Type	IFA	PIFA
Antenna Gain: G_{ANT}	Antenna 1: 6.0 dBi	Antenna 3: 4.5 dBi
Directional Gain *1)	8.29 dBi	
Maximum clock frequency	512 MHz	

UL Japan, Inc.

Ise EMC Lab.

4383-326 Asama-cho, Ise-shi, Mie-ken 516-0021 JAPAN

Telephone : +81 596 24 8999

Facsimile : +81 596 24 8124

BT1: Bluetooth (BR / EDR / Low Energy)

Equipment Type	Transceiver
Frequency of Operation	2402 MHz to 2480 MHz
Type of Modulation	BT: FHSS (GFSK, $\pi/4$ DQPSK, 8DPSK) BT LE: GFSK
Bandwidth / Channel spacing	BT: 79 MHz / 1 MHz BT LE: 1 MHz & 2 MHz / 2 MHz
Method of frequency generation	Synthesizer
Antenna Type	PIFA
Antenna Gain	Antenna 3: 5.8 dBi
Maximum clock frequency	128 MHz

BT2: Bluetooth (BR / EDR / Low Energy)

Equipment Type	Transceiver
Frequency of Operation	2402 MHz to 2480 MHz
Type of Modulation	BT: FHSS (GFSK, $\pi/4$ DQPSK, 8DPSK) BT LE: GFSK
Bandwidth / Channel spacing	BT: 79 MHz / 1 MHz BT LE: 1 MHz & 2 MHz / 2 MHz
Method of frequency generation	Synthesizer
Antenna Type	PIFA
Antenna Gain	Antenna 4: 5.8 dBi
Maximum clock frequency	128 MHz

*1) Directional antenna gain = $10 \log \left(\frac{G_{ANT1}}{10^{20}} + \frac{G_{ANT2}}{10^{20}} \right) / 2$

*This test report applies to WLAN (5 GHz band) part.

SECTION 3: Scope of Report

This report only covers DFS requirement, as specified by the following referenced procedures.

SECTION 4: Test specification, procedures & results

4.1 Test Specification

Test Specification	:	FCC Part 15 Subpart E FCC Part 15 final revised on January 12, 2021 and effective February 11, 2021
Title	:	FCC 47CFR Part15 Radio Frequency Device Subpart E Unlicensed National Information Infrastructure Devices Section 15.407 General technical requirements
Test Specification	:	KDB905462 D02 UNII DFS Compliance Procedures New Rules v02
Title	:	COMPLIANCE MEASUREMENT PROCEDURES FOR UNLICENSED- NATIONAL INFORMATION INFRASTRUCTURE DEVICES OPERATING IN THE 5250-5350MHz AND 5470-5725MHz BANDS INCORPORATING DYNAMIC FREQUENCY SELECTION
Test Specification	:	KDB905462 D03 Client Without DFS New Rules v01r02
Title	:	U-NII CLIENT DEVICES WITHOUT RADAR DETECTION CAPABILITY

FCC Part 15.31 (e)

The stable voltage will be supplied by the end product, which will be required to have a power supply regulator. Therefore, the EUT complies with the requirement.

FCC Part 15.203/212 Antenna requirement

[Antenna 1 and 2] The antenna is not removable from the EUT.

[Antenna 3 and 4] The EUT has a unique coupling/antenna connector (U.FL).

Therefore, the equipment complies with the antenna requirement of Section 15.203.

4.2 Procedures and results

Table 1: Applicability of DFS Requirements

Requirement	Operating Mode	Test Procedures & Limits	Deviation	Results
	Client without Radar Detection			
U-NII Detection Bandwidth	Not required	KDB905462 D02 UNII DFS Compliance Procedures New Rules v02	N/A	N/A
Initial Channel Availability Check Time	Not required	FCC15.407 (h)	N/A	N/A
		KDB905462 D02 UNII DFS Compliance Procedures New Rules v02		
		RSS-247 6.3		
Radar Burst at the Beginning of the Channel Availability Check Time	Not required	FCC15.407 (h)	N/A	N/A
		KDB905462 D02 UNII DFS Compliance Procedures New Rules v02		
		RSS-247 6.3		
Radar Burst at the End of the Channel Availability Check Time	Not required	FCC15.407 (h)	N/A	N/A
		KDB905462 D02 UNII DFS Compliance Procedures New Rules v02		
		RSS-247 6.3		
In-Service Monitoring for Channel Move Time, Channel Closing Transmission Time	Yes *1)	FCC15.407 (h)	N/A	Complied a)
		KDB905462 D02 UNII DFS Compliance Procedures New Rules v02		
		RSS-247 6.3		
In-Service Monitoring for Non-Occupancy period	Yes *	FCC15.407 (h)	N/A	Complied b)
		KDB905462 D02 UNII DFS Compliance Procedures New Rules v02		
		RSS-247 6.3		
Statistical Performance Check	Not required	FCC15.407 (h)	N/A	N/A
		KDB905462 D02 UNII DFS Compliance Procedures New Rules v02		
<p>Note: UL Japan, Inc.'s EMI Work Procedures No. 13-EM-W0422. *1) This EUT does not support preamble puncturing (channel puncturing) on 802.11ax.</p> <p>a) Refer to SECTION 6, clause 6.3 b) Refer to SECTION 7, clause 7.3</p> <p>Symbols: Complied The data of this test item has enough margin, more than the measurement uncertainty. Complied# The data of this test item meets the limits unless the measurement uncertainty is taken into consideration.</p>				

*Although this test was not required in FCC, KDB 905462 D02, it was performed as additional test.

Table 2 DFS Detection Thresholds for Master Devices and Client Devices With Radar Detection

Maximum Transmit Power	Value (See Notes 1,2, and 3)
≥ 200 milliwatt	-64 dBm
< 200 milliwatt and power spectral density < 10dBm/MHz	-62 dBm
< 200 milliwatt that do not meet the power spectral density requirement	-64 dBm
<p>Note 1: This is the level at the input of the receiver assuming a 0 dBi receive antenna.</p> <p>Note 2: Throughout these test procedures an additional 1 dB has been added to the amplitude of the test transmission waveforms to account for variations in measurement equipment. This will ensure that the test signal is at or above the detection threshold level to trigger a DFS response.</p> <p>Note 3: EIRP is based on the highest antenna gain. For MIMO devices refer to KDB Publication 662911 D01.</p>	

Table 3 DFS Response Requirement Values

Parameter	Value
Non-occupancy period	Minimum 30 minutes
Channel Availability Check Time	60 seconds
Channel Move Time	10 seconds See Note 1
Channel Closing Transmission Time	200 milliseconds + an aggregate of 60 milliseconds over remaining 10 second period. See Notes 1 and 2
U-NII Detection Bandwidth	Minimum 100 % of the U-NII 99 % transmission power bandwidth See Note 3
<p>Note 1: Channel Move Time and the Channel Closing Transmission Time should be performed with Radar Type 0. The measurement timing begins at the end of the Radar Type 0 burst.</p> <p>Note 2: The Channel Closing Transmission Time is comprised of 200 milliseconds starting at the beginning of the Channel Move Time plus any additional intermittent control signals required to facilitate a Channel move (an aggregate of 60 milliseconds) during the remainder of the 10 second period. The aggregate duration of control signal will not count quiet periods in between transmissions.</p> <p>Note 3: During the U-NII Detection Bandwidth detection test, radar type 0 should be used. For each frequency step the minimum percentage of detection is 90 percent. Measurements are performed with no data traffic.</p>	

Table 4 Short Pulse Radar Test Waveform

Radar Type	Pulse Width (μsec)	PRI (μsec)	Number of Pulses	Minimum Percentage of Successful Detection	Minimum Number of Trials
0	1	1428	18	See Note 1	See Note 1
1	1	Test A: 15 unique PRI values randomly selected from the list of 23 PRI values in Table 5a	Roundup{(1/360)* (19*10 ⁶ /PRI μsec)}	60 %	30
		Test B: 15 unique PRI values randomly selected within the range of 518-3066 μsec, with a minimum increment of 1 μsec, excluding PRI values selected in Test A			
2	1-5	150-230	23-29	60 %	30
3	6-10	200-500	16-18	60 %	30
4	11-20	200-500	12-16	60 %	30
Aggregate (Rader Types 1-4)				80 %	120
Note 1: Short Pulse Radar Type 0 should be used for the detection bandwidth test, channel move time, and channel closing time tests.					

Table 5 Long Pulse Radar Test Waveform

Radar Type	Pulse Width (μsec)	Chip Width (MHz)	PRI (μsec)	Number of Pulses per Burst	Number of Burst	Minimum Percentage of Successful Detection	Minimum Number of Trials
5	50-100	5 - 20	1000-2000	1-3	8-20	80 %	30

Table 6 Frequency Hopping Radar Test Waveform

Radar Type	Pulse Width (μsec)	PRI (μsec)	Pulse per Hop (kHz)	Hopping Rate (kHz)	Hopping Sequence Length (msec)	Minimum Percentage of Successful Detection	Minimum Number of Trials
6	1	333	9	0.333	300	70 %	30

4.3 Addition to standard

No addition, exclusion nor deviation has been made from the standard.

UL Japan, Inc.

Ise EMC Lab.

4383-326 Asama-cho, Ise-shi, Mie-ken 516-0021 JAPAN
Telephone : +81 596 24 8999
Facsimile : +81 596 24 8124

4.4 Test Location

UL Japan, Inc. Ise EMC Lab.

*A2LA Certificate Number: 5107.02 / FCC Test Firm Registration Number: 199967

ISED Lab Company Number: 2973C / CAB identifier: JP0002

4383-326 Asama-cho, Ise-shi, Mie-ken 516-0021 JAPAN

Telephone: +81 596 24 8999, Facsimile: +81 596 24 8124

Test site	Width x Depth x Height (m)	Size of reference ground plane (m) / horizontal conducting plane	Other rooms	Maximum measurement distance
No.1 semi-anechoic chamber	19.2 x 11.2 x 7.7	7.0 x 6.0	No.1 Power source room	10 m
No.2 semi-anechoic chamber	7.5 x 5.8 x 5.2	4.0 x 4.0	-	3 m
No.3 semi-anechoic chamber	12.0 x 8.5 x 5.9	6.8 x 5.75	No.3 Preparation room	3 m
No.3 shielded room	4.0 x 6.0 x 2.7	N/A	-	-
No.4 semi-anechoic chamber	12.0 x 8.5 x 5.9	6.8 x 5.75	No.4 Preparation room	3 m
No.4 shielded room	4.0 x 6.0 x 2.7	N/A	-	-
No.5 semi-anechoic chamber	6.0 x 6.0 x 3.9	6.0 x 6.0	-	-
No.5 measurement room	6.4 x 6.4 x 3.0	6.4 x 6.4	-	-
No.6 shielded room	4.0 x 4.5 x 2.7	4.0 x 4.5	-	-
No.6 measurement room	4.75 x 5.4 x 3.0	4.75 x 4.15	-	-
No.7 shielded room	4.7 x 7.5 x 2.7	4.7 x 7.5	-	-
No.8 measurement room	3.1 x 5.0 x 2.7	3.1 x 5.0	-	-
No.9 measurement room	8.8 x 4.6 x 2.8	2.4 x 2.4	-	-
No.11 measurement room	6.2 x 4.7 x 3.0	4.8 x 4.6	-	-

* Size of vertical conducting plane (for Conducted Emission test) : 2.0 x 2.0 m for No.1, No.2, No.3, and No.4 semi-anechoic chambers and No.3 and No.4 shielded rooms.

4.5 Uncertainty

The following uncertainties have been calculated to provide a confidence level of 95% using a coverage factor k=2. Time Measurement uncertainty for this test was: (\pm) 0.012%

4.6 Test instruments of DFS and Test set up

Refer to APPENDIX.

SECTION 5: Operation of EUT during testing

5.1 Operating Modes

The EUT, which is a Client Device without Radar detection capability, operates over the U-NII-2A and U-NII-2C Band.

The channel-loading of approximately 17% or greater was used for testing, and its test data was transferred from the Master Device to the Client Device for all test configurations.

The EUT utilizes the 802.11a/n/ac/ax architecture, with a 20 MHz, 40 MHz and 80 MHz channel bandwidth.

The FCC ID for the Master Device used with EUT for DFS testing is LDK102087.

The rated output power of the Master unit is >200 mW(23 dBm). Therefore the required interference threshold level is -64 dBm. After correction for antenna gain and procedural adjustments, the required conducted threshold at the antenna port is $-64 + 1 + 0 = -63.0$ dBm (threshold level + additional 1 dB + antenna gain).

It is impossible for users to change DFS control, because the DFS function is written on the firmware and users cannot access it.

The EUT was set by the software as follows:

Software name: iPerf

Version: 2.0.5

(Date: February 22, 2021, Storage location: Driven by connected PC)

5.2 Configuration and peripherals

This page has been submitted for a separate exhibit.

UL Japan, Inc.

Ise EMC Lab.

4383-326 Asama-cho, Ise-shi, Mie-ken 516-0021 JAPAN

Telephone : +81 596 24 8999

Facsimile : +81 596 24 8124

5.3 Test and Measurement System

SYSTEM OVERVIEW

The measurement system is based on a conducted test method.

The software selects waveform parameters from within the bounds of the signal type on a random basis using uniform distribution. The short pulse types 1, 2, 3, and 4, the long pulse type 5, and the frequency hopping type 6 parameters are randomized at run-time.

The signal monitoring equipment consists of a spectrum analyzer with the capacity to display 8001 bins on the horizontal axis. A time-domain resolution of 2 msec/bin is achievable with a 16 second sweep time, meeting the 10 seconds short pulse reporting criteria. The aggregate ON time is calculated by multiplying the number of bins above a threshold during a particular observation period by the dwell time per bin, with the analyzer set to peak detection.

FREQUENCY HOPPING RADAR WAVEFORM GENERATING SUBSYSTEM

The first 100 frequencies are selected out of the hopping sequence of the randomized 475 hop frequencies.

Only a *Burst* that has the frequency falling within the receiver bandwidth of the tested U-NII device is selected among those frequencies. (Frequency-domain simulation). The radar waveform generated at the start time of the selected *Burst* (Time-domain simulation) is download to the Signal Generator.

If all of the randomly selected 100 frequencies do not fall within the receiver bandwidth of the U-NII device, the radar waveform is not used for the test.

CONDUCTED METHODS SYSTEM BLOCK DIAGRAM

<Client mode>

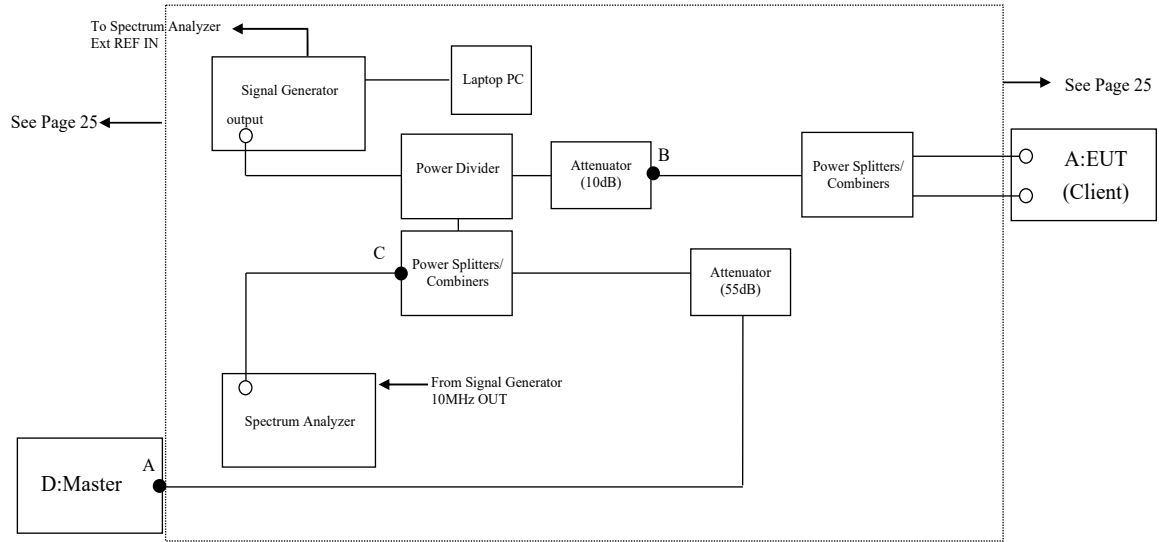

MEASUREMENT SYSTEM FREQUENCY REFERENCE

Lock the signal generator and the spectrum analyzer to the same reference sources as follows: Connect the 10 MHz OUT on the signal generator to the EXT REF IN on the spectrum analyzer and set the spectrum analyzer Ext to On.

SYSTEM CALIBRATION

Step 1: Set the system as shown in Figure 3 of KDB905462 D02 7.2.2.

Step 2: Adjust each attenuator to fulfill the following three conditions:

- WLAN can be communicated, and
- Rader detection threshold level is bigger than Client Device traffic level on the spectrum analyzer, and
- Master Device traffic level is not displayed on the spectrum analyzer.

Step 3: Terminate 50 ohm at B and C points, and connect the spectrum analyzer to the point A. (See the figure on page 16)
At the point A, adjust the signal generator and spectrum analyzer to the center frequency of the channel to be measured.

Download the applicable radar waveforms to the signal generator. Select the radar waveform, trigger a burst manually and measure the amplitude on the spectrum analyzer. Readjust the amplitude of the signal generator as required so that the peak level of the waveform is at a displayed level equal to the required or desired interference detection threshold.

Separate signal generator amplitude settings are determined as required for each radar type.

Step 4: Without changing any of the instrument settings, restore the system setting to Step 2 and adjust the Reference Level Offset of the spectrum analyzer to the level at Step 3.

By taking the above steps 1 to 4, the spectrum analyzer displays the level of the signal generator as received at the antenna ports of the Master Device.

See Clause 5.4 for Plots of Noise, Rader Waveforms, and WLAN signals.

5.4 Plots of Noise, Rader Waveforms, and WLAN signals

<Client mode>

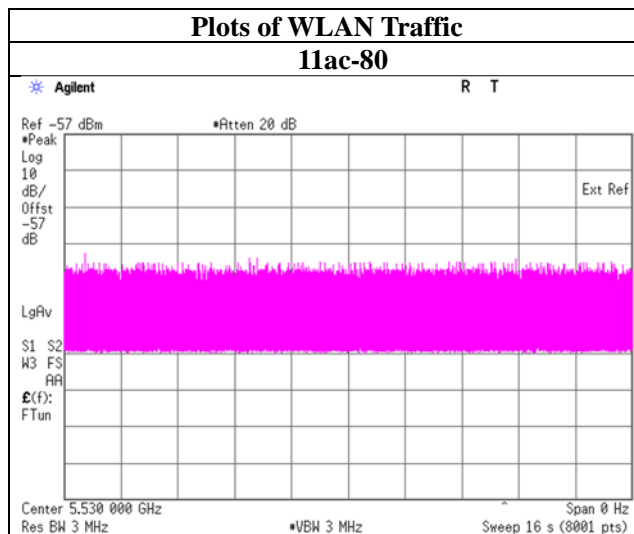
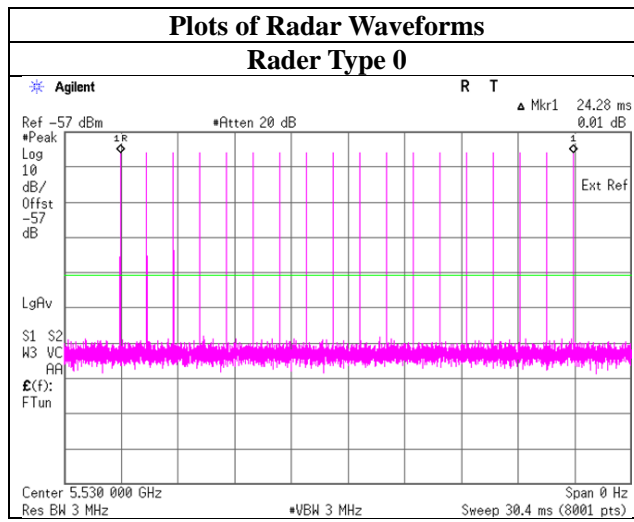
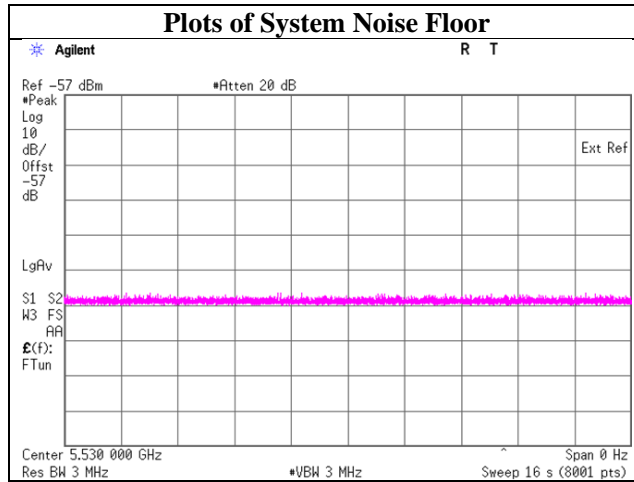

SECTION 6: Channel Move Time, Channel Closing Transmission Time

6.1 Operating environment

Test place Ise EMC Lab.No.10 Shielded Room
Date 02/22/2021
Temperature/ Humidity 25deg. C / 31% RH
Engineer Takafumi Noguchi
Mode 11ac-80

6.2 Test Procedure

Transmit the data from the Master Device to the Client Device on the test Channel for the entire period of the test. The Radar Waveform generator sends a Burst of pulses for one of the Radar Types 0 at levels defined on the Operating Channel. An additional 1 dB is added to the radar test signal to ensure it is at or above the DFS Detection Threshold, accounting for equipment variations/errors. Observe the transmissions of the EUT at the end of the radar Burst on the Operating Channel for duration greater than 10 seconds.

6.3 Test data

<Client Device>

11ac-80

Test Item	Unit	Measurement Time	Limit	Results
Channel Move Time *1)	[sec]	0.094	10.000	Pass
Channel Closing Transmission Time *2)	[msec]	0	60	Pass

*1) Channel Move Time is calculated as follows:

$$(\text{Channel Move Time}) = (\text{End of Transmission}) - (\text{End of Burst}) = 1.114 - 1.020$$

*2) Channel Closing Transmission Time is calculated from (End of Burst + 200msec) to (End of Burst + 10sec)

$$(\text{Channel Closing Transmission Time}) = (\text{Number of analyzer bins showing transmission}) \times (\text{dwell time per bin}) \\ = 0 \times 2 [\text{msec}]$$

<Client mode>

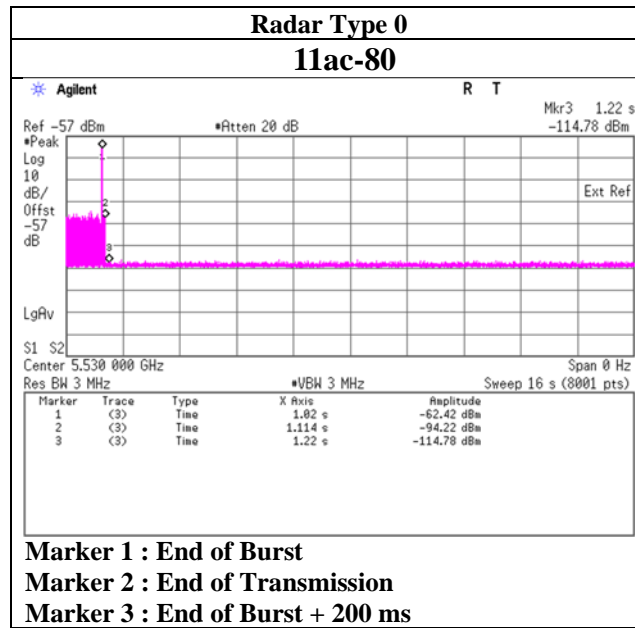

6.4 Test result

Test result: Pass

SECTION 7: Non-Occupancy Period

7.1 Operating environment

Test place	Ise EMC Lab.No.10 Shielded Room
Date	02/22/2021
Temperature/ Humidity	25deg. C / 31% RH
Engineer	Takafumi Noguchi
Mode	11ac-80

7.2 Test Procedure

The following two tests are performed:

1). Transmit the data from the Master Device to the Client Device on the test Channel for the entire period of the test. The Radar Waveform generator sends a Burst of pulses for one of the Radar Types 0-4(Master Device) or the Radar Types 0(Client Device) at levels defined on the Operating Channel. An additional 1 dB is added to the radar test signal to ensure it is at or above the DFS Detection Threshold, accounting for equipment variations/errors. Observe the transmissions of the EUT after the Channel Move Time on the Operating Channel for duration greater than 30 minutes.

7.3 Test data

<Client mode>

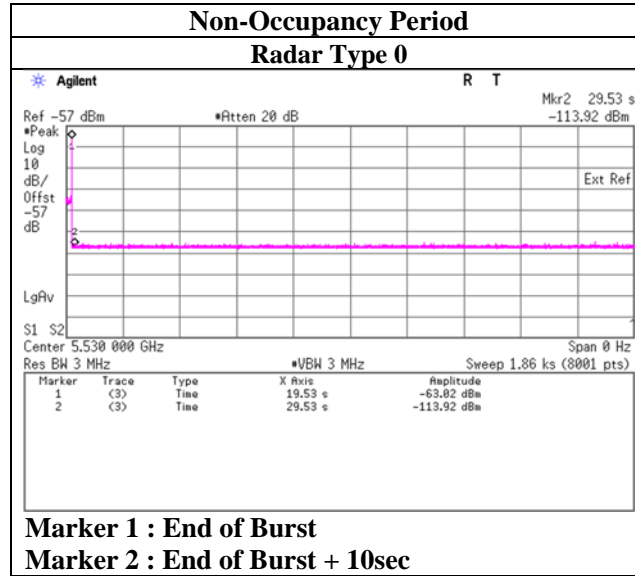

7.4 Test result

Test result: Pass

APPENDIX 1: Test instruments

Test equipment

Test Item	Local ID	LIMS ID	Description	Manufacturer	Model	Serial	Last Calibration Date	Cal Int
DFS	MSG-17 *1)	141897	Signal Genelator	KEYSIGHT	N5182B	MY56200024	11/13/2020	12
DFS	MRENT-130	141855	Spectrum Analyzer	AGILENT	E4440A	MY46187750	11/18/2020	12
DFS	MCC-150	142344	Microwave Cable	Junkosha	MWX221-01000AMSAMS	1304S247	-	-
DFS	MCC-151	142345	Microwave Cable	Junkosha	MWX221-01000AMSAMS	1304S248	-	-
DFS	MCC-152	142346	Microwave Cable	Junkosha	MWX221-01000AMSAMS	1304S249	-	-
DFS	MCC-189	142376	Microwave Cable	Junkosha	MWX-221-02000DMSDMS	1507S108	-	-
DFS	MPSC-06	142735	Power Splitters/Combiners	PASTERNAK ENTERPRISES	ZFRSC-123-S+	ZFRSC-123-00231	-	-
DFS	MPSC-04	141821	Power Splitters/Combiners	Mini-Circuit	ZFSC-2-10G	326	09/23/2020	12
DFS	MPD-03	141591	Power Divider DC-12.4GHz	Suhner	4901.19.A	-	05/25/2020	-
DFS	MCC-179	142364	Microwave Cable	Junkosha	MMX221-00500DMSDMS	1502S306	-	-
DFS	MAT-101	194879	Attenuator	Keysight Technologies Inc	8495A / 8495B	MY42150956 / MY42147424	-	-
DFS	MAT-57	141333	Attenuator(10dB)	Suhner	6810.19.A	-	12/07/2020	12
DFS	MOS-30	141569	Thermo-Hygrometer	CUSTOM	CTH-201	3001	07/10/2020	12
DFS	COTS-MDFS-03	170949	Signal Studio for DFS Radar Profiles	EMC Instruments Corporation	N7607B	-	-	-

***Hyphens for Last Calibration Date, Calibration Due Date and Cal Int (month) are instruments that Calibration is not required (e.g. software), or instruments checked in advance before use.**

***1) Signal generator is only used to generate radar test signal, and the wave form is confirmed with spectrum analyzer every time before the test.**

The expiration date of the calibration is the end of the expired month.

All equipment is calibrated with valid calibrations. Each measurement data is traceable to the national or international standards.

As for some calibrations performed after the tested dates, those test equipment have been controlled by means of an unbroken chains of calibrations.

Test item:

DFS: Dynamic Frequency Selection

UL Japan, Inc.

Ise EMC Lab.

4383-326 Asama-cho, Ise-shi, Mie-ken 516-0021 JAPAN

Telephone : +81 596 24 8999

Facsimile : +81 596 24 8124