



RADIO TEST REPORT

Test Report No. : 12079941H-D

Applicant : Sony Interactive Entertainment Inc.
Type of Equipment : Wireless communication module
Model No. : AW-CB319
FCC ID : AK8M18DAQ1
Test regulation : FCC Part 15 Subpart E: 2018
(DFS test only)
*Client without radar detection
Test Result : Complied

1. This test report shall not be reproduced in full or partial, without the written approval of UL Japan, Inc.
2. The results in this report apply only to the sample tested.
3. This sample tested is in compliance with the above regulation.
4. The test results in this report are traceable to the national or international standards.
5. This test report must not be used by the customer to claim product certification, approval, or endorsement by NVLAP, NIST, or any agency of the Federal Government.
6. This test report covers Radio technical requirements. It does not cover administrative issues such as Manual or non-Radio test related Requirements. (if applicable)

Date of test: February 16, 2018

Representative test engineer:

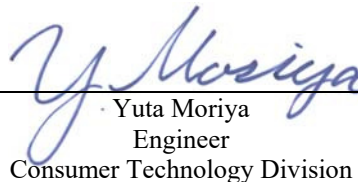
Yuta Moriya
Engineer
Consumer Technology Division

Approved by:

Takayuki Shimada
Leader
Consumer Technology Division



NVLAP LAB CODE: 200572-0

This laboratory is accredited by the NVLAP LAB CODE 200572-0, U.S.A. The tests reported herein have been performed in accordance with its terms of accreditation.
*As for the range of Accreditation in NVLAP, you may refer to the WEB address,
http://japan.ul.com/resources/emc_accredited/

UL Japan, Inc.

Ise EMC Lab.

4383-326 Asama-cho, Ise-shi, Mie-ken 516-0021 JAPAN

Telephone : +81 596 24 8999

Facsimile : +81 596 24 8124

13-EM-F0429

CONTENTS	PAGE
SECTION 1: Customer information.....	4
SECTION 2: Equipment under test (E.U.T.).....	4
SECTION 3: Scope of Report.....	6
SECTION 4: Test specification, procedures & results.....	6
SECTION 5: Operation of E.U.T. during testing.....	11
SECTION 6: Channel Move Time, Channel Closing Transmission Time.....	17
SECTION 7: Non-Occupancy Period.....	19
APPENDIX 1: Test instruments	21
APPENDIX 2: Photographs of test setup	22
Test Configuration and peripherals	23

UL Japan, Inc.

Ise EMC Lab.

4383-326 Asama-cho, Ise-shi, Mie-ken 516-0021 JAPAN

Telephone : +81 596 24 8999

Facsimile : +81 596 24 8124

SECTION 1: Customer information

Company Name	Sony Interactive Entertainment Inc.
Brand Name	SONY
Address	1-7-1 Konan, Minato-ku, Tokyo, 108-0075 Japan
Telephone Number	+81-50-3807-5639
Facsimile Number	+81-50-3807-9594
Contact Person	Kiyoto Sasaki

SECTION 2: Equipment under test (E.U.T.)

2.1 Identification of E.U.T.

Type of Equipment	Wireless communication module
Model No	AW-CB319
Serial No	Refer to Clause 4.2
Country of Manufacture	China/Japan
Receipt Date of Sample	January 20, 2018
Condition of EUT	Production prototype (Not for Sale: This sample is equivalent to mass-produced items.)
Modification of EUT	No modification by the test lab.

2.2 Product Description

AW-CB319 is the Wireless communication module.

Product Specification

Clock frequency in the system (radio part)	26 MHz
Operating Temperature	-10 deg. C - +85 deg. C
Power Supply	DC 3.3 V, DC 1.8 V
Size	20 x 18 x 3.0 mm, 55pin LGA

UL Japan, Inc.

Ise EMC Lab.

4383-326 Asama-cho, Ise-shi, Mie-ken 516-0021 JAPAN

Telephone : +81 596 24 8999

Facsimile : +81 596 24 8124

Radio Specification

WLAN (IEEE802.11b/g/n-20)

Equipment Type	Transceiver
Frequency of Operation	2412 MHz - 2462 MHz
Type of Modulation	DSSS, OFDM
Bandwidth & Channel spacing	Less than 20 MHz & 5 MHz
Method of frequency generation	Synthesizer
Antenna Type	IFA (Antenna port WA for 2.4 GHz / Antenna port WB for 2.4 GHz)
Antenna Gain: G _{ANT}	4.0 dBi (Antenna port WA for 2.4 GHz), 4.2 dBi (Antenna port WB for 2.4 GHz)
Directional Gain *1)	7.11 dBi

WLAN (IEEE802.11a/11n-20/11ac-20/11n-40/11ac-40/11ac-80)

Equipment Type	Transceiver
Frequency of Operation	U-NII-1: 5180 MHz - 5240 MHz U-NII-2A: 5260 MHz - 5320 MHz U-NII-2C: 5500 MHz - 5700 MHz U-NII-3: 5745 MHz - 5825 MHz
Type of Modulation	OFDM
Bandwidth & Channel spacing	Less than 20 MHz / 40 MHz / 80 MHz & 20 MHz / 40 MHz / 80 MHz
Method of frequency generation	Synthesizer
Antenna Type	IFA (Antenna port WA for 5 GHz), PIFA (Antenna port WC for 5 GHz)
Antenna Gain: G _{ANT}	5.0 dBi (Antenna port WA for 5 GHz), 3.5 dBi (Antenna port WC for 5 GHz)
Directional Gain *1)	7.29 dBi

Bluetooth (BDR/EDR)

Equipment Type	Transceiver
Frequency of Operation	2402 MHz - 2480 MHz
Type of Modulation	FHSS (GFSK, $\pi/4$ DQPSK, 8DPSK)
Bandwidth & Channel spacing	79 MHz & 1 MHz
Method of frequency generation	Synthesizer
Antenna Type	PIFA (Antenna port WC for 2.4 GHz)
Antenna Gain	6.4 dBi (Antenna port WC for 2.4 GHz)

Bluetooth (Low Energy)

Equipment Type	Transceiver
Frequency of Operation	2402 MHz - 2480 MHz
Type of Modulation	GFSK
Bandwidth & Channel spacing	1 MHz & 2 MHz
Method of frequency generation	Synthesizer
Antenna Type	PIFA (Antenna port WC for 2.4 GHz)
Antenna Gain	6.4 dBi (Antenna port WC for 2.4 GHz)

*1) Directional antenna gain = $10 \log \left(\frac{G_{ANT1}}{10^{20}} + \frac{G_{ANT2}}{10^{20}} \right)^2 / 2$

* This test report applies to WLAN (DFS band) part.

UL Japan, Inc.

Ise EMC Lab.

4383-326 Asama-cho, Ise-shi, Mie-ken 516-0021 JAPAN

Telephone : +81 596 24 8999

Facsimile : +81 596 24 8124

SECTION 3: Scope of Report

This report only covers DFS requirement, as specified by the following referenced procedures.

SECTION 4: Test specification, procedures & results

4.1 Test Specification

- Test Specification : FCC Part 15 Subpart E
FCC Part 15 final revised on February 2, 2018 and effective March 5, 2018
* The revision on February 2, 2018, does not affect the test specification applied to the EUT.
- Title : FCC 47CFR Part15 Radio Frequency Device Subpart E
Unlicensed National Information Infrastructure Devices
Section 15.407 General technical requirements
- Test Specification : KDB905462 D02 UNII DFS Compliance Procedures New Rules v02
- Title : COMPLIANCE MEASUREMENT PROCEDURES FOR UNLICENSED-
NATIONAL INFORMATION INFRASTRUCTURE DEVICES OPERATING
IN THE 5250-5350MHz AND 5470-5725MHz BANDS INCORPORATING
DYNAMIC FREQUENCY SELECTION
- Test Specification : KDB905462 D03 Client Without DFS New Rules v01r02
- Title : U-NII CLIENT DEVICES WITHOUT RADAR DETECTION CAPABILITY

FCC Part 15.31 (e)

The EUT has the power supply regulator. However one of the input voltages to RF part doesn't go through the regulator. The stable voltage will be supplied by the end product, which will be required to have a power supply regulator. Therefore, the EUT complies with the requirement.

FCC Part 15.203/212 Antenna requirement

The EUT has unique coupling/antenna connectors (U.FL) for antenna ports WC and also has a pattern antenna (Antenna port WA and WB) that is not removable from the EUT.
Therefore the equipment complies with the requirement of 15.203/212.

4.2 Procedures and results

Table 1: Applicability of DFS Requirements

Requirement	Operating Mode	Test Procedures & Limits	Deviation	Results
	Client without Radar Detection			
U-NII Detection Bandwidth	Not required	KDB905462 D02 UNII DFS Compliance Procedures New Rules v02	N/A	N/A
Initial Channel Availability Check Time	Not required	FCC15.407 (h)	N/A	N/A
		KDB905462 D02 UNII DFS Compliance Procedures New Rules v02		
		RSS-247 6.3		
Radar Burst at the Beginning of the Channel Availability Check Time	Not required	FCC15.407 (h)	N/A	N/A
		KDB905462 D02 UNII DFS Compliance Procedures New Rules v02		
		RSS-247 6.3		
Radar Burst at the End of the Channel Availability Check Time	Not required	FCC15.407 (h)	N/A	N/A
		KDB905462 D02 UNII DFS Compliance Procedures New Rules v02		
		RSS-247 6.3		
In-Service Monitoring for Channel Move Time, Channel Closing Transmission Time	Yes	FCC15.407 (h)	N/A	Complied
		KDB905462 D02 UNII DFS Compliance Procedures New Rules v02		
		RSS-247 6.3		
In-Service Monitoring for Non-Occupancy period	Yes *	FCC15.407 (h)	N/A	Complied
		KDB905462 D02 UNII DFS Compliance Procedures New Rules v02		
		RSS-247 6.3		
Statistical Performance Check	Not required	FCC15.407 (h)	N/A	N/A
		KDB905462 D02 UNII DFS Compliance Procedures New Rules v02		

Note: UL Japan, Inc.'s EMI Work Procedures No. 13-EM-W0422.

*Although this test was not required in FCC, KDB 905462 D02, it was performed as additional test.

Table 2 DFS Detection Thresholds for Master Devices and Client Devices With Radar Detection

Maximum Transmit Power	Value (See Notes 1,2, and 3)
≥ 200 milliwatt	-64 dBm
< 200 milliwatt and power spectral density < 10dBm/MHz	-62 dBm
< 200 milliwatt that do not meet the power spectral density requirement	-64 dBm
<p>Note 1: This is the level at the input of the receiver assuming a 0 dBi receive antenna.</p> <p>Note 2: Throughout these test procedures an additional 1 dB has been added to the amplitude of the test transmission waveforms to account for variations in measurement equipment. This will ensure that the test signal is at or above the detection threshold level to trigger a DFS response.</p> <p>Note 3: EIRP is based on the highest antenna gain. For MIMO devices refer to KDB Publication 662911 D01.</p>	

Table 3 DFS Response Requirement Values

Parameter	Value
Non-occupancy period	Minimum 30 minutes
Channel Availability Check Time	60 seconds
Channel Move Time	10 seconds See Note 1
Channel Closing Transmission Time	200 milliseconds + an aggregate of 60 milliseconds over remaining 10 second period. See Notes 1 and 2
U-NII Detection Bandwidth	Minimum 100 % of the U-NII 99 % transmission power bandwidth See Note 3
<p>Note 1: Channel Move Time and the Channel Closing Transmission Time should be performed with Radar Type 0. The measurement timing begins at the end of the Radar Type 0 burst.</p> <p>Note 2: The Channel Closing Transmission Time is comprised of 200 milliseconds starting at the beginning of the Channel Move Time plus any additional intermittent control signals required to facilitate a Channel move (an aggregate of 60 milliseconds) during the remainder of the 10 second period. The aggregate duration of control signal will not count quiet periods in between transmissions.</p> <p>Note 3: During the U-NII Detection Bandwidth detection test, radar type 0 should be used. For each frequency step the minimum percentage of detection is 90 percent. Measurements are performed with no data traffic.</p>	

Table 4 Short Pulse Radar Test Waveform

Radar Type	Pulse Width (μsec)	PRI (μsec)	Number of Pulses	Minimum Percentage of Successful Detection	Minimum Number of Trials
0	1	1428	18	See Note 1	See Note 1
1	1	Test A: 15 unique PRI values randomly selected from the list of 23 PRI values in Table 5a	Roundup{(1/360)* (19*10 ⁶ /PRI μsec)}	60 %	30
		Test B: 15 unique PRI values randomly selected within the range of 518-3066 μsec, with a minimum increment of 1 μsec, excluding PRI values selected in Test A			
2	1-5	150-230	23-29	60 %	30
3	6-10	200-500	16-18	60 %	30
4	11-20	200-500	12-16	60 %	30
Aggregate (Rader Types 1-4)				80 %	120
Note 1: Short Pulse Radar Type 0 should be used for the detection bandwidth test, channel move time, and channel closing time tests.					

Table 5 Long Pulse Radar Test Waveform

Radar Type	Pulse Width (μsec)	Chip Width (MHz)	PRI (μsec)	Number of Pulses per Burst	Number of Burst	Minimum Percentage of Successful Detection	Minimum Number of Trials
5	50-100	5 - 20	1000-2000	1-3	8-20	80 %	30

Table 6 Frequency Hopping Radar Test Waveform

Radar Type	Pulse Width (μsec)	PRI (μsec)	Pulse per Hop (kHz)	Hopping Rate (kHz)	Hopping Sequence Length (msec)	Minimum Percentage of Successful Detection	Minimum Number of Trials
6	1	333	9	0.333	300	70 %	30

4.3 Addition to standard

No addition, exclusion nor deviation has been made from the standard.

UL Japan, Inc.

Ise EMC Lab.

4383-326 Asama-cho, Ise-shi, Mie-ken 516-0021 JAPAN
Telephone : +81 596 24 8999
Facsimile : +81 596 24 8124

4.4 Test Location

UL Japan, Inc. Ise EMC Lab.
4383-326 Asama-cho, Ise-shi, Mie-ken 516-0021 JAPAN
Telephone: +81 596 24 8999, Facsimile: +81 596 24 8124
NVLAP Lab. code: 200572-0 / FCC Test Firm Registration Number: 199967

Test site	IC Registration Number	Width x Depth x Height (m)	Size of reference ground plane (m) / horizontal conducting plane	Other rooms	Maximum measurement distance
No.1 semi-anechoic chamber	2973C-1	19.2 x 11.2 x 7.7	7.0 x 6.0	No.1 Power source room	10 m
No.2 semi-anechoic chamber	2973C-2	7.5 x 5.8 x 5.2	4.0 x 4.0	-	3 m
No.3 semi-anechoic chamber	2973C-3	12.0 x 8.5 x 5.9	6.8 x 5.75	No.3 Preparation room	3 m
No.3 shielded room	-	4.0 x 6.0 x 2.7	N/A	-	-
No.4 semi-anechoic chamber	2973C-4	12.0 x 8.5 x 5.9	6.8 x 5.75	No.4 Preparation room	3 m
No.4 shielded room	-	4.0 x 6.0 x 2.7	N/A	-	-
No.5 semi-anechoic chamber	-	6.0 x 6.0 x 3.9	6.0 x 6.0	-	-
No.6 shielded room	-	4.0 x 4.5 x 2.7	4.0 x 4.5	-	-
No.6 measurement room	-	4.75 x 5.4 x 3.0	4.75 x 4.15	-	-
No.7 shielded room	-	4.7 x 7.5 x 2.7	4.7 x 7.5	-	-
No.8 measurement room	-	3.1 x 5.0 x 2.7	N/A	-	-
No.9 measurement room	-	8.8 x 4.6 x 2.8	2.4 x 2.4	-	-
No.11 measurement room	-	6.2 x 4.7 x 3.0	4.8 x 4.6	-	-

* Size of vertical conducting plane (for Conducted Emission test) : 2.0 m x 2.0m for No.1, No.2, No.3, and No.4 semi-anechoic chambers and No.3 and No.4 shielded rooms.

4.5 Uncertainty

The following uncertainties have been calculated to provide a confidence level of 95% using a coverage factor k=2. Time Measurement uncertainty for this test was: (±) 0.012%

4.6 Test instruments of DFS and Test set up

Refer to APPENDIX.

SECTION 5: Operation of E.U.T. during testing

5.1 Operating Modes

The EUT, which is a Client Device without Radar detection capability, operates over the U-NII-2A and U-NII-2C Band.

The channel-loading of approximately 17% or greater was used for testing, and its test data was transferred from the Master Device to the Client Device for all test configurations.

The EUT utilizes the 802.11a/n/ac architecture, with a 20 MHz, 40 MHz and 80 MHz channel bandwidth.

The FCC ID for the Master Device used with EUT for DFS testing is LDK102087.

The rated output power of the Master unit is >200 mW(23 dBm). Therefore the required interference threshold level is -64 dBm. After correction for antenna gain and procedural adjustments, the required conducted threshold at the antenna port is $-64 + 1 + 0 = -63.0$ dBm (threshold level + additional 1 dB + antenna gain).

It is impossible for users to change DFS control, because the DFS function is written on the firmware and users cannot access it.

The EUT was set by the software as follows:

Software name: iPerf

Version: 2.0.5

5.2 Configuration and peripherals

This page has been submitted for a separate exhibit.

UL Japan, Inc.

Ise EMC Lab.

4383-326 Asama-cho, Ise-shi, Mie-ken 516-0021 JAPAN

Telephone : +81 596 24 8999

Facsimile : +81 596 24 8124

5.3 Test and Measurement System

SYSTEM OVERVIEW

The measurement system is based on a conducted test method.

The software selects waveform parameters from within the bounds of the signal type on a random basis using uniform distribution. The short pulse types 1, 2, 3, and 4, the long pulse type 5, and the frequency hopping type 6 parameters are randomized at run-time.

The signal monitoring equipment consists of a spectrum analyzer with the capacity to display 8001 bins on the horizontal axis. A time-domain resolution of 2 msec/bin is achievable with a 16 second sweep time, meeting the 10 seconds short pulse reporting criteria. The aggregate ON time is calculated by multiplying the number of bins above a threshold during a particular observation period by the dwell time per bin, with the analyzer set to peak detection.

FREQUENCY HOPPING RADAR WAVEFORM GENERATING SUBSYSTEM

The first 100 frequencies are selected out of the hopping sequence of the randomized 475 hop frequencies. Only a *Burst* that has the frequency falling within the receiver bandwidth of the tested U-NII device is selected among those frequencies. (Frequency-domain simulation). The radar waveform generated at the start time of the selected *Burst* (Time-domain simulation) is download to the Signal Generator. If all of the randomly selected 100 frequencies do not fall within the receiver bandwidth of the U-NII device, the radar waveform is not used for the test.

CONDUCTED METHODS SYSTEM BLOCK DIAGRM

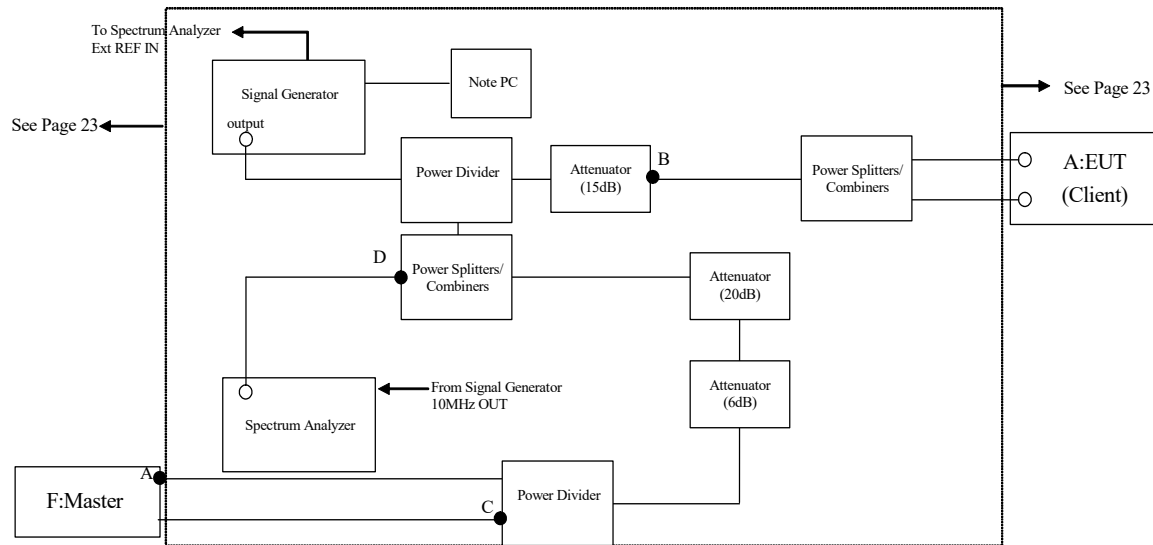

MEASUREMENT SYSTEM FREQUENCY REFERENCE

Lock the signal generator and the spectrum analyzer to the same reference sources as follows: Connect the 10 MHz OUT on the signal generator to the EXT REF IN on the spectrum analyzer and set the spectrum analyzer Ext to On.

SYSTEM CALIBRATION

Step 1: Set the system as shown in Figure 3 of KDB905462 D02 7.2.2.

Step 2: Adjust each attenuator to fulfill the following three conditions:

- WLAN can be communicated, and
- Rader detection threshold level is bigger than Client Device traffic level on the spectrum analyzer, and
- Master Device traffic level is not displayed on the spectrum analyzer.

Step 3: Terminate 50 ohm at B , C and D points, and connect the spectrum analyzer to the point A. (See the figure on page 14)

At the point A, adjust the signal generator and spectrum analyzer to the center frequency of the channel to be measured.

Download the applicable radar waveforms to the signal generator. Select the radar waveform, trigger a burst manually and measure the amplitude on the spectrum analyzer. Readjust the amplitude of the signal generator as required so that the peak level of the waveform is at a displayed level equal to the required or desired interference detection threshold.

Separate signal generator amplitude settings are determined as required for each radar type.

Step 4: Without changing any of the instrument settings, restore the system setting to Step 2 and adjust the Reference Level Offset of the spectrum analyzer to the level at Step 3.

By taking the above steps 1 to 4, the spectrum analyzer displays the level of the signal generator as received at the antenna ports of the Master Device.

See Clause 5.4 for Plots of Noise, Rader Waveforms, and WLAN signals.

5.4 Plots of Noise, Rader Waveforms, and WLAN signals

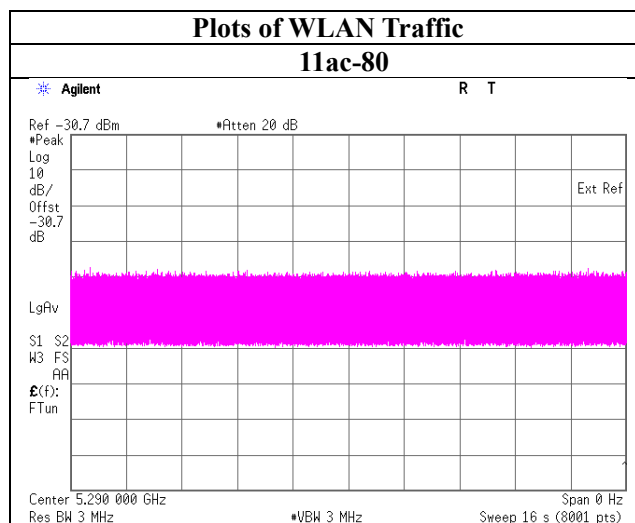
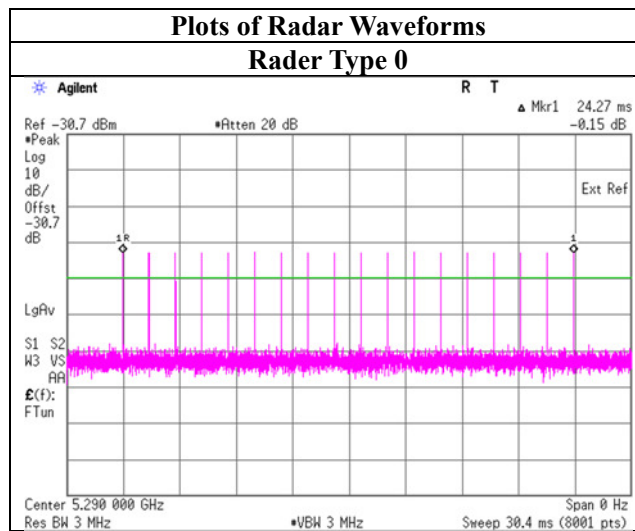
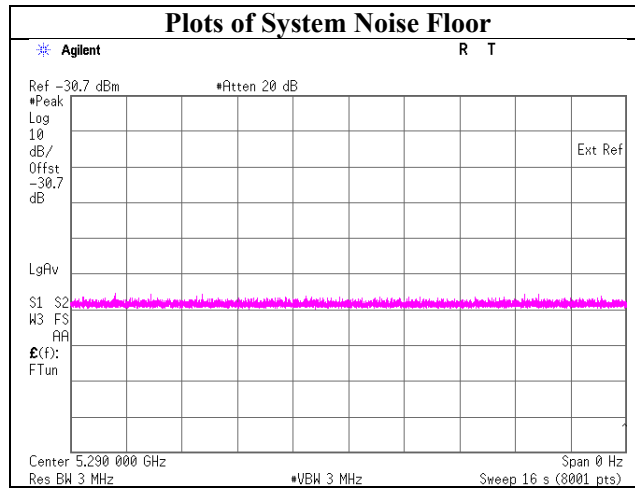

SECTION 6: Channel Move Time, Channel Closing Transmission Time

6.1 Operating environment

Test place Ise EMC Lab.No.6 Measurement Room
Date 02/16/2018
Temperature/ Humidity 24deg. C / 28% RH
Engineer Yuta Moriya
Mode 11ac-80

6.2 Test Procedure

Transmit the data from the Master Device to the Client Device on the test Channel for the entire period of the test. The Radar Waveform generator sends a Burst of pulses for one of the Short Pulse Radar Types 0 at levels defined , on the Operating Channel. An additional 1 dB is added to the radar test signal to ensure it is at or above the DFS Detection Threshold, accounting for equipment variations/errors.

Observe the transmissions of the EUT at the end of the radar Burst on the Operating Channel for duration greater than 10 seconds.

6.3 Test data

11ac-80

Test Item	Unit	Measurement Time	Limit	Results
Channel Move Time *1)	[sec]	0.070	10.000	Pass
Channel Closing Transmission Time *2)	[msec]	0	60	Pass

*1) Channel Move Time is calculated as follows:

$$(\text{Channel Move Time}) = (\text{End of Transmission}) - (\text{End of Burst}) = 1.962 - 1.892$$

*2) Channel Closing Transmission Time is calculated from (End of Burst + 200msec) to (End of Burst + 10sec)

$$(\text{Channel Closing Transmission Time}) = (\text{Number of analyzer bins showing transmission}) \times (\text{dwell time per bin}) \\ = 0 \times 2 [\text{msec}]$$

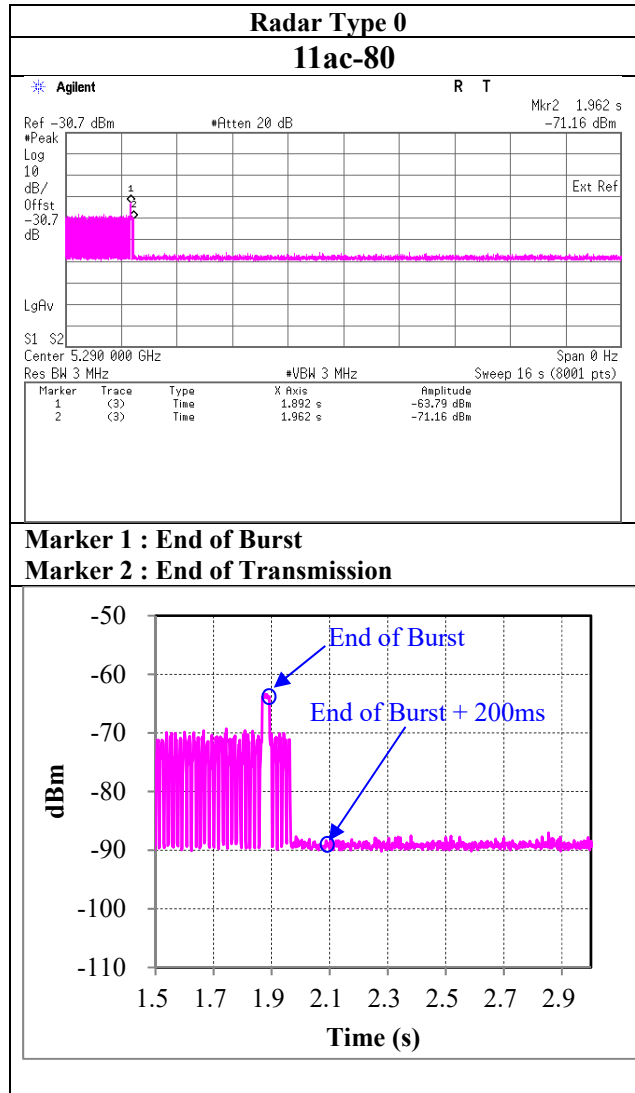

6.4 Test result

Test result: Pass

SECTION 7: Non-Occupancy Period

7.1 Operating environment

Test place	Ise EMC Lab.No.6 Measurement Room
Date	02/16/2018
Temperature/ Humidity	24deg. C / 28% RH
Engineer	Yuta Moriya
Mode	11ac-80

7.2 Test Procedure

The following two tests are performed:

- 1). Transmit the data from the Master Device to the Client Device on the test Channel for the entire period of the test. The Radar Waveform generator sends a Burst of pulses for one of the Radar Types 0 at levels defined on the Operating Channel. An additional 1 dB is added to the radar test signal to ensure it is at or above the DFS Detection Threshold, accounting for equipment variations/errors. Observe the transmissions of the EUT after the Channel Move Time on the Operating Channel for duration greater than 30 minutes.
- 2). Transmit the data from the Master Device to the Client Device on the test Channel for the entire period of the test. Observe the transmissions of the EUT on the Operating Channel for duration greater than 30 minutes after the Master Device is shut off.

7.3 Test data

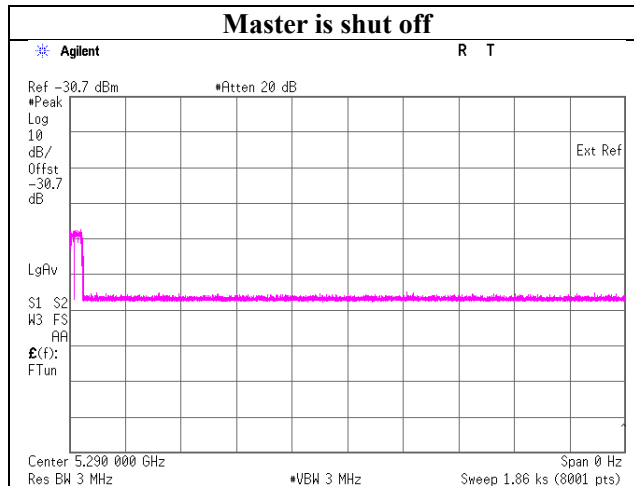
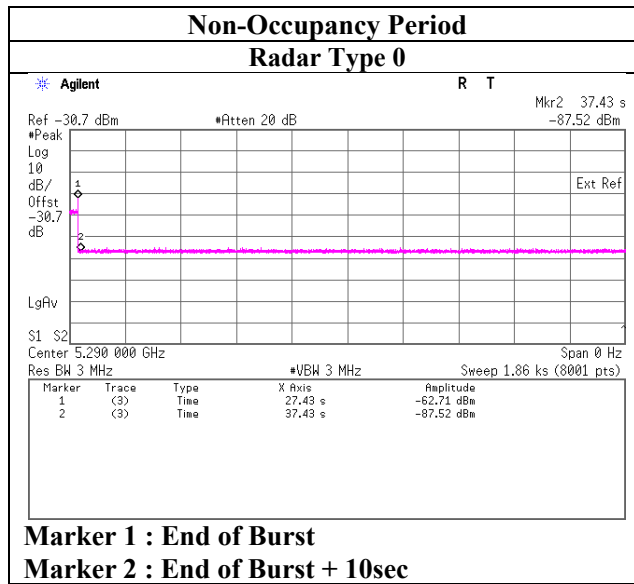

7.4 Test result

Test result: Pass

APPENDIX 1: Test instruments

EMI Test Instruments

Control No.	Instrument	Manufacturer	Model No	Serial No	Test Item	Calibration Date * Interval(month)
MCC-181	Microwave Cable	Junkosha	MMX221-00500DMSDMS	1502S308	DFS	Pre Check
MCC-190	Microwave Cable	Junkosha	MWX-221-02000DMSDMS	1507S109	DFS	Pre Check
MCC-179	Microwave Cable	Junkosha	MMX221-00500DMSDMS	1502S306	DFS	Pre Check
MCC-180	Microwave Cable	Junkosha	MMX221-00500DMSDMS	1502S307	DFS	Pre Check
MCC-189	Microwave Cable	Junkosha	MWX-221-02000DMSDMS	1507S108	DFS	Pre Check
MPSC-06	Power Splitters/Combiners	Pasternack Enterprises	ZFRSC-123-S+	ZFRSC-123-00231	DFS	Pre Check
MPSC-07	Power Splitters/Combiners	Pasternack Enterprises	ZFRSC-123-S+	ZFRSC-123-00232	DFS	Pre Check
MPD-01	Power Divider DC to 26.5GHz	Agilent	11636B	52258	DFS	2017/03/13 * 12
MPD-03	Power Divider DC-12.4GHz	SUHNER	4901.19.A	-	DFS	2017/05/30 * 12
MAT-101	Attenuator	KEYSIGHT	8494A, 8495B	MY42150956, MY42147424	DFS	Pre Check
MAT-19	Attenuator(6dB) (above1GHz)	HIROSE ELECTRIC CO.,LTD.	AT-106	-	DFS	2017/12/01 * 12
MAT-59	Attenuator(20dB)	Suhner	6820.19.A	-	DFS	Pre Check
MOS-14	Thermo-Hygrometer	Custom	CTH-201	1401	DFS	2018/01/24 * 12
MSA-16	Spectrum Analyzer	Agilent	E4440A	MY46186390	DFS	2017/09/20 * 12
MSG-17	Signal Generator	KEYSIGHT	N5182B	MY56200024	DFS	2017/11/30 * 12
COTS-MDFS-03	Signal Studio for DFS Radar Profiles	KEYSIGHT	N7607B	-	DFS	-

The expiration date of the calibration is the end of the expired month.

All equipment is calibrated with valid calibrations. Each measurement data is traceable to the national or international standards.

As for some calibrations performed after the tested dates, those test equipment have been controlled by means of an unbroken chains of calibrations.

Test item:

DFS: Dynamic Frequency Selection

UL Japan, Inc.

Ise EMC Lab.

4383-326 Asama-cho, Ise-shi, Mie-ken 516-0021 JAPAN

Telephone : +81 596 24 8999

Facsimile : +81 596 24 8124