

APPENDIX 3: Photographs of test setup

Conducted Emission

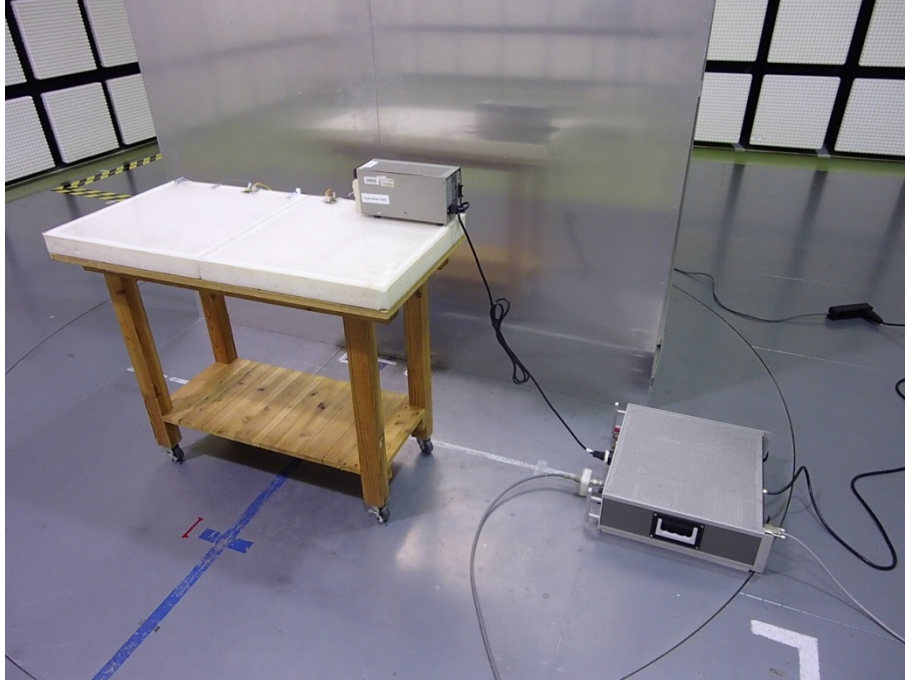

Photo 1

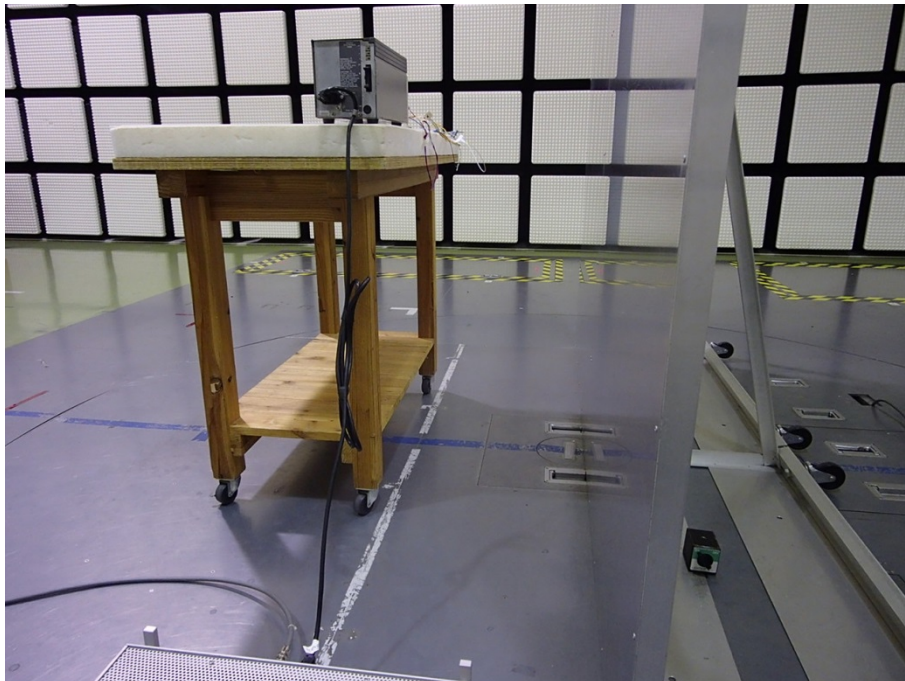

Photo 2

UL Japan, Inc.

Ise EMC Lab.

4383-326 Asama-cho, Ise-shi, Mie-ken 516-0021 JAPAN

Telephone : +81 596 24 8999

Facsimile : +81 596 24 8124

Radiated Spurious Emission

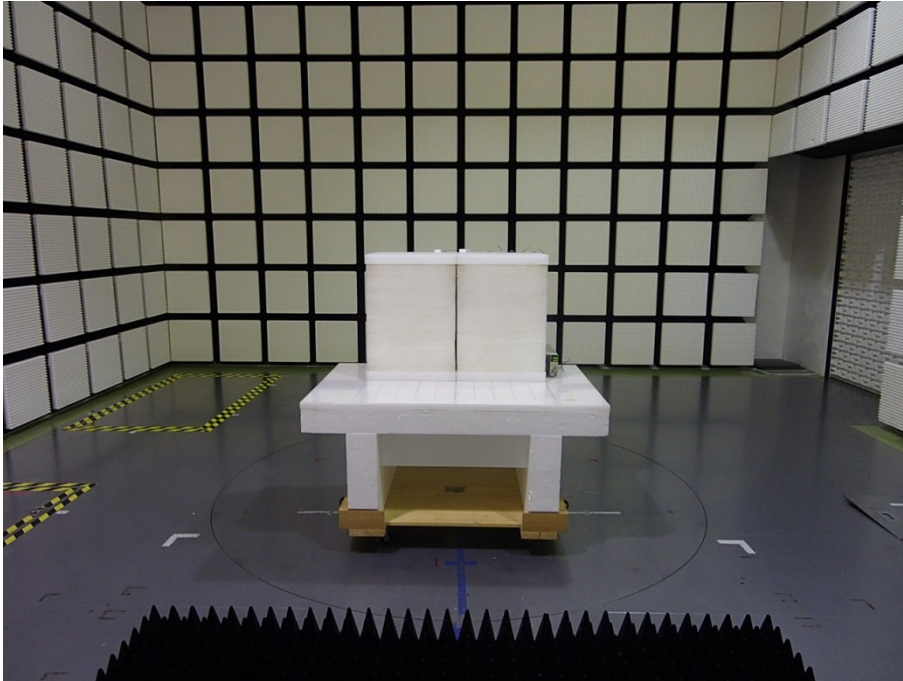

Photo 1

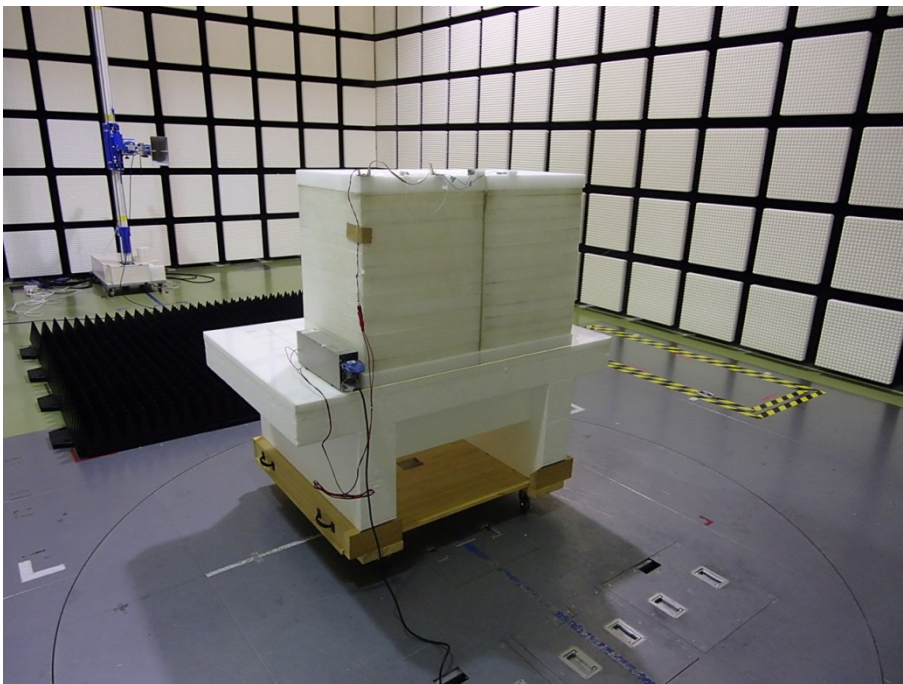

Photo 2

UL Japan, Inc.

Ise EMC Lab.

4383-326 Asama-cho, Ise-shi, Mie-ken 516-0021 JAPAN

Telephone : +81 596 24 8999

Facsimile : +81 596 24 8124

Worst Case Position (Horizontal: X-axis/ Vertical:Y-axis)
(Antenna)

X-axis

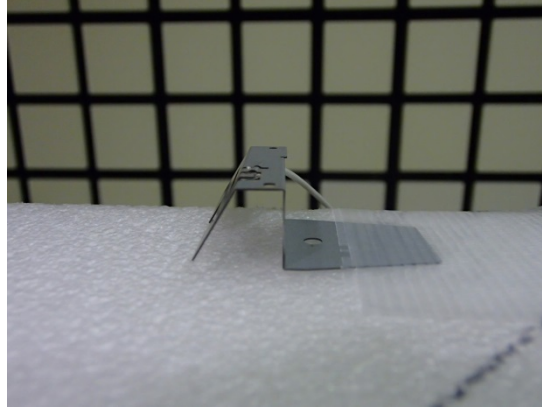

Y-axis

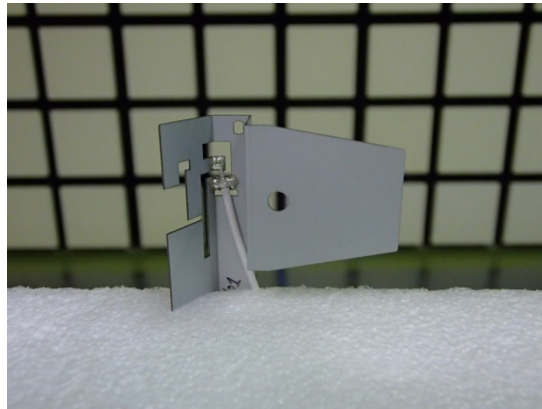

Z-axis

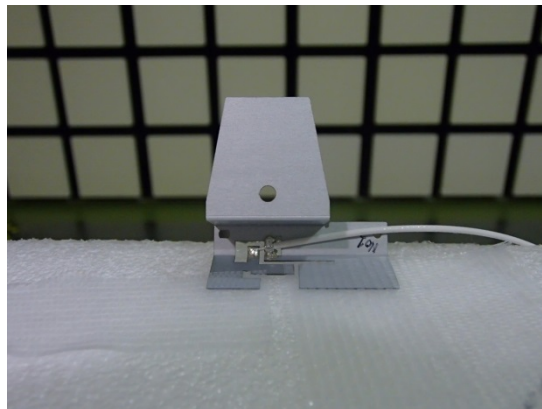

Worst Case Position (Horizontal: X-axis/ Vertical:X-axis)
(Module)

X-axis

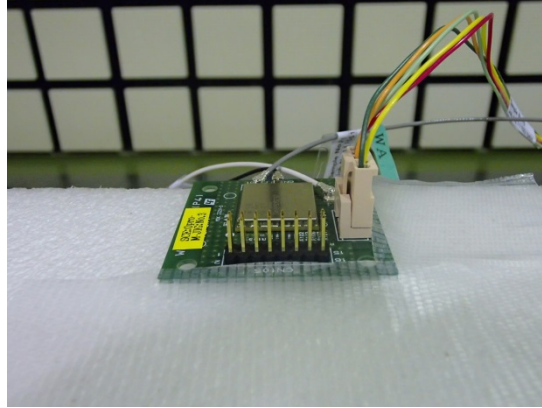

Y-axis

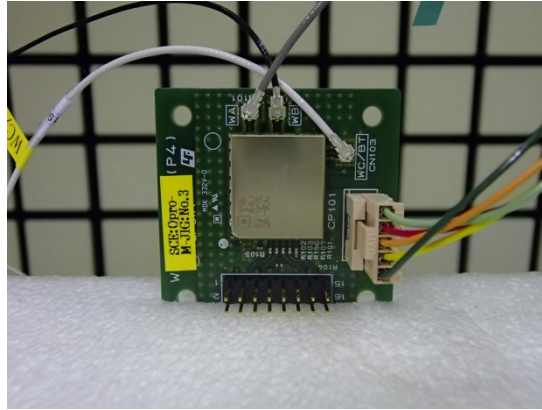

Z-axis

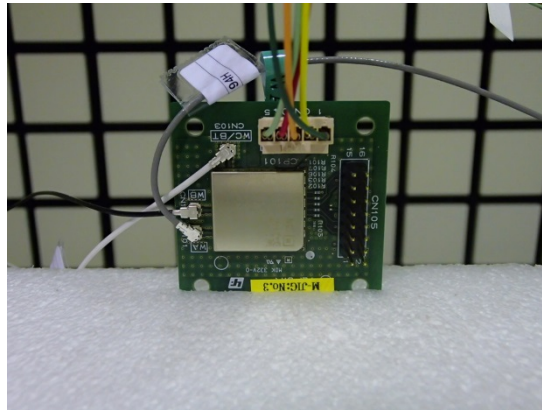

Test Configuration and peripherals

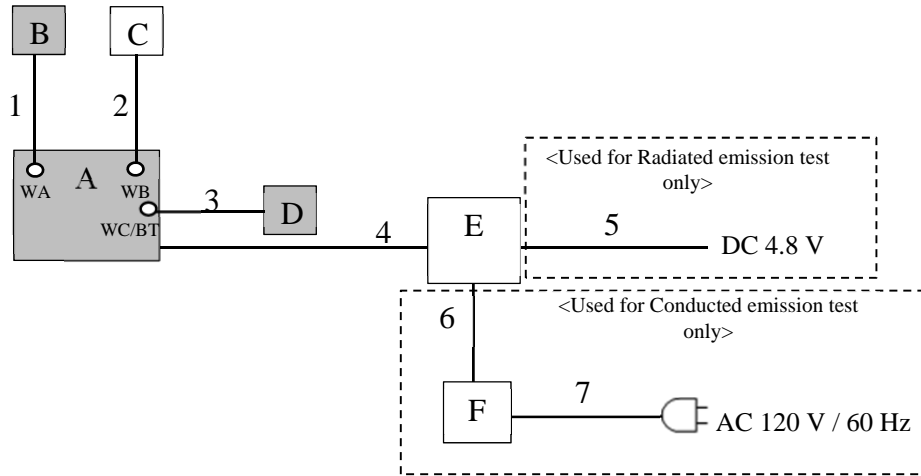

* Cabling and setup were taken into consideration and test data was taken under worse case conditions.

Description of EUT and Support equipment

No	Item	Model number	Serial number	Manufacturer	Remarks
A	Wireless communication module	J20H091	No.2 *1) No.3 *2)	Sony Interactive Entertainment	EUT
B	Antenna	2295423	No.1	TE Connectivity	EUT
C	Antenna	2295422	No.1	TE Connectivity	-
D	Antenna	2295421	No.1	TE Connectivity	EUT
E	Jig	-	No.2	-	-
F	DC Power supply	PMC35-2A	02871	KIKUSUI	*4)

List of cables used

No	Name	Length (m)	Shield		Remarks
			Cable	Connector	
1	Antenna Cable	0.15	Shielded	Shielded	-
2	Antenna Cable	0.30	Shielded	Shielded	-
3	Antenna Cable	0.45	Shielded	Shielded	-
4	DC + Signal Cable	0.35	Unshielded	Unshielded	-
5	DC Cable	0.50	Unshielded	Unshielded	*3)
6	DC Cable	3.00	Unshielded	Unshielded	*4)
7	AC Cable	1.50	Unshielded	Unshielded	*4)

- *1) Used for antenna terminal conducted tests.
- *2) Used for conducted emission and radiated emission tests.
- *3) Used for antenna terminal conducted tests and radiated emission test.
- *4) Used for conducted emission test only.

End of Report

UL Japan, Inc.

Ise EMC Lab.

4383-326 Asama-cho, Ise-shi, Mie-ken 516-0021 JAPAN

Telephone : +81 596 24 8999

Facsimile : +81 596 24 8124