

## FCC Test Report (WLAN)

**Report No.:** RF180416E05-1

**FCC ID:** AK8J20H098

**Test Model:** J20H098

**Received Date:** Apr. 16, 2018

**Test Date:** Apr. 24 to 27, 2018

**Issued Date:** May 28, 2018

**Applicant:** Sony Corporation

**Address:** 1-7-1 Konan Minato-ku Tokyo, 108-0075 Japan

**Issued By:** Bureau Veritas Consumer Products Services (H.K.) Ltd., Taoyuan Branch  
Hsin Chu Laboratory

**Lab Address:** E-2, No.1, Li Hsin 1st Road, Hsinchu Science Park, Hsinchu City 300,  
Taiwan R.O.C.

**Test Location :** E-2, No.1, Li Hsin 1st Road, Hsinchu Science Park, Hsinchu City 300,  
Taiwan R.O.C.

**FCC Registration /  
Designation Number:** 723255 / TW2022



This report is for your exclusive use. Any copying or replication of this report to or for any other person or entity, or use of our name or trademark, is permitted only with our prior written permission. This report sets forth our findings solely with respect to the test samples identified herein. The results set forth in this report are not indicative or representative of the quality or characteristics of the lot from which a test sample was taken or any similar or identical product unless specifically and expressly noted. Our report includes all of the tests requested by you and the results thereof based upon the information that you provided to us. You have 60 days from date of issuance of this report to notify us of any material error or omission caused by our negligence, provided, however, that such notice shall be in writing and shall specifically address the issue you wish to raise. A failure to raise such issue within the prescribed time shall constitute your unqualified acceptance of the completeness of this report, the tests conducted and the correctness of the report contents. Unless specific mention, the uncertainty of measurement has been explicitly taken into account to declare the compliance or non-compliance to the specification. The report must not be used by the client to claim product certification, approval, or endorsement by TAF or any government agencies.

## Table of Contents

<b>Release Control Record</b> .....	<b>4</b>
<b>1 Certificate of Conformity</b> .....	<b>5</b>
<b>2 Summary of Test Results</b> .....	<b>6</b>
2.1 Measurement Uncertainty .....	6
2.2 Modification Record .....	6
<b>3 General Information</b> .....	<b>7</b>
3.1 General Description of EUT (WLAN) .....	7
3.2 Description of Test Modes .....	9
3.2.1 Test Mode Applicability and Tested Channel Detail .....	11
3.3 Duty Cycle of Test Signal .....	13
3.4 Description of Support Units .....	14
3.4.1 Configuration of System under Test .....	14
3.5 General Description of Applied Standard .....	15
<b>4 Test Types and Results</b> .....	<b>16</b>
4.1 Radiated Emission and Bandedge Measurement .....	16
4.1.1 Limits of Radiated Emission and Bandedge Measurement .....	16
4.1.2 Test Instruments .....	17
4.1.3 Test Procedure .....	18
4.1.4 Deviation from Test Standard .....	18
4.1.5 Test Setup .....	19
4.1.6 EUT Operating Condition .....	20
4.1.7 Test Results .....	21
4.2 Conducted Emission Measurement .....	60
4.2.1 Limits of Conducted Emission Measurement .....	60
4.2.2 Test Instruments .....	60
4.2.3 Test Procedure .....	61
4.2.4 Deviation from Test Standard .....	61
4.2.5 Test Setup .....	61
4.2.6 EUT Operating Condition .....	61
4.2.7 Test Results .....	62
4.3 Transmit Power Measurement .....	64
4.3.1 Limits of Transmit Power Measurement .....	64
4.3.2 Test Setup .....	64
4.3.3 Test Instruments .....	65
4.3.4 Test Procedure .....	65
4.3.5 Deviation from Test Standard .....	65
4.3.6 EUT Operating Condition .....	65
4.3.7 Test Result .....	66
4.4 Occupied Bandwidth Measurement .....	73
4.4.1 Test Setup .....	73
4.4.2 Test Instruments .....	73
4.4.3 Test Procedure .....	73
4.4.4 Test Results .....	74
4.5 Peak Power Spectral Density Measurement .....	79
4.5.1 Limits of Peak Power Spectral Density Measurement .....	79
4.5.2 Test Setup .....	79
4.5.3 Test Instruments .....	79
4.5.4 Test Procedure .....	79
4.5.5 Deviation from Test Standard .....	80
4.5.6 EUT Operating Condition .....	80
4.5.7 Test Results .....	81
4.6 Frequency Stability Measurement .....	88
4.6.1 Limits of Frequency Stability Measurement .....	88

4.6.2	Test Setup.....	88
4.6.3	Test Instruments .....	88
4.6.4	Test Procedure .....	88
4.6.5	Deviation from Test Standard .....	88
4.6.6	EUT Operating Condition .....	88
4.6.7	Test Results .....	89
4.7	6dB Bandwidth Measurement .....	90
4.7.1	Limits of 6dB Bandwidth Measurement.....	90
4.7.2	Test Setup.....	90
4.7.3	Test Instruments .....	90
4.7.4	Test Procedure .....	90
4.7.5	Deviation from Test Standard .....	90
4.7.6	EUT Operating Condition .....	90
4.7.7	Test Results .....	91
<b>5</b>	<b>Pictures of Test Arrangements.....</b>	<b>93</b>
	<b>Annex A- Radiated Out of Band Emission (OOBE) Measurement (For U-NII-3 band) .....</b>	<b>94</b>
	<b>Appendix – Information on the Testing Laboratories .....</b>	<b>98</b>

### Release Control Record

Issue No.	Description	Date Issued
RF180416E05-1	Original release.	May 28, 2018

## 1 Certificate of Conformity

**Product:** WLAN/BT Module

**Brand:** FOXCONN

**Test Model:** J20H098

**Sample Status:** ENGINEERING SAMPLE

**Applicant:** Sony Corporation

**Test Date:** Apr. 24 to 27, 2018

**Standard:** 47 CFR FCC Part 15, Subpart E (Section 15.407)  
ANSI C63.10: 2013

The above equipment has been tested by **Bureau Veritas Consumer Products Services (H.K.) Ltd., Taoyuan Branch**, and found compliance with the requirement of the above standards. The test record, data evaluation & Equipment Under Test (EUT) configurations represented herein are true and accurate accounts of the measurements of the sample's EMC characteristics under the conditions specified in this report.

**Prepared by :** Mary Ko , **Date:** May 28, 2018  
Mary Ko / Specialist

**Approved by :** May Chen , **Date:** May 28, 2018  
May Chen / Manager

## 2 Summary of Test Results

47 CFR FCC Part 15, Subpart E (Section 15.407)			
FCC Clause	Test Item	Result	Remarks
15.407(b)(6)	AC Power Conducted Emission	PASS	Meet the requirement of limit. Minimum passing margin is -14.68dB at 0.15000MHz.
15.407(b) (1/2/3/4(i/ii)/6)	Radiated Emissions & Band Edge Measurement*	Pass	Meet the requirement of limit. Minimum passing margin is -0.1dB at 5725.00MHz.
15.407(a)(1/2/3)	Max Average Transmit Power	Pass	Meet the requirement of limit.
---	Occupied Bandwidth Measurement	-	Reference only.
15.407(a)(1/2/3)	Peak Power Spectral Density	Pass	Meet the requirement of limit.
15.407(e)	6dB bandwidth	Pass	Meet the requirement of limit. (U-NII-3 Band only)
15.407(g)	Frequency Stability	Pass	Meet the requirement of limit.
15.203	Antenna Requirement	Pass	No antenna connector is used.

\*For U-NII-3 band compliance with rule part 15.407(b)(4)(i), the OOBE test plots were recorded in Annex A.

### 2.1 Measurement Uncertainty

Where relevant, the following measurement uncertainty levels have been estimated for tests performed on the EUT as specified in CISPR 16-4-2:

Measurement	Frequency	Expanded Uncertainty (k=2) ( $\pm$ )
Conducted Emissions at mains ports	150kHz ~ 30MHz	1.84 dB
Radiated Emissions up to 1 GHz	30MHz ~ 1GHz	5.33 dB
Radiated Emissions above 1 GHz	1GHz ~ 6GHz	5.10 dB
	6GHz ~ 18GHz	4.85 dB
	18GHz ~ 40GHz	5.24 dB

### 2.2 Modification Record

There were no modifications required for compliance.

### 3 General Information

#### 3.1 General Description of EUT (WLAN)

Product	WLAN/BT Module
Brand	FOXCONN
Test Model	J20H098
Status of EUT	ENGINEERING SAMPLE
Power Supply Rating	3.3Vdc from host equipment
Modulation Type	CCK, DQPSK, DBPSK for DSSS 64QAM, 16QAM, QPSK, BPSK for OFDM 256QAM for OFDM in 11ac mode only
Modulation Technology	DSSS, OFDM
Transfer Rate	802.11b: up to 11Mbps 802.11a/g: up to 54Mbps 802.11n: up to 300Mbps 802.11ac: up to 866.7Mbps
Operating Frequency	<b>2.4GHz:</b> 2.412 ~ 2.462GHz <b>5GHz:</b> 5.18 ~ 5.24GHz, 5.26 ~ 5.32GHz, 5.50 ~ 5.70GHz, 5.745 ~ 5.825GHz
Number of Channel	<b>2.4GHz:</b> 802.11b, 802.11g, 802.11n (HT20): 11 <b>5GHz:</b> 802.11a, 802.11n (HT20), 802.11ac (VHT20): 24 802.11n (HT40), 802.11ac (VHT40): 11 802.11ac (VHT80): 5
Output Power	<b>2.4GHz:</b> 702.041mW <b>5GHz:</b> <b>5.18 ~ 5.24GHz:</b> 248.775mW <b>5.26 ~ 5.32GHz:</b> 237.912mW <b>5.50 ~ 5.70GHz:</b> 198.167mW <b>5.745 ~ 5.825GHz:</b> 328.118mW
Antenna Type	Refer to Note
Antenna Connector	Refer to Note
Accessory Device	NA
Data Cable Supplied	NA

Note:

1. There are WLAN and Bluetooth technology used for the EUT.
2. Simultaneously transmission condition.

Condition	Technology	
1	WLAN (2.4GHz)	Bluetooth
2	WLAN (5GHz)	Bluetooth

**Note:** The emission of the simultaneous operation has been evaluated and no non-compliance was found.

3. The EUT has two types, which are identical to each other in all aspects except for the followings:

Model	Type	Different
J20H098	Type 1	with Switch Connector
	Type 2	without Switch Connector

According to above types, **Type 1** was selected as representative model for the test and its data was recorded in this report.

4. The antennas provided to the EUT, please refer to the following table:

<b>For WLAN</b>				
Ant No.	Antenna Gain (dBi)	Frequency rang (MHz)	Antenna type	Connector type
1	-0.26	2412~2472	Metal PIFA	none
	1.89	5180~5240		
	2.3	5260~5320		
	3.14	5500~5700		
	1.53	5745~5825		
2	0.52	2412~2472	Metal PIFA	none
	3.73	5180~5240		
	3.01	5260~5320		
	2.12	5500~5700		
	1.15	5745~5825		
<b>For Bluetooth</b>				
Ant No.	Antenna Gain (dBi)	Frequency rang (GHz)	Antenna type	Connector type
1	0.85	2.4~2.4835	Metal PIFA	none

5. The EUT incorporates a MIMO function.

<b>2.4GHz Band</b>			
MODULATION MODE	DATA RATE (MCS)	TX & RX CONFIGURATION	
802.11b	1 ~ 11Mbps	2TX	2RX
802.11g	6 ~ 54Mbps	2TX	2RX
802.11n (HT20)	MCS 0~7	2TX	2RX
	MCS 8~15	2TX	2RX
<b>5GHz Band</b>			
MODULATION MODE	DATA RATE (MCS)	TX & RX CONFIGURATION	
802.11a	6 ~ 54Mbps	2TX	2RX
802.11n (HT20)	MCS 0~7	2TX	2RX
	MCS 8~15	2TX	2RX
802.11n (HT40)	MCS 0~7	2TX	2RX
	MCS 8~15	2TX	2RX
802.11ac (VHT20)	MCS0~8 Nss=1	2TX	2RX
	MCS0~8 Nss=2	2TX	2RX
802.11ac (VHT40)	MCS0~9 Nss=1	2TX	2RX
	MCS0~9 Nss=2	2TX	2RX
802.11ac (VHT80)	MCS0~9 Nss=1	2TX	2RX
	MCS0~9 Nss=2	2TX	2RX

6. The above EUT information is declared by manufacturer and for more detailed features description, please refer to the manufacturer's specifications or user's manual.



### 3.2 Description of Test Modes

#### FOR 5180 ~ 5240MHz

4 channels are provided for 802.11a, 802.11n (HT20), 802.11ac (VHT20):

Channel	Frequency	Channel	Frequency
36	5180 MHz	44	5220 MHz
40	5200 MHz	48	5240 MHz

2 channels are provided for 802.11n (HT40), 802.11ac (VHT40):

Channel	Frequency	Channel	Frequency
38	5190 MHz	46	5230 MHz

1 channel is provided for 802.11ac (VHT80):

Channel	Frequency
42	5210 MHz

#### FOR 5260 ~ 5320MHz

4 channels are provided for 802.11a, 802.11n (HT20), 802.11ac (VHT20):

Channel	Frequency	Channel	Frequency
52	5260 MHz	60	5300 MHz
56	5280 MHz	64	5320 MHz

2 channels are provided for 802.11n (HT40), 802.11ac (VHT40):

Channel	Frequency	Channel	Frequency
54	5270 MHz	62	5310 MHz

1 channel is provided for 802.11ac (VHT80):

Channel	Frequency
58	5290 MHz

### FOR 5500 ~ 5700MHz

11 channels are provided for 802.11a, 802.11n (HT20), 802.11ac (VHT20):

Channel	Frequency	Channel	Frequency
100	5500 MHz	124	5620 MHz
104	5520 MHz	128	5640 MHz
108	5540 MHz	132	5660 MHz
112	5560 MHz	136	5680 MHz
116	5580 MHz	140	5700 MHz
120	5600 MHz		

5 channels are provided for 802.11n (HT40), 802.11ac (VHT40):

Channel	Frequency	Channel	Frequency
102	5510 MHz	126	5630 MHz
110	5550 MHz	134	5670 MHz
118	5590 MHz		

2 channels are provided for 802.11ac (VHT80):

Channel	Frequency	Channel	Frequency
106	5530 MHz	122	5610 MHz

### FOR 5745 ~ 5825MHz:

5 channels are provided for 802.11a, 802.11n (HT20), 802.11ac (VHT20):

Channel	Frequency	Channel	Frequency
149	5745 MHz	161	5805 MHz
153	5765 MHz	165	5825 MHz
157	5785 MHz		

2 channels are provided for 802.11n (HT40), 802.11ac (VHT40):

Channel	Frequency	Channel	Frequency
151	5755 MHz	159	5795 MHz

1 channel is provided for 802.11ac (VHT80):

Channel	Frequency
155	5775 MHz

### 3.2.1 Test Mode Applicability and Tested Channel Detail

EUT Configure Mode	Applicable To				Description
	RE $\geq$ 1G	RE $<$ 1G	PLC	APCM	
-	√	√	√	√	-

Where **RE $\geq$ 1G**: Radiated Emission above 1GHz

**RE $<$ 1G**: Radiated Emission below 1GHz

**PLC**: Power Line Conducted Emission

**APCM**: Antenna Port Conducted Measurement

**NOTE**: 1. The EUT had been pre-tested on the positioned of each 3 axis. The worst case was found when positioned on **X-plane (below 1GHz) & Z-plane (above 1GHz)**.

#### **Radiated Emission Test (Above 1GHz):**

- Pre-Scan has been conducted to determine the worst-case mode from all possible combinations between available modulations, data rates and antenna ports (if EUT with antenna diversity architecture).
- Following channel(s) was (were) selected for the final test as listed below.

Mode	FREQ. Band (MHz)	Available Channel	Tested Channel	Modulation Technology	Modulation Type	Data Rate (Mbps)
802.11a	5180-5240	36 to 48	36, 40, 48	OFDM	BPSK	6
802.11ac (VHT20)		36 to 48	36, 40, 48	OFDM	BPSK	6.5
802.11ac (VHT40)		38 to 46	38, 46	OFDM	BPSK	13.5
802.11ac (VHT80)		42	42	OFDM	BPSK	29.3
802.11a	5260-5320	52 to 64	52, 60, 64	OFDM	BPSK	6
802.11ac (VHT20)		52 to 64	52, 60, 64	OFDM	BPSK	6.5
802.11ac (VHT40)		54 to 62	54, 62	OFDM	BPSK	13.5
802.11ac (VHT80)		58	58	OFDM	BPSK	29.3
802.11a	5500-5700	100 to 140	100, 116, 140	OFDM	BPSK	6
802.11ac (VHT20)		100 to 140	100, 116, 140	OFDM	BPSK	6.5
802.11ac (VHT40)		102 to 134	102, 110, 134	OFDM	BPSK	13.5
802.11ac (VHT80)		106 to 122	106, 122	OFDM	BPSK	29.3
802.11a	5745-5825	149 to 165	149, 157, 165	OFDM	BPSK	6
802.11ac (VHT20)		149 to 165	149, 157, 165	OFDM	BPSK	6.5
802.11ac (VHT40)		151 to 159	151, 159	OFDM	BPSK	13.5
802.11ac (VHT80)		155	155	OFDM	BPSK	29.3

#### **Radiated Emission Test (Below 1GHz):**

- Pre-Scan has been conducted to determine the worst-case mode from all possible combinations between available modulations, data rates and antenna ports (if EUT with antenna diversity architecture).
- Following channel(s) was (were) selected for the final test as listed below.

Mode	FREQ. Band (MHz)	Available Channel	Tested Channel	Modulation Technology	Modulation Type	Data Rate (Mbps)
802.11a	5180-5240 5745-5825 5500-5700 5745-5825	36 to 48 52 to 64 100 to 140 149 to 165	40	OFDM	BPSK	6

### Power Line Conducted Emission Test:

- Pre-Scan has been conducted to determine the worst-case mode from all possible combinations between available modulations, data rates and antenna ports (if EUT with antenna diversity architecture).
- Following channel(s) was (were) selected for the final test as listed below.

Mode	FREQ. Band (MHz)	Available Channel	Tested Channel	Modulation Technology	Modulation Type	Data Rate (Mbps)
802.11a	5180-5240 5745-5825 5500-5700 5745-5825	36 to 48 52 to 64 100 to 140 149 to 165	40	OFDM	BPSK	6

### Antenna Port Conducted Measurement:

- This item includes all test value of each mode, but only includes spectrum plot of worst value of each mode.
- Pre-Scan has been conducted to determine the worst-case mode from all possible combinations between available modulations, data rates and antenna ports (if EUT with antenna diversity architecture).
- Following channel(s) was (were) selected for the final test as listed below.

Mode	FREQ. Band (MHz)	Available Channel	Tested Channel	Modulation Technology	Modulation Type	Data Rate (Mbps)
802.11a	5180-5240	36 to 48	36, 40, 48	OFDM	BPSK	6
802.11ac (VHT20)		36 to 48	36, 40, 48	OFDM	BPSK	6.5
802.11ac (VHT40)		38 to 46	38, 46	OFDM	BPSK	13.5
802.11ac (VHT80)		42	42	OFDM	BPSK	29.3
802.11a	5260-5320	52 to 64	52, 60, 64	OFDM	BPSK	6
802.11ac (VHT20)		52 to 64	52, 60, 64	OFDM	BPSK	6.5
802.11ac (VHT40)		54 to 62	54, 62	OFDM	BPSK	13.5
802.11ac (VHT80)		58	58	OFDM	BPSK	29.3
802.11a	5500-5700	100 to 140	100, 116, 140	OFDM	BPSK	6
802.11ac (VHT20)		100 to 140	100, 116, 140	OFDM	BPSK	6.5
802.11ac (VHT40)		102 to 134	102, 110, 134	OFDM	BPSK	13.5
802.11ac (VHT80)		106 to 122	106, 122	OFDM	BPSK	29.3
802.11a	5745-5825	149 to 165	149, 157, 165	OFDM	BPSK	6
802.11ac (VHT20)		149 to 165	149, 157, 165	OFDM	BPSK	6.5
802.11ac (VHT40)		151 to 159	151, 159	OFDM	BPSK	13.5
802.11ac (VHT80)		155	155	OFDM	BPSK	29.3

### Test Condition:

APPLICABLE TO	ENVIRONMENTAL CONDITIONS	INPUT POWER	TESTED BY
RE $\geq$ 1G	21deg. C, 61%RH	120Vac, 60Hz (system)	Eason Tseng
RE $<$ 1G	20deg. C, 64%RH	120Vac, 60Hz (system)	Frank Chuang
PLC	25deg. C, 75%RH	120Vac, 60Hz (system)	Andy Ho
APCM	22deg. C, 61%RH	3Vdc	Robert Cheng

### 3.3 Duty Cycle of Test Signal

If duty cycle of test signal is < 98%, duty factor shall be considered.

**802.11a:** Duty cycle = 1.391 ms/1.428 ms = 0.974, Duty factor =  $10 * \log(1/0.974) = 0.11$

**802.11ac (VHT20):** Duty cycle = 0.68 ms/0.716 ms = 0.95, Duty factor =  $10 * \log(1/0.95) = 0.22$

**802.11ac (VHT40):** Duty cycle = 0.351 ms/0.387 ms = 0.907, Duty factor =  $10 * \log(1/0.907) = 0.42$

**802.11ac (VHT80):** Duty cycle = 0.188 ms/0.332 ms = 0.566, Duty factor =  $10 * \log(1/0.566) = 2.47$

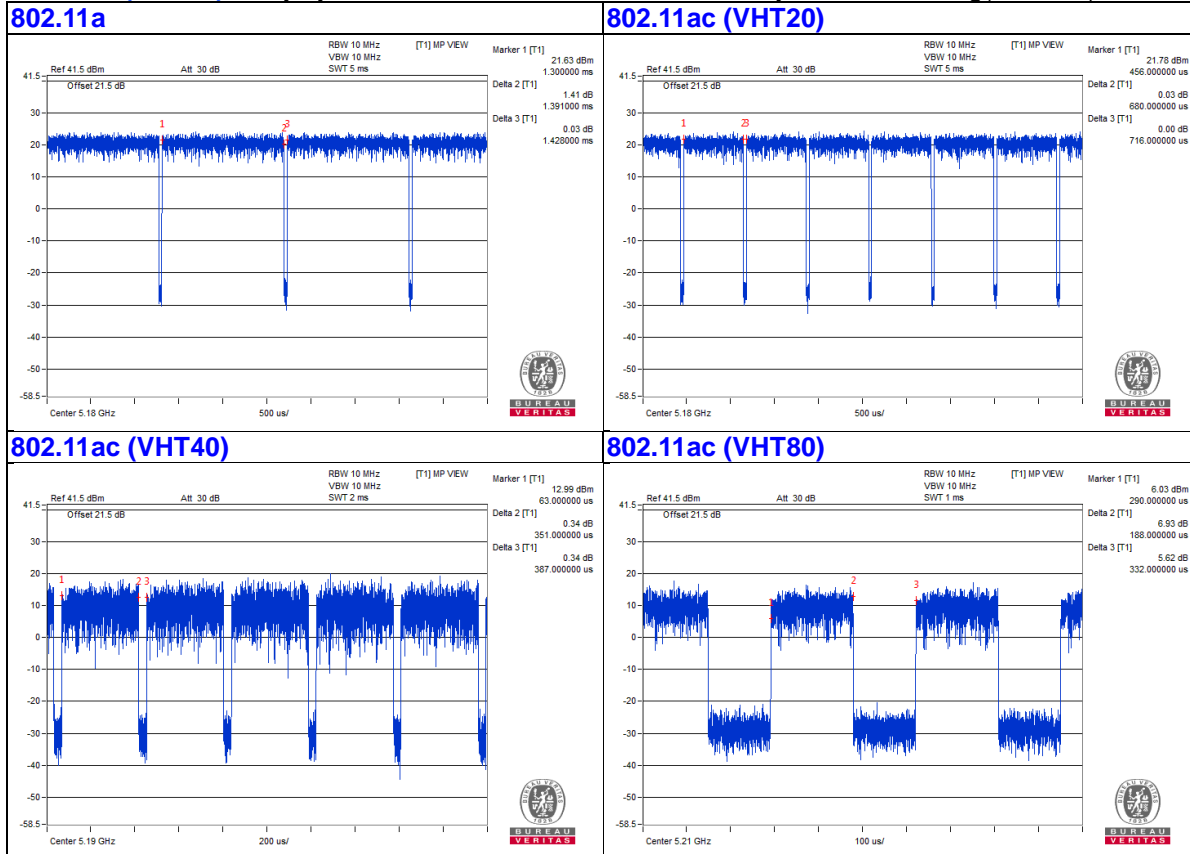

### 3.4 Description of Support Units

The EUT has been tested as an independent unit together with other necessary accessories or support units. The following support units or accessories were used to form a representative test configuration during the tests.

ID	Product	Brand	Model No.	Serial No.	FCC ID	Remarks
A.	Laptop	DELL	E6420	B92T3R1	FCC DoC	Provided by Lab
B.	Test Tool	NA	NA	NA	NA	Supplied by client

ID	Descriptions	Qty.	Length (m)	Shielding (Yes/No)	Cores (Qty.)	Remarks
1.	Cable	1	0.1	No	0	Supplied by client
2.	USB Cable	1	1.4	Yes	0	Provided by Lab

#### 3.4.1 Configuration of System under Test

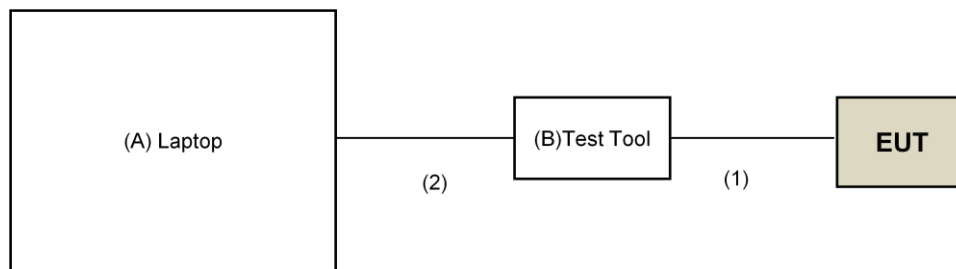

### 3.5 General Description of Applied Standard

The EUT is a RF Product. According to the specifications of the manufacturer, it must comply with the requirements of the following standards:

**FCC Part 15, Subpart E (15.407)**  
**KDB 789033 D02 General UNII Test Procedure New Rules v02r01**  
**KDB 662911 D01 Multiple Transmitter Output v02r01**  
**ANSI C63.10-2013**

All test items have been performed and recorded as per the above standards.

## 4 Test Types and Results

### 4.1 Radiated Emission and Bandedge Measurement

#### 4.1.1 Limits of Radiated Emission and Bandedge Measurement

Radiated emissions which fall in the restricted bands must comply with the radiated emission limits specified as below table.

Frequencies (MHz)	Field Strength (microvolts/meter)	Measurement Distance (meters)
0.009 ~ 0.490	2400/F(kHz)	300
0.490 ~ 1.705	24000/F(kHz)	30
1.705 ~ 30.0	30	30
30 ~ 88	100	3
88 ~ 216	150	3
216 ~ 960	200	3
Above 960	500	3

#### NOTE:

1. The lower limit shall apply at the transition frequencies.
2. Emission level (dBuV/m) = 20 log Emission level (uV/m).
3. For frequencies above 1000MHz, the field strength limits are based on average detector, however, the peak field strength of any emission shall not exceed the maximum permitted average limits, specified above by more than 20dB under any condition of modulation.

Limits of unwanted emission out of the restricted bands

Applicable To		Limit	
789033 D02 General UNII Test Procedure New Rules v02r01		Field Strength at 3m	
		PK:74 (dBuV/m)	AV:54 (dBuV/m)
Frequency Band	Applicable To	EIRP Limit	Equivalent Field Strength at 3m
5150~5250 MHz	15.407(b)(1)	PK:-27 (dBm/MHz)	PK:68.2(dBuV/m)
5250~5350 MHz	15.407(b)(2)		
5470~5725 MHz	15.407(b)(3)		
5725~5850 MHz	<input checked="" type="checkbox"/> 15.407(b)(4)(i)	PK:-27 (dBm/MHz) <sup>*1</sup> PK:10 (dBm/MHz) <sup>*2</sup> PK:15.6 (dBm/MHz) <sup>*3</sup> PK:27 (dBm/MHz) <sup>*4</sup>	PK: 68.2(dBuV/m) <sup>*1</sup> PK:105.2 (dBuV/m) <sup>*2</sup> PK: 110.8(dBuV/m) <sup>*3</sup> PK:122.2 (dBuV/m) <sup>*4</sup>
	<input type="checkbox"/> 15.407(b)(4)(ii)	Emission limits in section 15.247(d)	
<sup>*1</sup> beyond 75 MHz or more above of the band edge.		<sup>*2</sup> below the band edge increasing linearly to 10 dBm/MHz at 25 MHz above.	
<sup>*3</sup> below the band edge increasing linearly to a level of 15.6 dBm/MHz at 5 MHz above.		<sup>*4</sup> from 5 MHz above or below the band edge increasing linearly to a level of 27 dBm/MHz at the band edge.	

#### Note:

The following formula is used to convert the equipment isotropic radiated power (eirp) to field strength:

$$E = \frac{1000000\sqrt{30P}}{3} \mu\text{V/m, where P is the eirp (Watts).}$$



## 4.1.2 Test Instruments

DESCRIPTION & MANUFACTURER	MODEL NO.	SERIAL NO.	CALIBRATED DATE	CALIBRATED UNTIL
Test Receiver Keysight	N9038A	MY54450088	July 08, 2017	July 07, 2018
Pre-Amplifier EMCI	EMC001340	980142	Feb. 09, 2018	Feb. 08, 2019
Loop Antenna <sup>(*)</sup> Electro-Metrics	EM-6879	264	Dec. 16, 2016	Dec. 15, 2018
RF Cable	NA	LOOPCAB-001 LOOPCAB-002	Jan. 15, 2018	Jan. 14, 2019
Pre-Amplifier Mini-Circuits	ZFL-1000VH2B	AMP-ZFL-01	Nov. 09, 2017	Nov. 08, 2018
Trilog Broadband Antenna SCHWARZBECK	VULB 9168	9168-406	Nov. 29, 2017	Nov. 28, 2018
RF Cable	8D	966-4-1 966-4-2 966-4-3	Mar. 21, 2018	Mar. 20, 2019
Fixed attenuator Mini-Circuits	UNAT-5+	PAD-3m-4-01	Oct. 03, 2017	Oct. 02, 2018
Horn_Antenna SCHWARZBECK	BBHA 9120D	9120D-783	Dec. 12, 2017	Dec. 11, 2018
Pre-Amplifier EMCI	EMC12630SE	980385	Jan. 29, 2018	Jan. 28, 2019
RF Cable	EMC104-SM-SM-1200 EMC104-SM-SM-2000 EMC104-SM-SM-5000	160923 150318 150321	Jan. 29, 2018	Jan. 28, 2019
Pre-Amplifier EMCI	EMC184045SE	980387	Jan. 29, 2018	Jan. 28, 2019
Horn_Antenna SCHWARZBECK	BBHA 9170	BBHA9170608	Dec. 14, 2017	Dec. 13, 2018
RF Cable	EMC102-KM-KM-1200	160925	Jan. 29, 2018	Jan. 28, 2019
Software	ADT_Radiated_V8.7.08	NA	NA	NA
Antenna Tower & Turn Table Max-Full	MF-7802	MF780208410	NA	NA
Boresight Antenna Fixture	FBA-01	FBA-SIP02	NA	NA
Spectrum Analyzer R&S	FSV40	100964	July 1, 2017	June 30, 2018
Power meter Anritsu	ML2495A	1014008	May 11, 2017	May 10, 2018
Power sensor Anritsu	MA2411B	0917122	May 11, 2017	May 10, 2018
DC Power Supply Topward	6603D	795558	NA	NA
Temperature & Humidity Chamber Giant Force	GTH-150-40-SP-AR	MAA0812-008	Jan. 10, 2018	Jan. 09, 2019
True RMS Clamp Meter FLUKE	325	31130711WS	May 29, 2017	May 28, 2018

**Note:**

1. The calibration interval of the above test instruments is 12 months and the calibrations are traceable to NML/ROC and NIST/USA.
2. \*The calibration interval of the above test instruments is 24 months and the calibrations are traceable to NML/ROC and NIST/USA.
3. The test was performed in 966 Chamber No. 4.
4. The CANADA Site Registration No. is 20331-2
5. Loop antenna was used for all emissions below 30 MHz.
6. Tested Date: Apr. 24 to 27, 2018

#### 4.1.3 Test Procedure

##### **For Radiated emission below 30MHz**

- a. The EUT was placed on the top of a rotating table 0.8 meters above the ground at a 3 meter chamber room. The table was rotated 360 degrees to determine the position of the highest radiation.
- b. The EUT was set 3 meters away from the interference-receiving antenna, which was mounted on the top of a variable-height antenna tower.
- c. Parallel, perpendicular, and ground-parallel orientations of the antenna are set to make the measurement.
- d. For each suspected emission, the EUT was arranged to its worst case and the rotatable table was turned from 0 degrees to 360 degrees to find the maximum reading.
- e. The test-receiver system was set to Quasi-Peak Detect Function and Specified Bandwidth with Maximum Hold Mode.

##### **NOTE:**

1. The resolution bandwidth and video bandwidth of test receiver/spectrum analyzer is 9kHz at frequency below 30MHz.

##### **For Radiated emission above 30MHz**

- a. The EUT was placed on the top of a rotating table 0.8 meters (for 30MHz ~ 1GHz) / 1.5 meters (for above 1GHz) above the ground at 3 meter chamber room for test. The table was rotated 360 degrees to determine the position of the highest radiation.
- b. The EUT was set 3 meters away from the interference-receiving antenna, which was mounted on the top of a variable-height antenna tower.
- c. The height of antenna is varied from one meter to four meters above the ground to determine the maximum value of the field strength. Both horizontal and vertical polarizations of the antenna are set to make the measurement.
- d. For each suspected emission, the EUT was arranged to its worst case and then the antenna was tuned to heights from 1 meter to 4 meters and the rotatable table was turned from 0 degrees to 360 degrees to find the maximum reading.
- e. The test-receiver system was set to quasi-peak detect function and specified bandwidth with maximum hold mode when the test frequency is below 1 GHz.
- f. The test-receiver system was set to peak and average detect function and specified bandwidth with maximum hold mode when the test frequency is above 1 GHz. If the peak reading value also meets average limit, measurement with the average detector is unnecessary.

##### **Note:**

1. The resolution bandwidth and video bandwidth of test receiver/spectrum analyzer is 120kHz for Quasi-peak detection (QP) at frequency below 1GHz.
2. The resolution bandwidth of test receiver/spectrum analyzer is 1 MHz and the video bandwidth is 3 MHz for Peak detection (PK) at frequency above 1GHz.
3. The resolution bandwidth of test receiver/spectrum analyzer is 1MHz and the video bandwidth is  $\geq 1/T$  (Duty cycle  $< 98\%$ ) or 10Hz (Duty cycle  $\geq 98\%$ ) for Average detection (AV) at frequency above 1GHz.
4. All modes of operation were investigated and the worst-case emissions are reported.

#### 4.1.4 Deviation from Test Standard

No deviation.

#### 4.1.5 Test Setup

##### For Radiated emission below 30MHz

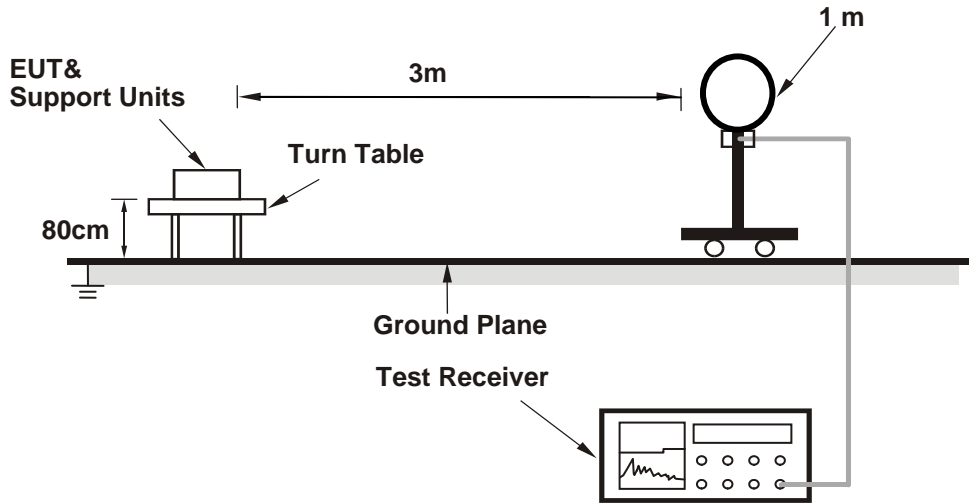

##### For Radiated emission 30MHz to 1GHz

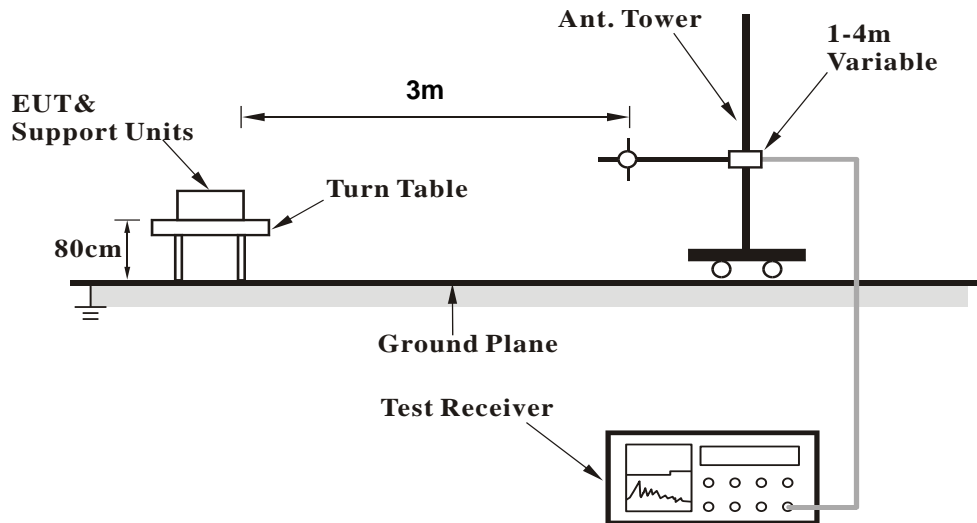

### For Radiated emission above 1GHz

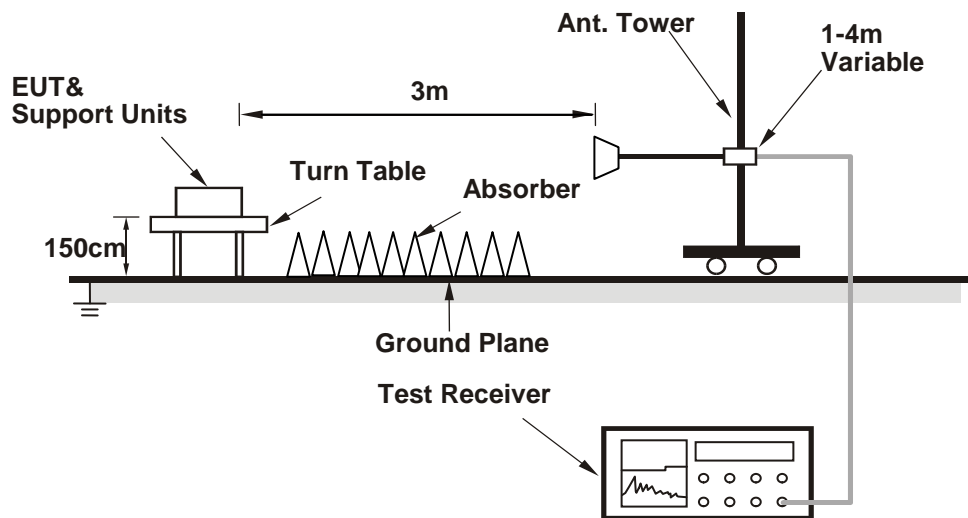

For the actual test configuration, please refer to the attached file (Test Setup Photo).

#### 4.1.6 EUT Operating Condition

- a. Placed the EUT on the testing table.
- b. Controlling software (MT7668 QA 0.0.1.90) has been activated to set the EUT on specific status.

4.1.7 Test Results

Above 1GHz Data:

802.11a

<b>CHANNEL</b>	TX Channel 36	<b>DETECTOR FUNCTION</b>	Peak (PK)
<b>FREQUENCY RANGE</b>	1GHz ~ 40GHz		Average (AV)

ANTENNA POLARITY & TEST DISTANCE: HORIZONTAL AT 3 M								
NO.	FREQ. (MHz)	EMISSION LEVEL (dBuV/m)	LIMIT (dBuV/m)	MARGIN (dB)	ANTENNA HEIGHT (m)	TABLE ANGLE (Degree)	RAW VALUE (dBuV)	CORRECTION FACTOR (dB/m)
1	5150.00	67.7 PK	74.0	-6.3	1.00 H	95	63.6	4.1
2	5150.00	53.7 AV	54.0	-0.3	1.00 H	95	49.6	4.1
3	*5180.00	113.3 PK			1.00 H	95	109.5	3.8
4	*5180.00	104.6 AV			1.00 H	95	100.8	3.8
5	#10360.00	49.2 PK	74.0	-24.8	1.49 H	224	36.1	13.1
6	#10360.00	39.1 AV	54.0	-14.9	1.49 H	224	26.0	13.1
7	15540.00	49.7 PK	74.0	-24.3	1.58 H	278	36.6	13.1
8	15540.00	38.2 AV	54.0	-15.8	1.58 H	278	25.1	13.1

ANTENNA POLARITY & TEST DISTANCE: VERTICAL AT 3 M								
NO.	FREQ. (MHz)	EMISSION LEVEL (dBuV/m)	LIMIT (dBuV/m)	MARGIN (dB)	ANTENNA HEIGHT (m)	TABLE ANGLE (Degree)	RAW VALUE (dBuV)	CORRECTION FACTOR (dB/m)
1	5150.00	65.3 PK	74.0	-8.7	3.07 V	110	61.2	4.1
2	5150.00	51.4 AV	54.0	-2.6	3.07 V	110	47.3	4.1
3	*5180.00	112.7 PK			3.07 V	110	108.9	3.8
4	*5180.00	103.6 AV			3.07 V	110	99.8	3.8
5	#10360.00	50.1 PK	74.0	-23.9	1.46 V	317	37.0	13.1
6	#10360.00	39.0 AV	54.0	-15.0	1.46 V	317	25.9	13.1
7	15540.00	48.9 PK	74.0	-25.1	1.39 V	136	35.8	13.1
8	15540.00	38.0 AV	54.0	-16.0	1.39 V	136	24.9	13.1

REMARKS:

1. Emission Level(dBuV/m) = Raw Value(dBuV) + Correction Factor(dB/m)
2. Correction Factor(dB/m) = Antenna Factor(dB/m) + Cable Factor(dB) – Pre-Amplifier Factor(dB)
3. The other emission levels were very low against the limit.
4. Margin value = Emission Level – Limit value
5. " \* ": Fundamental frequency.
6. " # ": The radiated frequency is out of the restricted band.

<b>CHANNEL</b>	TX Channel 40	<b>DETECTOR FUNCTION</b>	Peak (PK)
<b>FREQUENCY RANGE</b>	1GHz ~ 40GHz		Average (AV)

**ANTENNA POLARITY & TEST DISTANCE: HORIZONTAL AT 3 M**

NO.	FREQ. (MHz)	EMISSION LEVEL (dBuV/m)	LIMIT (dBuV/m)	MARGIN (dB)	ANTENNA HEIGHT (m)	TABLE ANGLE (Degree)	RAW VALUE (dBuV)	CORRECTION FACTOR (dB/m)
1	5150.00	59.3 PK	74.0	-14.7	1.26 H	183	55.2	4.1
2	5150.00	48.9 AV	54.0	-5.1	1.26 H	183	44.8	4.1
3	*5200.00	116.5 PK			1.26 H	183	112.8	3.7
4	*5200.00	106.9 AV			1.26 H	183	103.2	3.7
5	5350.00	48.6 PK	74.0	-25.4	1.26 H	183	45.0	3.6
6	5350.00	39.2 AV	54.0	-14.8	1.26 H	183	35.6	3.6
7	#10400.00	49.8 PK	74.0	-24.2	1.45 H	225	36.7	13.1
8	#10400.00	39.5 AV	54.0	-14.5	1.45 H	225	26.4	13.1
9	15600.00	50.2 PK	74.0	-23.8	1.56 H	278	37.2	13.0
10	15600.00	38.8 AV	54.0	-15.2	1.56 H	278	25.8	13.0

**ANTENNA POLARITY & TEST DISTANCE: VERTICAL AT 3 M**

NO.	FREQ. (MHz)	EMISSION LEVEL (dBuV/m)	LIMIT (dBuV/m)	MARGIN (dB)	ANTENNA HEIGHT (m)	TABLE ANGLE (Degree)	RAW VALUE (dBuV)	CORRECTION FACTOR (dB/m)
1	5150.00	55.4 PK	74.0	-18.6	3.05 V	174	51.3	4.1
2	5150.00	47.1 AV	54.0	-6.9	3.05 V	174	43.0	4.1
3	*5200.00	116.3 PK			3.05 V	174	112.6	3.7
4	*5200.00	106.3 AV			3.05 V	174	102.6	3.7
5	5350.00	49.4 PK	74.0	-24.6	3.05 V	174	45.8	3.6
6	5350.00	39.1 AV	54.0	-14.9	3.05 V	174	35.5	3.6
7	#10400.00	49.8 PK	74.0	-24.2	1.41 V	305	36.7	13.1
8	#10400.00	38.9 AV	54.0	-15.1	1.41 V	305	25.8	13.1
9	15600.00	48.5 PK	74.0	-25.5	1.38 V	149	35.5	13.0
10	15600.00	37.7 AV	54.0	-16.3	1.38 V	149	24.7	13.0

**REMARKS:**

1. Emission Level(dBuV/m) = Raw Value(dBuV) + Correction Factor(dB/m)
2. Correction Factor(dB/m) = Antenna Factor(dB/m) + Cable Factor(dB) – Pre-Amplifier Factor(dB)
3. The other emission levels were very low against the limit.
4. Margin value = Emission Level – Limit value
5. " \* ": Fundamental frequency.
6. " # ": The radiated frequency is out of the restricted band.

<b>CHANNEL</b>	TX Channel 48	<b>DETECTOR FUNCTION</b>	Peak (PK)
<b>FREQUENCY RANGE</b>	1GHz ~ 40GHz		Average (AV)

**ANTENNA POLARITY & TEST DISTANCE: HORIZONTAL AT 3 M**

NO.	FREQ. (MHz)	EMISSION LEVEL (dBuV/m)	LIMIT (dBuV/m)	MARGIN (dB)	ANTENNA HEIGHT (m)	TABLE ANGLE (Degree)	RAW VALUE (dBuV)	CORRECTION FACTOR (dB/m)
1	*5240.00	117.2 PK			1.35 H	175	113.7	3.5
2	*5240.00	107.2 AV			1.35 H	175	103.7	3.5
3	5350.00	48.9 PK	74.0	-25.1	1.35 H	175	45.3	3.6
4	5350.00	40.2 AV	54.0	-13.8	1.35 H	175	36.6	3.6
5	#10480.00	49.4 PK	74.0	-24.6	1.47 H	231	35.9	13.5
6	#10480.00	39.3 AV	54.0	-14.7	1.47 H	231	25.8	13.5
7	15720.00	50.1 PK	74.0	-23.9	1.59 H	280	37.3	12.8
8	15720.00	38.5 AV	54.0	-15.5	1.59 H	280	25.7	12.8

**ANTENNA POLARITY & TEST DISTANCE: VERTICAL AT 3 M**

NO.	FREQ. (MHz)	EMISSION LEVEL (dBuV/m)	LIMIT (dBuV/m)	MARGIN (dB)	ANTENNA HEIGHT (m)	TABLE ANGLE (Degree)	RAW VALUE (dBuV)	CORRECTION FACTOR (dB/m)
1	*5240.00	116.8 PK			3.05 V	170	113.3	3.5
2	*5240.00	106.6 AV			3.05 V	170	103.1	3.5
3	5350.00	47.6 PK	74.0	-26.4	3.05 V	170	44.0	3.6
4	5350.00	39.8 AV	54.0	-14.2	3.05 V	170	36.2	3.6
5	#10480.00	50.5 PK	74.0	-23.5	1.43 V	294	37.0	13.5
6	#10480.00	39.4 AV	54.0	-14.6	1.43 V	294	25.9	13.5
7	15720.00	48.1 PK	74.0	-25.9	1.35 V	158	35.3	12.8
8	15720.00	37.4 AV	54.0	-16.6	1.35 V	158	24.6	12.8

**REMARKS:**

1. Emission Level(dBuV/m) = Raw Value(dBuV) + Correction Factor(dB/m)
2. Correction Factor(dB/m) = Antenna Factor(dB/m) + Cable Factor(dB) – Pre-Amplifier Factor(dB)
3. The other emission levels were very low against the limit.
4. Margin value = Emission Level – Limit value
5. " \* ": Fundamental frequency.
6. " # ": The radiated frequency is out of the restricted band.

<b>CHANNEL</b>	TX Channel 52	<b>DETECTOR FUNCTION</b>	Peak (PK)
<b>FREQUENCY RANGE</b>	1GHz ~ 40GHz		Average (AV)

**ANTENNA POLARITY & TEST DISTANCE: HORIZONTAL AT 3 M**

NO.	FREQ. (MHz)	EMISSION LEVEL (dBuV/m)	LIMIT (dBuV/m)	MARGIN (dB)	ANTENNA HEIGHT (m)	TABLE ANGLE (Degree)	RAW VALUE (dBuV)	CORRECTION FACTOR (dB/m)
1	5150.00	49.4 PK	74.0	-24.6	1.04 H	179	45.3	4.1
2	5150.00	39.1 AV	54.0	-14.9	1.04 H	179	35.0	4.1
3	*5260.00	115.7 PK			1.04 H	179	112.3	3.4
4	*5260.00	106.8 AV			1.04 H	179	103.4	3.4
5	#10520.00	49.5 PK	74.0	-24.5	1.44 H	234	36.1	13.4
6	#10520.00	39.4 AV	54.0	-14.6	1.44 H	234	26.0	13.4
7	15780.00	49.6 PK	74.0	-24.4	1.59 H	293	36.7	12.9
8	15780.00	38.1 AV	54.0	-15.9	1.59 H	293	25.2	12.9

**ANTENNA POLARITY & TEST DISTANCE: VERTICAL AT 3 M**

NO.	FREQ. (MHz)	EMISSION LEVEL (dBuV/m)	LIMIT (dBuV/m)	MARGIN (dB)	ANTENNA HEIGHT (m)	TABLE ANGLE (Degree)	RAW VALUE (dBuV)	CORRECTION FACTOR (dB/m)
1	5150.00	48.6 PK	74.0	-25.4	3.07 V	185	44.5	4.1
2	5150.00	38.4 AV	54.0	-15.6	3.07 V	185	34.3	4.1
3	*5260.00	115.3 PK			3.07 V	185	111.9	3.4
4	*5260.00	106.4 AV			3.07 V	185	103.0	3.4
5	#10520.00	49.2 PK	74.0	-24.8	1.44 V	296	35.8	13.4
6	#10520.00	38.6 AV	54.0	-15.4	1.44 V	296	25.2	13.4
7	15780.00	48.6 PK	74.0	-25.4	1.42 V	160	35.7	12.9
8	15780.00	37.8 AV	54.0	-16.2	1.42 V	160	24.9	12.9

**REMARKS:**

1. Emission Level(dBuV/m) = Raw Value(dBuV) + Correction Factor(dB/m)
2. Correction Factor(dB/m) = Antenna Factor(dB/m) + Cable Factor(dB) – Pre-Amplifier Factor(dB)
3. The other emission levels were very low against the limit.
4. Margin value = Emission Level – Limit value
5. " \* ": Fundamental frequency.
6. " # ": The radiated frequency is out of the restricted band.



<b>CHANNEL</b>	TX Channel 60	<b>DETECTOR FUNCTION</b>	Peak (PK)
<b>FREQUENCY RANGE</b>	1GHz ~ 40GHz		Average (AV)

**ANTENNA POLARITY & TEST DISTANCE: HORIZONTAL AT 3 M**

NO.	FREQ. (MHz)	EMISSION LEVEL (dBuV/m)	LIMIT (dBuV/m)	MARGIN (dB)	ANTENNA HEIGHT (m)	TABLE ANGLE (Degree)	RAW VALUE (dBuV)	CORRECTION FACTOR (dB/m)
1	*5300.00	115.4 PK			1.04 H	174	111.9	3.5
2	*5300.00	106.7 AV			1.04 H	174	103.2	3.5
3	10600.00	49.8 PK	74.0	-24.2	1.44 H	233	37.0	12.8
4	10600.00	39.4 AV	54.0	-14.6	1.44 H	233	26.6	12.8
5	15900.00	49.4 PK	74.0	-24.6	1.63 H	280	36.7	12.7
6	15900.00	38.1 AV	54.0	-15.9	1.63 H	280	25.4	12.7

**ANTENNA POLARITY & TEST DISTANCE: VERTICAL AT 3 M**

NO.	FREQ. (MHz)	EMISSION LEVEL (dBuV/m)	LIMIT (dBuV/m)	MARGIN (dB)	ANTENNA HEIGHT (m)	TABLE ANGLE (Degree)	RAW VALUE (dBuV)	CORRECTION FACTOR (dB/m)
1	*5300.00	115.3 PK			3.03 V	171	111.8	3.5
2	*5300.00	105.9 AV			3.03 V	171	102.4	3.5
3	10600.00	50.2 PK	74.0	-23.8	1.42 V	299	37.4	12.8
4	10600.00	39.4 AV	54.0	-14.6	1.42 V	299	26.6	12.8
5	15900.00	48.4 PK	74.0	-25.6	1.37 V	141	35.7	12.7
6	15900.00	37.8 AV	54.0	-16.2	1.37 V	141	25.1	12.7

**REMARKS:**

1. Emission Level(dBuV/m) = Raw Value(dBuV) + Correction Factor(dB/m)
2. Correction Factor(dB/m) = Antenna Factor(dB/m) + Cable Factor(dB) – Pre-Amplifier Factor(dB)
3. The other emission levels were very low against the limit.
4. Margin value = Emission Level – Limit value
5. " \* ": Fundamental frequency.

<b>CHANNEL</b>	TX Channel 64	<b>DETECTOR FUNCTION</b>	Peak (PK)
<b>FREQUENCY RANGE</b>	1GHz ~ 40GHz		Average (AV)

**ANTENNA POLARITY & TEST DISTANCE: HORIZONTAL AT 3 M**

NO.	FREQ. (MHz)	EMISSION LEVEL (dBuV/m)	LIMIT (dBuV/m)	MARGIN (dB)	ANTENNA HEIGHT (m)	TABLE ANGLE (Degree)	RAW VALUE (dBuV)	CORRECTION FACTOR (dB/m)
1	*5320.00	114.1 PK			1.03 H	178	110.6	3.5
2	*5320.00	105.4 AV			1.03 H	178	101.9	3.5
3	5350.00	64.6 PK	74.0	-9.4	1.03 H	178	61.0	3.6
4	5350.00	53.6 AV	54.0	-0.4	1.03 H	178	50.0	3.6
5	10640.00	49.0 PK	74.0	-25.0	1.45 H	230	36.0	13.0
6	10640.00	39.1 AV	54.0	-14.9	1.45 H	230	26.1	13.0
7	15960.00	50.3 PK	74.0	-23.7	1.59 H	295	37.5	12.8
8	15960.00	38.7 AV	54.0	-15.3	1.59 H	295	25.9	12.8

**ANTENNA POLARITY & TEST DISTANCE: VERTICAL AT 3 M**

NO.	FREQ. (MHz)	EMISSION LEVEL (dBuV/m)	LIMIT (dBuV/m)	MARGIN (dB)	ANTENNA HEIGHT (m)	TABLE ANGLE (Degree)	RAW VALUE (dBuV)	CORRECTION FACTOR (dB/m)
1	*5320.00	113.5 PK			3.01 V	165	110.0	3.5
2	*5320.00	104.6 AV			3.01 V	165	101.1	3.5
3	5350.00	62.7 PK	74.0	-11.3	3.01 V	165	59.1	3.6
4	5350.00	52.4 AV	54.0	-1.6	3.01 V	165	48.8	3.6
5	10640.00	50.0 PK	74.0	-24.0	1.43 V	303	37.0	13.0
6	10640.00	38.9 AV	54.0	-15.1	1.43 V	303	25.9	13.0
7	15960.00	48.1 PK	74.0	-25.9	1.39 V	156	35.3	12.8
8	15960.00	37.2 AV	54.0	-16.8	1.39 V	156	24.4	12.8

**REMARKS:**

1. Emission Level(dBuV/m) = Raw Value(dBuV) + Correction Factor(dB/m)
2. Correction Factor(dB/m) = Antenna Factor(dB/m) + Cable Factor(dB) – Pre-Amplifier Factor(dB)
3. The other emission levels were very low against the limit.
4. Margin value = Emission Level – Limit value
5. " \* ": Fundamental frequency.

<b>CHANNEL</b>	TX Channel 100	<b>DETECTOR FUNCTION</b>	Peak (PK)
<b>FREQUENCY RANGE</b>	1GHz ~ 40GHz		Average (AV)

**ANTENNA POLARITY & TEST DISTANCE: HORIZONTAL AT 3 M**

NO.	FREQ. (MHz)	EMISSION LEVEL (dBuV/m)	LIMIT (dBuV/m)	MARGIN (dB)	ANTENNA HEIGHT (m)	TABLE ANGLE (Degree)	RAW VALUE (dBuV)	CORRECTION FACTOR (dB/m)
1	#5470.00	64.2 PK	74.0	-9.8	1.00 H	175	60.3	3.9
2	#5470.00	53.7 AV	54.0	-0.3	1.00 H	175	49.8	3.9
3	*5500.00	113.7 PK			1.00 H	175	109.8	3.9
4	*5500.00	105.1 AV			1.00 H	175	101.2	3.9
5	11000.00	50.0 PK	74.0	-24.0	1.41 H	236	36.1	13.9
6	11000.00	39.6 AV	54.0	-14.4	1.41 H	236	25.7	13.9
7	#16500.00	50.3 PK	74.0	-23.7	1.56 H	294	35.0	15.3
8	#16500.00	39.0 AV	54.0	-15.0	1.56 H	294	23.7	15.3

**ANTENNA POLARITY & TEST DISTANCE: VERTICAL AT 3 M**

NO.	FREQ. (MHz)	EMISSION LEVEL (dBuV/m)	LIMIT (dBuV/m)	MARGIN (dB)	ANTENNA HEIGHT (m)	TABLE ANGLE (Degree)	RAW VALUE (dBuV)	CORRECTION FACTOR (dB/m)
1	#5470.00	63.8 PK	74.0	-10.2	2.95 V	158	59.9	3.9
2	#5470.00	52.3 AV	54.0	-1.7	2.95 V	158	48.4	3.9
3	*5500.00	113.4 PK			2.95 V	158	109.5	3.9
4	*5500.00	104.7 AV			2.95 V	158	100.8	3.9
5	11000.00	49.6 PK	74.0	-24.4	1.36 V	301	35.7	13.9
6	11000.00	38.8 AV	54.0	-15.2	1.36 V	301	24.9	13.9
7	#16500.00	48.1 PK	74.0	-25.9	1.41 V	158	32.8	15.3
8	#16500.00	37.4 AV	54.0	-16.6	1.41 V	158	22.1	15.3

**REMARKS:**

1. Emission Level(dBuV/m) = Raw Value(dBuV) + Correction Factor(dB/m)
2. Correction Factor(dB/m) = Antenna Factor(dB/m) + Cable Factor(dB) – Pre-Amplifier Factor(dB)
3. The other emission levels were very low against the limit.
4. Margin value = Emission Level – Limit value
5. " \* ": Fundamental frequency.
6. " # ": The radiated frequency is out of the restricted band.

<b>CHANNEL</b>	TX Channel 116	<b>DETECTOR FUNCTION</b>	Peak (PK)
<b>FREQUENCY RANGE</b>	1GHz ~ 40GHz		Average (AV)

**ANTENNA POLARITY & TEST DISTANCE: HORIZONTAL AT 3 M**

NO.	FREQ. (MHz)	EMISSION LEVEL (dBuV/m)	LIMIT (dBuV/m)	MARGIN (dB)	ANTENNA HEIGHT (m)	TABLE ANGLE (Degree)	RAW VALUE (dBuV)	CORRECTION FACTOR (dB/m)
1	*5580.00	115.5 PK			1.04 H	172	111.2	4.3
2	*5580.00	106.4 AV			1.04 H	172	102.1	4.3
3	11160.00	49.2 PK	74.0	-24.8	1.42 H	216	35.6	13.6
4	11160.00	38.9 AV	54.0	-15.1	1.42 H	216	25.3	13.6
5	#16740.00	50.2 PK	74.0	-23.8	1.54 H	293	33.5	16.7
6	#16740.00	38.7 AV	54.0	-15.3	1.54 H	293	22.0	16.7

**ANTENNA POLARITY & TEST DISTANCE: VERTICAL AT 3 M**

NO.	FREQ. (MHz)	EMISSION LEVEL (dBuV/m)	LIMIT (dBuV/m)	MARGIN (dB)	ANTENNA HEIGHT (m)	TABLE ANGLE (Degree)	RAW VALUE (dBuV)	CORRECTION FACTOR (dB/m)
1	*5580.00	115.3 PK			2.96 V	156	111.0	4.3
2	*5580.00	105.9 AV			2.96 V	156	101.6	4.3
3	11160.00	49.7 PK	74.0	-24.3	1.38 V	295	36.1	13.6
4	11160.00	39.1 AV	54.0	-14.9	1.38 V	295	25.5	13.6
5	#16740.00	48.6 PK	74.0	-25.4	1.40 V	148	31.9	16.7
6	#16740.00	38.1 AV	54.0	-15.9	1.40 V	148	21.4	16.7

**REMARKS:**

1. Emission Level(dBuV/m) = Raw Value(dBuV) + Correction Factor(dB/m)
2. Correction Factor(dB/m) = Antenna Factor(dB/m) + Cable Factor(dB) – Pre-Amplifier Factor(dB)
3. The other emission levels were very low against the limit.
4. Margin value = Emission Level – Limit value
5. " \* ": Fundamental frequency.
6. " # ": The radiated frequency is out of the restricted band.

<b>CHANNEL</b>	TX Channel 140	<b>DETECTOR FUNCTION</b>	Peak (PK)
<b>FREQUENCY RANGE</b>	1GHz ~ 40GHz		Average (AV)

**ANTENNA POLARITY & TEST DISTANCE: HORIZONTAL AT 3 M**

NO.	FREQ. (MHz)	EMISSION LEVEL (dBuV/m)	LIMIT (dBuV/m)	MARGIN (dB)	ANTENNA HEIGHT (m)	TABLE ANGLE (Degree)	RAW VALUE (dBuV)	CORRECTION FACTOR (dB/m)
1	*5700.00	112.3 PK			1.07 H	173	107.8	4.5
2	*5700.00	103.4 AV			1.07 H	173	98.9	4.5
3	#5725.00	66.4 PK	74.0	-7.6	1.07 H	173	62.0	4.4
4	<b>#5725.00</b>	<b>53.9 AV</b>	<b>54.0</b>	<b>-0.1</b>	<b>1.07 H</b>	<b>173</b>	<b>49.5</b>	<b>4.4</b>
5	11400.00	47.3 PK	74.0	-26.7	1.24 H	348	33.2	14.1
6	11400.00	36.8 AV	54.0	-17.2	1.24 H	348	22.7	14.1
7	#17100.00	54.2 PK	74.0	-19.8	2.02 H	167	37.7	16.5
8	#17100.00	41.8 AV	54.0	-12.2	2.02 H	167	25.3	16.5

**ANTENNA POLARITY & TEST DISTANCE: VERTICAL AT 3 M**

NO.	FREQ. (MHz)	EMISSION LEVEL (dBuV/m)	LIMIT (dBuV/m)	MARGIN (dB)	ANTENNA HEIGHT (m)	TABLE ANGLE (Degree)	RAW VALUE (dBuV)	CORRECTION FACTOR (dB/m)
1	*5700.00	109.9 PK			2.35 V	9	105.4	4.5
2	*5700.00	100.8 AV			2.35 V	9	96.3	4.5
3	11400.00	46.8 PK	74.0	-27.2	1.30 V	352	32.7	14.1
4	11400.00	35.6 AV	54.0	-18.4	1.30 V	352	21.5	14.1
5	#17100.00	53.9 PK	74.0	-20.1	2.09 V	141	37.4	16.5
6	#17100.00	41.9 AV	54.0	-12.1	2.09 V	141	25.4	16.5

**REMARKS:**

1. Emission Level(dBuV/m) = Raw Value(dBuV) + Correction Factor(dB/m)
2. Correction Factor(dB/m) = Antenna Factor(dB/m) + Cable Factor(dB) – Pre-Amplifier Factor(dB)
3. The other emission levels were very low against the limit.
4. Margin value = Emission Level – Limit value
5. " \* ": Fundamental frequency.
6. " # ": The radiated frequency is out of the restricted band.

<b>CHANNEL</b>	TX Channel 149	<b>DETECTOR FUNCTION</b>	Peak (PK)
<b>FREQUENCY RANGE</b>	1GHz ~ 40GHz		Average (AV)

**ANTENNA POLARITY & TEST DISTANCE: HORIZONTAL AT 3 M**

NO.	FREQ. (MHz)	EMISSION LEVEL (dBuV/m)	LIMIT (dBuV/m)	MARGIN (dB)	ANTENNA HEIGHT (m)	TABLE ANGLE (Degree)	RAW VALUE (dBuV)	CORRECTION FACTOR (dB/m)
1	*5745.00	113.5 PK			1.14 H	177	109.2	4.3
2	*5745.00	104.1 AV			1.14 H	177	99.8	4.3
3	11490.00	46.6 PK	74.0	-27.4	1.15 H	349	32.6	14.0
4	11490.00	36.2 AV	54.0	-17.8	1.15 H	349	22.2	14.0
5	#17235.00	54.7 PK	74.0	-19.3	2.01 H	162	37.8	16.9
6	#17235.00	42.2 AV	54.0	-11.8	2.01 H	162	25.3	16.9

**ANTENNA POLARITY & TEST DISTANCE: VERTICAL AT 3 M**

NO.	FREQ. (MHz)	EMISSION LEVEL (dBuV/m)	LIMIT (dBuV/m)	MARGIN (dB)	ANTENNA HEIGHT (m)	TABLE ANGLE (Degree)	RAW VALUE (dBuV)	CORRECTION FACTOR (dB/m)
1	*5745.00	111.1 PK			2.37 V	18	106.8	4.3
2	*5745.00	101.5 AV			2.37 V	18	97.2	4.3
3	11490.00	47.0 PK	74.0	-27.0	1.32 V	356	33.0	14.0
4	11490.00	35.7 AV	54.0	-18.3	1.32 V	356	21.7	14.0
5	#17235.00	53.7 PK	74.0	-20.3	2.01 V	142	36.8	16.9
6	#17235.00	41.7 AV	54.0	-12.3	2.01 V	142	24.8	16.9

**REMARKS:**

1. Emission Level(dBuV/m) = Raw Value(dBuV) + Correction Factor(dB/m)
2. Correction Factor(dB/m) = Antenna Factor(dB/m) + Cable Factor(dB) – Pre-Amplifier Factor(dB)
3. The other emission levels were very low against the limit.
4. Margin value = Emission Level – Limit value
5. " \* ": Fundamental frequency.
6. " # ": The radiated frequency is out of the restricted band.

<b>CHANNEL</b>	TX Channel 157	<b>DETECTOR FUNCTION</b>	Peak (PK)
<b>FREQUENCY RANGE</b>	1GHz ~ 40GHz		Average (AV)

**ANTENNA POLARITY & TEST DISTANCE: HORIZONTAL AT 3 M**

NO.	FREQ. (MHz)	EMISSION LEVEL (dBuV/m)	LIMIT (dBuV/m)	MARGIN (dB)	ANTENNA HEIGHT (m)	TABLE ANGLE (Degree)	RAW VALUE (dBuV)	CORRECTION FACTOR (dB/m)
1	*5785.00	112.7 PK			1.18 H	174	108.4	4.3
2	*5785.00	103.9 AV			1.18 H	174	99.6	4.3
3	11570.00	46.7 PK	74.0	-27.3	1.16 H	351	32.7	14.0
4	11570.00	36.2 AV	54.0	-17.8	1.16 H	351	22.2	14.0
5	#17355.00	55.5 PK	74.0	-18.5	1.99 H	145	38.2	17.3
6	#17355.00	42.6 AV	54.0	-11.4	1.99 H	145	25.3	17.3

**ANTENNA POLARITY & TEST DISTANCE: VERTICAL AT 3 M**

NO.	FREQ. (MHz)	EMISSION LEVEL (dBuV/m)	LIMIT (dBuV/m)	MARGIN (dB)	ANTENNA HEIGHT (m)	TABLE ANGLE (Degree)	RAW VALUE (dBuV)	CORRECTION FACTOR (dB/m)
1	*5785.00	110.9 PK			2.41 V	11	106.6	4.3
2	*5785.00	101.8 AV			2.41 V	11	97.5	4.3
3	11570.00	46.4 PK	74.0	-27.6	1.24 V	351	32.4	14.0
4	11570.00	35.4 AV	54.0	-18.6	1.24 V	351	21.4	14.0
5	#17355.00	53.3 PK	74.0	-20.7	2.06 V	149	36.0	17.3
6	#17355.00	41.5 AV	54.0	-12.5	2.06 V	149	24.2	17.3

**REMARKS:**

1. Emission Level(dBuV/m) = Raw Value(dBuV) + Correction Factor(dB/m)
2. Correction Factor(dB/m) = Antenna Factor(dB/m) + Cable Factor(dB) – Pre-Amplifier Factor(dB)
3. The other emission levels were very low against the limit.
4. Margin value = Emission Level – Limit value
5. " \* ": Fundamental frequency.
6. " # ": The radiated frequency is out of the restricted band.

<b>CHANNEL</b>	TX Channel 165	<b>DETECTOR FUNCTION</b>	Peak (PK)
<b>FREQUENCY RANGE</b>	1GHz ~ 40GHz		Average (AV)

**ANTENNA POLARITY & TEST DISTANCE: HORIZONTAL AT 3 M**

NO.	FREQ. (MHz)	EMISSION LEVEL (dBuV/m)	LIMIT (dBuV/m)	MARGIN (dB)	ANTENNA HEIGHT (m)	TABLE ANGLE (Degree)	RAW VALUE (dBuV)	CORRECTION FACTOR (dB/m)
1	*5825.00	112.4 PK			1.02 H	169	108.0	4.4
2	*5825.00	103.4 AV			1.02 H	169	99.0	4.4
3	11650.00	47.2 PK	74.0	-26.8	1.21 H	351	33.3	13.9
4	11650.00	36.6 AV	54.0	-17.4	1.21 H	351	22.7	13.9
5	#17475.00	54.9 PK	74.0	-19.1	2.00 H	155	36.7	18.2
6	#17475.00	42.2 AV	54.0	-11.8	2.00 H	155	24.0	18.2

**ANTENNA POLARITY & TEST DISTANCE: VERTICAL AT 3 M**

NO.	FREQ. (MHz)	EMISSION LEVEL (dBuV/m)	LIMIT (dBuV/m)	MARGIN (dB)	ANTENNA HEIGHT (m)	TABLE ANGLE (Degree)	RAW VALUE (dBuV)	CORRECTION FACTOR (dB/m)
1	*5825.00	110.7 PK			2.33 V	1	106.3	4.4
2	*5825.00	101.2 AV			2.33 V	1	96.8	4.4
3	11650.00	46.6 PK	74.0	-27.4	1.26 V	354	32.7	13.9
4	11650.00	35.5 AV	54.0	-18.5	1.26 V	354	21.6	13.9
5	#17475.00	53.6 PK	74.0	-20.4	2.04 V	157	35.4	18.2
6	#17475.00	41.6 AV	54.0	-12.4	2.04 V	157	23.4	18.2

**REMARKS:**

1. Emission Level(dBuV/m) = Raw Value(dBuV) + Correction Factor(dB/m)
2. Correction Factor(dB/m) = Antenna Factor(dB/m) + Cable Factor(dB) – Pre-Amplifier Factor(dB)
3. The other emission levels were very low against the limit.
4. Margin value = Emission Level – Limit value
5. " \* ": Fundamental frequency.
6. " # ": The radiated frequency is out of the restricted band.



**802.11ac (VHT20)**

<b>CHANNEL</b>	TX Channel 36	<b>DETECTOR FUNCTION</b>	Peak (PK)
<b>FREQUENCY RANGE</b>	1GHz ~ 40GHz		Average (AV)

**ANTENNA POLARITY & TEST DISTANCE: HORIZONTAL AT 3 M**

NO.	FREQ. (MHz)	EMISSION LEVEL (dBuV/m)	LIMIT (dBuV/m)	MARGIN (dB)	ANTENNA HEIGHT (m)	TABLE ANGLE (Degree)	RAW VALUE (dBuV)	CORRECTION FACTOR (dB/m)
1	5150.00	61.1 PK	74.0	-12.9	1.02 H	169	57.0	4.1
2	5150.00	53.7 AV	54.0	-0.3	1.02 H	169	49.6	4.1
3	*5180.00	111.7 PK			1.02 H	169	107.9	3.8
4	*5180.00	105.1 AV			1.02 H	169	101.3	3.8
5	#10360.00	49.1 PK	74.0	-24.9	1.51 H	223	36.0	13.1
6	#10360.00	38.7 AV	54.0	-15.3	1.51 H	223	25.6	13.1
7	15540.00	49.9 PK	74.0	-24.1	1.64 H	282	36.8	13.1
8	15540.00	38.2 AV	54.0	-15.8	1.64 H	282	25.1	13.1

**ANTENNA POLARITY & TEST DISTANCE: VERTICAL AT 3 M**

NO.	FREQ. (MHz)	EMISSION LEVEL (dBuV/m)	LIMIT (dBuV/m)	MARGIN (dB)	ANTENNA HEIGHT (m)	TABLE ANGLE (Degree)	RAW VALUE (dBuV)	CORRECTION FACTOR (dB/m)
1	5150.00	60.6 PK	74.0	-13.4	3.08 V	105	56.5	4.1
2	5150.00	52.3 AV	54.0	-1.7	3.08 V	105	48.2	4.1
3	*5180.00	110.8 PK			3.08 V	105	107.0	3.8
4	*5180.00	104.5 AV			3.08 V	105	100.7	3.8
5	#10360.00	50.6 PK	74.0	-23.4	1.51 V	319	37.5	13.1
6	#10360.00	39.3 AV	54.0	-14.7	1.51 V	319	26.2	13.1
7	15540.00	49.4 PK	74.0	-24.6	1.33 V	124	36.3	13.1
8	15540.00	38.3 AV	54.0	-15.7	1.33 V	124	25.2	13.1

**REMARKS:**

- Emission Level(dBuV/m) = Raw Value(dBuV) + Correction Factor(dB/m)
- Correction Factor(dB/m) = Antenna Factor(dB/m) + Cable Factor(dB) – Pre-Amplifier Factor(dB)
- The other emission levels were very low against the limit.
- Margin value = Emission Level – Limit value
- " \* ": Fundamental frequency.
- " # ": The radiated frequency is out of the restricted band.

<b>CHANNEL</b>	TX Channel 40	<b>DETECTOR FUNCTION</b>	Peak (PK)
<b>FREQUENCY RANGE</b>	1GHz ~ 40GHz		Average (AV)

**ANTENNA POLARITY & TEST DISTANCE: HORIZONTAL AT 3 M**

NO.	FREQ. (MHz)	EMISSION LEVEL (dBuV/m)	LIMIT (dBuV/m)	MARGIN (dB)	ANTENNA HEIGHT (m)	TABLE ANGLE (Degree)	RAW VALUE (dBuV)	CORRECTION FACTOR (dB/m)
1	*5200.00	113.1 PK			1.15 H	180	109.4	3.7
2	*5200.00	106.3 AV			1.15 H	180	102.6	3.7
3	#10400.00	48.8 PK	74.0	-25.2	1.45 H	221	35.7	13.1
4	#10400.00	38.9 AV	54.0	-15.1	1.45 H	221	25.8	13.1
5	15600.00	49.8 PK	74.0	-24.2	1.59 H	284	36.8	13.0
6	15600.00	38.5 AV	54.0	-15.5	1.59 H	284	25.5	13.0

**ANTENNA POLARITY & TEST DISTANCE: VERTICAL AT 3 M**

NO.	FREQ. (MHz)	EMISSION LEVEL (dBuV/m)	LIMIT (dBuV/m)	MARGIN (dB)	ANTENNA HEIGHT (m)	TABLE ANGLE (Degree)	RAW VALUE (dBuV)	CORRECTION FACTOR (dB/m)
1	*5200.00	112.9 PK			3.09 V	99	109.2	3.7
2	*5200.00	105.6 AV			3.09 V	99	101.9	3.7
3	#10400.00	49.7 PK	74.0	-24.3	1.45 V	303	36.6	13.1
4	#10400.00	38.6 AV	54.0	-15.4	1.45 V	303	25.5	13.1
5	15600.00	48.6 PK	74.0	-25.4	1.36 V	121	35.6	13.0
6	15600.00	38.0 AV	54.0	-16.0	1.36 V	121	25.0	13.0

**REMARKS:**

1. Emission Level(dBuV/m) = Raw Value(dBuV) + Correction Factor(dB/m)
2. Correction Factor(dB/m) = Antenna Factor(dB/m) + Cable Factor(dB) – Pre-Amplifier Factor(dB)
3. The other emission levels were very low against the limit.
4. Margin value = Emission Level – Limit value
5. " \* ": Fundamental frequency.
6. " # ": The radiated frequency is out of the restricted band.

<b>CHANNEL</b>	TX Channel 48	<b>DETECTOR FUNCTION</b>	Peak (PK)
<b>FREQUENCY RANGE</b>	1GHz ~ 40GHz		Average (AV)

**ANTENNA POLARITY & TEST DISTANCE: HORIZONTAL AT 3 M**

NO.	FREQ. (MHz)	EMISSION LEVEL (dBuV/m)	LIMIT (dBuV/m)	MARGIN (dB)	ANTENNA HEIGHT (m)	TABLE ANGLE (Degree)	RAW VALUE (dBuV)	CORRECTION FACTOR (dB/m)
1	*5240.00	112.7 PK			1.06 H	174	109.2	3.5
2	*5240.00	105.7 AV			1.06 H	174	102.2	3.5
3	5350.00	50.1 PK	74.0	-23.9	1.06 H	174	46.5	3.6
4	5350.00	41.3 AV	54.0	-12.7	1.06 H	174	37.7	3.6
5	#10480.00	48.9 PK	74.0	-25.1	1.47 H	210	35.4	13.5
6	#10480.00	38.8 AV	54.0	-15.2	1.47 H	210	25.3	13.5
7	15720.00	49.6 PK	74.0	-24.4	1.62 H	292	36.8	12.8
8	15720.00	37.9 AV	54.0	-16.1	1.62 H	292	25.1	12.8

**ANTENNA POLARITY & TEST DISTANCE: VERTICAL AT 3 M**

NO.	FREQ. (MHz)	EMISSION LEVEL (dBuV/m)	LIMIT (dBuV/m)	MARGIN (dB)	ANTENNA HEIGHT (m)	TABLE ANGLE (Degree)	RAW VALUE (dBuV)	CORRECTION FACTOR (dB/m)
1	*5240.00	111.9 PK			3.13 V	115	108.4	3.5
2	*5240.00	104.8 AV			3.13 V	115	101.3	3.5
3	5350.00	48.9 PK	74.0	-25.1	3.13 V	115	45.3	3.6
4	5350.00	40.6 AV	54.0	-13.4	3.13 V	115	37.0	3.6
5	#10480.00	50.4 PK	74.0	-23.6	1.47 V	303	36.9	13.5
6	#10480.00	39.4 AV	54.0	-14.6	1.47 V	303	25.9	13.5
7	15720.00	49.5 PK	74.0	-24.5	1.37 V	145	36.7	12.8
8	15720.00	38.5 AV	54.0	-15.5	1.37 V	145	25.7	12.8

**REMARKS:**

1. Emission Level(dBuV/m) = Raw Value(dBuV) + Correction Factor(dB/m)
2. Correction Factor(dB/m) = Antenna Factor(dB/m) + Cable Factor(dB) – Pre-Amplifier Factor(dB)
3. The other emission levels were very low against the limit.
4. Margin value = Emission Level – Limit value
5. " \* ": Fundamental frequency.
6. " # ": The radiated frequency is out of the restricted band.

<b>CHANNEL</b>	TX Channel 52	<b>DETECTOR FUNCTION</b>	Peak (PK)
<b>FREQUENCY RANGE</b>	1GHz ~ 40GHz		Average (AV)

**ANTENNA POLARITY & TEST DISTANCE: HORIZONTAL AT 3 M**

NO.	FREQ. (MHz)	EMISSION LEVEL (dBuV/m)	LIMIT (dBuV/m)	MARGIN (dB)	ANTENNA HEIGHT (m)	TABLE ANGLE (Degree)	RAW VALUE (dBuV)	CORRECTION FACTOR (dB/m)
1	5150.00	50.1 PK	74.0	-23.9	1.07 H	174	46.0	4.1
2	5150.00	39.2 AV	54.0	-14.8	1.07 H	174	35.1	4.1
3	*5260.00	115.9 PK			1.07 H	174	112.5	3.4
4	*5260.00	106.2 AV			1.07 H	174	102.8	3.4
5	#10520.00	49.6 PK	74.0	-24.4	1.51 H	209	36.2	13.4
6	#10520.00	39.6 AV	54.0	-14.4	1.51 H	209	26.2	13.4
7	15780.00	49.4 PK	74.0	-24.6	1.59 H	285	36.5	12.9
8	15780.00	38.1 AV	54.0	-15.9	1.59 H	285	25.2	12.9

**ANTENNA POLARITY & TEST DISTANCE: VERTICAL AT 3 M**

NO.	FREQ. (MHz)	EMISSION LEVEL (dBuV/m)	LIMIT (dBuV/m)	MARGIN (dB)	ANTENNA HEIGHT (m)	TABLE ANGLE (Degree)	RAW VALUE (dBuV)	CORRECTION FACTOR (dB/m)
1	5150.00	49.8 PK	74.0	-24.2	3.17 V	129	45.7	4.1
2	5150.00	38.4 AV	54.0	-15.6	3.17 V	129	34.3	4.1
3	*5260.00	115.4 PK			3.17 V	129	112.0	3.4
4	*5260.00	105.6 AV			3.17 V	129	102.2	3.4
5	#10520.00	50.3 PK	74.0	-23.7	1.50 V	313	36.9	13.4
6	#10520.00	39.4 AV	54.0	-14.6	1.50 V	313	26.0	13.4
7	15780.00	48.5 PK	74.0	-25.5	1.41 V	146	35.6	12.9
8	15780.00	37.8 AV	54.0	-16.2	1.41 V	146	24.9	12.9

**REMARKS:**

1. Emission Level(dBuV/m) = Raw Value(dBuV) + Correction Factor(dB/m)
2. Correction Factor(dB/m) = Antenna Factor(dB/m) + Cable Factor(dB) – Pre-Amplifier Factor(dB)
3. The other emission levels were very low against the limit.
4. Margin value = Emission Level – Limit value
5. " \* ": Fundamental frequency.
6. " # ": The radiated frequency is out of the restricted band.

<b>CHANNEL</b>	TX Channel 60	<b>DETECTOR FUNCTION</b>	Peak (PK)
<b>FREQUENCY RANGE</b>	1GHz ~ 40GHz		Average (AV)

**ANTENNA POLARITY & TEST DISTANCE: HORIZONTAL AT 3 M**

NO.	FREQ. (MHz)	EMISSION LEVEL (dBuV/m)	LIMIT (dBuV/m)	MARGIN (dB)	ANTENNA HEIGHT (m)	TABLE ANGLE (Degree)	RAW VALUE (dBuV)	CORRECTION FACTOR (dB/m)
1	*5300.00	114.1 PK			1.09 H	170	110.6	3.5
2	*5300.00	105.6 AV			1.09 H	170	102.1	3.5
3	10600.00	48.5 PK	74.0	-25.5	1.49 H	217	35.7	12.8
4	10600.00	38.7 AV	54.0	-15.3	1.49 H	217	25.9	12.8
5	15900.00	50.2 PK	74.0	-23.8	1.64 H	270	37.5	12.7
6	15900.00	38.7 AV	54.0	-15.3	1.64 H	270	26.0	12.7

**ANTENNA POLARITY & TEST DISTANCE: VERTICAL AT 3 M**

NO.	FREQ. (MHz)	EMISSION LEVEL (dBuV/m)	LIMIT (dBuV/m)	MARGIN (dB)	ANTENNA HEIGHT (m)	TABLE ANGLE (Degree)	RAW VALUE (dBuV)	CORRECTION FACTOR (dB/m)
1	*5300.00	113.8 PK			3.22 V	136	110.3	3.5
2	*5300.00	105.4 AV			3.22 V	136	101.9	3.5
3	10600.00	50.6 PK	74.0	-23.4	1.51 V	303	37.8	12.8
4	10600.00	39.3 AV	54.0	-14.7	1.51 V	303	26.5	12.8
5	15900.00	49.0 PK	74.0	-25.0	1.38 V	140	36.3	12.7
6	15900.00	38.3 AV	54.0	-15.7	1.38 V	140	25.6	12.7

**REMARKS:**

1. Emission Level(dBuV/m) = Raw Value(dBuV) + Correction Factor(dB/m)
2. Correction Factor(dB/m) = Antenna Factor(dB/m) + Cable Factor(dB) – Pre-Amplifier Factor(dB)
3. The other emission levels were very low against the limit.
4. Margin value = Emission Level – Limit value
5. " \* ": Fundamental frequency.

<b>CHANNEL</b>	TX Channel 64	<b>DETECTOR FUNCTION</b>	Peak (PK)
<b>FREQUENCY RANGE</b>	1GHz ~ 40GHz		Average (AV)

**ANTENNA POLARITY & TEST DISTANCE: HORIZONTAL AT 3 M**

NO.	FREQ. (MHz)	EMISSION LEVEL (dBuV/m)	LIMIT (dBuV/m)	MARGIN (dB)	ANTENNA HEIGHT (m)	TABLE ANGLE (Degree)	RAW VALUE (dBuV)	CORRECTION FACTOR (dB/m)
1	*5320.00	113.2 PK			1.05 H	176	109.7	3.5
2	*5320.00	104.9 AV			1.05 H	176	101.4	3.5
3	5350.00	67.6 PK	74.0	-6.4	1.05 H	176	64.0	3.6
4	5350.00	53.7 AV	54.0	-0.3	1.05 H	176	50.1	3.6
5	10640.00	49.6 PK	74.0	-24.4	1.52 H	232	36.6	13.0
6	10640.00	39.5 AV	54.0	-14.5	1.52 H	232	26.5	13.0
7	15960.00	49.3 PK	74.0	-24.7	1.54 H	277	36.5	12.8
8	15960.00	37.8 AV	54.0	-16.2	1.54 H	277	25.0	12.8

**ANTENNA POLARITY & TEST DISTANCE: VERTICAL AT 3 M**

NO.	FREQ. (MHz)	EMISSION LEVEL (dBuV/m)	LIMIT (dBuV/m)	MARGIN (dB)	ANTENNA HEIGHT (m)	TABLE ANGLE (Degree)	RAW VALUE (dBuV)	CORRECTION FACTOR (dB/m)
1	*5320.00	112.9 PK			3.22 V	133	109.4	3.5
2	*5320.00	103.8 AV			3.22 V	133	100.3	3.5
3	5350.00	66.8 PK	74.0	-7.2	3.22 V	133	63.2	3.6
4	5350.00	52.6 AV	54.0	-1.4	3.22 V	133	49.0	3.6
5	10640.00	49.6 PK	74.0	-24.4	1.50 V	316	36.6	13.0
6	10640.00	38.7 AV	54.0	-15.3	1.50 V	316	25.7	13.0
7	15960.00	49.4 PK	74.0	-24.6	1.33 V	135	36.6	12.8
8	15960.00	38.4 AV	54.0	-15.6	1.33 V	135	25.6	12.8

**REMARKS:**

1. Emission Level(dBuV/m) = Raw Value(dBuV) + Correction Factor(dB/m)
2. Correction Factor(dB/m) = Antenna Factor(dB/m) + Cable Factor(dB) – Pre-Amplifier Factor(dB)
3. The other emission levels were very low against the limit.
4. Margin value = Emission Level – Limit value
5. " \* ": Fundamental frequency.

<b>CHANNEL</b>	TX Channel 100	<b>DETECTOR FUNCTION</b>	Peak (PK)
<b>FREQUENCY RANGE</b>	1GHz ~ 40GHz		Average (AV)

**ANTENNA POLARITY & TEST DISTANCE: HORIZONTAL AT 3 M**

NO.	FREQ. (MHz)	EMISSION LEVEL (dBuV/m)	LIMIT (dBuV/m)	MARGIN (dB)	ANTENNA HEIGHT (m)	TABLE ANGLE (Degree)	RAW VALUE (dBuV)	CORRECTION FACTOR (dB/m)
1	#5470.00	67.1 PK	74.0	-6.9	1.04 H	178	63.2	3.9
2	#5470.00	53.6 AV	54.0	-0.4	1.04 H	178	49.7	3.9
3	*5500.00	113.7 PK			1.04 H	178	109.8	3.9
4	*5500.00	104.9 AV			1.04 H	178	101.0	3.9
5	11000.00	49.1 PK	74.0	-24.9	1.54 H	213	35.2	13.9
6	11000.00	39.2 AV	54.0	-14.8	1.54 H	213	25.3	13.9
7	#16500.00	49.8 PK	74.0	-24.2	1.54 H	270	34.5	15.3
8	#16500.00	38.5 AV	54.0	-15.5	1.54 H	270	23.2	15.3

**ANTENNA POLARITY & TEST DISTANCE: VERTICAL AT 3 M**

NO.	FREQ. (MHz)	EMISSION LEVEL (dBuV/m)	LIMIT (dBuV/m)	MARGIN (dB)	ANTENNA HEIGHT (m)	TABLE ANGLE (Degree)	RAW VALUE (dBuV)	CORRECTION FACTOR (dB/m)
1	#5470.00	66.4 PK	74.0	-7.6	3.26 V	128	62.5	3.9
2	#5470.00	51.8 AV	54.0	-2.2	3.26 V	128	47.9	3.9
3	*5500.00	113.4 PK			3.26 V	128	109.5	3.9
4	*5500.00	103.8 AV			3.26 V	128	99.9	3.9
5	11000.00	49.9 PK	74.0	-24.1	1.48 V	307	36.0	13.9
6	11000.00	38.8 AV	54.0	-15.2	1.48 V	307	24.9	13.9
7	#16500.00	49.4 PK	74.0	-24.6	1.36 V	151	34.1	15.3
8	#16500.00	38.4 AV	54.0	-15.6	1.36 V	151	23.1	15.3

**REMARKS:**

1. Emission Level(dBuV/m) = Raw Value(dBuV) + Correction Factor(dB/m)
2. Correction Factor(dB/m) = Antenna Factor(dB/m) + Cable Factor(dB) – Pre-Amplifier Factor(dB)
3. The other emission levels were very low against the limit.
4. Margin value = Emission Level – Limit value
5. " \* ": Fundamental frequency.
6. " # ": The radiated frequency is out of the restricted band.

<b>CHANNEL</b>	TX Channel 116	<b>DETECTOR FUNCTION</b>	Peak (PK)
<b>FREQUENCY RANGE</b>	1GHz ~ 40GHz		Average (AV)

**ANTENNA POLARITY & TEST DISTANCE: HORIZONTAL AT 3 M**

NO.	FREQ. (MHz)	EMISSION LEVEL (dBuV/m)	LIMIT (dBuV/m)	MARGIN (dB)	ANTENNA HEIGHT (m)	TABLE ANGLE (Degree)	RAW VALUE (dBuV)	CORRECTION FACTOR (dB/m)
1	*5580.00	114.8 PK			1.10 H	174	110.5	4.3
2	*5580.00	105.1 AV			1.10 H	174	100.8	4.3
3	11160.00	49.7 PK	74.0	-24.3	1.46 H	230	36.1	13.6
4	11160.00	39.4 AV	54.0	-14.6	1.46 H	230	25.8	13.6
5	#16740.00	49.6 PK	74.0	-24.4	1.55 H	269	32.9	16.7
6	#16740.00	38.2 AV	54.0	-15.8	1.55 H	269	21.5	16.7

**ANTENNA POLARITY & TEST DISTANCE: VERTICAL AT 3 M**

NO.	FREQ. (MHz)	EMISSION LEVEL (dBuV/m)	LIMIT (dBuV/m)	MARGIN (dB)	ANTENNA HEIGHT (m)	TABLE ANGLE (Degree)	RAW VALUE (dBuV)	CORRECTION FACTOR (dB/m)
1	*5580.00	113.9 PK			3.20 V	126	109.6	4.3
2	*5580.00	104.9 AV			3.20 V	126	100.6	4.3
3	11160.00	49.9 PK	74.0	-24.1	1.42 V	318	36.3	13.6
4	11160.00	38.6 AV	54.0	-15.4	1.42 V	318	25.0	13.6
5	#16740.00	49.5 PK	74.0	-24.5	1.44 V	129	32.8	16.7
6	#16740.00	38.3 AV	54.0	-15.7	1.44 V	129	21.6	16.7

**REMARKS:**

1. Emission Level(dBuV/m) = Raw Value(dBuV) + Correction Factor(dB/m)
2. Correction Factor(dB/m) = Antenna Factor(dB/m) + Cable Factor(dB) – Pre-Amplifier Factor(dB)
3. The other emission levels were very low against the limit.
4. Margin value = Emission Level – Limit value
5. " \* ": Fundamental frequency.
6. " # ": The radiated frequency is out of the restricted band.



<b>CHANNEL</b>	TX Channel 140	<b>DETECTOR FUNCTION</b>	Peak (PK)
<b>FREQUENCY RANGE</b>	1GHz ~ 40GHz		Average (AV)

**ANTENNA POLARITY & TEST DISTANCE: HORIZONTAL AT 3 M**

NO.	FREQ. (MHz)	EMISSION LEVEL (dBuV/m)	LIMIT (dBuV/m)	MARGIN (dB)	ANTENNA HEIGHT (m)	TABLE ANGLE (Degree)	RAW VALUE (dBuV)	CORRECTION FACTOR (dB/m)
1	*5700.00	112.9 PK			1.06 H	170	108.4	4.5
2	*5700.00	103.8 AV			1.06 H	170	99.3	4.5
3	#5725.00	66.6 PK	74.0	-7.4	1.06 H	170	62.2	4.4
4	#5725.00	53.7 AV	54.0	-0.3	1.06 H	170	49.3	4.4
5	11400.00	48.0 PK	74.0	-26.0	1.24 H	360	33.9	14.1
6	11400.00	37.2 AV	54.0	-16.8	1.24 H	360	23.1	14.1
7	#17100.00	53.8 PK	74.0	-20.2	2.01 H	174	37.3	16.5
8	#17100.00	41.6 AV	54.0	-12.4	2.01 H	174	25.1	16.5

**ANTENNA POLARITY & TEST DISTANCE: VERTICAL AT 3 M**

NO.	FREQ. (MHz)	EMISSION LEVEL (dBuV/m)	LIMIT (dBuV/m)	MARGIN (dB)	ANTENNA HEIGHT (m)	TABLE ANGLE (Degree)	RAW VALUE (dBuV)	CORRECTION FACTOR (dB/m)
1	*5700.00	109.8 PK			2.54 V	16	105.3	4.5
2	*5700.00	100.1 AV			2.54 V	16	95.6	4.5
3	#5725.00	65.9 PK	74.0	-8.1	2.54 V	16	61.5	4.4
4	#5725.00	51.9 AV	54.0	-2.1	2.54 V	16	47.5	4.4
5	11400.00	47.1 PK	74.0	-26.9	1.34 V	344	33.0	14.1
6	11400.00	35.7 AV	54.0	-18.3	1.34 V	344	21.6	14.1
7	#17100.00	53.7 PK	74.0	-20.3	2.13 V	125	37.2	16.5
8	#17100.00	41.5 AV	54.0	-12.5	2.13 V	125	25.0	16.5

**REMARKS:**

1. Emission Level(dBuV/m) = Raw Value(dBuV) + Correction Factor(dB/m)
2. Correction Factor(dB/m) = Antenna Factor(dB/m) + Cable Factor(dB) – Pre-Amplifier Factor(dB)
3. The other emission levels were very low against the limit.
4. Margin value = Emission Level – Limit value
5. " \* ": Fundamental frequency.
6. " # ": The radiated frequency is out of the restricted band.

<b>CHANNEL</b>	TX Channel 149	<b>DETECTOR FUNCTION</b>	Peak (PK)
<b>FREQUENCY RANGE</b>	1GHz ~ 40GHz		Average (AV)

**ANTENNA POLARITY & TEST DISTANCE: HORIZONTAL AT 3 M**

NO.	FREQ. (MHz)	EMISSION LEVEL (dBuV/m)	LIMIT (dBuV/m)	MARGIN (dB)	ANTENNA HEIGHT (m)	TABLE ANGLE (Degree)	RAW VALUE (dBuV)	CORRECTION FACTOR (dB/m)
1	*5745.00	113.3 PK			1.02 H	181	109.0	4.3
2	*5745.00	103.7 AV			1.02 H	181	99.4	4.3
3	11490.00	47.9 PK	74.0	-26.1	1.26 H	352	33.9	14.0
4	11490.00	37.3 AV	54.0	-16.7	1.26 H	352	23.3	14.0
5	#17235.00	54.5 PK	74.0	-19.5	2.04 H	176	37.6	16.9
6	#17235.00	42.0 AV	54.0	-12.0	2.04 H	176	25.1	16.9

**ANTENNA POLARITY & TEST DISTANCE: VERTICAL AT 3 M**

NO.	FREQ. (MHz)	EMISSION LEVEL (dBuV/m)	LIMIT (dBuV/m)	MARGIN (dB)	ANTENNA HEIGHT (m)	TABLE ANGLE (Degree)	RAW VALUE (dBuV)	CORRECTION FACTOR (dB/m)
1	*5745.00	110.4 PK			2.52 V	19	106.1	4.3
2	*5745.00	100.2 AV			2.52 V	19	95.9	4.3
3	11490.00	46.9 PK	74.0	-27.1	1.35 V	347	32.9	14.0
4	11490.00	35.9 AV	54.0	-18.1	1.35 V	347	21.9	14.0
5	#17235.00	54.4 PK	74.0	-19.6	2.10 V	155	37.5	16.9
6	#17235.00	42.3 AV	54.0	-11.7	2.10 V	155	25.4	16.9

**REMARKS:**

1. Emission Level(dBuV/m) = Raw Value(dBuV) + Correction Factor(dB/m)
2. Correction Factor(dB/m) = Antenna Factor(dB/m) + Cable Factor(dB) – Pre-Amplifier Factor(dB)
3. The other emission levels were very low against the limit.
4. Margin value = Emission Level – Limit value
5. " \* ": Fundamental frequency.
6. " # ": The radiated frequency is out of the restricted band.

<b>CHANNEL</b>	TX Channel 157	<b>DETECTOR FUNCTION</b>	Peak (PK)
<b>FREQUENCY RANGE</b>	1GHz ~ 40GHz		Average (AV)

**ANTENNA POLARITY & TEST DISTANCE: HORIZONTAL AT 3 M**

NO.	FREQ. (MHz)	EMISSION LEVEL (dBuV/m)	LIMIT (dBuV/m)	MARGIN (dB)	ANTENNA HEIGHT (m)	TABLE ANGLE (Degree)	RAW VALUE (dBuV)	CORRECTION FACTOR (dB/m)
1	*5785.00	113.0 PK			1.06 H	173	108.7	4.3
2	*5785.00	103.4 AV			1.06 H	173	99.1	4.3
3	11570.00	47.4 PK	74.0	-26.6	1.29 H	358	33.4	14.0
4	11570.00	36.8 AV	54.0	-17.2	1.29 H	358	22.8	14.0
5	#17355.00	54.1 PK	74.0	-19.9	2.08 H	182	36.8	17.3
6	#17355.00	41.5 AV	54.0	-12.5	2.08 H	182	24.2	17.3

**ANTENNA POLARITY & TEST DISTANCE: VERTICAL AT 3 M**

NO.	FREQ. (MHz)	EMISSION LEVEL (dBuV/m)	LIMIT (dBuV/m)	MARGIN (dB)	ANTENNA HEIGHT (m)	TABLE ANGLE (Degree)	RAW VALUE (dBuV)	CORRECTION FACTOR (dB/m)
1	*5785.00	110.2 PK			2.51 V	23	105.9	4.3
2	*5785.00	99.9 AV			2.51 V	23	95.6	4.3
3	11570.00	47.0 PK	74.0	-27.0	1.24 V	360	33.0	14.0
4	11570.00	36.1 AV	54.0	-17.9	1.24 V	360	22.1	14.0
5	#17355.00	53.9 PK	74.0	-20.1	2.05 V	142	36.6	17.3
6	#17355.00	42.2 AV	54.0	-11.8	2.05 V	142	24.9	17.3

**REMARKS:**

1. Emission Level(dBuV/m) = Raw Value(dBuV) + Correction Factor(dB/m)
2. Correction Factor(dB/m) = Antenna Factor(dB/m) + Cable Factor(dB) – Pre-Amplifier Factor(dB)
3. The other emission levels were very low against the limit.
4. Margin value = Emission Level – Limit value
5. " \* ": Fundamental frequency.
6. " # ": The radiated frequency is out of the restricted band.

<b>CHANNEL</b>	TX Channel 165	<b>DETECTOR FUNCTION</b>	Peak (PK)
<b>FREQUENCY RANGE</b>	1GHz ~ 40GHz		Average (AV)

**ANTENNA POLARITY & TEST DISTANCE: HORIZONTAL AT 3 M**

NO.	FREQ. (MHz)	EMISSION LEVEL (dBuV/m)	LIMIT (dBuV/m)	MARGIN (dB)	ANTENNA HEIGHT (m)	TABLE ANGLE (Degree)	RAW VALUE (dBuV)	CORRECTION FACTOR (dB/m)
1	*5825.00	112.7 PK			1.08 H	175	108.3	4.4
2	*5825.00	102.9 AV			1.08 H	175	98.5	4.4
3	11650.00	47.2 PK	74.0	-26.8	1.18 H	352	33.3	13.9
4	11650.00	36.7 AV	54.0	-17.3	1.18 H	352	22.8	13.9
5	#17475.00	54.4 PK	74.0	-19.6	2.07 H	162	36.2	18.2
6	#17475.00	42.2 AV	54.0	-11.8	2.07 H	162	24.0	18.2

**ANTENNA POLARITY & TEST DISTANCE: VERTICAL AT 3 M**

NO.	FREQ. (MHz)	EMISSION LEVEL (dBuV/m)	LIMIT (dBuV/m)	MARGIN (dB)	ANTENNA HEIGHT (m)	TABLE ANGLE (Degree)	RAW VALUE (dBuV)	CORRECTION FACTOR (dB/m)
1	*5825.00	110.9 PK			2.56 V	15	106.5	4.4
2	*5825.00	100.6 AV			2.56 V	15	96.2	4.4
3	11650.00	46.7 PK	74.0	-27.3	1.25 V	360	32.8	13.9
4	11650.00	35.4 AV	54.0	-18.6	1.25 V	360	21.5	13.9
5	#17475.00	53.6 PK	74.0	-20.4	2.13 V	144	35.4	18.2
6	#17475.00	41.5 AV	54.0	-12.5	2.13 V	144	23.3	18.2

**REMARKS:**

- Emission Level(dBuV/m) = Raw Value(dBuV) + Correction Factor(dB/m)
- Correction Factor(dB/m) = Antenna Factor(dB/m) + Cable Factor(dB) – Pre-Amplifier Factor(dB)
- The other emission levels were very low against the limit.
- Margin value = Emission Level – Limit value
- " \* ": Fundamental frequency.
- " # ": The radiated frequency is out of the restricted band.

**802.11ac (VHT40)**

<b>CHANNEL</b>	TX Channel 38	<b>DETECTOR FUNCTION</b>	Peak (PK)
<b>FREQUENCY RANGE</b>	1GHz ~ 40GHz		Average (AV)

**ANTENNA POLARITY & TEST DISTANCE: HORIZONTAL AT 3 M**

NO.	FREQ. (MHz)	EMISSION LEVEL (dBuV/m)	LIMIT (dBuV/m)	MARGIN (dB)	ANTENNA HEIGHT (m)	TABLE ANGLE (Degree)	RAW VALUE (dBuV)	CORRECTION FACTOR (dB/m)
1	5150.00	66.6 PK	74.0	-7.4	1.00 H	169	62.5	4.1
2	5150.00	53.6 AV	54.0	-0.4	1.00 H	169	49.5	4.1
3	*5190.00	106.7 PK			1.00 H	169	102.9	3.8
4	*5190.00	99.3 AV			1.00 H	169	95.5	3.8
5	5350.00	50.5 PK	74.0	-23.5	1.00 H	169	46.9	3.6
6	5350.00	40.1 AV	54.0	-13.9	1.00 H	169	36.5	3.6
7	#10380.00	49.4 PK	74.0	-24.6	1.48 H	231	36.3	13.1
8	#10380.00	39.5 AV	54.0	-14.5	1.48 H	231	26.4	13.1
9	15570.00	49.6 PK	74.0	-24.4	1.55 H	287	36.5	13.1
10	15570.00	37.8 AV	54.0	-16.2	1.55 H	287	24.7	13.1

**ANTENNA POLARITY & TEST DISTANCE: VERTICAL AT 3 M**

NO.	FREQ. (MHz)	EMISSION LEVEL (dBuV/m)	LIMIT (dBuV/m)	MARGIN (dB)	ANTENNA HEIGHT (m)	TABLE ANGLE (Degree)	RAW VALUE (dBuV)	CORRECTION FACTOR (dB/m)
1	5150.00	65.4 PK	74.0	-8.6	3.17 V	123	61.3	4.1
2	5150.00	52.4 AV	54.0	-1.6	3.17 V	123	48.3	4.1
3	*5190.00	105.9 PK			3.17 V	123	102.1	3.8
4	*5190.00	98.6 AV			3.17 V	123	94.8	3.8
5	5350.00	49.6 PK	74.0	-24.4	3.17 V	123	46.0	3.6
6	5350.00	39.6 AV	54.0	-14.4	3.17 V	123	36.0	3.6
7	#10380.00	50.3 PK	74.0	-23.7	1.51 V	323	37.2	13.1
8	#10380.00	39.0 AV	54.0	-15.0	1.51 V	323	25.9	13.1
9	15570.00	48.5 PK	74.0	-25.5	1.39 V	126	35.4	13.1
10	15570.00	37.8 AV	54.0	-16.2	1.39 V	126	24.7	13.1

**REMARKS:**

- Emission Level(dBuV/m) = Raw Value(dBuV) + Correction Factor(dB/m)
- Correction Factor(dB/m) = Antenna Factor(dB/m) + Cable Factor(dB) – Pre-Amplifier Factor(dB)
- The other emission levels were very low against the limit.
- Margin value = Emission Level – Limit value
- " \* ": Fundamental frequency.
- " # ": The radiated frequency is out of the restricted band.

<b>CHANNEL</b>	TX Channel 46	<b>DETECTOR FUNCTION</b>	Peak (PK)
<b>FREQUENCY RANGE</b>	1GHz ~ 40GHz		Average (AV)

**ANTENNA POLARITY & TEST DISTANCE: HORIZONTAL AT 3 M**

NO.	FREQ. (MHz)	EMISSION LEVEL (dBuV/m)	LIMIT (dBuV/m)	MARGIN (dB)	ANTENNA HEIGHT (m)	TABLE ANGLE (Degree)	RAW VALUE (dBuV)	CORRECTION FACTOR (dB/m)
1	*5230.00	108.6 PK			1.02 H	171	105.1	3.5
2	*5230.00	102.1 AV			1.02 H	171	98.6	3.5
3	5350.00	57.5 PK	74.0	-16.5	1.02 H	171	53.9	3.6
4	5350.00	43.7 AV	54.0	-10.3	1.02 H	171	40.1	3.6
5	#10460.00	48.7 PK	74.0	-25.3	1.48 H	223	35.3	13.4
6	#10460.00	38.6 AV	54.0	-15.4	1.48 H	223	25.2	13.4
7	15690.00	49.3 PK	74.0	-24.7	1.57 H	286	36.4	12.9
8	15690.00	38.1 AV	54.0	-15.9	1.57 H	286	25.2	12.9

**ANTENNA POLARITY & TEST DISTANCE: VERTICAL AT 3 M**

NO.	FREQ. (MHz)	EMISSION LEVEL (dBuV/m)	LIMIT (dBuV/m)	MARGIN (dB)	ANTENNA HEIGHT (m)	TABLE ANGLE (Degree)	RAW VALUE (dBuV)	CORRECTION FACTOR (dB/m)
1	*5230.00	107.9 PK			3.16 V	122	104.4	3.5
2	*5230.00	101.6 AV			3.16 V	122	98.1	3.5
3	5350.00	56.9 PK	74.0	-17.1	3.16 V	122	53.3	3.6
4	5350.00	43.1 AV	54.0	-10.9	3.16 V	122	39.5	3.6
5	#10460.00	50.2 PK	74.0	-23.8	1.45 V	316	36.8	13.4
6	#10460.00	39.3 AV	54.0	-14.7	1.45 V	316	25.9	13.4
7	15690.00	49.3 PK	74.0	-24.7	1.37 V	147	36.4	12.9
8	15690.00	38.5 AV	54.0	-15.5	1.37 V	147	25.6	12.9

**REMARKS:**

- Emission Level(dBuV/m) = Raw Value(dBuV) + Correction Factor(dB/m)
- Correction Factor(dB/m) = Antenna Factor(dB/m) + Cable Factor(dB) – Pre-Amplifier Factor(dB)
- The other emission levels were very low against the limit.
- Margin value = Emission Level – Limit value
- " \* ": Fundamental frequency.
- " # ": The radiated frequency is out of the restricted band.

<b>CHANNEL</b>	TX Channel 54	<b>DETECTOR FUNCTION</b>	Peak (PK)
<b>FREQUENCY RANGE</b>	1GHz ~ 40GHz		Average (AV)

**ANTENNA POLARITY & TEST DISTANCE: HORIZONTAL AT 3 M**

NO.	FREQ. (MHz)	EMISSION LEVEL (dBuV/m)	LIMIT (dBuV/m)	MARGIN (dB)	ANTENNA HEIGHT (m)	TABLE ANGLE (Degree)	RAW VALUE (dBuV)	CORRECTION FACTOR (dB/m)
1	5150.00	52.5 PK	74.0	-21.5	1.11 H	174	48.4	4.1
2	5150.00	41.5 AV	54.0	-12.5	1.11 H	174	37.4	4.1
3	*5270.00	119.7 PK			1.11 H	174	116.3	3.4
4	*5270.00	113.4 AV			1.11 H	174	110.0	3.4
5	#10540.00	48.7 PK	74.0	-25.3	1.55 H	229	35.5	13.2
6	#10540.00	38.7 AV	54.0	-15.3	1.55 H	229	25.5	13.2
7	15810.00	49.7 PK	74.0	-24.3	1.57 H	291	37.0	12.7
8	15810.00	38.1 AV	54.0	-15.9	1.57 H	291	25.4	12.7

**ANTENNA POLARITY & TEST DISTANCE: VERTICAL AT 3 M**

NO.	FREQ. (MHz)	EMISSION LEVEL (dBuV/m)	LIMIT (dBuV/m)	MARGIN (dB)	ANTENNA HEIGHT (m)	TABLE ANGLE (Degree)	RAW VALUE (dBuV)	CORRECTION FACTOR (dB/m)
1	5150.00	51.9 PK	74.0	-22.1	3.17 V	126	47.8	4.1
2	5150.00	40.4 AV	54.0	-13.6	3.17 V	126	36.3	4.1
3	*5270.00	118.8 PK			3.17 V	126	115.4	3.4
4	*5270.00	112.7 AV			3.17 V	126	109.3	3.4
5	#10540.00	50.0 PK	74.0	-24.0	1.47 V	314	36.8	13.2
6	#10540.00	39.0 AV	54.0	-15.0	1.47 V	314	25.8	13.2
7	15810.00	49.0 PK	74.0	-25.0	1.42 V	143	36.3	12.7
8	15810.00	38.3 AV	54.0	-15.7	1.42 V	143	25.6	12.7

**REMARKS:**

1. Emission Level(dBuV/m) = Raw Value(dBuV) + Correction Factor(dB/m)
2. Correction Factor(dB/m) = Antenna Factor(dB/m) + Cable Factor(dB) – Pre-Amplifier Factor(dB)
3. The other emission levels were very low against the limit.
4. Margin value = Emission Level – Limit value
5. " \* ": Fundamental frequency.
6. " # ": The radiated frequency is out of the restricted band.

<b>CHANNEL</b>	TX Channel 62	<b>DETECTOR FUNCTION</b>	Peak (PK)
<b>FREQUENCY RANGE</b>	1GHz ~ 40GHz		Average (AV)

**ANTENNA POLARITY & TEST DISTANCE: HORIZONTAL AT 3 M**

NO.	FREQ. (MHz)	EMISSION LEVEL (dBuV/m)	LIMIT (dBuV/m)	MARGIN (dB)	ANTENNA HEIGHT (m)	TABLE ANGLE (Degree)	RAW VALUE (dBuV)	CORRECTION FACTOR (dB/m)
1	*5310.00	107.5 PK			1.14 H	181	104.1	3.4
2	*5310.00	98.9 AV			1.14 H	181	95.5	3.4
3	5350.00	67.9 PK	74.0	-6.1	1.14 H	181	64.3	3.6
4	5350.00	53.8 AV	54.0	-0.2	1.14 H	181	50.2	3.6
5	10620.00	49.2 PK	74.0	-24.8	1.46 H	227	36.3	12.9
6	10620.00	39.3 AV	54.0	-14.7	1.46 H	227	26.4	12.9
7	15930.00	49.9 PK	74.0	-24.1	1.63 H	288	37.1	12.8
8	15930.00	38.6 AV	54.0	-15.4	1.63 H	288	25.8	12.8

**ANTENNA POLARITY & TEST DISTANCE: VERTICAL AT 3 M**

NO.	FREQ. (MHz)	EMISSION LEVEL (dBuV/m)	LIMIT (dBuV/m)	MARGIN (dB)	ANTENNA HEIGHT (m)	TABLE ANGLE (Degree)	RAW VALUE (dBuV)	CORRECTION FACTOR (dB/m)
1	*5310.00	106.8 PK			3.15 V	123	103.4	3.4
2	*5310.00	97.6 AV			3.15 V	123	94.2	3.4
3	5350.00	66.8 PK	74.0	-7.2	3.15 V	123	63.2	3.6
4	5350.00	52.6 AV	54.0	-1.4	3.15 V	123	49.0	3.6
5	10620.00	50.0 PK	74.0	-24.0	1.50 V	317	37.1	12.9
6	10620.00	38.8 AV	54.0	-15.2	1.50 V	317	25.9	12.9
7	15930.00	48.5 PK	74.0	-25.5	1.40 V	134	35.7	12.8
8	15930.00	37.6 AV	54.0	-16.4	1.40 V	134	24.8	12.8

**REMARKS:**

1. Emission Level(dBuV/m) = Raw Value(dBuV) + Correction Factor(dB/m)
2. Correction Factor(dB/m) = Antenna Factor(dB/m) + Cable Factor(dB) – Pre-Amplifier Factor(dB)
3. The other emission levels were very low against the limit.
4. Margin value = Emission Level – Limit value
5. " \* ": Fundamental frequency.



<b>CHANNEL</b>	TX Channel 102	<b>DETECTOR FUNCTION</b>	Peak (PK)
<b>FREQUENCY RANGE</b>	1GHz ~ 40GHz		Average (AV)

**ANTENNA POLARITY & TEST DISTANCE: HORIZONTAL AT 3 M**

NO.	FREQ. (MHz)	EMISSION LEVEL (dBuV/m)	LIMIT (dBuV/m)	MARGIN (dB)	ANTENNA HEIGHT (m)	TABLE ANGLE (Degree)	RAW VALUE (dBuV)	CORRECTION FACTOR (dB/m)
1	#5470.00	62.5 PK	74.0	-11.5	1.06 H	179	58.6	3.9
2	#5470.00	53.7 AV	54.0	-0.3	1.06 H	179	49.8	3.9
3	*5510.00	106.7 PK			1.06 H	179	102.8	3.9
4	*5510.00	98.6 AV			1.06 H	179	94.7	3.9
5	11020.00	48.6 PK	74.0	-25.4	1.46 H	224	34.7	13.9
6	11020.00	38.7 AV	54.0	-15.3	1.46 H	224	24.8	13.9
7	#16530.00	50.0 PK	74.0	-24.0	1.59 H	270	34.7	15.3
8	#16530.00	38.3 AV	54.0	-15.7	1.59 H	270	23.0	15.3

**ANTENNA POLARITY & TEST DISTANCE: VERTICAL AT 3 M**

NO.	FREQ. (MHz)	EMISSION LEVEL (dBuV/m)	LIMIT (dBuV/m)	MARGIN (dB)	ANTENNA HEIGHT (m)	TABLE ANGLE (Degree)	RAW VALUE (dBuV)	CORRECTION FACTOR (dB/m)
1	#5470.00	61.8 PK	74.0	-12.2	3.17 V	107	57.9	3.9
2	#5470.00	52.6 AV	54.0	-1.4	3.17 V	107	48.7	3.9
3	*5510.00	105.6 PK			3.17 V	107	101.7	3.9
4	*5510.00	97.4 AV			3.17 V	107	93.5	3.9
5	11020.00	50.0 PK	74.0	-24.0	1.49 V	304	36.1	13.9
6	11020.00	39.2 AV	54.0	-14.8	1.49 V	304	25.3	13.9
7	#16530.00	49.5 PK	74.0	-24.5	1.41 V	124	34.2	15.3
8	#16530.00	38.5 AV	54.0	-15.5	1.41 V	124	23.2	15.3

**REMARKS:**

1. Emission Level(dBuV/m) = Raw Value(dBuV) + Correction Factor(dB/m)
2. Correction Factor(dB/m) = Antenna Factor(dB/m) + Cable Factor(dB) – Pre-Amplifier Factor(dB)
3. The other emission levels were very low against the limit.
4. Margin value = Emission Level – Limit value
5. " \* ": Fundamental frequency.
6. " # ": The radiated frequency is out of the restricted band.

<b>CHANNEL</b>	TX Channel 110	<b>DETECTOR FUNCTION</b>	Peak (PK)
<b>FREQUENCY RANGE</b>	1GHz ~ 40GHz		Average (AV)

**ANTENNA POLARITY & TEST DISTANCE: HORIZONTAL AT 3 M**

NO.	FREQ. (MHz)	EMISSION LEVEL (dBuV/m)	LIMIT (dBuV/m)	MARGIN (dB)	ANTENNA HEIGHT (m)	TABLE ANGLE (Degree)	RAW VALUE (dBuV)	CORRECTION FACTOR (dB/m)
1	*5550.00	110.6 PK			1.05 H	174	106.5	4.1
2	*5550.00	102.7 AV			1.05 H	174	98.6	4.1
3	11100.00	48.8 PK	74.0	-25.2	1.54 H	220	35.1	13.7
4	11100.00	38.9 AV	54.0	-15.1	1.54 H	220	25.2	13.7
5	#16650.00	49.8 PK	74.0	-24.2	1.62 H	293	33.8	16.0
6	#16650.00	38.0 AV	54.0	-16.0	1.62 H	293	22.0	16.0

**ANTENNA POLARITY & TEST DISTANCE: VERTICAL AT 3 M**

NO.	FREQ. (MHz)	EMISSION LEVEL (dBuV/m)	LIMIT (dBuV/m)	MARGIN (dB)	ANTENNA HEIGHT (m)	TABLE ANGLE (Degree)	RAW VALUE (dBuV)	CORRECTION FACTOR (dB/m)
1	*5550.00	109.3 PK			3.23 V	115	105.2	4.1
2	*5550.00	101.5 AV			3.23 V	115	97.4	4.1
3	11100.00	49.9 PK	74.0	-24.1	1.42 V	328	36.2	13.7
4	11100.00	39.1 AV	54.0	-14.9	1.42 V	328	25.4	13.7
5	#16650.00	49.3 PK	74.0	-24.7	1.42 V	126	33.3	16.0
6	#16650.00	38.5 AV	54.0	-15.5	1.42 V	126	22.5	16.0

**REMARKS:**

1. Emission Level(dBuV/m) = Raw Value(dBuV) + Correction Factor(dB/m)
2. Correction Factor(dB/m) = Antenna Factor(dB/m) + Cable Factor(dB) – Pre-Amplifier Factor(dB)
3. The other emission levels were very low against the limit.
4. Margin value = Emission Level – Limit value
5. " \* ": Fundamental frequency.
6. " # ": The radiated frequency is out of the restricted band.

<b>CHANNEL</b>	TX Channel 134	<b>DETECTOR FUNCTION</b>	Peak (PK)
<b>FREQUENCY RANGE</b>	1GHz ~ 40GHz		Average (AV)

**ANTENNA POLARITY & TEST DISTANCE: HORIZONTAL AT 3 M**

NO.	FREQ. (MHz)	EMISSION LEVEL (dBuV/m)	LIMIT (dBuV/m)	MARGIN (dB)	ANTENNA HEIGHT (m)	TABLE ANGLE (Degree)	RAW VALUE (dBuV)	CORRECTION FACTOR (dB/m)
1	*5670.00	108.9 PK			1.09 H	171	104.6	4.3
2	*5670.00	101.2 AV			1.09 H	171	96.9	4.3
3	#5725.00	65.8 PK	74.0	-8.2	1.09 H	171	61.4	4.4
4	<b>#5725.00</b>	<b>53.9 AV</b>	<b>54.0</b>	<b>-0.1</b>	<b>1.09 H</b>	<b>171</b>	<b>49.5</b>	<b>4.4</b>
5	11340.00	48.4 PK	74.0	-25.6	1.23 H	349	34.4	14.0
6	11340.00	37.4 AV	54.0	-16.6	1.23 H	349	23.4	14.0
7	#17010.00	54.1 PK	74.0	-19.9	2.03 H	180	37.3	16.8
8	#17010.00	41.6 AV	54.0	-12.4	2.03 H	180	24.8	16.8

**ANTENNA POLARITY & TEST DISTANCE: VERTICAL AT 3 M**

NO.	FREQ. (MHz)	EMISSION LEVEL (dBuV/m)	LIMIT (dBuV/m)	MARGIN (dB)	ANTENNA HEIGHT (m)	TABLE ANGLE (Degree)	RAW VALUE (dBuV)	CORRECTION FACTOR (dB/m)
1	*5670.00	106.0 PK			2.46 V	23	101.7	4.3
2	*5670.00	98.1 AV			2.46 V	23	93.8	4.3
3	#5725.00	64.6 PK	74.0	-9.4	2.46 V	23	60.2	4.4
4	#5725.00	51.4 AV	54.0	-2.6	2.46 V	23	47.0	4.4
5	11340.00	46.6 PK	74.0	-27.4	1.32 V	337	32.6	14.0
6	11340.00	35.5 AV	54.0	-18.5	1.32 V	337	21.5	14.0
7	#17010.00	53.5 PK	74.0	-20.5	2.12 V	154	36.7	16.8
8	#17010.00	41.7 AV	54.0	-12.3	2.12 V	154	24.9	16.8

**REMARKS:**

1. Emission Level(dBuV/m) = Raw Value(dBuV) + Correction Factor(dB/m)
2. Correction Factor(dB/m) = Antenna Factor(dB/m) + Cable Factor(dB) – Pre-Amplifier Factor(dB)
3. The other emission levels were very low against the limit.
4. Margin value = Emission Level – Limit value
5. " \* ": Fundamental frequency.
6. " # ": The radiated frequency is out of the restricted band.

<b>CHANNEL</b>	TX Channel 151	<b>DETECTOR FUNCTION</b>	Peak (PK)
<b>FREQUENCY RANGE</b>	1GHz ~ 40GHz		Average (AV)

**ANTENNA POLARITY & TEST DISTANCE: HORIZONTAL AT 3 M**

NO.	FREQ. (MHz)	EMISSION LEVEL (dBuV/m)	LIMIT (dBuV/m)	MARGIN (dB)	ANTENNA HEIGHT (m)	TABLE ANGLE (Degree)	RAW VALUE (dBuV)	CORRECTION FACTOR (dB/m)
1	*5755.00	107.9 PK			1.04 H	169	103.6	4.3
2	*5755.00	99.9 AV			1.04 H	169	95.6	4.3
3	11510.00	48.0 PK	74.0	-26.0	1.30 H	359	34.0	14.0
4	11510.00	37.5 AV	54.0	-16.5	1.30 H	359	23.5	14.0
5	#17265.00	53.6 PK	74.0	-20.4	1.99 H	183	36.6	17.0
6	#17265.00	41.3 AV	54.0	-12.7	1.99 H	183	24.3	17.0

**ANTENNA POLARITY & TEST DISTANCE: VERTICAL AT 3 M**

NO.	FREQ. (MHz)	EMISSION LEVEL (dBuV/m)	LIMIT (dBuV/m)	MARGIN (dB)	ANTENNA HEIGHT (m)	TABLE ANGLE (Degree)	RAW VALUE (dBuV)	CORRECTION FACTOR (dB/m)
1	*5755.00	104.6 PK			2.49 V	7	100.3	4.3
2	*5755.00	96.7 AV			2.49 V	7	92.4	4.3
3	11510.00	47.1 PK	74.0	-26.9	1.25 V	360	33.1	14.0
4	11510.00	35.7 AV	54.0	-18.3	1.25 V	360	21.7	14.0
5	#17265.00	53.3 PK	74.0	-20.7	2.10 V	139	36.3	17.0
6	#17265.00	41.5 AV	54.0	-12.5	2.10 V	139	24.5	17.0

**REMARKS:**

1. Emission Level(dBuV/m) = Raw Value(dBuV) + Correction Factor(dB/m)
2. Correction Factor(dB/m) = Antenna Factor(dB/m) + Cable Factor(dB) – Pre-Amplifier Factor(dB)
3. The other emission levels were very low against the limit.
4. Margin value = Emission Level – Limit value
5. " \* ": Fundamental frequency.
6. " # ": The radiated frequency is out of the restricted band.

<b>CHANNEL</b>	TX Channel 159	<b>DETECTOR FUNCTION</b>	Peak (PK)
<b>FREQUENCY RANGE</b>	1GHz ~ 40GHz		Average (AV)

**ANTENNA POLARITY & TEST DISTANCE: HORIZONTAL AT 3 M**

NO.	FREQ. (MHz)	EMISSION LEVEL (dBuV/m)	LIMIT (dBuV/m)	MARGIN (dB)	ANTENNA HEIGHT (m)	TABLE ANGLE (Degree)	RAW VALUE (dBuV)	CORRECTION FACTOR (dB/m)
1	*5795.00	110.2 PK			1.09 H	166	105.9	4.3
2	*5795.00	101.7 AV			1.09 H	166	97.4	4.3
3	11590.00	47.5 PK	74.0	-26.5	1.26 H	360	33.5	14.0
4	11590.00	36.8 AV	54.0	-17.2	1.26 H	360	22.8	14.0
5	#17385.00	53.3 PK	74.0	-20.7	2.03 H	181	36.0	17.3
6	#17385.00	41.2 AV	54.0	-12.8	2.03 H	181	23.9	17.3

**ANTENNA POLARITY & TEST DISTANCE: VERTICAL AT 3 M**

NO.	FREQ. (MHz)	EMISSION LEVEL (dBuV/m)	LIMIT (dBuV/m)	MARGIN (dB)	ANTENNA HEIGHT (m)	TABLE ANGLE (Degree)	RAW VALUE (dBuV)	CORRECTION FACTOR (dB/m)
1	*5795.00	106.5 PK			2.53 V	12	102.2	4.3
2	*5795.00	98.2 AV			2.53 V	12	93.9	4.3
3	11590.00	46.4 PK	74.0	-27.6	1.33 V	360	32.4	14.0
4	11590.00	35.2 AV	54.0	-18.8	1.33 V	360	21.2	14.0
5	#17385.00	53.5 PK	74.0	-20.5	2.03 V	150	36.2	17.3
6	#17385.00	41.6 AV	54.0	-12.4	2.03 V	150	24.3	17.3

**REMARKS:**

1. Emission Level(dBuV/m) = Raw Value(dBuV) + Correction Factor(dB/m)
2. Correction Factor(dB/m) = Antenna Factor(dB/m) + Cable Factor(dB) – Pre-Amplifier Factor(dB)
3. The other emission levels were very low against the limit.
4. Margin value = Emission Level – Limit value
5. " \* ": Fundamental frequency.
6. " # ": The radiated frequency is out of the restricted band.

802.11ac (VHT80)

<b>CHANNEL</b>	TX Channel 42	<b>DETECTOR FUNCTION</b>	Peak (PK)
<b>FREQUENCY RANGE</b>	1GHz ~ 40GHz		Average (AV)

ANTENNA POLARITY & TEST DISTANCE: HORIZONTAL AT 3 M								
NO.	FREQ. (MHz)	EMISSION LEVEL (dBuV/m)	LIMIT (dBuV/m)	MARGIN (dB)	ANTENNA HEIGHT (m)	TABLE ANGLE (Degree)	RAW VALUE (dBuV)	CORRECTION FACTOR (dB/m)
1	5150.00	61.3 PK	74.0	-12.7	1.12 H	171	57.2	4.1
2	5150.00	53.6 AV	54.0	-0.4	1.12 H	171	49.5	4.1
3	*5210.00	103.2 PK			1.12 H	171	99.5	3.7
4	*5210.00	95.4 AV			1.12 H	171	91.7	3.7
5	5350.00	54.9 PK	74.0	-19.1	1.12 H	171	51.3	3.6
6	5350.00	42.5 AV	54.0	-11.5	1.12 H	171	38.9	3.6
7	#10420.00	48.6 PK	74.0	-25.4	1.44 H	209	35.4	13.2
8	#10420.00	38.7 AV	54.0	-15.3	1.44 H	209	25.5	13.2
9	15630.00	49.9 PK	74.0	-24.1	1.54 H	269	36.9	13.0
10	15630.00	38.2 AV	54.0	-15.8	1.54 H	269	25.2	13.0

ANTENNA POLARITY & TEST DISTANCE: VERTICAL AT 3 M								
NO.	FREQ. (MHz)	EMISSION LEVEL (dBuV/m)	LIMIT (dBuV/m)	MARGIN (dB)	ANTENNA HEIGHT (m)	TABLE ANGLE (Degree)	RAW VALUE (dBuV)	CORRECTION FACTOR (dB/m)
1	5150.00	60.3 PK	74.0	-13.7	3.20 V	111	56.2	4.1
2	5150.00	52.9 AV	54.0	-1.1	3.20 V	111	48.8	4.1
3	*5210.00	102.8 PK			3.20 V	111	99.1	3.7
4	*5210.00	94.6 AV			3.20 V	111	90.9	3.7
5	5350.00	53.4 PK	74.0	-20.6	3.20 V	111	49.8	3.6
6	5350.00	41.6 AV	54.0	-12.4	3.20 V	111	38.0	3.6
7	#10420.00	49.8 PK	74.0	-24.2	1.41 V	314	36.6	13.2
8	#10420.00	38.5 AV	54.0	-15.5	1.41 V	314	25.3	13.2
9	15630.00	49.5 PK	74.0	-24.5	1.44 V	150	36.5	13.0
10	15630.00	38.3 AV	54.0	-15.7	1.44 V	150	25.3	13.0

**REMARKS:**

1. Emission Level(dBuV/m) = Raw Value(dBuV) + Correction Factor(dB/m)
2. Correction Factor(dB/m) = Antenna Factor(dB/m) + Cable Factor(dB) – Pre-Amplifier Factor(dB)
3. The other emission levels were very low against the limit.
4. Margin value = Emission Level – Limit value
5. " \* ": Fundamental frequency.
6. " # ": The radiated frequency is out of the restricted band.

<b>CHANNEL</b>	TX Channel 58	<b>DETECTOR FUNCTION</b>	Peak (PK)
<b>FREQUENCY RANGE</b>	1GHz ~ 40GHz		Average (AV)

**ANTENNA POLARITY & TEST DISTANCE: HORIZONTAL AT 3 M**

NO.	FREQ. (MHz)	EMISSION LEVEL (dBuV/m)	LIMIT (dBuV/m)	MARGIN (dB)	ANTENNA HEIGHT (m)	TABLE ANGLE (Degree)	RAW VALUE (dBuV)	CORRECTION FACTOR (dB/m)
1	5150.00	49.1 PK	74.0	-24.9	1.07 H	179	45.0	4.1
2	5150.00	38.9 AV	54.0	-15.1	1.07 H	179	34.8	4.1
3	*5290.00	103.1 PK			1.07 H	179	99.7	3.4
4	*5290.00	94.1 AV			1.07 H	179	90.7	3.4
5	5350.00	65.5 PK	74.0	-8.5	1.07 H	179	61.9	3.6
6	5350.00	53.7 AV	54.0	-0.3	1.07 H	179	50.1	3.6
7	#10580.00	48.9 PK	74.0	-25.1	1.48 H	222	35.9	13.0
8	#10580.00	39.1 AV	54.0	-14.9	1.48 H	222	26.1	13.0
9	15870.00	49.9 PK	74.0	-24.1	1.62 H	282	37.1	12.8
10	15870.00	38.6 AV	54.0	-15.4	1.62 H	282	25.8	12.8

**ANTENNA POLARITY & TEST DISTANCE: VERTICAL AT 3 M**

NO.	FREQ. (MHz)	EMISSION LEVEL (dBuV/m)	LIMIT (dBuV/m)	MARGIN (dB)	ANTENNA HEIGHT (m)	TABLE ANGLE (Degree)	RAW VALUE (dBuV)	CORRECTION FACTOR (dB/m)
1	5150.00	48.6 PK	74.0	-25.4	3.24 V	115	44.5	4.1
2	5150.00	37.8 AV	54.0	-16.2	3.24 V	115	33.7	4.1
3	*5290.00	102.6 PK			3.24 V	115	99.2	3.4
4	*5290.00	93.2 AV			3.24 V	115	89.8	3.4
5	5350.00	64.3 PK	74.0	-9.7	3.24 V	115	60.7	3.6
6	5350.00	52.4 AV	54.0	-1.6	3.24 V	115	48.8	3.6
7	#10580.00	50.4 PK	74.0	-23.6	1.46 V	326	37.4	13.0
8	#10580.00	39.3 AV	54.0	-14.7	1.46 V	326	26.3	13.0
9	15870.00	48.9 PK	74.0	-25.1	1.35 V	138	36.1	12.8
10	15870.00	38.1 AV	54.0	-15.9	1.35 V	138	25.3	12.8

**REMARKS:**

1. Emission Level(dBuV/m) = Raw Value(dBuV) + Correction Factor(dB/m)
2. Correction Factor(dB/m) = Antenna Factor(dB/m) + Cable Factor(dB) – Pre-Amplifier Factor(dB)
3. The other emission levels were very low against the limit.
4. Margin value = Emission Level – Limit value
5. " \* ": Fundamental frequency.
6. " # ": The radiated frequency is out of the restricted band.

<b>CHANNEL</b>	TX Channel 106	<b>DETECTOR FUNCTION</b>	Peak (PK)
<b>FREQUENCY RANGE</b>	1GHz ~ 40GHz		Average (AV)

**ANTENNA POLARITY & TEST DISTANCE: HORIZONTAL AT 3 M**

NO.	FREQ. (MHz)	EMISSION LEVEL (dBuV/m)	LIMIT (dBuV/m)	MARGIN (dB)	ANTENNA HEIGHT (m)	TABLE ANGLE (Degree)	RAW VALUE (dBuV)	CORRECTION FACTOR (dB/m)
1	#5470.00	64.1 PK	74.0	-9.9	1.04 H	175	60.2	3.9
2	#5470.00	53.6 AV	54.0	-0.4	1.04 H	175	49.7	3.9
3	*5530.00	101.9 PK			1.04 H	175	97.8	4.1
4	*5530.00	93.7 AV			1.04 H	175	89.6	4.1
5	#5725.00	49.3 PK	74.0	-24.7	1.04 H	175	44.9	4.4
6	#5725.00	38.5 AV	54.0	-15.5	1.04 H	175	34.1	4.4
7	11060.00	49.5 PK	74.0	-24.5	1.43 H	228	35.7	13.8
8	11060.00	39.4 AV	54.0	-14.6	1.43 H	228	25.6	13.8
9	#16590.00	50.2 PK	74.0	-23.8	1.55 H	268	34.8	15.4
10	#16590.00	38.4 AV	54.0	-15.6	1.55 H	268	23.0	15.4

**ANTENNA POLARITY & TEST DISTANCE: VERTICAL AT 3 M**

NO.	FREQ. (MHz)	EMISSION LEVEL (dBuV/m)	LIMIT (dBuV/m)	MARGIN (dB)	ANTENNA HEIGHT (m)	TABLE ANGLE (Degree)	RAW VALUE (dBuV)	CORRECTION FACTOR (dB/m)
1	#5470.00	63.8 PK	74.0	-10.2	3.24 V	123	59.9	3.9
2	#5470.00	52.7 AV	54.0	-1.3	3.24 V	123	48.8	3.9
3	*5530.00	100.8 PK			3.24 V	123	96.7	4.1
4	*5530.00	92.6 AV			3.24 V	123	88.5	4.1
5	#5725.00	48.4 PK	74.0	-25.6	3.24 V	123	44.0	4.4
6	#5725.00	37.6 AV	54.0	-16.4	3.24 V	123	33.2	4.4
7	11060.00	50.1 PK	74.0	-23.9	1.49 V	321	36.3	13.8
8	11060.00	38.9 AV	54.0	-15.1	1.49 V	321	25.1	13.8
9	#16590.00	49.4 PK	74.0	-24.6	1.43 V	127	34.0	15.4
10	#16590.00	38.3 AV	54.0	-15.7	1.43 V	127	22.9	15.4

**REMARKS:**

1. Emission Level(dBuV/m) = Raw Value(dBuV) + Correction Factor(dB/m)
2. Correction Factor(dB/m) = Antenna Factor(dB/m) + Cable Factor(dB) – Pre-Amplifier Factor(dB)
3. The other emission levels were very low against the limit.
4. Margin value = Emission Level – Limit value
5. " \* ": Fundamental frequency.
6. " # ": The radiated frequency is out of the restricted band.



<b>CHANNEL</b>	TX Channel 122	<b>DETECTOR FUNCTION</b>	Peak (PK)
<b>FREQUENCY RANGE</b>	1GHz ~ 40GHz		Average (AV)

**ANTENNA POLARITY & TEST DISTANCE: HORIZONTAL AT 3 M**

NO.	FREQ. (MHz)	EMISSION LEVEL (dBuV/m)	LIMIT (dBuV/m)	MARGIN (dB)	ANTENNA HEIGHT (m)	TABLE ANGLE (Degree)	RAW VALUE (dBuV)	CORRECTION FACTOR (dB/m)
1	*5610.00	106.8 PK			1.09 H	173	102.5	4.3
2	*5610.00	98.5 AV			1.09 H	173	94.2	4.3
3	#5725.00	63.5 PK	74.0	-10.5	1.09 H	173	59.1	4.4
4	#5725.00	53.6 AV	54.0	-0.4	1.09 H	173	49.2	4.4
5	11220.00	47.6 PK	74.0	-26.4	1.20 H	357	33.9	13.7
6	11220.00	36.7 AV	54.0	-17.3	1.20 H	357	23.0	13.7
7	#16830.00	53.9 PK	74.0	-20.1	1.97 H	190	37.0	16.9
8	#16830.00	41.5 AV	54.0	-12.5	1.97 H	190	24.6	16.9

**ANTENNA POLARITY & TEST DISTANCE: VERTICAL AT 3 M**

NO.	FREQ. (MHz)	EMISSION LEVEL (dBuV/m)	LIMIT (dBuV/m)	MARGIN (dB)	ANTENNA HEIGHT (m)	TABLE ANGLE (Degree)	RAW VALUE (dBuV)	CORRECTION FACTOR (dB/m)
1	*5610.00	104.9 PK			2.24 V	21	100.6	4.3
2	*5610.00	96.4 AV			2.24 V	21	92.1	4.3
3	#5725.00	61.4 PK	74.0	-12.6	2.24 V	21	57.0	4.4
4	#5725.00	51.2 AV	54.0	-2.8	2.24 V	21	46.8	4.4
5	11220.00	47.2 PK	74.0	-26.8	1.32 V	350	33.5	13.7
6	11220.00	36.0 AV	54.0	-18.0	1.32 V	350	22.3	13.7
7	#16830.00	53.9 PK	74.0	-20.1	2.18 V	114	37.0	16.9
8	#16830.00	41.6 AV	54.0	-12.4	2.18 V	114	24.7	16.9

**REMARKS:**

1. Emission Level(dBuV/m) = Raw Value(dBuV) + Correction Factor(dB/m)
2. Correction Factor(dB/m) = Antenna Factor(dB/m) + Cable Factor(dB) – Pre-Amplifier Factor(dB)
3. The other emission levels were very low against the limit.
4. Margin value = Emission Level – Limit value
5. " \* ": Fundamental frequency.
6. " # ": The radiated frequency is out of the restricted band.

<b>CHANNEL</b>	TX Channel 155	<b>DETECTOR FUNCTION</b>	Peak (PK)
<b>FREQUENCY RANGE</b>	1GHz ~ 40GHz		Average (AV)

**ANTENNA POLARITY & TEST DISTANCE: HORIZONTAL AT 3 M**

NO.	FREQ. (MHz)	EMISSION LEVEL (dBuV/m)	LIMIT (dBuV/m)	MARGIN (dB)	ANTENNA HEIGHT (m)	TABLE ANGLE (Degree)	RAW VALUE (dBuV)	CORRECTION FACTOR (dB/m)
1	*5775.00	103.3 PK			1.18 H	171	98.9	4.4
2	*5775.00	95.1 AV			1.18 H	171	90.7	4.4
3	11550.00	47.5 PK	74.0	-26.5	1.20 H	360	33.6	13.9
4	11550.00	36.8 AV	54.0	-17.2	1.20 H	360	22.9	13.9
5	#17325.00	53.5 PK	74.0	-20.5	2.06 H	189	36.3	17.2
6	#17325.00	41.2 AV	54.0	-12.8	2.06 H	189	24.0	17.2

**ANTENNA POLARITY & TEST DISTANCE: VERTICAL AT 3 M**

NO.	FREQ. (MHz)	EMISSION LEVEL (dBuV/m)	LIMIT (dBuV/m)	MARGIN (dB)	ANTENNA HEIGHT (m)	TABLE ANGLE (Degree)	RAW VALUE (dBuV)	CORRECTION FACTOR (dB/m)
1	*5775.00	100.2 PK			2.29 V	15	95.8	4.4
2	*5775.00	92.4 AV			2.29 V	15	88.0	4.4
3	11550.00	47.0 PK	74.0	-27.0	1.31 V	342	33.1	13.9
4	11550.00	35.6 AV	54.0	-18.4	1.31 V	342	21.7	13.9
5	#17325.00	53.5 PK	74.0	-20.5	2.10 V	124	36.3	17.2
6	#17325.00	41.5 AV	54.0	-12.5	2.10 V	124	24.3	17.2

**REMARKS:**

1. Emission Level(dBuV/m) = Raw Value(dBuV) + Correction Factor(dB/m)
2. Correction Factor(dB/m) = Antenna Factor(dB/m) + Cable Factor(dB) – Pre-Amplifier Factor(dB)
3. The other emission levels were very low against the limit.
4. Margin value = Emission Level – Limit value
5. " \* ": Fundamental frequency.
6. " # ": The radiated frequency is out of the restricted band.

**Below 1GHz Data:**

**802.11a**

<b>CHANNEL</b>	TX Channel 40	<b>DETECTOR FUNCTION</b>	Quasi-Peak (QP)
<b>FREQUENCY RANGE</b>	9kHz ~ 1GHz		

**ANTENNA POLARITY & TEST DISTANCE: HORIZONTAL AT 3 M**

NO.	FREQ. (MHz)	EMISSION LEVEL (dBuV/m)	LIMIT (dBuV/m)	MARGIN (dB)	ANTENNA HEIGHT (m)	TABLE ANGLE (Degree)	RAW VALUE (dBuV)	CORRECTION FACTOR (dB/m)
1	69.38	29.7 QP	40.0	-10.3	2.44 H	108	39.3	-9.6
2	146.77	28.4 QP	43.5	-15.1	1.75 H	231	36.2	-7.8
3	164.57	31.2 QP	43.5	-12.3	2.74 H	132	39.1	-7.9
4	240.24	29.7 QP	46.0	-16.3	1.29 H	144	39.0	-9.3
5	322.94	26.0 QP	46.0	-20.0	1.50 H	221	32.2	-6.2
6	848.22	36.8 QP	46.0	-9.2	1.42 H	269	32.2	4.6

**ANTENNA POLARITY & TEST DISTANCE: VERTICAL AT 3 M**

NO.	FREQ. (MHz)	EMISSION LEVEL (dBuV/m)	LIMIT (dBuV/m)	MARGIN (dB)	ANTENNA HEIGHT (m)	TABLE ANGLE (Degree)	RAW VALUE (dBuV)	CORRECTION FACTOR (dB/m)
1	69.66	31.2 QP	40.0	-8.8	2.41 V	129	40.9	-9.7
2	145.34	30.1 QP	43.5	-13.4	1.45 V	232	38.0	-7.9
3	164.74	31.2 QP	43.5	-12.3	2.95 V	134	39.1	-7.9
4	215.27	26.8 QP	43.5	-16.7	1.50 V	305	38.0	-11.2
5	237.53	29.2 QP	46.0	-16.8	1.14 V	133	38.7	-9.5
6	841.39	36.5 QP	46.0	-9.5	1.14 V	205	32.0	4.5

**REMARKS:**

1. Emission Level(dBuV/m) = Raw Value(dBuV) + Correction Factor(dB/m)
2. Correction Factor(dB/m) = Antenna Factor(dB/m) + Cable Factor(dB) – Pre-Amplifier Factor(dB)
3. The other emission levels were very low against the limit.
4. Margin value = Emission Level – Limit value

## 4.2 Conducted Emission Measurement

### 4.2.1 Limits of Conducted Emission Measurement

Frequency (MHz)	Conducted Limit (dBuV)	
	Quasi-peak	Average
0.15 - 0.5	66 - 56	56 - 46
0.50 - 5.0	56	46
5.0 - 30.0	60	50

Note: 1. The lower limit shall apply at the transition frequencies.

2. The limit decreases in line with the logarithm of the frequency in the range of 0.15 to 0.50MHz.

### 4.2.2 Test Instruments

DESCRIPTION & MANUFACTURER	MODEL NO.	SERIAL NO.	CALIBRATED DATE	CALIBRATED UNTIL
Test Receiver R&S	ESCS 30	847124/029	Nov. 01, 2017	Oct. 31, 2018
Line-Impedance Stabilization Network (for EUT) R&S	ESH3-Z5	848773/004	Nov. 15, 2017	Nov. 14, 2018
Line-Impedance Stabilization Network (for Peripheral) R&S	ENV216	100072	June 03, 2017	June 02, 2018
50 ohms Terminator	N/A	EMC-02	Sep. 22, 2017	Sep. 21, 2018
RF Cable	5D-FB	COCCAB-001	Sep. 29, 2017	Sep. 28, 2018
Fixed attenuator EMEC	STI02-2200-10	003	Mar. 16, 2018	Mar. 15, 2019
Software BVADT	BVADT_Cond_ V7.3.7.4	NA	NA	NA

**Note:**

1. The calibration interval of the above test instruments are 12 months and the calibrations are traceable to NML/ROC and NIST/USA.
2. The test was performed in Conduction 1.
3. Tested Date: Apr. 24, 2018

#### 4.2.3 Test Procedure

- The EUT was placed 0.4 meters from the conducting wall of the shielded room with EUT being connected to the power mains through a line impedance stabilization network (LISN). Other support units were connected to the power mains through another LISN. The two LISNs provide 50 ohm/ 50uH of coupling impedance for the measuring instrument.
- Both lines of the power mains connected to the EUT were checked for maximum conducted interference.
- The frequency range from 150kHz to 30MHz was searched. Emission levels under (Limit - 20dB) was not recorded.

**NOTE:** All modes of operation were investigated and the worst-case emissions are reported.

#### 4.2.4 Deviation from Test Standard

No deviation.

#### 4.2.5 Test Setup

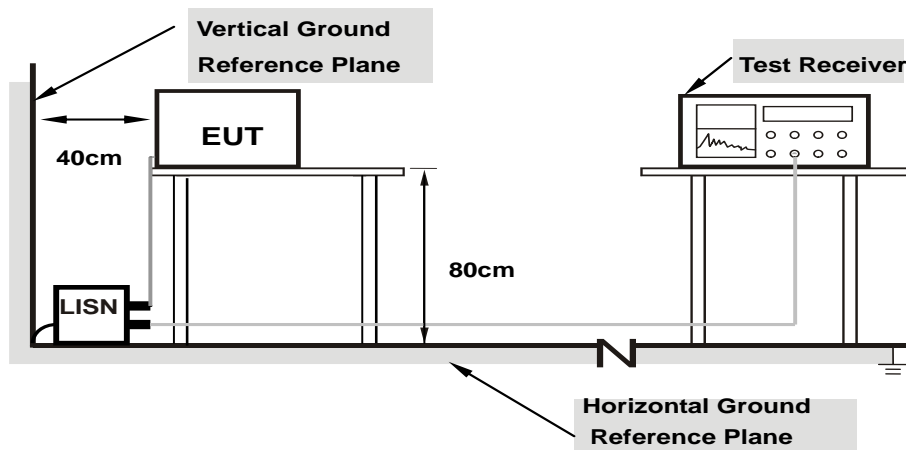

**Note: 1.Support units were connected to second LISN.**

For the actual test configuration, please refer to the attached file (Test Setup Photo).

#### 4.2.6 EUT Operating Condition

Same as 4.1.6.

#### 4.2.7 Test Results

Phase	Line (L)	Detector Function	Quasi-Peak (QP) / Average (AV)
-------	----------	-------------------	--------------------------------

No	Freq. [MHz]	Corr.	Reading Value		Emission Level		Limit		Margin	
		Factor (dB)	[dB (uV)]		[dB (uV)]		[dB (uV)]		(dB)	
	Q.P.	AV.	Q.P.	AV.	Q.P.	AV.	Q.P.	AV.	Q.P.	AV.
1	0.17734	10.05	34.63	14.55	44.68	24.60	64.61	54.61	-19.93	-30.01
2	0.22422	10.07	26.60	18.74	36.67	28.81	62.66	52.66	-25.99	-23.85
3	0.82578	10.14	24.46	7.60	34.60	17.74	56.00	46.00	-21.40	-28.26
4	2.75391	10.22	25.47	14.64	35.69	24.86	56.00	46.00	-20.31	-21.14
5	7.98438	10.45	19.81	10.70	30.26	21.15	60.00	50.00	-29.74	-28.85
6	17.94922	10.99	16.11	9.37	27.10	20.36	60.00	50.00	-32.90	-29.64

#### Remarks:

1. Q.P. and AV. are abbreviations of quasi-peak and average individually.
2. The emission levels of other frequencies were very low against the limit.
3. Margin value = Emission level – Limit value
4. Correction factor = Insertion loss + Cable loss
5. Emission Level = Correction Factor + Reading Value

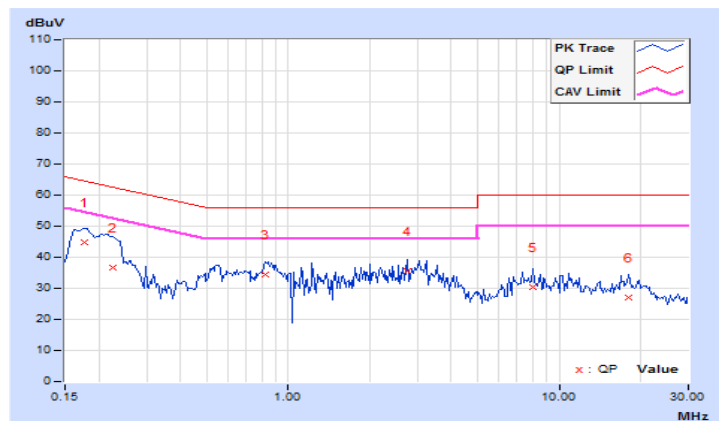

Phase	Neutral (N)	Detector Function	Quasi-Peak (QP) / Average (AV)
-------	-------------	-------------------	--------------------------------

No	Freq. [MHz]	Corr. Factor	Reading Value [dB (uV)]		Emission Level [dB (uV)]		Limit [dB (uV)]		Margin (dB)	
		(dB)	Q.P.	AV.	Q.P.	AV.	Q.P.	AV.	Q.P.	AV.
	<b>1</b>	<b>0.15000</b>	<b>9.94</b>	<b>41.38</b>	<b>18.73</b>	<b>51.32</b>	<b>28.67</b>	<b>66.00</b>	<b>56.00</b>	<b>-14.68</b>
2	0.21250	9.96	32.49	5.06	42.45	15.02	63.11	53.11	-20.66	-38.09
3	0.54063	10.01	19.73	1.30	29.74	11.31	56.00	46.00	-26.26	-34.69
4	0.89219	10.02	22.47	3.40	32.49	13.42	56.00	46.00	-23.51	-32.58
5	2.96875	10.10	25.45	15.26	35.55	25.36	56.00	46.00	-20.45	-20.64
6	20.80859	10.90	14.16	7.45	25.06	18.35	60.00	50.00	-34.94	-31.65

**Remarks:**

1. Q.P. and AV. are abbreviations of quasi-peak and average individually.
2. The emission levels of other frequencies were very low against the limit.
3. Margin value = Emission level – Limit value
4. Correction factor = Insertion loss + Cable loss
5. Emission Level = Correction Factor + Reading Value

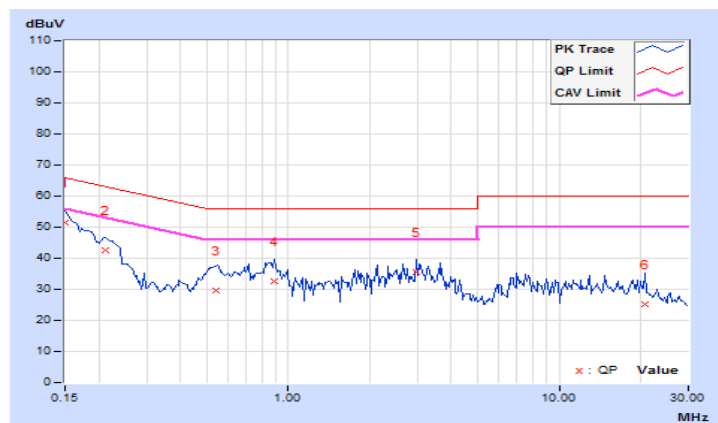

### 4.3 Transmit Power Measurement

#### 4.3.1 Limits of Transmit Power Measurement

Operation Band	EUT Category		Limit
U-NII-1		Outdoor Access Point	1 Watt (30 dBm) (Max. e.i.r.p $\leq$ 125mW(21 dBm) at any elevation angle above 30 degrees as measured from the horizon)
		Fixed point-to-point Access Point	1 Watt (30 dBm)
		Indoor Access Point	1 Watt (30 dBm)
	√	Client device	250mW (24 dBm)
U-NII-2A		√	250mW (24 dBm) or 11 dBm+10 log B*
U-NII-2C		√	250mW (24 dBm) or 11 dBm+10 log B*
U-NII-3		√	1 Watt (30 dBm)

\*B is the 26 dB emission bandwidth in megahertz

Per KDB 662911 Method of conducted output power measurement on IEEE 802.11 devices,

Array Gain = 0 dB (i.e., no array gain) for  $N_{ANT} \leq 4$ ;

Array Gain = 0 dB (i.e., no array gain) for channel widths  $\geq 40$  MHz for any  $N_{ANT}$ ;

Array Gain =  $5 \log(N_{ANT}/N_{SS})$  dB or 3 dB, whichever is less for 20-MHz channel widths with  $N_{ANT} \geq 5$ .

For power measurements on all other devices: Array Gain =  $10 \log(N_{ANT}/N_{SS})$  dB.

#### 4.3.2 Test Setup

##### FOR POWER OUTPUT MEASUREMENT

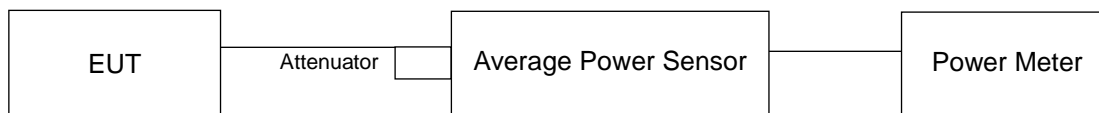

##### FOR 26dB OCCUPIED BANDWIDTH

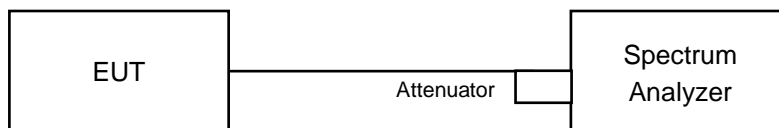



#### 4.3.3 Test Instruments

Refer to section 4.1.2 to get information of above instrument.

#### 4.3.4 Test Procedure

##### For Average Power Measurement

Method PM is used to perform output power measurement, trigger and gating function of wide band power meter is enabled to measure max output power of TX on burst. Duty factor is not added to measured value.

##### For 26dB Occupied Bandwith

1. Set RBW = approximately 1% of the emission bandwidth.
2. Set the VBW > RBW.
3. Detector = Peak.
4. Trace mode = max hold.
5. Measure the maximum width of the emission that is 26 dB down from the peak of the emission. Compare this with the RBW setting of the analyzer. Readjust RBW and repeat measurement as needed until the RBW/EBW ratio is approximately 1%.

#### 4.3.5 Deviation from Test Standard

No deviation.

#### 4.3.6 EUT Operating Condition

The software provided by client to enable the EUT under transmission condition continuously at lowest, middle and highest channel frequencies individually.

#### 4.3.7 Test Result

##### 802.11a

##### Power Output:

Chan.	Chan. Freq. (MHz)	Maximum Conducted Power (dBm)		Total Power (mW)	Total Power (dBm)	Limit (dBm)	Pass / Fail
		Chain 0	Chain 1				
36	5180	20.04	19.31	186.235	22.70	24.00	Pass
40	5200	21.10	20.79	248.775	23.96	24.00	Pass
48	5240	20.74	20.16	222.33	23.47	24.00	Pass
52	5260	21.03	20.36	235.408	23.72	24.00	Pass
60	5300	21.15	20.16	234.07	23.69	24.00	Pass
64	5320	19.68	18.89	170.343	22.31	24.00	Pass
100	5500	19.43	19.40	174.796	22.43	24.00	Pass
116	5580	19.97	19.95	198.167	22.97	24.00	Pass
140	5700	19.07	18.77	156.06	21.93	24.00	Pass
149	5745	22.20	21.71	314.211	24.97	30.00	Pass
157	5785	22.17	21.88	318.986	25.04	30.00	Pass
165	5825	22.15	22.15	328.118	25.16	30.00	Pass

##### 26dB OCCUPIED BANDWIDTH

Channel	Frequency (MHz)	26dBc Bandwidth (MHz)	
		Chain 0	Chain 1
52	5260	35.71	35.45
60	5300	35.85	35.47
64	5320	29.60	28.70
100	5500	29.85	29.09
116	5580	31.71	30.91
140	5700	28.62	27.15

**Note: For U-NII-2A, U-NII-2C Band output power limitation is determined based on 26dBc bandwidth**

Power Limit =  $11\text{dBm} + 10\log B < \text{U-NII-2A, U-NII-2C} >$

Channel Number	Freq.(MHz)	Min. B(MHz)	Determined Conducted Limit (dBm)
52	5260	35.45	26.49 > 24
60	5300	35.47	26.49 > 24
64	5320	28.70	25.57 > 24
100	5500	29.09	25.63 > 24
116	5580	30.91	25.9 > 24
140	5700	27.15	25.33 > 24

## 802.11ac (VHT20)

### Power Output:

Chan.	Chan. Freq. (MHz)	Maximum Conducted Power (dBm)		Total Power (mW)	Total Power (dBm)	Limit (dBm)	Pass / Fail
		Chain 0	Chain 1				
36	5180	20.06	19.44	189.293	22.77	24.00	Pass
40	5200	20.96	20.68	241.688	23.83	24.00	Pass
48	5240	20.57	20.16	217.778	23.38	24.00	Pass
52	5260	21.14	20.33	237.912	23.76	24.00	Pass
60	5300	20.62	19.98	214.886	23.32	24.00	Pass
64	5320	19.77	18.84	171.402	22.34	24.00	Pass
100	5500	18.83	19.05	156.737	21.95	24.00	Pass
116	5580	19.41	19.46	175.605	22.45	24.00	Pass
140	5700	18.29	18.45	137.437	21.38	24.00	Pass
149	5745	21.46	21.48	280.564	24.48	30.00	Pass
157	5785	21.38	21.58	281.284	24.49	30.00	Pass
165	5825	21.46	21.67	286.852	24.58	30.00	Pass

Note: \* Test was performed in accordance with Measurement follow FCC KDB 789033 UNII test procedure Method SA-2 and use spectrum analyzer test.

### 26dB OCCUPIED BANDWIDTH

Channel	Frequency (MHz)	26dBc Bandwidth (MHz)	
		Chain 0	Chain 1
52	5260	36.58	38.63
60	5300	36.07	37.90
64	5320	29.44	32.34
100	5500	24.69	29.72
116	5580	29.67	30.34
140	5700	25.22	29.68

Note: For U-NII-2A, U-NII-2C Band output power limitation is determined based on 26dBc bandwidth

Power Limit =  $11\text{dBm} + 10\log B < \text{U-NII-2A, U-NII-2C} >$

Channel Number	Freq.(MHz)	Min. B(MHz)	Determined Conducted Limit (dBm)
52	5260	36.58	26.63 > 24
60	5300	36.07	26.57 > 24
64	5320	29.44	25.68 > 24
100	5500	24.69	24.92 > 24
116	5580	29.67	25.72 > 24
140	5700	25.22	25.01 > 24

## 802.11ac (VHT40)

### Power Output:

Chan.	Chan. Freq. (MHz)	Maximum Conducted Power (dBm)		Total Power (mW)	Total Power (dBm)	Limit (dBm)	Pass / Fail
		Chain 0	Chain 1				
38	5190	17.33	16.59	99.679	19.99	24.00	Pass
46	5230	19.61	18.99	170.661	22.32	24.00	Pass
54	5270	20.64	19.81	211.597	23.26	24.00	Pass
62	5310	17.40	16.48	99.417	19.97	24.00	Pass
102	5510	16.50	16.60	90.377	19.56	24.00	Pass
110	5550	19.34	19.38	172.597	22.37	24.00	Pass
134	5670	18.24	18.35	135.072	21.31	24.00	Pass
151	5755	19.89	19.81	193.218	22.86	30.00	Pass
159	5795	21.29	21.07	262.524	24.19	30.00	Pass

Note: \* Test was performed in accordance with Measurement follow FCC KDB 789033 UNII test procedure Method SA-2 and use spectrum analyzer test.

### 26dB OCCUPIED BANDWIDTH

Channel	Frequency (MHz)	26dBc Bandwidth (MHz)	
		Chain 0	Chain 1
54	5270	75.20	79.69
62	5310	42.09	41.85
102	5510	41.90	41.83
110	5550	69.31	68.91
134	5670	65.17	66.52

**Note: For U-NII-2A, U-NII-2C Band output power limitation is determined based on 26dBc bandwidth**

Power Limit = 11dBm + 10logB < U-NII-2A, U-NII-2C >			
Channel Number	Freq.(MHz)	Min. B(MHz)	Determined Conducted Limit (dBm)
54	5270	75.20	29.76 > 24
62	5310	41.85	27.21 > 24
102	5510	41.83	27.21 > 24
110	5550	68.91	29.38 > 24
134	5670	65.17	29.14 > 24

### 802.11ac (VHT80)

#### Power Output:

Chan.	Chan. Freq. (MHz)	Maximum Conducted Power (dBm)		Total Power (mW)	Total Power (dBm)	Limit (dBm)	Pass / Fail
		Chain 0	Chain 1				
42	5210	16.29	15.58	78.701	18.96	24.00	Pass
58	5290	14.58	13.59	51.564	17.12	24.00	Pass
106	5530	13.72	13.73	47.155	16.74	24.00	Pass
122	5610	18.67	18.63	146.567	21.66	24.00	Pass
155	5775	18.16	18.09	129.881	21.14	30.00	Pass

Note: \* Test was performed in accordance with Measurement follow FCC KDB 789033 UNII test procedure Method SA-2 and use spectrum analyzer test.

#### 26dB OCCUPIED BANDWIDTH

Channel	Frequency (MHz)	26dBc Bandwidth (MHz)	
		Chain 0	Chain 1
58	5290	97.14	82.52
106	5530	81.68	82.29
122	5610	176.17	113.99

**Note: For U-NII-2A, U-NII-2C Band output power limitation is determined based on 26dBc bandwidth**

Power Limit = 11dBm + 10logB < U-NII-2A, U-NII-2C >			
Channel Number	Freq.(MHz)	Min. B(MHz)	Determined Conducted Limit (dBm)
58	5290	82.52	30.16 > 24
106	5530	81.68	30.12 > 24
122	5610	113.99	31.56 > 24

### Spectrum Plot of Worst Value

**802.11a / Chain 1 : CH140**

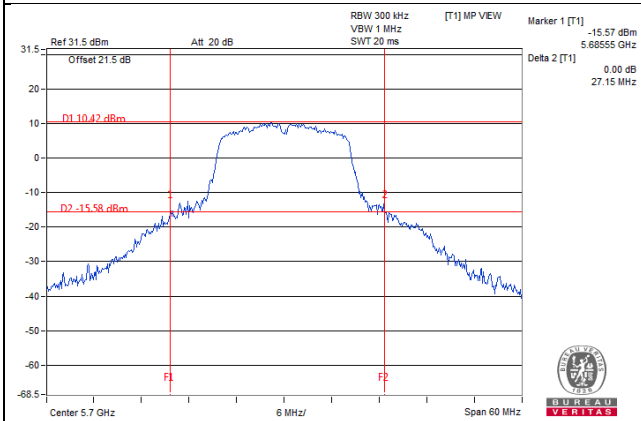

**802.11ac (VHT20) / Chain 0 : CH100**

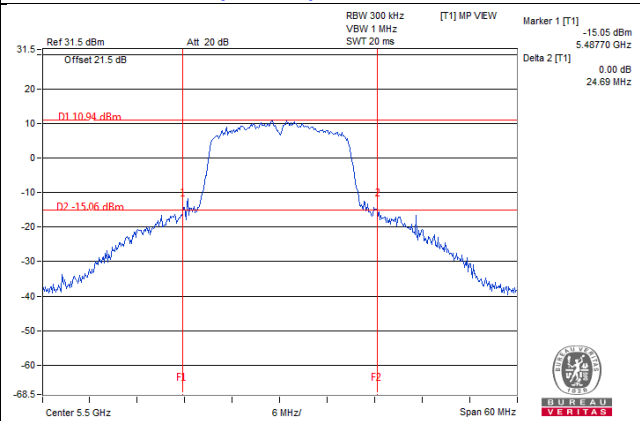

**802.11ac (VHT40) / Chain 1 : CH102**

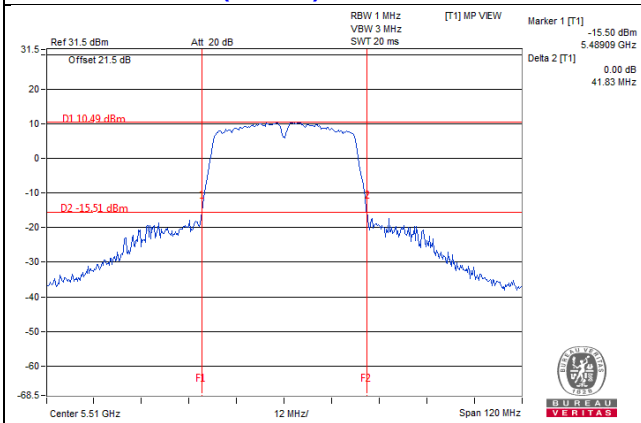

**802.11ac (VHT80) / Chain 0 : CH106**

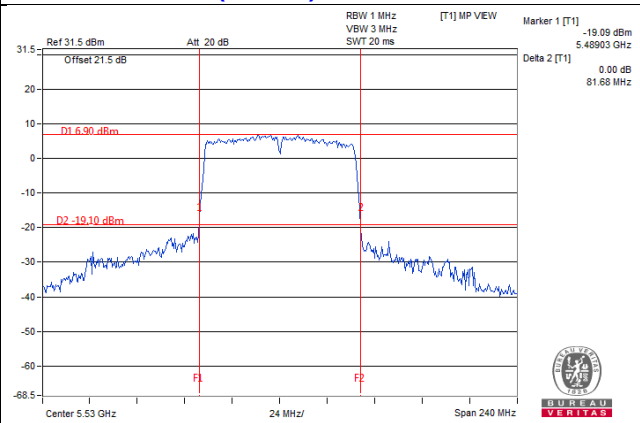



## 4.4 Occupied Bandwidth Measurement

### 4.4.1 Test Setup



### 4.4.2 Test Instruments

Refer to section 4.1.2 to get information of above instrument.

### 4.4.3 Test Procedure

The transmitter output was connected to the spectrum analyzer through an attenuator. The bandwidth of the fundamental frequency was measured by spectrum analyzer with resolution bandwidth in the range of 1% to 5% of the anticipated emission bandwidth, and a video bandwidth at least 3x the resolution bandwidth and set the detector to SAMPLE. The width of a frequency band such that, below the lower and above the upper frequency limits, the mean powers emitted are each equal to a specified percentage 0.5 %of the total mean power of a given emission.

#### 4.4.4 Test Results

##### 802.11a

Channel	Channel Frequency (MHz)	Occupied Bandwidth (MHz)	
		Chain 0	Chain 1
36	5180	17.04	17.04
40	5200	18.24	17.76
48	5240	17.52	17.40
52	5260	18.72	18.36
60	5300	19.44	18.84
64	5320	17.04	17.04
100	5500	17.04	16.68
116	5580	17.40	17.28
140	5700	16.92	16.92
149	5745	22.68	23.52
157	5785	23.40	23.76
165	5825	23.52	23.40

##### 802.11ac (VHT20)

Channel	Channel Frequency (MHz)	Occupied Bandwidth (MHz)	
		Chain 0	Chain 1
36	5180	18.12	18.24
40	5200	18.48	20.28
48	5240	18.24	18.72
52	5260	19.20	18.48
60	5300	18.36	18.84
64	5320	18.00	18.00
100	5500	17.76	17.76
116	5580	17.88	18.00
140	5700	17.64	17.76
149	5745	22.08	23.64
157	5785	22.44	24.00
165	5825	23.28	25.20

**802.11ac (VHT40)**

Channel	Channel Frequency (MHz)	Occupied Bandwidth (MHz)	
		Chain 0	Chain 1
38	5190	36.24	36.48
46	5230	36.72	36.96
54	5270	36.96	38.88
62	5310	36.24	36.48
102	5510	36.24	36.72
110	5550	36.72	36.96
134	5670	36.48	36.72
151	5755	37.20	37.44
159	5795	37.92	38.16

**802.11ac (VHT80)**

Channel	Channel Frequency (MHz)	Occupied Bandwidth (MHz)	
		Chain 0	Chain 1
42	5210	76.32	76.32
58	5290	75.84	76.32
106	5530	75.84	75.84
122	5610	79.68	76.32
155	5775	76.32	76.32

### Spectrum Plot of Worst Value

**802.11a / Chain 1 : CH157**

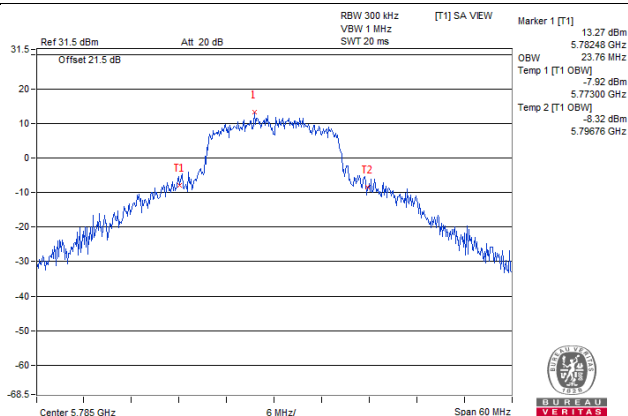

**802.11ac (VHT20) / Chain 1 : CH165**

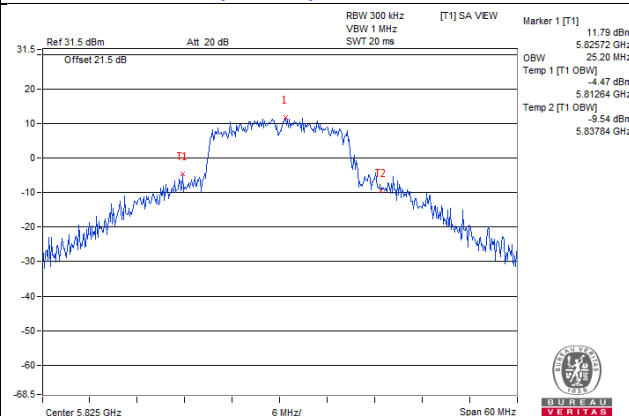

**802.11ac (VHT40) / Chain 1 : CH159**

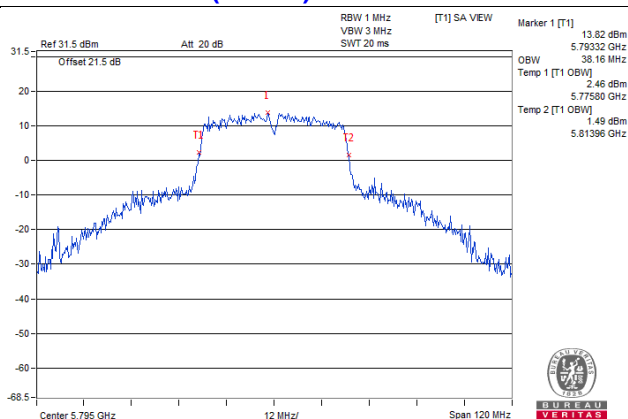

**802.11ac (VHT80) / Chain 0 : CH122**

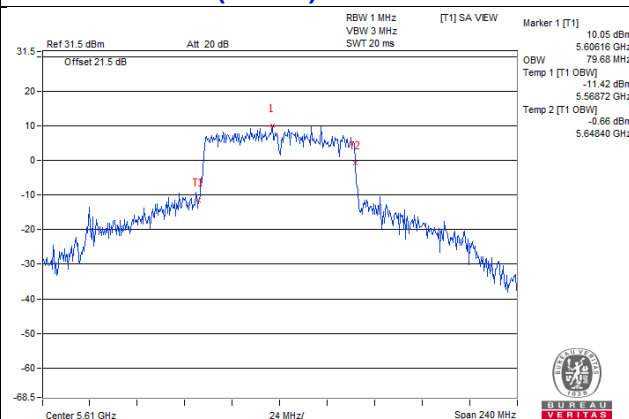

### Spectrum Plot for near by DFS band (DFS is required, if 99% OCP straddle into U-NII-2A band)

**802.11a\_Chain0 / CH48**

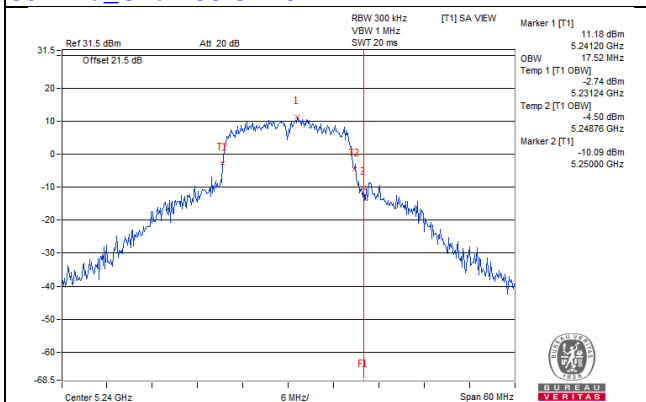

**802.11a\_Chain1 / CH48**

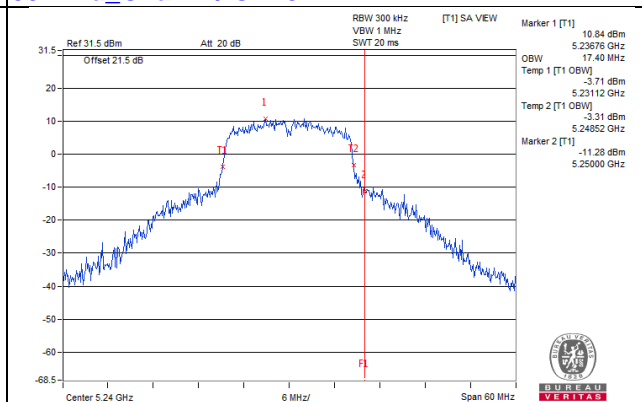

**802.11ac(VHT20)\_Chain0 / CH48**

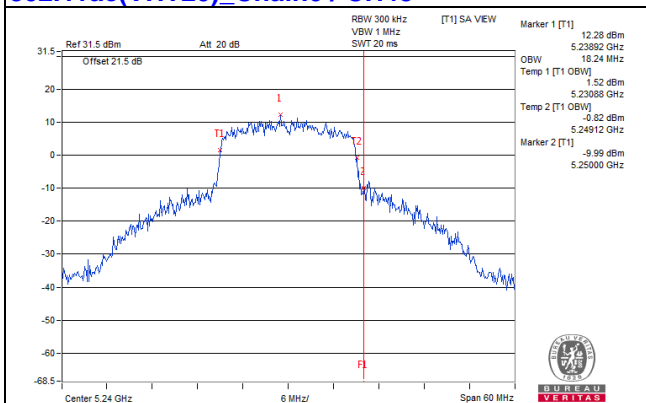

**802.11ac(VHT20)\_Chain1 / CH48**

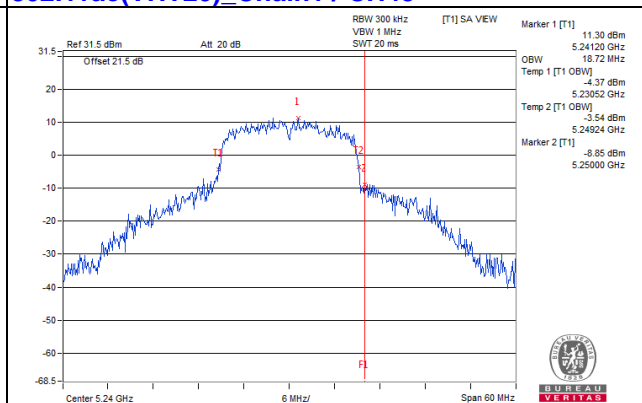

**802.11ac(VHT40)\_Chain0 / CH46**

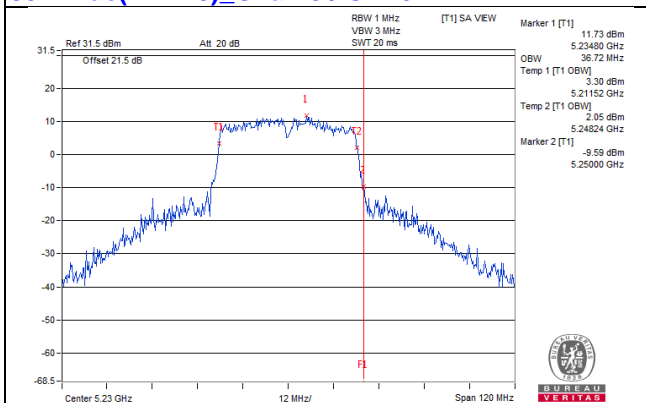

**802.11ac(VHT40)\_Chain1 / CH46**

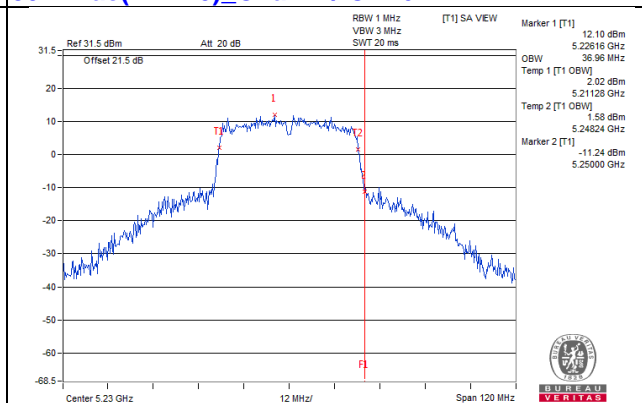

**802.11ac(VHT80)\_Chain0 / CH42**

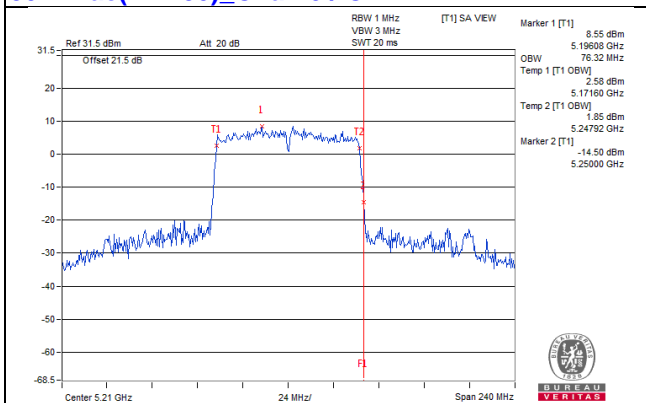

**802.11ac(VHT80)\_Chain1 / CH42**

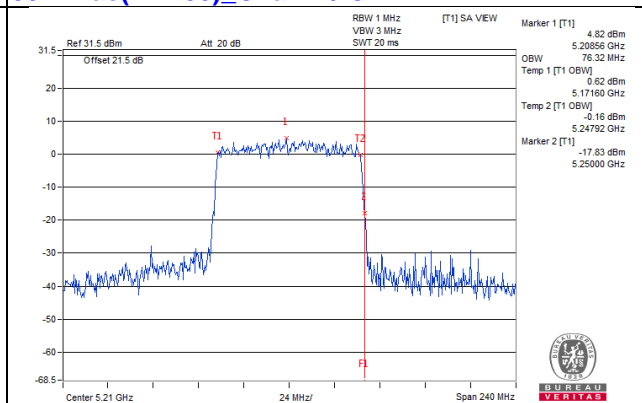

### Spectrum Plot for near by DFS band (DFS is required, if 99% OCP straddle into U-NII-2C band)

**802.11a\_Chain0 / CH149**

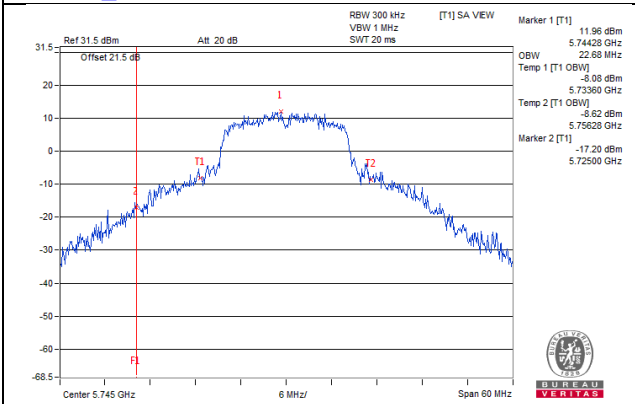

**802.11a\_Chain1 / CH149**

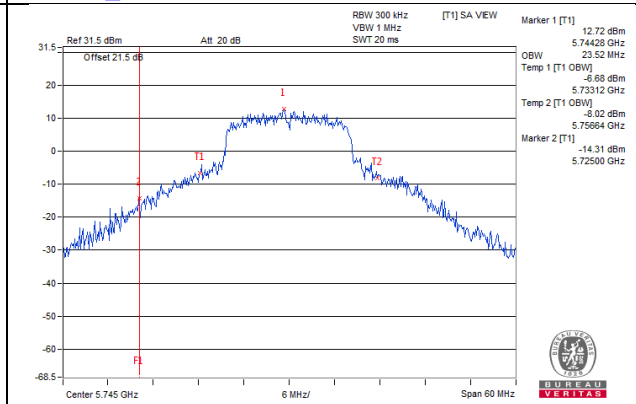

**802.11ac(VHT20)\_Chain0 / CH149**

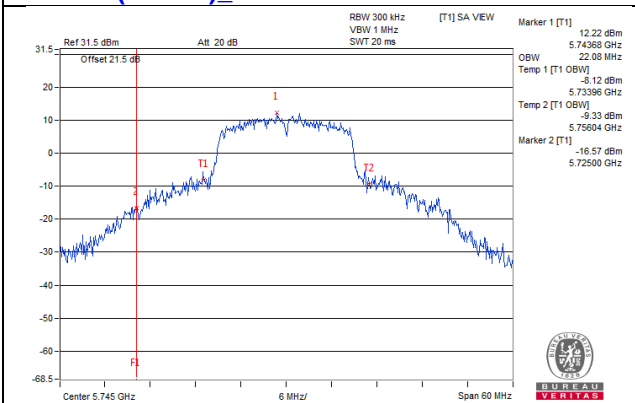

**802.11ac(VHT20)\_Chain1 / CH149**

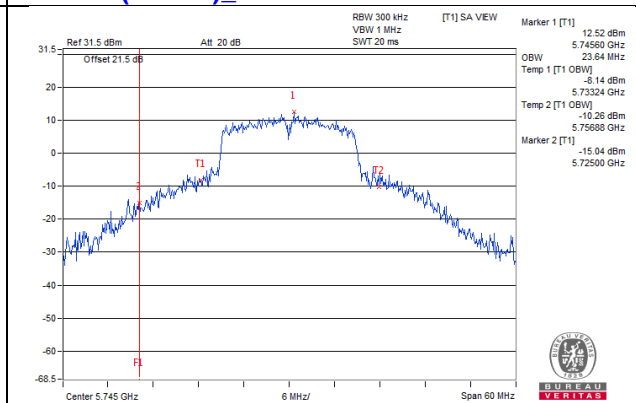

**802.11ac(VHT40)\_Chain0 / CH151**

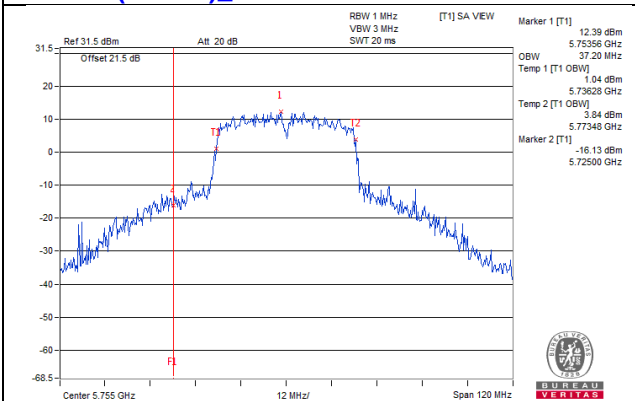

**802.11ac(VHT40)\_Chain1 / CH151**

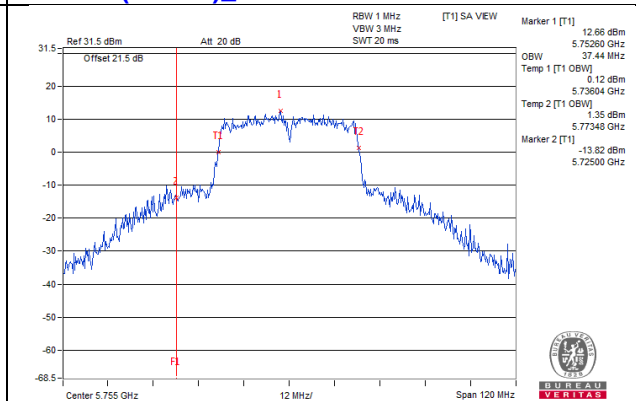

**802.11ac(VHT80)\_Chain0 / CH155**

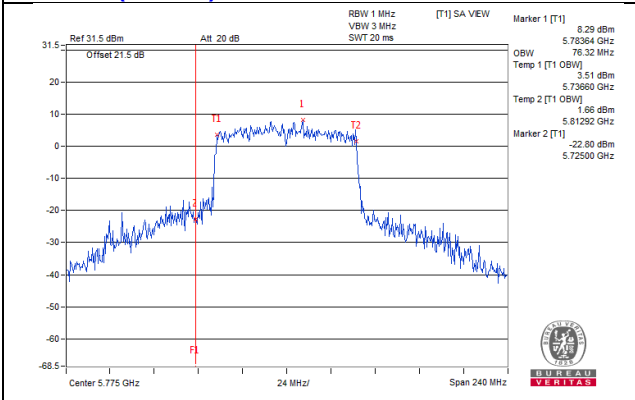

**802.11ac(VHT80)\_Chain1 / CH155**

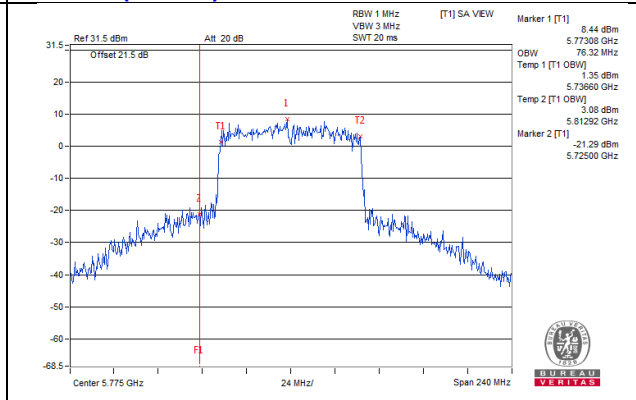

## 4.5 Peak Power Spectral Density Measurement

### 4.5.1 Limits of Peak Power Spectral Density Measurement

Operation Band	EUT Category		Limit
U-NII-1		Outdoor Access Point	17dBm/ MHz
		Fixed point-to-point Access Point	
		Indoor Access Point	
	√	Client device	11dBm/ MHz
U-NII-2A		√	11dBm/ MHz
U-NII-2C		√	11dBm/ MHz
U-NII-3		√	30dBm/ 500kHz

### 4.5.2 Test Setup

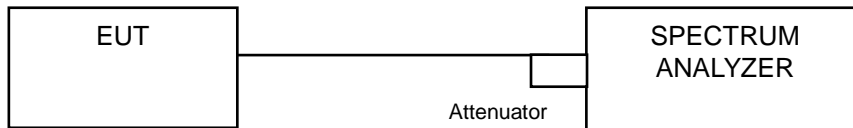

### 4.5.3 Test Instruments

Refer to section 4.1.2 to get information of above instrument.

### 4.5.4 Test Procedure

#### For U-NII-1, U-NII-2A, U-NII-2C:

Using method SA-2

1. Set span to encompass the entire emission bandwidth (EBW) of the signal.
2. Set RBW = 1 MHz, Set VBW  $\geq$  3 MHz, Detector = RMS
3. Sweep time = auto, trigger set to "free run".
4. Trace average at least 100 traces in power averaging mode.
5. Record the max value and add 10 log (1/duty cycle)

#### For U-NII-3:

1. Set span to encompass the entire emission bandwidth (EBW) of the signal.
2. Set RBW = 300 kHz, Set VBW  $\geq$  1 MHz, Detector = RMS
3. Use the peak marker function to determine the maximum power level in any 300 kHz band segment within the fundamental EBW.
4. Scale the observed power level to an equivalent value in 500 kHz by adjusting (reducing) the measured power by a bandwidth correction factor (BWCF) where  $BWCF = 10\log(500\text{ kHz}/300\text{kHz})$
5. Sweep time = auto, trigger set to "free run".
6. Trace average at least 100 traces in power averaging mode.
7. Record the max value and add 10 log (1/duty cycle)

#### 4.5.5 Deviation from Test Standard

No deviation.

#### 4.5.6 EUT Operating Condition

Same as Item 4.3.6.



#### 4.5.7 Test Results

**For U-NII-1, U-NII-2A, U-NII-2C:**

##### 802.11a

Chan.	Chan. Freq. (MHz)	PSD W/O Duty Factor (dBm/MHz)		Duty Factor (dB)	Total PSD With Duty Factor (dBm/MHz)	MAX. Limit (dBm/MHz)	Pass / Fail
		Chain 0	Chain 1				
36	5180	6.72	6.24	0.11	9.61	11.00	Pass
40	5200	7.78	7.83	0.11	10.93	11.00	Pass
48	5240	7.40	7.31	0.11	10.48	11.00	Pass
52	5260	7.91	7.76	0.11	10.96	11.00	Pass
60	5300	7.17	8.02	0.11	10.74	11.00	Pass
64	5320	6.85	6.45	0.11	9.78	11.00	Pass
100	5500	6.55	6.40	0.11	9.60	11.00	Pass
116	5580	7.14	7.24	0.11	10.31	11.00	Pass
140	5700	5.79	5.45	0.11	8.75	11.00	Pass

- Note:**
- Method a) of power density measurement of KDB 662911 is using for calculating total power density. Total power density is summing entire spectra across corresponding frequency bins on the various outputs by computer.
  - For UNII-1: Directional gain =  $10 \log[(10^{G_0/20} + 10^{G_1/20})^2 / 2] = 5.87 < 6\text{dBi}$ , so the power density limit shall not be reduced.
  - For UNII-2a: Directional gain =  $10 \log[(10^{G_0/20} + 10^{G_1/20})^2 / 2] = 5.67 < 6\text{dBi}$ , so the power density limit shall not be reduced.
  - For UNII-2c: Directional gain =  $10 \log[(10^{G_0/20} + 10^{G_1/20})^2 / 2] = 5.66 < 6\text{dBi}$ , so the power density limit shall not be reduced.
  - Refer to section 3.3 for duty cycle spectrum plot.

**802.11ac (VHT20)**

Chan.	Chan. Freq. (MHz)	PSD W/O Duty Factor (dBm/MHz)		Duty Factor (dB)	Total PSD With Duty Factor (dBm/MHz)	MAX. Limit (dBm/MHz)	Pass / Fail
		Chain 0	Chain 1				
36	5180	6.38	6.01	0.22	9.43	11.00	Pass
40	5200	7.77	7.20	0.22	10.73	11.00	Pass
48	5240	7.23	6.85	0.22	10.28	11.00	Pass
52	5260	7.75	7.32	0.22	10.77	11.00	Pass
60	5300	7.50	6.85	0.22	10.42	11.00	Pass
64	5320	6.42	6.19	0.22	9.54	11.00	Pass
100	5500	5.67	5.21	0.22	8.68	11.00	Pass
116	5580	5.90	5.77	0.22	9.07	11.00	Pass
140	5700	5.16	5.47	0.22	8.55	11.00	Pass

- Note:**
- Method a) of power density measurement of KDB 662911 is using for calculating total power density. Total power density is summing entire spectra across corresponding frequency bins on the various outputs by computer.
  - For UNII-1: Directional gain =  $10 \log[(10^{G0/20} + 10^{G1/20})^2 / 2] = 5.87 < 6\text{dBi}$  , so the power density limit shall not be reduced.
  - For UNII-2a: Directional gain =  $10 \log[(10^{G0/20} + 10^{G1/20})^2 / 2] = 5.67 < 6\text{dBi}$  , so the power density limit shall not be reduced.
  - For UNII-2c: Directional gain =  $10 \log[(10^{G0/20} + 10^{G1/20})^2 / 2] = 5.66 < 6\text{dBi}$  , so the power density limit shall not be reduced.
  - Refer to section 3.3 for duty cycle spectrum plot.

**802.11ac (VHT40)**

Chan.	Chan. Freq. (MHz)	PSD W/O Duty Factor (dBm/MHz)		Duty Factor (dB)	Total PSD With Duty Factor (dBm/MHz)	MAX. Limit (dBm/MHz)	Pass / Fail
		Chain 0	Chain 1				
38	5190	0.04	-0.31	0.42	3.30	11.00	Pass
46	5230	2.17	2.07	0.42	5.55	11.00	Pass
54	5270	3.29	3.12	0.42	6.64	11.00	Pass
62	5310	0.45	0.10	0.42	3.71	11.00	Pass
102	5510	-0.36	-0.81	0.42	2.86	11.00	Pass
110	5550	2.35	1.77	0.42	5.50	11.00	Pass
134	5670	0.76	0.37	0.42	4.00	11.00	Pass

- Note:**
- Method a) of power density measurement of KDB 662911 is using for calculating total power density. Total power density is summing entire spectra across corresponding frequency bins on the various outputs by computer.
  - For UNII-1: Directional gain =  $10 \log[(10^{G0/20} + 10^{G1/20})^2 / 2] = 5.87 < 6\text{dBi}$  , so the power density limit shall not be reduced.
  - For UNII-2a: Directional gain =  $10 \log[(10^{G0/20} + 10^{G1/20})^2 / 2] = 5.67 < 6\text{dBi}$  , so the power density limit shall not be reduced.
  - For UNII-2c: Directional gain =  $10 \log[(10^{G0/20} + 10^{G1/20})^2 / 2] = 5.66 < 6\text{dBi}$  , so the power density limit shall not be reduced.
  - Refer to section 3.3 for duty cycle spectrum plot.

**802.11ac (VHT80)**

Chan.	Chan. Freq. (MHz)	PSD W/O Duty Factor (dBm/MHz)		Duty Factor (dB)	Total PSD With Duty Factor (dBm/MHz)	MAX. Limit (dBm/MHz)	Pass / Fail
		Chain 0	Chain 1				
42	5210	-7.07	-5.77	2.47	-0.89	11.00	Pass
58	5290	-5.27	-7.52	2.47	-0.77	11.00	Pass
106	5530	-5.80	-7.89	2.47	-1.24	11.00	Pass
122	5610	-1.72	-3.71	2.47	2.88	11.00	Pass

- Note:**
- Method a) of power density measurement of KDB 662911 is using for calculating total power density. Total power density is summing entire spectra across corresponding frequency bins on the various outputs by computer.
  - For UNII-1: Directional gain =  $10 \log[(10^{G0/20} + 10^{G1/20})^2 / 2] = 5.87 < 6\text{dBi}$  , so the power density limit shall not be reduced.
  - For UNII-2a: Directional gain =  $10 \log[(10^{G0/20} + 10^{G1/20})^2 / 2] = 5.67 < 6\text{dBi}$  , so the power density limit shall not be reduced.
  - For UNII-2c: Directional gain =  $10 \log[(10^{G0/20} + 10^{G1/20})^2 / 2] = 5.66 < 6\text{dBi}$  , so the power density limit shall not be reduced.
  - Refer to section 3.3 for duty cycle spectrum plot.

Spectrum Plot of Worst Value

802.11a / Chain 1 : CH60

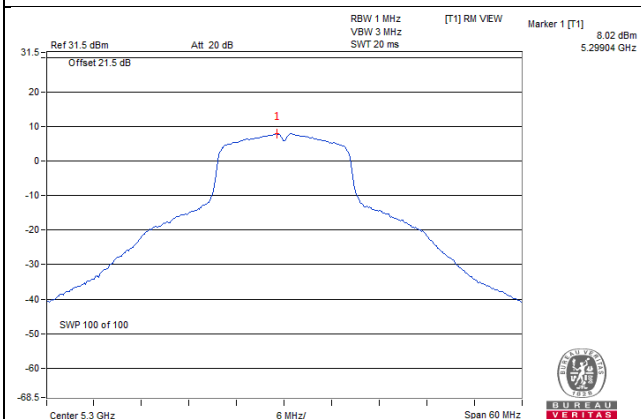

802.11ac (VHT20) / Chain 0 : CH40

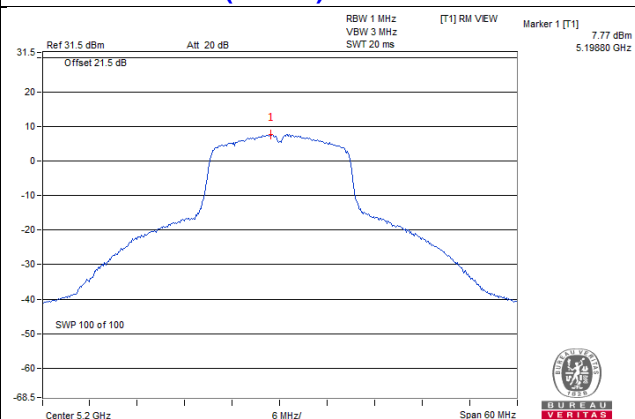

802.11ac (VHT40) / Chain 0 : CH54

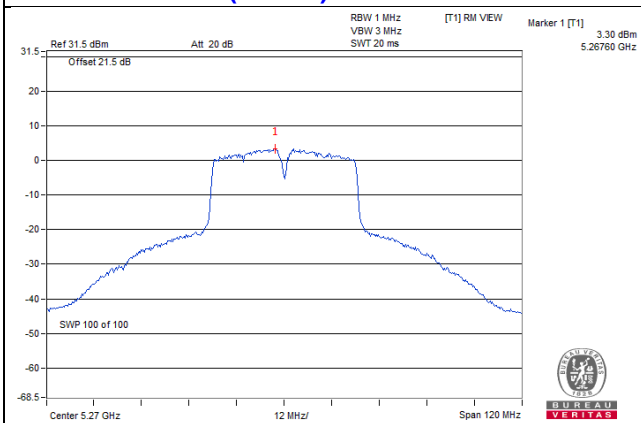

802.11ac (VHT80) / Chain 0 : CH122

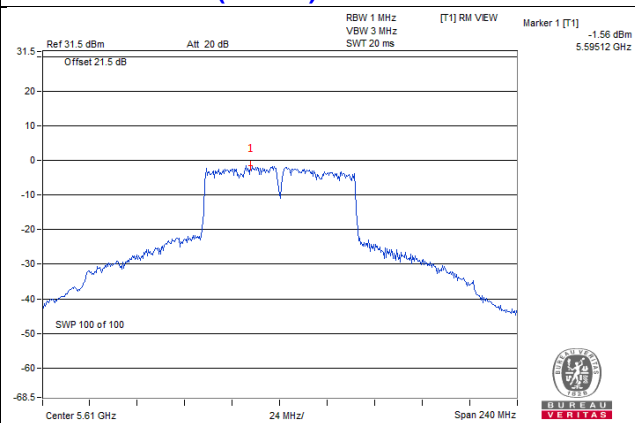

**For U-NII-3:**
**802.11a**

TX chain	Chan.	Chan. Freq. (MHz)	PSD W/O Duty Factor		10 log (N=2) dB	Duty Factor (dB)	Total PSD With Duty Factor (dBm/500kHz)	Limit (dBm/500kHz)	Pass /Fail
			(dBm/300kHz)	(dBm/500kHz)					
0	149	5745	0.42	2.64	3.01	0.11	5.76	30.00	Pass
	157	5785	0.98	3.20	3.01	0.11	6.32	30.00	Pass
	165	5825	0.84	3.06	3.01	0.11	6.18	30.00	Pass
1	149	5745	0.84	3.06	3.01	0.11	6.18	30.00	Pass
	157	5785	0.52	2.74	3.01	0.11	5.86	30.00	Pass
	165	5825	0.63	2.85	3.01	0.11	5.97	30.00	Pass

**Note:** 1. Directional gain =  $10 \log[(10^{G0/20} + 10^{G1/20})^2 / 2] = 4.35\text{dBi} < 6\text{dBi}$ , so the power density limit shall not be reduced.

2. Refer to section 3.3 for duty cycle spectrum plot.

**802.11ac (VHT20)**

TX chain	Chan.	Chan. Freq. (MHz)	PSD W/O Duty Factor		10 log (N=2) dB	Duty Factor (dB)	Total PSD With Duty Factor (dBm/500kHz)	Limit (dBm/500kHz)	Pass /Fail
			(dBm/300kHz)	(dBm/500kHz)					
0	149	5745	0.31	2.53	3.01	0.22	5.76	30.00	Pass
	157	5785	0.29	2.51	3.01	0.22	5.74	30.00	Pass
	165	5825	0.31	2.53	3.01	0.22	5.76	30.00	Pass
1	149	5745	0.39	2.61	3.01	0.22	5.84	30.00	Pass
	157	5785	0.25	2.47	3.01	0.22	5.70	30.00	Pass
	165	5825	0.44	2.66	3.01	0.22	5.89	30.00	Pass

**Note:** 1. Directional gain =  $10 \log[(10^{G0/20} + 10^{G1/20})^2 / 2] = 4.35\text{dBi} < 6\text{dBi}$ , so the power density limit shall not be reduced.

2. Refer to section 3.3 for duty cycle spectrum plot.

### 802.11ac (VHT40)

TX chain	Chan.	Chan. Freq. (MHz)	PSD W/O Duty Factor		10 log (N=2) dB	Duty Factor (dB)	Total PSD With Duty Factor (dBm/500kHz)	Limit (dBm/500kHz)	Pass /Fail
			(dBm/300kHz)	(dBm/500kHz)					
0	151	5755	-5.77	-3.55	3.01	0.42	-0.12	30.00	Pass
	159	5795	-4.35	-2.13	3.01	0.42	1.30	30.00	Pass
1	151	5755	-6.17	-3.95	3.01	0.42	-0.52	30.00	Pass
	159	5795	-5.17	-2.95	3.01	0.42	0.48	30.00	Pass

**Note:** 1. Directional gain =  $10 \log[(10^{G0/20} + 10^{G1/20})^2 / 2] = 4.35\text{dBi} < 6\text{dBi}$ , so the power density limit shall not be reduced.

2. Refer to section 3.3 for duty cycle spectrum plot.

### 802.11ac (VHT80)

TX chain	Chan.	Chan. Freq. (MHz)	PSD W/O Duty Factor		10 log (N=2) dB	Duty Factor (dB)	Total PSD With Duty Factor (dBm/500kHz)	Limit (dBm/500kHz)	Pass /Fail
			(dBm/300kHz)	(dBm/500kHz)					
0	155	5775	-12.65	-10.43	3.01	2.47	-4.95	30.00	Pass
1	155	5775	-12.70	-10.48	3.01	2.47	-5.00	30.00	Pass

**Note:** 1. Directional gain =  $10 \log[(10^{G0/20} + 10^{G1/20})^2 / 2] = 4.35\text{dBi} < 6\text{dBi}$ , so the power density limit shall not be reduced.

2. Refer to section 3.3 for duty cycle spectrum plot.

### Spectrum Plot of Worst Value

**802.11a / Chain 0 : CH157**

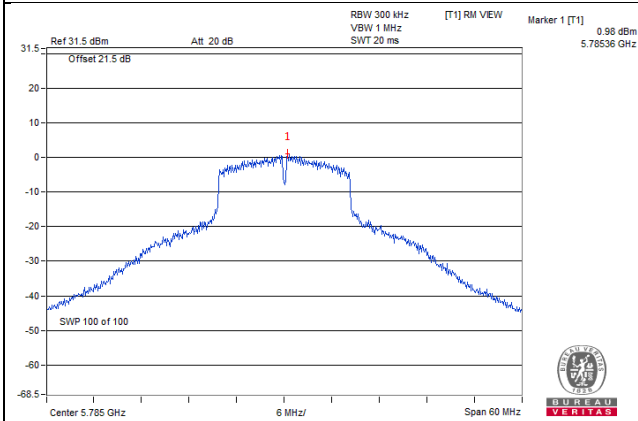

**802.11ac (VHT20) / Chain 1 : CH165**

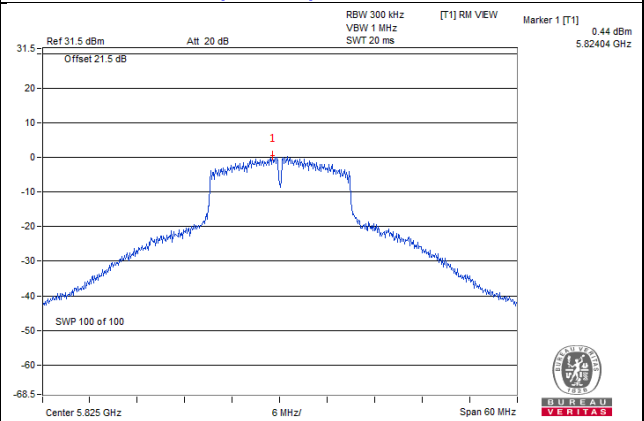

**802.11ac (VHT40) / Chain 0 : CH159**

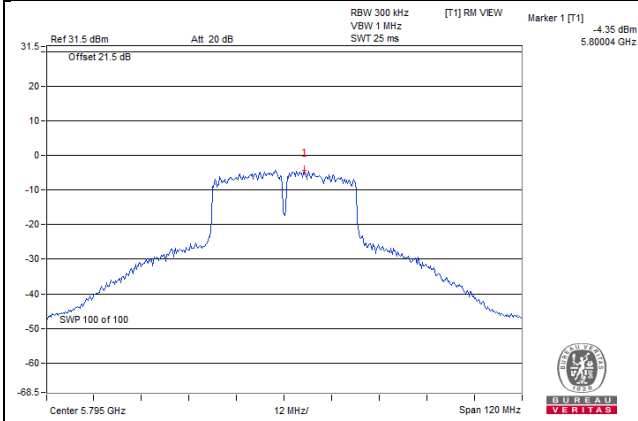

**802.11ac (VHT80) / Chain 0 : CH155**

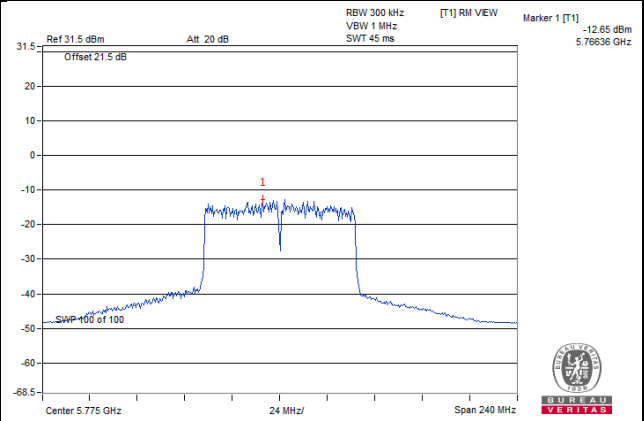

## 4.6 Frequency Stability Measurement

### 4.6.1 Limits of Frequency Stability Measurement

The frequency of the carrier signal shall be maintained within band of operation

### 4.6.2 Test Setup

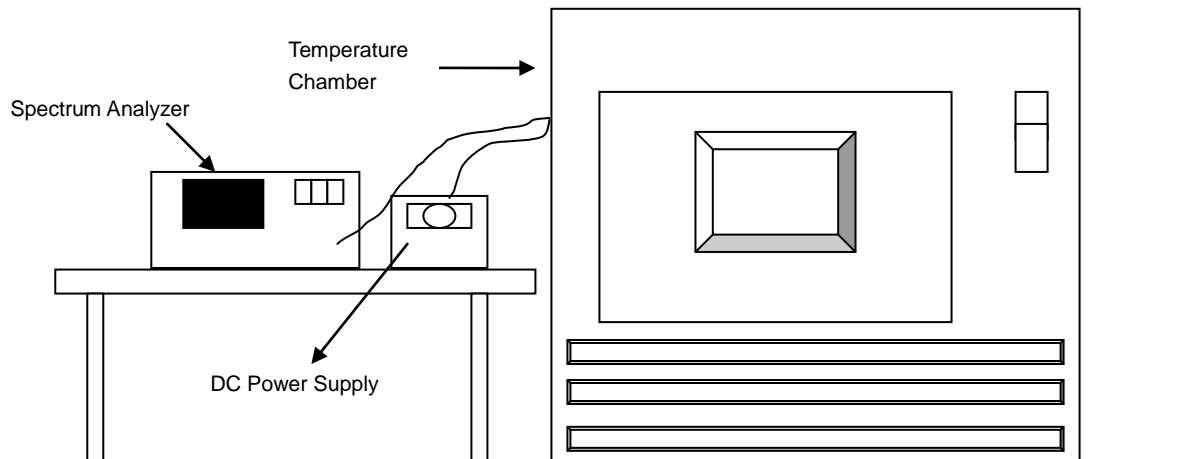

### 4.6.3 Test Instruments

Refer to section 4.1.2 to get information of above instrument.

### 4.6.4 Test Procedure

- The EUT was placed inside the environmental test chamber and powered by nominal DC voltage.
- Turn the EUT on and couple its output to a spectrum analyzer.
- Turn the EUT off and set the chamber to the highest temperature specified.
- Allow sufficient time (approximately 30 min) for the temperature of the chamber to stabilize, turn the EUT on and measure the operating frequency after 2, 5, and 10 Minutes.
- Repeat step 2 and 3 with the temperature chamber set to the lowest temperature.
- The test chamber was allowed to stabilize at +20 degree C for a minimum of 30 Minutes. The supply voltage was then adjusted on the EUT from 85% to 115% and the frequency record.

### 4.6.5 Deviation from Test Standard

No deviation.

### 4.6.6 EUT Operating Condition

Set the EUT transmit at un-modulation mode to test frequency stability.



## 4.6.7 Test Results

Frequency Stability Versus Temp.									
Operating Frequency: 5180 MHz									
TEMP. (°C)	Power Supply (Vdc)	0 Minute		2 Minutes		5 Minutes		10 Minutes	
		Measured Frequency (MHz)	Pass/Fail	Measured Frequency (MHz)	Pass/Fail	Measured Frequency (MHz)	Pass/Fail	Measured Frequency (MHz)	Pass/Fail
50	3.3	5179.9894	PASS	5179.9884	PASS	5179.989	PASS	5179.9877	PASS
40	3.3	5179.9976	PASS	5179.9972	PASS	5179.9996	PASS	5179.9988	PASS
30	3.3	5179.9934	PASS	5179.9945	PASS	5179.9938	PASS	5179.9897	PASS
20	3.3	5179.9991	PASS	5179.9982	PASS	5179.9951	PASS	5179.9981	PASS
10	3.3	5179.9884	PASS	5179.9896	PASS	5179.9865	PASS	5179.9875	PASS
0	3.3	5179.9872	PASS	5179.9909	PASS	5179.9881	PASS	5179.9865	PASS
-10	3.3	5179.9799	PASS	5179.9777	PASS	5179.9787	PASS	5179.9784	PASS
-20	3.3	5179.9834	PASS	5179.982	PASS	5179.984	PASS	5179.982	PASS
-30	3.3	5180.0139	PASS	5180.015	PASS	5180.0172	PASS	5180.0184	PASS

Frequency Stability Versus Voltage									
Operating Frequency: 5180 MHz									
TEMP. (°C)	Power Supply (Vdc)	0 Minute		2 Minutes		5 Minutes		10 Minutes	
		Measured Frequency (MHz)	Pass/Fail	Measured Frequency (MHz)	Pass/Fail	Measured Frequency (MHz)	Pass/Fail	Measured Frequency (MHz)	Pass/Fail
20	3.795	5179.9992	PASS	5179.9991	PASS	5179.9956	PASS	5179.9976	PASS
	3.3	5179.9991	PASS	5179.9982	PASS	5179.9951	PASS	5179.9981	PASS
	2.805	5179.9992	PASS	5179.9977	PASS	5179.9946	PASS	5179.9977	PASS

## 4.7 6dB Bandwidth Measurement

### 4.7.1 Limits of 6dB Bandwidth Measurement

The minimum of 6dB Bandwidth Measurement is 0.5MHz.

### 4.7.2 Test Setup

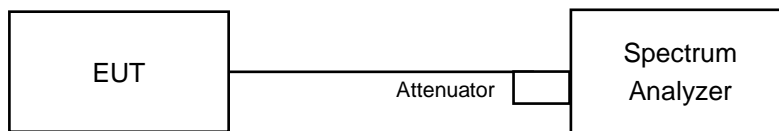

### 4.7.3 Test Instruments

Refer to section 4.1.2 to get information of above instrument.

### 4.7.4 Test Procedure

#### MEASUREMENT PROCEDURE REF

- a. Set resolution bandwidth (RBW) = 100kHz
- b. Set the video bandwidth (VBW)  $\geq 3 \times$  RBW, Detector = Peak.
- c. Trace mode = max hold.
- d. Sweep = auto couple.
- e. Measure the maximum width of the emission that is constrained by the frequencies associated with the two amplitude points (upper and lower) that are attenuated by 6 dB relative to the maximum level measured in the fundamental emission

### 4.7.5 Deviation from Test Standard

No deviation.

### 4.7.6 EUT Operating Condition

The software provided by client to enable the EUT under transmission condition continuously at lowest, middle and highest channel frequencies individually.

#### 4.7.7 Test Results

##### 802.11a

Channel	Frequency (MHz)	6dB Bandwidth (MHz)		Minimum Limit (MHz)	Pass / Fail
		Chain 0	Chain 1		
149	5745	15.20	15.19	0.5	PASS
157	5785	15.12	15.16	0.5	PASS
165	5825	15.17	15.18	0.5	PASS

##### 802.11ac (VHT20)

Channel	Frequency (MHz)	6dB Bandwidth (MHz)		Minimum Limit (MHz)	Pass / Fail
		Chain 0	Chain 1		
149	5745	15.20	15.17	0.5	PASS
157	5785	15.16	15.17	0.5	PASS
165	5825	15.19	15.16	0.5	PASS

##### 802.11ac (VHT40)

Channel	Frequency (MHz)	6dB Bandwidth (MHz)		Minimum Limit (MHz)	Pass / Fail
		Chain 0	Chain 1		
151	5755	35.28	35.23	0.5	PASS
159	5795	35.23	35.24	0.5	PASS

##### 802.11ac (VHT80)

Channel	Frequency (MHz)	6dB Bandwidth (MHz)		Minimum Limit (MHz)	Pass / Fail
		Chain 0	Chain 1		
155	5775	75.97	75.60	0.5	PASS

### Spectrum Plot of Worst Value

**802.11a / Chain 0 : CH157**

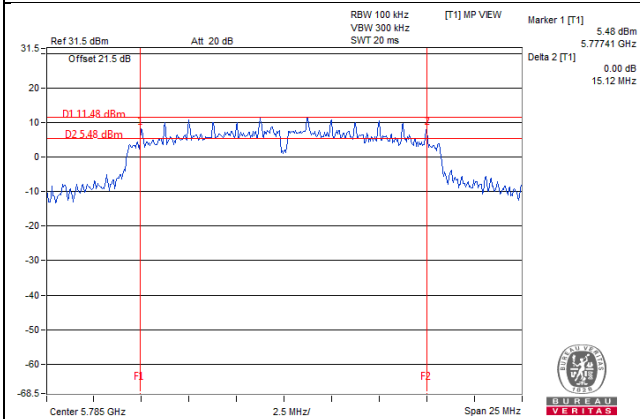

**802.11ac (VHT20) / Chain 0 : CH157**

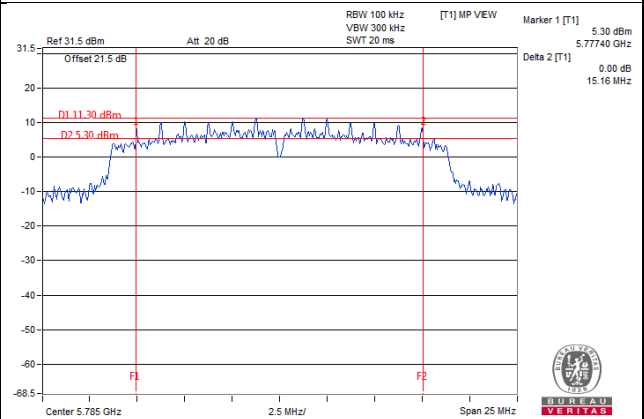

**802.11ac (VHT40) / Chain 0 : CH159**

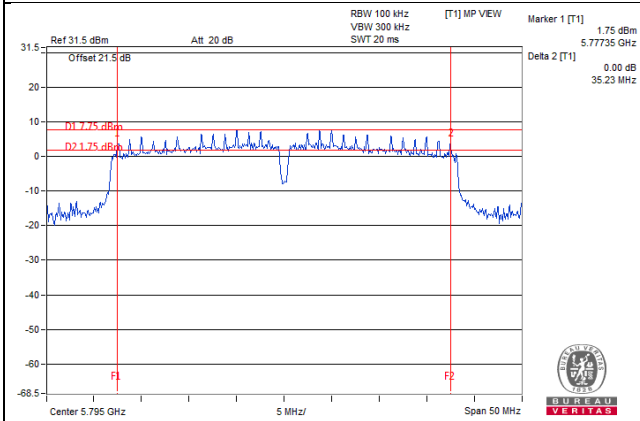

**802.11ac (VHT80) / Chain 1 : CH155**

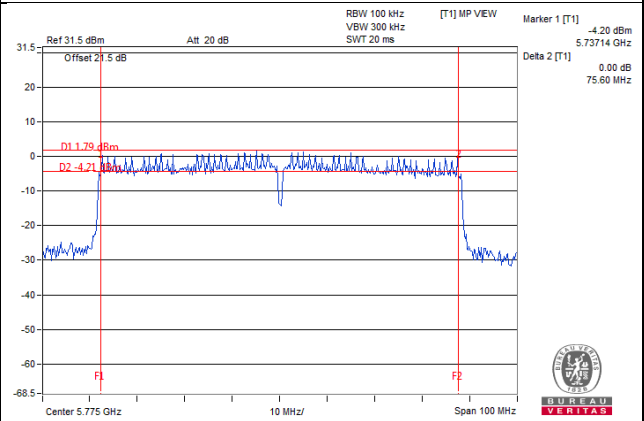

## 5 Pictures of Test Arrangements

Please refer to the attached file (Test Setup Photo).

## Annex A- Radiated Out of Band Emission (OOBE) Measurement (For U-NII-3 band)

802.11a

**CH 149 5745 MHz**

**Horizontal**

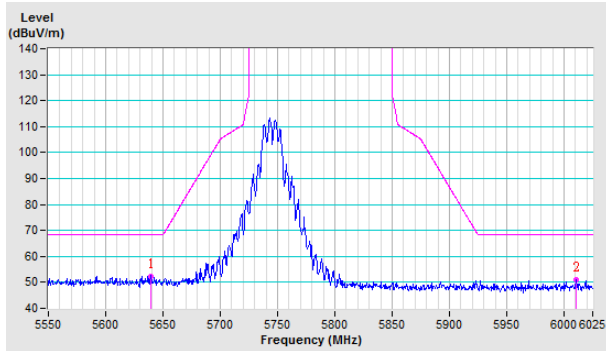

**Vertical**

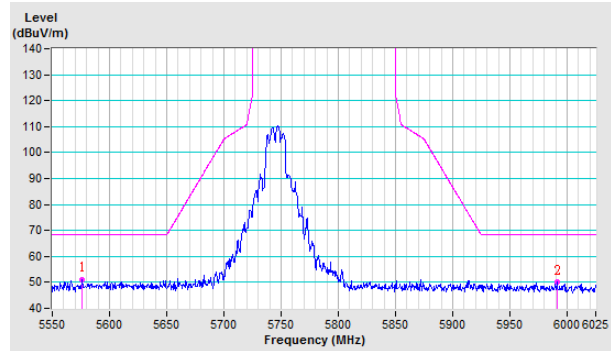

**CH 157 5785 MHz**

**Horizontal**

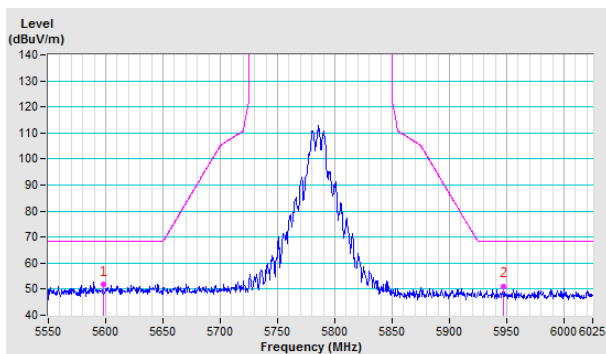

**Vertical**

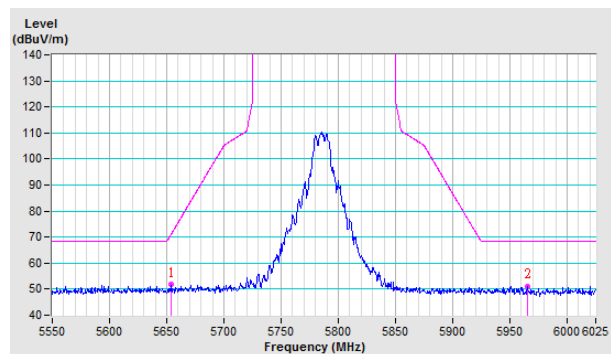

**CH 165 5825 MHz**

**Horizontal**

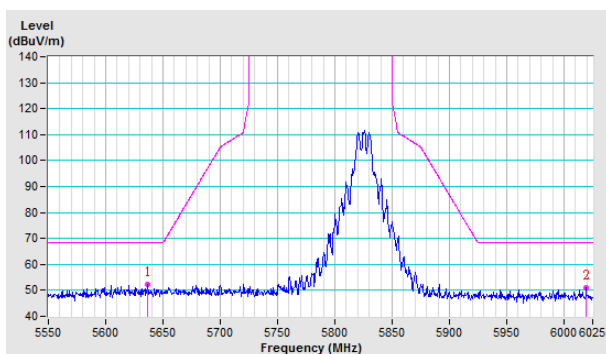

**Vertical**

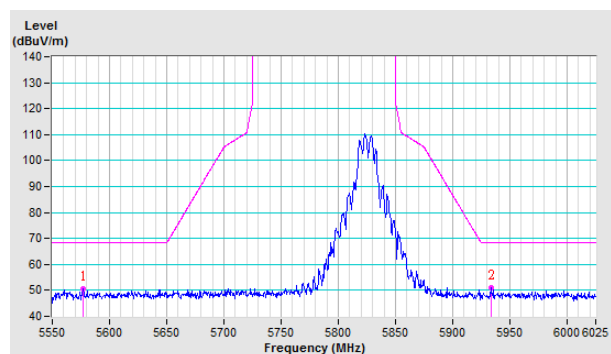

802.11ac (VHT20)

CH 149 5745 MHz

Horizontal

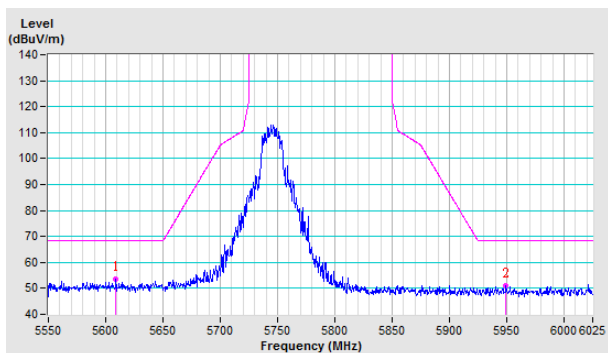

Vertical

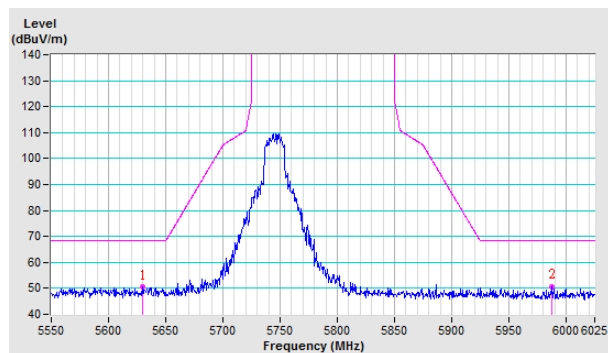

CH 157 5785 MHz

Horizontal

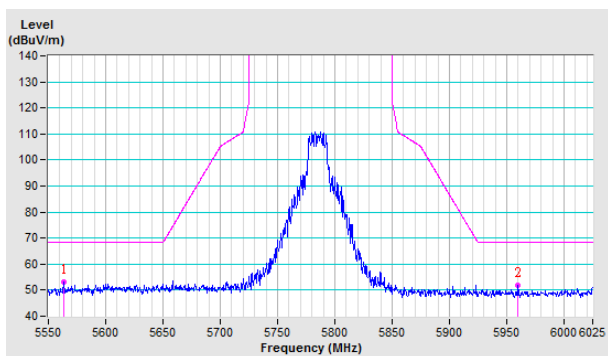

Vertical

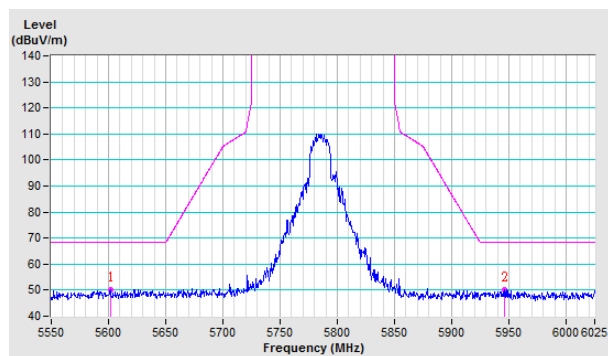

CH 165 5825 MHz

Horizontal

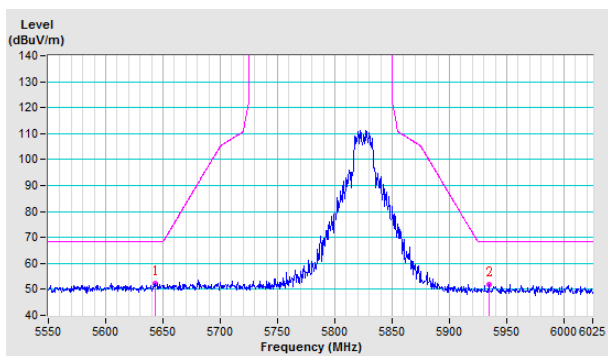

Vertical

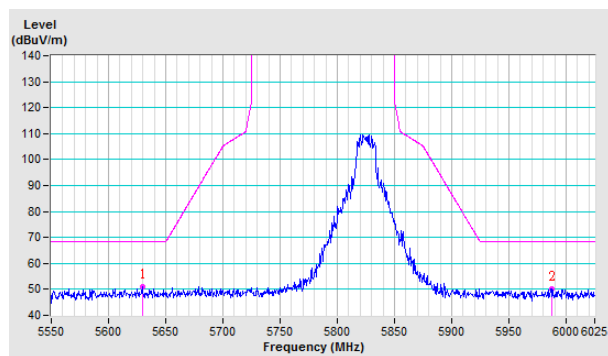

802.11ac (VHT40)

CH 151 5755 MHz

Horizontal

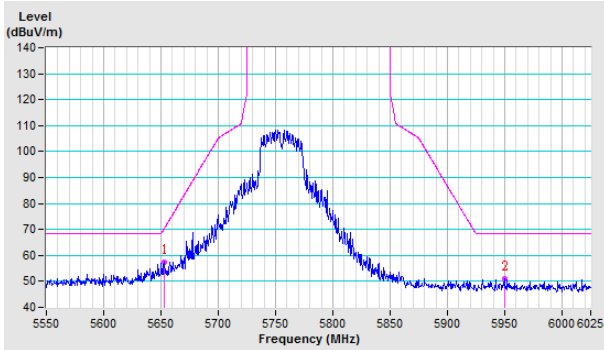

Vertical

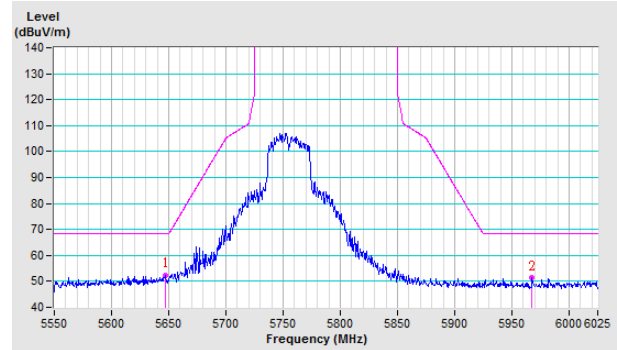

CH 159 5795 MHz

Horizontal

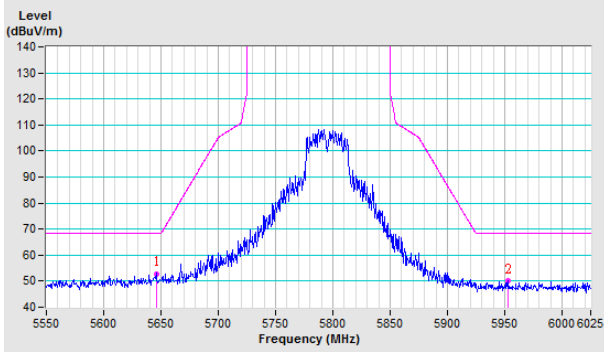

Vertical

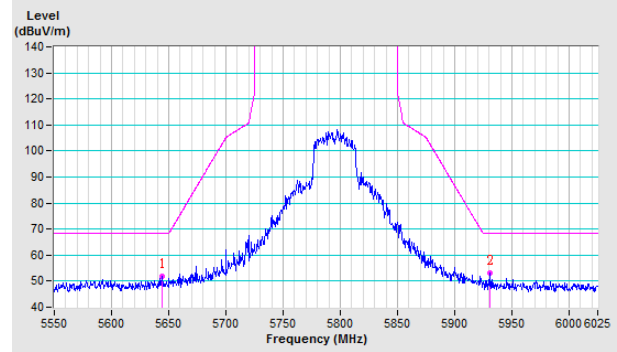



802.11ac (VHT80)

CH 155 5775 MHz

Horizontal

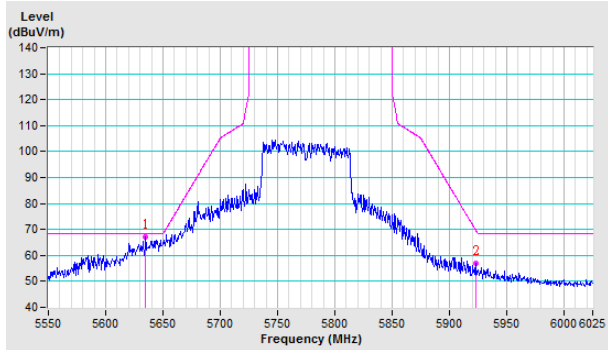

Vertical

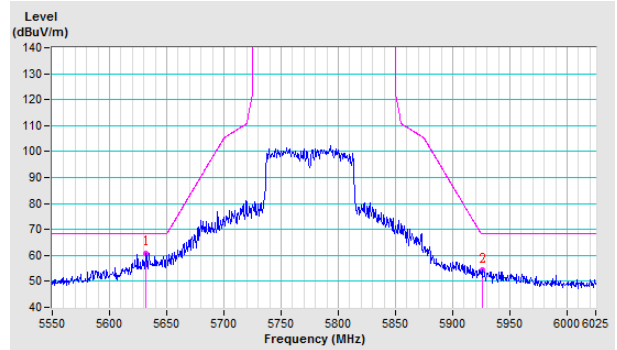

## Appendix – Information on the Testing Laboratories

We, Bureau Veritas Consumer Products Services (H.K.) Ltd., Taoyuan Branch, were founded in 1988 to provide our best service in EMC, Radio, Telecom and Safety consultation. Our laboratories are FCC recognized accredited test firms and accredited according to ISO/IEC 17025.

If you have any comments, please feel free to contact us at the following:

**Linko EMC/RF Lab**

Tel: 886-2-26052180

Fax: 886-2-26051924

**Hsin Chu EMC/RF/Telecom Lab**

Tel: 886-3-6668565

Fax: 886-3-6668323

**Hwa Ya EMC/RF/Safety Lab**

Tel: 886-3-3183232

Fax: 886-3-3270892

**Email:** [service.adt@tw.bureauveritas.com](mailto:service.adt@tw.bureauveritas.com)

**Web Site:** [www.bureauveritas-adt.com](http://www.bureauveritas-adt.com)

The address and road map of all our labs can be found in our web site also.

--- END ---