

## FCC Test Report (WLAN)

**Report No.:** RF180416E05

**FCC ID:** AK8J20H098

**Test Model:** J20H098

**Received Date:** Apr. 16, 2018

**Test Date:** Apr. 24 to 27, 2018

**Issued Date:** May 28, 2018

**Applicant:** Sony Corporation

**Address:** 1-7-1 Konan Minato-ku Tokyo, 108-0075 Japan

**Issued By:** Bureau Veritas Consumer Products Services (H.K.) Ltd., Taoyuan  
Branch Hsin Chu Laboratory

**Lab Address:** E-2, No.1, Li Hsin 1st Road, Hsinchu Science Park, Hsinchu City 300,  
Taiwan R.O.C.

**Test Location :** E-2, No.1, Li Hsin 1st Road, Hsinchu Science Park, Hsinchu City 300,  
Taiwan R.O.C.

**FCC Registration /  
Designation Number:** 723255 / TW2022



This report is for your exclusive use. Any copying or replication of this report to or for any other person or entity, or use of our name or trademark, is permitted only with our prior written permission. This report sets forth our findings solely with respect to the test samples identified herein. The results set forth in this report are not indicative or representative of the quality or characteristics of the lot from which a test sample was taken or any similar or identical product unless specifically and expressly noted. Our report includes all of the tests requested by you and the results thereof based upon the information that you provided to us. You have 60 days from date of issuance of this report to notify us of any material error or omission caused by our negligence, provided, however, that such notice shall be in writing and shall specifically address the issue you wish to raise. A failure to raise such issue within the prescribed time shall constitute your unqualified acceptance of the completeness of this report, the tests conducted and the correctness of the report contents. Unless specific mention, the uncertainty of measurement has been explicitly taken into account to declare the compliance or non-compliance to the specification. The report must not be used by the client to claim product certification, approval, or endorsement by TAF or any government agencies.

## Table of Contents

<b>Release Control Record</b> .....	<b>4</b>
<b>1 Certificate of Conformity</b> .....	<b>5</b>
<b>2 Summary of Test Results</b> .....	<b>6</b>
2.1 Measurement Uncertainty .....	6
2.2 Modification Record .....	6
<b>3 General Information</b> .....	<b>7</b>
3.1 General Description of EUT (WLAN) .....	7
3.2 Description of Test Modes .....	9
3.2.1 Test Mode Applicability and Tested Channel Detail .....	10
3.3 Duty Cycle of Test Signal .....	12
3.4 Description of Support Units .....	13
3.4.1 Configuration of System under Test .....	13
3.5 General Description of Applied Standards .....	14
<b>4 Test Types and Results</b> .....	<b>15</b>
4.1 Radiated Emission and Bandedge Measurement .....	15
4.1.1 Limits of Radiated Emission and Bandedge Measurement .....	15
4.1.2 Test Instruments .....	16
4.1.3 Test Procedures .....	17
4.1.4 Deviation from Test Standard .....	17
4.1.5 Test Setup .....	18
4.1.6 EUT Operating Conditions .....	19
4.1.7 Test Results .....	20
4.2 Conducted Emission Measurement .....	33
4.2.1 Limits of Conducted Emission Measurement .....	33
4.2.2 Test Instruments .....	33
4.2.3 Test Procedures .....	34
4.2.4 Deviation from Test Standard .....	34
4.2.5 Test Setup .....	34
4.2.6 EUT Operating Conditions .....	34
4.2.7 Test Results .....	35
4.3 6dB Bandwidth Measurement .....	37
4.3.1 Limits of 6dB Bandwidth Measurement .....	37
4.3.2 Test Setup .....	37
4.3.3 Test Instruments .....	37
4.3.4 Test Procedure .....	37
4.3.5 Deviation from Test Standard .....	37
4.3.6 EUT Operating Conditions .....	37
4.3.7 Test Result .....	38
4.4 Conducted Output Power Measurement .....	40
4.4.1 Limits of Conducted Output Power Measurement .....	40
4.4.2 Test Setup .....	40
4.4.3 Test Instruments .....	40
4.4.4 Test Procedures .....	40
4.4.5 Deviation from Test Standard .....	40
4.4.6 EUT Operating Conditions .....	40
4.4.7 Test Results .....	41
4.5 Power Spectral Density Measurement .....	43
4.5.1 Limits of Power Spectral Density Measurement .....	43
4.5.2 Test Setup .....	43
4.5.3 Test Instruments .....	43
4.5.4 Test Procedure .....	43
4.5.5 Deviation from Test Standard .....	43
4.5.6 EUT Operating Condition .....	43

4.5.7 Test Results .....	44
4.6 Conducted Out of Band Emission Measurement .....	47
4.6.1 Limits of Conducted Out of Band Emission Measurement.....	47
4.6.2 Test Setup.....	47
4.6.3 Test Instruments .....	47
4.6.4 Test Procedure .....	47
4.6.5 Deviation from Test Standard .....	47
4.6.6 EUT Operating Condition .....	47
4.6.7 Test Results .....	47
<b>5 Pictures of Test Arrangements.....</b>	<b>58</b>
<b>Appendix – Information on the Testing Laboratories .....</b>	<b>59</b>

### Release Control Record

Issue No.	Description	Date Issued
RF180416E05	Original release.	May 28, 2018

## 1 Certificate of Conformity

**Product:** WLAN/BT Module

**Brand:** FOXCONN

**Test Model:** J20H098

**Sample Status:** ENGINEERING SAMPLE

**Applicant:** Sony Corporation

**Test Date:** Apr. 24 to 27, 2018

**Standards:** 47 CFR FCC Part 15, Subpart C (Section 15.247)  
ANSI C63.10: 2013

The above equipment has been tested by **Bureau Veritas Consumer Products Services (H.K.) Ltd., Taoyuan Branch**, and found compliance with the requirement of the above standards. The test record, data evaluation & Equipment Under Test (EUT) configurations represented herein are true and accurate accounts of the measurements of the sample's EMC characteristics under the conditions specified in this report.

**Prepared by :** Mary Ko , **Date:** May 28, 2018  
Mary Ko / Specialist

**Approved by :** May Chen , **Date:** May 28, 2018  
May Chen / Manager

## 2 Summary of Test Results

47 CFR FCC Part 15, Subpart C (Section 15.247)			
FCC Clause	Test Item	Result	Remarks
15.207	AC Power Conducted Emission	PASS	Meet the requirement of limit. Minimum passing margin is -14.72dB at 0.15000MHz.
15.205 / 15.209 / 15.247(d)	Radiated Emissions and Band Edge Measurement	PASS	Meet the requirement of limit. Minimum passing margin is -0.1dB at 2390.00MHz, 2483.50MHz, 7386.00MHz.
15.247(d)	Antenna Port Emission	PASS	Meet the requirement of limit.
15.247(a)(2)	6dB bandwidth	PASS	Meet the requirement of limit.
15.247(b)	Conducted power	PASS	Meet the requirement of limit.
15.247(e)	Power Spectral Density	PASS	Meet the requirement of limit.
15.203	Antenna Requirement	PASS	No antenna connector is used.

### 2.1 Measurement Uncertainty

Where relevant, the following measurement uncertainty levels have been estimated for tests performed on the EUT as specified in CISPR 16-4-2:

Measurement	Frequency	Expanded Uncertainty (k=2) ( $\pm$ )
Conducted Emissions at mains ports	150kHz ~ 30MHz	1.84 dB
Radiated Emissions up to 1 GHz	30MHz ~ 1GHz	5.33 dB
Radiated Emissions above 1 GHz	1GHz ~ 6GHz	5.10 dB
	6GHz ~ 18GHz	4.85 dB
	18GHz ~ 40GHz	5.24 dB

### 2.2 Modification Record

There were no modifications required for compliance.

### 3 General Information

#### 3.1 General Description of EUT (WLAN)

Product	WLAN/BT Module
Brand	FOXCONN
Test Model	J20H098
Status of EUT	ENGINEERING SAMPLE
Power Supply Rating	3.3Vdc from host equipment
Modulation Type	CCK, DQPSK, DBPSK for DSSS 64QAM, 16QAM, QPSK, BPSK for OFDM 256QAM for OFDM in 11ac mode only
Modulation Technology	DSSS, OFDM
Transfer Rate	802.11b: up to 11Mbps 802.11a/g: up to 54Mbps 802.11n: up to 300Mbps 802.11ac: up to 866.7Mbps
Operating Frequency	<b>2.4GHz:</b> 2.412 ~ 2.462GHz <b>5GHz:</b> 5.18 ~ 5.24GHz, 5.26 ~ 5.32GHz, 5.50 ~ 5.70GHz, 5.745 ~ 5.825GHz
Number of Channel	<b>2.4GHz:</b> 802.11b, 802.11g, 802.11n (HT20): 11 <b>5GHz:</b> 802.11a, 802.11n (HT20), 802.11ac (VHT20): 24 802.11n (HT40), 802.11ac (VHT40): 11 802.11ac (VHT80): 5
Output Power	<b>2.4GHz:</b> 702.041mW <b>5GHz:</b> <b>5.18 ~ 5.24GHz:</b> 248.775mW <b>5.26 ~ 5.32GHz:</b> 237.912mW <b>5.50 ~ 5.70GHz:</b> 198.167mW <b>5.745 ~ 5.825GHz:</b> 328.118mW
Antenna Type	Refer to Note
Antenna Connector	Refer to Note
Accessory Device	NA
Data Cable Supplied	NA

Note:

1. There are WLAN and Bluetooth technology used for the EUT.
2. Simultaneously transmission condition.

Condition	Technology	
1	WLAN (2.4GHz)	Bluetooth
2	WLAN (5GHz)	Bluetooth

**Note:** The emission of the simultaneous operation has been evaluated and no non-compliance was found.

3. The EUT has two types, which are identical to each other in all aspects except for the followings:

Model	Type	Different
J20H098	Type 1	with Switch Connector
	Type 2	without Switch Connector

According to above types, **Type 1** was selected as representative model for the test and its data was recorded in this report.

4. The antennas provided to the EUT, please refer to the following table:

For WLAN				
Ant No.	Antenna Gain (dBi)	Frequency rang (MHz)	Antenna type	Connector type
1	-0.26	2412~2472	Metal PIFA	none
	1.89	5180~5240		
	2.3	5260~5320		
	3.14	5500~5700		
	1.53	5745~5825		
2	0.52	2412~2472	Metal PIFA	none
	3.73	5180~5240		
	3.01	5260~5320		
	2.12	5500~5700		
	1.15	5745~5825		
For Bluetooth				
Ant No.	Antenna Gain (dBi)	Frequency rang (GHz)	Antenna type	Connector type
1	0.85	2.4~2.4835	Metal PIFA	none

5. The EUT incorporates a MIMO function.

2.4GHz Band			
MODULATION MODE	DATA RATE (MCS)	TX & RX CONFIGURATION	
802.11b	1 ~ 11Mbps	2TX	2RX
802.11g	6 ~ 54Mbps	2TX	2RX
802.11n (HT20)	MCS 0~7	2TX	2RX
	MCS 8~15	2TX	2RX
5GHz Band			
MODULATION MODE	DATA RATE (MCS)	TX & RX CONFIGURATION	
802.11a	6 ~ 54Mbps	2TX	2RX
802.11n (HT20)	MCS 0~7	2TX	2RX
	MCS 8~15	2TX	2RX
802.11n (HT40)	MCS 0~7	2TX	2RX
	MCS 8~15	2TX	2RX
802.11ac (VHT20)	MCS0~8 Nss=1	2TX	2RX
	MCS0~8 Nss=2	2TX	2RX
802.11ac (VHT40)	MCS0~9 Nss=1	2TX	2RX
	MCS0~9 Nss=2	2TX	2RX
802.11ac (VHT80)	MCS0~9 Nss=1	2TX	2RX
	MCS0~9 Nss=2	2TX	2RX

6. The above EUT information is declared by manufacturer and for more detailed features description, please refer to the manufacturer's specifications or user's manual.



### 3.2 Description of Test Modes

11 channels are provided for 802.11b, 802.11g and 802.11n (HT20):

Channel	Frequency	Channel	Frequency
1	2412MHz	7	2442MHz
2	2417MHz	8	2447MHz
3	2422MHz	9	2452MHz
4	2427MHz	10	2457MHz
5	2432MHz	11	2462MHz
6	2437MHz		

### 3.2.1 Test Mode Applicability and Tested Channel Detail

EUT CONFIGURE MODE	APPLICABLE TO				DESCRIPTION
	RE $\geq$ 1G	RE<1G	PLC	APCM	
-	√	√	√	√	-

Where **RE $\geq$ 1G**: Radiated Emission above 1GHz & Bandedge Measurement  
**RE<1G**: Radiated Emission below 1GHz  
**PLC**: Power Line Conducted Emission  
**APCM**: Antenna Port Conducted Measurement

**NOTE:** 1. The EUT had been pre-tested on the positioned of each 3 axis. The worst case was found when positioned on **X-plane**.

#### **Radiated Emission Test (Above 1GHz):**

- Pre-Scan has been conducted to determine the worst-case mode from all possible combinations between available modulations, data rates and antenna ports (if EUT with antenna diversity architecture).
- Following channel(s) was (were) selected for the final test as listed below.

MODE	AVAILABLE CHANNEL	TESTED CHANNEL	MODULATION TECHNOLOGY	MODULATION TYPE	DATA RATE (Mbps)
802.11b	1 to 11	1, 6, 11	DSSS	DBPSK	1
802.11g	1 to 11	1, 6, 9, 10, 11	OFDM	BPSK	6
802.11n (HT20)	1 to 11	1, 6, 10, 11	OFDM	BPSK	6.5

#### **Radiated Emission Test (Below 1GHz):**

- Pre-Scan has been conducted to determine the worst-case mode from all possible combinations between available modulations, data rates and antenna ports (if EUT with antenna diversity architecture).
- Following channel(s) was (were) selected for the final test as listed below.

MODE	AVAILABLE CHANNEL	TESTED CHANNEL	MODULATION TECHNOLOGY	MODULATION TYPE	DATA RATE (Mbps)
802.11g	1 to 11	6	OFDM	BPSK	6

#### **Power Line Conducted Emission Test:**

- Pre-Scan has been conducted to determine the worst-case mode from all possible combinations between available modulations, data rates and antenna ports (if EUT with antenna diversity architecture).
- Following channel(s) was (were) selected for the final test as listed below.

MODE	AVAILABLE CHANNEL	TESTED CHANNEL	MODULATION TECHNOLOGY	MODULATION TYPE	DATA RATE (Mbps)
802.11g	1 to 11	6	OFDM	BPSK	6

### Antenna Port Conducted Measurement:

- This item includes all test value of each mode, but only includes spectrum plot of worst value of each mode.
- Pre-Scan has been conducted to determine the worst-case mode from all possible combinations between available modulations, data rates and antenna ports (if EUT with antenna diversity architecture).
- Following channel(s) was (were) selected for the final test as listed below.

MODE	AVAILABLE CHANNEL	TESTED CHANNEL	MODULATION TECHNOLOGY	MODULATION TYPE	DATA RATE (Mbps)
802.11b	1 to 11	1, 6, 11	DSSS	DBPSK	1
802.11g	1 to 11	1, 6, 9, 10, 11	OFDM	BPSK	6
802.11n (HT20)	1 to 11	1, 6, 10, 11	OFDM	BPSK	6.5

### Test Condition:

APPLICABLE TO	ENVIRONMENTAL CONDITIONS	INPUT POWER	TESTED BY
RE $\geq$ 1G	21deg. C, 61%RH	120Vac, 60Hz (system)	Eason Tseng
RE<1G	20deg. C, 64%RH	120Vac, 60Hz (system)	Eason Tseng
PLC	25deg. C, 75%RH	120Vac, 60Hz (system)	Andy Ho
APCM	22deg. C, 61%RH	3.3Vdc	Anderson Chen

### 3.3 Duty Cycle of Test Signal

If duty cycle of test signal is  $\geq 98\%$ , duty factor is not required.

If duty cycle of test signal is  $< 98\%$ , duty factor shall be considered.

**802.11b**: Duty cycle =  $8.419/8.481 = 0.993$

**802.11g**: Duty cycle =  $1.392/1.428 = 0.975$ , Duty factor =  $10 * \log(1/0.975) = 0.11$

**802.11n (HT20)**: Duty cycle =  $1.299/1.335 = 0.973$ , Duty factor =  $10 * \log(1/0.973) = 0.12$

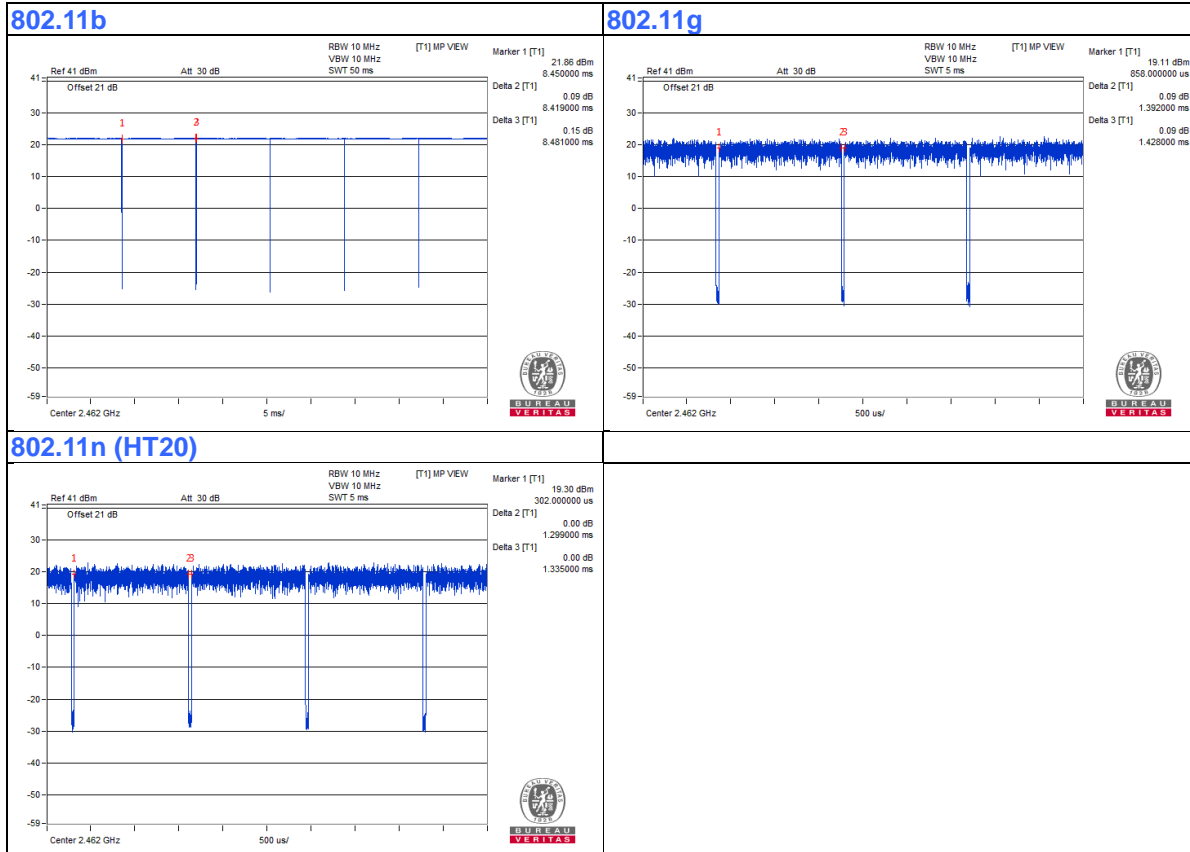

### 3.4 Description of Support Units

The EUT has been tested as an independent unit together with other necessary accessories or support units. The following support units or accessories were used to form a representative test configuration during the tests.

ID	Product	Brand	Model No.	Serial No.	FCC ID	Remarks
A.	Laptop	DELL	E6420	B92T3R1	FCC DoC	Provided by Lab
B.	Test Tool	NA	NA	NA	NA	Supplied by client

ID	Descriptions	Qty.	Length (m)	Shielding (Yes/No)	Cores (Qty.)	Remarks
1.	Cable	1	0.1	No	0	Supplied by client
2.	USB Cable	1	1.4	Yes	0	Provided by Lab

#### 3.4.1 Configuration of System under Test

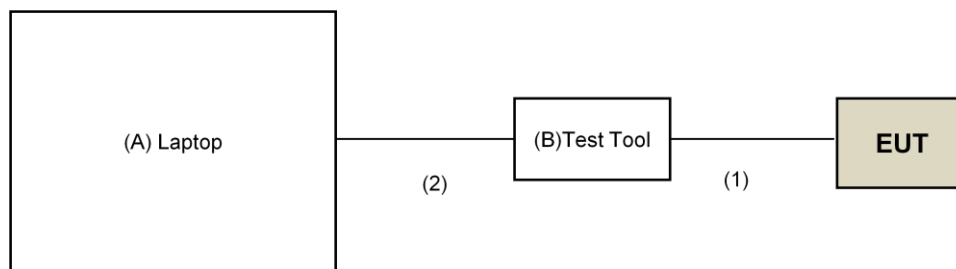

### 3.5 General Description of Applied Standards

The EUT is a RF Product. According to the specifications of the manufacturer, it must comply with the requirements of the following standards:

**FCC Part 15, Subpart C (15.247)**  
**KDB 558074 D01 DTS Meas Guidance v04**  
**KDB 662911 D01 Multiple Transmitter Output v02r01**  
**ANSI C63.10-2013**

All test items have been performed and recorded as per the above standards.

## 4 Test Types and Results

### 4.1 Radiated Emission and Bandedge Measurement

#### 4.1.1 Limits of Radiated Emission and Bandedge Measurement

Radiated emissions which fall in the restricted bands must comply with the radiated emission limits specified as below table. Other emissions shall be at least 20dB below the highest level of the desired power:

Frequencies (MHz)	Field Strength (microvolts/meter)	Measurement Distance (meters)
0.009 ~ 0.490	2400/F(kHz)	300
0.490 ~ 1.705	24000/F(kHz)	30
1.705 ~ 30.0	30	30
30 ~ 88	100	3
88 ~ 216	150	3
216 ~ 960	200	3
Above 960	500	3

**NOTE:**

1. The lower limit shall apply at the transition frequencies.
2. Emission level (dBuV/m) = 20 log Emission level (uV/m).
3. For frequencies above 1000MHz, the field strength limits are based on average detector, however, the peak field strength of any emission shall not exceed the maximum permitted average limits, specified above by more than 20dB under any condition of modulation.

## 4.1.2 Test Instruments

DESCRIPTION & MANUFACTURER	MODEL NO.	SERIAL NO.	CALIBRATED DATE	CALIBRATED UNTIL
Test Receiver Keysight	N9038A	MY54450088	July 08, 2017	July 07, 2018
Pre-Amplifier EMC1	EMC001340	980142	Feb. 09, 2018	Feb. 08, 2019
Loop Antenna <sup>(*)</sup> Electro-Metrics	EM-6879	264	Dec. 16, 2016	Dec. 15, 2018
RF Cable	NA	LOOPCAB-001 LOOPCAB-002	Jan. 15, 2018	Jan. 14, 2019
Pre-Amplifier Mini-Circuits	ZFL-1000VH2B	AMP-ZFL-01	Nov. 09, 2017	Nov. 08, 2018
Trilog Broadband Antenna SCHWARZBECK	VULB 9168	9168-406	Nov. 29, 2017	Nov. 28, 2018
RF Cable	8D	966-4-1 966-4-2 966-4-3	Mar. 21, 2018	Mar. 20, 2019
Fixed attenuator Mini-Circuits	UNAT-5+	PAD-3m-4-01	Oct. 03, 2017	Oct. 02, 2018
Horn_Antenna SCHWARZBECK	BBHA 9120D	9120D-783	Dec. 12, 2017	Dec. 11, 2018
Pre-Amplifier EMC1	EMC12630SE	980385	Jan. 29, 2018	Jan. 28, 2019
RF Cable	EMC104-SM-SM-1200 EMC104-SM-SM-2000 EMC104-SM-SM-5000	160923 150318 150321	Jan. 29, 2018	Jan. 28, 2019
Pre-Amplifier EMC1	EMC184045SE	980387	Jan. 29, 2018	Jan. 28, 2019
Horn_Antenna SCHWARZBECK	BBHA 9170	BBHA9170608	Dec. 14, 2017	Dec. 13, 2018
RF Cable	EMC102-KM-KM-1200	160925	Jan. 29, 2018	Jan. 28, 2019
Software	ADT_Radiated_V8.7.08	NA	NA	NA
Antenna Tower & Turn Table Max-Full	MF-7802	MF780208410	NA	NA
Boresight Antenna Fixture	FBA-01	FBA-SIP02	NA	NA
Spectrum Analyzer R&S	FSV40	100964	July 1, 2017	June 30, 2018
Power meter Anritsu	ML2495A	1014008	May 11, 2017	May 10, 2018
Power sensor Anritsu	MA2411B	0917122	May 11, 2017	May 10, 2018

**Note:**

1. The calibration interval of the above test instruments is 12 months and the calibrations are traceable to NML/ROC and NIST/USA.
2. \*The calibration interval of the above test instruments is 24 months and the calibrations are traceable to NML/ROC and NIST/USA.
3. The test was performed in 966 Chamber No. 4.
4. The CANADA Site Registration No. is 20331-2
5. Loop antenna was used for all emissions below 30 MHz.
6. Tested Date: Apr. 24 to 27, 2018



#### 4.1.3 Test Procedures

##### **For Radiated emission below 30MHz**

- a. The EUT was placed on the top of a rotating table 0.8 meters above the ground at a 3 meter chamber room. The table was rotated 360 degrees to determine the position of the highest radiation.
- b. The EUT was set 3 meters away from the interference-receiving antenna, which was mounted on the top of a variable-height antenna tower.
- c. Parallel, perpendicular, and ground-parallel orientations of the antenna are set to make the measurement.
- d. For each suspected emission, the EUT was arranged to its worst case and the rotatable table was turned from 0 degrees to 360 degrees to find the maximum reading.
- e. The test-receiver system was set to Quasi-Peak Detect Function and Specified Bandwidth with Maximum Hold Mode.

##### **NOTE:**

1. The resolution bandwidth and video bandwidth of test receiver/spectrum analyzer is 9kHz at frequency below 30MHz.

##### **For Radiated emission above 30MHz**

- a. The EUT was placed on the top of a rotating table 0.8 meters (for 30MHz ~ 1GHz) / 1.5 meters (for above 1GHz) above the ground at 3 meter chamber room for test. The table was rotated 360 degrees to determine the position of the highest radiation.
- b. The EUT was set 3 meters away from the interference-receiving antenna, which was mounted on the top of a variable-height antenna tower.
- c. The height of antenna is varied from one meter to four meters above the ground to determine the maximum value of the field strength. Both horizontal and vertical polarizations of the antenna are set to make the measurement.
- d. For each suspected emission, the EUT was arranged to its worst case and then the antenna was tuned to heights from 1 meter to 4 meters and the rotatable table was turned from 0 degrees to 360 degrees to find the maximum reading.
- e. The test-receiver system was set to quasi-peak detect function and specified bandwidth with maximum hold mode when the test frequency is below 1 GHz.
- f. The test-receiver system was set to peak and average detect function and specified bandwidth with maximum hold mode when the test frequency is above 1 GHz. If the peak reading value also meets average limit, measurement with the average detector is unnecessary.

##### **Note:**

1. The resolution bandwidth and video bandwidth of test receiver/spectrum analyzer is 120kHz for Quasi-peak detection (QP) at frequency below 1GHz.
2. The resolution bandwidth of test receiver/spectrum analyzer is 1 MHz and the video bandwidth is 3 MHz for Peak detection (PK) at frequency above 1GHz.
3. The resolution bandwidth of test receiver/spectrum analyzer is 1MHz and the video bandwidth is  $\geq 1/T$  (Duty cycle < 98%) or 10Hz (Duty cycle  $\geq 98\%$ ) for Average detection (AV) at frequency above 1GHz.
4. All modes of operation were investigated and the worst-case emissions are reported.

#### 4.1.4 Deviation from Test Standard

No deviation.

4.1.5 Test Setup

For Radiated emission below 30MHz

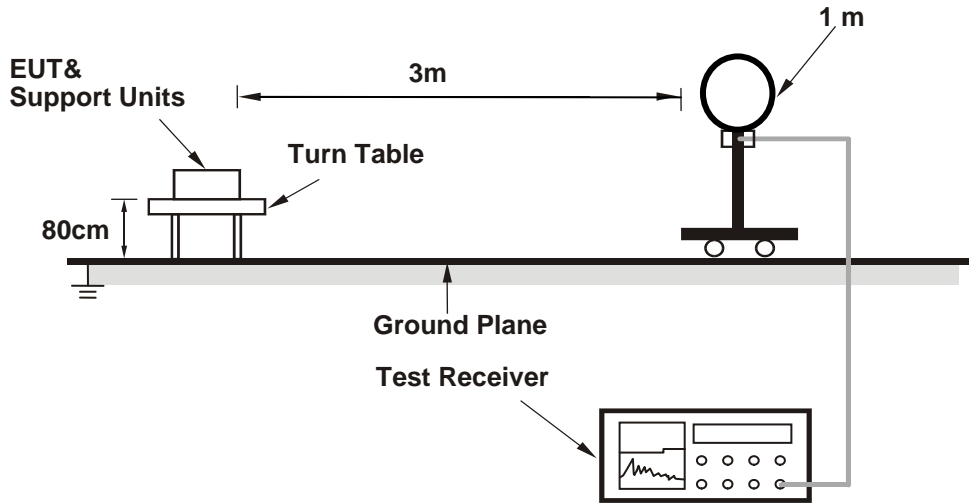

For Radiated emission 30MHz to 1GHz

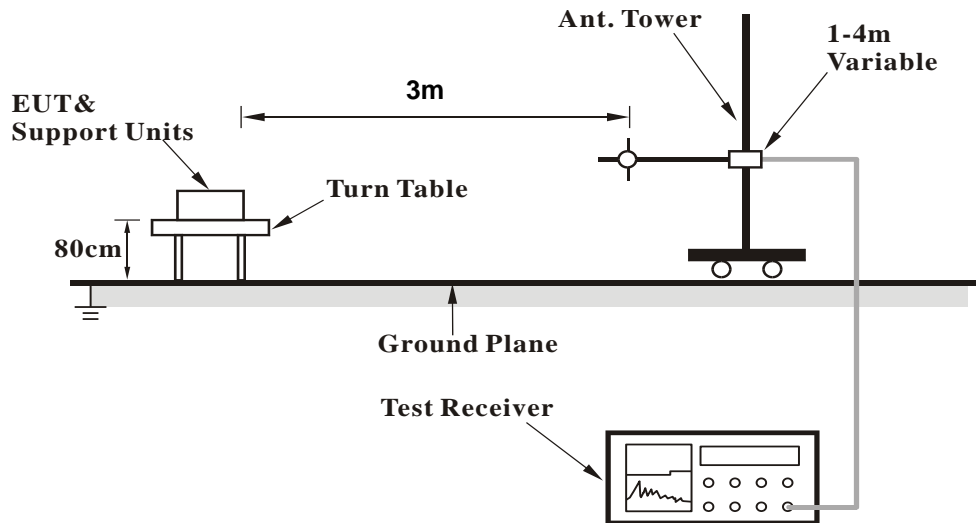

### For Radiated emission above 1GHz

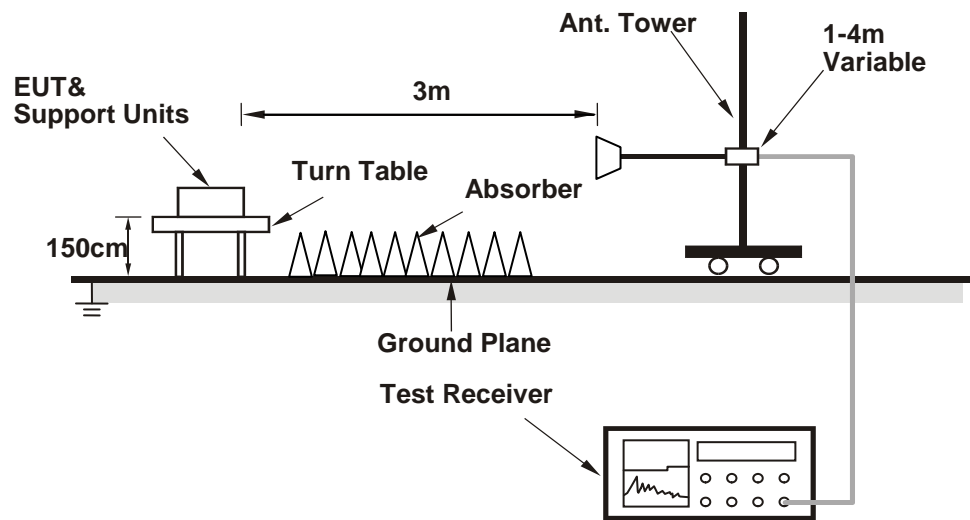

For the actual test configuration, please refer to the attached file (Test Setup Photo).

#### 4.1.6 EUT Operating Conditions

- a. Placed the EUT on the testing table.
- b. Controlling software (MT7668 QA 0.0.1.90) has been activated to set the EUT on specific status.

#### 4.1.7 Test Results

#### Above 1GHz Data:

#### 802.11b

<b>CHANNEL</b>	TX Channel 1	<b>DETECTOR FUNCTION</b>	Peak (PK)
<b>FREQUENCY RANGE</b>	1GHz ~ 25GHz		Average (AV)

ANTENNA POLARITY & TEST DISTANCE: HORIZONTAL AT 3 M								
NO.	FREQ. (MHz)	EMISSION LEVEL (dBuV/m)	LIMIT (dBuV/m)	MARGIN (dB)	ANTENNA HEIGHT (m)	TABLE ANGLE (Degree)	RAW VALUE (dBuV)	CORRECTION FACTOR (dB/m)
1	2390.00	56.5 PK	74.0	-17.5	1.29 H	310	58.5	-2.0
2	2390.00	45.9 AV	54.0	-8.1	1.29 H	310	47.9	-2.0
3	*2412.00	110.1 PK			1.29 H	310	112.2	-2.1
4	*2412.00	107.7 AV			1.29 H	310	109.8	-2.1
5	4824.00	54.4 PK	74.0	-19.6	1.21 H	79	51.7	2.7
6	4824.00	53.8 AV	54.0	-0.2	1.21 H	79	51.1	2.7
ANTENNA POLARITY & TEST DISTANCE: VERTICAL AT 3 M								
NO.	FREQ. (MHz)	EMISSION LEVEL (dBuV/m)	LIMIT (dBuV/m)	MARGIN (dB)	ANTENNA HEIGHT (m)	TABLE ANGLE (Degree)	RAW VALUE (dBuV)	CORRECTION FACTOR (dB/m)
1	2390.00	51.5 PK	74.0	-22.5	1.07 V	57	53.5	-2.0
2	2390.00	38.4 AV	54.0	-15.6	1.07 V	57	40.4	-2.0
3	*2412.00	103.9 PK			1.07 V	57	106.0	-2.1
4	*2412.00	102.1 AV			1.07 V	57	104.2	-2.1
5	4824.00	51.4 PK	74.0	-22.6	1.17 V	65	48.7	2.7
6	4824.00	50.3 AV	54.0	-3.7	1.17 V	65	47.6	2.7

#### REMARKS:

1. Emission Level(dBuV/m) = Raw Value(dBuV) + Correction Factor(dB/m)
2. Correction Factor(dB/m) = Antenna Factor(dB/m) + Cable Factor(dB) – Pre-Amplifier Factor(dB)
3. The other emission levels were very low against the limit.
4. Margin value = Emission Level – Limit value
5. " \* ": Fundamental frequency.

<b>CHANNEL</b>	TX Channel 6	<b>DETECTOR FUNCTION</b>	Peak (PK)
<b>FREQUENCY RANGE</b>	1GHz ~ 25GHz		Average (AV)

**ANTENNA POLARITY & TEST DISTANCE: HORIZONTAL AT 3 M**

NO.	FREQ. (MHz)	EMISSION LEVEL (dBuV/m)	LIMIT (dBuV/m)	MARGIN (dB)	ANTENNA HEIGHT (m)	TABLE ANGLE (Degree)	RAW VALUE (dBuV)	CORRECTION FACTOR (dB/m)
1	2390.00	53.5 PK	74.0	-20.5	1.27 H	281	55.5	-2.0
2	2390.00	42.3 AV	54.0	-11.7	1.27 H	281	44.3	-2.0
3	*2437.00	110.3 PK			1.27 H	281	112.6	-2.3
4	*2437.00	107.8 AV			1.27 H	281	110.1	-2.3
5	2483.50	54.2 PK	74.0	-19.8	1.27 H	281	56.4	-2.2
6	2483.50	43.4 AV	54.0	-10.6	1.27 H	281	45.6	-2.2
7	4874.00	52.5 PK	74.0	-21.5	1.23 H	73	49.6	2.9
8	4874.00	51.7 AV	54.0	-2.3	1.23 H	73	48.8	2.9
9	7311.00	56.3 PK	74.0	-17.7	1.12 H	199	47.0	9.3
10	7311.00	53.5 AV	54.0	-0.5	1.12 H	199	44.2	9.3

**ANTENNA POLARITY & TEST DISTANCE: VERTICAL AT 3 M**

NO.	FREQ. (MHz)	EMISSION LEVEL (dBuV/m)	LIMIT (dBuV/m)	MARGIN (dB)	ANTENNA HEIGHT (m)	TABLE ANGLE (Degree)	RAW VALUE (dBuV)	CORRECTION FACTOR (dB/m)
1	2390.00	48.6 PK	74.0	-25.4	1.10 V	43	50.6	-2.0
2	2390.00	33.4 AV	54.0	-20.6	1.10 V	43	35.4	-2.0
3	*2437.00	104.1 PK			1.10 V	43	106.4	-2.3
4	*2437.00	102.0 AV			1.10 V	43	104.3	-2.3
5	2483.50	49.1 PK	74.0	-24.9	1.10 V	43	51.3	-2.2
6	2483.50	34.4 AV	54.0	-19.6	1.10 V	43	36.6	-2.2
7	4874.00	49.0 PK	74.0	-25.0	1.17 V	67	46.1	2.9
8	4874.00	47.5 AV	54.0	-6.5	1.17 V	67	44.6	2.9
9	7311.00	53.2 PK	74.0	-20.8	1.19 V	208	43.9	9.3
10	7311.00	49.2 AV	54.0	-4.8	1.19 V	208	39.9	9.3

**REMARKS:**

1. Emission Level(dBuV/m) = Raw Value(dBuV) + Correction Factor(dB/m)
2. Correction Factor(dB/m) = Antenna Factor(dB/m) + Cable Factor(dB) – Pre-Amplifier Factor(dB)
3. The other emission levels were very low against the limit.
4. Margin value = Emission Level – Limit value
5. " \* ": Fundamental frequency.

<b>CHANNEL</b>	TX Channel 11	<b>DETECTOR FUNCTION</b>	Peak (PK)
<b>FREQUENCY RANGE</b>	1GHz ~ 25GHz		Average (AV)

**ANTENNA POLARITY & TEST DISTANCE: HORIZONTAL AT 3 M**

NO.	FREQ. (MHz)	EMISSION LEVEL (dBuV/m)	LIMIT (dBuV/m)	MARGIN (dB)	ANTENNA HEIGHT (m)	TABLE ANGLE (Degree)	RAW VALUE (dBuV)	CORRECTION FACTOR (dB/m)
1	*2462.00	110.4 PK			1.27 H	310	112.7	-2.3
2	*2462.00	107.9 AV			1.27 H	310	110.2	-2.3
3	2483.50	59.5 PK	74.0	-14.5	1.27 H	310	61.7	-2.2
4	2483.50	53.6 AV	54.0	-0.4	1.27 H	310	55.8	-2.2
5	4924.00	52.1 PK	74.0	-21.9	1.31 H	70	49.1	3.0
6	4924.00	50.9 AV	54.0	-3.1	1.31 H	70	47.9	3.0
7	7386.00	56.5 PK	74.0	-17.5	1.00 H	114	46.8	9.7
8	<b>7386.00</b>	<b>53.9 AV</b>	<b>54.0</b>	<b>-0.1</b>	<b>1.00 H</b>	<b>114</b>	<b>44.2</b>	<b>9.7</b>

**ANTENNA POLARITY & TEST DISTANCE: VERTICAL AT 3 M**

NO.	FREQ. (MHz)	EMISSION LEVEL (dBuV/m)	LIMIT (dBuV/m)	MARGIN (dB)	ANTENNA HEIGHT (m)	TABLE ANGLE (Degree)	RAW VALUE (dBuV)	CORRECTION FACTOR (dB/m)
1	*2462.00	104.1 PK			1.07 V	32	106.4	-2.3
2	*2462.00	102.1 AV			1.07 V	32	104.4	-2.3
3	2483.50	54.4 PK	74.0	-19.6	1.07 V	32	56.6	-2.2
4	2483.50	44.6 AV	54.0	-9.4	1.07 V	32	46.8	-2.2
5	4924.00	49.1 PK	74.0	-24.9	1.20 V	77	46.1	3.0
6	4924.00	47.4 AV	54.0	-6.6	1.20 V	77	44.4	3.0
7	7386.00	53.3 PK	74.0	-20.7	1.14 V	201	43.6	9.7
8	7386.00	49.1 AV	54.0	-4.9	1.14 V	201	39.4	9.7

**REMARKS:**

1. Emission Level(dBuV/m) = Raw Value(dBuV) + Correction Factor(dB/m)
2. Correction Factor(dB/m) = Antenna Factor(dB/m) + Cable Factor(dB) – Pre-Amplifier Factor(dB)
3. The other emission levels were very low against the limit.
4. Margin value = Emission Level – Limit value
5. " \* ": Fundamental frequency.

**802.11g**

<b>CHANNEL</b>	TX Channel 1	<b>DETECTOR FUNCTION</b>	Peak (PK)
<b>FREQUENCY RANGE</b>	1GHz ~ 25GHz		Average (AV)

**ANTENNA POLARITY & TEST DISTANCE: HORIZONTAL AT 3 M**

NO.	FREQ. (MHz)	EMISSION LEVEL (dBuV/m)	LIMIT (dBuV/m)	MARGIN (dB)	ANTENNA HEIGHT (m)	TABLE ANGLE (Degree)	RAW VALUE (dBuV)	CORRECTION FACTOR (dB/m)
1	2390.00	66.9 PK	74.0	-7.1	1.27 H	295	68.9	-2.0
2	2390.00	53.7 AV	54.0	-0.3	1.27 H	295	55.7	-2.0
3	*2412.00	111.4 PK			1.27 H	295	113.5	-2.1
4	*2412.00	101.2 AV			1.27 H	295	103.3	-2.1
5	4824.00	50.9 PK	74.0	-23.1	1.09 H	122	48.2	2.7
6	4824.00	39.8 AV	54.0	-14.2	1.09 H	122	37.1	2.7

**ANTENNA POLARITY & TEST DISTANCE: VERTICAL AT 3 M**

NO.	FREQ. (MHz)	EMISSION LEVEL (dBuV/m)	LIMIT (dBuV/m)	MARGIN (dB)	ANTENNA HEIGHT (m)	TABLE ANGLE (Degree)	RAW VALUE (dBuV)	CORRECTION FACTOR (dB/m)
1	2390.00	62.6 PK	74.0	-11.4	1.01 V	38	64.6	-2.0
2	2390.00	49.6 AV	54.0	-4.4	1.01 V	38	51.6	-2.0
3	*2412.00	105.8 PK			1.01 V	38	107.9	-2.1
4	*2412.00	95.9 AV			1.01 V	38	98.0	-2.1
5	4824.00	47.4 PK	74.0	-26.6	1.23 V	74	44.7	2.7
6	4824.00	35.6 AV	54.0	-18.4	1.23 V	74	32.9	2.7

**REMARKS:**

1. Emission Level(dBuV/m) = Raw Value(dBuV) + Correction Factor(dB/m)
2. Correction Factor(dB/m) = Antenna Factor(dB/m) + Cable Factor(dB) – Pre-Amplifier Factor(dB)
3. The other emission levels were very low against the limit.
4. Margin value = Emission Level – Limit value
5. " \* ": Fundamental frequency.

<b>CHANNEL</b>	TX Channel 6	<b>DETECTOR FUNCTION</b>	Peak (PK)
<b>FREQUENCY RANGE</b>	1GHz ~ 25GHz		Average (AV)

**ANTENNA POLARITY & TEST DISTANCE: HORIZONTAL AT 3 M**

NO.	FREQ. (MHz)	EMISSION LEVEL (dBuV/m)	LIMIT (dBuV/m)	MARGIN (dB)	ANTENNA HEIGHT (m)	TABLE ANGLE (Degree)	RAW VALUE (dBuV)	CORRECTION FACTOR (dB/m)
1	2387.00	60.3 PK	74.0	-13.7	1.33 H	295	62.3	-2.0
2	2387.00	46.5 AV	54.0	-7.5	1.33 H	295	48.5	-2.0
3	2390.00	59.8 PK	74.0	-14.2	1.33 H	295	61.8	-2.0
4	2390.00	45.4 AV	54.0	-8.6	1.33 H	295	47.4	-2.0
5	*2437.00	115.5 PK			1.33 H	295	117.8	-2.3
6	*2437.00	105.5 AV			1.33 H	295	107.8	-2.3
7	2483.50	64.9 PK	74.0	-9.1	1.33 H	295	67.1	-2.2
8	2483.50	49.6 AV	54.0	-4.4	1.33 H	295	51.8	-2.2
9	2486.80	65.1 PK	74.0	-8.9	1.33 H	295	67.3	-2.2
10	2486.80	50.5 AV	54.0	-3.5	1.33 H	295	52.7	-2.2
11	4874.00	54.9 PK	74.0	-19.1	1.05 H	106	52.0	2.9
12	4874.00	42.9 AV	54.0	-11.1	1.05 H	106	40.0	2.9
13	7311.00	62.6 PK	74.0	-11.4	1.17 H	202	53.3	9.3
14	7311.00	50.2 AV	54.0	-3.8	1.17 H	202	40.9	9.3

**ANTENNA POLARITY & TEST DISTANCE: VERTICAL AT 3 M**

NO.	FREQ. (MHz)	EMISSION LEVEL (dBuV/m)	LIMIT (dBuV/m)	MARGIN (dB)	ANTENNA HEIGHT (m)	TABLE ANGLE (Degree)	RAW VALUE (dBuV)	CORRECTION FACTOR (dB/m)
1	2387.00	56.4 PK	74.0	-17.6	1.19 V	45	58.4	-2.0
2	2387.00	42.1 AV	54.0	-11.9	1.19 V	45	44.1	-2.0
3	2390.00	55.4 PK	74.0	-18.6	1.19 V	45	57.4	-2.0
4	2390.00	41.9 AV	54.0	-12.1	1.19 V	45	43.9	-2.0
5	*2437.00	109.9 PK			1.19 V	45	112.2	-2.3
6	*2437.00	100.2 AV			1.19 V	45	102.5	-2.3
7	2483.50	60.8 PK	74.0	-13.2	1.19 V	45	63.0	-2.2
8	2483.50	45.6 AV	54.0	-8.4	1.19 V	45	47.8	-2.2
9	2486.80	61.7 PK	74.0	-12.3	1.19 V	45	63.9	-2.2
10	2486.80	46.9 AV	54.0	-7.1	1.19 V	45	49.1	-2.2
11	4874.00	50.6 PK	74.0	-23.4	1.27 V	71	47.7	2.9
12	4874.00	38.4 AV	54.0	-15.6	1.27 V	71	35.5	2.9
13	7311.00	58.2 PK	74.0	-15.8	1.13 V	217	48.9	9.3
14	7311.00	45.7 AV	54.0	-8.3	1.13 V	217	36.4	9.3

**REMARKS:**

1. Emission Level(dBuV/m) = Raw Value(dBuV) + Correction Factor(dB/m)
2. Correction Factor(dB/m) = Antenna Factor(dB/m) + Cable Factor(dB) – Pre-Amplifier Factor(dB)
3. The other emission levels were very low against the limit.
4. Margin value = Emission Level – Limit value
5. " \* ": Fundamental frequency.



<b>CHANNEL</b>	TX Channel 9	<b>DETECTOR FUNCTION</b>	Peak (PK)
<b>FREQUENCY RANGE</b>	1GHz ~ 25GHz		Average (AV)

**ANTENNA POLARITY & TEST DISTANCE: HORIZONTAL AT 3 M**

NO.	FREQ. (MHz)	EMISSION LEVEL (dBuV/m)	LIMIT (dBuV/m)	MARGIN (dB)	ANTENNA HEIGHT (m)	TABLE ANGLE (Degree)	RAW VALUE (dBuV)	CORRECTION FACTOR (dB/m)
1	*2452.00	111.6 PK			1.09 H	305	113.9	-2.3
2	*2452.00	101.7 AV			1.09 H	305	104.0	-2.3
3	2483.50	68.8 PK	74.0	-5.2	1.09 H	305	71.0	-2.2
4	2483.50	53.7 AV	54.0	-0.3	1.09 H	305	55.9	-2.2
5	4904.00	50.4 PK	74.0	-23.6	1.03 H	119	47.5	2.9
6	4904.00	39.6 AV	54.0	-14.4	1.03 H	119	36.7	2.9
7	7356.00	58.5 PK	74.0	-15.5	1.12 H	192	48.8	9.7
8	7356.00	46.1 AV	54.0	-7.9	1.12 H	192	36.4	9.7

**ANTENNA POLARITY & TEST DISTANCE: VERTICAL AT 3 M**

NO.	FREQ. (MHz)	EMISSION LEVEL (dBuV/m)	LIMIT (dBuV/m)	MARGIN (dB)	ANTENNA HEIGHT (m)	TABLE ANGLE (Degree)	RAW VALUE (dBuV)	CORRECTION FACTOR (dB/m)
1	*2452.00	106.0 PK			1.19 V	39	108.3	-2.3
2	*2452.00	96.4 AV			1.19 V	39	98.7	-2.3
3	2483.50	64.8 PK	74.0	-9.2	1.19 V	39	67.0	-2.2
4	2483.50	49.6 AV	54.0	-4.4	1.19 V	39	51.8	-2.2
5	4904.00	47.2 PK	74.0	-26.8	1.24 V	84	44.3	2.9
6	4904.00	35.6 AV	54.0	-18.4	1.24 V	84	32.7	2.9
7	7356.00	54.1 PK	74.0	-19.9	1.08 V	205	44.4	9.7
8	7356.00	41.8 AV	54.0	-12.2	1.08 V	205	32.1	9.7

**REMARKS:**

1. Emission Level(dBuV/m) = Raw Value(dBuV) + Correction Factor(dB/m)
2. Correction Factor(dB/m) = Antenna Factor(dB/m) + Cable Factor(dB) – Pre-Amplifier Factor(dB)
3. The other emission levels were very low against the limit.
4. Margin value = Emission Level – Limit value
5. " \* ": Fundamental frequency.

<b>CHANNEL</b>	TX Channel 10	<b>DETECTOR FUNCTION</b>	Peak (PK)
<b>FREQUENCY RANGE</b>	1GHz ~ 25GHz		Average (AV)

**ANTENNA POLARITY & TEST DISTANCE: HORIZONTAL AT 3 M**

NO.	FREQ. (MHz)	EMISSION LEVEL (dBuV/m)	LIMIT (dBuV/m)	MARGIN (dB)	ANTENNA HEIGHT (m)	TABLE ANGLE (Degree)	RAW VALUE (dBuV)	CORRECTION FACTOR (dB/m)
1	*2457.00	111.2 PK			1.10 H	292	113.5	-2.3
2	*2457.00	101.1 AV			1.10 H	292	103.4	-2.3
3	2483.50	68.3 PK	74.0	-5.7	1.10 H	292	70.5	-2.2
<b>4</b>	<b>2483.50</b>	<b>53.9 AV</b>	<b>54.0</b>	<b>-0.1</b>	<b>1.10 H</b>	<b>292</b>	<b>56.1</b>	<b>-2.2</b>
5	4914.00	50.2 PK	74.0	-23.8	1.05 H	104	47.3	2.9
6	4914.00	39.2 AV	54.0	-14.8	1.05 H	104	36.3	2.9
7	7371.00	58.8 PK	74.0	-15.2	1.14 H	184	49.1	9.7
8	7371.00	46.2 AV	54.0	-7.8	1.14 H	184	36.5	9.7

**ANTENNA POLARITY & TEST DISTANCE: VERTICAL AT 3 M**

NO.	FREQ. (MHz)	EMISSION LEVEL (dBuV/m)	LIMIT (dBuV/m)	MARGIN (dB)	ANTENNA HEIGHT (m)	TABLE ANGLE (Degree)	RAW VALUE (dBuV)	CORRECTION FACTOR (dB/m)
1	*2457.00	105.6 PK			1.14 V	51	107.9	-2.3
2	*2457.00	95.8 AV			1.14 V	51	98.1	-2.3
3	2483.50	64.2 PK	74.0	-9.8	1.14 V	51	66.4	-2.2
4	2483.50	49.6 AV	54.0	-4.4	1.14 V	51	51.8	-2.2
5	4914.00	47.1 PK	74.0	-26.9	1.19 V	93	44.2	2.9
6	4914.00	35.6 AV	54.0	-18.4	1.19 V	93	32.7	2.9
7	7371.00	54.0 PK	74.0	-20.0	1.08 V	198	44.3	9.7
8	7371.00	41.5 AV	54.0	-12.5	1.08 V	198	31.8	9.7

**REMARKS:**

1. Emission Level(dBuV/m) = Raw Value(dBuV) + Correction Factor(dB/m)
2. Correction Factor(dB/m) = Antenna Factor(dB/m) + Cable Factor(dB) – Pre-Amplifier Factor(dB)
3. The other emission levels were very low against the limit.
4. Margin value = Emission Level – Limit value
5. " \* ": Fundamental frequency.

<b>CHANNEL</b>	TX Channel 11	<b>DETECTOR FUNCTION</b>	Peak (PK)
<b>FREQUENCY RANGE</b>	1GHz ~ 25GHz		Average (AV)

**ANTENNA POLARITY & TEST DISTANCE: HORIZONTAL AT 3 M**

NO.	FREQ. (MHz)	EMISSION LEVEL (dBuV/m)	LIMIT (dBuV/m)	MARGIN (dB)	ANTENNA HEIGHT (m)	TABLE ANGLE (Degree)	RAW VALUE (dBuV)	CORRECTION FACTOR (dB/m)
1	*2462.00	110.5 PK			1.08 H	296	112.8	-2.3
2	*2462.00	100.1 AV			1.08 H	296	102.4	-2.3
3	2483.50	68.3 PK	74.0	-5.7	1.08 H	296	70.5	-2.2
4	2483.50	52.6 AV	54.0	-1.4	1.08 H	296	54.8	-2.2
5	2486.80	69.9 PK	74.0	-4.1	1.08 H	296	72.1	-2.2
6	2486.80	53.8 AV	54.0	-0.2	1.08 H	296	56.0	-2.2
7	4924.00	50.5 PK	74.0	-23.5	1.04 H	113	47.5	3.0
8	4924.00	39.3 AV	54.0	-14.7	1.04 H	113	36.3	3.0
9	7386.00	59.0 PK	74.0	-15.0	1.10 H	175	49.3	9.7
10	7386.00	46.2 AV	54.0	-7.8	1.10 H	175	36.5	9.7

**ANTENNA POLARITY & TEST DISTANCE: VERTICAL AT 3 M**

NO.	FREQ. (MHz)	EMISSION LEVEL (dBuV/m)	LIMIT (dBuV/m)	MARGIN (dB)	ANTENNA HEIGHT (m)	TABLE ANGLE (Degree)	RAW VALUE (dBuV)	CORRECTION FACTOR (dB/m)
1	*2462.00	104.9 PK			1.12 V	53	107.2	-2.3
2	*2462.00	94.8 AV			1.12 V	53	97.1	-2.3
3	2483.50	64.6 PK	74.0	-9.4	1.12 V	53	66.8	-2.2
4	2483.50	48.4 AV	54.0	-5.6	1.12 V	53	50.6	-2.2
5	2486.80	65.8 PK	74.0	-8.2	1.12 V	53	68.0	-2.2
6	2486.80	49.5 AV	54.0	-4.5	1.12 V	53	51.7	-2.2
7	4924.00	47.4 PK	74.0	-26.6	1.16 V	105	44.4	3.0
8	4924.00	35.7 AV	54.0	-18.3	1.16 V	105	32.7	3.0
9	7386.00	53.5 PK	74.0	-20.5	1.02 V	195	43.8	9.7
10	7386.00	41.2 AV	54.0	-12.8	1.02 V	195	31.5	9.7

**REMARKS:**

1. Emission Level(dBuV/m) = Raw Value(dBuV) + Correction Factor(dB/m)
2. Correction Factor(dB/m) = Antenna Factor(dB/m) + Cable Factor(dB) – Pre-Amplifier Factor(dB)
3. The other emission levels were very low against the limit.
4. Margin value = Emission Level – Limit value
5. " \* ": Fundamental frequency.

### 802.11n (HT20)

<b>CHANNEL</b>	TX Channel 1	<b>DETECTOR FUNCTION</b>	Peak (PK)
<b>FREQUENCY RANGE</b>	1GHz ~ 25GHz		Average (AV)

#### ANTENNA POLARITY & TEST DISTANCE: HORIZONTAL AT 3 M

NO.	FREQ. (MHz)	EMISSION LEVEL (dBuV/m)	LIMIT (dBuV/m)	MARGIN (dB)	ANTENNA HEIGHT (m)	TABLE ANGLE (Degree)	RAW VALUE (dBuV)	CORRECTION FACTOR (dB/m)
1	2390.00	70.5 PK	74.0	-3.5	1.34 H	121	72.5	-2.0
2	<b>2390.00</b>	<b>53.9 AV</b>	<b>54.0</b>	<b>-0.1</b>	<b>1.34 H</b>	<b>121</b>	<b>55.9</b>	<b>-2.0</b>
3	*2412.00	111.1 PK			1.34 H	121	113.2	-2.1
4	*2412.00	100.2 AV			1.34 H	121	102.3	-2.1
5	4824.00	50.5 PK	74.0	-23.5	1.02 H	100	47.8	2.7
6	4824.00	39.5 AV	54.0	-14.5	1.02 H	100	36.8	2.7

#### ANTENNA POLARITY & TEST DISTANCE: VERTICAL AT 3 M

NO.	FREQ. (MHz)	EMISSION LEVEL (dBuV/m)	LIMIT (dBuV/m)	MARGIN (dB)	ANTENNA HEIGHT (m)	TABLE ANGLE (Degree)	RAW VALUE (dBuV)	CORRECTION FACTOR (dB/m)
1	2390.00	66.4 PK	74.0	-7.6	1.17 V	59	68.4	-2.0
2	2390.00	49.6 AV	54.0	-4.4	1.17 V	59	51.6	-2.0
3	*2412.00	105.1 PK			1.17 V	59	107.2	-2.1
4	*2412.00	94.9 AV			1.17 V	59	97.0	-2.1
5	4824.00	46.8 PK	74.0	-27.2	1.20 V	119	44.1	2.7
6	4824.00	35.3 AV	54.0	-18.7	1.20 V	119	32.6	2.7

#### REMARKS:

1. Emission Level(dBuV/m) = Raw Value(dBuV) + Correction Factor(dB/m)
2. Correction Factor(dB/m) = Antenna Factor(dB/m) + Cable Factor(dB) – Pre-Amplifier Factor(dB)
3. The other emission levels were very low against the limit.
4. Margin value = Emission Level – Limit value
5. " \* ": Fundamental frequency.

<b>CHANNEL</b>	TX Channel 6	<b>DETECTOR FUNCTION</b>	Peak (PK)
<b>FREQUENCY RANGE</b>	1GHz ~ 25GHz		Average (AV)

**ANTENNA POLARITY & TEST DISTANCE: HORIZONTAL AT 3 M**

NO.	FREQ. (MHz)	EMISSION LEVEL (dBuV/m)	LIMIT (dBuV/m)	MARGIN (dB)	ANTENNA HEIGHT (m)	TABLE ANGLE (Degree)	RAW VALUE (dBuV)	CORRECTION FACTOR (dB/m)
1	2390.00	61.6 PK	74.0	-12.4	1.31 H	244	63.6	-2.0
2	2390.00	47.2 AV	54.0	-6.8	1.31 H	244	49.2	-2.0
3	*2437.00	113.8 PK			1.32 H	244	116.1	-2.3
4	*2437.00	104.3 AV			1.32 H	244	106.6	-2.3
5	2483.50	66.6 PK	74.0	-7.4	1.31 H	244	68.8	-2.2
6	2483.50	50.8 AV	54.0	-3.2	1.31 H	244	53.0	-2.2
7	4874.00	54.8 PK	74.0	-19.2	1.00 H	110	51.9	2.9
8	4874.00	43.0 AV	54.0	-11.0	1.00 H	110	40.1	2.9
9	7311.00	62.8 PK	74.0	-11.2	1.13 H	194	53.5	9.3
10	7311.00	50.6 AV	54.0	-3.4	1.13 H	194	41.3	9.3

**ANTENNA POLARITY & TEST DISTANCE: VERTICAL AT 3 M**

NO.	FREQ. (MHz)	EMISSION LEVEL (dBuV/m)	LIMIT (dBuV/m)	MARGIN (dB)	ANTENNA HEIGHT (m)	TABLE ANGLE (Degree)	RAW VALUE (dBuV)	CORRECTION FACTOR (dB/m)
1	2390.00	57.4 PK	74.0	-16.6	1.11 V	43	59.4	-2.0
2	2390.00	43.1 AV	54.0	-10.9	1.11 V	43	45.1	-2.0
3	*2437.00	108.2 PK			1.11 V	43	110.5	-2.3
4	*2437.00	99.0 AV			1.11 V	43	101.3	-2.3
5	2483.50	62.5 PK	74.0	-11.5	1.11 V	43	64.7	-2.2
6	2483.50	46.5 AV	54.0	-7.5	1.11 V	43	48.7	-2.2
7	4874.00	50.7 PK	74.0	-23.3	1.25 V	59	47.8	2.9
8	4874.00	38.7 AV	54.0	-15.3	1.25 V	59	35.8	2.9
9	7311.00	57.9 PK	74.0	-16.1	1.13 V	206	48.6	9.3
10	7311.00	45.4 AV	54.0	-8.6	1.13 V	206	36.1	9.3

**REMARKS:**

1. Emission Level(dBuV/m) = Raw Value(dBuV) + Correction Factor(dB/m)
2. Correction Factor(dB/m) = Antenna Factor(dB/m) + Cable Factor(dB) – Pre-Amplifier Factor(dB)
3. The other emission levels were very low against the limit.
4. Margin value = Emission Level – Limit value
5. " \* ": Fundamental frequency.

<b>CHANNEL</b>	TX Channel 10	<b>DETECTOR FUNCTION</b>	Peak (PK)
<b>FREQUENCY RANGE</b>	1GHz ~ 25GHz		Average (AV)

**ANTENNA POLARITY & TEST DISTANCE: HORIZONTAL AT 3 M**

NO.	FREQ. (MHz)	EMISSION LEVEL (dBuV/m)	LIMIT (dBuV/m)	MARGIN (dB)	ANTENNA HEIGHT (m)	TABLE ANGLE (Degree)	RAW VALUE (dBuV)	CORRECTION FACTOR (dB/m)
1	*2457.00	111.9 PK			1.01 H	245	114.2	-2.3
2	*2457.00	101.7 AV			1.01 H	245	104.0	-2.3
3	2483.50	71.0 PK	74.0	-3.0	1.01 H	245	73.2	-2.2
4	2483.50	53.7 AV	54.0	-0.3	1.01 H	245	55.9	-2.2
5	4914.00	49.9 PK	74.0	-24.1	1.06 H	98	47.0	2.9
6	4914.00	38.8 AV	54.0	-15.2	1.06 H	98	35.9	2.9
7	7371.00	58.1 PK	74.0	-15.9	1.15 H	194	48.4	9.7
8	7371.00	45.8 AV	54.0	-8.2	1.15 H	194	36.1	9.7

**ANTENNA POLARITY & TEST DISTANCE: VERTICAL AT 3 M**

NO.	FREQ. (MHz)	EMISSION LEVEL (dBuV/m)	LIMIT (dBuV/m)	MARGIN (dB)	ANTENNA HEIGHT (m)	TABLE ANGLE (Degree)	RAW VALUE (dBuV)	CORRECTION FACTOR (dB/m)
1	*2457.00	106.3 PK			1.09 V	38	108.6	-2.3
2	*2457.00	96.4 AV			1.09 V	38	98.7	-2.3
3	2483.50	66.9 PK	74.0	-7.1	1.09 V	38	69.1	-2.2
4	2483.50	49.4 AV	54.0	-4.6	1.09 V	38	51.6	-2.2
5	4914.00	46.8 PK	74.0	-27.2	1.24 V	79	43.9	2.9
6	4914.00	35.5 AV	54.0	-18.5	1.24 V	79	32.6	2.9
7	7371.00	53.8 PK	74.0	-20.2	1.05 V	194	44.1	9.7
8	7371.00	41.6 AV	54.0	-12.4	1.05 V	194	31.9	9.7

**REMARKS:**

1. Emission Level(dBuV/m) = Raw Value(dBuV) + Correction Factor(dB/m)
2. Correction Factor(dB/m) = Antenna Factor(dB/m) + Cable Factor(dB) – Pre-Amplifier Factor(dB)
3. The other emission levels were very low against the limit.
4. Margin value = Emission Level – Limit value
5. " \* ": Fundamental frequency.

<b>CHANNEL</b>	TX Channel 11	<b>DETECTOR FUNCTION</b>	Peak (PK)
<b>FREQUENCY RANGE</b>	1GHz ~ 25GHz		Average (AV)

**ANTENNA POLARITY & TEST DISTANCE: HORIZONTAL AT 3 M**

NO.	FREQ. (MHz)	EMISSION LEVEL (dBuV/m)	LIMIT (dBuV/m)	MARGIN (dB)	ANTENNA HEIGHT (m)	TABLE ANGLE (Degree)	RAW VALUE (dBuV)	CORRECTION FACTOR (dB/m)
1	*2462.00	110.2 PK			1.09 H	243	112.8	-2.6
2	*2462.00	100.7 AV			1.09 H	243	103.3	-2.6
3	2483.50	68.5 PK	74.0	-5.5	1.09 H	243	70.9	-2.4
4	2483.50	53.8 AV	54.0	-0.2	1.09 H	243	56.2	-2.4
5	4924.00	57.7 PK	74.0	-16.3	1.06 H	202	55.7	2.0
6	4924.00	45.4 AV	54.0	-8.6	1.06 H	202	43.4	2.0
7	7386.00	68.5 PK	74.0	-5.5	1.09 H	242	59.9	8.6
8	7386.00	53.8 AV	54.0	-0.2	1.09 H	242	45.2	8.6

**ANTENNA POLARITY & TEST DISTANCE: VERTICAL AT 3 M**

NO.	FREQ. (MHz)	EMISSION LEVEL (dBuV/m)	LIMIT (dBuV/m)	MARGIN (dB)	ANTENNA HEIGHT (m)	TABLE ANGLE (Degree)	RAW VALUE (dBuV)	CORRECTION FACTOR (dB/m)
1	*2462.00	104.6 PK			1.10 V	43	107.2	-2.6
2	*2462.00	95.5 AV			1.10 V	43	98.1	-2.6
3	2483.50	64.6 PK	74.0	-9.4	1.09 V	39	67.0	-2.4
4	2483.50	49.5 AV	54.0	-4.5	1.09 V	39	51.9	-2.4
5	4924.00	46.6 PK	74.0	-27.4	1.24 V	59	44.6	2.0
6	4924.00	35.1 AV	54.0	-18.9	1.24 V	59	33.1	2.0
7	7386.00	54.2 PK	74.0	-19.8	1.02 V	171	45.6	8.6
8	7386.00	41.5 AV	54.0	-12.5	1.02 V	171	32.9	8.6

**REMARKS:**

1. Emission Level(dBuV/m) = Raw Value(dBuV) + Correction Factor(dB/m)
2. Correction Factor(dB/m) = Antenna Factor(dB/m) + Cable Factor(dB) – Pre-Amplifier Factor(dB)
3. The other emission levels were very low against the limit.
4. Margin value = Emission Level – Limit value
5. " \* ": Fundamental frequency.

**Below 1GHz Data:**

**802.11g**

<b>CHANNEL</b>	TX Channel 6	<b>DETECTOR FUNCTION</b>	Quasi-Peak (QP)
<b>FREQUENCY RANGE</b>	9kHz ~ 1GHz		

**ANTENNA POLARITY & TEST DISTANCE: HORIZONTAL AT 3 M**

NO.	FREQ. (MHz)	EMISSION LEVEL (dBuV/m)	LIMIT (dBuV/m)	MARGIN (dB)	ANTENNA HEIGHT (m)	TABLE ANGLE (Degree)	RAW VALUE (dBuV)	CORRECTION FACTOR (dB/m)
1	39.70	30.6 QP	40.0	-9.4	1.54 H	209	38.9	-8.3
2	120.21	29.6 QP	43.5	-13.9	1.79 H	201	39.3	-9.7
3	212.36	33.9 QP	43.5	-9.6	2.91 H	331	45.0	-11.1
4	232.73	35.1 QP	46.0	-10.9	1.14 H	12	45.2	-10.1
5	477.17	30.2 QP	46.0	-15.8	1.59 H	287	32.4	-2.2
6	929.19	35.0 QP	46.0	-11.0	2.01 H	14	28.9	6.1

**ANTENNA POLARITY & TEST DISTANCE: VERTICAL AT 3 M**

NO.	FREQ. (MHz)	EMISSION LEVEL (dBuV/m)	LIMIT (dBuV/m)	MARGIN (dB)	ANTENNA HEIGHT (m)	TABLE ANGLE (Degree)	RAW VALUE (dBuV)	CORRECTION FACTOR (dB/m)
1	39.70	36.1 QP	40.0	-3.9	1.00 V	241	44.4	-8.3
2	69.77	30.8 QP	40.0	-9.2	2.51 V	119	40.6	-9.8
3	146.40	29.0 QP	43.5	-14.5	1.59 V	211	36.8	-7.8
4	165.80	30.4 QP	43.5	-13.1	2.81 V	144	38.4	-8.0
5	240.49	29.8 QP	46.0	-16.2	1.04 V	129	39.1	-9.3
6	862.26	37.1 QP	46.0	-8.9	1.00 V	218	32.5	4.6

**REMARKS:**

1. Emission Level(dBuV/m) = Raw Value(dBuV) + Correction Factor(dB/m)
2. Correction Factor(dB/m) = Antenna Factor(dB/m) + Cable Factor(dB) – Pre-Amplifier Factor(dB)
3. The other emission levels were very low against the limit.
4. Margin value = Emission Level – Limit value



## 4.2 Conducted Emission Measurement

### 4.2.1 Limits of Conducted Emission Measurement

Frequency (MHz)	Conducted Limit (dBuV)	
	Quasi-peak	Average
0.15 - 0.5	66 - 56	56 - 46
0.50 - 5.0	56	46
5.0 - 30.0	60	50

Note: 1. The lower limit shall apply at the transition frequencies.

2. The limit decreases in line with the logarithm of the frequency in the range of 0.15 to 0.50MHz.

### 4.2.2 Test Instruments

DESCRIPTION & MANUFACTURER	MODEL NO.	SERIAL NO.	CALIBRATED DATE	CALIBRATED UNTIL
Test Receiver R&S	ESCS 30	847124/029	Nov. 01, 2017	Oct. 31, 2018
Line-Impedance Stabilization Network (for EUT) R&S	ESH3-Z5	848773/004	Nov. 15, 2017	Nov. 14, 2018
Line-Impedance Stabilization Network (for Peripheral) R&S	ENV216	100072	June 03, 2017	June 02, 2018
50 ohms Terminator	N/A	EMC-02	Sep. 22, 2017	Sep. 21, 2018
RF Cable	5D-FB	COCCAB-001	Sep. 29, 2017	Sep. 28, 2018
Fixed attenuator EMEC	STI02-2200-10	003	Mar. 16, 2018	Mar. 15, 2019
Software BVADT	BVADT_Cond_ V7.3.7.4	NA	NA	NA

**Note:**

1. The calibration interval of the above test instruments are 12 months and the calibrations are traceable to NML/ROC and NIST/USA.
2. The test was performed in Conduction 1.
3. Tested Date: Apr. 24, 2018

#### 4.2.3 Test Procedures

- The EUT was placed 0.4 meters from the conducting wall of the shielded room with EUT being connected to the power mains through a line impedance stabilization network (LISN). Other support units were connected to the power mains through another LISN. The two LISNs provide 50 ohm/ 50uH of coupling impedance for the measuring instrument.
- Both lines of the power mains connected to the EUT were checked for maximum conducted interference.
- The frequency range from 150kHz to 30MHz was searched. Emission levels under (Limit - 20dB) was not recorded.

**NOTE:** The resolution bandwidth and video bandwidth of test receiver is 9kHz for quasi-peak detection (QP) and average detection (AV) at frequency 0.15MHz-30MHz.

#### 4.2.4 Deviation from Test Standard

No deviation.

#### 4.2.5 Test Setup

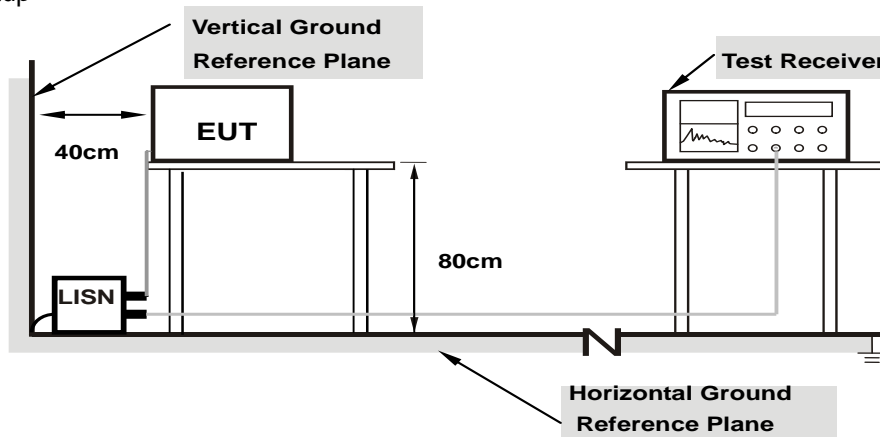

**Note:** 1.Support units were connected to second LISN.

For the actual test configuration, please refer to the attached file (Test Setup Photo).

#### 4.2.6 EUT Operating Conditions

Same as 4.1.6.

#### 4.2.7 Test Results

Phase	Line (L)	Detector Function	Quasi-Peak (QP) / Average (AV)
-------	----------	-------------------	--------------------------------

No	Freq.	Corr.	Reading Value		Emission Level		Limit		Margin	
	[MHz]	Factor	[dB (uV)]		[dB (uV)]		[dB (uV)]		(dB)	
		(dB)	Q.P.	AV.	Q.P.	AV.	Q.P.	AV.	Q.P.	AV.
1	0.15000	10.03	39.02	17.08	49.05	27.11	66.00	56.00	-16.95	-28.89
2	0.18516	10.05	36.73	20.21	46.78	30.26	64.25	54.25	-17.47	-23.99
3	0.52891	10.12	22.44	6.63	32.56	16.75	56.00	46.00	-23.44	-29.25
4	2.76563	10.22	23.23	13.93	33.45	24.15	56.00	46.00	-22.55	-21.85
5	8.35547	10.47	18.21	10.56	28.68	21.03	60.00	50.00	-31.32	-28.97
6	20.01953	11.10	14.30	7.84	25.40	18.94	60.00	50.00	-34.60	-31.06

#### Remarks:

1. Q.P. and AV. are abbreviations of quasi-peak and average individually.
2. The emission levels of other frequencies were very low against the limit.
3. Margin value = Emission level – Limit value
4. Correction factor = Insertion loss + Cable loss
5. Emission Level = Correction Factor + Reading Value

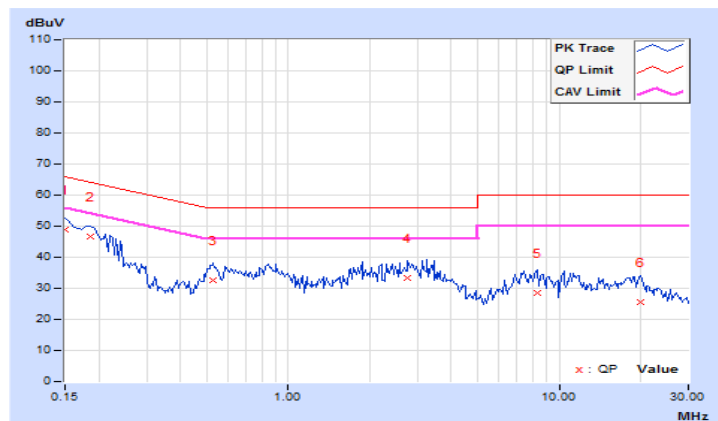

Phase	Neutral (N)	Detector Function	Quasi-Peak (QP) / Average (AV)
-------	-------------	-------------------	--------------------------------

No	Freq.	Corr.	Reading Value		Emission Level		Limit		Margin	
	[MHz]	Factor	[dB (uV)]		[dB (uV)]		[dB (uV)]		(dB)	
		(dB)	Q.P.	AV.	Q.P.	AV.	Q.P.	AV.	Q.P.	AV.
1	0.15000	9.94	41.34	18.81	51.28	28.75	66.00	56.00	-14.72	-27.25
2	0.22812	9.97	24.42	0.86	34.39	10.83	62.52	52.52	-28.13	-41.69
3	0.54844	10.01	20.31	3.66	30.32	13.67	56.00	46.00	-25.68	-32.33
4	0.89219	10.02	19.74	8.81	29.76	18.83	56.00	46.00	-26.24	-27.17
5	3.68750	10.13	22.13	11.71	32.26	21.84	56.00	46.00	-23.74	-24.16
6	19.99219	10.90	15.87	6.44	26.77	17.34	60.00	50.00	-33.23	-32.66

**Remarks:**

1. Q.P. and AV. are abbreviations of quasi-peak and average individually.
2. The emission levels of other frequencies were very low against the limit.
3. Margin value = Emission level – Limit value
4. Correction factor = Insertion loss + Cable loss
5. Emission Level = Correction Factor + Reading Value

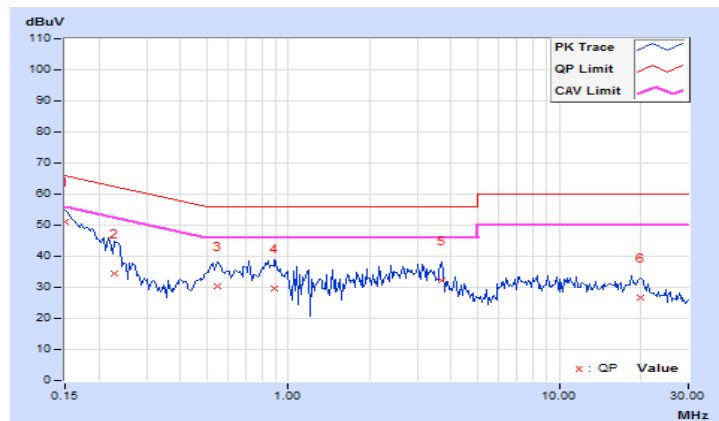

### 4.3 6dB Bandwidth Measurement

#### 4.3.1 Limits of 6dB Bandwidth Measurement

The minimum of 6dB Bandwidth Measurement is 0.5 MHz.

#### 4.3.2 Test Setup

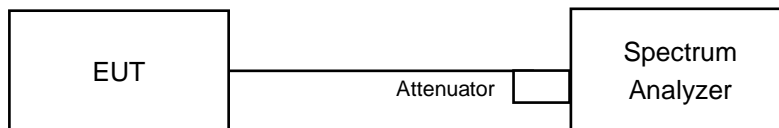

#### 4.3.3 Test Instruments

Refer to section 4.1.2 to get information of above instrument.

#### 4.3.4 Test Procedure

- a. Set resolution bandwidth (RBW) = 100kHz
- b. Set the video bandwidth (VBW)  $\geq 3 \times$  RBW, Detector = Peak.
- c. Trace mode = max hold.
- d. Sweep = auto couple.
- e. Measure the maximum width of the emission that is constrained by the frequencies associated with the two amplitude points (upper and lower) that are attenuated by 6 dB relative to the maximum level measured in the fundamental emission

#### 4.3.5 Deviation from Test Standard

No deviation.

#### 4.3.6 EUT Operating Conditions

The software provided by client to enable the EUT under transmission condition continuously at lowest, middle and highest channel frequencies individually.

#### 4.3.7 Test Result

##### 802.11b

Channel	Frequency (MHz)	6dB Bandwidth (MHz)		Minimum Limit (MHz)	Pass / Fail
		Chain 0	Chain 1		
1	2412	9.13	9.14	0.5	Pass
6	2437	9.61	9.57	0.5	Pass
11	2462	9.61	9.15	0.5	Pass

##### 802.11g

Channel	Frequency (MHz)	6dB Bandwidth (MHz)		Minimum Limit (MHz)	Pass / Fail
		Chain 0	Chain 1		
1	2412	15.19	15.18	0.5	Pass
6	2437	15.18	15.20	0.5	Pass
9	2452	15.19	15.16	0.5	Pass
10	2457	15.18	15.20	0.5	Pass
11	2462	15.19	15.19	0.5	Pass

##### 802.11n (HT20)

Channel	Frequency (MHz)	6dB Bandwidth (MHz)		Minimum Limit (MHz)	Pass / Fail
		Chain 0	Chain 1		
1	2412	15.16	15.18	0.5	Pass
6	2437	15.20	15.18	0.5	Pass
10	2457	15.19	15.18	0.5	Pass
11	2462	15.19	15.76	0.5	Pass

### Spectrum Plot of Worst Value

#### 802.11b / Chain 0 : CH1

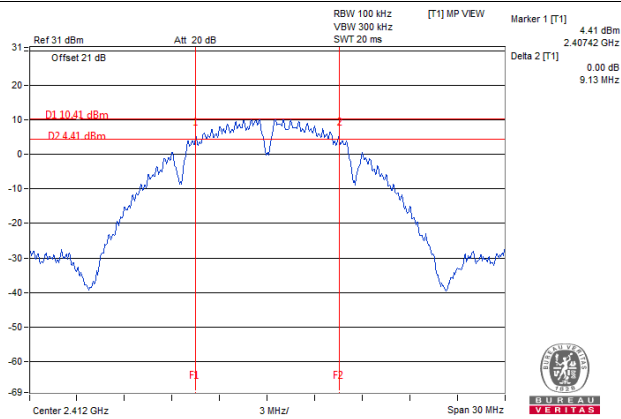

#### 802.11g / Chain 1 : CH9

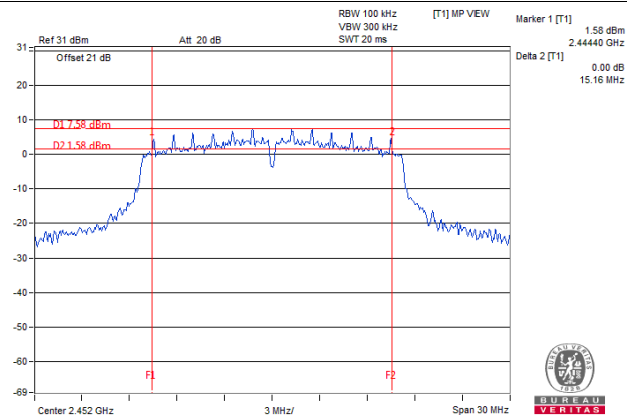

#### 802.11n (HT20) / Chain 0 : CH1

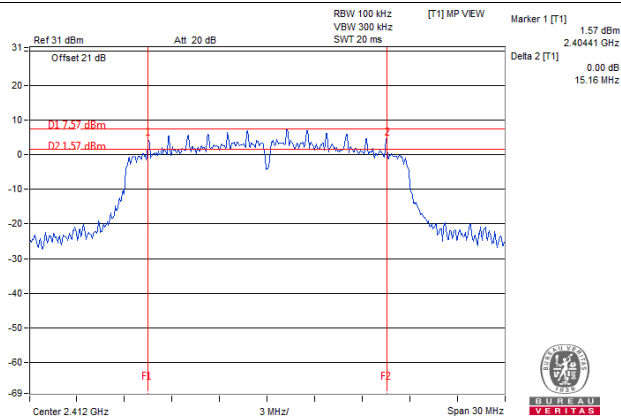

## 4.4 Conducted Output Power Measurement

### 4.4.1 Limits of Conducted Output Power Measurement

For systems using digital modulation in the 2400–2483.5 MHz bands: 1 Watt (30dBm)

Per KDB 662911 D01 Multiple Transmitter Output Method of conducted output power measurement on IEEE 802.11 devices,

Array Gain = 0 dB (i.e., no array gain) for  $N_{ANT} \leq 4$ ;

Array Gain = 0 dB (i.e., no array gain) for channel widths  $\geq 40$  MHz for any  $N_{ANT}$ ;

Array Gain =  $5 \log(N_{ANT}/N_{SS})$  dB or 3 dB, whichever is less for 20-MHz channel widths with  $N_{ANT} \geq 5$ .

For power measurements on all other devices: Array Gain =  $10 \log(N_{ANT}/N_{SS})$  dB.

### 4.4.2 Test Setup

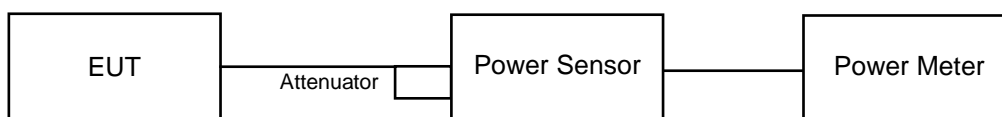

### 4.4.3 Test Instruments

Refer to section 4.1.2 to get information of above instrument.

### 4.4.4 Test Procedures

A peak power sensor was used on the output port of the EUT. A power meter was used to read the response of the peak power sensor. Record the power level.

Average power sensor was used to perform output power measurement, trigger and gating function of wide band power meter is enabled to measure max output power of TX on burst. Duty factor is not added to measured value.

### 4.4.5 Deviation from Test Standard

No deviation.

### 4.4.6 EUT Operating Conditions

Same as Item 4.3.6.



#### 4.4.7 Test Results

#### FOR PEAK POWER

##### 802.11b

Chan.	Freq. (MHz)	Peak Power (dBm)		Total Power (mW)	Total Power (dBm)	Limit (dBm)	Pass / Fail
		Chain 0	Chain 1				
1	2412	22.56	22.47	356.906	25.53	30.00	Pass
6	2437	22.51	22.59	359.79	25.56	30.00	Pass
11	2462	22.24	22.02	326.715	25.14	30.00	Pass

##### 802.11g

Chan.	Freq. (MHz)	Peak Power (dBm)		Total Power (mW)	Total Power (dBm)	Limit (dBm)	Pass / Fail
		Chain 0	Chain 1				
1	2412	24.37	24.88	581.137	27.64	30.00	Pass
6	2437	25.28	25.62	702.041	28.46	30.00	Pass
9	2452	24.38	24.36	547.055	27.38	30.00	Pass
10	2457	24.33	24.34	542.663	27.35	30.00	Pass
11	2462	24.01	24.28	519.685	27.16	30.00	Pass

##### 802.11n (HT20)

Chan.	Freq. (MHz)	Peak Power (dBm)		Total Power (mW)	Total Power (dBm)	Limit (dBm)	Pass / Fail
		Chain 0	Chain 1				
1	2412	24.52	24.90	592.169	27.72	30.00	Pass
6	2437	25.06	25.56	680.376	28.33	30.00	Pass
10	2457	24.36	24.47	552.796	27.43	30.00	Pass
11	2462	24.96	25.14	639.917	28.06	30.00	Pass

## FOR AVERAGE POWER

### 802.11b

Chan.	Frequency (MHz)	Avg. Power (dBm)		Total Power (mW)	Total Power (dBm)
		Chain 0	Chain 1		
1	2412	20.56	20.46	224.936	23.52
6	2437	20.53	20.41	222.881	23.48
11	2462	20.02	20.01	200.693	23.03

### 802.11g

Chan.	Frequency (MHz)	Avg. Power (dBm)		Total Power (mW)	Total Power (dBm)
		Chain 0	Chain 1		
1	2412	18.29	18.39	136.477	21.35
6	2437	20.79	21.50	261.204	24.17
9	2452	18.47	18.39	139.331	21.44
10	2457	17.83	17.90	122.334	20.88
11	2462	17.51	17.59	113.776	20.56

### 802.11n (HT20)

Chan.	Frequency (MHz)	Avg. Power (dBm)		Total Power (mW)	Total Power (dBm)
		Chain 0	Chain 1		
1	2412	18.24	18.22	133.055	21.24
6	2437	20.52	20.99	238.323	23.77
10	2457	17.97	17.96	125.178	20.98
11	2462	17.21	17.40	107.556	20.32

## 4.5 Power Spectral Density Measurement

### 4.5.1 Limits of Power Spectral Density Measurement

The Maximum of Power Spectral Density Measurement is 8dBm in any 3 kHz.

### 4.5.2 Test Setup

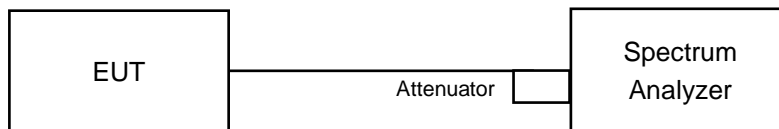

### 4.5.3 Test Instruments

Refer to section 4.1.2 to get information of above instrument.

### 4.5.4 Test Procedure

- a. Set analyzer center frequency to DTS channel center frequency.
- b. Set the span to 1.5 times the DTS bandwidth.
- c. Set the RBW to:  $3 \text{ kHz} \leq \text{RBW} \leq 100 \text{ kHz}$ .
- d. Set the VBW  $\geq 3 \times \text{RBW}$ .
- e. Detector = peak.
- f. Sweep time = auto couple.
- g. Trace mode = max hold.
- h. Allow trace to fully stabilize.
- i. Use the peak marker function to determine the maximum amplitude level within the RBW.

### 4.5.5 Deviation from Test Standard

No deviation.

### 4.5.6 EUT Operating Condition

Same as Item 4.3.6

#### 4.5.7 Test Results

##### 802.11b

TX chain	Channel	Freq. (MHz)	PSD (dBm/3kHz)	10 log (N=2) dB	Total PSD (dBm/3kHz)	Limit (dBm/3kHz)	Pass /Fail
0	1	2412	-5.55	3.01	-2.54	8.00	Pass
	6	2437	-5.74	3.01	-2.73	8.00	Pass
	11	2462	-6.04	3.01	-3.03	8.00	Pass
1	1	2412	-5.53	3.01	-2.52	8.00	Pass
	6	2437	-5.36	3.01	-2.35	8.00	Pass
	11	2462	2.11	3.01	5.12	8.00	Pass

**Note:** 1. Directional gain =  $10 \log[(10^{G0/20} + 10^{G1/20})^2 / 2] = 3.15\text{dBi} < 6\text{dBi}$  , so the power density limit shall not be reduced.

##### 802.11g

TX chain	Channel	Freq. (MHz)	PSD (dBm/3kHz)	10 log (N=2) dB	Total PSD (dBm/3kHz)	Limit (dBm/3kHz)	Pass /Fail
0	1	2412	-7.40	3.01	-4.39	8.00	Pass
	6	2437	-6.63	3.01	-3.62	8.00	Pass
	9	2452	-9.33	3.01	-6.32	8.00	Pass
	10	2457	-6.63	3.01	-3.62	8.00	Pass
	11	2462	-8.60	3.01	-5.59	8.00	Pass
1	1	2412	-9.15	3.01	-6.14	8.00	Pass
	6	2437	-6.54	3.01	-3.53	8.00	Pass
	9	2452	-7.92	3.01	-4.91	8.00	Pass
	10	2457	-6.54	3.01	-3.53	8.00	Pass
	11	2462	-8.84	3.01	-5.83	8.00	Pass

**Note:** 1. Directional gain =  $10 \log[(10^{G0/20} + 10^{G1/20})^2 / 2] = 3.15\text{dBi} < 6\text{dBi}$  , so the power density limit shall not be reduced.

### 802.11n (HT20)

TX chain	Channel	Freq. (MHz)	PSD (dBm/3kHz)	10 log (N=2) dB	Total PSD (dBm/3kHz)	Limit (dBm/3kHz)	Pass /Fail
0	1	2412	-9.31	3.01	-6.30	8.00	Pass
	6	2437	-6.16	3.01	-3.15	8.00	Pass
	10	2457	-9.20	3.01	-6.19	8.00	Pass
	11	2462	-10.12	3.01	-7.11	8.00	Pass
1	1	2412	-8.80	3.01	-5.79	8.00	Pass
	6	2437	-5.61	3.01	-2.60	8.00	Pass
	10	2457	-7.96	3.01	-4.95	8.00	Pass
	11	2462	-9.34	3.01	-6.33	8.00	Pass

**Note:** 1. Directional gain =  $10 \log[(10^{G0/20} + 10^{G1/20})^2 / 2] = 3.15\text{dBi} < 6\text{dBi}$  , so the power density limit shall not be reduced.

Spectrum Plot of Worst Value

802.11b / Chain 1 : CH11

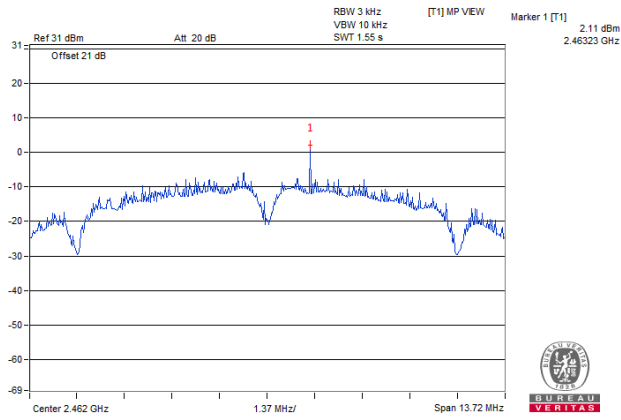

802.11g / Chain 1 : CH6

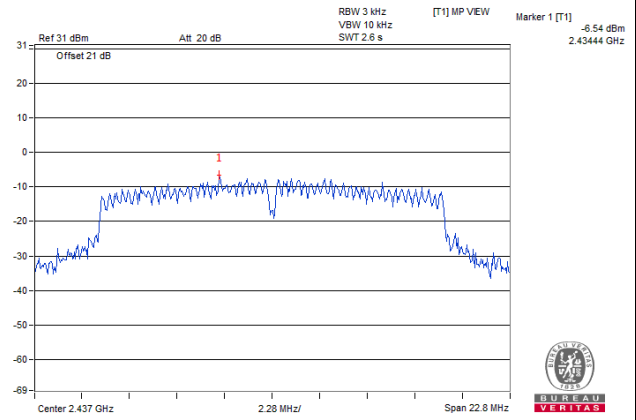

802.11n (HT20) / Chain 1 : CH6

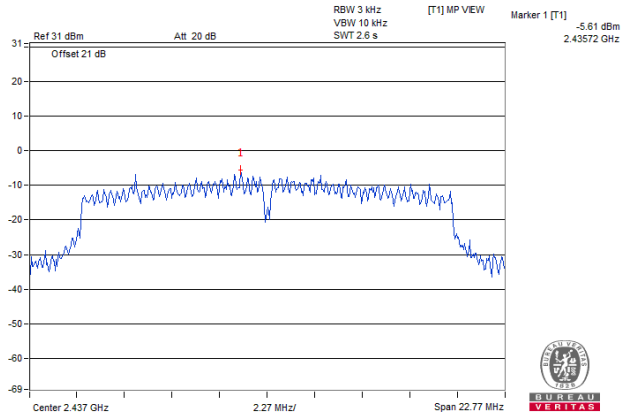

## 4.6 Conducted Out of Band Emission Measurement

### 4.6.1 Limits of Conducted Out of Band Emission Measurement

Below 20dB of the highest emission level of operating band (in 100kHz Resolution Bandwidth).

### 4.6.2 Test Setup

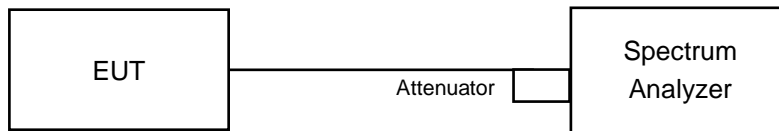

### 4.6.3 Test Instruments

Refer to section 4.1.2 to get information of above instrument.

### 4.6.4 Test Procedure

#### MEASUREMENT PROCEDURE REF

1. Set the RBW = 100 kHz.
2. Set the VBW  $\geq$  300 kHz.
3. Detector = peak.
4. Sweep time = auto couple.
5. Trace mode = max hold.
6. Allow trace to fully stabilize.
7. Use the peak marker function to determine the maximum power level in any 100 kHz band segment within the fundamental EBW.

#### MEASUREMENT PROCEDURE OOB

1. Set RBW = 100 kHz.
2. Set VBW  $\geq$  300 kHz.
3. Detector = peak.
4. Sweep = auto couple.
5. Trace Mode = max hold.
6. Allow trace to fully stabilize.
7. Use the peak marker function to determine the maximum amplitude level.

### 4.6.5 Deviation from Test Standard

No deviation.

### 4.6.6 EUT Operating Condition

Same as Item 4.3.6

### 4.6.7 Test Results

The spectrum plots are attached on the following pages. D1 line indicates the highest level, and D2 line indicates the 20dB offset below D1. It shows compliance with the requirement.

802.11b  
Chain 0

CH 1

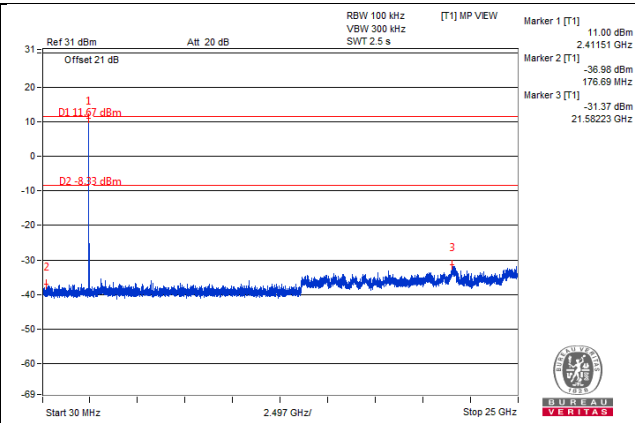
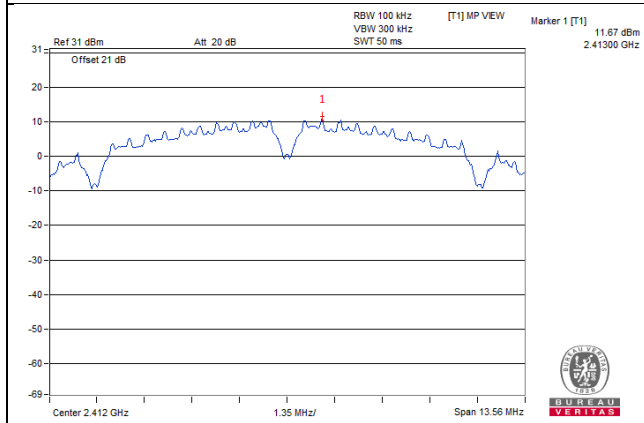

CH 6

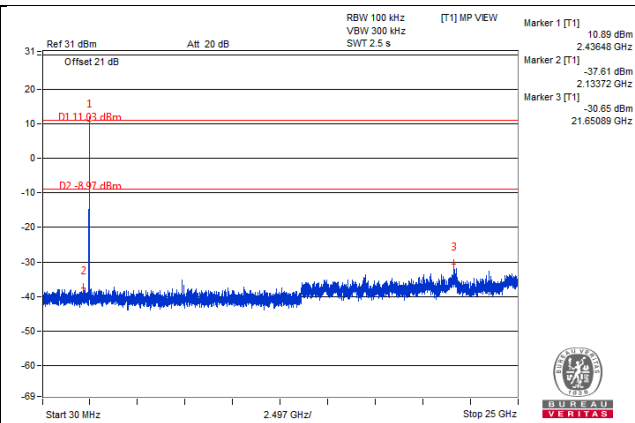
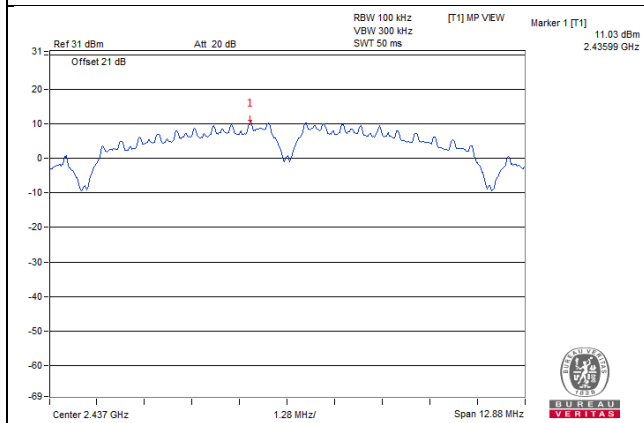

CH 11

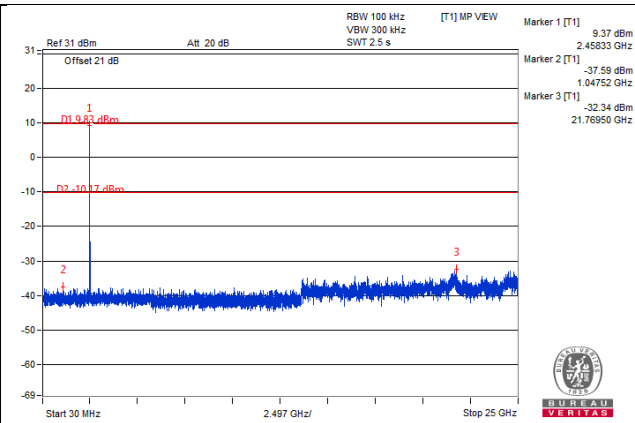
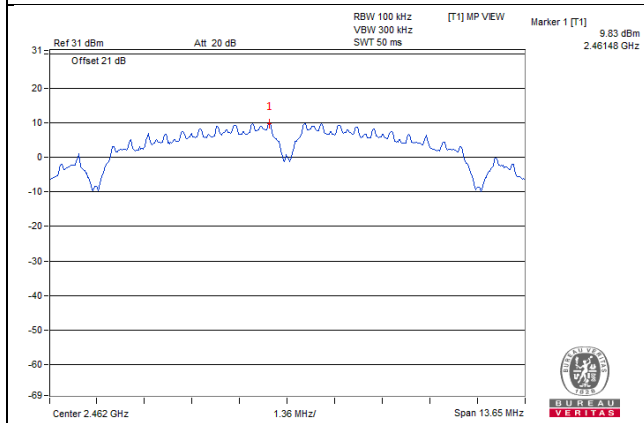

CH 1 Band edge

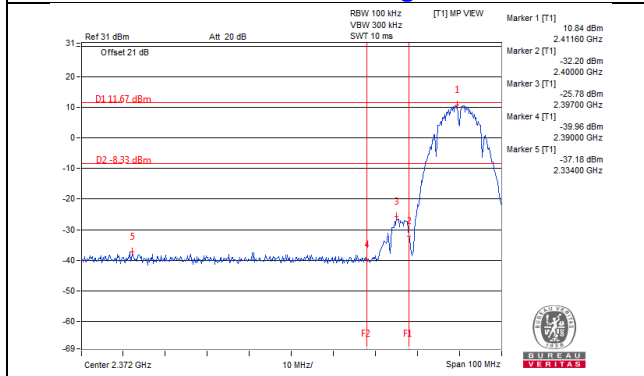

CH 11 Band edge

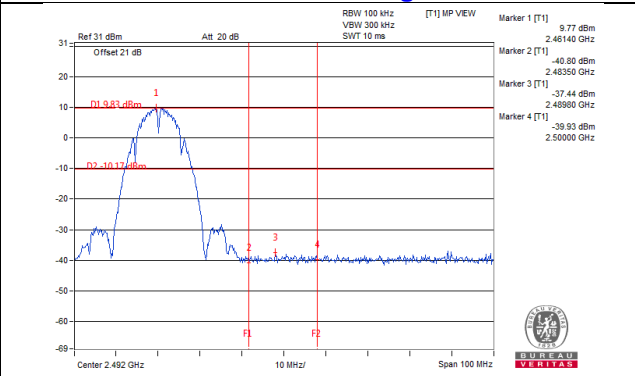



### Chain 1

#### CH 1

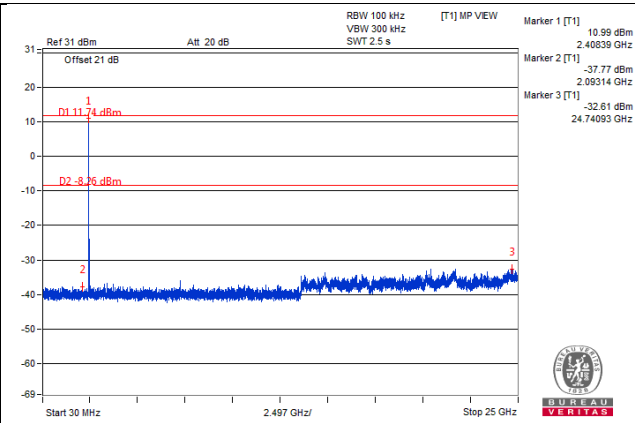
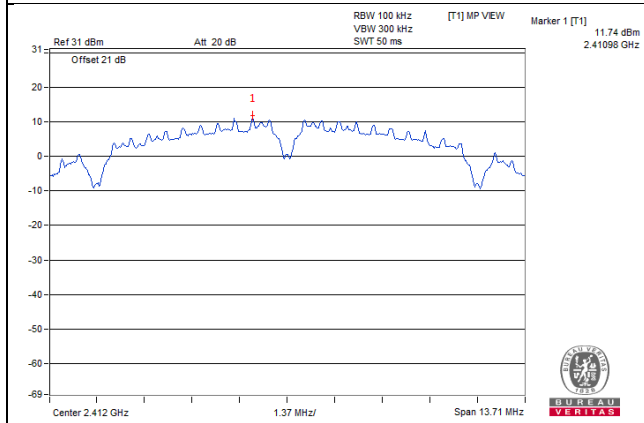

#### CH 6

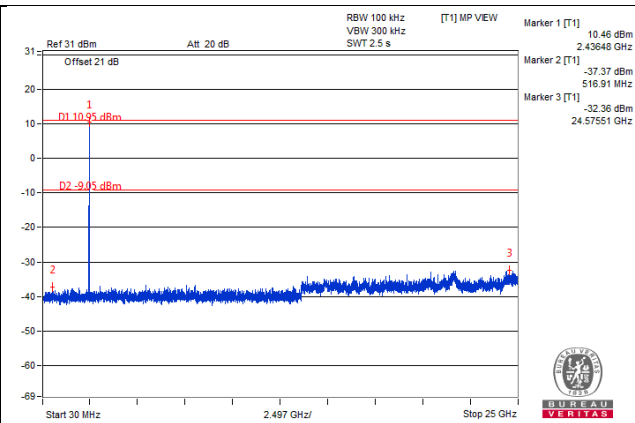
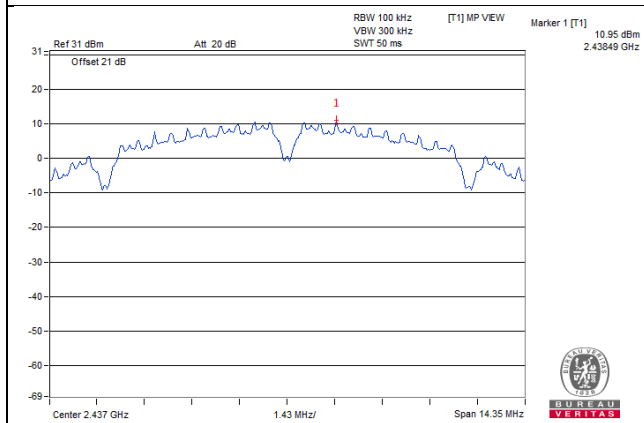

#### CH 11

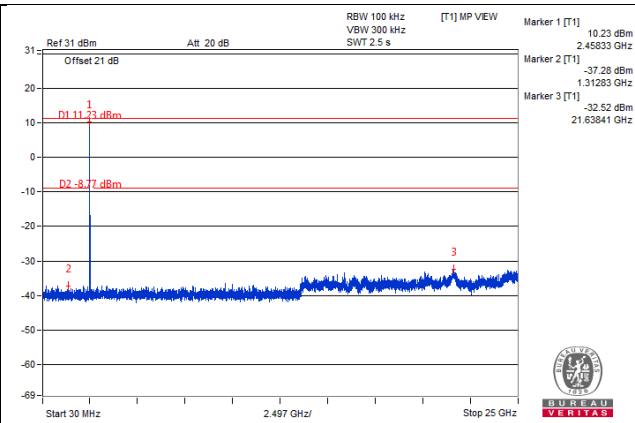
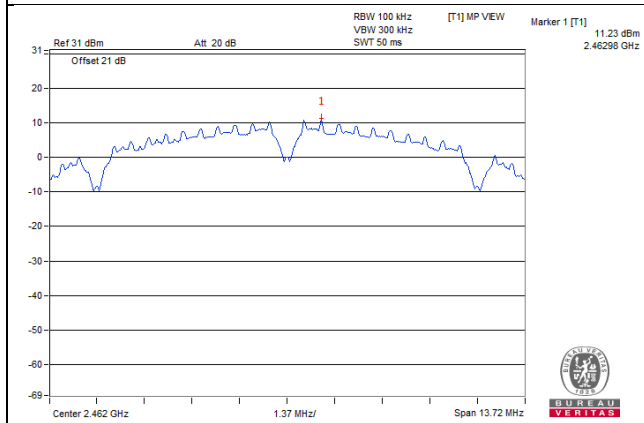

#### CH 1 Band edge

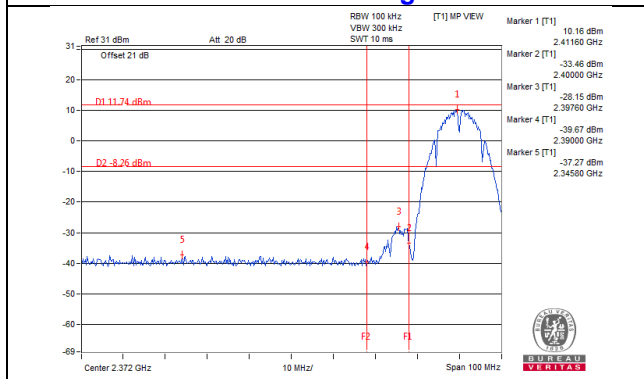

#### CH 11 Band edge

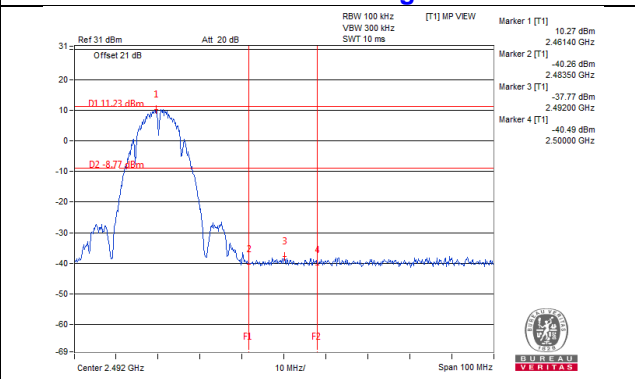

802.11g  
Chain 0

CH 1

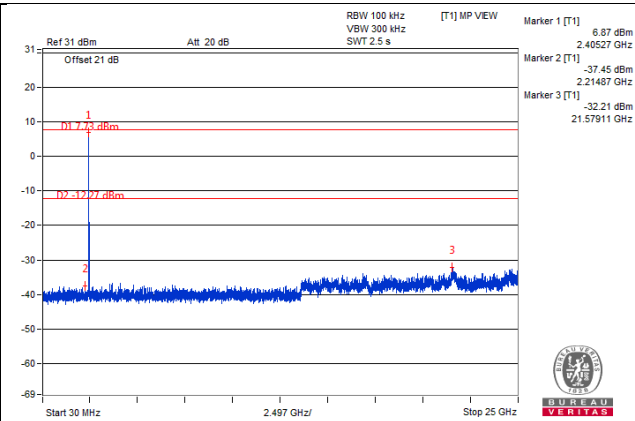
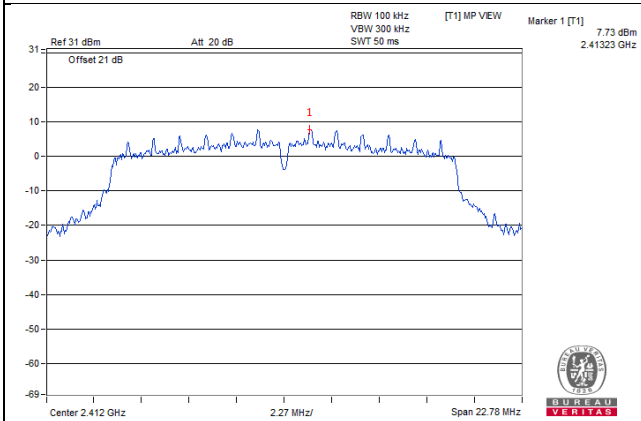

CH 6

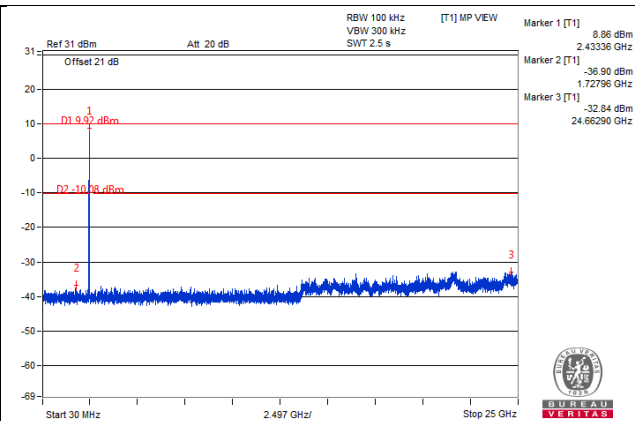
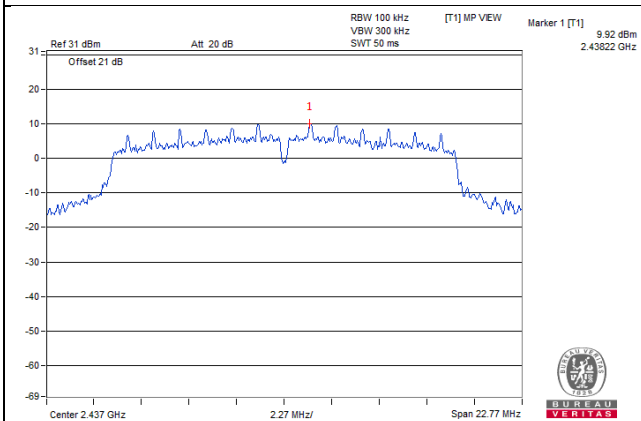

CH 9

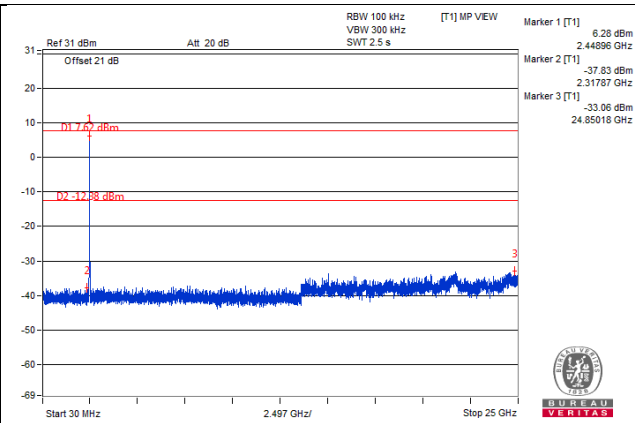
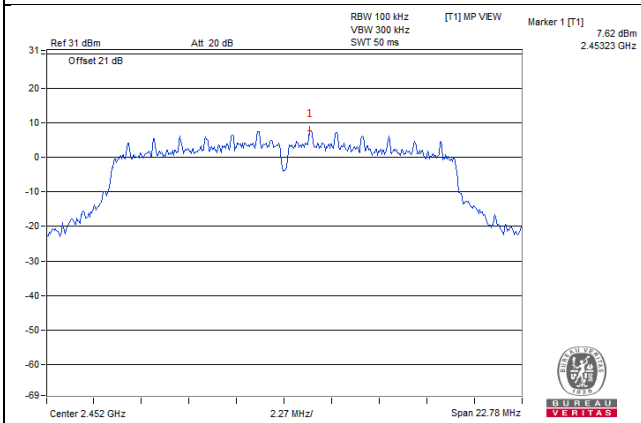

### CH 10

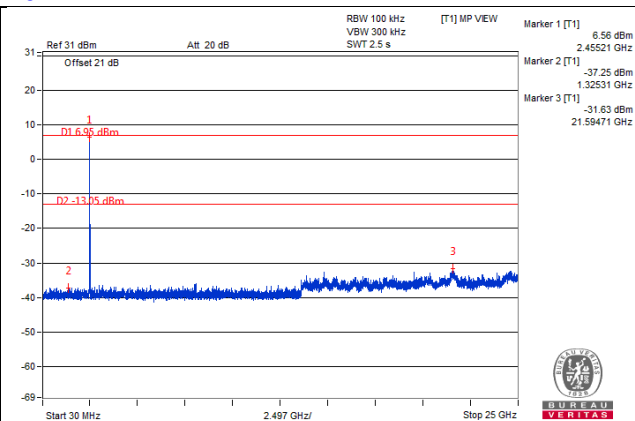
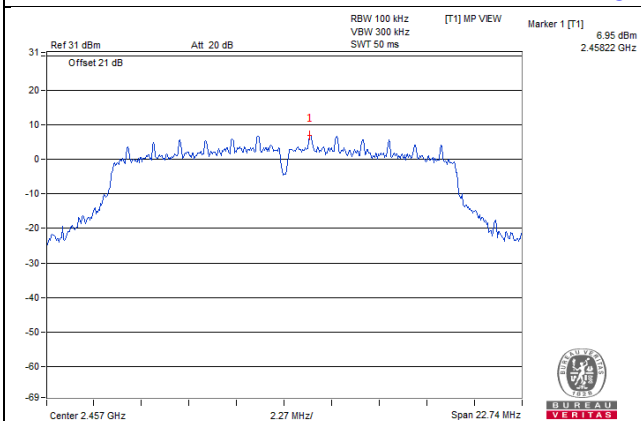

### CH 11

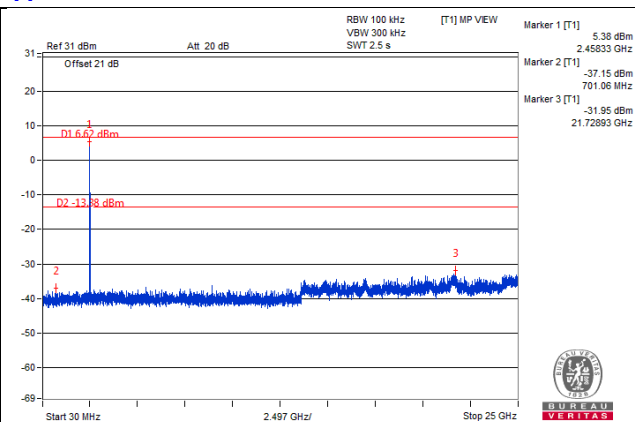
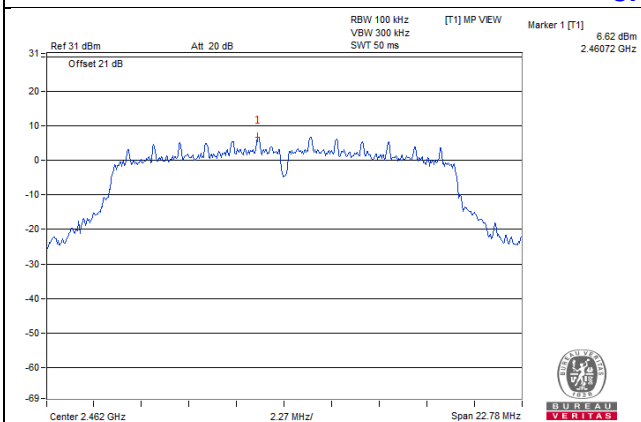

### CH 10 Band edge

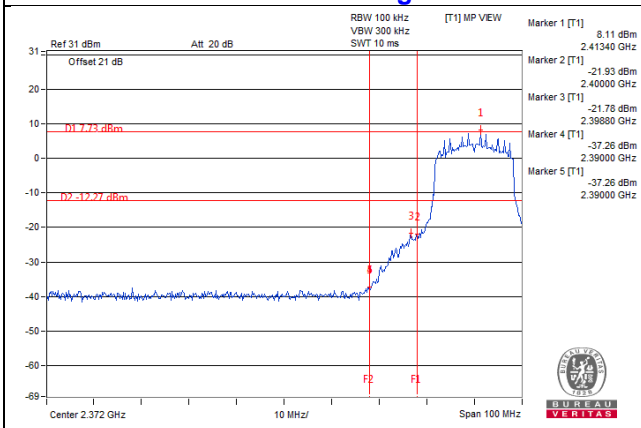

### CH 11 Band edge

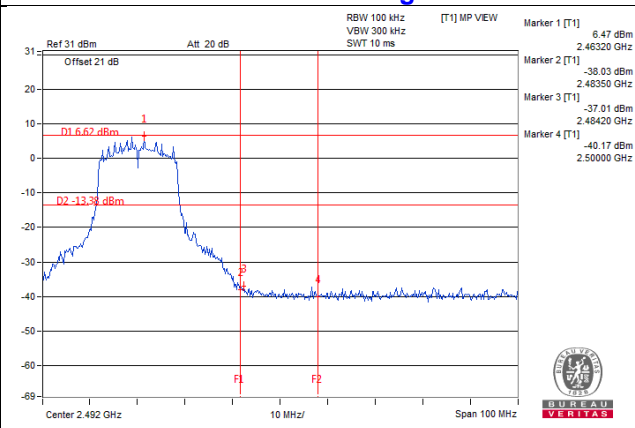

### Chain 1

#### CH 1

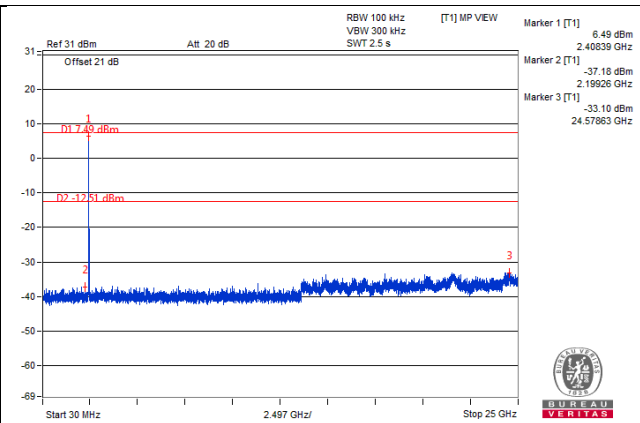
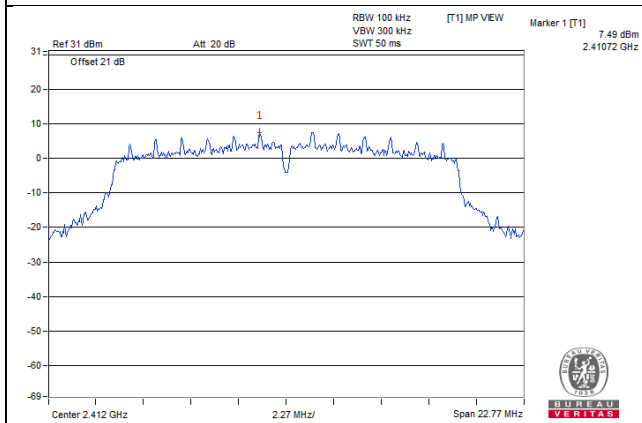

#### CH 6

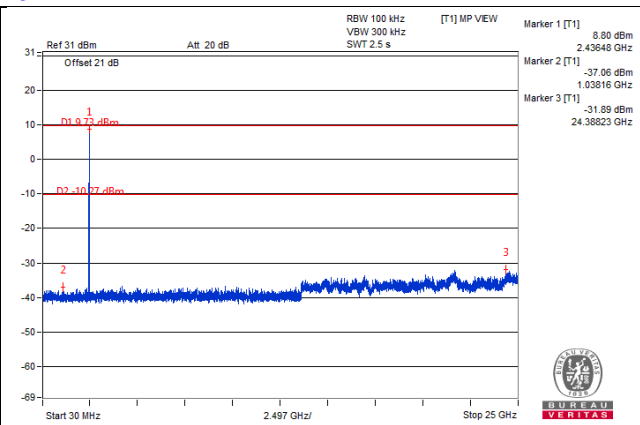
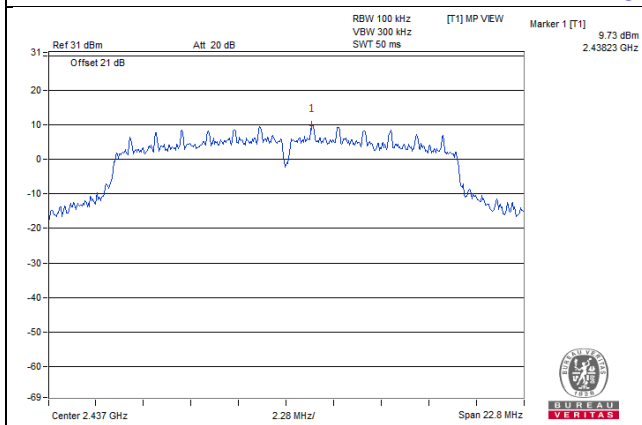

#### CH 9

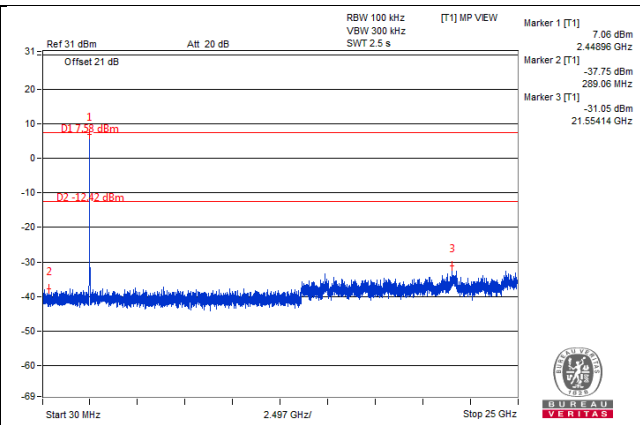
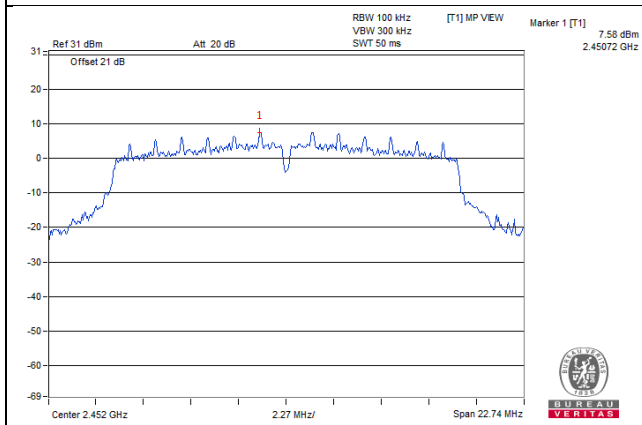

### CH 10

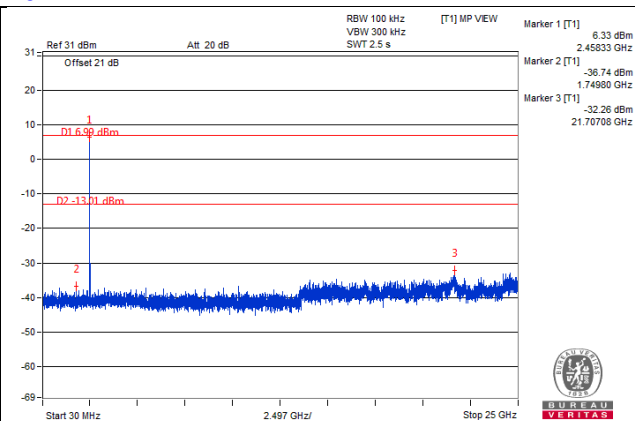
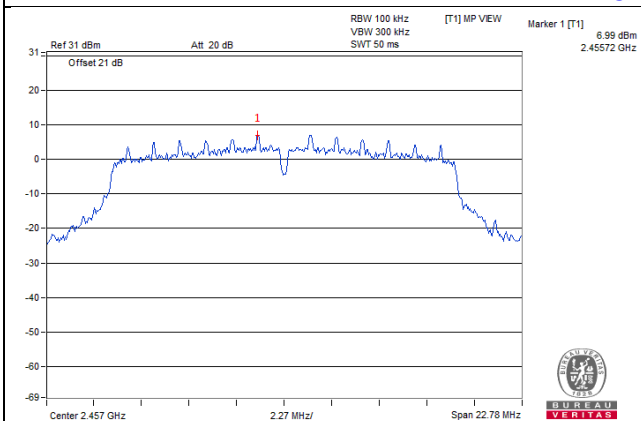

### CH 11

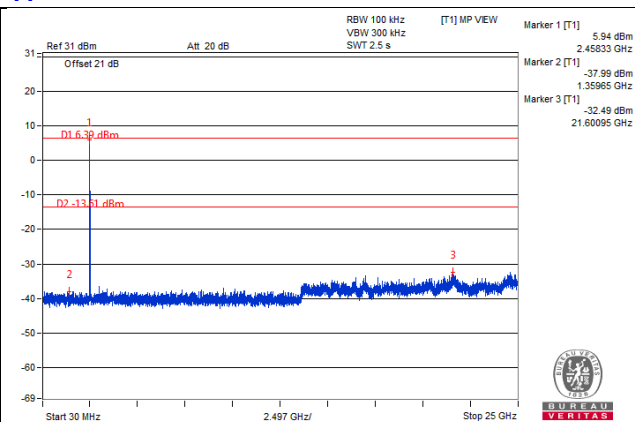
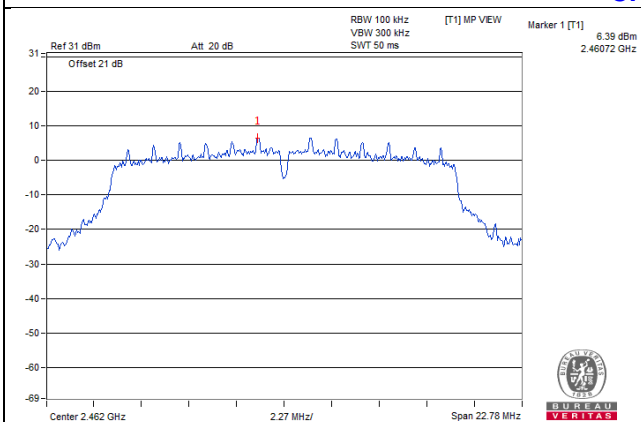

### CH 10 Band edge

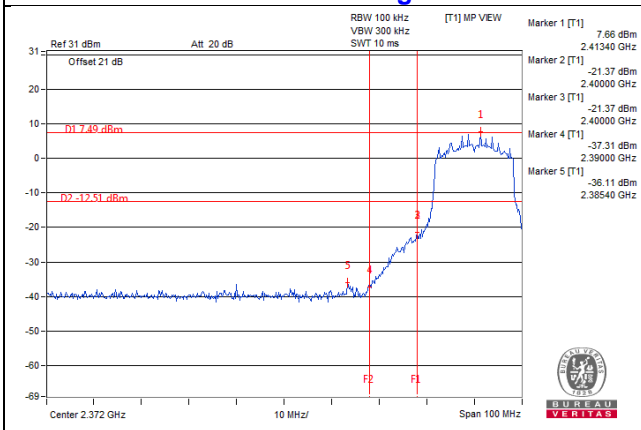

### CH 11 Band edge

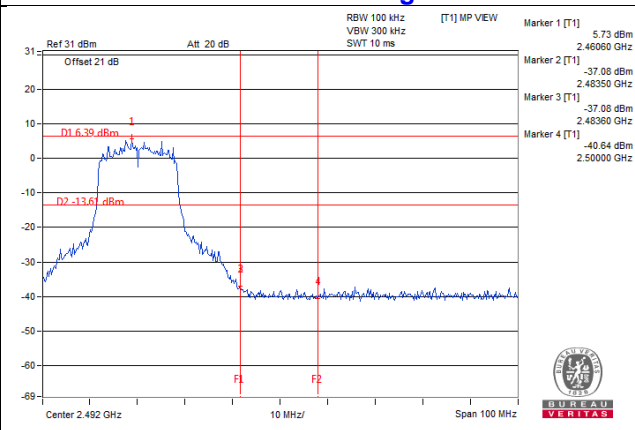

802.11n (HT20)  
Chain 0

CH 1

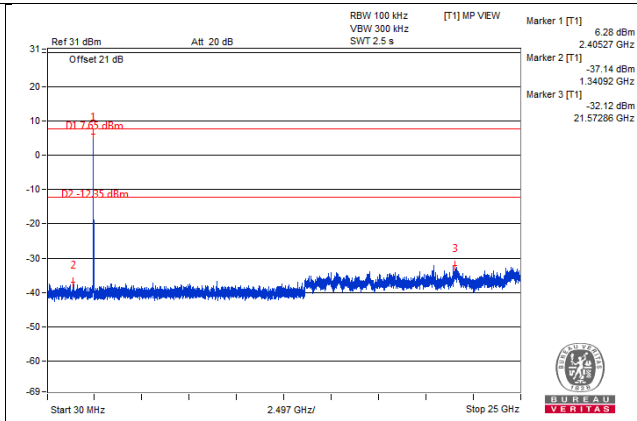
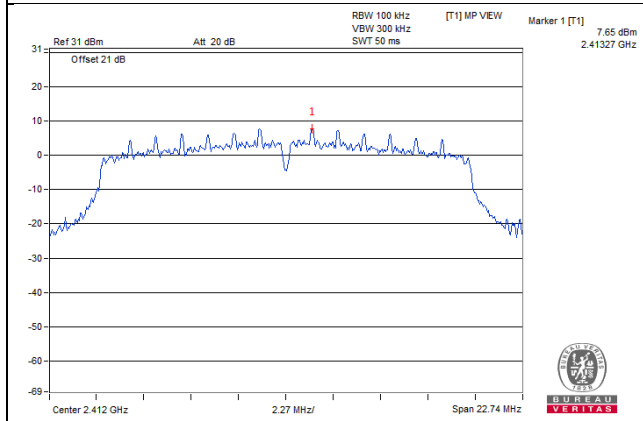

CH 6

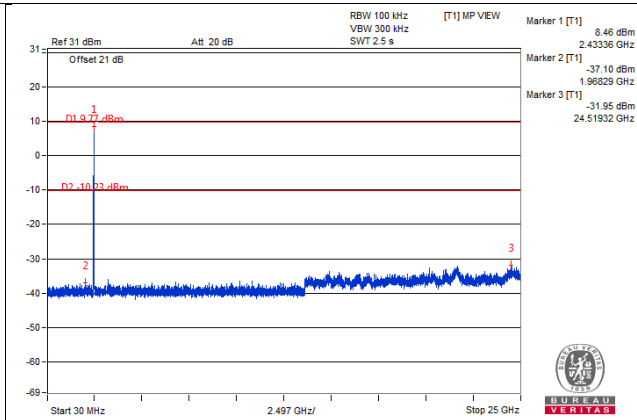
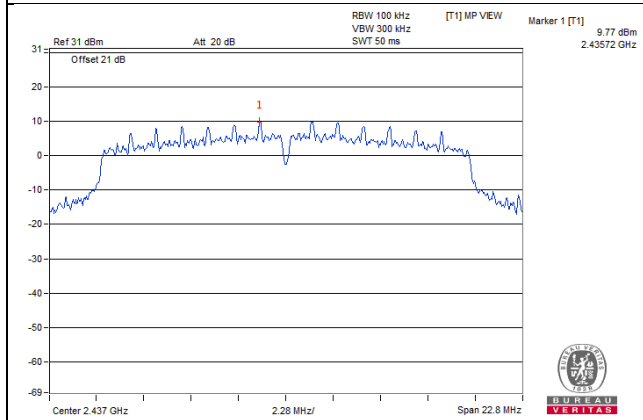

CH 10

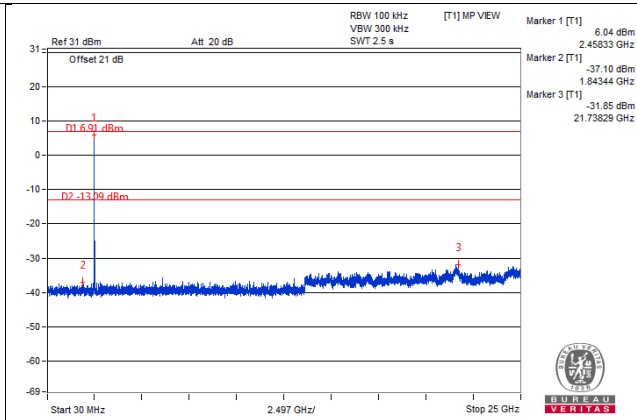
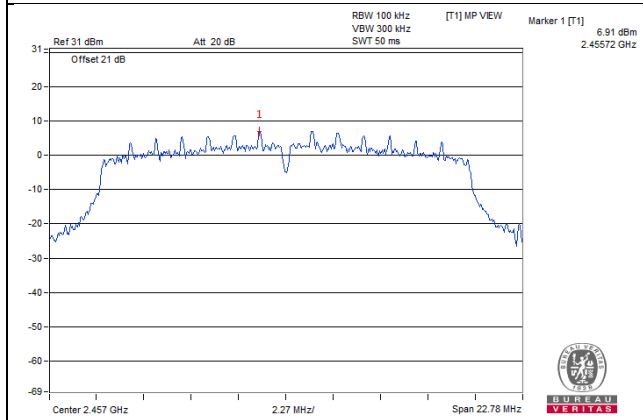

### CH 11

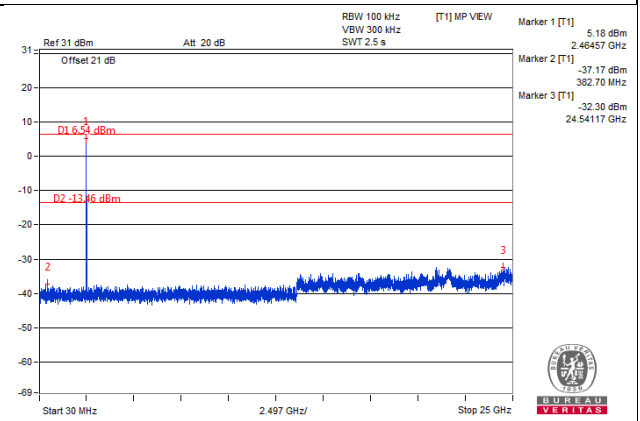
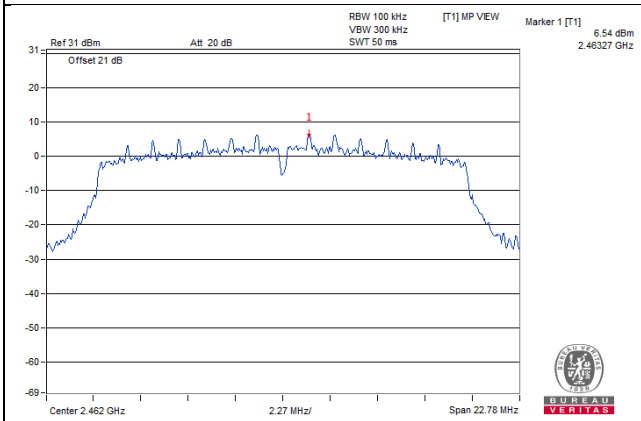

### CH 1 Band edge

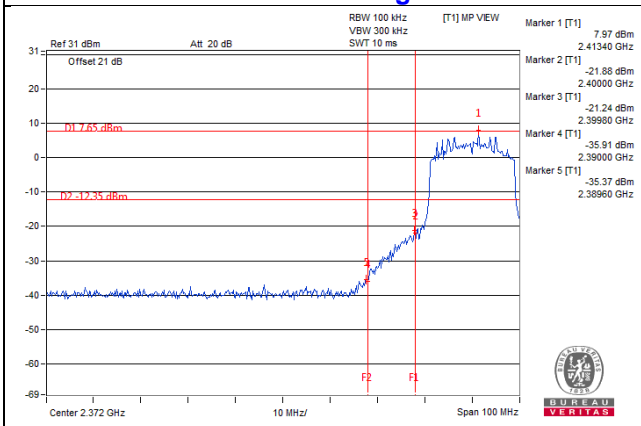

### CH 11 Band edge

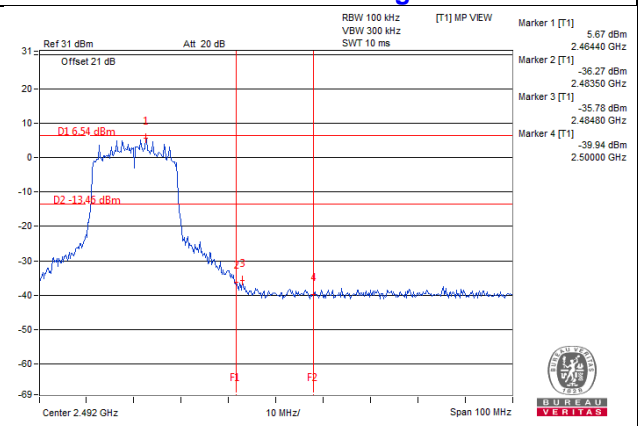

Chain 1

CH 1

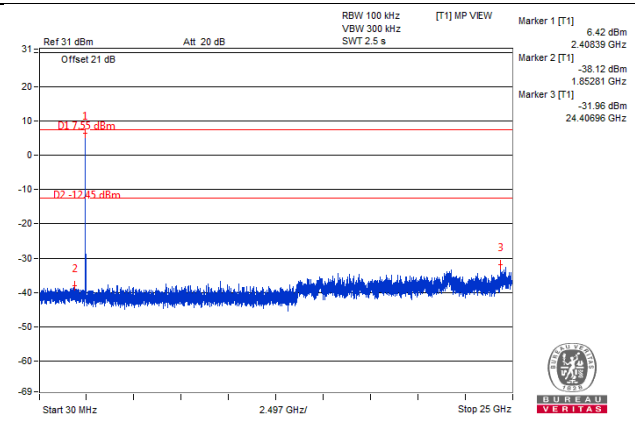
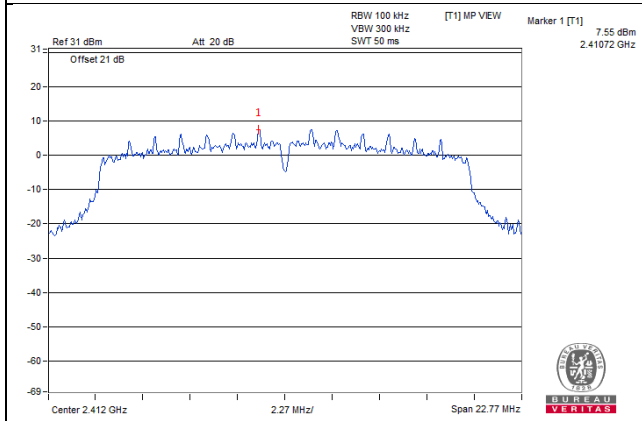

CH 6

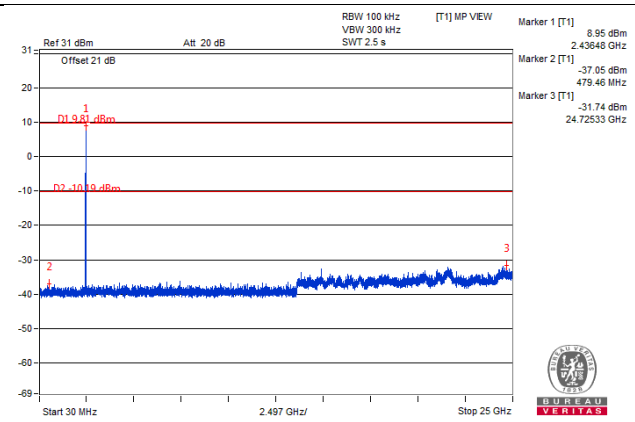
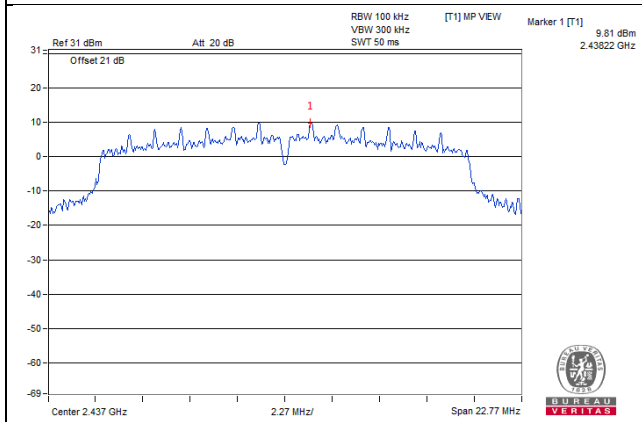

CH 10

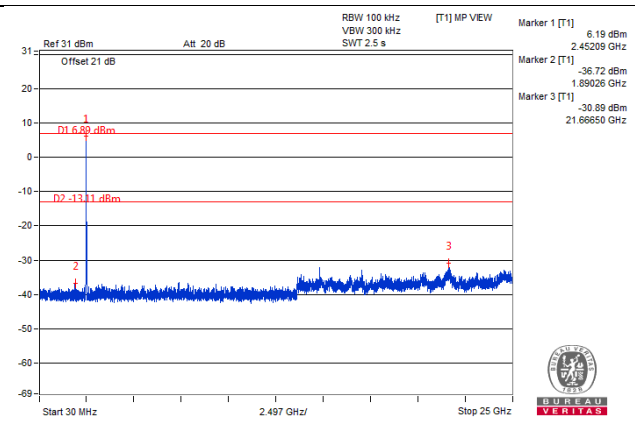
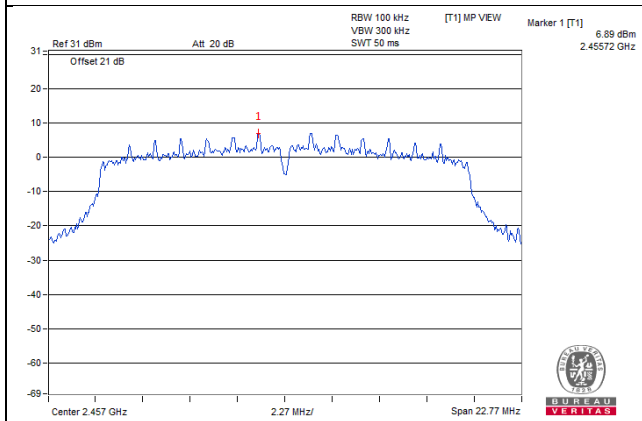

CH 11

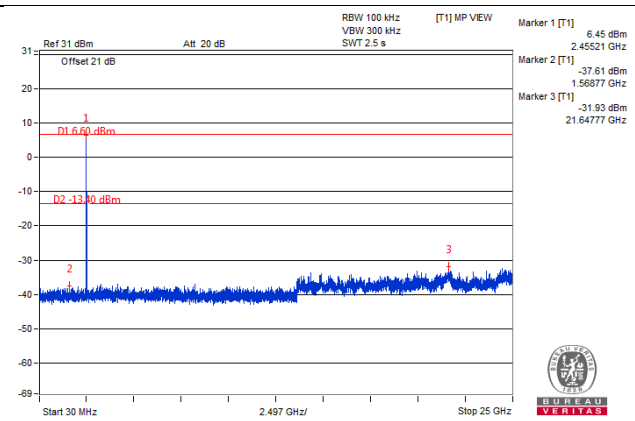
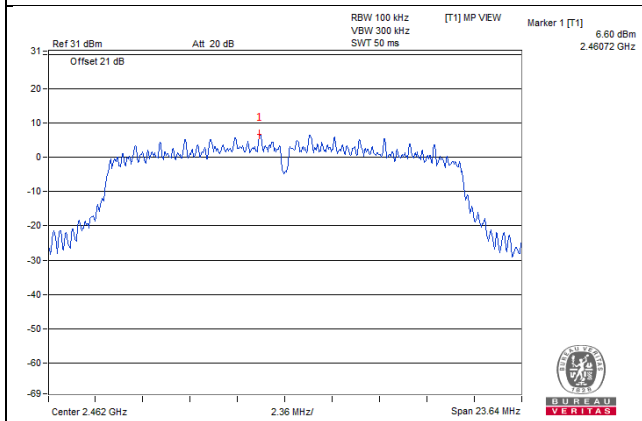



### CH 1 Band edge

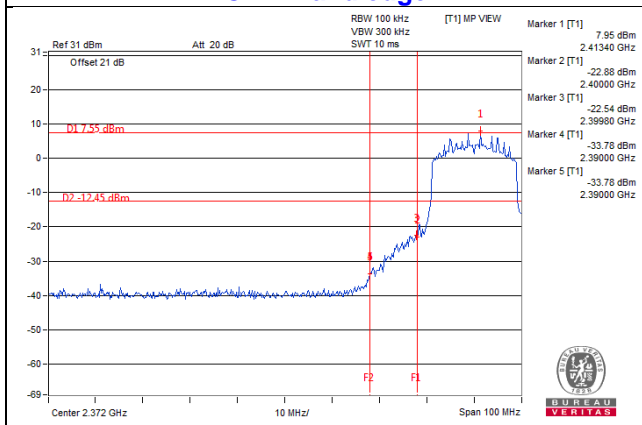

### CH 11 Band edge

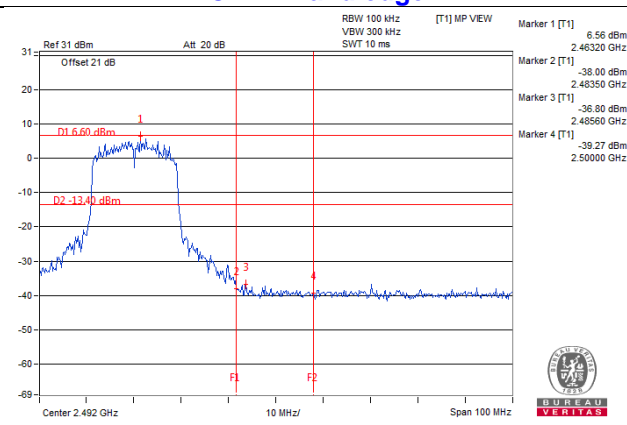

## 5 Pictures of Test Arrangements

Please refer to the attached file (Test Setup Photo).

## Appendix – Information on the Testing Laboratories

We, Bureau Veritas Consumer Products Services (H.K.) Ltd., Taoyuan Branch, were founded in 1988 to provide our best service in EMC, Radio, Telecom and Safety consultation. Our laboratories are FCC recognized accredited test firms and accredited according to ISO/IEC 17025.

If you have any comments, please feel free to contact us at the following:

**Linko EMC/RF Lab**

Tel: 886-2-26052180

Fax: 886-2-26051924

**Hsin Chu EMC/RF/Telecom Lab**

Tel: 886-3-6668565

Fax: 886-3-6668323

**Hwa Ya EMC/RF/Safety Lab**

Tel: 886-3-3183232

Fax: 886-3-3270892

**Email:** [service.adt@tw.bureauveritas.com](mailto:service.adt@tw.bureauveritas.com)

**Web Site:** [www.bureauveritas-adt.com](http://www.bureauveritas-adt.com)

The address and road map of all our labs can be found in our web site also.

--- END ---