

FCC Test Report (WLAN)

Report No.: RF170822E13-1

FCC ID: AK8J20H095

Test Model: J20H095

Received Date: Aug. 22, 2017

Test Date: Sep. 04 to 13, 2017

Issued Date: Oct. 24, 2017

Applicant: Sony Corporation

Address: 1-7-1 Konan Minato-ku Tokyo, 108-0075 Japan

Issued By: Bureau Veritas Consumer Products Services (H.K.) Ltd., Taoyuan Branch
Hsin Chu Laboratory

Lab Address: E-2, No.1, Li Hsin 1st Road, Hsinchu Science Park, Hsinchu City 300,
Taiwan R.O.C.

Test Location : E-2, No.1, Li Hsin 1st Road, Hsinchu Science Park, Hsinchu City 300,
Taiwan R.O.C.



This report is for your exclusive use. Any copying or replication of this report to or for any other person or entity, or use of our name or trademark, is permitted only with our prior written permission. This report sets forth our findings solely with respect to the test samples identified herein. The results set forth in this report are not indicative or representative of the quality or characteristics of the lot from which a test sample was taken or any similar or identical product unless specifically and expressly noted. Our report includes all of the tests requested by you and the results thereof based upon the information that you provided to us. You have 60 days from date of issuance of this report to notify us of any material error or omission caused by our negligence, provided, however, that such notice shall be in writing and shall specifically address the issue you wish to raise. A failure to raise such issue within the prescribed time shall constitute your unqualified acceptance of the completeness of this report, the tests conducted and the correctness of the report contents. Unless specific mention, the uncertainty of measurement has been explicitly taken into account to declare the compliance or non-compliance to the specification. The report must not be used by the client to claim product certification, approval, or endorsement by TAF or any government agencies.

Table of Contents

Release Control Record	4
1 Certificate of Conformity	5
2 Summary of Test Results	6
2.1 Measurement Uncertainty	6
2.2 Modification Record	6
3 General Information	7
3.1 General Description of EUT	7
3.2 Description of Test Modes	9
3.2.1 Test Mode Applicability and Tested Channel Detail	11
3.3 Duty Cycle of Test Signal	13
3.4 Description of Support Units	14
3.4.1 Configuration of System under Test	14
3.5 General Description of Applied Standard	15
4 Test Types and Results	16
4.1 Radiated Emission and Bandedge Measurement	16
4.1.1 Limits of Radiated Emission and Bandedge Measurement	16
4.1.2 Test Instruments	17
4.1.3 Test Procedure	19
4.1.4 Deviation from Test Standard	19
4.1.5 Test Setup	20
4.1.6 EUT Operating Condition	21
4.1.7 Test Results	22
4.2 Conducted Emission Measurement	61
4.2.1 Limits of Conducted Emission Measurement	61
4.2.2 Test Instruments	61
4.2.3 Test Procedure	62
4.2.4 Deviation from Test Standard	62
4.2.5 Test Setup	62
4.2.6 EUT Operating Condition	62
4.2.7 Test Results	63
4.3 Transmit Power Measurement	65
4.3.1 Limits of Transmit Power Measurement	65
4.3.2 Test Setup	65
4.3.3 Test Instruments	65
4.3.4 Test Procedure	66
4.3.5 Deviation from Test Standard	66
4.3.6 EUT Operating Condition	66
4.3.7 Test Result	67
4.4 Occupied Bandwidth Measurement	75
4.4.1 Test Setup	75
4.4.2 Test Instruments	75
4.4.3 Test Procedure	75
4.4.4 Test Results	76
4.5 Peak Power Spectral Density Measurement	83
4.5.1 Limits of Peak Power Spectral Density Measurement	83
4.5.2 Test Setup	83
4.5.3 Test Instruments	83
4.5.4 Test Procedure	83
4.5.5 Deviation from Test Standard	83
4.5.6 EUT Operating Condition	83
4.5.7 Test Results	84
4.6 Frequency Stability Measurement	91
4.6.1 Limits of Frequency Stability Measurement	91

4.6.2	Test Setup.....	91
4.6.3	Test Instruments	91
4.6.4	Test Procedure	91
4.6.5	Deviation from Test Standard	91
4.6.6	EUT Operating Condition	91
4.6.7	Test Results	92
4.7	6dB Bandwidth Measurement	93
4.7.1	Limits of 6dB Bandwidth Measurement.....	93
4.7.2	Test Setup.....	93
4.7.3	Test Instruments	93
4.7.4	Test Procedure	93
4.7.5	Deviation from Test Standard	93
4.7.6	EUT Operating Condition	93
4.7.7	Test Results	94
5	Pictures of Test Arrangements.....	96
	Annex A- Radiated Out of Band Emission (OOBE) Measurement (For U-NII-3 band)	97
	Appendix – Information on the Testing Laboratories	100

Release Control Record

Issue No.	Description	Date Issued
RF170822E13-1	Original release.	Oct. 24, 2017

1 Certificate of Conformity

Product: WLAN/BT Module

Brand: FOXCONN

Test Model: J20H095

Sample Status: ENGINEERING SAMPLE

Applicant: Sony Corporation

Test Date: Sep. 04 to 13, 2017

Standard: 47 CFR FCC Part 15, Subpart E (Section 15.407)
ANSI C63.10: 2013

The above equipment has been tested by **Bureau Veritas Consumer Products Services (H.K.) Ltd., Taoyuan Branch**, and found compliance with the requirement of the above standards. The test record, data evaluation & Equipment Under Test (EUT) configurations represented herein are true and accurate accounts of the measurements of the sample's EMC characteristics under the conditions specified in this report.

Prepared by : Wendy Wu , **Date:** Oct. 24, 2017
Wendy Wu / Specialist

Approved by : May Chen , **Date:** Oct. 24, 2017
May Chen / Manager

2 Summary of Test Results

47 CFR FCC Part 15, Subpart E (Section 15.407)			
FCC Clause	Test Item	Result	Remarks
15.407(b)(6)	AC Power Conducted Emissions	Pass	Meet the requirement of limit. Minimum passing margin is -5.73dB at 16.46484MHz.
15.407(b) (1/2/3/4(i/ii)/6)	Radiated Emissions & Band Edge Measurement*	Pass	Meet the requirement of limit. Minimum passing margin is -0.1dB at 5150.00MHz, 5350.00MHz, 5470.00MHz, 5725.00MHz.
15.407(a)(1/2/3)	Max Average Transmit Power	Pass	Meet the requirement of limit.
---	Occupied Bandwidth Measurement	-	Reference only.
15.407(a)(1/2/3)	Peak Power Spectral Density	Pass	Meet the requirement of limit.
15.407(e)	6dB bandwidth	Pass	Meet the requirement of limit. (U-NII-3 Band only)
15.407(g)	Frequency Stability	Pass	Meet the requirement of limit.
15.203	Antenna Requirement	Pass	No antenna connector is used.

*For U-NII-3 band compliance with rule part 15.407(b)(4)(i), the OOB test plots were recorded in Annex A.

2.1 Measurement Uncertainty

Where relevant, the following measurement uncertainty levels have been estimated for tests performed on the EUT as specified in CISPR 16-4-2:

Measurement	Frequency	Expanded Uncertainty (k=2) (\pm)
Conducted Emissions at mains ports	150kHz ~ 30MHz	1.84 dB
Radiated Emissions up to 1 GHz	30MHz ~ 1GHz	5.32 dB
Radiated Emissions above 1 GHz	1GHz ~ 6GHz	5.14 dB
	6GHz ~ 18GHz	5.04 dB
	18GHz ~ 40GHz	5.25 dB

2.2 Modification Record

There were no modifications required for compliance.

3 General Information

3.1 General Description of EUT

Product	WLAN/BT Module
Brand	FOXCONN
Test Model	J20H095
Status of EUT	ENGINEERING SAMPLE
Power Supply Rating	3.3Vdc from host equipment
Modulation Type	CCK, DQPSK, DBPSK for DSSS 64QAM, 16QAM, QPSK, BPSK for OFDM 256QAM for OFDM in 11ac mode only
Modulation Technology	DSSS, OFDM
Transfer Rate	802.11b: up to 11Mbps 802.11a/g: up to 54Mbps 802.11n: up to 300Mbps 802.11ac: up to 866.7Mbps
Operating Frequency	2.4GHz: 2.412 ~ 2.462GHz 5GHz: 5.18 ~ 5.24GHz, 5.26 ~ 5.32GHz, 5.50 ~ 5.70GHz, 5.745 ~ 5.825GHz
Number of Channel	2.4GHz: 802.11b, 802.11g, 802.11n (HT20): 11 5GHz: 802.11a, 802.11n (HT20), 802.11ac (VHT20): 24 802.11n (HT40), 802.11ac (VHT40): 11 802.11ac (VHT80): 5
Output Power	2.4GHz: 691.119mW 5GHz: 5.18 ~ 5.24GHz: 233.419mW 5.26 ~ 5.32GHz: 186.215mW 5.50 ~ 5.70GHz: 201.905mW 5.745 ~ 5.825GHz: 404.291mW
Antenna Type	Refer to Note
Antenna Connector	Refer to Note
Accessory Device	NA
Data Cable Supplied	NA

Note:

1. There are WLAN, BT technology used for the EUT.
2. Simultaneously transmission condition.

Condition	Technology	
1	WLAN (2.4GHz)	Bluetooth
2	WLAN (5GHz)	Bluetooth

Note: The emission of the simultaneous operation has been evaluated and no non-compliance was found.

3. The EUT has two types, which are identical to each other in all aspects except for the followings:

Model	Type	Different
J20H095	Type 1	with Con1/Con2/Con3 switch connector
	Type 2	without Con1/Con2/Con3 switch connector

According to above types, **Type 1** was selected as representative model for the test and its data was recorded in this report.

4. The antennas provided to the EUT, please refer to the following table:

For WLAN				
Ant No.	Antenna Gain (dBi)	Frequency rang (GHz)	Antenna type	Connector type
1	-0.84	2.4~2.5	Metal PIFA	none
	0.45	5.15~5.25		
	1.14	5.25~5.35		
	0.34	5.47~5.725		
	-0.13	5.725~5.85		
2	3.87	2.4~2.5	Metal PIFA	none
	3.21	5.15~5.25		
	3.67	5.25~5.35		
	3.56	5.47~5.725		
	3.38	5.725~5.85		
For Bluetooth				
Ant No.	Antenna Gain (dBi)	Frequency rang (GHz)	Antenna type	Connector type
1	4.23	2.4~2.4835	Metal PIFA	none

5. The EUT incorporates a MIMO function.

2.4GHz Band			
MODULATION MODE	DATA RATE (MCS)	TX & RX CONFIGURATION	
802.11b	1 ~ 11Mbps	2TX	2RX
802.11g	6 ~ 54Mbps	2TX	2RX
802.11n (HT20)	MCS 0~7	2TX	2RX
	MCS 8~15	2TX	2RX
5GHz Band			
MODULATION MODE	DATA RATE (MCS)	TX & RX CONFIGURATION	
802.11a	6 ~ 54Mbps	2TX	2RX
802.11n (HT20)	MCS 0~7	2TX	2RX
	MCS 8~15	2TX	2RX
802.11n (HT40)	MCS 0~7	2TX	2RX
	MCS 8~15	2TX	2RX
802.11ac (VHT20)	MCS0~8 Nss=1	2TX	2RX
	MCS0~8 Nss=2	2TX	2RX
802.11ac (VHT40)	MCS0~9 Nss=1	2TX	2RX
	MCS0~9 Nss=2	2TX	2RX
802.11ac (VHT80)	MCS0~9 Nss=1	2TX	2RX
	MCS0~9 Nss=2	2TX	2RX

Note: The modulation and bandwidth are similar for 802.11n mode for 20MHz (40MHz) and 802.11ac mode for 20MHz (40MHz), therefore investigated worst case to representative mode in test report. (Final test mode refer section 3.2.1)

6. The above EUT information is declared by manufacturer and for more detailed features description, please refer to the manufacturer's specifications or user's manual.

3.2 Description of Test Modes

FOR 5180 ~ 5240MHz

4 channels are provided for 802.11a, 802.11n (HT20), 802.11ac (VHT20):

Channel	Frequency	Channel	Frequency
36	5180 MHz	44	5220 MHz
40	5200 MHz	48	5240 MHz

2 channels are provided for 802.11n (HT40), 802.11ac (VHT40):

Channel	Frequency	Channel	Frequency
38	5190 MHz	46	5230 MHz

1 channel is provided for 802.11ac (VHT80):

Channel	Frequency
42	5210 MHz

FOR 5260 ~ 5320MHz

4 channels are provided for 802.11a, 802.11n (HT20), 802.11ac (VHT20):

Channel	Frequency	Channel	Frequency
52	5260 MHz	60	5300 MHz
56	5280 MHz	64	5320 MHz

2 channels are provided for 802.11n (HT40), 802.11ac (VHT40):

Channel	Frequency	Channel	Frequency
54	5270 MHz	62	5310 MHz

1 channel is provided for 802.11ac (VHT80):

Channel	Frequency
58	5290 MHz

FOR 5500 ~ 5700MHz

11 channels are provided for 802.11a, 802.11n (HT20), 802.11ac (VHT20):

Channel	Frequency	Channel	Frequency
100	5500 MHz	124	5620 MHz
104	5520 MHz	128	5640 MHz
108	5540 MHz	132	5660 MHz
112	5560 MHz	136	5680 MHz
116	5580 MHz	140	5700 MHz
120	5600 MHz		

5 channels are provided for 802.11n (HT40), 802.11ac (VHT40):

Channel	Frequency	Channel	Frequency
102	5510 MHz	126	5630 MHz
110	5550 MHz	134	5670 MHz
118	5590 MHz		

2 channels are provided for 802.11ac (VHT80):

Channel	Frequency	Channel	Frequency
106	5530 MHz	122	5610 MHz

FOR 5745 ~ 5825MHz:

5 channels are provided for 802.11a, 802.11n (HT20), 802.11ac (VHT20):

Channel	Frequency	Channel	Frequency
149	5745 MHz	161	5805 MHz
153	5765 MHz	165	5825 MHz
157	5785 MHz		

2 channels are provided for 802.11n (HT40), 802.11ac (VHT40):

Channel	Frequency	Channel	Frequency
151	5755 MHz	159	5795 MHz

1 channel is provided for 802.11ac (VHT80):

Channel	Frequency
155	5775 MHz

3.2.1 Test Mode Applicability and Tested Channel Detail

EUT Configure Mode	Applicable To				Description
	RE \geq 1G	RE<1G	PLC	APCM	
-	√	√	√	√	-

Where **RE \geq 1G**: Radiated Emission above 1GHz **RE<1G**: Radiated Emission below 1GHz
PLC: Power Line Conducted Emission **APCM**: Antenna Port Conducted Measurement

NOTE: The EUT had been pre-tested on the positioned of each 3 axis. The worst case was found when positioned on **Y-plane (below 1GHz) & Z-plane (above 1GHz)**

Radiated Emission Test (Above 1GHz):

- Pre-Scan has been conducted to determine the worst-case mode from all possible combinations between available modulations, data rates and antenna ports (if EUT with antenna diversity architecture).
- Following channel(s) was (were) selected for the final test as listed below.

Mode	FREQ. Band (MHz)	Available Channel	Tested Channel	Modulation Technology	Modulation Type	Data Rate (Mbps)
802.11a	5180-5240	36 to 48	36, 40, 48	OFDM	BPSK	6
802.11ac (VHT20)		36 to 48	36, 40, 48	OFDM	BPSK	6.5
802.11ac (VHT40)		38 to 46	38, 46	OFDM	BPSK	13.5
802.11ac (VHT80)		42	42	OFDM	BPSK	29.3
802.11a	5260-5320	52 to 64	52, 60, 64	OFDM	BPSK	6
802.11ac (VHT20)		52 to 64	52, 60, 64	OFDM	BPSK	6.5
802.11ac (VHT40)		54 to 62	54, 62	OFDM	BPSK	13.5
802.11ac (VHT80)		58	58	OFDM	BPSK	29.3
802.11a	5500-5700	100 to 140	100, 116, 140	OFDM	BPSK	6
802.11ac (VHT20)		100 to 140	100, 116, 140	OFDM	BPSK	6.5
802.11ac (VHT40)		102 to 134	102, 110, 134	OFDM	BPSK	13.5
802.11ac (VHT80)		106, 122	106, 122	OFDM	BPSK	29.3
802.11a	5745-5825	149 to 165	149, 157, 165	OFDM	BPSK	6
802.11ac (VHT20)		149 to 165	149, 157, 165	OFDM	BPSK	6.5
802.11ac (VHT40)		151 to 159	151, 159	OFDM	BPSK	13.5
802.11ac (VHT80)		155	155	OFDM	BPSK	29.3

Radiated Emission Test (Below 1GHz):

- Pre-Scan has been conducted to determine the worst-case mode from all possible combinations between available modulations, data rates and antenna ports (if EUT with antenna diversity architecture).
- Following channel(s) was (were) selected for the final test as listed below.

Mode	FREQ. Band (MHz)	Available Channel	Tested Channel	Modulation Technology	Modulation Type	Data Rate (Mbps)
802.11ac (VHT20)	5180-5240 5260-5320 5500-5700 5745-5825	149 to 165	157	OFDM	BPSK	6

Power Line Conducted Emission Test:

- Pre-Scan has been conducted to determine the worst-case mode from all possible combinations between available modulations, data rates and antenna ports (if EUT with antenna diversity architecture).
- Following channel(s) was (were) selected for the final test as listed below.

Mode	FREQ. Band (MHz)	Available Channel	Tested Channel	Modulation Technology	Modulation Type	Data Rate (Mbps)
802.11ac (VHT20)	5180-5240 5260-5320 5500-5700 5745-5825	149 to 165	157	OFDM	BPSK	6

Antenna Port Conducted Measurement:

- This item includes all test value of each mode, but only includes spectrum plot of worst value of each mode.
- Pre-Scan has been conducted to determine the worst-case mode from all possible combinations between available modulations, data rates and antenna ports (if EUT with antenna diversity architecture).
- Following channel(s) was (were) selected for the final test as listed below.

Mode	FREQ. Band (MHz)	Available Channel	Tested Channel	Modulation Technology	Modulation Type	Data Rate (Mbps)
802.11a	5180-5240	36 to 48	36, 40, 48	OFDM	BPSK	6
802.11ac (VHT20)		36 to 48	36, 40, 48	OFDM	BPSK	6.5
802.11ac (VHT40)		38 to 46	38, 46	OFDM	BPSK	13.5
802.11ac (VHT80)		42	42	OFDM	BPSK	29.3
802.11a	5260-5320	52 to 64	52, 60, 64	OFDM	BPSK	6
802.11ac (VHT20)		52 to 64	52, 60, 64	OFDM	BPSK	6.5
802.11ac (VHT40)		54 to 62	54, 62	OFDM	BPSK	13.5
802.11ac (VHT80)		58	58	OFDM	BPSK	29.3
802.11a	5500-5700	100 to 140	100, 116, 140	OFDM	BPSK	6
802.11ac (VHT20)		100 to 140	100, 116, 140	OFDM	BPSK	6.5
802.11ac (VHT40)		102 to 134	102, 110, 134	OFDM	BPSK	13.5
802.11ac (VHT80)		106, 122	106, 122	OFDM	BPSK	29.3
802.11a	5745-5825	149 to 165	149, 157, 165	OFDM	BPSK	6
802.11ac (VHT20)		149 to 165	149, 157, 165	OFDM	BPSK	6.5
802.11ac (VHT40)		151 to 159	151, 159	OFDM	BPSK	13.5
802.11ac (VHT80)		155	155	OFDM	BPSK	29.3

Test Condition:

Applicable To	ENVIRONMENTAL CONDITIONS	INPUT POWER (System)	TESTED BY
RE \geq 1G	23deg. C, 63%RH	120Vac, 60Hz	Weiwei Lo
RE $<$ 1G	25deg. C, 70%RH	120Vac, 60Hz	Weiwei Lo
PLC	25deg. C, 75%RH	120Vac, 60Hz	Andy Ho
APCM	25deg. C, 60%RH	120Vac, 60Hz	Weiwei Lo

3.3 Duty Cycle of Test Signal

Duty cycle of test signal is < 98 %, duty factor shall be considered.

802.11a: Duty cycle = 1.391 ms/1.428 ms = 0.974, Duty factor = $10 * \log(1/0.974) = 0.11$

802.11ac (VHT20): Duty cycle = 1.311 ms/1.365 ms = 0.96, Duty factor = $10 * \log(1/0.96) = 0.18$

802.11ac (VHT40): Duty cycle = 0.651 ms/0.687 ms = 0.948, Duty factor = $10 * \log(1/0.948) = 0.23$

802.11ac (VHT80): Duty cycle = 0.323 ms/0.359 ms = 0.90, Duty factor = $10 * \log(1/0.90) = 0.46$

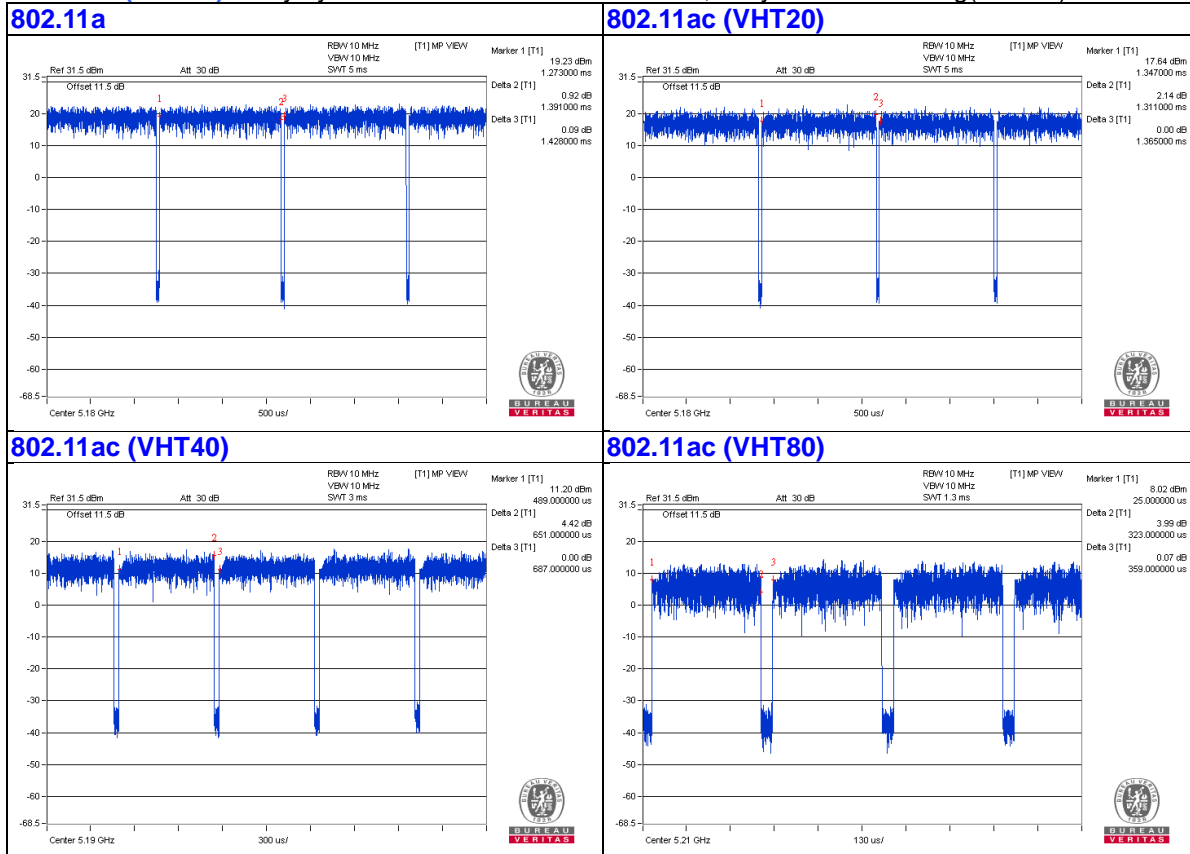

3.4 Description of Support Units

The EUT has been tested as an independent unit together with other necessary accessories or support units. The following support units or accessories were used to form a representative test configuration during the tests.

ID	Product	Brand	Model No.	Serial No.	FCC ID	Remarks
A.	Laptop	DELL	E6420	482T3R1	FCC DoC	Provided by Lab
B.	Test Tool	HON HAI	NA	NA	NA	Supplied by clien (for RF Setup)

Note:

1. All power cords of the above support units are non-shielded (1.8m).

ID	Descriptions	Qty.	Length (m)	Shielding (Yes/No)	Cores (Qty.)	Remarks
1.	USB Cable	1	1.8	Yes	0	Provided by Lab
2.	Console Cable	1	0.05	No	0	Supplied by client(for RF Setup)

3.4.1 Configuration of System under Test

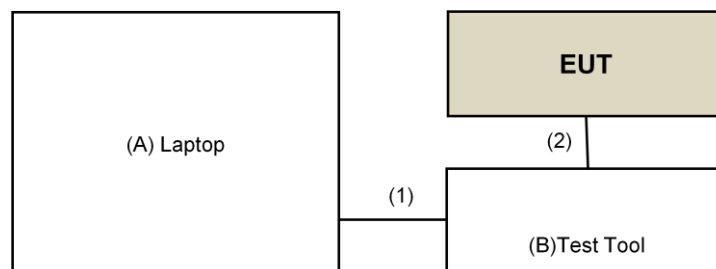

3.5 General Description of Applied Standard

The EUT is a RF Product. According to the specifications of the manufacturer, it must comply with the requirements of the following standards:

FCC Part 15, Subpart E (15.407)
KDB 789033 D02 General UNII Test Procedure New Rules v01r04
KDB 662911 D01 Multiple Transmitter Output v02r01
ANSI C63.10-2013

All test items have been performed and recorded as per the above standards.

NOTE: The EUT has been verified to comply with the requirements of FCC Part 15, Subpart B, Class B (DoC). The test report has been issued separately.

4 Test Types and Results

4.1 Radiated Emission and Bandedge Measurement

4.1.1 Limits of Radiated Emission and Bandedge Measurement

Radiated emissions which fall in the restricted bands must comply with the radiated emission limits specified as below table.

Frequencies (MHz)	Field Strength (microvolts/meter)	Measurement Distance (meters)
0.009 ~ 0.490	2400/F(kHz)	300
0.490 ~ 1.705	24000/F(kHz)	30
1.705 ~ 30.0	30	30
30 ~ 88	100	3
88 ~ 216	150	3
216 ~ 960	200	3
Above 960	500	3

NOTE:

1. The lower limit shall apply at the transition frequencies.
2. Emission level (dBuV/m) = 20 log Emission level (uV/m).
3. For frequencies above 1000MHz, the field strength limits are based on average detector, however, the peak field strength of any emission shall not exceed the maximum permitted average limits, specified above by more than 20dB under any condition of modulation.

Limits of unwanted emission out of the restricted bands

Applicable To		Limit	
789033 D02 General UNII Test Procedure New Rules v01r04		Field Strength at 3m	
		PK:74 (dBuV/m)	AV:54 (dBuV/m)
Frequency Band	Applicable To	EIRP Limit	Equivalent Field Strength at 3m
5150~5250 MHz	15.407(b)(1)	PK:-27 (dBm/MHz)	PK:68.2(dBuV/m)
5250~5350 MHz	15.407(b)(2)		
5470~5725 MHz	15.407(b)(3)		
5725~5850 MHz	<input checked="" type="checkbox"/> 15.407(b)(4)(i)	PK:-27 (dBm/MHz) ^{*1} PK:10 (dBm/MHz) ^{*2} PK:15.6 (dBm/MHz) ^{*3} PK:27 (dBm/MHz) ^{*4}	PK: 68.2(dBuV/m) ^{*1} PK:105.2 (dBuV/m) ^{*2} PK: 110.8(dBuV/m) ^{*3} PK:122.2 (dBuV/m) ^{*4}
	<input type="checkbox"/> 15.407(b)(4)(ii)	Emission limits in section 15.247(d)	
^{*1} beyond 75 MHz or more above of the band edge.		^{*2} below the band edge increasing linearly to 10 dBm/MHz at 25 MHz above.	
^{*3} below the band edge increasing linearly to a level of 15.6 dBm/MHz at 5 MHz above.		^{*4} from 5 MHz above or below the band edge increasing linearly to a level of 27 dBm/MHz at the band edge.	

Note:

The following formula is used to convert the equipment isotropic radiated power (eirp) to field strength:

$$E = \frac{1000000\sqrt{30P}}{3} \mu\text{V/m, where } P \text{ is the eirp (Watts).}$$

4.1.2 Test Instruments

DESCRIPTION & MANUFACTURER	MODEL NO.	SERIAL NO.	CALIBRATED DATE	CALIBRATED UNTIL
Test Receiver Agilent	N9038A	MY50010156	July 12, 2017	July 11, 2018
Pre-Amplifier ^(*) EMCI	EMC001340	980142	Jan. 20, 2016	Jan. 19, 2018
Loop Antenna ^(*) Electro-Metrics	EM-6879	264	Dec. 16, 2016	Dec. 15, 2018
RF Cable	NA	LOOPCAB-001 LOOPCAB-002	Jan. 17, 2017	Jan. 16, 2018
Pre-Amplifier Mini-Circuits	ZFL-1000VH2B	AMP-ZFL-05	May 06, 2017	May 05, 2018
Trilog Broadband Antenna SCHWARZBECK	VULB 9168	9168-361	Dec. 29, 2016	Dec. 28, 2017
RF Cable	8D	966-3-1 966-3-2 966-3-3	Apr. 01, 2017	Mar. 31, 2018
Fixed attenuator Mini-Circuits	UNAT-5+	PAD-3m-3-01	Oct. 05, 2016	Oct. 04, 2017
Horn_Antenna SCHWARZBECK	BBHA9120-D	9120D-406	Dec. 28, 2016	Dec. 27, 2017
Pre-Amplifier EMCI	EMC12630SE	980384	Feb. 02, 2017	Feb. 01, 2018
RF Cable	EMC104-SM-SM-1200 EMC104-SM-SM-2000 EMC104-SM-SM-5000	160922 150317 150322	Feb. 02, 2017 Mar. 29, 2017 Mar. 29, 2017	Feb. 01, 2018 Mar. 28, 2018 Mar. 28, 2018
Spectrum Analyzer Keysight	N9030A	MY54490679	July 25, 2017	July 24, 2018
Pre-Amplifier EMCI	EMC184045SE	980386	Feb. 02, 2017	Feb. 01, 2018
Horn_Antenna SCHWARZBECK	BBHA 9170	BBHA9170608	Dec. 15, 2016	Dec. 14, 2017
RF Cable	SUCOFLEX 102	36432/2 36433/2	Jan. 15, 2017	Jan. 14, 2018
Software	ADT_Radiated_V8.7.08	NA	NA	NA
Antenna Tower & Turn Table Max-Full	MF-7802	MF780208406	NA	NA
Boresight Antenna Fixture	FBA-01	FBA-SIP01	NA	NA
Spectrum Analyzer R&S	FSv40	100964	July 1, 2017	June 30, 2018
Power meter Anritsu	ML2495A	1014008	May 11, 2017	May 10, 2018
Power sensor Anritsu	MA2411B	0917122	May 11, 2017	May 10, 2018
Temperature & Humidity Chamber Giant Force	GTH-150-40-SP-AR	MAA0812-008	Jan. 11, 2017	Jan. 10, 2018
DC Power Supply Topward	6603D	795558	NA	NA
Digital Multimeter FLUKE	87III	73680266	Nov. 10, 2016	Nov. 09, 2017

Note:

1. The calibration interval of the above test instruments is 12 months and the calibrations are traceable to NML/ROC and NIST/USA.
2. *The calibration interval of the above test instruments is 24 months and the calibrations are traceable to NML/ROC and NIST/USA.
3. The test was performed in 966 Chamber No. 3.
4. Loop antenna was used for all emissions below 30 MHz.
5. The CANADA Site Registration No. is 20331-1
6. Tested Date: Sep. 04 to 12, 2017

4.1.3 Test Procedure

For Radiated emission below 30MHz

- a. The EUT was placed on the top of a rotating table 0.8 meters above the ground at a 3 meter chamber room. The table was rotated 360 degrees to determine the position of the highest radiation.
- b. The EUT was set 3 meters away from the interference-receiving antenna, which was mounted on the top of a variable-height antenna tower.
- c. Both X and Y axes of the antenna are set to make the measurement.
- d. For each suspected emission, the EUT was arranged to its worst case and the rotatable table was turned from 0 degrees to 360 degrees to find the maximum reading.
- e. The test-receiver system was set to Quasi-Peak Detect Function and Specified Bandwidth with Maximum Hold Mode.

NOTE:

1. The resolution bandwidth and video bandwidth of test receiver/spectrum analyzer is 9kHz at frequency below 30MHz.

For Radiated emission above 30MHz

- a. The EUT was placed on the top of a rotating table 0.8 meters (for 30MHz ~ 1GHz) / 1.5 meters (for above 1GHz) above the ground at 3 meter chamber room for test. The table was rotated 360 degrees to determine the position of the highest radiation.
- b. The EUT was set 3 meters away from the interference-receiving antenna, which was mounted on the top of a variable-height antenna tower.
- c. The height of antenna is varied from one meter to four meters above the ground to determine the maximum value of the field strength. Both horizontal and vertical polarizations of the antenna are set to make the measurement.
- d. For each suspected emission, the EUT was arranged to its worst case and then the antenna was tuned to heights from 1 meter to 4 meters and the rotatable table was turned from 0 degrees to 360 degrees to find the maximum reading.
- e. The test-receiver system was set to quasi-peak detect function and specified bandwidth with maximum hold mode when the test frequency is below 1 GHz.
- f. The test-receiver system was set to peak and average detect function and specified bandwidth with maximum hold mode when the test frequency is above 1 GHz. If the peak reading value also meets average limit, measurement with the average detector is unnecessary.

Note:

1. The resolution bandwidth and video bandwidth of test receiver/spectrum analyzer is 120kHz for Quasi-peak detection (QP) at frequency below 1GHz.
2. The resolution bandwidth of test receiver/spectrum analyzer is 1 MHz and the video bandwidth is 3 MHz for Peak detection (PK) at frequency above 1GHz.
3. The resolution bandwidth of test receiver/spectrum analyzer is 1MHz and the video bandwidth is $\geq 1/T$ (Duty cycle < 98%) or 10Hz (Duty cycle $\geq 98\%$) for Average detection (AV) at frequency above 1GHz.
4. All modes of operation were investigated and the worst-case emissions are reported.

4.1.4 Deviation from Test Standard

No deviation.

4.1.5 Test Setup

For Radiated emission below 30MHz

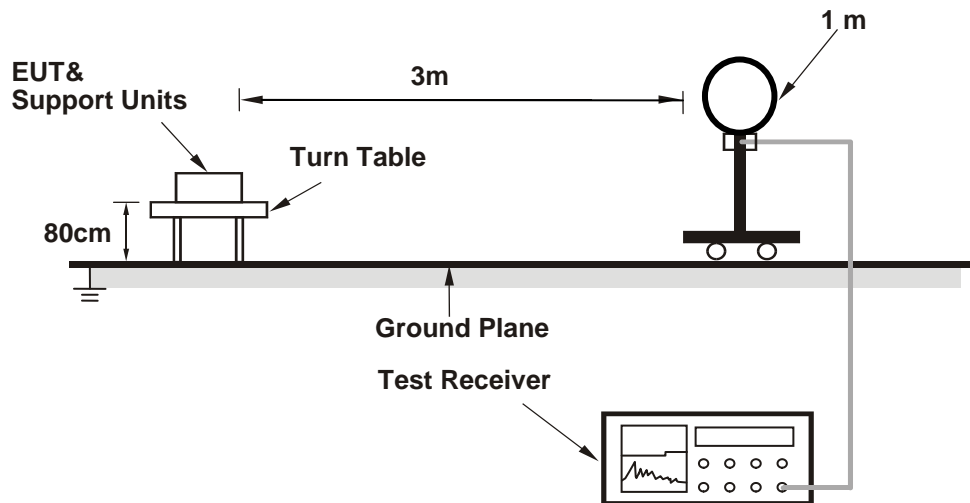

For Radiated emission 30MHz to 1GHz

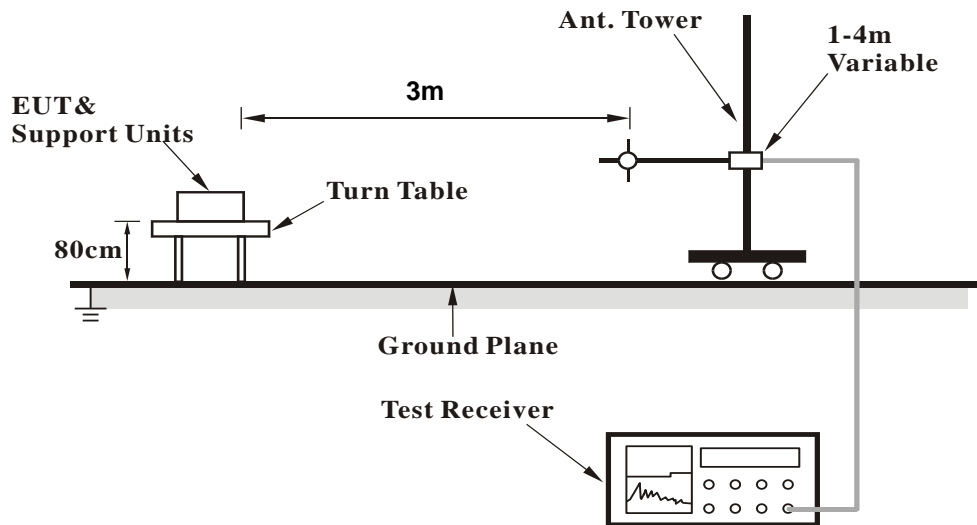

For Radiated emission above 1GHz

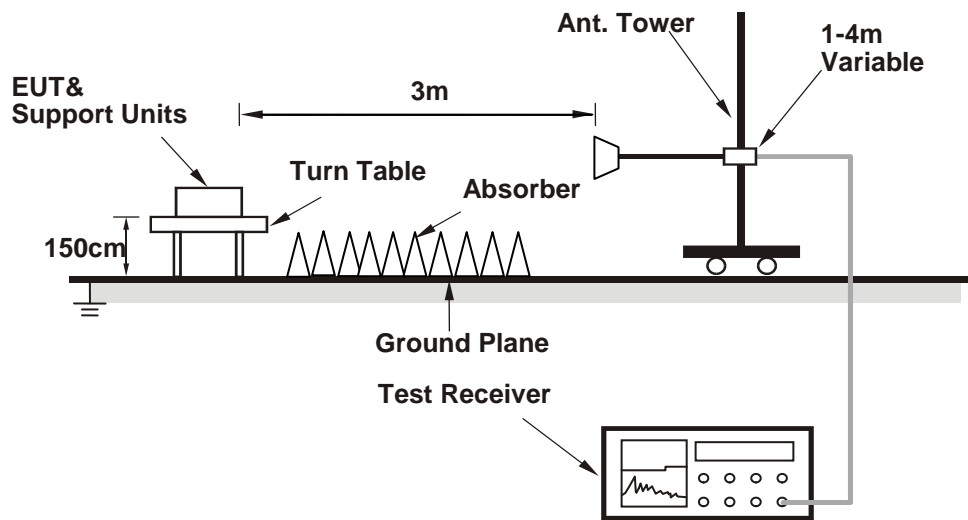

For the actual test configuration, please refer to the attached file (Test Setup Photo).

4.1.6 EUT Operating Condition

- a. Connected the EUT with the Laptop.
- b. Controlling software (MT7668 QA 0.0.1.85) has been activated to set the EUT on specific status.

4.1.7 Test Results

Above 1GHz Data:

802.11a

CHANNEL	TX Channel 36	DETECTOR FUNCTION	Peak (PK)
FREQUENCY RANGE	1GHz ~ 40GHz		Average (AV)

ANTENNA POLARITY & TEST DISTANCE: HORIZONTAL AT 3 M								
NO.	FREQ. (MHz)	EMISSION LEVEL (dBuV/m)	LIMIT (dBuV/m)	MARGIN (dB)	ANTENNA HEIGHT (m)	TABLE ANGLE (Degree)	RAW VALUE (dBuV)	CORRECTION FACTOR (dB/m)
1	5150.00	68.5 PK	74.0	-5.5	2.23 H	112	64.8	3.7
2	5150.00	53.9 AV	54.0	-0.1	2.23 H	112	50.2	3.7
3	*5180.00	116.7 PK			2.23 H	112	113.0	3.7
4	*5180.00	106.3 AV			2.23 H	112	102.6	3.7
5	#10360.00	59.9 PK	74.0	-14.1	2.00 H	169	46.9	13.0
6	#10360.00	46.7 AV	54.0	-7.3	2.00 H	169	33.7	13.0
7	15540.00	43.9 PK	74.0	-30.1	1.57 H	302	30.8	13.1
8	15540.00	32.5 AV	54.0	-21.5	1.57 H	302	19.4	13.1
ANTENNA POLARITY & TEST DISTANCE: VERTICAL AT 3 M								
NO.	FREQ. (MHz)	EMISSION LEVEL (dBuV/m)	LIMIT (dBuV/m)	MARGIN (dB)	ANTENNA HEIGHT (m)	TABLE ANGLE (Degree)	RAW VALUE (dBuV)	CORRECTION FACTOR (dB/m)
1	5150.00	61.8 PK	74.0	-12.2	3.30 V	195	58.1	3.7
2	5150.00	47.8 AV	54.0	-6.2	3.30 V	195	44.1	3.7
3	*5180.00	112.4 PK			3.30 V	195	108.7	3.7
4	*5180.00	102.5 AV			3.30 V	195	98.8	3.7
5	#10360.00	56.7 PK	74.0	-17.3	1.02 V	26	43.7	13.0
6	#10360.00	42.8 AV	54.0	-11.2	1.02 V	26	29.8	13.0
7	15540.00	45.1 PK	74.0	-28.9	1.68 V	214	32.0	13.1
8	15540.00	32.4 AV	54.0	-21.6	1.68 V	214	19.3	13.1

REMARKS:

1. Emission Level(dBuV/m) = Raw Value(dBuV) + Correction Factor(dB/m)
2. Correction Factor(dB/m) = Antenna Factor(dB/m) + Cable Factor(dB) – Pre-Amplifier Factor(dB)
3. The other emission levels were very low against the limit.
4. Margin value = Emission Level – Limit value
5. " * ": Fundamental frequency.
6. " # ": The radiated frequency is out of the restricted band.

CHANNEL	TX Channel 40	DETECTOR FUNCTION	Peak (PK)
FREQUENCY RANGE	1GHz ~ 40GHz		Average (AV)

ANTENNA POLARITY & TEST DISTANCE: HORIZONTAL AT 3 M

NO.	FREQ. (MHz)	EMISSION LEVEL (dBuV/m)	LIMIT (dBuV/m)	MARGIN (dB)	ANTENNA HEIGHT (m)	TABLE ANGLE (Degree)	RAW VALUE (dBuV)	CORRECTION FACTOR (dB/m)
1	5150.00	67.2 PK	74.0	-6.8	2.64 H	112	63.5	3.7
2	5150.00	53.6 AV	54.0	-0.4	2.64 H	112	49.9	3.7
3	*5200.00	121.0 PK			2.64 H	112	117.3	3.7
4	*5200.00	110.3 AV			2.64 H	112	106.6	3.7
5	5350.00	51.5 PK	74.0	-22.5	2.64 H	112	47.4	4.1
6	5350.00	39.6 AV	54.0	-14.4	2.64 H	112	35.5	4.1
7	#10400.00	60.8 PK	74.0	-13.2	2.02 H	173	47.8	13.0
8	#10400.00	47.4 AV	54.0	-6.6	2.02 H	173	34.4	13.0
9	15600.00	44.5 PK	74.0	-29.5	1.55 H	304	31.2	13.3
10	15600.00	33.1 AV	54.0	-20.9	1.55 H	304	19.8	13.3

ANTENNA POLARITY & TEST DISTANCE: VERTICAL AT 3 M

NO.	FREQ. (MHz)	EMISSION LEVEL (dBuV/m)	LIMIT (dBuV/m)	MARGIN (dB)	ANTENNA HEIGHT (m)	TABLE ANGLE (Degree)	RAW VALUE (dBuV)	CORRECTION FACTOR (dB/m)
1	5150.00	62.1 PK	74.0	-11.9	3.25 V	183	58.4	3.7
2	5150.00	47.2 AV	54.0	-6.8	3.25 V	183	43.5	3.7
3	*5200.00	116.8 PK			3.25 V	183	113.1	3.7
4	*5200.00	106.5 AV			3.25 V	183	102.8	3.7
5	5350.00	49.1 PK	74.0	-24.9	3.25 V	183	45.0	4.1
6	5350.00	38.0 AV	54.0	-16.0	3.25 V	183	33.9	4.1
7	#10400.00	57.5 PK	74.0	-16.5	1.00 V	14	44.5	13.0
8	#10400.00	43.4 AV	54.0	-10.6	1.00 V	14	30.4	13.0
9	15600.00	45.5 PK	74.0	-28.5	1.73 V	223	32.2	13.3
10	15600.00	32.9 AV	54.0	-21.1	1.73 V	223	19.6	13.3

REMARKS:

1. Emission Level(dBuV/m) = Raw Value(dBuV) + Correction Factor(dB/m)
2. Correction Factor(dB/m) = Antenna Factor(dB/m) + Cable Factor(dB) – Pre-Amplifier Factor(dB)
3. The other emission levels were very low against the limit.
4. Margin value = Emission Level – Limit value
5. " * ": Fundamental frequency.
6. " # ": The radiated frequency is out of the restricted band.

CHANNEL	TX Channel 48	DETECTOR FUNCTION	Peak (PK)
FREQUENCY RANGE	1GHz ~ 40GHz		Average (AV)

ANTENNA POLARITY & TEST DISTANCE: HORIZONTAL AT 3 M

NO.	FREQ. (MHz)	EMISSION LEVEL (dBuV/m)	LIMIT (dBuV/m)	MARGIN (dB)	ANTENNA HEIGHT (m)	TABLE ANGLE (Degree)	RAW VALUE (dBuV)	CORRECTION FACTOR (dB/m)
1	*5240.00	119.2 PK			2.45 H	118	115.4	3.8
2	*5240.00	108.5 AV			2.45 H	118	104.7	3.8
3	5350.00	53.5 PK	74.0	-20.5	2.45 H	118	49.4	4.1
4	5350.00	42.0 AV	54.0	-12.0	2.45 H	118	37.9	4.1
5	#10480.00	60.6 PK	74.0	-13.4	1.98 H	161	47.4	13.2
6	#10480.00	47.2 AV	54.0	-6.8	1.98 H	161	34.0	13.2
7	15720.00	44.3 PK	74.0	-29.7	1.58 H	313	30.7	13.6
8	15720.00	32.9 AV	54.0	-21.1	1.58 H	313	19.3	13.6

ANTENNA POLARITY & TEST DISTANCE: VERTICAL AT 3 M

NO.	FREQ. (MHz)	EMISSION LEVEL (dBuV/m)	LIMIT (dBuV/m)	MARGIN (dB)	ANTENNA HEIGHT (m)	TABLE ANGLE (Degree)	RAW VALUE (dBuV)	CORRECTION FACTOR (dB/m)
1	*5240.00	114.9 PK			3.27 V	192	111.1	3.8
2	*5240.00	104.8 AV			3.27 V	192	101.0	3.8
3	5350.00	51.9 PK	74.0	-22.1	3.27 V	192	47.8	4.1
4	5350.00	39.1 AV	54.0	-14.9	3.27 V	192	35.0	4.1
5	#10480.00	57.3 PK	74.0	-16.7	1.00 V	28	44.1	13.2
6	#10480.00	43.2 AV	54.0	-10.8	1.00 V	28	30.0	13.2
7	15720.00	45.3 PK	74.0	-28.7	1.74 V	223	31.7	13.6
8	15720.00	32.7 AV	54.0	-21.3	1.74 V	223	19.1	13.6

REMARKS:

1. Emission Level(dBuV/m) = Raw Value(dBuV) + Correction Factor(dB/m)
2. Correction Factor(dB/m) = Antenna Factor(dB/m) + Cable Factor(dB) – Pre-Amplifier Factor(dB)
3. The other emission levels were very low against the limit.
4. Margin value = Emission Level – Limit value
5. " * ": Fundamental frequency.
6. " # ": The radiated frequency is out of the restricted band.

CHANNEL	TX Channel 52	DETECTOR FUNCTION	Peak (PK)
FREQUENCY RANGE	1GHz ~ 40GHz		Average (AV)

ANTENNA POLARITY & TEST DISTANCE: HORIZONTAL AT 3 M

NO.	FREQ. (MHz)	EMISSION LEVEL (dBuV/m)	LIMIT (dBuV/m)	MARGIN (dB)	ANTENNA HEIGHT (m)	TABLE ANGLE (Degree)	RAW VALUE (dBuV)	CORRECTION FACTOR (dB/m)
1	5150.00	55.4 PK	74.0	-18.6	2.44 H	117	51.7	3.7
2	5150.00	43.3 AV	54.0	-10.7	2.44 H	117	39.6	3.7
3	*5260.00	119.3 PK			2.44 H	117	115.3	4.0
4	*5260.00	108.8 AV			2.44 H	117	104.8	4.0
5	#10520.00	61.0 PK	74.0	-13.0	1.97 H	168	47.8	13.2
6	#10520.00	47.4 AV	54.0	-6.6	1.97 H	168	34.2	13.2
7	15780.00	44.6 PK	74.0	-29.4	1.56 H	321	31.0	13.6
8	15780.00	33.1 AV	54.0	-20.9	1.56 H	321	19.5	13.6

ANTENNA POLARITY & TEST DISTANCE: VERTICAL AT 3 M

NO.	FREQ. (MHz)	EMISSION LEVEL (dBuV/m)	LIMIT (dBuV/m)	MARGIN (dB)	ANTENNA HEIGHT (m)	TABLE ANGLE (Degree)	RAW VALUE (dBuV)	CORRECTION FACTOR (dB/m)
1	5150.00	48.7 PK	74.0	-25.3	3.31 V	186	45.0	3.7
2	5150.00	37.2 AV	54.0	-16.8	3.31 V	186	33.5	3.7
3	*5260.00	115.1 PK			3.31 V	186	111.1	4.0
4	*5260.00	105.1 AV			3.31 V	186	101.1	4.0
5	#10520.00	57.2 PK	74.0	-16.8	1.00 V	36	44.0	13.2
6	#10520.00	42.9 AV	54.0	-11.1	1.00 V	36	29.7	13.2
7	15780.00	45.3 PK	74.0	-28.7	1.79 V	239	31.7	13.6
8	15780.00	33.0 AV	54.0	-21.0	1.79 V	239	19.4	13.6

REMARKS:

1. Emission Level(dBuV/m) = Raw Value(dBuV) + Correction Factor(dB/m)
2. Correction Factor(dB/m) = Antenna Factor(dB/m) + Cable Factor(dB) – Pre-Amplifier Factor(dB)
3. The other emission levels were very low against the limit.
4. Margin value = Emission Level – Limit value
5. " * ": Fundamental frequency.
6. " # ": The radiated frequency is out of the restricted band.

CHANNEL	TX Channel 60	DETECTOR FUNCTION	Peak (PK)
FREQUENCY RANGE	1GHz ~ 40GHz		Average (AV)

ANTENNA POLARITY & TEST DISTANCE: HORIZONTAL AT 3 M

NO.	FREQ. (MHz)	EMISSION LEVEL (dBuV/m)	LIMIT (dBuV/m)	MARGIN (dB)	ANTENNA HEIGHT (m)	TABLE ANGLE (Degree)	RAW VALUE (dBuV)	CORRECTION FACTOR (dB/m)
1	5150.00	52.2 PK	74.0	-21.8	2.43 H	116	48.5	3.7
2	5150.00	42.2 AV	54.0	-11.8	2.43 H	116	38.5	3.7
3	*5300.00	118.6 PK			2.43 H	116	114.5	4.1
4	*5300.00	108.3 AV			2.43 H	116	104.2	4.1
5	5350.00	58.7 PK	74.0	-15.3	2.43 H	116	54.6	4.1
6	5350.00	44.6 AV	54.0	-9.4	2.43 H	116	40.5	4.1
7	10600.00	60.8 PK	74.0	-13.2	1.94 H	158	47.3	13.5
8	10600.00	47.7 AV	54.0	-6.3	1.94 H	158	34.2	13.5
9	15900.00	44.3 PK	74.0	-29.7	1.62 H	301	31.4	12.9
10	15900.00	32.8 AV	54.0	-21.2	1.62 H	301	19.9	12.9

ANTENNA POLARITY & TEST DISTANCE: VERTICAL AT 3 M

NO.	FREQ. (MHz)	EMISSION LEVEL (dBuV/m)	LIMIT (dBuV/m)	MARGIN (dB)	ANTENNA HEIGHT (m)	TABLE ANGLE (Degree)	RAW VALUE (dBuV)	CORRECTION FACTOR (dB/m)
1	5150.00	47.2 PK	74.0	-26.8	3.30 V	184	43.5	3.7
2	5150.00	35.9 AV	54.0	-18.1	3.30 V	184	32.2	3.7
3	*5300.00	114.5 PK			3.30 V	184	110.4	4.1
4	*5300.00	104.5 AV			3.30 V	184	100.4	4.1
5	5350.00	56.2 PK	74.0	-17.8	3.30 V	184	52.1	4.1
6	5350.00	43.1 AV	54.0	-10.9	3.30 V	184	39.0	4.1
7	10600.00	57.1 PK	74.0	-16.9	1.00 V	43	43.6	13.5
8	10600.00	42.8 AV	54.0	-11.2	1.00 V	43	29.3	13.5
9	15900.00	45.3 PK	74.0	-28.7	1.74 V	233	32.4	12.9
10	15900.00	32.9 AV	54.0	-21.1	1.74 V	233	20.0	12.9

REMARKS:

1. Emission Level(dBuV/m) = Raw Value(dBuV) + Correction Factor(dB/m)
2. Correction Factor(dB/m) = Antenna Factor(dB/m) + Cable Factor(dB) – Pre-Amplifier Factor(dB)
3. The other emission levels were very low against the limit.
4. Margin value = Emission Level – Limit value
5. " * ": Fundamental frequency.

CHANNEL	TX Channel 64	DETECTOR FUNCTION	Peak (PK)
FREQUENCY RANGE	1GHz ~ 40GHz		Average (AV)

ANTENNA POLARITY & TEST DISTANCE: HORIZONTAL AT 3 M

NO.	FREQ. (MHz)	EMISSION LEVEL (dBuV/m)	LIMIT (dBuV/m)	MARGIN (dB)	ANTENNA HEIGHT (m)	TABLE ANGLE (Degree)	RAW VALUE (dBuV)	CORRECTION FACTOR (dB/m)
1	*5320.00	116.4 PK			2.32 H	115	112.3	4.1
2	*5320.00	106.4 AV			2.32 H	115	102.3	4.1
3	5350.00	67.2 PK	74.0	-6.8	2.32 H	115	63.1	4.1
4	5350.00	53.8 AV	54.0	-0.2	2.32 H	115	49.7	4.1
5	10640.00	60.3 PK	74.0	-13.7	1.99 H	164	46.8	13.5
6	10640.00	46.5 AV	54.0	-7.5	1.99 H	164	33.0	13.5
7	15960.00	44.3 PK	74.0	-29.7	1.65 H	310	31.4	12.9
8	15960.00	32.5 AV	54.0	-21.5	1.65 H	310	19.6	12.9

ANTENNA POLARITY & TEST DISTANCE: VERTICAL AT 3 M

NO.	FREQ. (MHz)	EMISSION LEVEL (dBuV/m)	LIMIT (dBuV/m)	MARGIN (dB)	ANTENNA HEIGHT (m)	TABLE ANGLE (Degree)	RAW VALUE (dBuV)	CORRECTION FACTOR (dB/m)
1	*5320.00	112.1 PK			3.28 V	204	108.0	4.1
2	*5320.00	102.7 AV			3.28 V	204	98.6	4.1
3	5350.00	65.6 PK	74.0	-8.4	3.28 V	204	61.5	4.1
4	5350.00	52.9 AV	54.0	-1.1	3.28 V	204	48.8	4.1
5	10640.00	56.9 PK	74.0	-17.1	1.00 V	27	43.4	13.5
6	10640.00	42.5 AV	54.0	-11.5	1.00 V	27	29.0	13.5
7	15960.00	45.0 PK	74.0	-29.0	1.79 V	217	32.1	12.9
8	15960.00	32.9 AV	54.0	-21.1	1.79 V	217	20.0	12.9

REMARKS:

1. Emission Level(dBuV/m) = Raw Value(dBuV) + Correction Factor(dB/m)
2. Correction Factor(dB/m) = Antenna Factor(dB/m) + Cable Factor(dB) – Pre-Amplifier Factor(dB)
3. The other emission levels were very low against the limit.
4. Margin value = Emission Level – Limit value
5. " * ": Fundamental frequency.

CHANNEL	TX Channel 100	DETECTOR FUNCTION	Peak (PK)
FREQUENCY RANGE	1GHz ~ 40GHz		Average (AV)

ANTENNA POLARITY & TEST DISTANCE: HORIZONTAL AT 3 M

NO.	FREQ. (MHz)	EMISSION LEVEL (dBuV/m)	LIMIT (dBuV/m)	MARGIN (dB)	ANTENNA HEIGHT (m)	TABLE ANGLE (Degree)	RAW VALUE (dBuV)	CORRECTION FACTOR (dB/m)
1	#5470.00	69.2 PK	74.0	-4.8	2.34 H	120	65.0	4.2
2	#5470.00	53.6 AV	54.0	-0.4	2.34 H	120	49.4	4.2
3	*5500.00	116.8 PK			2.34 H	120	112.6	4.2
4	*5500.00	106.5 AV			2.34 H	120	102.3	4.2
5	11000.00	59.7 PK	74.0	-14.3	2.00 H	159	45.6	14.1
6	11000.00	46.3 AV	54.0	-7.7	2.00 H	159	32.2	14.1
7	#16500.00	43.7 PK	74.0	-30.3	1.67 H	326	29.2	14.5
8	#16500.00	32.0 AV	54.0	-22.0	1.67 H	326	17.5	14.5

ANTENNA POLARITY & TEST DISTANCE: VERTICAL AT 3 M

NO.	FREQ. (MHz)	EMISSION LEVEL (dBuV/m)	LIMIT (dBuV/m)	MARGIN (dB)	ANTENNA HEIGHT (m)	TABLE ANGLE (Degree)	RAW VALUE (dBuV)	CORRECTION FACTOR (dB/m)
1	#5470.00	62.5 PK	74.0	-11.5	3.34 V	187	58.3	4.2
2	#5470.00	47.5 AV	54.0	-6.5	3.34 V	187	43.3	4.2
3	*5500.00	112.7 PK			3.34 V	187	108.5	4.2
4	*5500.00	102.6 AV			3.34 V	187	98.4	4.2
5	11000.00	57.0 PK	74.0	-17.0	1.00 V	36	42.9	14.1
6	11000.00	42.6 AV	54.0	-11.4	1.00 V	36	28.5	14.1
7	#16500.00	45.3 PK	74.0	-28.7	1.81 V	232	30.8	14.5
8	#16500.00	32.8 AV	54.0	-21.2	1.81 V	232	18.3	14.5

REMARKS:

1. Emission Level(dBuV/m) = Raw Value(dBuV) + Correction Factor(dB/m)
2. Correction Factor(dB/m) = Antenna Factor(dB/m) + Cable Factor(dB) – Pre-Amplifier Factor(dB)
3. The other emission levels were very low against the limit.
4. Margin value = Emission Level – Limit value
5. " * ": Fundamental frequency.
6. " # ": The radiated frequency is out of the restricted band.

CHANNEL	TX Channel 116	DETECTOR FUNCTION	Peak (PK)
FREQUENCY RANGE	1GHz ~ 40GHz		Average (AV)

ANTENNA POLARITY & TEST DISTANCE: HORIZONTAL AT 3 M

NO.	FREQ. (MHz)	EMISSION LEVEL (dBuV/m)	LIMIT (dBuV/m)	MARGIN (dB)	ANTENNA HEIGHT (m)	TABLE ANGLE (Degree)	RAW VALUE (dBuV)	CORRECTION FACTOR (dB/m)
1	#5470.00	54.9 PK	74.0	-19.1	2.37 H	113	50.7	4.2
2	#5470.00	43.6 AV	54.0	-10.4	2.37 H	113	39.4	4.2
3	*5580.00	119.2 PK			2.37 H	113	115.0	4.2
4	*5580.00	108.9 AV			2.37 H	113	104.7	4.2
5	#5725.00	53.2 PK	74.0	-20.8	2.37 H	113	48.8	4.4
6	#5725.00	39.7 AV	54.0	-14.3	2.37 H	113	35.3	4.4
7	11160.00	60.4 PK	74.0	-13.6	2.03 H	163	46.7	13.7
8	11160.00	46.8 AV	54.0	-7.2	2.03 H	163	33.1	13.7
9	#16740.00	44.4 PK	74.0	-29.6	1.60 H	315	28.7	15.7
10	#16740.00	32.7 AV	54.0	-21.3	1.60 H	315	17.0	15.7

ANTENNA POLARITY & TEST DISTANCE: VERTICAL AT 3 M

NO.	FREQ. (MHz)	EMISSION LEVEL (dBuV/m)	LIMIT (dBuV/m)	MARGIN (dB)	ANTENNA HEIGHT (m)	TABLE ANGLE (Degree)	RAW VALUE (dBuV)	CORRECTION FACTOR (dB/m)
1	#5470.00	49.8 PK	74.0	-24.2	3.29 V	200	45.6	4.2
2	#5470.00	37.2 AV	54.0	-16.8	3.29 V	200	33.0	4.2
3	*5580.00	115.1 PK			3.29 V	200	110.9	4.2
4	*5580.00	105.2 AV			3.29 V	200	101.0	4.2
5	#5725.00	50.8 PK	74.0	-23.2	3.29 V	200	46.4	4.4
6	#5725.00	38.1 AV	54.0	-15.9	3.29 V	200	33.7	4.4
7	11160.00	57.7 PK	74.0	-16.3	1.00 V	32	44.0	13.7
8	11160.00	43.5 AV	54.0	-10.5	1.00 V	32	29.8	13.7
9	#16740.00	45.4 PK	74.0	-28.6	1.78 V	229	29.7	15.7
10	#16740.00	33.1 AV	54.0	-20.9	1.78 V	229	17.4	15.7

REMARKS:

- Emission Level(dBuV/m) = Raw Value(dBuV) + Correction Factor(dB/m)
- Correction Factor(dB/m) = Antenna Factor(dB/m) + Cable Factor(dB) – Pre-Amplifier Factor(dB)
- The other emission levels were very low against the limit.
- Margin value = Emission Level – Limit value
- " * ": Fundamental frequency.
- " # ": The radiated frequency is out of the restricted band.

CHANNEL	TX Channel 140	DETECTOR FUNCTION	Peak (PK)
FREQUENCY RANGE	1GHz ~ 40GHz		Average (AV)

ANTENNA POLARITY & TEST DISTANCE: HORIZONTAL AT 3 M

NO.	FREQ. (MHz)	EMISSION LEVEL (dBuV/m)	LIMIT (dBuV/m)	MARGIN (dB)	ANTENNA HEIGHT (m)	TABLE ANGLE (Degree)	RAW VALUE (dBuV)	CORRECTION FACTOR (dB/m)
1	*5700.00	114.8 PK			2.39 H	114	110.3	4.5
2	*5700.00	104.5 AV			2.39 H	114	100.0	4.5
3	#5725.00	66.9 PK	74.0	-7.1	2.39 H	114	62.5	4.4
4	#5725.00	53.6 AV	54.0	-0.4	2.39 H	114	49.2	4.4
5	11400.00	59.9 PK	74.0	-14.1	2.04 H	162	46.3	13.6
6	11400.00	46.3 AV	54.0	-7.7	2.04 H	162	32.7	13.6
7	#17100.00	43.9 PK	74.0	-30.1	1.64 H	313	26.5	17.4
8	#17100.00	32.2 AV	54.0	-21.8	1.64 H	313	14.8	17.4

ANTENNA POLARITY & TEST DISTANCE: VERTICAL AT 3 M

NO.	FREQ. (MHz)	EMISSION LEVEL (dBuV/m)	LIMIT (dBuV/m)	MARGIN (dB)	ANTENNA HEIGHT (m)	TABLE ANGLE (Degree)	RAW VALUE (dBuV)	CORRECTION FACTOR (dB/m)
1	*5700.00	110.7 PK			3.31 V	205	106.2	4.5
2	*5700.00	100.9 AV			3.31 V	205	96.4	4.5
3	#5725.00	65.3 PK	74.0	-8.7	3.31 V	205	60.9	4.4
4	#5725.00	52.7 AV	54.0	-1.3	3.31 V	205	48.3	4.4
5	11400.00	57.2 PK	74.0	-16.8	1.00 V	36	43.6	13.6
6	11400.00	43.0 AV	54.0	-11.0	1.00 V	36	29.4	13.6
7	#17100.00	44.9 PK	74.0	-29.1	1.79 V	229	27.5	17.4
8	#17100.00	32.6 AV	54.0	-21.4	1.79 V	229	15.2	17.4

REMARKS:

1. Emission Level(dBuV/m) = Raw Value(dBuV) + Correction Factor(dB/m)
2. Correction Factor(dB/m) = Antenna Factor(dB/m) + Cable Factor(dB) – Pre-Amplifier Factor(dB)
3. The other emission levels were very low against the limit.
4. Margin value = Emission Level – Limit value
5. " * ": Fundamental frequency.
6. " # ": The radiated frequency is out of the restricted band.

CHANNEL	TX Channel 149	DETECTOR FUNCTION	Peak (PK)
FREQUENCY RANGE	1GHz ~ 40GHz		Average (AV)

ANTENNA POLARITY & TEST DISTANCE: HORIZONTAL AT 3 M

NO.	FREQ. (MHz)	EMISSION LEVEL (dBuV/m)	LIMIT (dBuV/m)	MARGIN (dB)	ANTENNA HEIGHT (m)	TABLE ANGLE (Degree)	RAW VALUE (dBuV)	CORRECTION FACTOR (dB/m)
1	#5622.82	56.8 PK	68.2	-11.4	2.12 H	295	52.4	4.4
2	*5745.00	118.7 PK			2.34 H	113	114.3	4.4
3	*5745.00	107.9 AV			2.34 H	113	103.5	4.4
4	#5948.76	54.8 PK	68.2	-13.4	2.12 H	295	50.1	4.7
5	11490.00	60.5 PK	74.0	-13.5	2.03 H	172	47.0	13.5
6	11490.00	47.1 AV	54.0	-6.9	2.03 H	172	33.6	13.5
7	#17235.00	45.0 PK	74.0	-29.0	1.58 H	325	27.7	17.3
8	#17235.00	33.1 AV	54.0	-20.9	1.58 H	325	15.8	17.3

ANTENNA POLARITY & TEST DISTANCE: VERTICAL AT 3 M

NO.	FREQ. (MHz)	EMISSION LEVEL (dBuV/m)	LIMIT (dBuV/m)	MARGIN (dB)	ANTENNA HEIGHT (m)	TABLE ANGLE (Degree)	RAW VALUE (dBuV)	CORRECTION FACTOR (dB/m)
1	#5614.68	52.0 PK	68.2	-16.2	2.76 V	260	47.6	4.4
2	*5745.00	113.6 PK			2.76 V	260	109.2	4.4
3	*5745.00	103.3 AV			2.76 V	260	98.9	4.4
4	#6008.24	51.4 PK	68.2	-16.8	2.76 V	260	46.6	4.8
5	11490.00	58.4 PK	74.0	-15.6	1.00 V	38	44.9	13.5
6	11490.00	44.1 AV	54.0	-9.9	1.00 V	38	30.6	13.5
7	#17235.00	46.2 PK	74.0	-27.8	1.75 V	244	28.9	17.3
8	#17235.00	33.9 AV	54.0	-20.1	1.75 V	244	16.6	17.3

REMARKS:

1. Emission Level(dBuV/m) = Raw Value(dBuV) + Correction Factor(dB/m)
2. Correction Factor(dB/m) = Antenna Factor(dB/m) + Cable Factor(dB) – Pre-Amplifier Factor(dB)
3. The other emission levels were very low against the limit.
4. Margin value = Emission Level – Limit value
5. " * ": Fundamental frequency.
6. " # ": The radiated frequency is out of the restricted band.

CHANNEL	TX Channel 157	DETECTOR FUNCTION	Peak (PK)
FREQUENCY RANGE	1GHz ~ 40GHz		Average (AV)

ANTENNA POLARITY & TEST DISTANCE: HORIZONTAL AT 3 M

NO.	FREQ. (MHz)	EMISSION LEVEL (dBuV/m)	LIMIT (dBuV/m)	MARGIN (dB)	ANTENNA HEIGHT (m)	TABLE ANGLE (Degree)	RAW VALUE (dBuV)	CORRECTION FACTOR (dB/m)
1	#5626.10	55.8 PK	68.2	-12.4	2.15 H	291	51.4	4.4
2	*5785.00	118.5 PK			2.37 H	111	114.1	4.4
3	*5785.00	108.0 AV			2.37 H	111	103.6	4.4
4	#5944.01	54.6 PK	68.2	-13.6	2.15 H	291	49.9	4.7
5	11570.00	60.3 PK	74.0	-13.7	2.00 H	165	46.8	13.5
6	11570.00	47.1 AV	54.0	-6.9	2.00 H	165	33.6	13.5
7	#17355.00	45.5 PK	74.0	-28.5	1.61 H	329	27.5	18.0
8	#17355.00	33.3 AV	54.0	-20.7	1.61 H	329	15.3	18.0

ANTENNA POLARITY & TEST DISTANCE: VERTICAL AT 3 M

NO.	FREQ. (MHz)	EMISSION LEVEL (dBuV/m)	LIMIT (dBuV/m)	MARGIN (dB)	ANTENNA HEIGHT (m)	TABLE ANGLE (Degree)	RAW VALUE (dBuV)	CORRECTION FACTOR (dB/m)
1	#5614.27	53.0 PK	68.2	-15.2	2.81 V	259	48.6	4.4
2	*5785.00	113.2 PK			2.81 V	259	108.8	4.4
3	*5785.00	103.0 AV			2.81 V	259	98.6	4.4
4	#5945.79	51.5 PK	68.2	-16.7	2.81 V	259	46.8	4.7
5	11570.00	58.6 PK	74.0	-15.4	1.00 V	28	45.1	13.5
6	11570.00	44.4 AV	54.0	-9.6	1.00 V	28	30.9	13.5
7	#17355.00	46.0 PK	74.0	-28.0	1.76 V	243	28.0	18.0
8	#17355.00	33.9 AV	54.0	-20.1	1.76 V	243	15.9	18.0

REMARKS:

1. Emission Level(dBuV/m) = Raw Value(dBuV) + Correction Factor(dB/m)
2. Correction Factor(dB/m) = Antenna Factor(dB/m) + Cable Factor(dB) – Pre-Amplifier Factor(dB)
3. The other emission levels were very low against the limit.
4. Margin value = Emission Level – Limit value
5. " * ": Fundamental frequency.
6. " # ": The radiated frequency is out of the restricted band.

CHANNEL	TX Channel 165	DETECTOR FUNCTION	Peak (PK)
FREQUENCY RANGE	1GHz ~ 40GHz		Average (AV)

ANTENNA POLARITY & TEST DISTANCE: HORIZONTAL AT 3 M

NO.	FREQ. (MHz)	EMISSION LEVEL (dBuV/m)	LIMIT (dBuV/m)	MARGIN (dB)	ANTENNA HEIGHT (m)	TABLE ANGLE (Degree)	RAW VALUE (dBuV)	CORRECTION FACTOR (dB/m)
1	#5595.81	56.2 PK	68.2	-12.0	2.18 H	298	51.9	4.3
2	*5825.00	117.6 PK			2.38 H	114	113.2	4.4
3	*5825.00	107.1 AV			2.38 H	114	102.7	4.4
4	#5995.59	54.3 PK	68.2	-13.9	2.18 H	298	49.6	4.7
5	11650.00	60.3 PK	74.0	-13.7	2.03 H	158	46.6	13.7
6	11650.00	47.1 AV	54.0	-6.9	2.03 H	158	33.4	13.7
7	#17475.00	45.1 PK	74.0	-28.9	1.55 H	322	26.5	18.6
8	#17475.00	33.2 AV	54.0	-20.8	1.55 H	322	14.6	18.6

ANTENNA POLARITY & TEST DISTANCE: VERTICAL AT 3 M

NO.	FREQ. (MHz)	EMISSION LEVEL (dBuV/m)	LIMIT (dBuV/m)	MARGIN (dB)	ANTENNA HEIGHT (m)	TABLE ANGLE (Degree)	RAW VALUE (dBuV)	CORRECTION FACTOR (dB/m)
1	#5618.64	52.2 PK	68.2	-16.0	2.71 V	265	47.8	4.4
2	*5825.00	113.3 PK			2.71 V	265	108.9	4.4
3	*5825.00	103.1 AV			2.71 V	265	98.7	4.4
4	#5931.25	50.7 PK	68.2	-17.5	2.71 V	265	46.0	4.7
5	11650.00	58.5 PK	74.0	-15.5	1.00 V	49	44.8	13.7
6	11650.00	44.3 AV	54.0	-9.7	1.00 V	49	30.6	13.7
7	#17475.00	46.0 PK	74.0	-28.0	1.73 V	258	27.4	18.6
8	#17475.00	33.8 AV	54.0	-20.2	1.73 V	258	15.2	18.6

REMARKS:

1. Emission Level(dBuV/m) = Raw Value(dBuV) + Correction Factor(dB/m)
2. Correction Factor(dB/m) = Antenna Factor(dB/m) + Cable Factor(dB) – Pre-Amplifier Factor(dB)
3. The other emission levels were very low against the limit.
4. Margin value = Emission Level – Limit value
5. " * ": Fundamental frequency.
6. " # ": The radiated frequency is out of the restricted band.

802.11ac (VHT20)

CHANNEL	TX Channel 36	DETECTOR FUNCTION	Peak (PK)
FREQUENCY RANGE	1GHz ~ 40GHz		Average (AV)

ANTENNA POLARITY & TEST DISTANCE: HORIZONTAL AT 3 M								
NO.	FREQ. (MHz)	EMISSION LEVEL (dBuV/m)	LIMIT (dBuV/m)	MARGIN (dB)	ANTENNA HEIGHT (m)	TABLE ANGLE (Degree)	RAW VALUE (dBuV)	CORRECTION FACTOR (dB/m)
1	5150.00	61.4 PK	74.0	-12.6	2.27 H	117	57.7	3.7
2	5150.00	53.6 AV	54.0	-0.4	2.27 H	117	49.9	3.7
3	*5180.00	115.2 PK			2.27 H	117	111.5	3.7
4	*5180.00	104.5 AV			2.27 H	117	100.8	3.7
5	#10360.00	60.5 PK	74.0	-13.5	2.03 H	148	47.5	13.0
6	#10360.00	46.9 AV	54.0	-7.1	2.03 H	148	33.9	13.0
7	15540.00	44.3 PK	74.0	-29.7	1.63 H	313	31.2	13.1
8	15540.00	32.8 AV	54.0	-21.2	1.63 H	313	19.7	13.1

ANTENNA POLARITY & TEST DISTANCE: VERTICAL AT 3 M								
NO.	FREQ. (MHz)	EMISSION LEVEL (dBuV/m)	LIMIT (dBuV/m)	MARGIN (dB)	ANTENNA HEIGHT (m)	TABLE ANGLE (Degree)	RAW VALUE (dBuV)	CORRECTION FACTOR (dB/m)
1	5150.00	54.7 PK	74.0	-19.3	2.61 V	281	51.0	3.7
2	5150.00	47.6 AV	54.0	-6.4	2.61 V	281	43.9	3.7
3	*5180.00	110.9 PK			2.61 V	281	107.2	3.7
4	*5180.00	100.7 AV			2.61 V	281	97.0	3.7
5	#10360.00	57.9 PK	74.0	-16.1	1.00 V	46	44.9	13.0
6	#10360.00	43.5 AV	54.0	-10.5	1.00 V	46	30.5	13.0
7	15540.00	45.6 PK	74.0	-28.4	1.73 V	244	32.5	13.1
8	15540.00	33.4 AV	54.0	-20.6	1.73 V	244	20.3	13.1

REMARKS:

- Emission Level(dBuV/m) = Raw Value(dBuV) + Correction Factor(dB/m)
- Correction Factor(dB/m) = Antenna Factor(dB/m) + Cable Factor(dB) – Pre-Amplifier Factor(dB)
- The other emission levels were very low against the limit.
- Margin value = Emission Level – Limit value
- " * ": Fundamental frequency.
- " # ": The radiated frequency is out of the restricted band.

CHANNEL	TX Channel 40	DETECTOR FUNCTION	Peak (PK)
FREQUENCY RANGE	1GHz ~ 40GHz		Average (AV)

ANTENNA POLARITY & TEST DISTANCE: HORIZONTAL AT 3 M

NO.	FREQ. (MHz)	EMISSION LEVEL (dBuV/m)	LIMIT (dBuV/m)	MARGIN (dB)	ANTENNA HEIGHT (m)	TABLE ANGLE (Degree)	RAW VALUE (dBuV)	CORRECTION FACTOR (dB/m)
1	5150.00	65.9 PK	74.0	-8.1	2.36 H	122	62.2	3.7
2	5150.00	53.6 AV	54.0	-0.4	2.36 H	122	49.9	3.7
3	*5200.00	118.9 PK			2.36 H	122	115.2	3.7
4	*5200.00	108.6 AV			2.36 H	122	104.9	3.7
5	5350.00	52.8 PK	74.0	-21.2	2.36 H	122	48.7	4.1
6	5350.00	40.8 AV	54.0	-13.2	2.36 H	122	36.7	4.1
7	#10400.00	61.0 PK	74.0	-13.0	2.06 H	164	48.0	13.0
8	#10400.00	47.4 AV	54.0	-6.6	2.06 H	164	34.4	13.0
9	15600.00	45.1 PK	74.0	-28.9	1.57 H	314	31.8	13.3
10	15600.00	33.6 AV	54.0	-20.4	1.57 H	314	20.3	13.3

ANTENNA POLARITY & TEST DISTANCE: VERTICAL AT 3 M

NO.	FREQ. (MHz)	EMISSION LEVEL (dBuV/m)	LIMIT (dBuV/m)	MARGIN (dB)	ANTENNA HEIGHT (m)	TABLE ANGLE (Degree)	RAW VALUE (dBuV)	CORRECTION FACTOR (dB/m)
1	5150.00	60.7 PK	74.0	-13.3	2.61 V	253	57.0	3.7
2	5150.00	47.3 AV	54.0	-6.7	2.61 V	253	43.6	3.7
3	*5200.00	114.5 PK			2.61 V	253	110.8	3.7
4	*5200.00	104.9 AV			2.61 V	253	101.2	3.7
5	5350.00	50.4 PK	74.0	-23.6	2.61 V	253	46.3	4.1
6	5350.00	39.3 AV	54.0	-14.7	2.61 V	253	35.2	4.1
7	#10400.00	57.6 PK	74.0	-16.4	1.00 V	23	44.6	13.0
8	#10400.00	43.5 AV	54.0	-10.5	1.00 V	23	30.5	13.0
9	15600.00	45.9 PK	74.0	-28.1	1.71 V	220	32.6	13.3
10	15600.00	33.1 AV	54.0	-20.9	1.71 V	220	19.8	13.3

REMARKS:

1. Emission Level(dBuV/m) = Raw Value(dBuV) + Correction Factor(dB/m)
2. Correction Factor(dB/m) = Antenna Factor(dB/m) + Cable Factor(dB) – Pre-Amplifier Factor(dB)
3. The other emission levels were very low against the limit.
4. Margin value = Emission Level – Limit value
5. " * ": Fundamental frequency.
6. " # ": The radiated frequency is out of the restricted band.

CHANNEL	TX Channel 48	DETECTOR FUNCTION	Peak (PK)
FREQUENCY RANGE	1GHz ~ 40GHz		Average (AV)

ANTENNA POLARITY & TEST DISTANCE: HORIZONTAL AT 3 M

NO.	FREQ. (MHz)	EMISSION LEVEL (dBuV/m)	LIMIT (dBuV/m)	MARGIN (dB)	ANTENNA HEIGHT (m)	TABLE ANGLE (Degree)	RAW VALUE (dBuV)	CORRECTION FACTOR (dB/m)
1	*5240.00	116.9 PK			2.37 H	117	113.1	3.8
2	*5240.00	106.1 AV			2.37 H	117	102.3	3.8
3	5350.00	54.5 PK	74.0	-19.5	2.37 H	117	50.4	4.1
4	5350.00	43.2 AV	54.0	-10.8	2.37 H	117	39.1	4.1
5	#10480.00	60.4 PK	74.0	-13.6	2.05 H	166	47.2	13.2
6	#10480.00	46.6 AV	54.0	-7.4	2.05 H	166	33.4	13.2
7	15720.00	44.0 PK	74.0	-30.0	1.61 H	319	30.4	13.6
8	15720.00	32.2 AV	54.0	-21.8	1.61 H	319	18.6	13.6

ANTENNA POLARITY & TEST DISTANCE: VERTICAL AT 3 M

NO.	FREQ. (MHz)	EMISSION LEVEL (dBuV/m)	LIMIT (dBuV/m)	MARGIN (dB)	ANTENNA HEIGHT (m)	TABLE ANGLE (Degree)	RAW VALUE (dBuV)	CORRECTION FACTOR (dB/m)
1	*5240.00	112.5 PK			2.64 V	276	108.7	3.8
2	*5240.00	102.4 AV			2.64 V	276	98.6	3.8
3	5350.00	52.8 PK	74.0	-21.2	2.64 V	276	48.7	4.1
4	5350.00	42.3 AV	54.0	-11.7	2.64 V	276	38.2	4.1
5	#10480.00	57.6 PK	74.0	-16.4	1.00 V	34	44.4	13.2
6	#10480.00	43.5 AV	54.0	-10.5	1.00 V	34	30.3	13.2
7	15720.00	45.5 PK	74.0	-28.5	1.83 V	240	31.9	13.6
8	15720.00	33.3 AV	54.0	-20.7	1.83 V	240	19.7	13.6

REMARKS:

- Emission Level(dBuV/m) = Raw Value(dBuV) + Correction Factor(dB/m)
- Correction Factor(dB/m) = Antenna Factor(dB/m) + Cable Factor(dB) – Pre-Amplifier Factor(dB)
- The other emission levels were very low against the limit.
- Margin value = Emission Level – Limit value
- " * ": Fundamental frequency.
- " # ": The radiated frequency is out of the restricted band.

CHANNEL	TX Channel 52	DETECTOR FUNCTION	Peak (PK)
FREQUENCY RANGE	1GHz ~ 40GHz		Average (AV)

ANTENNA POLARITY & TEST DISTANCE: HORIZONTAL AT 3 M

NO.	FREQ. (MHz)	EMISSION LEVEL (dBuV/m)	LIMIT (dBuV/m)	MARGIN (dB)	ANTENNA HEIGHT (m)	TABLE ANGLE (Degree)	RAW VALUE (dBuV)	CORRECTION FACTOR (dB/m)
1	5150.00	55.6 PK	74.0	-18.4	2.39 H	120	51.9	3.7
2	5150.00	44.4 AV	54.0	-9.6	2.39 H	120	40.7	3.7
3	*5260.00	117.2 PK			2.39 H	120	113.2	4.0
4	*5260.00	106.7 AV			2.39 H	120	102.7	4.0
5	5350.00	54.7 PK	74.0	-19.3	2.39 H	120	50.6	4.1
6	5350.00	43.7 AV	54.0	-10.3	2.39 H	120	39.6	4.1
7	#10520.00	60.6 PK	74.0	-13.4	2.06 H	156	47.4	13.2
8	#10520.00	47.2 AV	54.0	-6.8	2.06 H	156	34.0	13.2
9	15780.00	45.0 PK	74.0	-29.0	1.63 H	327	31.4	13.6
10	15780.00	33.1 AV	54.0	-20.9	1.63 H	327	19.5	13.6

ANTENNA POLARITY & TEST DISTANCE: VERTICAL AT 3 M

NO.	FREQ. (MHz)	EMISSION LEVEL (dBuV/m)	LIMIT (dBuV/m)	MARGIN (dB)	ANTENNA HEIGHT (m)	TABLE ANGLE (Degree)	RAW VALUE (dBuV)	CORRECTION FACTOR (dB/m)
1	5150.00	49.0 PK	74.0	-25.0	2.68 V	268	45.3	3.7
2	5150.00	38.4 AV	54.0	-15.6	2.68 V	268	34.7	3.7
3	*5260.00	113.0 PK			2.68 V	268	109.0	4.0
4	*5260.00	103.0 AV			2.68 V	268	99.0	4.0
5	5350.00	52.8 PK	74.0	-21.2	2.68 V	268	48.7	4.1
6	5350.00	41.6 AV	54.0	-12.4	2.68 V	268	37.5	4.1
7	#10520.00	58.0 PK	74.0	-16.0	1.00 V	44	44.8	13.2
8	#10520.00	43.7 AV	54.0	-10.3	1.00 V	44	30.5	13.2
9	15780.00	45.8 PK	74.0	-28.2	1.74 V	236	32.2	13.6
10	15780.00	33.4 AV	54.0	-20.6	1.74 V	236	19.8	13.6

REMARKS:

1. Emission Level(dBuV/m) = Raw Value(dBuV) + Correction Factor(dB/m)
2. Correction Factor(dB/m) = Antenna Factor(dB/m) + Cable Factor(dB) – Pre-Amplifier Factor(dB)
3. The other emission levels were very low against the limit.
4. Margin value = Emission Level – Limit value
5. " * ": Fundamental frequency.
6. " # ": The radiated frequency is out of the restricted band.

CHANNEL	TX Channel 60	DETECTOR FUNCTION	Peak (PK)
FREQUENCY RANGE	1GHz ~ 40GHz		Average (AV)

ANTENNA POLARITY & TEST DISTANCE: HORIZONTAL AT 3 M

NO.	FREQ. (MHz)	EMISSION LEVEL (dBuV/m)	LIMIT (dBuV/m)	MARGIN (dB)	ANTENNA HEIGHT (m)	TABLE ANGLE (Degree)	RAW VALUE (dBuV)	CORRECTION FACTOR (dB/m)
1	5150.00	52.8 PK	74.0	-21.2	2.32 H	120	49.1	3.7
2	5150.00	43.2 AV	54.0	-10.8	2.32 H	120	39.5	3.7
3	*5300.00	117.7 PK			2.32 H	120	113.6	4.1
4	*5300.00	107.0 AV			2.32 H	120	102.9	4.1
5	5350.00	61.6 PK	74.0	-12.4	2.32 H	120	57.5	4.1
6	5350.00	46.2 AV	54.0	-7.8	2.32 H	120	42.1	4.1
7	10600.00	60.3 PK	74.0	-13.7	2.02 H	165	46.8	13.5
8	10600.00	46.8 AV	54.0	-7.2	2.02 H	165	33.3	13.5
9	15900.00	44.9 PK	74.0	-29.1	1.62 H	322	32.0	12.9
10	15900.00	33.0 AV	54.0	-21.0	1.62 H	322	20.1	12.9

ANTENNA POLARITY & TEST DISTANCE: VERTICAL AT 3 M

NO.	FREQ. (MHz)	EMISSION LEVEL (dBuV/m)	LIMIT (dBuV/m)	MARGIN (dB)	ANTENNA HEIGHT (m)	TABLE ANGLE (Degree)	RAW VALUE (dBuV)	CORRECTION FACTOR (dB/m)
1	5150.00	47.6 PK	74.0	-26.4	2.67 V	261	43.9	3.7
2	5150.00	36.8 AV	54.0	-17.2	2.67 V	261	33.1	3.7
3	*5300.00	113.4 PK			2.67 V	261	109.3	4.1
4	*5300.00	103.1 AV			2.67 V	261	99.0	4.1
5	5350.00	59.1 PK	74.0	-14.9	2.67 V	261	55.0	4.1
6	5350.00	44.6 AV	54.0	-9.4	2.67 V	261	40.5	4.1
7	10600.00	57.7 PK	74.0	-16.3	1.00 V	31	44.2	13.5
8	10600.00	43.8 AV	54.0	-10.2	1.00 V	31	30.3	13.5
9	15900.00	45.0 PK	74.0	-29.0	1.79 V	227	32.1	12.9
10	15900.00	32.7 AV	54.0	-21.3	1.79 V	227	19.8	12.9

REMARKS:

1. Emission Level(dBuV/m) = Raw Value(dBuV) + Correction Factor(dB/m)
2. Correction Factor(dB/m) = Antenna Factor(dB/m) + Cable Factor(dB) – Pre-Amplifier Factor(dB)
3. The other emission levels were very low against the limit.
4. Margin value = Emission Level – Limit value
5. " * ": Fundamental frequency.

CHANNEL	TX Channel 64	DETECTOR FUNCTION	Peak (PK)
FREQUENCY RANGE	1GHz ~ 40GHz		Average (AV)

ANTENNA POLARITY & TEST DISTANCE: HORIZONTAL AT 3 M

NO.	FREQ. (MHz)	EMISSION LEVEL (dBuV/m)	LIMIT (dBuV/m)	MARGIN (dB)	ANTENNA HEIGHT (m)	TABLE ANGLE (Degree)	RAW VALUE (dBuV)	CORRECTION FACTOR (dB/m)
1	*5320.00	115.6 PK			2.30 H	116	111.5	4.1
2	*5320.00	104.5 AV			2.30 H	116	100.4	4.1
3	5350.00	67.3 PK	74.0	-6.7	2.30 H	116	63.2	4.1
4	5350.00	53.6 AV	54.0	-0.4	2.30 H	116	49.5	4.1
5	10640.00	60.8 PK	74.0	-13.2	2.05 H	159	47.3	13.5
6	10640.00	46.8 AV	54.0	-7.2	2.05 H	159	33.3	13.5
7	15960.00	43.9 PK	74.0	-30.1	1.71 H	314	31.0	12.9
8	15960.00	32.3 AV	54.0	-21.7	1.71 H	314	19.4	12.9

ANTENNA POLARITY & TEST DISTANCE: VERTICAL AT 3 M

NO.	FREQ. (MHz)	EMISSION LEVEL (dBuV/m)	LIMIT (dBuV/m)	MARGIN (dB)	ANTENNA HEIGHT (m)	TABLE ANGLE (Degree)	RAW VALUE (dBuV)	CORRECTION FACTOR (dB/m)
1	*5320.00	111.2 PK			2.67 V	262	107.1	4.1
2	*5320.00	100.8 AV			2.67 V	262	96.7	4.1
3	5350.00	65.6 PK	74.0	-8.4	2.67 V	262	61.5	4.1
4	5350.00	52.5 AV	54.0	-1.5	2.67 V	262	48.4	4.1
5	10640.00	57.0 PK	74.0	-17.0	1.02 V	16	43.5	13.5
6	10640.00	42.6 AV	54.0	-11.4	1.02 V	16	29.1	13.5
7	15960.00	44.6 PK	74.0	-29.4	1.77 V	221	31.7	12.9
8	15960.00	32.7 AV	54.0	-21.3	1.77 V	221	19.8	12.9

REMARKS:

1. Emission Level(dBuV/m) = Raw Value(dBuV) + Correction Factor(dB/m)
2. Correction Factor(dB/m) = Antenna Factor(dB/m) + Cable Factor(dB) – Pre-Amplifier Factor(dB)
3. The other emission levels were very low against the limit.
4. Margin value = Emission Level – Limit value
5. " * ": Fundamental frequency.

CHANNEL	TX Channel 100	DETECTOR FUNCTION	Peak (PK)
FREQUENCY RANGE	1GHz ~ 40GHz		Average (AV)

ANTENNA POLARITY & TEST DISTANCE: HORIZONTAL AT 3 M

NO.	FREQ. (MHz)	EMISSION LEVEL (dBuV/m)	LIMIT (dBuV/m)	MARGIN (dB)	ANTENNA HEIGHT (m)	TABLE ANGLE (Degree)	RAW VALUE (dBuV)	CORRECTION FACTOR (dB/m)
1	#5470.00	69.4 PK	74.0	-4.6	2.24 H	116	65.2	4.2
2	#5470.00	53.7 AV	54.0	-0.3	2.24 H	116	49.5	4.2
3	*5500.00	116.2 PK			2.24 H	116	112.0	4.2
4	*5500.00	104.6 AV			2.24 H	116	100.4	4.2
5	11000.00	60.2 PK	74.0	-13.8	1.97 H	150	46.1	14.1
6	11000.00	46.4 AV	54.0	-7.6	1.97 H	150	32.3	14.1
7	#16500.00	44.3 PK	74.0	-29.7	1.67 H	296	29.8	14.5
8	#16500.00	32.7 AV	54.0	-21.3	1.67 H	296	18.2	14.5

ANTENNA POLARITY & TEST DISTANCE: VERTICAL AT 3 M

NO.	FREQ. (MHz)	EMISSION LEVEL (dBuV/m)	LIMIT (dBuV/m)	MARGIN (dB)	ANTENNA HEIGHT (m)	TABLE ANGLE (Degree)	RAW VALUE (dBuV)	CORRECTION FACTOR (dB/m)
1	#5470.00	62.5 PK	74.0	-11.5	2.65 V	269	58.3	4.2
2	#5470.00	47.7 AV	54.0	-6.3	2.65 V	269	43.5	4.2
3	*5500.00	111.8 PK			2.65 V	269	107.6	4.2
4	*5500.00	100.8 AV			2.65 V	269	96.6	4.2
5	11000.00	57.5 PK	74.0	-16.5	1.00 V	14	43.4	14.1
6	11000.00	43.0 AV	54.0	-11.0	1.00 V	14	28.9	14.1
7	#16500.00	45.5 PK	74.0	-28.5	1.77 V	207	31.0	14.5
8	#16500.00	33.3 AV	54.0	-20.7	1.77 V	207	18.8	14.5

REMARKS:

1. Emission Level(dBuV/m) = Raw Value(dBuV) + Correction Factor(dB/m)
2. Correction Factor(dB/m) = Antenna Factor(dB/m) + Cable Factor(dB) – Pre-Amplifier Factor(dB)
3. The other emission levels were very low against the limit.
4. Margin value = Emission Level – Limit value
5. " * ": Fundamental frequency.
6. " # ": The radiated frequency is out of the restricted band.

CHANNEL	TX Channel 116	DETECTOR FUNCTION	Peak (PK)
FREQUENCY RANGE	1GHz ~ 40GHz		Average (AV)

ANTENNA POLARITY & TEST DISTANCE: HORIZONTAL AT 3 M

NO.	FREQ. (MHz)	EMISSION LEVEL (dBuV/m)	LIMIT (dBuV/m)	MARGIN (dB)	ANTENNA HEIGHT (m)	TABLE ANGLE (Degree)	RAW VALUE (dBuV)	CORRECTION FACTOR (dB/m)
1	#5470.00	54.9 PK	74.0	-19.1	2.14 H	115	50.7	4.2
2	#5470.00	43.7 AV	54.0	-10.3	2.14 H	115	39.5	4.2
3	*5580.00	117.3 PK			2.14 H	115	113.1	4.2
4	*5580.00	107.1 AV			2.14 H	115	102.9	4.2
5	#5725.00	53.2 PK	74.0	-20.8	2.14 H	115	48.8	4.4
6	#5725.00	39.9 AV	54.0	-14.1	2.14 H	115	35.5	4.4
7	11160.00	61.1 PK	74.0	-12.9	2.08 H	159	47.4	13.7
8	11160.00	47.3 AV	54.0	-6.7	2.08 H	159	33.6	13.7
9	#16740.00	44.7 PK	74.0	-29.3	1.58 H	301	29.0	15.7
10	#16740.00	33.2 AV	54.0	-20.8	1.58 H	301	17.5	15.7

ANTENNA POLARITY & TEST DISTANCE: VERTICAL AT 3 M

NO.	FREQ. (MHz)	EMISSION LEVEL (dBuV/m)	LIMIT (dBuV/m)	MARGIN (dB)	ANTENNA HEIGHT (m)	TABLE ANGLE (Degree)	RAW VALUE (dBuV)	CORRECTION FACTOR (dB/m)
1	#5470.00	49.9 PK	74.0	-24.1	2.58 V	268	45.7	4.2
2	#5470.00	37.4 AV	54.0	-16.6	2.58 V	268	33.2	4.2
3	*5580.00	113.1 PK			2.58 V	268	108.9	4.2
4	*5580.00	103.3 AV			2.58 V	268	99.1	4.2
5	#5725.00	50.8 PK	74.0	-23.2	2.58 V	268	46.4	4.4
6	#5725.00	38.2 AV	54.0	-15.8	2.58 V	268	33.8	4.4
7	11160.00	57.4 PK	74.0	-16.6	1.00 V	29	43.7	13.7
8	11160.00	43.2 AV	54.0	-10.8	1.00 V	29	29.5	13.7
9	#16740.00	45.9 PK	74.0	-28.1	1.81 V	237	30.2	15.7
10	#16740.00	33.5 AV	54.0	-20.5	1.81 V	237	17.8	15.7

REMARKS:

1. Emission Level(dBuV/m) = Raw Value(dBuV) + Correction Factor(dB/m)
2. Correction Factor(dB/m) = Antenna Factor(dB/m) + Cable Factor(dB) – Pre-Amplifier Factor(dB)
3. The other emission levels were very low against the limit.
4. Margin value = Emission Level – Limit value
5. " * ": Fundamental frequency.
6. " # ": The radiated frequency is out of the restricted band.

CHANNEL	TX Channel 140	DETECTOR FUNCTION	Peak (PK)
FREQUENCY RANGE	1GHz ~ 40GHz		Average (AV)

ANTENNA POLARITY & TEST DISTANCE: HORIZONTAL AT 3 M

NO.	FREQ. (MHz)	EMISSION LEVEL (dBuV/m)	LIMIT (dBuV/m)	MARGIN (dB)	ANTENNA HEIGHT (m)	TABLE ANGLE (Degree)	RAW VALUE (dBuV)	CORRECTION FACTOR (dB/m)
1	*5700.00	115.4 PK			2.15 H	114	110.9	4.5
2	*5700.00	103.6 AV			2.15 H	114	99.1	4.5
3	#5725.00	68.0 PK	74.0	-6.0	2.15 H	114	63.6	4.4
4	#5725.00	53.7 AV	54.0	-0.3	2.15 H	114	49.3	4.4
5	11400.00	60.6 PK	74.0	-13.4	1.98 H	170	47.0	13.6
6	11400.00	47.0 AV	54.0	-7.0	1.98 H	170	33.4	13.6
7	#17100.00	44.9 PK	74.0	-29.1	1.59 H	299	27.5	17.4
8	#17100.00	32.8 AV	54.0	-21.2	1.59 H	299	15.4	17.4

ANTENNA POLARITY & TEST DISTANCE: VERTICAL AT 3 M

NO.	FREQ. (MHz)	EMISSION LEVEL (dBuV/m)	LIMIT (dBuV/m)	MARGIN (dB)	ANTENNA HEIGHT (m)	TABLE ANGLE (Degree)	RAW VALUE (dBuV)	CORRECTION FACTOR (dB/m)
1	*5700.00	111.2 PK			2.61 V	274	106.7	4.5
2	*5700.00	99.8 AV			2.61 V	274	95.3	4.5
3	#5725.00	66.4 PK	74.0	-7.6	2.61 V	274	62.0	4.4
4	#5725.00	52.5 AV	54.0	-1.5	2.61 V	274	48.1	4.4
5	11400.00	56.9 PK	74.0	-17.1	1.00 V	33	43.3	13.6
6	11400.00	42.7 AV	54.0	-11.3	1.00 V	33	29.1	13.6
7	#17100.00	45.2 PK	74.0	-28.8	1.79 V	219	27.8	17.4
8	#17100.00	32.9 AV	54.0	-21.1	1.79 V	219	15.5	17.4

REMARKS:

1. Emission Level(dBuV/m) = Raw Value(dBuV) + Correction Factor(dB/m)
2. Correction Factor(dB/m) = Antenna Factor(dB/m) + Cable Factor(dB) – Pre-Amplifier Factor(dB)
3. The other emission levels were very low against the limit.
4. Margin value = Emission Level – Limit value
5. " * ": Fundamental frequency.
6. " # ": The radiated frequency is out of the restricted band.

CHANNEL	TX Channel 149	DETECTOR FUNCTION	Peak (PK)
FREQUENCY RANGE	1GHz ~ 40GHz		Average (AV)

ANTENNA POLARITY & TEST DISTANCE: HORIZONTAL AT 3 M

NO.	FREQ. (MHz)	EMISSION LEVEL (dBuV/m)	LIMIT (dBuV/m)	MARGIN (dB)	ANTENNA HEIGHT (m)	TABLE ANGLE (Degree)	RAW VALUE (dBuV)	CORRECTION FACTOR (dB/m)
1	#5637.69	55.1 PK	68.2	-13.1	2.24 H	360	50.7	4.4
2	*5745.00	117.5 PK			2.14 H	114	113.1	4.4
3	*5745.00	106.7 AV			2.14 H	114	102.3	4.4
4	#5935.44	54.8 PK	68.2	-13.4	2.24 H	360	50.1	4.7
5	11490.00	60.8 PK	74.0	-13.2	2.09 H	150	47.3	13.5
6	11490.00	47.4 AV	54.0	-6.6	2.09 H	150	33.9	13.5
7	#17235.00	45.1 PK	74.0	-28.9	1.56 H	307	27.8	17.3
8	#17235.00	33.3 AV	54.0	-20.7	1.56 H	307	16.0	17.3

ANTENNA POLARITY & TEST DISTANCE: VERTICAL AT 3 M

NO.	FREQ. (MHz)	EMISSION LEVEL (dBuV/m)	LIMIT (dBuV/m)	MARGIN (dB)	ANTENNA HEIGHT (m)	TABLE ANGLE (Degree)	RAW VALUE (dBuV)	CORRECTION FACTOR (dB/m)
1	#5588.23	52.4 PK	68.2	-15.8	2.63 V	267	48.2	4.2
2	*5745.00	113.2 PK			2.63 V	267	108.8	4.4
3	*5745.00	102.4 AV			2.63 V	267	98.0	4.4
4	#5993.12	50.7 PK	68.2	-17.5	2.63 V	267	46.0	4.7
5	11490.00	58.2 PK	74.0	-15.8	1.00 V	56	44.7	13.5
6	11490.00	44.1 AV	54.0	-9.9	1.00 V	56	30.6	13.5
7	#17235.00	46.1 PK	74.0	-27.9	1.70 V	252	28.8	17.3
8	#17235.00	34.0 AV	54.0	-20.0	1.70 V	252	16.7	17.3

REMARKS:

- Emission Level(dBuV/m) = Raw Value(dBuV) + Correction Factor(dB/m)
- Correction Factor(dB/m) = Antenna Factor(dB/m) + Cable Factor(dB) – Pre-Amplifier Factor(dB)
- The other emission levels were very low against the limit.
- Margin value = Emission Level – Limit value
- " * ": Fundamental frequency.
- " # ": The radiated frequency is out of the restricted band.

CHANNEL	TX Channel 157	DETECTOR FUNCTION	Peak (PK)
FREQUENCY RANGE	1GHz ~ 40GHz		Average (AV)

ANTENNA POLARITY & TEST DISTANCE: HORIZONTAL AT 3 M

NO.	FREQ. (MHz)	EMISSION LEVEL (dBuV/m)	LIMIT (dBuV/m)	MARGIN (dB)	ANTENNA HEIGHT (m)	TABLE ANGLE (Degree)	RAW VALUE (dBuV)	CORRECTION FACTOR (dB/m)
1	#5609.29	54.1 PK	68.2	-14.1	2.26 H	360	49.7	4.4
2	*5785.00	117.7 PK			2.13 H	112	113.3	4.4
3	*5785.00	107.0 AV			2.13 H	112	102.6	4.4
4	#5946.72	54.6 PK	68.2	-13.6	2.26 H	360	49.9	4.7
5	11570.00	60.0 PK	74.0	-14.0	2.03 H	148	46.5	13.5
6	11570.00	46.9 AV	54.0	-7.1	2.03 H	148	33.4	13.5
7	#17355.00	45.6 PK	74.0	-28.4	1.54 H	321	27.6	18.0
8	#17355.00	33.5 AV	54.0	-20.5	1.54 H	321	15.5	18.0

ANTENNA POLARITY & TEST DISTANCE: VERTICAL AT 3 M

NO.	FREQ. (MHz)	EMISSION LEVEL (dBuV/m)	LIMIT (dBuV/m)	MARGIN (dB)	ANTENNA HEIGHT (m)	TABLE ANGLE (Degree)	RAW VALUE (dBuV)	CORRECTION FACTOR (dB/m)
1	#5567.06	52.1 PK	68.2	-16.1	2.64 V	269	47.9	4.2
2	*5785.00	113.4 PK			2.64 V	269	109.0	4.4
3	*5785.00	102.2 AV			2.64 V	269	97.8	4.4
4	#6003.27	52.0 PK	68.2	-16.2	2.64 V	269	47.2	4.8
5	11570.00	58.2 PK	74.0	-15.8	1.00 V	40	44.7	13.5
6	11570.00	43.9 AV	54.0	-10.1	1.00 V	40	30.4	13.5
7	#17355.00	46.4 PK	74.0	-27.6	1.72 V	258	28.4	18.0
8	#17355.00	34.2 AV	54.0	-19.8	1.72 V	258	16.2	18.0

REMARKS:

1. Emission Level(dBuV/m) = Raw Value(dBuV) + Correction Factor(dB/m)
2. Correction Factor(dB/m) = Antenna Factor(dB/m) + Cable Factor(dB) – Pre-Amplifier Factor(dB)
3. The other emission levels were very low against the limit.
4. Margin value = Emission Level – Limit value
5. " * ": Fundamental frequency.
6. " # ": The radiated frequency is out of the restricted band.

CHANNEL	TX Channel 165	DETECTOR FUNCTION	Peak (PK)
FREQUENCY RANGE	1GHz ~ 40GHz		Average (AV)

ANTENNA POLARITY & TEST DISTANCE: HORIZONTAL AT 3 M

NO.	FREQ. (MHz)	EMISSION LEVEL (dBuV/m)	LIMIT (dBuV/m)	MARGIN (dB)	ANTENNA HEIGHT (m)	TABLE ANGLE (Degree)	RAW VALUE (dBuV)	CORRECTION FACTOR (dB/m)
1	#5595.75	56.1 PK	68.2	-12.1	2.24 H	360	51.8	4.3
2	*5825.00	117.6 PK			2.34 H	114	113.2	4.4
3	*5825.00	106.6 AV			2.34 H	114	102.2	4.4
4	#5974.53	54.3 PK	68.2	-13.9	2.24 H	360	49.6	4.7
5	11650.00	60.2 PK	74.0	-13.8	1.97 H	168	46.5	13.7
6	11650.00	46.7 AV	54.0	-7.3	1.97 H	168	33.0	13.7
7	#17475.00	44.8 PK	74.0	-29.2	1.54 H	310	26.2	18.6
8	#17475.00	33.1 AV	54.0	-20.9	1.54 H	310	14.5	18.6

ANTENNA POLARITY & TEST DISTANCE: VERTICAL AT 3 M

NO.	FREQ. (MHz)	EMISSION LEVEL (dBuV/m)	LIMIT (dBuV/m)	MARGIN (dB)	ANTENNA HEIGHT (m)	TABLE ANGLE (Degree)	RAW VALUE (dBuV)	CORRECTION FACTOR (dB/m)
1	#5639.92	52.4 PK	68.2	-15.8	2.62 V	263	48.0	4.4
2	*5825.00	113.3 PK			2.62 V	263	108.9	4.4
3	*5825.00	102.3 AV			2.62 V	263	97.9	4.4
4	#5992.94	51.0 PK	68.2	-17.2	2.62 V	263	46.3	4.7
5	11650.00	58.9 PK	74.0	-15.1	1.00 V	57	45.2	13.7
6	11650.00	44.7 AV	54.0	-9.3	1.00 V	57	31.0	13.7
7	#17475.00	46.1 PK	74.0	-27.9	1.78 V	261	27.5	18.6
8	#17475.00	33.8 AV	54.0	-20.2	1.78 V	261	15.2	18.6

REMARKS:

1. Emission Level(dBuV/m) = Raw Value(dBuV) + Correction Factor(dB/m)
2. Correction Factor(dB/m) = Antenna Factor(dB/m) + Cable Factor(dB) – Pre-Amplifier Factor(dB)
3. The other emission levels were very low against the limit.
4. Margin value = Emission Level – Limit value
5. " * ": Fundamental frequency.
6. " # ": The radiated frequency is out of the restricted band.

802.11ac (VHT40)

CHANNEL	TX Channel 38	DETECTOR FUNCTION	Peak (PK)
FREQUENCY RANGE	1GHz ~ 40GHz		Average (AV)

ANTENNA POLARITY & TEST DISTANCE: HORIZONTAL AT 3 M								
NO.	FREQ. (MHz)	EMISSION LEVEL (dBuV/m)	LIMIT (dBuV/m)	MARGIN (dB)	ANTENNA HEIGHT (m)	TABLE ANGLE (Degree)	RAW VALUE (dBuV)	CORRECTION FACTOR (dB/m)
1	5150.00	69.3 PK	74.0	-4.7	2.26 H	296	65.6	3.7
2	5150.00	53.9 AV	54.0	-0.1	2.26 H	296	50.2	3.7
3	*5190.00	110.7 PK			2.26 H	296	107.0	3.7
4	*5190.00	100.7 AV			2.26 H	296	97.0	3.7
5	5350.00	53.0 PK	74.0	-21.0	2.26 H	296	48.9	4.1
6	5350.00	42.6 AV	54.0	-11.4	2.26 H	296	38.5	4.1
7	#10380.00	60.6 PK	74.0	-13.4	2.04 H	150	47.5	13.1
8	#10380.00	46.7 AV	54.0	-7.3	2.04 H	150	33.6	13.1
9	15570.00	44.2 PK	74.0	-29.8	1.61 H	324	30.9	13.3
10	15570.00	32.6 AV	54.0	-21.4	1.61 H	324	19.3	13.3

ANTENNA POLARITY & TEST DISTANCE: VERTICAL AT 3 M								
NO.	FREQ. (MHz)	EMISSION LEVEL (dBuV/m)	LIMIT (dBuV/m)	MARGIN (dB)	ANTENNA HEIGHT (m)	TABLE ANGLE (Degree)	RAW VALUE (dBuV)	CORRECTION FACTOR (dB/m)
1	5150.00	62.4 PK	74.0	-11.6	2.48 V	285	58.7	3.7
2	5150.00	47.7 AV	54.0	-6.3	2.48 V	285	44.0	3.7
3	*5190.00	106.5 PK			2.48 V	285	102.8	3.7
4	*5190.00	97.0 AV			2.48 V	285	93.3	3.7
5	5350.00	51.6 PK	74.0	-22.4	2.48 V	285	47.5	4.1
6	5350.00	41.2 AV	54.0	-12.8	2.48 V	285	37.1	4.1
7	#10380.00	57.4 PK	74.0	-16.6	1.00 V	32	44.3	13.1
8	#10380.00	42.9 AV	54.0	-11.1	1.00 V	32	29.8	13.1
9	15570.00	44.8 PK	74.0	-29.2	1.74 V	224	31.5	13.3
10	15570.00	32.7 AV	54.0	-21.3	1.74 V	224	19.4	13.3

REMARKS:

1. Emission Level(dBuV/m) = Raw Value(dBuV) + Correction Factor(dB/m)
2. Correction Factor(dB/m) = Antenna Factor(dB/m) + Cable Factor(dB) – Pre-Amplifier Factor(dB)
3. The other emission levels were very low against the limit.
4. Margin value = Emission Level – Limit value
5. " * ": Fundamental frequency.
6. " # ": The radiated frequency is out of the restricted band.

CHANNEL	TX Channel 46	DETECTOR FUNCTION	Peak (PK)
FREQUENCY RANGE	1GHz ~ 40GHz		Average (AV)

ANTENNA POLARITY & TEST DISTANCE: HORIZONTAL AT 3 M

NO.	FREQ. (MHz)	EMISSION LEVEL (dBuV/m)	LIMIT (dBuV/m)	MARGIN (dB)	ANTENNA HEIGHT (m)	TABLE ANGLE (Degree)	RAW VALUE (dBuV)	CORRECTION FACTOR (dB/m)
1	5150.00	60.8 PK	74.0	-13.2	2.38 H	301	57.1	3.7
2	5150.00	49.4 AV	54.0	-4.6	2.38 H	301	45.7	3.7
3	*5230.00	112.6 PK			2.38 H	301	108.8	3.8
4	*5230.00	103.5 AV			2.38 H	301	99.7	3.8
5	5350.00	53.7 PK	74.0	-20.3	2.38 H	301	49.6	4.1
6	5350.00	42.6 AV	54.0	-11.4	2.38 H	301	38.5	4.1
7	#10460.00	60.5 PK	74.0	-13.5	2.03 H	151	47.4	13.1
8	#10460.00	47.0 AV	54.0	-7.0	2.03 H	151	33.9	13.1
9	15690.00	43.9 PK	74.0	-30.1	1.64 H	318	30.1	13.8
10	15690.00	32.3 AV	54.0	-21.7	1.64 H	318	18.5	13.8

ANTENNA POLARITY & TEST DISTANCE: VERTICAL AT 3 M

NO.	FREQ. (MHz)	EMISSION LEVEL (dBuV/m)	LIMIT (dBuV/m)	MARGIN (dB)	ANTENNA HEIGHT (m)	TABLE ANGLE (Degree)	RAW VALUE (dBuV)	CORRECTION FACTOR (dB/m)
1	5150.00	58.4 PK	74.0	-15.6	2.53 V	285	54.7	3.7
2	5150.00	47.7 AV	54.0	-6.3	2.53 V	285	44.0	3.7
3	*5230.00	108.4 PK			2.53 V	285	104.6	3.8
4	*5230.00	99.7 AV			2.53 V	285	95.9	3.8
5	5350.00	48.6 PK	74.0	-25.4	2.53 V	285	44.5	4.1
6	5350.00	36.2 AV	54.0	-17.8	2.53 V	285	32.1	4.1
7	#10460.00	58.1 PK	74.0	-15.9	1.00 V	43	45.0	13.1
8	#10460.00	43.9 AV	54.0	-10.1	1.00 V	43	30.8	13.1
9	15690.00	45.4 PK	74.0	-28.6	1.83 V	237	31.6	13.8
10	15690.00	33.2 AV	54.0	-20.8	1.83 V	237	19.4	13.8

REMARKS:

1. Emission Level(dBuV/m) = Raw Value(dBuV) + Correction Factor(dB/m)
2. Correction Factor(dB/m) = Antenna Factor(dB/m) + Cable Factor(dB) – Pre-Amplifier Factor(dB)
3. The other emission levels were very low against the limit.
4. Margin value = Emission Level – Limit value
5. " * ": Fundamental frequency.
6. " # ": The radiated frequency is out of the restricted band.

CHANNEL	TX Channel 54	DETECTOR FUNCTION	Peak (PK)
FREQUENCY RANGE	1GHz ~ 40GHz		Average (AV)

ANTENNA POLARITY & TEST DISTANCE: HORIZONTAL AT 3 M

NO.	FREQ. (MHz)	EMISSION LEVEL (dBuV/m)	LIMIT (dBuV/m)	MARGIN (dB)	ANTENNA HEIGHT (m)	TABLE ANGLE (Degree)	RAW VALUE (dBuV)	CORRECTION FACTOR (dB/m)
1	5150.00	54.6 PK	74.0	-19.4	2.30 H	300	50.9	3.7
2	5150.00	43.9 AV	54.0	-10.1	2.30 H	300	40.2	3.7
3	*5270.00	113.5 PK			2.30 H	300	109.5	4.0
4	*5270.00	104.8 AV			2.30 H	300	100.8	4.0
5	#10540.00	60.6 PK	74.0	-13.4	1.99 H	153	47.3	13.3
6	#10540.00	46.8 AV	54.0	-7.2	1.99 H	153	33.5	13.3
7	15810.00	44.1 PK	74.0	-29.9	1.59 H	323	30.7	13.4
8	15810.00	32.4 AV	54.0	-21.6	1.59 H	323	19.0	13.4

ANTENNA POLARITY & TEST DISTANCE: VERTICAL AT 3 M

NO.	FREQ. (MHz)	EMISSION LEVEL (dBuV/m)	LIMIT (dBuV/m)	MARGIN (dB)	ANTENNA HEIGHT (m)	TABLE ANGLE (Degree)	RAW VALUE (dBuV)	CORRECTION FACTOR (dB/m)
1	5150.00	52.9 PK	74.0	-21.1	2.48 V	288	49.2	3.7
2	5150.00	42.9 AV	54.0	-11.1	2.48 V	288	39.2	3.7
3	*5270.00	109.3 PK			2.48 V	288	105.3	4.0
4	*5270.00	101.1 AV			2.48 V	288	97.1	4.0
5	#10540.00	57.1 PK	74.0	-16.9	1.00 V	26	43.8	13.3
6	#10540.00	43.1 AV	54.0	-10.9	1.00 V	26	29.8	13.3
7	15810.00	46.0 PK	74.0	-28.0	1.78 V	217	32.6	13.4
8	15810.00	33.5 AV	54.0	-20.5	1.78 V	217	20.1	13.4

REMARKS:

1. Emission Level(dBuV/m) = Raw Value(dBuV) + Correction Factor(dB/m)
2. Correction Factor(dB/m) = Antenna Factor(dB/m) + Cable Factor(dB) – Pre-Amplifier Factor(dB)
3. The other emission levels were very low against the limit.
4. Margin value = Emission Level – Limit value
5. " * ": Fundamental frequency.
6. " # ": The radiated frequency is out of the restricted band.

CHANNEL	TX Channel 62	DETECTOR FUNCTION	Peak (PK)
FREQUENCY RANGE	1GHz ~ 40GHz		Average (AV)

ANTENNA POLARITY & TEST DISTANCE: HORIZONTAL AT 3 M

NO.	FREQ. (MHz)	EMISSION LEVEL (dBuV/m)	LIMIT (dBuV/m)	MARGIN (dB)	ANTENNA HEIGHT (m)	TABLE ANGLE (Degree)	RAW VALUE (dBuV)	CORRECTION FACTOR (dB/m)
1	*5310.00	110.5 PK			2.22 H	296	106.4	4.1
2	*5310.00	101.5 AV			2.22 H	296	97.4	4.1
3	5350.00	68.7 PK	74.0	-5.3	2.22 H	296	64.6	4.1
4	5350.00	53.6 AV	54.0	-0.4	2.22 H	296	49.5	4.1
5	10620.00	59.7 PK	74.0	-14.3	1.97 H	154	46.2	13.5
6	10620.00	46.1 AV	54.0	-7.9	1.97 H	154	32.6	13.5
7	15930.00	43.7 PK	74.0	-30.3	1.61 H	306	30.9	12.8
8	15930.00	32.2 AV	54.0	-21.8	1.61 H	306	19.4	12.8

ANTENNA POLARITY & TEST DISTANCE: VERTICAL AT 3 M

NO.	FREQ. (MHz)	EMISSION LEVEL (dBuV/m)	LIMIT (dBuV/m)	MARGIN (dB)	ANTENNA HEIGHT (m)	TABLE ANGLE (Degree)	RAW VALUE (dBuV)	CORRECTION FACTOR (dB/m)
1	*5310.00	106.1 PK			2.53 V	276	102.0	4.1
2	*5310.00	97.9 AV			2.53 V	276	93.8	4.1
3	5350.00	61.9 PK	74.0	-12.1	2.53 V	276	57.8	4.1
4	5350.00	47.5 AV	54.0	-6.5	2.53 V	276	43.4	4.1
5	10620.00	56.6 PK	74.0	-17.4	1.00 V	25	43.1	13.5
6	10620.00	42.2 AV	54.0	-11.8	1.00 V	25	28.7	13.5
7	15930.00	45.8 PK	74.0	-28.2	1.82 V	226	33.0	12.8
8	15930.00	33.4 AV	54.0	-20.6	1.82 V	226	20.6	12.8

REMARKS:

1. Emission Level(dBuV/m) = Raw Value(dBuV) + Correction Factor(dB/m)
2. Correction Factor(dB/m) = Antenna Factor(dB/m) + Cable Factor(dB) – Pre-Amplifier Factor(dB)
3. The other emission levels were very low against the limit.
4. Margin value = Emission Level – Limit value
5. " * ": Fundamental frequency.

CHANNEL	TX Channel 102	DETECTOR FUNCTION	Peak (PK)
FREQUENCY RANGE	1GHz ~ 40GHz		Average (AV)

ANTENNA POLARITY & TEST DISTANCE: HORIZONTAL AT 3 M

NO.	FREQ. (MHz)	EMISSION LEVEL (dBuV/m)	LIMIT (dBuV/m)	MARGIN (dB)	ANTENNA HEIGHT (m)	TABLE ANGLE (Degree)	RAW VALUE (dBuV)	CORRECTION FACTOR (dB/m)
1	#5470.00	68.0 PK	74.0	-6.0	2.17 H	296	63.8	4.2
2	#5470.00	53.9 AV	54.0	-0.1	2.17 H	296	49.7	4.2
3	*5510.00	108.1 PK			2.17 H	296	103.9	4.2
4	*5510.00	98.8 AV			2.17 H	296	94.6	4.2
5	11020.00	59.1 PK	74.0	-14.9	1.99 H	144	45.1	14.0
6	11020.00	45.5 AV	54.0	-8.5	1.99 H	144	31.5	14.0
7	#16530.00	43.1 PK	74.0	-30.9	1.59 H	314	28.2	14.9
8	#16530.00	31.7 AV	54.0	-22.3	1.59 H	314	16.8	14.9

ANTENNA POLARITY & TEST DISTANCE: VERTICAL AT 3 M

NO.	FREQ. (MHz)	EMISSION LEVEL (dBuV/m)	LIMIT (dBuV/m)	MARGIN (dB)	ANTENNA HEIGHT (m)	TABLE ANGLE (Degree)	RAW VALUE (dBuV)	CORRECTION FACTOR (dB/m)
1	#5470.00	66.3 PK	74.0	-7.7	2.56 V	273	62.1	4.2
2	#5470.00	52.7 AV	54.0	-1.3	2.56 V	273	48.5	4.2
3	*5510.00	103.9 PK			2.56 V	273	99.7	4.2
4	*5510.00	95.2 AV			2.56 V	273	91.0	4.2
5	11020.00	56.0 PK	74.0	-18.0	1.00 V	40	42.0	14.0
6	11020.00	41.6 AV	54.0	-12.4	1.00 V	40	27.6	14.0
7	#16530.00	45.2 PK	74.0	-28.8	1.80 V	221	30.3	14.9
8	#16530.00	32.8 AV	54.0	-21.2	1.80 V	221	17.9	14.9

REMARKS:

1. Emission Level(dBuV/m) = Raw Value(dBuV) + Correction Factor(dB/m)
2. Correction Factor(dB/m) = Antenna Factor(dB/m) + Cable Factor(dB) – Pre-Amplifier Factor(dB)
3. The other emission levels were very low against the limit.
4. Margin value = Emission Level – Limit value
5. " * ": Fundamental frequency.
6. " # ": The radiated frequency is out of the restricted band.

CHANNEL	TX Channel 110	DETECTOR FUNCTION	Peak (PK)
FREQUENCY RANGE	1GHz ~ 40GHz		Average (AV)

ANTENNA POLARITY & TEST DISTANCE: HORIZONTAL AT 3 M

NO.	FREQ. (MHz)	EMISSION LEVEL (dBuV/m)	LIMIT (dBuV/m)	MARGIN (dB)	ANTENNA HEIGHT (m)	TABLE ANGLE (Degree)	RAW VALUE (dBuV)	CORRECTION FACTOR (dB/m)
1	#5470.00	65.3 PK	74.0	-8.7	2.31 H	296	61.1	4.2
2	#5470.00	53.8 AV	54.0	-0.2	2.31 H	296	49.6	4.2
3	*5550.00	113.6 PK			2.31 H	296	109.4	4.2
4	*5550.00	104.4 AV			2.31 H	296	100.2	4.2
5	#5725.00	50.8 PK	74.0	-23.2	2.31 H	296	46.4	4.4
6	#5725.00	40.0 AV	54.0	-14.0	2.31 H	296	35.6	4.4
7	11100.00	60.7 PK	74.0	-13.3	2.03 H	153	46.9	13.8
8	11100.00	46.9 AV	54.0	-7.1	2.03 H	153	33.1	13.8
9	#16650.00	44.4 PK	74.0	-29.6	1.61 H	302	28.8	15.6
10	#16650.00	32.7 AV	54.0	-21.3	1.61 H	302	17.1	15.6

ANTENNA POLARITY & TEST DISTANCE: VERTICAL AT 3 M

NO.	FREQ. (MHz)	EMISSION LEVEL (dBuV/m)	LIMIT (dBuV/m)	MARGIN (dB)	ANTENNA HEIGHT (m)	TABLE ANGLE (Degree)	RAW VALUE (dBuV)	CORRECTION FACTOR (dB/m)
1	#5470.00	60.1 PK	74.0	-13.9	2.58 V	287	55.9	4.2
2	#5470.00	47.4 AV	54.0	-6.6	2.58 V	287	43.2	4.2
3	*5550.00	109.4 PK			2.58 V	287	105.2	4.2
4	*5550.00	100.7 AV			2.58 V	287	96.5	4.2
5	#5725.00	48.3 PK	74.0	-25.7	2.58 V	287	43.9	4.4
6	#5725.00	38.3 AV	54.0	-15.7	2.58 V	287	33.9	4.4
7	11100.00	57.8 PK	74.0	-16.2	1.00 V	37	44.0	13.8
8	11100.00	43.9 AV	54.0	-10.1	1.00 V	37	30.1	13.8
9	#16650.00	45.0 PK	74.0	-29.0	1.79 V	221	29.4	15.6
10	#16650.00	32.7 AV	54.0	-21.3	1.79 V	221	17.1	15.6

REMARKS:

1. Emission Level(dBuV/m) = Raw Value(dBuV) + Correction Factor(dB/m)
2. Correction Factor(dB/m) = Antenna Factor(dB/m) + Cable Factor(dB) – Pre-Amplifier Factor(dB)
3. The other emission levels were very low against the limit.
4. Margin value = Emission Level – Limit value
5. " * ": Fundamental frequency.
6. " # ": The radiated frequency is out of the restricted band.

CHANNEL	TX Channel 134	DETECTOR FUNCTION	Peak (PK)
FREQUENCY RANGE	1GHz ~ 40GHz		Average (AV)

ANTENNA POLARITY & TEST DISTANCE: HORIZONTAL AT 3 M

NO.	FREQ. (MHz)	EMISSION LEVEL (dBuV/m)	LIMIT (dBuV/m)	MARGIN (dB)	ANTENNA HEIGHT (m)	TABLE ANGLE (Degree)	RAW VALUE (dBuV)	CORRECTION FACTOR (dB/m)
1	*5670.00	112.2 PK			2.23 H	293	107.9	4.3
2	*5670.00	101.9 AV			2.23 H	293	97.6	4.3
3	#5725.00	64.9 PK	74.0	-9.1	2.23 H	293	60.5	4.4
4	#5725.00	53.9 AV	54.0	-0.1	2.23 H	293	49.5	4.4
5	11340.00	60.1 PK	74.0	-13.9	2.06 H	149	46.5	13.6
6	11340.00	46.5 AV	54.0	-7.5	2.06 H	149	32.9	13.6
7	#17010.00	44.3 PK	74.0	-29.7	1.66 H	303	27.2	17.1
8	#17010.00	32.4 AV	54.0	-21.6	1.66 H	303	15.3	17.1

ANTENNA POLARITY & TEST DISTANCE: VERTICAL AT 3 M

NO.	FREQ. (MHz)	EMISSION LEVEL (dBuV/m)	LIMIT (dBuV/m)	MARGIN (dB)	ANTENNA HEIGHT (m)	TABLE ANGLE (Degree)	RAW VALUE (dBuV)	CORRECTION FACTOR (dB/m)
1	*5670.00	107.8 PK			2.50 V	285	103.5	4.3
2	*5670.00	98.2 AV			2.50 V	285	93.9	4.3
3	#5725.00	63.3 PK	74.0	-10.7	2.50 V	285	58.9	4.4
4	#5725.00	52.3 AV	54.0	-1.7	2.50 V	285	47.9	4.4
5	11340.00	57.8 PK	74.0	-16.2	1.00 V	17	44.2	13.6
6	11340.00	43.5 AV	54.0	-10.5	1.00 V	17	29.9	13.6
7	#17010.00	45.1 PK	74.0	-28.9	1.78 V	220	28.0	17.1
8	#17010.00	32.6 AV	54.0	-21.4	1.78 V	220	15.5	17.1

REMARKS:

1. Emission Level(dBuV/m) = Raw Value(dBuV) + Correction Factor(dB/m)
2. Correction Factor(dB/m) = Antenna Factor(dB/m) + Cable Factor(dB) – Pre-Amplifier Factor(dB)
3. The other emission levels were very low against the limit.
4. Margin value = Emission Level – Limit value
5. " * ": Fundamental frequency.
6. " # ": The radiated frequency is out of the restricted band.

CHANNEL	TX Channel 151	DETECTOR FUNCTION	Peak (PK)
FREQUENCY RANGE	1GHz ~ 40GHz		Average (AV)

ANTENNA POLARITY & TEST DISTANCE: HORIZONTAL AT 3 M

NO.	FREQ. (MHz)	EMISSION LEVEL (dBuV/m)	LIMIT (dBuV/m)	MARGIN (dB)	ANTENNA HEIGHT (m)	TABLE ANGLE (Degree)	RAW VALUE (dBuV)	CORRECTION FACTOR (dB/m)
1	#5646.25	64.9 PK	68.2	-3.3	2.16 H	297	60.5	4.4
2	*5755.00	114.4 PK			2.16 H	297	110.0	4.4
3	*5755.00	105.3 AV			2.16 H	297	100.9	4.4
4	#5994.65	54.3 PK	68.2	-13.9	2.16 H	297	49.6	4.7
5	11510.00	60.0 PK	74.0	-14.0	2.01 H	165	46.4	13.6
6	11510.00	47.1 AV	54.0	-6.9	2.01 H	165	33.5	13.6
7	#17265.00	45.0 PK	74.0	-29.0	1.54 H	328	27.4	17.6
8	#17265.00	33.1 AV	54.0	-20.9	1.54 H	328	15.5	17.6

ANTENNA POLARITY & TEST DISTANCE: VERTICAL AT 3 M

NO.	FREQ. (MHz)	EMISSION LEVEL (dBuV/m)	LIMIT (dBuV/m)	MARGIN (dB)	ANTENNA HEIGHT (m)	TABLE ANGLE (Degree)	RAW VALUE (dBuV)	CORRECTION FACTOR (dB/m)
1	#5643.01	58.5 PK	68.2	-9.7	2.53 V	279	54.1	4.4
2	*5755.00	110.2 PK			2.53 V	279	105.8	4.4
3	*5755.00	101.6 AV			2.53 V	279	97.2	4.4
4	#5947.59	51.4 PK	68.2	-16.8	2.53 V	279	46.7	4.7
5	11510.00	58.8 PK	74.0	-15.2	1.00 V	44	45.2	13.6
6	11510.00	44.5 AV	54.0	-9.5	1.00 V	44	30.9	13.6
7	#17265.00	46.7 PK	74.0	-27.3	1.75 V	263	29.1	17.6
8	#17265.00	34.2 AV	54.0	-19.8	1.75 V	263	16.6	17.6

REMARKS:

1. Emission Level(dBuV/m) = Raw Value(dBuV) + Correction Factor(dB/m)
2. Correction Factor(dB/m) = Antenna Factor(dB/m) + Cable Factor(dB) – Pre-Amplifier Factor(dB)
3. The other emission levels were very low against the limit.
4. Margin value = Emission Level – Limit value
5. " * ": Fundamental frequency.
6. " # ": The radiated frequency is out of the restricted band.

CHANNEL	TX Channel 159	DETECTOR FUNCTION	Peak (PK)
FREQUENCY RANGE	1GHz ~ 40GHz		Average (AV)

ANTENNA POLARITY & TEST DISTANCE: HORIZONTAL AT 3 M

NO.	FREQ. (MHz)	EMISSION LEVEL (dBuV/m)	LIMIT (dBuV/m)	MARGIN (dB)	ANTENNA HEIGHT (m)	TABLE ANGLE (Degree)	RAW VALUE (dBuV)	CORRECTION FACTOR (dB/m)
1	#5638.99	58.8 PK	68.2	-9.4	2.13 H	291	54.4	4.4
2	*5795.00	114.2 PK			2.13 H	291	109.8	4.4
3	*5795.00	105.2 AV			2.13 H	291	100.8	4.4
4	#5924.55	62.2 PK	68.5	-6.3	2.13 H	291	57.5	4.7
5	11590.00	60.1 PK	74.0	-13.9	1.99 H	166	46.6	13.5
6	11590.00	47.1 AV	54.0	-6.9	1.99 H	166	33.6	13.5
7	#17385.00	45.8 PK	74.0	-28.2	1.55 H	335	27.5	18.3
8	#17385.00	33.7 AV	54.0	-20.3	1.55 H	335	15.4	18.3

ANTENNA POLARITY & TEST DISTANCE: VERTICAL AT 3 M

NO.	FREQ. (MHz)	EMISSION LEVEL (dBuV/m)	LIMIT (dBuV/m)	MARGIN (dB)	ANTENNA HEIGHT (m)	TABLE ANGLE (Degree)	RAW VALUE (dBuV)	CORRECTION FACTOR (dB/m)
1	#5636.14	54.7 PK	68.2	-13.5	2.49 V	277	50.3	4.4
2	*5795.00	110.1 PK			2.49 V	277	105.7	4.4
3	*5795.00	101.3 AV			2.49 V	277	96.9	4.4
4	#5940.33	53.1 PK	68.2	-15.1	2.49 V	277	48.4	4.7
5	11590.00	58.4 PK	74.0	-15.6	1.02 V	56	44.9	13.5
6	11590.00	44.1 AV	54.0	-9.9	1.02 V	56	30.6	13.5
7	#17385.00	45.6 PK	74.0	-28.4	1.73 V	251	27.3	18.3
8	#17385.00	33.7 AV	54.0	-20.3	1.73 V	251	15.4	18.3

REMARKS:

1. Emission Level(dBuV/m) = Raw Value(dBuV) + Correction Factor(dB/m)
2. Correction Factor(dB/m) = Antenna Factor(dB/m) + Cable Factor(dB) – Pre-Amplifier Factor(dB)
3. The other emission levels were very low against the limit.
4. Margin value = Emission Level – Limit value
5. " * ": Fundamental frequency.
6. " # ": The radiated frequency is out of the restricted band.

802.11ac (VHT80)

CHANNEL	TX Channel 42	DETECTOR FUNCTION	Peak (PK)
FREQUENCY RANGE	1GHz ~ 40GHz		Average (AV)

ANTENNA POLARITY & TEST DISTANCE: HORIZONTAL AT 3 M

NO.	FREQ. (MHz)	EMISSION LEVEL (dBuV/m)	LIMIT (dBuV/m)	MARGIN (dB)	ANTENNA HEIGHT (m)	TABLE ANGLE (Degree)	RAW VALUE (dBuV)	CORRECTION FACTOR (dB/m)
1	5150.00	66.2 PK	74.0	-7.8	2.40 H	296	62.5	3.7
2	5150.00	53.9 AV	54.0	-0.1	2.40 H	296	50.2	3.7
3	*5210.00	104.2 PK			2.40 H	296	100.5	3.7
4	*5210.00	95.9 AV			2.40 H	296	92.2	3.7
5	5350.00	56.2 PK	74.0	-17.8	2.40 H	296	52.1	4.1
6	5350.00	41.9 AV	54.0	-12.1	2.40 H	296	37.8	4.1
7	#10420.00	60.8 PK	74.0	-13.2	2.01 H	163	47.7	13.1
8	#10420.00	46.7 AV	54.0	-7.3	2.01 H	163	33.6	13.1
9	15630.00	44.4 PK	74.0	-29.6	1.59 H	296	30.8	13.6
10	15630.00	32.8 AV	54.0	-21.2	1.59 H	296	19.2	13.6

ANTENNA POLARITY & TEST DISTANCE: VERTICAL AT 3 M

NO.	FREQ. (MHz)	EMISSION LEVEL (dBuV/m)	LIMIT (dBuV/m)	MARGIN (dB)	ANTENNA HEIGHT (m)	TABLE ANGLE (Degree)	RAW VALUE (dBuV)	CORRECTION FACTOR (dB/m)
1	5150.00	59.6 PK	74.0	-14.4	3.85 V	112	55.9	3.7
2	5150.00	47.8 AV	54.0	-6.2	3.85 V	112	44.1	3.7
3	*5210.00	99.9 PK			3.85 V	112	96.2	3.7
4	*5210.00	92.1 AV			3.85 V	112	88.4	3.7
5	5350.00	54.8 PK	74.0	-19.2	3.85 V	112	50.7	4.1
6	5350.00	40.3 AV	54.0	-13.7	3.85 V	112	36.2	4.1
7	#10420.00	57.0 PK	74.0	-17.0	1.01 V	38	43.9	13.1
8	#10420.00	42.5 AV	54.0	-11.5	1.01 V	38	29.4	13.1
9	15630.00	44.8 PK	74.0	-29.2	1.83 V	221	31.2	13.6
10	15630.00	32.7 AV	54.0	-21.3	1.83 V	221	19.1	13.6

REMARKS:

1. Emission Level(dBuV/m) = Raw Value(dBuV) + Correction Factor(dB/m)
2. Correction Factor(dB/m) = Antenna Factor(dB/m) + Cable Factor(dB) – Pre-Amplifier Factor(dB)
3. The other emission levels were very low against the limit.
4. Margin value = Emission Level – Limit value
5. " * ": Fundamental frequency.
6. " # ": The radiated frequency is out of the restricted band.

CHANNEL	TX Channel 58	DETECTOR FUNCTION	Peak (PK)
FREQUENCY RANGE	1GHz ~ 40GHz		Average (AV)

ANTENNA POLARITY & TEST DISTANCE: HORIZONTAL AT 3 M

NO.	FREQ. (MHz)	EMISSION LEVEL (dBuV/m)	LIMIT (dBuV/m)	MARGIN (dB)	ANTENNA HEIGHT (m)	TABLE ANGLE (Degree)	RAW VALUE (dBuV)	CORRECTION FACTOR (dB/m)
1	5150.00	50.8 PK	74.0	-23.2	2.37 H	295	47.1	3.7
2	5150.00	39.8 AV	54.0	-14.2	2.37 H	295	36.1	3.7
3	*5290.00	103.4 PK			2.37 H	295	99.3	4.1
4	*5290.00	94.5 AV			2.37 H	295	90.4	4.1
5	5350.00	65.2 PK	74.0	-8.8	2.37 H	295	61.1	4.1
6	5350.00	53.9 AV	54.0	-0.1	2.37 H	295	49.8	4.1
7	#10580.00	58.9 PK	74.0	-15.1	2.04 H	135	45.5	13.4
8	#10580.00	45.1 AV	54.0	-8.9	2.04 H	135	31.7	13.4
9	15870.00	43.5 PK	74.0	-30.5	1.61 H	323	30.5	13.0
10	15870.00	32.2 AV	54.0	-21.8	1.61 H	323	19.2	13.0

ANTENNA POLARITY & TEST DISTANCE: VERTICAL AT 3 M

NO.	FREQ. (MHz)	EMISSION LEVEL (dBuV/m)	LIMIT (dBuV/m)	MARGIN (dB)	ANTENNA HEIGHT (m)	TABLE ANGLE (Degree)	RAW VALUE (dBuV)	CORRECTION FACTOR (dB/m)
1	5150.00	48.1 PK	74.0	-25.9	3.94 V	136	44.4	3.7
2	5150.00	38.1 AV	54.0	-15.9	3.94 V	136	34.4	3.7
3	*5290.00	99.2 PK			3.94 V	136	95.1	4.1
4	*5290.00	90.7 AV			3.94 V	136	86.6	4.1
5	5350.00	62.8 PK	74.0	-11.2	3.94 V	136	58.7	4.1
6	5350.00	52.3 AV	54.0	-1.7	3.94 V	136	48.2	4.1
7	#10580.00	56.3 PK	74.0	-17.7	1.00 V	51	42.9	13.4
8	#10580.00	42.0 AV	54.0	-12.0	1.00 V	51	28.6	13.4
9	15870.00	45.3 PK	74.0	-28.7	1.79 V	226	32.3	13.0
10	15870.00	33.0 AV	54.0	-21.0	1.79 V	226	20.0	13.0

REMARKS:

1. Emission Level(dBuV/m) = Raw Value(dBuV) + Correction Factor(dB/m)
2. Correction Factor(dB/m) = Antenna Factor(dB/m) + Cable Factor(dB) – Pre-Amplifier Factor(dB)
3. The other emission levels were very low against the limit.
4. Margin value = Emission Level – Limit value
5. " * ": Fundamental frequency.
6. " # ": The radiated frequency is out of the restricted band.

CHANNEL	TX Channel 106	DETECTOR FUNCTION	Peak (PK)
FREQUENCY RANGE	1GHz ~ 40GHz		Average (AV)

ANTENNA POLARITY & TEST DISTANCE: HORIZONTAL AT 3 M

NO.	FREQ. (MHz)	EMISSION LEVEL (dBuV/m)	LIMIT (dBuV/m)	MARGIN (dB)	ANTENNA HEIGHT (m)	TABLE ANGLE (Degree)	RAW VALUE (dBuV)	CORRECTION FACTOR (dB/m)
1	#5470.00	67.9 PK	74.0	-6.1	2.30 H	291	63.7	4.2
2	#5470.00	53.9 AV	54.0	-0.1	2.30 H	291	49.7	4.2
3	*5530.00	103.3 PK			2.30 H	291	99.1	4.2
4	*5530.00	93.6 AV			2.30 H	291	89.4	4.2
5	#5725.00	50.4 PK	74.0	-23.6	2.30 H	291	46.0	4.4
6	#5725.00	39.6 AV	54.0	-14.4	2.30 H	291	35.2	4.4
7	11060.00	58.4 PK	74.0	-15.6	1.96 H	130	44.5	13.9
8	11060.00	45.0 AV	54.0	-9.0	1.96 H	130	31.1	13.9
9	#16590.00	43.3 PK	74.0	-30.7	1.64 H	308	27.7	15.6
10	#16590.00	32.2 AV	54.0	-21.8	1.64 H	308	16.6	15.6

ANTENNA POLARITY & TEST DISTANCE: VERTICAL AT 3 M

NO.	FREQ. (MHz)	EMISSION LEVEL (dBuV/m)	LIMIT (dBuV/m)	MARGIN (dB)	ANTENNA HEIGHT (m)	TABLE ANGLE (Degree)	RAW VALUE (dBuV)	CORRECTION FACTOR (dB/m)
1	#5470.00	62.8 PK	74.0	-11.2	3.91 V	137	58.6	4.2
2	#5470.00	47.5 AV	54.0	-6.5	3.91 V	137	43.3	4.2
3	*5530.00	99.0 PK			3.91 V	137	94.8	4.2
4	*5530.00	90.0 AV			3.91 V	137	85.8	4.2
5	#5725.00	48.0 PK	74.0	-26.0	3.91 V	137	43.6	4.4
6	#5725.00	37.9 AV	54.0	-16.1	3.91 V	137	33.5	4.4
7	11060.00	56.2 PK	74.0	-17.8	1.03 V	25	42.3	13.9
8	11060.00	41.8 AV	54.0	-12.2	1.03 V	25	27.9	13.9
9	#16590.00	45.6 PK	74.0	-28.4	1.76 V	222	30.0	15.6
10	#16590.00	33.2 AV	54.0	-20.8	1.76 V	222	17.6	15.6

REMARKS:

1. Emission Level(dBuV/m) = Raw Value(dBuV) + Correction Factor(dB/m)
2. Correction Factor(dB/m) = Antenna Factor(dB/m) + Cable Factor(dB) – Pre-Amplifier Factor(dB)
3. The other emission levels were very low against the limit.
4. Margin value = Emission Level – Limit value
5. " * ": Fundamental frequency.
6. " # ": The radiated frequency is out of the restricted band.

CHANNEL	TX Channel 122	DETECTOR FUNCTION	Peak (PK)
FREQUENCY RANGE	1GHz ~ 40GHz		Average (AV)

ANTENNA POLARITY & TEST DISTANCE: HORIZONTAL AT 3 M

NO.	FREQ. (MHz)	EMISSION LEVEL (dBuV/m)	LIMIT (dBuV/m)	MARGIN (dB)	ANTENNA HEIGHT (m)	TABLE ANGLE (Degree)	RAW VALUE (dBuV)	CORRECTION FACTOR (dB/m)
1	*5610.00	109.8 PK			2.38 H	294	105.4	4.4
2	*5610.00	99.8 AV			2.38 H	294	95.4	4.4
3	#5725.00	67.8 PK	74.0	-6.2	2.38 H	294	63.4	4.4
4	#5725.00	53.8 AV	54.0	-0.2	2.38 H	294	49.4	4.4
5	11220.00	60.1 PK	74.0	-13.9	2.06 H	161	46.4	13.7
6	11220.00	46.7 AV	54.0	-7.3	2.06 H	161	33.0	13.7
7	#16830.00	45.2 PK	74.0	-28.8	1.57 H	309	29.3	15.9
8	#16830.00	33.2 AV	54.0	-20.8	1.57 H	309	17.3	15.9

ANTENNA POLARITY & TEST DISTANCE: VERTICAL AT 3 M

NO.	FREQ. (MHz)	EMISSION LEVEL (dBuV/m)	LIMIT (dBuV/m)	MARGIN (dB)	ANTENNA HEIGHT (m)	TABLE ANGLE (Degree)	RAW VALUE (dBuV)	CORRECTION FACTOR (dB/m)
1	*5610.00	105.5 PK			3.90 V	137	101.1	4.4
2	*5610.00	96.0 AV			3.90 V	137	91.6	4.4
3	#5725.00	66.1 PK	74.0	-7.9	3.90 V	137	61.7	4.4
4	#5725.00	52.3 AV	54.0	-1.7	3.90 V	137	47.9	4.4
5	11220.00	57.6 PK	74.0	-16.4	1.00 V	27	43.9	13.7
6	11220.00	43.5 AV	54.0	-10.5	1.00 V	27	29.8	13.7
7	#16830.00	45.9 PK	74.0	-28.1	1.78 V	220	30.0	15.9
8	#16830.00	33.4 AV	54.0	-20.6	1.78 V	220	17.5	15.9

REMARKS:

1. Emission Level(dBuV/m) = Raw Value(dBuV) + Correction Factor(dB/m)
2. Correction Factor(dB/m) = Antenna Factor(dB/m) + Cable Factor(dB) – Pre-Amplifier Factor(dB)
3. The other emission levels were very low against the limit.
4. Margin value = Emission Level – Limit value
5. " * ": Fundamental frequency.
6. " # ": The radiated frequency is out of the restricted band.

CHANNEL	TX Channel 155	DETECTOR FUNCTION	Peak (PK)
FREQUENCY RANGE	1GHz ~ 40GHz		Average (AV)

ANTENNA POLARITY & TEST DISTANCE: HORIZONTAL AT 3 M

NO.	FREQ. (MHz)	EMISSION LEVEL (dBuV/m)	LIMIT (dBuV/m)	MARGIN (dB)	ANTENNA HEIGHT (m)	TABLE ANGLE (Degree)	RAW VALUE (dBuV)	CORRECTION FACTOR (dB/m)
1	#5643.95	66.9 PK	68.2	-1.3	2.32 H	360	62.5	4.4
2	*5775.00	108.9 PK			2.32 H	360	104.5	4.4
3	*5775.00	99.8 AV			2.32 H	360	95.4	4.4
4	#5949.55	61.8 PK	68.2	-6.4	2.32 H	360	57.1	4.7
5	11550.00	60.5 PK	74.0	-13.5	2.05 H	145	47.0	13.5
6	11550.00	47.3 AV	54.0	-6.7	2.05 H	145	33.8	13.5
7	#17325.00	44.7 PK	74.0	-29.3	1.57 H	312	26.9	17.8
8	#17325.00	32.9 AV	54.0	-21.1	1.57 H	312	15.1	17.8

ANTENNA POLARITY & TEST DISTANCE: VERTICAL AT 3 M

NO.	FREQ. (MHz)	EMISSION LEVEL (dBuV/m)	LIMIT (dBuV/m)	MARGIN (dB)	ANTENNA HEIGHT (m)	TABLE ANGLE (Degree)	RAW VALUE (dBuV)	CORRECTION FACTOR (dB/m)
1	#5647.16	59.1 PK	68.2	-9.1	3.90 V	126	54.7	4.4
2	*5775.00	104.6 PK			3.90 V	126	100.2	4.4
3	*5775.00	96.1 AV			3.90 V	126	91.7	4.4
4	#5928.12	59.0 PK	68.2	-9.2	3.90 V	126	54.3	4.7
5	11550.00	58.7 PK	74.0	-15.3	1.00 V	39	45.2	13.5
6	11550.00	44.4 AV	54.0	-9.6	1.00 V	39	30.9	13.5
7	#17325.00	45.8 PK	74.0	-28.2	1.78 V	258	28.0	17.8
8	#17325.00	33.5 AV	54.0	-20.5	1.78 V	258	15.7	17.8

REMARKS:

1. Emission Level(dBuV/m) = Raw Value(dBuV) + Correction Factor(dB/m)
2. Correction Factor(dB/m) = Antenna Factor(dB/m) + Cable Factor(dB) – Pre-Amplifier Factor(dB)
3. The other emission levels were very low against the limit.
4. Margin value = Emission Level – Limit value
5. " * ": Fundamental frequency.
6. " # ": The radiated frequency is out of the restricted band.

Below 1GHz Data:

802.11ac (VHT20)

CHANNEL	TX Channel 157	DETECTOR FUNCTION	Quasi-Peak (QP)
FREQUENCY RANGE	9kHz ~ 1GHz		

ANTENNA POLARITY & TEST DISTANCE: HORIZONTAL AT 3 M

NO.	FREQ. (MHz)	EMISSION LEVEL (dBuV/m)	LIMIT (dBuV/m)	MARGIN (dB)	ANTENNA HEIGHT (m)	TABLE ANGLE (Degree)	RAW VALUE (dBuV)	CORRECTION FACTOR (dB/m)
1	99.94	27.6 QP	43.5	-15.9	2.00 H	104	40.1	-12.5
2	175.21	38.6 QP	43.5	-4.9	1.50 H	193	47.9	-9.3
3	244.08	35.7 QP	46.0	-10.3	1.00 H	118	45.4	-9.7
4	260.13	33.9 QP	46.0	-12.1	1.50 H	112	43.0	-9.1
5	479.28	35.8 QP	46.0	-10.2	2.00 H	152	39.3	-3.5
6	721.12	35.5 QP	46.0	-10.5	1.00 H	26	34.9	0.6

ANTENNA POLARITY & TEST DISTANCE: VERTICAL AT 3 M

NO.	FREQ. (MHz)	EMISSION LEVEL (dBuV/m)	LIMIT (dBuV/m)	MARGIN (dB)	ANTENNA HEIGHT (m)	TABLE ANGLE (Degree)	RAW VALUE (dBuV)	CORRECTION FACTOR (dB/m)
1	137.21	26.7 QP	43.5	-16.8	1.00 V	186	35.4	-8.7
2	166.60	29.9 QP	43.5	-13.6	1.00 V	91	38.6	-8.7
3	261.88	27.0 QP	46.0	-19.0	1.00 V	177	36.0	-9.0
4	478.55	33.0 QP	46.0	-13.0	1.50 V	264	36.5	-3.5
5	657.49	27.4 QP	46.0	-18.6	1.50 V	360	27.6	-0.2
6	720.74	32.8 QP	46.0	-13.2	1.50 V	140	32.3	0.5

REMARKS:

1. Emission Level(dBuV/m) = Raw Value(dBuV) + Correction Factor(dB/m)
2. Correction Factor(dB/m) = Antenna Factor(dB/m) + Cable Factor(dB) – Pre-Amplifier Factor(dB)
3. The other emission levels were very low against the limit.
4. Margin value = Emission Level – Limit value

4.2 Conducted Emission Measurement

4.2.1 Limits of Conducted Emission Measurement

Frequency (MHz)	Conducted Limit (dBuV)	
	Quasi-peak	Average
0.15 - 0.5	66 - 56	56 - 46
0.50 - 5.0	56	46
5.0 - 30.0	60	50

Note: 1. The lower limit shall apply at the transition frequencies.

2. The limit decreases in line with the logarithm of the frequency in the range of 0.15 to 0.50MHz.

4.2.2 Test Instruments

DESCRIPTION & MANUFACTURER	MODEL NO.	SERIAL NO.	CALIBRATED DATE	CALIBRATED UNTIL
Test Receiver R&S	ESCS 30	847124/029	Oct. 24, 2016	Oct. 23, 2017
Line-Impedance Stabilization Network (for EUT) R&S	ESH3-Z5	848773/004	Oct. 26, 2016	Oct. 25, 2017
Line-Impedance Stabilization Network (for Peripheral) R&S	ENV216	100072	June 03, 2017	June 02, 2018
50 ohms Terminator	N/A	EMC-02	Sep. 29, 2016	Sep. 28, 2017
RF Cable	5D-FB	COCCAB-001	Sep. 30, 2016	Sep. 29, 2017
10 dB PAD Mini-Circuits	HAT-10+	CONATT-004	June 18, 2017	June 17, 2018
Software BVADT	BVADT_Cond_ V7.3.7.4	NA	NA	NA

Note:

1. The calibration interval of the above test instruments are 12 months and the calibrations are traceable to NML/ROC and NIST/USA.
2. The test was performed in Shielded Room No. 1.
3. Tested Date: Sep. 13, 2017

4.2.3 Test Procedure

- The EUT was placed 0.4 meters from the conducting wall of the shielded room with EUT being connected to the power mains through a line impedance stabilization network (LISN). Other support units were connected to the power mains through another LISN. The two LISNs provide 50 ohm/ 50uH of coupling impedance for the measuring instrument.
- Both lines of the power mains connected to the EUT were checked for maximum conducted interference.
- The frequency range from 150kHz to 30MHz was searched. Emission levels under (Limit - 20dB) was not recorded.

NOTE: All modes of operation were investigated and the worst-case emissions are reported.

4.2.4 Deviation from Test Standard

No deviation.

4.2.5 Test Setup

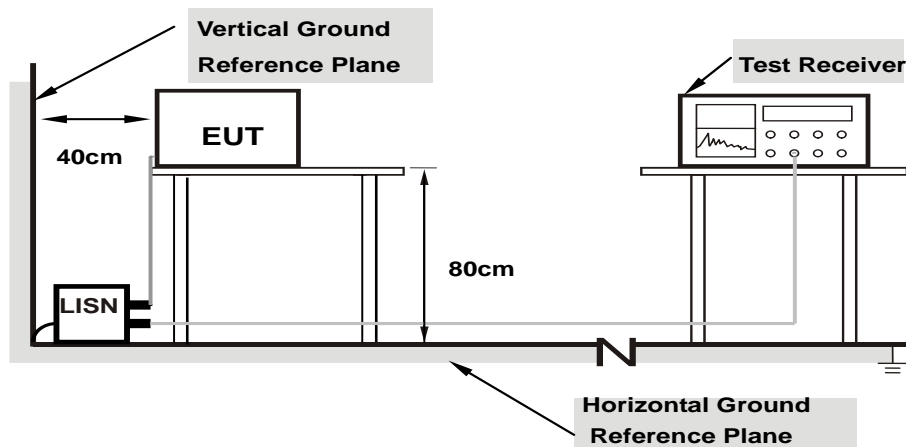

Note: 1.Support units were connected to second LISN.

For the actual test configuration, please refer to the attached file (Test Setup Photo).

4.2.6 EUT Operating Condition

Same as 4.1.6.

4.2.7 Test Results

Phase	Line (L)	Detector Function	Quasi-Peak (QP) / Average (AV)
-------	----------	-------------------	--------------------------------

No	Freq. [MHz]	Corr.	Reading Value		Emission Level		Limit		Margin	
		Factor (dB)	[dB (uV)]		[dB (uV)]		[dB (uV)]		(dB)	
	Q.P.	AV.	Q.P.	AV.	Q.P.	AV.	Q.P.	AV.	Q.P.	AV.
1	0.15000	10.07	35.27	24.72	45.34	34.79	66.00	56.00	-20.66	-21.21
2	0.17344	10.07	34.00	20.43	44.07	30.50	64.79	54.79	-20.72	-24.29
3	0.23203	10.07	32.48	24.64	42.55	34.71	62.38	52.38	-19.83	-17.67
4	16.46484	11.06	33.37	32.56	44.43	43.62	60.00	50.00	-15.57	-6.38
5	21.16797	11.30	29.60	29.18	40.90	40.48	60.00	50.00	-19.10	-9.52
6	25.87500	11.33	26.50	26.14	37.83	37.47	60.00	50.00	-22.17	-12.53

REMARKS:

1. Q.P. and AV. are abbreviations of quasi-peak and average individually.
2. The emission levels of other frequencies were very low against the limit.
3. Margin value = Emission level - Limit value
4. Correction factor = Insertion loss + Cable loss
5. Emission Level = Correction Factor + Reading Value.

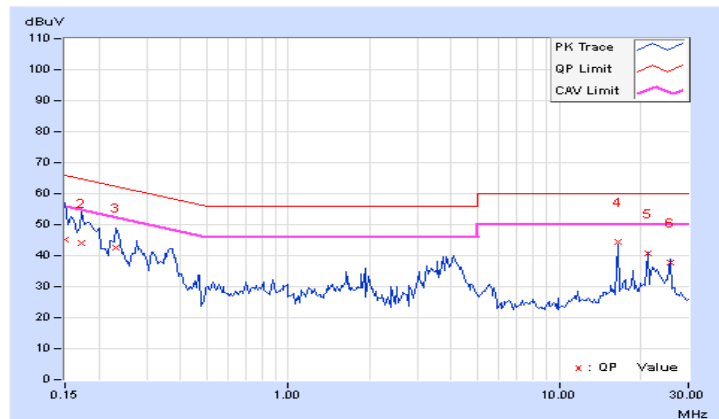

Phase	Neutral (N)	Detector Function	Quasi-Peak (QP) / Average (AV)
-------	-------------	-------------------	--------------------------------

No	Freq.	Corr.	Reading Value		Emission Level		Limit		Margin	
	[MHz]	Factor	[dB (uV)]		[dB (uV)]		[dB (uV)]		(dB)	
		(dB)	Q.P.	AV.	Q.P.	AV.	Q.P.	AV.	Q.P.	AV.
1	0.16953	10.05	32.46	15.36	42.51	25.41	64.98	54.98	-22.47	-29.57
2	0.22953	10.04	31.92	25.21	41.96	35.25	62.47	52.47	-20.51	-17.22
3	0.36484	10.09	26.33	22.71	36.42	32.80	58.62	48.62	-22.20	-15.82
4	16.46484	10.85	34.21	33.42	45.06	44.27	60.00	50.00	-14.94	-5.73
5	21.16797	11.00	28.87	28.06	39.87	39.06	60.00	50.00	-20.13	-10.94
6	25.87262	10.97	26.60	26.41	37.57	37.38	60.00	50.00	-22.43	-12.62

REMARKS:

1. Q.P. and AV. are abbreviations of quasi-peak and average individually.
2. The emission levels of other frequencies were very low against the limit.
3. Margin value = Emission level - Limit value
4. Correction factor = Insertion loss + Cable loss
5. Emission Level = Correction Factor + Reading Value.

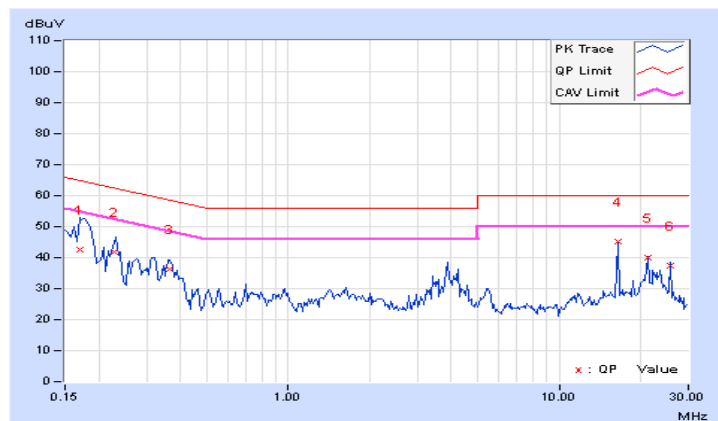

4.3 Transmit Power Measurement

4.3.1 Limits of Transmit Power Measurement

Operation Band	EUT Category		Limit
U-NII-1		Outdoor Access Point	1 Watt (30 dBm) (Max. e.i.r.p \leq 125mW(21 dBm) at any elevation angle above 30 degrees as measured from the horizon)
		Fixed point-to-point Access Point	1 Watt (30 dBm)
		Indoor Access Point	1 Watt (30 dBm)
	√	Mobile and Portable client device	250mW (24 dBm)
U-NII-2A		√	250mW (24 dBm) or 11 dBm+10 log B*
U-NII-2C		√	250mW (24 dBm) or 11 dBm+10 log B*
U-NII-3		√	1 Watt (30 dBm)

*B is the 26 dB emission bandwidth in megahertz

Per KDB 662911 Method of conducted output power measurement on IEEE 802.11 devices,

Array Gain = 0 dB (i.e., no array gain) for $N_{ANT} \leq 4$;

Array Gain = 0 dB (i.e., no array gain) for channel widths ≥ 40 MHz for any N_{ANT} ;

Array Gain = $5 \log(N_{ANT}/N_{SS})$ dB or 3 dB, whichever is less for 20-MHz channel widths with $N_{ANT} \geq 5$.

For power measurements on all other devices: Array Gain = $10 \log(N_{ANT}/N_{SS})$ dB.

4.3.2 Test Setup

FOR POWER OUTPUT MEASUREMENT

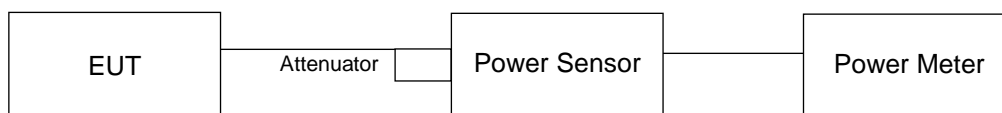

FOR 26dB OCCUPIED BANDWIDTH

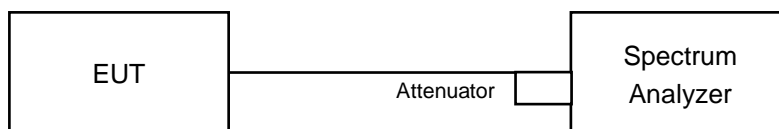

4.3.3 Test Instruments

Refer to section 4.1.2 to get information of above instrument.

4.3.4 Test Procedure

For Average Power Measurement

Method PM is used to perform output power measurement, trigger and gating function of wide band power meter is enabled to measure max output power of TX on burst. Duty factor is not added to measured value.

For 26dB Occupied Bandwidth

1. Set RBW = approximately 1% of the emission bandwidth.
2. Set the VBW > RBW.
3. Detector = Peak.
4. Trace mode = max hold.
5. Measure the maximum width of the emission that is 26 dB down from the peak of the emission. Compare this with the RBW setting of the analyzer. Readjust RBW and repeat measurement as needed until the RBW/EBW ratio is approximately 1%.

4.3.5 Deviation from Test Standard

No deviation.

4.3.6 EUT Operating Condition

The software provided by client to enable the EUT under transmission condition continuously at lowest, middle and highest channel frequencies individually.

4.3.7 Test Result

802.11a

Power Output:

Chan.	Chan. Freq. (MHz)	Maximum Conducted Power (dBm)		Total Power (mW)	Total Power (dBm)	Limit (dBm)	Pass / Fail
		Chain 0	Chain 1				
36	5180	16.44	16.79	91.808	19.63	24.00	Pass
40	5200	20.35	20.97	233.419	23.68	24.00	Pass
48	5240	19.12	19.47	170.17	22.31	24.00	Pass
52	5260	19.46	19.72	182.064	22.60	24.00	Pass
60	5300	19.48	19.89	186.215	22.70	24.00	Pass
64	5320	16.42	16.73	90.951	19.59	24.00	Pass
100	5500	16.53	17.44	100.441	20.02	24.00	Pass
116	5580	19.65	20.40	201.905	23.05	24.00	Pass
140	5700	15.99	16.96	89.378	19.51	24.00	Pass
149	5745	21.76	21.61	294.845	24.70	30.00	Pass
157	5785	21.56	21.67	290.112	24.63	30.00	Pass
165	5825	21.12	21.03	256.185	24.09	30.00	Pass

26dB OCCUPIED BANDWIDTH

Channel	Frequency (MHz)	26dBc Bandwidth (MHz)	
		Chain 0	Chain 1
52	5260	33.32	32.34
60	5300	30.63	28.75
64	5320	25.06	21.52
100	5500	22.63	24.81
116	5580	29.96	29.74
140	5700	23.70	24.53

Note: For U-NII-2A, U-NII-2C Band output power limitation is determined based on 26dBc bandwidth

Power Limit = 11dBm + 10logB < U-NII-2A, U-NII-2C >			
Channel Number	Freq.(MHz)	Min. B(MHz)	Determined Conducted Limit (dBm)
52	5260	32.34	26.09 > 24
60	5300	28.75	25.58 > 24
64	5320	21.52	24.32 > 24
100	5500	22.63	24.54 > 24
116	5580	29.74	25.73 > 24
140	5700	23.70	24.74 > 24

802.11ac (VHT20)

Power Output:

Chan.	Chan. Freq. (MHz)	Maximum Conducted Power (dBm)		Total Power (mW)	Total Power (dBm)	Limit (dBm)	Pass / Fail
		Chain 0	Chain 1				
36	5180	15.24	15.59	69.644	18.43	24.00	Pass
40	5200	19.12	19.54	171.608	22.35	24.00	Pass
48	5240	19.37	19.32	172.004	22.36	24.00	Pass
52	5260	19.22	19.17	166.164	22.21	24.00	Pass
60	5300	18.99	18.89	156.696	21.95	24.00	Pass
64	5320	16.01	16.47	84.263	19.26	24.00	Pass
100	5500	16.31	16.65	88.994	19.49	24.00	Pass
116	5580	18.98	19.12	160.726	22.06	24.00	Pass
140	5700	15.62	15.34	70.673	18.49	24.00	Pass
149	5745	21.03	21.43	265.76	24.24	30.00	Pass
157	5785	21.08	24.41	404.291	26.07	30.00	Pass
165	5825	21.09	21.03	255.294	24.07	30.00	Pass

26dB OCCUPIED BANDWIDTH

Channel	Frequency (MHz)	26dBc Bandwidth (MHz)	
		Chain 0	Chain 1
52	5260	36.87	30.70
60	5300	33.88	29.67
64	5320	24.65	20.92
100	5500	21.56	20.92
116	5580	32.83	29.47
140	5700	21.65	20.54

Note: For U-NII-2A, U-NII-2C Band output power limitation is determined based on 26dBc bandwidth

Power Limit = 11dBm + 10logB < U-NII-2A, U-NII-2C >			
Channel Number	Freq.(MHz)	Min. B(MHz)	Determined Conducted Limit (dBm)
52	5260	30.70	25.87 > 24
60	5300	29.67	25.72 > 24
64	5320	20.92	24.2 > 24
100	5500	20.92	24.2 > 24
120	5600	29.47	25.69 > 24
140	5700	20.54	24.12 > 24

802.11ac (VHT40)
Power Output:

Chan.	Chan. Freq. (MHz)	Maximum Conducted Power (dBm)		Total Power (mW)	Total Power (dBm)	Limit (dBm)	Pass / Fail
		Chain 0	Chain 1				
38	5190	13.32	13.51	43.917	16.43	24.00	Pass
46	5230	19.31	19.87	182.361	22.61	24.00	Pass
54	5270	18.93	19.06	158.701	22.01	24.00	Pass
62	5310	14.72	15.05	61.637	17.90	24.00	Pass
102	5510	12.45	12.96	37.349	15.72	24.00	Pass
110	5550	18.59	18.82	148.485	21.72	24.00	Pass
134	5670	16.95	16.72	96.534	19.85	24.00	Pass
151	5755	21.14	21.83	282.422	24.51	30.00	Pass
159	5795	21.29	21.36	271.359	24.34	30.00	Pass

26dB OCCUPIED BANDWIDTH

Channel	Frequency (MHz)	26dBc Bandwidth (MHz)	
		Chain 0	Chain 1
54	5270	73.33	67.82
62	5310	41.67	41.74
102	5510	41.48	41.58
110	5550	70.92	68.40
134	5670	66.86	42.10

Note: For U-NII-2A, U-NII-2C Band output power limitation is determined based on 26dBc bandwidth

Power Limit = 11dBm + 10logB < U-NII-2A, U-NII-2C >			
Channel Number	Freq.(MHz)	Min. B(MHz)	Determined Conducted Limit (dBm)
54	5270	67.82	29.31 > 24
62	5310	41.67	27.19 > 24
102	5510	41.48	27.17 > 24
110	5550	68.40	29.35 > 24
134	5670	42.10	27.24 > 24

802.11ac (VHT80)

Power Output:

Chan.	Chan. Freq. (MHz)	Maximum Conducted Power (dBm)		Total Power (mW)	Total Power (dBm)	Limit (dBm)	Pass / Fail
		Chain 0	Chain 1				
42	5210	12.69	13.15	39.232	15.94	24.00	Pass
58	5290	12.44	12.64	35.904	15.55	24.00	Pass
106	5530	11.03	11.25	26.012	14.15	24.00	Pass
122	5610	17.13	17.02	101.992	20.09	24.00	Pass
155	5775	18.51	18.91	148.762	21.72	30.00	Pass

26dB OCCUPIED BANDWIDTH

Channel	Frequency (MHz)	26dBc Bandwidth (MHz)	
		Chain 0	Chain 1
58	5290	82.76	82.46
106	5530	82.36	82.76
122	5610	130.14	114.01

Note: For U-NII-2A, U-NII-2C Band output power limitation is determined based on 26dBc bandwidth

Power Limit = 11dBm + 10logB < U-NII-2A, U-NII-2C >			
Channel Number	Freq.(MHz)	Min. B(MHz)	Determined Conducted Limit (dBm)
58	5290	82.46	30.16 > 24
106	5530	82.36	30.15 > 24
122	5610	114.01	31.56 > 24

Spectrum Plot of Worst Value

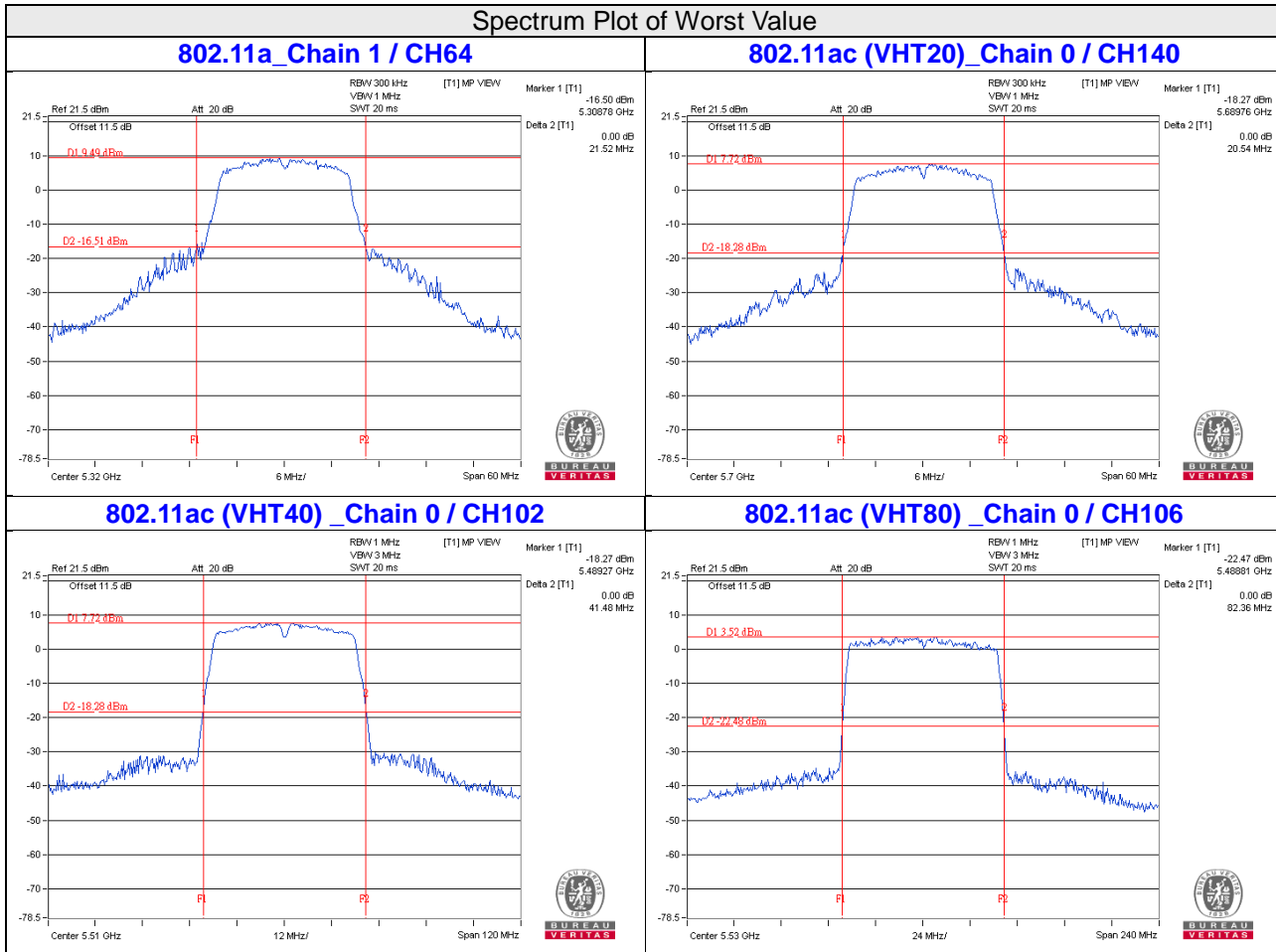

4.4 Occupied Bandwidth Measurement

4.4.1 Test Setup

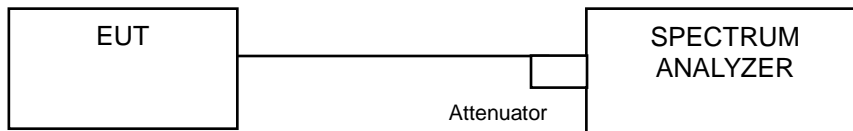

4.4.2 Test Instruments

Refer to section 4.1.2 to get information of above instrument.

4.4.3 Test Procedure

The transmitter output was connected to the spectrum analyzer through an attenuator. The bandwidth of the fundamental frequency was measured by spectrum analyzer with resolution bandwidth in the range of 1% to 5% of the anticipated emission bandwidth, and a video bandwidth at least 3x the resolution bandwidth and set the detector to SAMPLE. The width of a frequency band such that, below the lower and above the upper frequency limits, the mean powers emitted are each equal to a specified percentage 0.5 %of the total mean power of a given emission.

4.4.4 Test Results

802.11a

CHANNEL	CHANNEL FREQUENCY (MHz)	OCCUPIED BANDWIDTH (MHz)	
		CHAIN 0	CHAIN 1
36	5180	16.80	16.80
40	5200	17.52	17.40
48	5240	17.52	16.92
52	5260	17.76	16.92
60	5300	17.52	16.80
64	5320	16.68	16.68
100	5500	16.68	16.56
116	5580	17.28	16.92
140	5700	16.68	16.56
149	5745	26.16	23.76
157	5785	27.12	21.00
165	5825	26.88	21.36

802.11ac (VHT20)

CHANNEL	CHANNEL FREQUENCY (MHz)	OCCUPIED BANDWIDTH (MHz)	
		CHAIN 0	CHAIN 1
36	5180	17.76	17.76
40	5200	18.36	18.00
48	5240	18.48	18.00
52	5260	18.72	17.88
60	5300	18.24	17.76
64	5320	17.76	17.76
100	5500	17.76	17.76
116	5580	18.12	17.88
140	5700	17.76	17.64
149	5745	25.08	21.36
157	5785	27.24	22.44
165	5825	27.60	19.44

802.11ac (VHT40)

CHANNEL	CHANNEL FREQUENCY (MHz)	OCCUPIED BANDWIDTH (MHz)	
		CHAIN 0	CHAIN 1
38	5190	36.48	36.24
46	5230	36.96	36.72
54	5270	37.20	36.96
62	5310	36.24	36.24
102	5510	36.48	36.48
110	5550	37.20	36.96
134	5670	36.72	36.48
151	5755	56.16	54.24
159	5795	57.84	48.48

802.11ac (VHT80)

CHANNEL	CHANNEL FREQUENCY (MHz)	OCCUPIED BANDWIDTH (MHz)	
		CHAIN 0	CHAIN 1
42	5210	76.32	75.84
58	5290	76.32	76.32
106	5530	75.84	75.84
122	5610	76.32	76.32
155	5775	77.28	76.80

Spectrum Plot of Worst Value

802.11a_Chain 0 / CH157

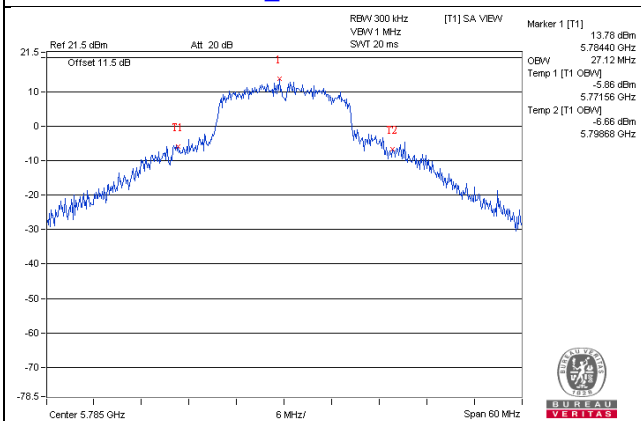

802.11ac (VHT20)_Chain 0 / CH165

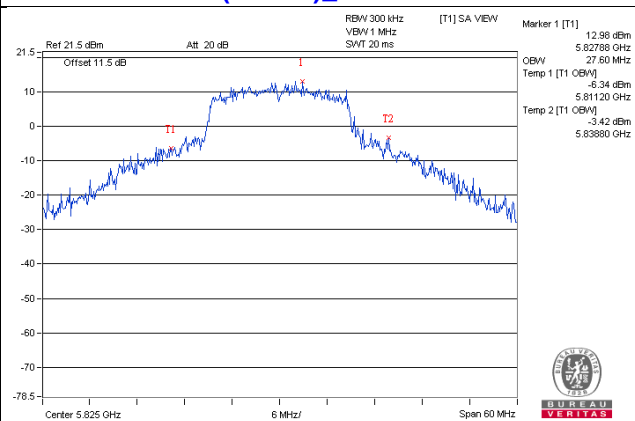

8802.11ac (VHT40)_Chain 0 / CH159

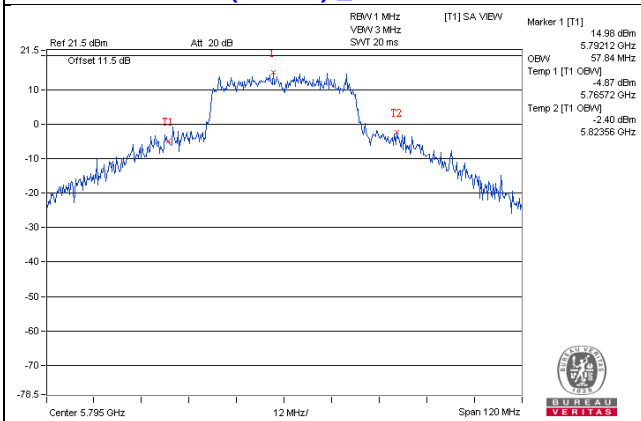

802.11ac (VHT80)_Chain 0 / CH155

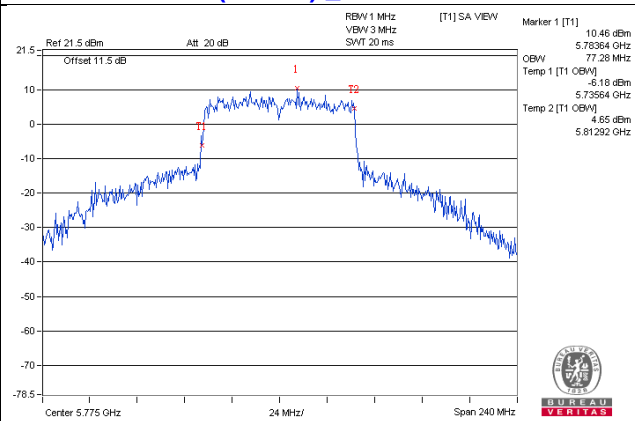

Spectrum Plot for near by DFS band (DFS is required, if 99% OCP straddle into U-NII-2A band)

802.11a / Chain 0 : CH48

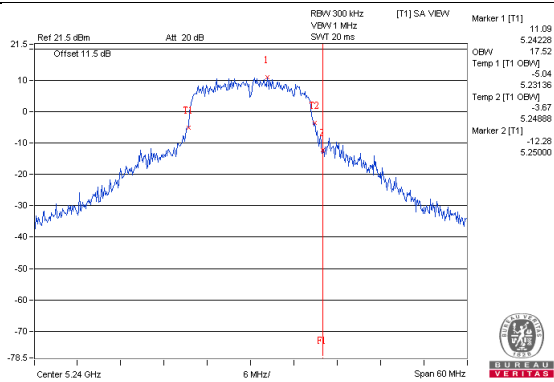

802.11a / Chain 1 : CH48

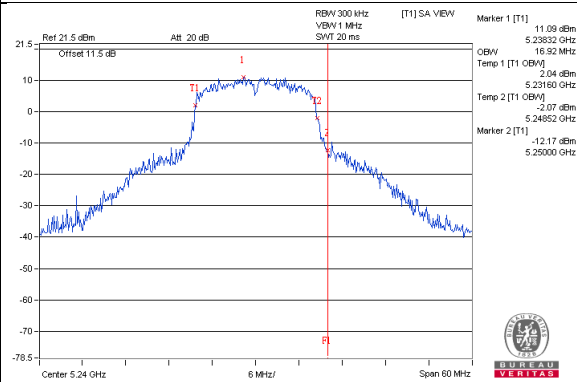

802.11ac (VHT20) / Chain 0 : CH48

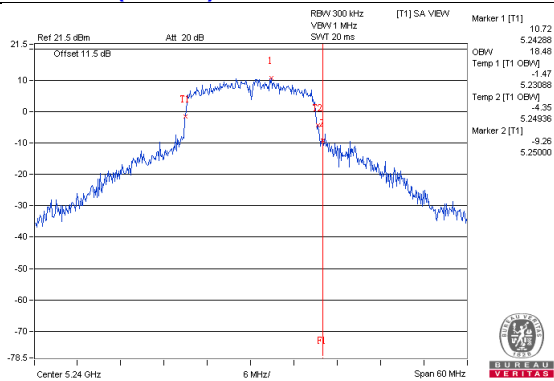

802.11ac (VHT20) / Chain 1 : CH48

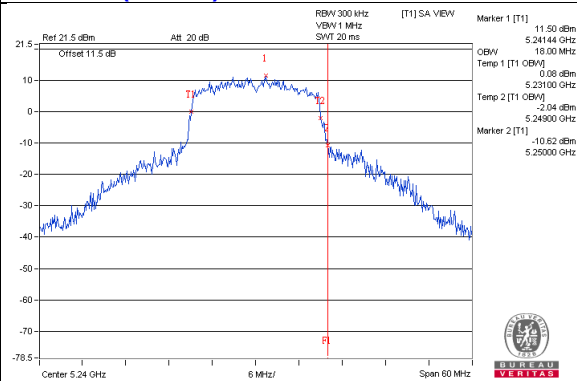

**Spectrum Plot for near by DFS band
(DFS is required, if 99% OCP straddle into U-NII-2A band)**

802.11ac (VHT40) / Chain 0 : CH46

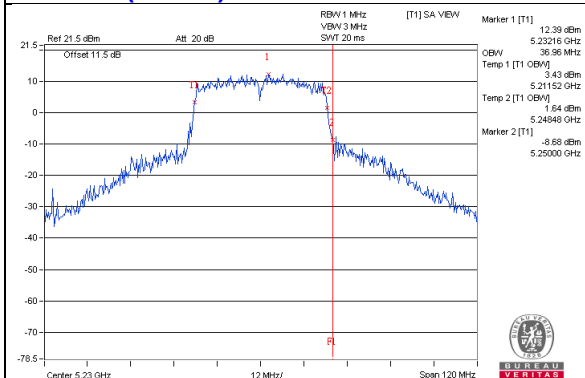

802.11ac (VHT40) / Chain 1 : CH46

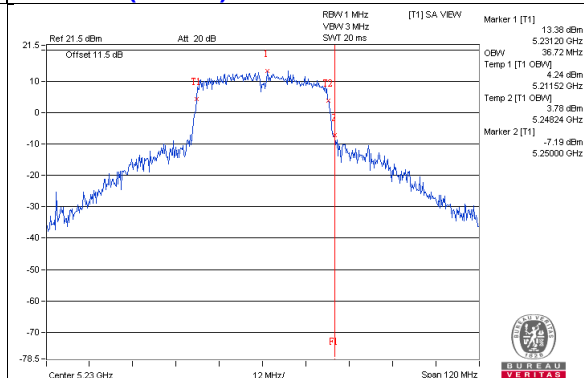

802.11ac (VHT80) / Chain 0 : CH42

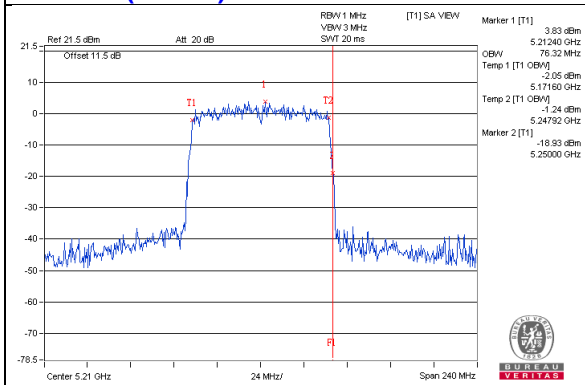

802.11ac (VHT80) / Chain 1 : CH42

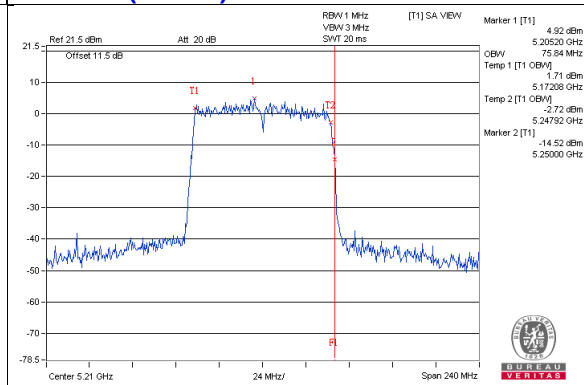

**Spectrum Plot for near by DFS band
(DFS is required, if 99% OCP straddle into U-NII-2C band)**

802.11a / Chain 0 : CH149

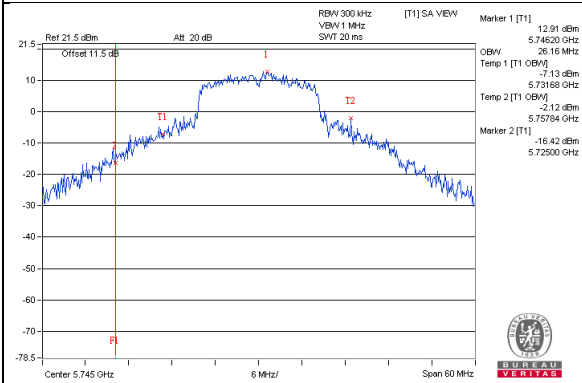

802.11a / Chain 1 : CH149

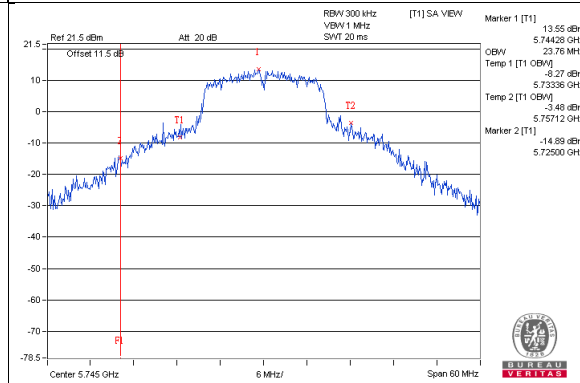

802.11ac (VHT20) / Chain 0 : CH149

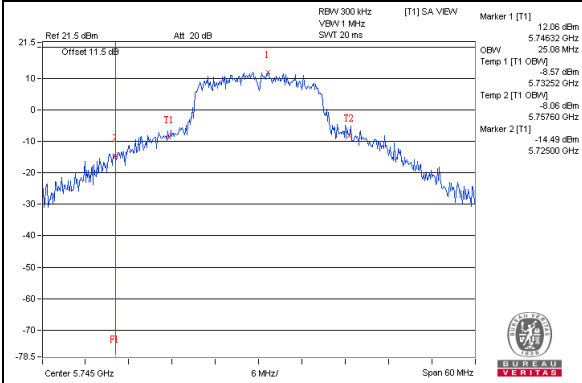

802.11ac (VHT20) / Chain 1 : CH149

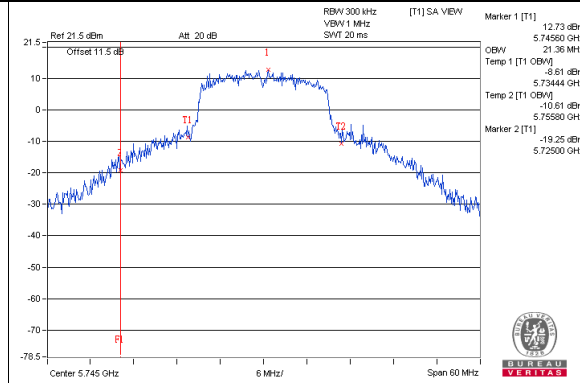

Spectrum Plot for near by DFS band (DFS is required, if 99% OCP straddle into U-NII-2C band)

802.11ac (VHT40) / Chain 0 : CH151

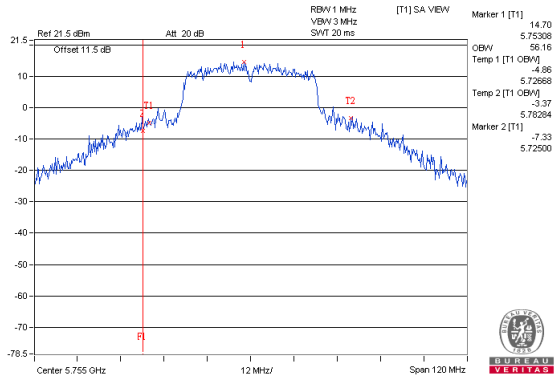

802.11ac (VHT40) / Chain 1 : CH151

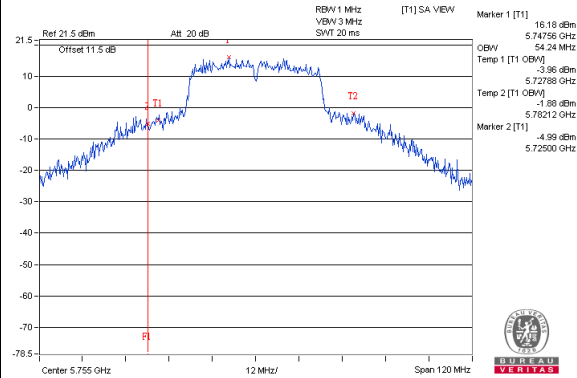

802.11ac (VHT80) / Chain 0 : CH155

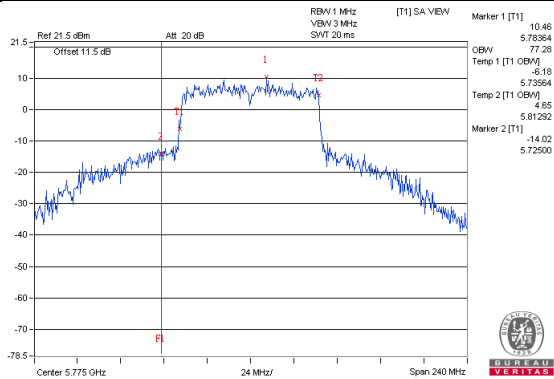

802.11ac (VHT80) / Chain 1 : CH155

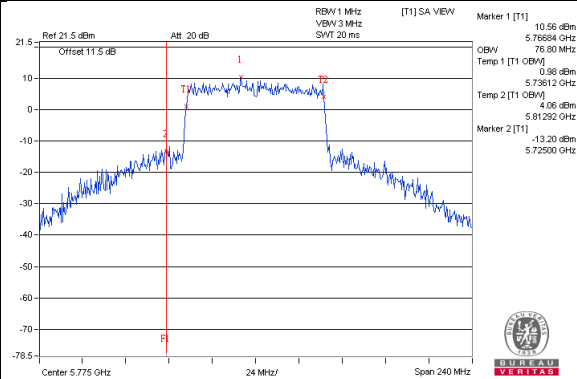

4.5 Peak Power Spectral Density Measurement

4.5.1 Limits of Peak Power Spectral Density Measurement

Operation Band	EUT Category		Limit
U-NII-1		Outdoor Access Point	17dBm/ MHz
		Fixed point-to-point Access Point	
		Indoor Access Point	
	√	Mobile and Portable client device	11dBm/ MHz
U-NII-2A		√	11dBm/ MHz
U-NII-2C		√	11dBm/ MHz
U-NII-3		√	30dBm/ 500kHz

4.5.2 Test Setup

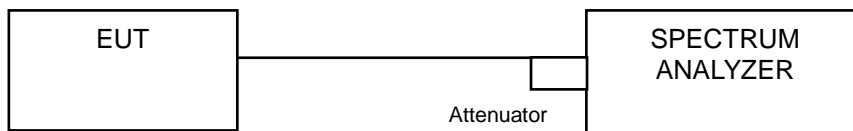

4.5.3 Test Instruments

Refer to section 4.1.2 to get information of above instrument.

4.5.4 Test Procedure

For U-NII-1, U-NII-2A, U-NII-2C:

Using method SA-2

1. Set span to encompass the entire emission bandwidth (EBW) of the signal.
2. Set RBW = 1 MHz, Set VBW ≥ 3 MHz, Detector = RMS
3. Sweep time = auto, trigger set to "free run".
4. Trace average at least 100 traces in power averaging mode.
5. Record the max value and add 10 log (1/duty cycle)

For U-NII-3:

1. Set span to encompass the entire emission bandwidth (EBW) of the signal.
2. Set RBW = 300 kHz, Set VBW ≥ 1 MHz, Detector = RMS
3. Use the peak marker function to determine the maximum power level in any 300 kHz band segment within the fundamental EBW.
4. Scale the observed power level to an equivalent value in 500 kHz by adjusting (reducing) the measured power by a bandwidth correction factor (BWCF) where $BWCF = 10\log(500\text{ kHz}/300\text{ kHz})$
5. Sweep time = auto, trigger set to "free run".
6. Trace average at least 100 traces in power averaging mode.
7. Record the max value and add 10 log (1/duty cycle)

4.5.5 Deviation from Test Standard

No deviation.

4.5.6 EUT Operating Condition

Same as Item 4.3.6.

4.5.7 Test Results

802.11a

Chan.	Chan. Freq. (MHz)	PSD W/O Duty Factor (dBm/MHz)		Duty Factor (dB)	Total PSD With Duty Factor (dBm/MHz)	MAX. Limit (dBm/MHz)	Pass / Fail
		Chain 0	Chain 1				
36	5180	4.67	5.03	0.11	7.98	11.00	Pass
40	5200	7.49	8.08	0.11	10.92	11.00	Pass
48	5240	7.34	7.40	0.11	10.49	11.00	Pass
52	5260	7.43	7.72	0.11	10.70	11.00	Pass
60	5300	7.18	8.03	0.11	10.75	11.00	Pass
64	5320	4.82	4.91	0.11	7.99	11.00	Pass
100	5500	4.37	5.77	0.11	8.25	11.00	Pass
116	5580	6.85	7.52	0.11	10.32	11.00	Pass
140	5700	4.04	5.29	0.11	7.83	11.00	Pass

- Note:**
- Method a) of power density measurement of KDB 662911 is using for calculating total power density. Total power density is summing entire spectra across corresponding frequency bins on the various outputs by computer.
 - UNII-1: Directional gain = $10 \log[(10^{G1/20} + 10^{G2/20})^2 / 2] = 4.95\text{dBi} < 6\text{dBi}$, so the power density limit shall not be reduced.
 - UNII-2A: Directional gain = $10 \log[(10^{G1/20} + 10^{G2/20})^2 / 2] = 5.51\text{dBi} < 6\text{dBi}$, so the power density limit shall not be reduced.
 - UNII-2C: Directional gain = $10 \log[(10^{G1/20} + 10^{G2/20})^2 / 2] = 5.11\text{dBi} < 6\text{dBi}$, so the power density limit shall not be reduced.
 - Refer to section 3.3 for duty cycle spectrum plot.

802.11ac (VHT20)

Chan.	Chan. Freq. (MHz)	PSD W/O Duty Factor (dBm/MHz)		Duty Factor (dB)	Total PSD With Duty Factor (dBm/MHz)	MAX. Limit (dBm/MHz)	Pass / Fail
		Chain 0	Chain 1				
36	5180	2.65	3.17	0.18	6.10	11.00	Pass
40	5200	6.85	7.16	0.18	10.19	11.00	Pass
48	5240	7.10	7.26	0.18	10.37	11.00	Pass
52	5260	7.03	6.86	0.18	10.13	11.00	Pass
60	5300	6.92	6.61	0.18	9.95	11.00	Pass
64	5320	3.74	4.23	0.18	7.18	11.00	Pass
100	5500	4.01	4.39	0.18	7.39	11.00	Pass
116	5580	6.61	6.77	0.18	9.88	11.00	Pass
140	5700	3.38	2.88	0.18	6.32	11.00	Pass

- Note:**
- Method a) of power density measurement of KDB 662911 is using for calculating total power density. Total power density is summing entire spectra across corresponding frequency bins on the various outputs by computer.
 - UNII-1: Directional gain = $10 \log[(10^{G1/20} + 10^{G2/20})^2 / 2] = 4.95\text{dBi} < 6\text{dBi}$, so the power density limit shall not be reduced.
 - UNII-2A: Directional gain = $10 \log[(10^{G1/20} + 10^{G2/20})^2 / 2] = 5.51\text{dBi} < 6\text{dBi}$, so the power density limit shall not be reduced.
 - UNII-2C: Directional gain = $10 \log[(10^{G1/20} + 10^{G2/20})^2 / 2] = 5.11\text{dBi} < 6\text{dBi}$, so the power density limit shall not be reduced.
 - Refer to section 3.3 for duty cycle spectrum plot.

802.11ac (VHT40)

Chan.	Chan. Freq. (MHz)	PSD W/O Duty Factor (dBm/MHz)		Duty Factor (dB)	Total PSD With Duty Factor (dBm/MHz)	MAX. Limit (dBm/MHz)	Pass / Fail
		Chain 0	Chain 1				
38	5190	-2.12	-2.40	0.23	0.99	11.00	Pass
46	5230	2.75	3.78	0.23	6.54	11.00	Pass
54	5270	2.89	3.31	0.23	6.35	11.00	Pass
62	5310	-0.49	-0.89	0.23	2.56	11.00	Pass
102	5510	-3.16	-2.50	0.23	0.43	11.00	Pass
110	5550	3.23	3.35	0.23	6.53	11.00	Pass
134	5670	1.34	1.00	0.23	4.42	11.00	Pass

- Note:**
- Method a) of power density measurement of KDB 662911 is using for calculating total power density. Total power density is summing entire spectra across corresponding frequency bins on the various outputs by computer.
 - UNII-1: Directional gain = $10 \log[(10^{G1/20} + 10^{G2/20})^2 / 2] = 4.95\text{dBi} < 6\text{dBi}$, so the power density limit shall not be reduced.
 - UNII-2A: Directional gain = $10 \log[(10^{G1/20} + 10^{G2/20})^2 / 2] = 5.51\text{dBi} < 6\text{dBi}$, so the power density limit shall not be reduced.
 - UNII-2C: Directional gain = $10 \log[(10^{G1/20} + 10^{G2/20})^2 / 2] = 5.11\text{dBi} < 6\text{dBi}$, so the power density limit shall not be reduced.
 - Refer to section 3.3 for duty cycle spectrum plot.

802.11ac (VHT80)

Chan.	Chan. Freq. (MHz)	PSD W/O Duty Factor (dBm/MHz)		Duty Factor (dB)	Total PSD With Duty Factor (dBm/MHz)	MAX. Limit (dBm/MHz)	Pass / Fail
		Chain 0	Chain 1				
42	5210	-8.71	-6.23	0.46	-3.83	11.00	Pass
58	5290	-6.99	-8.10	0.46	-4.04	11.00	Pass
106	5530	-8.54	-10.07	0.46	-5.77	11.00	Pass
122	5610	-3.42	-2.99	0.46	0.27	11.00	Pass

- Note:**
- Method a) of power density measurement of KDB 662911 is using for calculating total power density. Total power density is summing entire spectra across corresponding frequency bins on the various outputs by computer.
 - UNII-1: Directional gain = $10 \log[(10^{G1/20} + 10^{G2/20})^2 / 2] = 4.95\text{dBi} < 6\text{dBi}$, so the power density limit shall not be reduced.
 - UNII-2A: Directional gain = $10 \log[(10^{G1/20} + 10^{G2/20})^2 / 2] = 5.51\text{dBi} < 6\text{dBi}$, so the power density limit shall not be reduced.
 - UNII-2C: Directional gain = $10 \log[(10^{G1/20} + 10^{G2/20})^2 / 2] = 5.11\text{dBi} < 6\text{dBi}$, so the power density limit shall not be reduced.
 - Refer to section 3.3 for duty cycle spectrum plot.

Spectrum Plot of Worst Value

802.11a_Chain 1 / CH40

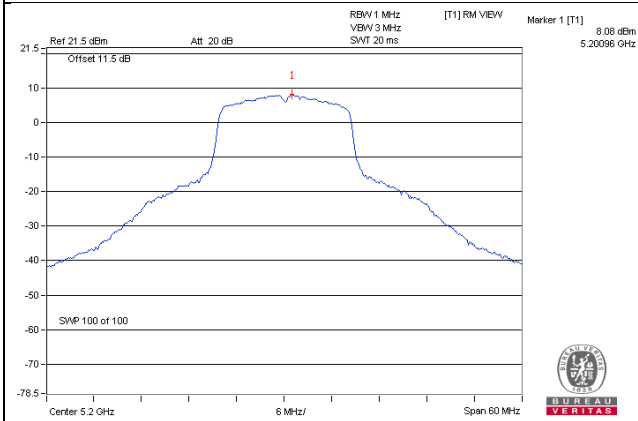

802.11ac (VHT20)_Chain 1 / CH48

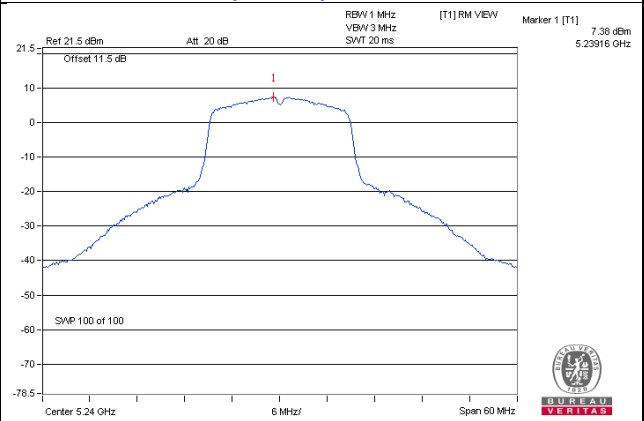

802.11ac (VHT40)_Chain 1 / CH46

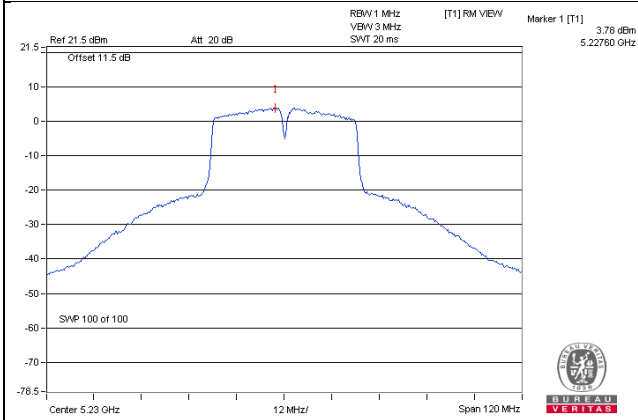

802.11ac (VHT80)_Chain 1 / CH122

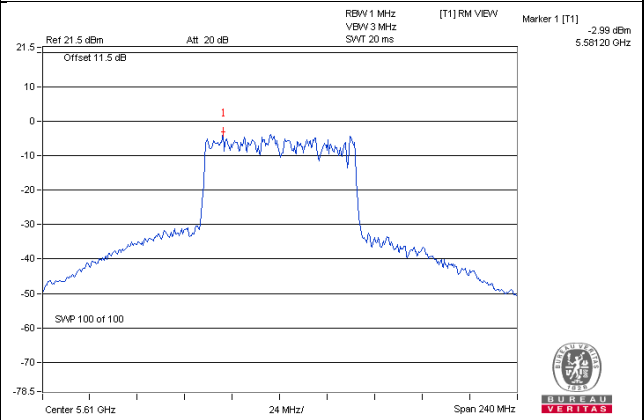

For U-NII-3:

802.11a

TX chain	Chan.	Chan. Freq. (MHz)	PSD W/O Duty Factor		10 log (N=2) dB	Duty Factor (dB)	Total PSD With Duty Factor (dBm/500kHz)	Limit (dBm/500kHz)	Pass /Fail
			(dBm/300kHz)	(dBm/500kHz)					
0	149	5745	0.92	3.14	3.01	0.11	6.26	30.00	Pass
	157	5785	1.05	3.27	3.01	0.11	6.39	30.00	Pass
	165	5825	1.10	3.32	3.01	0.11	6.44	30.00	Pass
1	149	5745	1.90	4.12	3.01	0.11	7.24	30.00	Pass
	157	5785	1.24	3.46	3.01	0.11	6.58	30.00	Pass
	165	5825	1.58	3.80	3.01	0.11	6.92	30.00	Pass

Note: 1. Directional gain = $10 \log[(10^{G1/20} + 10^{G2/20})^2 / 2] = 4.81 \text{dBi} < 6 \text{dBi}$, so the power density limit shall not be reduced..

2. Refer to section 3.3 for duty cycle spectrum plot.

802.11ac (VHT20)

TX chain	Chan.	Chan. Freq. (MHz)	PSD W/O Duty Factor		10 log (N=2) dB	Duty Factor (dB)	Total PSD With Duty Factor (dBm/500kHz)	Limit (dBm/500kHz)	Pass /Fail
			(dBm/300kHz)	(dBm/500kHz)					
0	149	5745	0.40	2.62	3.01	0.18	5.81	30.00	Pass
	157	5785	0.56	2.78	3.01	0.18	5.97	30.00	Pass
	165	5825	0.69	2.91	3.01	0.18	6.10	30.00	Pass
1	149	5745	1.03	3.25	3.01	0.18	6.44	30.00	Pass
	157	5785	0.98	3.20	3.01	0.18	6.39	30.00	Pass
	165	5825	0.52	2.74	3.01	0.18	5.93	30.00	Pass

Note: 1. Directional gain = $10 \log[(10^{G1/20} + 10^{G2/20})^2 / 2] = 4.81 \text{dBi} < 6 \text{dBi}$, so the power density limit shall not be reduced..

2. Refer to section 3.3 for duty cycle spectrum plot.

802.11ac (VHT40)

TX chain	Chan.	Chan. Freq. (MHz)	PSD W/O Duty Factor		10 log (N=2) dB	Duty Factor (dB)	Total PSD With Duty Factor (dBm/500kHz)	Limit (dBm/500kHz)	Pass /Fail
			(dBm/300kHz)	(dBm/500kHz)					
0	151	5755	-3.15	-0.93	3.01	0.23	2.31	30.00	Pass
	159	5795	-3.44	-1.22	3.01	0.23	2.02	30.00	Pass
1	151	5755	-2.49	-0.27	3.01	0.23	2.97	30.00	Pass
	159	5795	-2.66	-0.44	3.01	0.23	2.80	30.00	Pass

Note: 1. Directional gain = $10 \log[(10^{G1/20} + 10^{G2/20})^2 / 2] = 4.81 \text{dBi} < 6 \text{dBi}$, so the power density limit shall not be reduced..

2. Refer to section 3.3 for duty cycle spectrum plot.

802.11ac (VHT80)

TX chain	Chan.	Chan. Freq. (MHz)	PSD W/O Duty Factor		10 log (N=2) dB	Duty Factor (dB)	Total PSD With Duty Factor (dBm/500kHz)	Limit (dBm/500kHz)	Pass /Fail
			(dBm/300kHz)	(dBm/500kHz)					
0	155	5775	-9.54	-7.32	3.01	0.46	-3.85	30.00	Pass
1	155	5775	-8.86	-6.64	3.01	0.46	-3.17	30.00	Pass

Note: 1. Directional gain = $10 \log[(10^{G1/20} + 10^{G2/20})^2 / 2] = 4.81 \text{dBi} < 6 \text{dBi}$, so the power density limit shall not be reduced..

2. Refer to section 3.3 for duty cycle spectrum plot.

Spectrum Plot of Worst Value

802.11a – Chain 1: CH 149

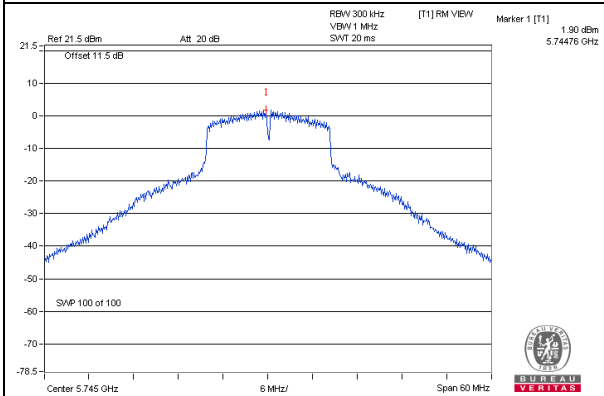

802.11ac (VHT20) – Chain 1: CH 149

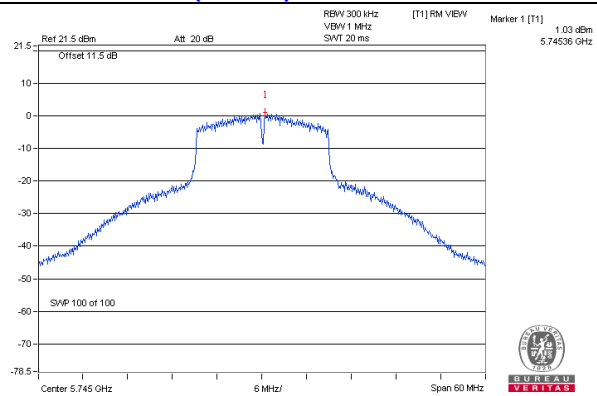

802.11ac (VHT40) – Chain 1: CH 151

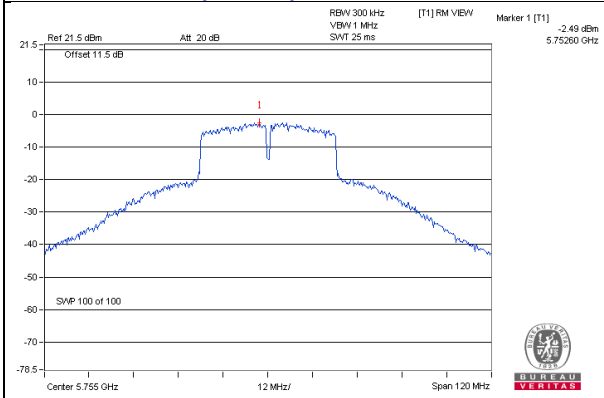

802.11ac (VHT80) – Chain 1: CH 155

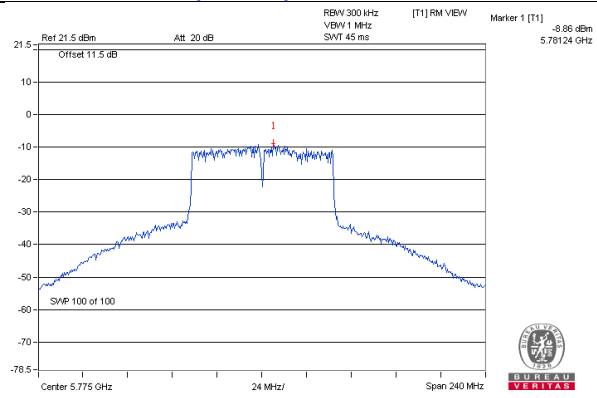

4.6 Frequency Stability Measurement

4.6.1 Limits of Frequency Stability Measurement

The frequency of the carrier signal shall be maintained within band of operation

4.6.2 Test Setup

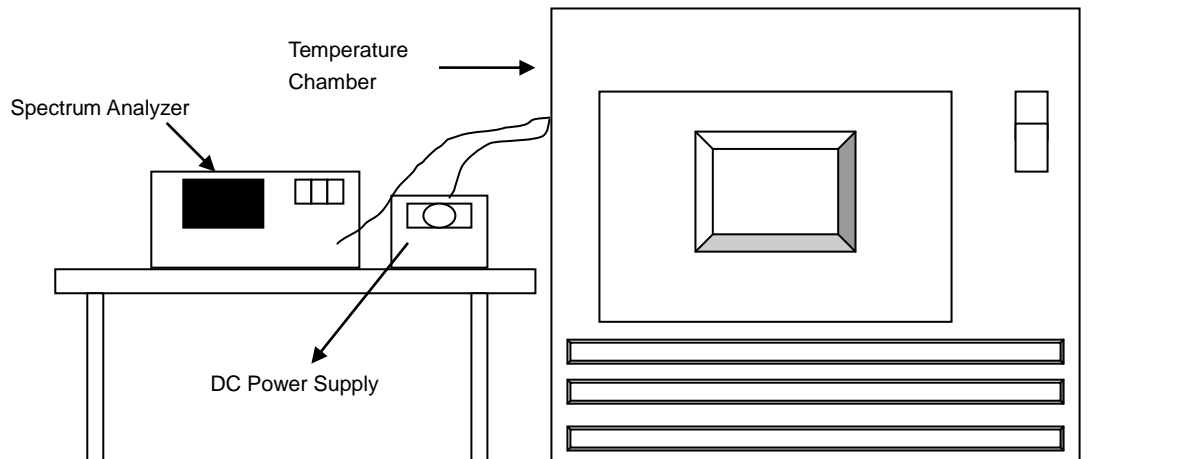

4.6.3 Test Instruments

Refer to section 4.1.2 to get information of above instrument.

4.6.4 Test Procedure

- The EUT was placed inside the environmental test chamber and powered by nominal DC voltage.
- Turn the EUT on and couple its output to a spectrum analyzer.
- Turn the EUT off and set the chamber to the highest temperature specified.
- Allow sufficient time (approximately 30 min) for the temperature of the chamber to stabilize, turn the EUT on and measure the operating frequency after 2, 5, and 10 Minutes.
- Repeat step 2 and 3 with the temperature chamber set to the lowest temperature.
- The test chamber was allowed to stabilize at +20 degree C for a minimum of 30 Minutes. The supply voltage was then adjusted on the EUT from 85% to 115% and the frequency record.

4.6.5 Deviation from Test Standard

No deviation.

4.6.6 EUT Operating Condition

Set the EUT transmit at un-modulation mode to test frequency stability.

4.6.7 Test Results

Frequency Stability Versus Temp.									
Operating Frequency: 5180 MHz									
TEMP. (°C)	Power Supply (Vdc)	0 Minute		2 Minute		5 Minute		10 Minute	
		Measured Frequency (MHz)	Pass/Fail	Measured Frequency (MHz)	Pass/Fail	Measured Frequency (MHz)	Pass/Fail	Measured Frequency (MHz)	Pass/Fail
50	3.3	5180.0238	PASS	5180.0219	PASS	5180.0216	PASS	5180.0233	PASS
40	3.3	5179.9904	PASS	5179.9926	PASS	5179.9928	PASS	5179.9923	PASS
30	3.3	5179.9751	PASS	5179.9757	PASS	5179.9751	PASS	5179.9737	PASS
20	3.3	5179.994	PASS	5179.9943	PASS	5179.9956	PASS	5179.9924	PASS
10	3.3	5180.0043	PASS	5180.0033	PASS	5180.0031	PASS	5180.0012	PASS
0	3.3	5180.007	PASS	5180.0064	PASS	5180.0067	PASS	5180.0052	PASS
-10	3.3	5180.0109	PASS	5180.0155	PASS	5180.0157	PASS	5180.0158	PASS
-20	3.3	5179.9744	PASS	5179.9736	PASS	5179.9764	PASS	5179.9736	PASS
-30	3.3	5179.9866	PASS	5179.9873	PASS	5179.987	PASS	5179.9857	PASS

Frequency Stability Versus Voltage									
Operating Frequency: 5180 MHz									
TEMP. (°C)	Power Supply (Vdc)	0 Minute		2 Minute		5 Minute		10 Minute	
		Measured Frequency (MHz)	Pass/Fail	Measured Frequency (MHz)	Pass/Fail	Measured Frequency (MHz)	Pass/Fail	Measured Frequency (MHz)	Pass/Fail
20	3.795	5179.9939	PASS	5179.995	PASS	5179.9953	PASS	5179.9934	PASS
	3.3	5179.994	PASS	5179.9943	PASS	5179.9956	PASS	5179.9924	PASS
	2.805	5179.9932	PASS	5179.9937	PASS	5179.9954	PASS	5179.9923	PASS

4.7 6dB Bandwidth Measurement

4.7.1 Limits of 6dB Bandwidth Measurement

The minimum of 6dB Bandwidth Measurement is 0.5MHz.

4.7.2 Test Setup

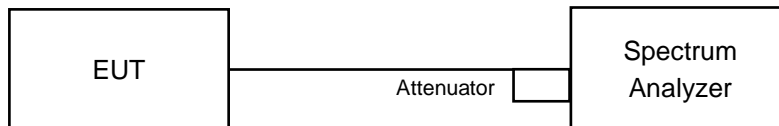

4.7.3 Test Instruments

Refer to section 4.1.2 to get information of above instrument.

4.7.4 Test Procedure

MEASUREMENT PROCEDURE REF

- a. Set resolution bandwidth (RBW) = 100kHz
- b. Set the video bandwidth (VBW) $\geq 3 \times$ RBW, Detector = Peak.
- c. Trace mode = max hold.
- d. Sweep = auto couple.
- e. Measure the maximum width of the emission that is constrained by the frequencies associated with the two amplitude points (upper and lower) that are attenuated by 6 dB relative to the maximum level measured in the fundamental emission

4.7.5 Deviation from Test Standard

No deviation.

4.7.6 EUT Operating Condition

The software provided by client to enable the EUT under transmission condition continuously at lowest, middle and highest channel frequencies individually.

4.7.7 Test Results

802.11a

Channel	Frequency (MHz)	6dB Bandwidth (MHz)		Minimum Limit (MHz)	Pass / Fail
		Chain 0	Chain 1		
149	5745	15.19	15.22	0.5	PASS
157	5785	15.20	15.20	0.5	PASS
165	5825	15.17	15.16	0.5	PASS

802.11ac (VHT20)

Channel	Frequency (MHz)	6dB Bandwidth (MHz)		Minimum Limit (MHz)	Pass / Fail
		Chain 0	Chain 1		
149	5745	15.18	15.22	0.5	PASS
157	5785	15.47	15.22	0.5	PASS
165	5825	15.44	15.18	0.5	PASS

802.11ac (VHT40)

Channel	Frequency (MHz)	6dB Bandwidth (MHz)		Minimum Limit (MHz)	Pass / Fail
		Chain 0	Chain 1		
151	5755	35.15	35.18	0.5	PASS
159	5795	35.16	35.19	0.5	PASS

802.11ac (VHT80)

Channel	Frequency (MHz)	6dB Bandwidth (MHz)		Minimum Limit (MHz)	Pass / Fail
		Chain 0	Chain 1		
155	5775	75.73	75.75	0.5	PASS

Spectrum Plot of Worst Value

802.11a_Chain 1 / CH165

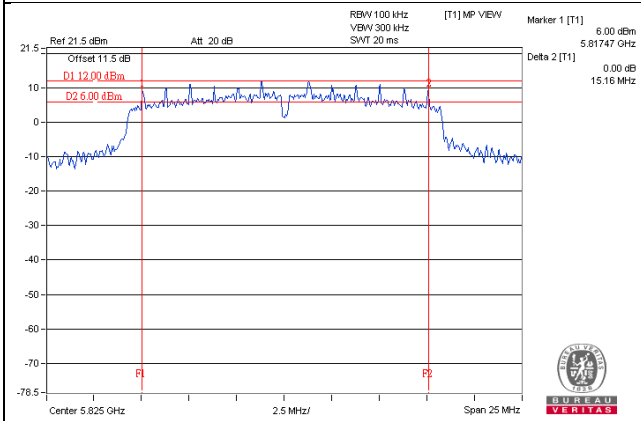

802.11ac (VHT20)_Chain 0 / CH149

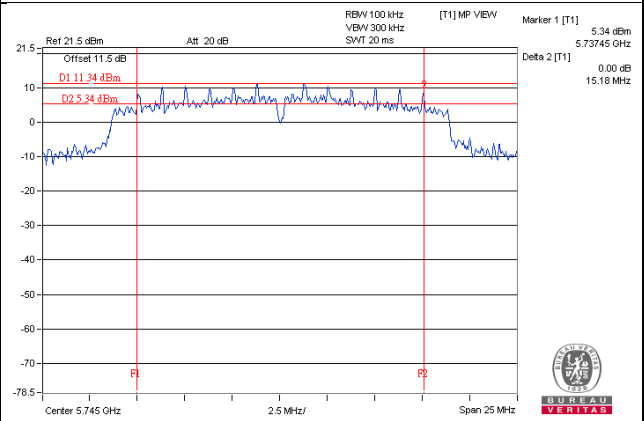

802.11ac (VHT40)_Chain 0 / CH151

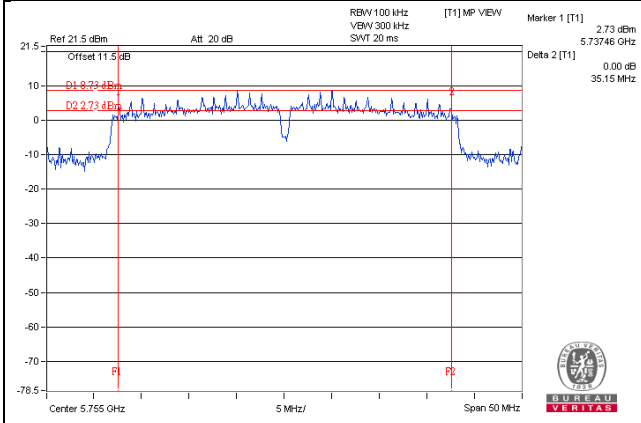

802.11ac (VHT80)_Chain 0 / CH155

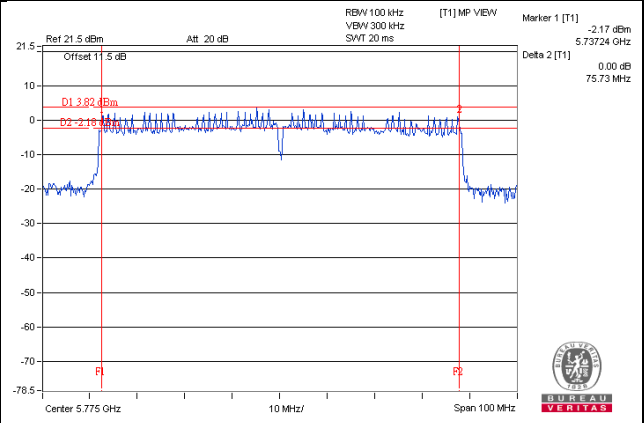

5 Pictures of Test Arrangements

Please refer to the attached file (Test Setup Photo).

Annex A- Radiated Out of Band Emission (OOBE) Measurement (For U-NII-3 band)

802.11a

CH 149 5745 MHz

Horizontal

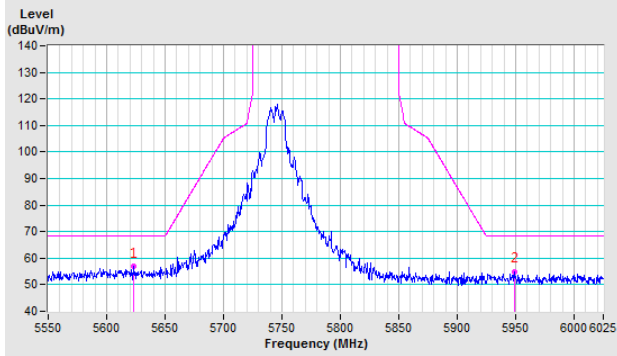

Vertical

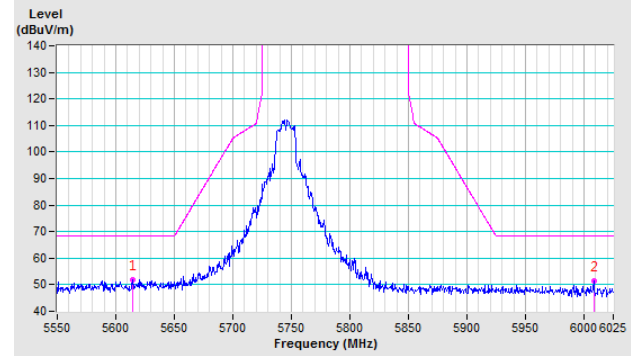

CH 157 5785 MHz

Horizontal

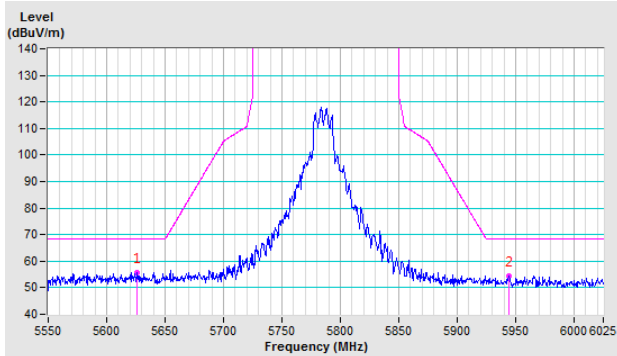

Vertical

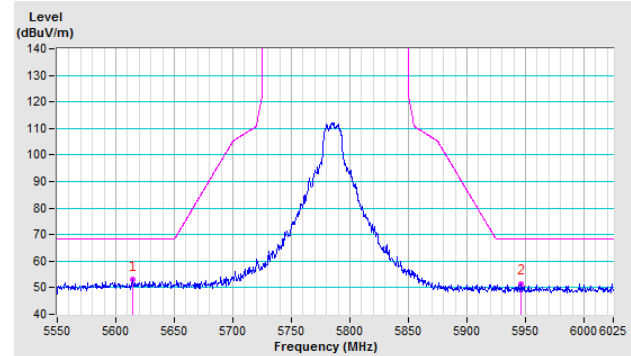

CH 165 5825 MHz

Horizontal

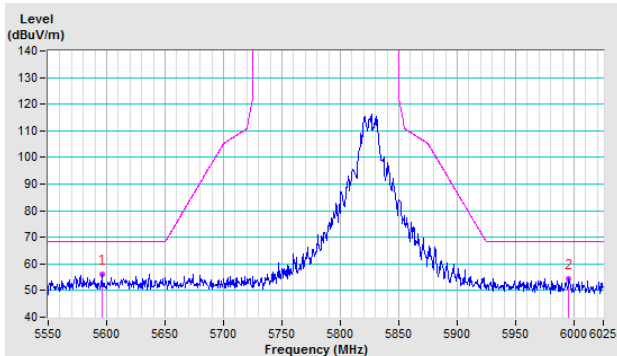

Vertical

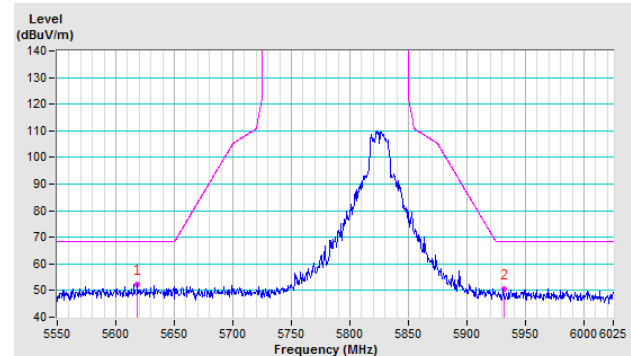

802.11ac (VHT20)

CH 149 5745 MHz

Horizontal

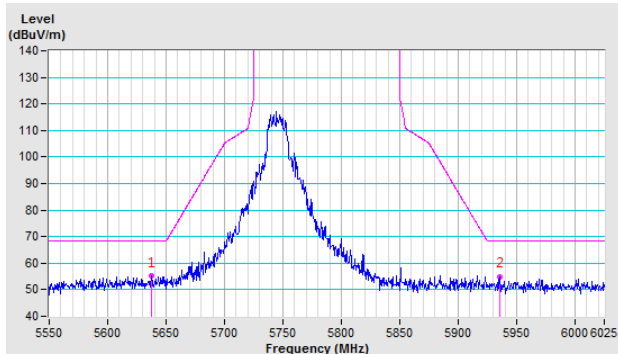

Vertical

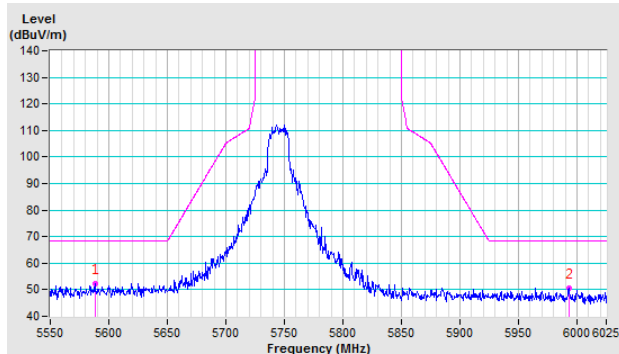

CH 157 5785 MHz

Horizontal

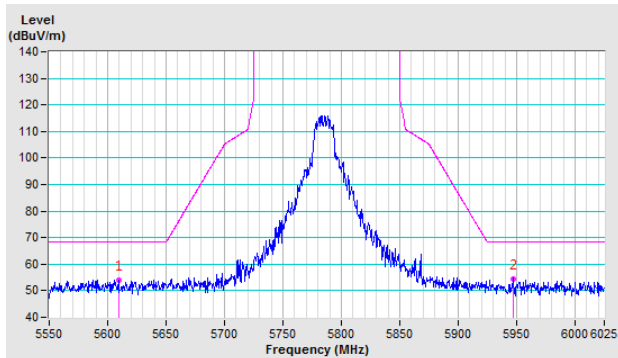

Vertical

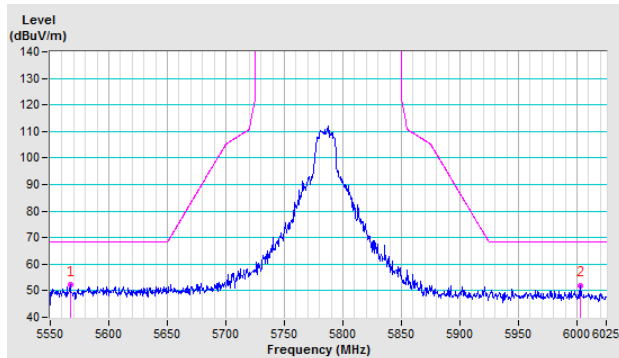

CH 165 5825 MHz

Horizontal

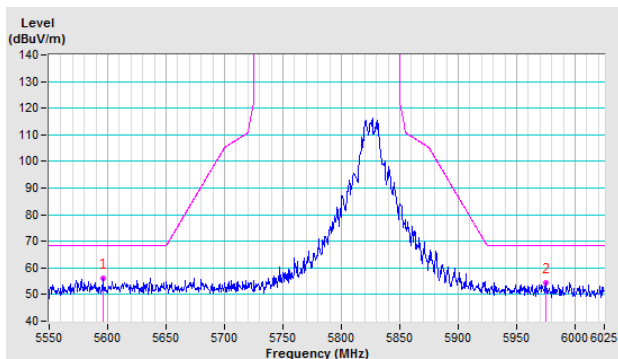

Vertical

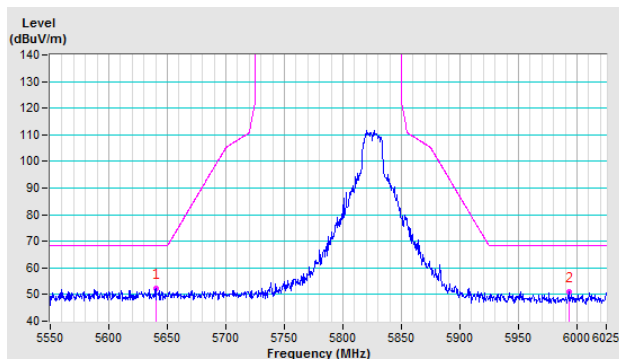

802.11ac (VHT40)

CH 151 5755 MHz

Horizontal

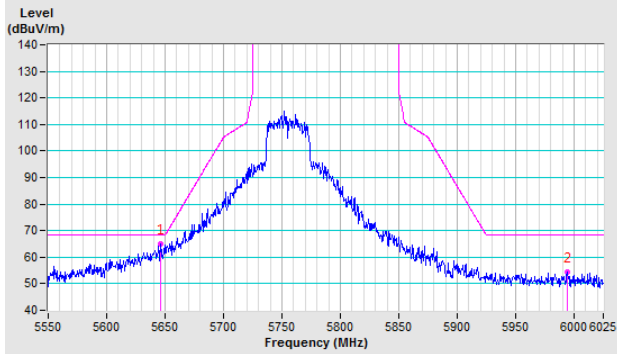

Vertical

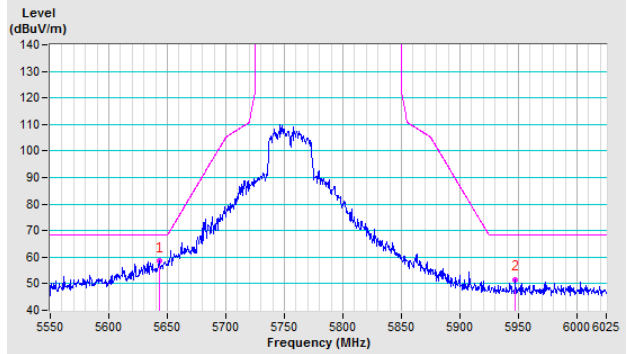

CH 159 5795 MHz

Horizontal

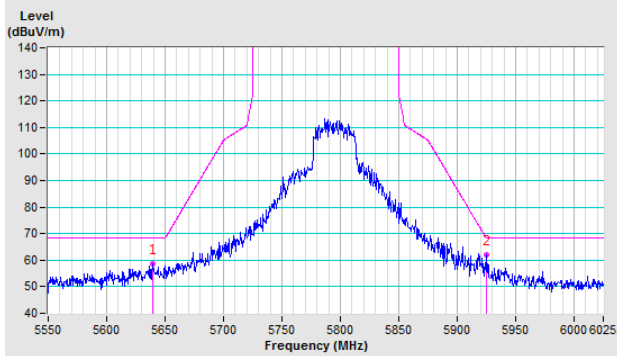

Vertical

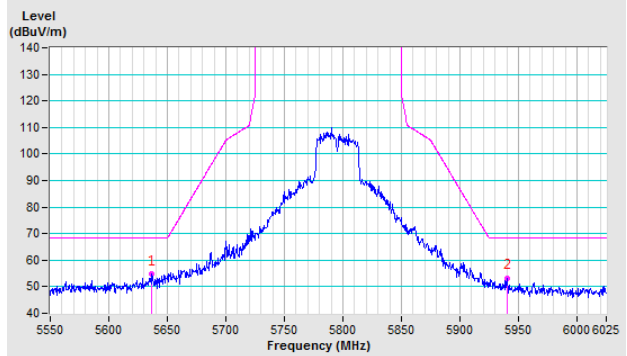

802.11ac (VHT80)

CH 155 5775 MHz

Horizontal

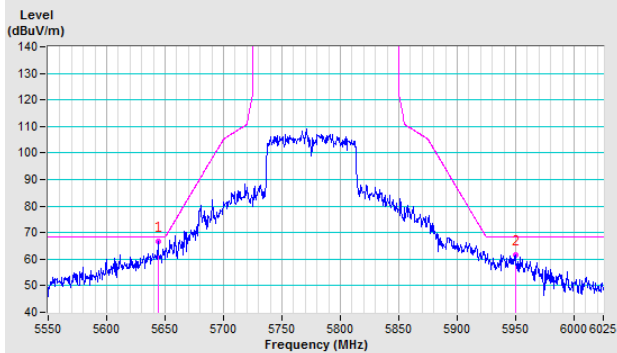

Vertical

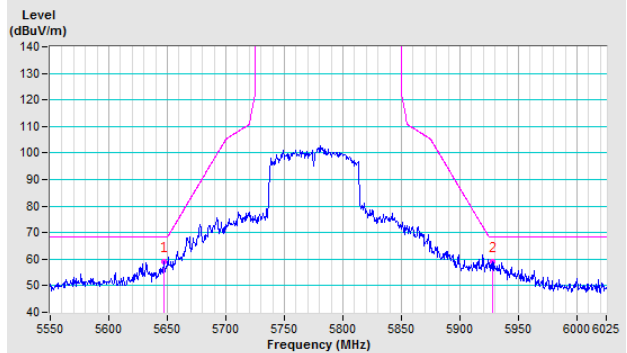

Appendix – Information on the Testing Laboratories

We, Bureau Veritas Consumer Products Services (H.K.) Ltd., Taoyuan Branch, were founded in 1988 to provide our best service in EMC, Radio, Telecom and Safety consultation. Our laboratories are FCC recognized accredited test firms and accredited according to ISO/IEC 17025.

If you have any comments, please feel free to contact us at the following:

Linko EMC/RF Lab

Tel: 886-2-26052180

Fax: 886-2-26051924

Hsin Chu EMC/RF/Telecom Lab

Tel: 886-3-6668565

Fax: 886-3-6668323

Hwa Ya EMC/RF/Safety Lab

Tel: 886-3-3183232

Fax: 886-3-3270892

Email: service.adt@tw.bureauveritas.com

Web Site: www.bureauveritas-adt.com

The address and road map of all our labs can be found in our web site also.

--- END ---