



FCC TEST REPORT (WLAN 15.407)

REPORT NO.: RF140515E03-1 R1

MODEL NO.: J20H084ac, J20H084

FCC ID: AK8J20H084AC

RECEIVED: May 15, 2014

TESTED: May 16 to June 13, 2014

ISSUED: July 29, 2014

APPLICANT: Sony Corporation

ADDRESS: 1-7-1 Konan Minato-ku Tokyo, 108-0075
Japan

ISSUED BY: Bureau Veritas Consumer Products Services
(H.K.) Ltd., Taoyuan Branch Hsin Chu Laboratory

LAB ADDRESS : No. 81-1, Lu Liao Keng, 9th Ling, Wu Lung Tsuen,
Chiung Lin Hsiang, Hsin Chu Hsien 307, Taiwan,
R.O.C.

TEST LOCATION (1): No. 81-1, Lu Liao Keng, 9th Ling, Wu Lung Tsuen,
Chiung Lin Hsiang, Hsin Chu Hsien 307, Taiwan,
R.O.C.

TEST LOCATION (2): No. 49, Ln. 206, Wende Rd., Shangshan Tsuen,
Chiung Lin Hsiang, Hsin Chu Hsien 307, Taiwan,
R.O.C.

This report should not be used by the client to claim product certification, approval, or endorsement by TAF or any government agencies.



This report is for your exclusive use. Any copying or replication of this report to or for any other person or entity, or use of our name or trademark, is permitted only with our prior written permission. This report sets forth our findings solely with respect to the test samples identified herein. The results set forth in this report are not indicative or representative of the quality or characteristics of the lot from which a test sample was taken or any similar or identical product unless specifically and expressly noted. Our report includes all of the tests requested by you and the results thereof based upon the information that you provided to us. You have 60 days from date of issuance of this report to notify us of any material error or omission caused by our negligence, provided, however, that such notice shall be in writing and shall specifically address the issue you wish to raise. A failure to raise such issue within the prescribed time shall constitute your unqualified acceptance of the completeness of this report, the tests conducted and the correctness of the report contents. Unless specific mention, the uncertainty of measurement has been explicitly taken into account to declare the compliance or non-compliance to the specification



A D T

Table of Contents

RELEASE CONTROL RECORD	4
1. CERTIFICATION	5
2. SUMMARY OF TEST RESULTS	6
2.1 MEASUREMENT UNCERTAINTY	7
3. GENERAL INFORMATION.....	8
3.1 GENERAL DESCRIPTION OF EUT (WLAN)	8
3.2 DESCRIPTION OF TEST MODES	23
3.2.1 TEST MODE APPLICABILITY AND TESTED CHANNEL DETAIL	25
3.3 GENERAL DESCRIPTION OF APPLIED STANDARDS	28
3.4 DUTY CYCLE OF TEST SIGNAL.....	29
3.5 DESCRIPTION OF SUPPORT UNITS	30
3.6 CONFIGURATION OF SYSTEM UNDER TEST	30
4. TEST TYPES AND RESULTS	31
4.1 CONDUCTED EMISSION MEASUREMENT	31
4.1.1 LIMITS OF CONDUCTED EMISSION MEASUREMENT.....	31
4.1.2 TEST INSTRUMENTS	31
4.1.3 TEST PROCEDURES	32
4.1.4 DEVIATION FROM TEST STANDARD	32
4.1.5 TEST SETUP	32
4.1.6 EUT OPERATING CONDITIONS	33
4.1.7 TEST RESULTS	34
4.2 RADIATED EMISSION AND BANDEDGE MEASUREMENT.....	36
4.2.1 LIMITS OF RADIATED EMISSION AND BANDEDGE MEASUREMENT	36
4.2.2 LIMITS OF UNWANTED EMISSION OUT OF THE RESTRICTED BANDS.....	37
4.2.3 TEST INSTRUMENTS	38
4.2.4 TEST PROCEDURES	39
4.2.5 DEVIATION FROM TEST STANDARD	39
4.2.6 TEST SETUP	40
4.2.7 EUT OPERATING CONDITION	40
4.2.8 TEST RESULTS	41
4.3 TRANSMIT POWER MEASUREMENT.....	80
4.3.1 LIMITS OF TRANSMIT POWER MEASUREMENT	80
4.3.2 TEST INSTRUMENTS	81
4.3.3 TEST PROCEDURE	81
4.3.4 DEVIATION FROM TEST STANDARD	82
4.3.5 TEST SETUP	82
4.3.6 EUT OPERATING CONDITIONS	82
4.3.7 TEST RESULTS	83



A D T

4.4	PEAK POWER SPECTRAL DENSITY MEASUREMENT	91
4.4.1	LIMITS OF PEAK POWER SPECTRAL DENSITY MEASUREMENT	91
4.4.2	TEST INSTRUMENTS	91
4.4.3	TEST PROCEDURES	92
4.4.4	DEVIATION FROM TEST STANDARD	93
4.4.5	TEST SETUP	93
4.4.6	EUT OPERATING CONDITIONS	93
4.4.7	TEST RESULTS	94
4.5	FREQUENCY STABILITY	101
4.5.1	LIMITS OF FREQUENCY STABILITY MEASUREMENT	101
4.5.2	TEST INSTRUMENTS	101
4.5.3	TEST PROCEDURE	101
4.5.4	DEVIATION FROM TEST STANDARD	102
4.5.5	TEST SETUP	102
4.5.6	EUT OPERATING CONDITION	102
4.5.7	TEST RESULTS	103
4.6	6DB BANDWIDTH MEASUREMENT	104
4.6.1	LIMITS OF 6DB BANDWIDTH MEASUREMENT	104
4.6.2	TEST INSTRUMENTS	104
4.6.3	TEST PROCEDURE	104
4.6.4	DEVIATION FROM TEST STANDARD	104
4.6.5	TEST SETUP	104
4.6.6	EUT OPERATING CONDITIONS	104
4.6.7	TEST RESULTS	105
5.	PHOTOGRAPHS OF THE TEST CONFIGURATION	107
6.	INFORMATION ON THE TESTING LABORATORIES	108
7.	APPENDIX A - MODIFICATIONS RECORDERS FOR ENGINEERING CHANGES TO THE EUT BY THE LAB	109



A D T

RELEASE CONTROL RECORD

ISSUE NO.	REASON FOR CHANGE	DATE ISSUED
RF140515E03-1	Original release	June 27, 2014
RF140515E03-1 R1	Modified information of applicant.	July 29, 2014



A D T

1. CERTIFICATION

PRODUCT: WLAN Module
BRAND NAME: FOXCONN
MODEL NO.: J20H084ac, J20H084
TEST SAMPLE: ENGINEERING SAMPLE
APPLICANT: Sony Corporation
TESTED: May 16 to June 13, 2014
STANDARDS: **FCC Part 15, Subpart E (Section 15.407)**
ANSI C63.10-2009

The above equipment (Model: J20H084ac) has been tested by **Bureau Veritas Consumer Products Services (H.K.) Ltd., Taoyuan Branch**, and found compliance with the requirement of the above standards. The test record, data evaluation & Equipment Under Test (EUT) configurations represented herein are true and accurate accounts of the measurements of the sample's EMC characteristics under the conditions specified in this report.

PREPARED BY : Phoenix Huang , **DATE:** July 29, 2014
(Phoenix Huang, Specialist)

APPROVED BY : May Chen , **DATE:** July 29, 2014
(May Chen, Manager)



A D T

2. SUMMARY OF TEST RESULTS

The EUT has been tested according to the following specifications:

APPLIED STANDARD: FCC PART 15, SUBPART E (SECTION 15.407)			
STANDARD SECTION	TEST TYPE	RESULT	REMARK
15.407(b)(6)	AC Power Conducted Emission	PASS	Meet the requirement of limit. Minimum passing margin is -15.17dB at 0.66953MHz
15.407 (b)(1/2/3/4/6)	Radiated Emissions & Band Edge Measurement	PASS	Meet the requirement of limit. Minimum passing margin is -0.1dB at 5725.00MHz, 15540.00MHz, 15780.00MHz & 16500.00MHz.
15.407(a/1/2/3)	Transmit Power	PASS	Meet the requirement of limit.
15.407(a/1/2/3)	Peak Power Spectral Density	PASS	Meet the requirement of limit.
15.407(e)	6dB bandwidth	PASS	Meet the requirement of limit. (U-NII-3 Band only)
15.407(g)	Frequency Stability	PASS	Meet the requirement of limit.
15.203	Antenna Requirement	PASS	No antenna connector is used.

- NOTE:** 1. For WLAN: The EUT was operating in 2400 ~ 2483.5MHz, 5.15~5.35GHz, 5.47~5.725GHz and 5.725~5.850GHz frequencies band. This report was recorded the RF parameters including 5.15~5.35GHz, 5.47~5.725GHz and 5.725~5.850GHz. For the 2400 ~ 2483.5MHz RF parameters was recorded in another test report.
2. The DFS report was recorded in another test report.



A D T

2.1 MEASUREMENT UNCERTAINTY

Where relevant, the following measurement uncertainty levels have been estimated for tests performed on the EUT as specified in CISPR 16-4-2:

This uncertainty represents an expanded uncertainty expressed at approximately the 95% confidence level using a coverage factor of $k=2$.

Measurement	Value
Conducted emissions	2.86 dB
Radiated emissions (30MHz-1GHz)	5.43 dB
Radiated emissions (1GHz -6GHz)	3.72 dB
Radiated emissions (6GHz -18GHz)	4.00 dB
Radiated emissions (18GHz -40GHz)	4.11 dB



A D T

3. GENERAL INFORMATION

3.1 GENERAL DESCRIPTION OF EUT (WLAN)

PRODUCT	WLAN Module
MODEL NO.	J20H084ac, J20H084
POWER SUPPLY	3.3Vdc \pm 5% (from host equipment)
MODULATION TYPE	CCK, DQPSK, DBPSK for DSSS 64QAM, 16QAM, QPSK, BPSK for OFDM 256QAM for OFDM in 11ac mode only
MODULATION TECHNOLOGY	DSSS, OFDM
TRANSFER RATE	802.11b: up to 11Mbps 802.11a / g: up to 54Mbps 802.11n: up to 300Mbps 802.11ac: up to 866.7Mbps
OPERATING FREQUENCY	For 15.407 5.18 ~ 5.24GHz, 5.26 ~ 5.32GHz, 5.50 ~ 5.70GHz, 5.745 ~ 5.825GHz For 15.247 2.412 ~ 2.462GHz
NUMBER OF CHANNEL	For 15.407 24 for 802.11a, 802.11n (HT20), 802.11ac (VHT20) 11 for 802.11n (HT40), 802.11ac (VHT40) 5 for 802.11ac (VHT80) For 15.247 11 for 802.11b, 802.11g, 802.11n (HT20)
MAXIMUM OUTPUT POWER	For 15.407 802.11a: 233.91mW 802.11ac (VHT20): 328.794mW 802.11ac (VHT40): 145.631mW 802.11ac (VHT80): 180.565mW For 15.247 802.11b: 325.835mW 802.11g: 709.261mW 802.11n (HT20): 700.427mW



A D T

ANTENNA TYPE	Please see NOTE
DATA CABLE	NA
I/O PORTS	Refer to user's manual
ASSOCIATED DEVICES	NA

NOTE:

- The EUT has two model names which are the same hardware (chip). This different function (base on different model) is controlled by firmware, one is enable 802.11ac mode, the other is disable 802.11ac mode, but the hardware is identical.

Model Name	Different
J20H084ac	Chip support 802.11ac function.
J20H084	Chip doesn't support 802.11ac function.

From the above models, models: **J20H084ac** was selected as representative model for the test and its data was recorded in this report.

- There are Bluetooth and WLAN technology used for the EUT.
- For WLAN, 2.4GHz and 5GHz technology can not transmit at same time.
- The emission of the simultaneous operation (WLAN & Bluetooth) has been evaluated and no non-compliance was found.
- The antennas provided to the EUT, please refer to the following table:

For WLAN								
Antenna No.	Transmitter Circuit	Brand	Model	Antenna Gain(dBi) < including cable loss>	Frequency range (GHz)	Antenna Type	Connecter Type	Cable Length
1	Chain (0)	Foxconn WiFi	J20H084	2.81	2.4	PCB printing	NA	NA
				3.05	2.45			
				3.40	2.5			
				3.50	5.15			
				3.28	5.45			
				3.79	5.85			
2	Chain (1)	Foxconn WiFi	J20H084	2.93	2.4	PCB printing	NA	NA
				2.91	2.45			
				2.76	2.5			
				2.96	5.15			
				2.57	5.45			
				2.82	5.85			



A D T

For BT used								
Antenna No.	Brand	Model	Antenna Gain(dBi) <exclude cable loss>	Frequency range (MHz to MHz)	Cable Loss(dB)	Antenna Type	Connector Type	Cable Length (mm)
3	Foxconn Corporation	WDAN-S1TV0100-DH	-0.58	2400-2500	0.24	PIFA	UFL	100
4	Foxconn Corporation	WDAN-S1TV0300-DH	-0.58	2400-2500	0.7	PIFA	UFL	300
5	Foxconn Corporation	WDAN-S1TV0310-DH	-0.58	2400-2500	0.8	PIFA	UFL	310
6	Foxconn Corporation	WDAN-S1TV0320-DH	-0.58	2400-2500	0.8	PIFA	UFL	320
7	Foxconn Corporation	WDAN-S1TV0330-DH	-0.58	2400-2500	0.8	PIFA	UFL	330
8	Foxconn Corporation	WDAN-S1TV0340-DH	-0.58	2400-2500	0.8	PIFA	UFL	340
9	Foxconn Corporation	WDAN-S1TV0350-DH	-0.58	2400-2500	0.9	PIFA	UFL	350
10	Foxconn Corporation	WDAN-S1TV0360-DH	-0.58	2400-2500	0.9	PIFA	UFL	360
11	Foxconn Corporation	WDAN-S1TV0370-DH	-0.58	2400-2500	0.9	PIFA	UFL	370
12	Foxconn Corporation	WDAN-S1TV0380-DH	-0.58	2400-2500	0.9	PIFA	UFL	380
13	Foxconn Corporation	WDAN-S1TV0390-DH	-0.58	2400-2500	1.0	PIFA	UFL	390
14	Foxconn Corporation	WDAN-S1TV0400-DH	-0.58	2400-2500	1.0	PIFA	UFL	400
15	Foxconn Corporation	WDAN-S1TV0410-DH	-0.58	2400-2500	1.0	PIFA	UFL	410
16	Foxconn Corporation	WDAN-S1TV0420-DH	-0.58	2400-2500	1.0	PIFA	UFL	420
17	Foxconn Corporation	WDAN-S1TV0430-DH	-0.58	2400-2500	1.1	PIFA	UFL	430
18	Foxconn Corporation	WDAN-S1TV0440-DH	-0.58	2400-2500	1.1	PIFA	UFL	440
19	Foxconn Corporation	WDAN-S1TV0450-DH	-0.58	2400-2500	1.1	PIFA	UFL	450
20	Foxconn Corporation	WDAN-S1TV0460-DH	-0.58	2400-2500	1.1	PIFA	UFL	460



A D T

Antenna No.	Brand	Model	Antenna Gain(dBi) <exclude cable loss>	Frequency range (MHz to MHz)	Cable Loss(dB)	Antenna Type	Connector Type	Cable Length (mm)
21	Foxconn Corporation	WDAN-S1TV0470-DH	-0.58	2400-2500	1.2	PIFA	UFL	470
22	Foxconn Corporation	WDAN-S1TV0480-DH	-0.58	2400-2500	1.2	PIFA	UFL	480
23	Foxconn Corporation	WDAN-S1TV0490-DH	-0.58	2400-2500	1.2	PIFA	UFL	490
24	Foxconn Corporation	WDAN-S1TV0500-DH	-0.58	2400-2500	1.2	PIFA	UFL	500
25	Foxconn Corporation	WDAN-S1TV0510-DH	-0.58	2400-2500	1.2	PIFA	UFL	510
26	Foxconn Corporation	WDAN-S1TV0520-DH	-0.58	2400-2500	1.3	PIFA	UFL	520
27	Foxconn Corporation	WDAN-S1TV0530-DH	-0.58	2400-2500	1.3	PIFA	UFL	530
28	Foxconn Corporation	WDAN-S1TV0540-DH	-0.58	2400-2500	1.3	PIFA	UFL	540
29	Foxconn Corporation	WDAN-S1TV0550-DH	-0.58	2400-2500	1.3	PIFA	UFL	550
30	Foxconn Corporation	WDAN-S1TV0560-DH	-0.58	2400-2500	1.4	PIFA	UFL	560
31	Foxconn Corporation	WDAN-S1TV0570-DH	-0.58	2400-2500	1.4	PIFA	UFL	570
32	Foxconn Corporation	WDAN-S1TV0580-DH	-0.58	2400-2500	1.4	PIFA	UFL	580
33	Foxconn Corporation	WDAN-S1TV0590-DH	-0.58	2400-2500	1.4	PIFA	UFL	590
34	Foxconn Corporation	WDAN-S1TV0600-DH	-0.58	2400-2500	1.5	PIFA	UFL	600
35	Foxconn Corporation	WDAN-S1TV0610-DH	-0.58	2400-2500	1.5	PIFA	UFL	610
36	Foxconn Corporation	WDAN-S1TV0620-DH	-0.58	2400-2500	1.5	PIFA	UFL	620
37	Foxconn Corporation	WDAN-S1TV0630-DH	-0.58	2400-2500	1.5	PIFA	UFL	630
38	Foxconn Corporation	WDAN-S1TV0640-DH	-0.58	2400-2500	1.6	PIFA	UFL	640
39	Foxconn Corporation	WDAN-S1TV0650-DH	-0.58	2400-2500	1.6	PIFA	UFL	650
40	Foxconn Corporation	WDAN-S1TV0660-DH	-0.58	2400-2500	1.6	PIFA	UFL	660



A D T

Antenna No.	Brand	Model	Antenna Gain(dBi) <exclude cable loss>	Frequency range (MHz to MHz)	Cable Loss(dB)	Antenna Type	Connector Type	Cable Length (mm)
41	Foxconn Corporation	WDAN-S1TV0670-DH	-0.58	2400-2500	1.6	PIFA	UFL	670
42	Foxconn Corporation	WDAN-S1TV0680-DH	-0.58	2400-2500	1.7	PIFA	UFL	680
43	Foxconn Corporation	WDAN-S1TV0690-DH	-0.58	2400-2500	1.7	PIFA	UFL	690
44	Foxconn Corporation	WDAN-S1TV0700-DH	-0.58	2400-2500	1.7	PIFA	UFL	700
45	Foxconn Corporation	WDAN-S1TV0710-DH	-0.58	2400-2500	1.7	PIFA	UFL	710
46	Foxconn Corporation	WDAN-S1TV0720-DH	-0.58	2400-2500	1.7	PIFA	UFL	720
47	Foxconn Corporation	WDAN-S1TV0730-DH	-0.58	2400-2500	1.8	PIFA	UFL	730
48	Foxconn Corporation	WDAN-S1TV0740-DH	-0.58	2400-2500	1.8	PIFA	UFL	740
49	Foxconn Corporation	WDAN-S1TV0750-DH	-0.58	2400-2500	1.8	PIFA	UFL	750
50	Foxconn Corporation	WDAN-S1TV0760-DH	-0.58	2400-2500	1.8	PIFA	UFL	760
51	Foxconn Corporation	WDAN-S1TV0770-DH	-0.58	2400-2500	1.9	PIFA	UFL	770
52	Foxconn Corporation	WDAN-S1TV0780-DH	-0.58	2400-2500	1.9	PIFA	UFL	780
53	Foxconn Corporation	WDAN-S1TV0790-DH	-0.58	2400-2500	1.9	PIFA	UFL	790
54	Foxconn Corporation	WDAN-S1TV0800-DH	-0.58	2400-2500	1.9	PIFA	UFL	800
55	Foxconn Corporation	WDAN-S1TV0810-DH	-0.58	2400-2500	2.0	PIFA	UFL	810
56	Foxconn Corporation	WDAN-S1TV0820-DH	-0.58	2400-2500	2.0	PIFA	UFL	820
57	Foxconn Corporation	WDAN-S1TV0830-DH	-0.58	2400-2500	2.0	PIFA	UFL	830
58	Foxconn Corporation	WDAN-S1TV0840-DH	-0.58	2400-2500	2.0	PIFA	UFL	840
59	Foxconn Corporation	WDAN-S1TV0850-DH	-0.58	2400-2500	2.1	PIFA	UFL	850
60	Foxconn Corporation	WDAN-S1TV0860-DH	-0.58	2400-2500	2.1	PIFA	UFL	860



A D T

Antenna No.	Brand	Model	Antenna Gain(dBi) <exclude cable loss>	Frequency range (MHz to MHz)	Cable Loss(dB)	Antenna Type	Connector Type	Cable Length (mm)
61	Foxconn Corporation	WDAN-S1TV0870-DH	-0.58	2400-2500	2.1	PIFA	UFL	870
62	Foxconn Corporation	WDAN-S1TV0880-DH	-0.58	2400-2500	2.1	PIFA	UFL	880
63	Foxconn Corporation	WDAN-S1TV0890-DH	-0.58	2400-2500	2.2	PIFA	UFL	890
64	Foxconn Corporation	WDAN-S1TV0900-DH	-0.58	2400-2500	2.2	PIFA	UFL	900
65	Foxconn Corporation	WDAN-S1TV0910-DH	-0.58	2400-2500	2.2	PIFA	UFL	910
66	Foxconn Corporation	WDAN-S1TV0920-DH	-0.58	2400-2500	2.2	PIFA	UFL	920
67	Foxconn Corporation	WDAN-S1TV0930-DH	-0.58	2400-2500	2.3	PIFA	UFL	930
68	Foxconn Corporation	WDAN-S1TV0940-DH	-0.58	2400-2500	2.3	PIFA	UFL	940
69	Foxconn Corporation	WDAN-S1TV0950-DH	-0.58	2400-2500	2.3	PIFA	UFL	950
70	Foxconn Corporation	WDAN-S1TV0960-DH	-0.58	2400-2500	2.3	PIFA	UFL	960
71	Foxconn Corporation	WDAN-S1TV0970-DH	-0.58	2400-2500	2.3	PIFA	UFL	970
72	Foxconn Corporation	WDAN-S1TV0980-DH	-0.58	2400-2500	2.4	PIFA	UFL	980
73	Foxconn Corporation	WDAN-S1TV0990-DH	-0.58	2400-2500	2.4	PIFA	UFL	990
74	Foxconn Corporation	WDAN-S1TV1000-DH	-0.58	2400-2500	2.4	PIFA	UFL	1000
75	Foxconn Corporation	WDAN-S1TV1010-DH	-0.58	2400-2500	2.4	PIFA	UFL	1010
76	Foxconn Corporation	WDAN-S1TV1020-DH	-0.58	2400-2500	2.5	PIFA	UFL	1020
77	Foxconn Corporation	WDAN-S1TV1030-DH	-0.58	2400-2500	2.5	PIFA	UFL	1030
78	Foxconn Corporation	WDAN-S1TV1040-DH	-0.58	2400-2500	2.5	PIFA	UFL	1040
79	Foxconn Corporation	WDAN-S1TV1050-DH	-0.58	2400-2500	2.5	PIFA	UFL	1050
80	Foxconn Corporation	WDAN-S1TV1060-DH	-0.58	2400-2500	2.6	PIFA	UFL	1060



A D T

Antenna No.	Brand	Model	Antenna Gain(dBi) <exclude cable loss>	Frequency range (MHz to MHz)	Cable Loss(dB)	Antenna Type	Connector Type	Cable Length (mm)
81	Foxconn Corporation	WDAN-S1TV1070-DH	-0.58	2400-2500	2.6	PIFA	UFL	1070
82	Foxconn Corporation	WDAN-S1TV1080-DH	-0.58	2400-2500	2.6	PIFA	UFL	1080
83	Foxconn Corporation	WDAN-S1TV1090-DH	-0.58	2400-2500	2.6	PIFA	UFL	1090
84	Foxconn Corporation	WDAN-S1TV1100-DH	-0.58	2400-2500	2.7	PIFA	UFL	1100
85	Foxconn Corporation	WDAN-S1TV1110-DH	-0.58	2400-2500	2.7	PIFA	UFL	1110
86	Foxconn Corporation	WDAN-S1TV1120-DH	-0.58	2400-2500	2.7	PIFA	UFL	1120
87	Foxconn Corporation	WDAN-S1TV1130-DH	-0.58	2400-2500	2.7	PIFA	UFL	1130
88	Foxconn Corporation	WDAN-S1TV1140-DH	-0.58	2400-2500	2.8	PIFA	UFL	1140
89	Foxconn Corporation	WDAN-S1TV1150-DH	-0.58	2400-2500	2.8	PIFA	UFL	1150
90	Foxconn Corporation	WDAN-S1TV1160-DH	-0.58	2400-2500	2.8	PIFA	UFL	1160
91	Foxconn Corporation	WDAN-S1TV1170-DH	-0.58	2400-2500	2.8	PIFA	UFL	1170
92	Foxconn Corporation	WDAN-S1TV1180-DH	-0.58	2400-2500	2.8	PIFA	UFL	1180
93	Foxconn Corporation	WDAN-S1TV1190-DH	-0.58	2400-2500	2.9	PIFA	UFL	1190
94	Foxconn Corporation	WDAN-S1TV1200-DH	-0.58	2400-2500	2.9	PIFA	UFL	1200
95	Foxconn Corporation	WDAN-S1TV1210-DH	-0.58	2400-2500	2.9	PIFA	UFL	1210
96	Foxconn Corporation	WDAN-S1TV1220-DH	-0.58	2400-2500	2.9	PIFA	UFL	1220
97	Foxconn Corporation	WDAN-S1TV1230-DH	-0.58	2400-2500	3.0	PIFA	UFL	1230
98	Foxconn Corporation	WDAN-S1TV1240-DH	-0.58	2400-2500	3.0	PIFA	UFL	1240
99	Foxconn Corporation	WDAN-S1TV1250-DH	-0.58	2400-2500	3.0	PIFA	UFL	1250
100	Foxconn Corporation	WDAN-S1TV1260-DH	-0.58	2400-2500	3.0	PIFA	UFL	1260



A D T

Antenna No.	Brand	Model	Antenna Gain(dBi) <exclude cable loss>	Frequency range (MHz to MHz)	Cable Loss(dB)	Antenna Type	Connector Type	Cable Length (mm)
101	Foxconn Corporation	WDAN-S1TV1270-DH	-0.58	2400-2500	3.1	PIFA	UFL	1270
102	Foxconn Corporation	WDAN-S1TV1280-DH	-0.58	2400-2500	3.1	PIFA	UFL	1280
103	Foxconn Corporation	WDAN-S1TV1290-DH	-0.58	2400-2500	3.1	PIFA	UFL	1290
104	Foxconn Corporation	WDAN-S1TV1300-DH	-0.58	2400-2500	3.1	PIFA	UFL	1300
105	Foxconn Corporation	WDAN-S1TV1310-DH	-0.58	2400-2500	3.2	PIFA	UFL	1310
106	Foxconn Corporation	WDAN-S1TV1320-DH	-0.58	2400-2500	3.2	PIFA	UFL	1320
107	Foxconn Corporation	WDAN-S1TV1330-DH	-0.58	2400-2500	3.2	PIFA	UFL	1330
108	Foxconn Corporation	WDAN-S1TV1340-DH	-0.58	2400-2500	3.2	PIFA	UFL	1340
109	Foxconn Corporation	WDAN-S1TV1350-DH	-0.58	2400-2500	3.3	PIFA	UFL	1350
110	Foxconn Corporation	WDAN-S1TV1360-DH	-0.58	2400-2500	3.3	PIFA	UFL	1360
111	Foxconn Corporation	WDAN-S1TV1370-DH	-0.58	2400-2500	3.3	PIFA	UFL	1370
112	Foxconn Corporation	WDAN-S1TV1380-DH	-0.58	2400-2500	3.3	PIFA	UFL	1380
113	Foxconn Corporation	WDAN-S1TV1390-DH	-0.58	2400-2500	3.3	PIFA	UFL	1390
114	Foxconn Corporation	WDAN-S1TV1400-DH	-0.58	2400-2500	3.4	PIFA	UFL	1400
115	Foxconn Corporation	WDAN-S1TV1410-DH	-0.58	2400-2500	3.4	PIFA	UFL	1410
116	Foxconn Corporation	WDAN-S1TV1420-DH	-0.58	2400-2500	3.4	PIFA	UFL	1420
117	Foxconn Corporation	WDAN-S1TV1430-DH	-0.58	2400-2500	3.4	PIFA	UFL	1430
118	Foxconn Corporation	WDAN-S1TV1440-DH	-0.58	2400-2500	3.5	PIFA	UFL	1440
119	Foxconn Corporation	WDAN-S1TV1450-DH	-0.58	2400-2500	3.5	PIFA	UFL	1450
120	Foxconn Corporation	WDAN-S1TV1460-DH	-0.58	2400-2500	3.5	PIFA	UFL	1460



A D T

Antenna No.	Brand	Model	Antenna Gain(dBi) <exclude cable loss>	Frequency range (MHz to MHz)	Cable Loss(dB)	Antenna Type	Connector Type	Cable Length (mm)
121	Foxconn Corporation	WDAN-S1TV1470-DH	-0.58	2400-2500	3.5	PIFA	UFL	1470
122	Foxconn Corporation	WDAN-S1TV1480-DH	-0.58	2400-2500	3.6	PIFA	UFL	1480
123	Foxconn Corporation	WDAN-S1TV1490-DH	-0.58	2400-2500	3.6	PIFA	UFL	1490
124	Foxconn Corporation	WDAN-S1TV1500-DH	-0.58	2400-2500	3.6	PIFA	UFL	1500
125	Foxconn Corporation	WDAN-S1TV1510-DH	-0.58	2400-2500	3.6	PIFA	UFL	1510
126	Foxconn Corporation	WDAN-S1TV1520-DH	-0.58	2400-2500	3.7	PIFA	UFL	1520
127	Foxconn Corporation	WDAN-S1TV1530-DH	-0.58	2400-2500	3.7	PIFA	UFL	1530
128	Foxconn Corporation	WDAN-S1TV1540-DH	-0.58	2400-2500	3.7	PIFA	UFL	1540
129	Foxconn Corporation	WDAN-S1TV1550-DH	-0.58	2400-2500	3.7	PIFA	UFL	1550
130	Foxconn Corporation	WDAN-S1TV1560-DH	-0.58	2400-2500	3.8	PIFA	UFL	1560
131	Foxconn Corporation	WDAN-S1TV1570-DH	-0.58	2400-2500	3.8	PIFA	UFL	1570
132	Foxconn Corporation	WDAN-S1TV1580-DH	-0.58	2400-2500	3.8	PIFA	UFL	1580
133	Foxconn Corporation	WDAN-S1TV1590-DH	-0.58	2400-2500	3.8	PIFA	UFL	1590
134	Foxconn Corporation	WDAN-S1TV1600-DH	-0.58	2400-2500	3.9	PIFA	UFL	1600
135	Foxconn Corporation	WDAN-S1TV1610-DH	-0.58	2400-2500	3.9	PIFA	UFL	1610
136	Foxconn Corporation	WDAN-S1TV1620-DH	-0.58	2400-2500	3.9	PIFA	UFL	1620
137	Foxconn Corporation	WDAN-S1TV1630-DH	-0.58	2400-2500	3.9	PIFA	UFL	1630
138	Foxconn Corporation	WDAN-S1TV1640-DH	-0.58	2400-2500	3.9	PIFA	UFL	1640
139	Foxconn Corporation	WDAN-S1TV1650-DH	-0.58	2400-2500	4.0	PIFA	UFL	1650
140	Foxconn Corporation	WDAN-S1TV1660-DH	-0.58	2400-2500	4.0	PIFA	UFL	1660



A D T

Antenna No.	Brand	Model	Antenna Gain(dBi) <exclude cable loss>	Frequency range (MHz to MHz)	Cable Loss(dB)	Antenna Type	Connector Type	Cable Length (mm)
141	Foxconn Corporation	WDAN-S1TV1670-DH	-0.58	2400-2500	4.0	PIFA	UFL	1670
142	Foxconn Corporation	WDAN-S1TV1680-DH	-0.58	2400-2500	4.0	PIFA	UFL	1680
143	Foxconn Corporation	WDAN-S1TV1690-DH	-0.58	2400-2500	4.1	PIFA	UFL	1690
144	Foxconn Corporation	WDAN-S1TV1700-DH	-0.58	2400-2500	4.1	PIFA	UFL	1700
145	Foxconn Corporation	WDAN-S1TV1710-DH	-0.58	2400-2500	4.1	PIFA	UFL	1710
146	Foxconn Corporation	WDAN-S1TV1720-DH	-0.58	2400-2500	4.1	PIFA	UFL	1720
147	Foxconn Corporation	WDAN-S1TV1730-DH	-0.58	2400-2500	4.2	PIFA	UFL	1730
148	Foxconn Corporation	WDAN-S1TV1740-DH	-0.58	2400-2500	4.2	PIFA	UFL	1740
149	Foxconn Corporation	WDAN-S1TV1750-DH	-0.58	2400-2500	4.2	PIFA	UFL	1750
150	Foxconn Corporation	WDAN-S1TV1760-DH	-0.58	2400-2500	4.2	PIFA	UFL	1760
151	Foxconn Corporation	WDAN-S1TV1770-DH	-0.58	2400-2500	4.3	PIFA	UFL	1770
152	Foxconn Corporation	WDAN-S1TV1780-DH	-0.58	2400-2500	4.3	PIFA	UFL	1780
153	Foxconn Corporation	WDAN-S1TV1790-DH	-0.58	2400-2500	4.3	PIFA	UFL	1790
154	Foxconn Corporation	WDAN-S1TV1800-DH	-0.58	2400-2500	4.3	PIFA	UFL	1800
155	Foxconn Corporation	WDAN-S1TV2000-DH	-0.58	2400-2500	4.8	PIFA	UFL	2000
156	SAA	SN6506-11-010-C	-2.42	2400-2500	0.5	PIFA	UFL	100
157	SAA	SN6506-11-030-C	-2.42	2400-2500	1.1	PIFA	UFL	300
158	SAA	SN6506-11-031-C	-2.42	2400-2500	1.1	PIFA	UFL	310
159	SAA	SN6506-11-032-C	-2.42	2400-2500	1.1	PIFA	UFL	320
160	SAA	SN6506-11-033-C	-2.42	2400-2500	1.1	PIFA	UFL	330
161	SAA	SN6506-11-034-C	-2.42	2400-2500	1.2	PIFA	UFL	340
162	SAA	SN6506-11-035-C	-2.42	2400-2500	1.2	PIFA	UFL	350
163	SAA	SN6506-11-036-C	-2.42	2400-2500	1.2	PIFA	UFL	360
164	SAA	SN6506-11-037-C	-2.42	2400-2500	1.2	PIFA	UFL	370
165	SAA	SN6506-11-038-C	-2.42	2400-2500	1.3	PIFA	UFL	380

**A D T**

Antenna No.	Brand	Model	Antenna Gain(dBi) <exclude cable loss>	Frequency range (MHz to MHz)	Cable Loss(dB)	Antenna Type	Connector Type	Cable Length (mm)
166	SAA	SN6506-11-039-C	-2.42	2400-2500	1.3	PIFA	UFL	390
167	SAA	SN6506-11-040-C	-2.42	2400-2500	1.3	PIFA	UFL	400
168	SAA	SN6506-11-041-C	-2.42	2400-2500	1.3	PIFA	UFL	410
169	SAA	SN6506-11-042-C	-2.42	2400-2500	1.4	PIFA	UFL	420
170	SAA	SN6506-11-043-C	-2.42	2400-2500	1.4	PIFA	UFL	430
171	SAA	SN6506-11-044-C	-2.42	2400-2500	1.4	PIFA	UFL	440
172	SAA	SN6506-11-045-C	-2.42	2400-2500	1.5	PIFA	UFL	450
173	SAA	SN6506-11-046-C	-2.42	2400-2500	1.5	PIFA	UFL	460
174	SAA	SN6506-11-047-C	-2.42	2400-2500	1.5	PIFA	UFL	470
175	SAA	SN6506-11-048-C	-2.42	2400-2500	1.5	PIFA	UFL	480
176	SAA	SN6506-11-049-C	-2.42	2400-2500	1.6	PIFA	UFL	490
177	SAA	SN6506-11-050-C	-2.42	2400-2500	1.6	PIFA	UFL	500
178	SAA	SN6506-11-051-C	-2.42	2400-2500	1.6	PIFA	UFL	510
179	SAA	SN6506-11-052-C	-2.42	2400-2500	1.6	PIFA	UFL	520
180	SAA	SN6506-11-053-C	-2.42	2400-2500	1.7	PIFA	UFL	530
181	SAA	SN6506-11-054-C	-2.42	2400-2500	1.7	PIFA	UFL	540
182	SAA	SN6506-11-055-C	-2.42	2400-2500	1.7	PIFA	UFL	550
183	SAA	SN6506-11-056-C	-2.42	2400-2500	1.7	PIFA	UFL	560
184	SAA	SN6506-11-057-C	-2.42	2400-2500	1.8	PIFA	UFL	570
185	SAA	SN6506-11-058-C	-2.42	2400-2500	1.8	PIFA	UFL	580
186	SAA	SN6506-11-059-C	-2.42	2400-2500	1.8	PIFA	UFL	590
187	SAA	SN6506-11-060-C	-2.42	2400-2500	1.8	PIFA	UFL	600
188	SAA	SN6506-11-061-C	-2.42	2400-2500	1.9	PIFA	UFL	610
189	SAA	SN6506-11-062-C	-2.42	2400-2500	1.9	PIFA	UFL	620
190	SAA	SN6506-11-063-C	-2.42	2400-2500	1.9	PIFA	UFL	630
191	SAA	SN6506-11-064-C	-2.42	2400-2500	2.0	PIFA	UFL	640
192	SAA	SN6506-11-065-C	-2.42	2400-2500	2.0	PIFA	UFL	650
193	SAA	SN6506-11-066-C	-2.42	2400-2500	2.0	PIFA	UFL	660
194	SAA	SN6506-11-067-C	-2.42	2400-2500	2.0	PIFA	UFL	670
195	SAA	SN6506-11-068-C	-2.42	2400-2500	2.1	PIFA	UFL	680
196	SAA	SN6506-11-069-C	-2.42	2400-2500	2.1	PIFA	UFL	690
197	SAA	SN6506-11-070-C	-2.42	2400-2500	2.1	PIFA	UFL	700
198	SAA	SN6506-11-071-C	-2.42	2400-2500	2.1	PIFA	UFL	710
199	SAA	SN6506-11-072-C	-2.42	2400-2500	2.2	PIFA	UFL	720
200	SAA	SN6506-11-073-C	-2.42	2400-2500	2.2	PIFA	UFL	730

**A D T**

Antenna No.	Brand	Model	Antenna Gain(dBi) <exclude cable loss>	Frequency range (MHz to MHz)	Cable Loss(dB)	Antenna Type	Connector Type	Cable Length (mm)
201	SAA	SN6506-11-074-C	-2.42	2400-2500	2.2	PIFA	UFL	740
202	SAA	SN6506-11-075-C	-2.42	2400-2500	2.2	PIFA	UFL	750
203	SAA	SN6506-11-076-C	-2.42	2400-2500	2.3	PIFA	UFL	760
204	SAA	SN6506-11-077-C	-2.42	2400-2500	2.3	PIFA	UFL	770
205	SAA	SN6506-11-078-C	-2.42	2400-2500	2.3	PIFA	UFL	780
206	SAA	SN6506-11-079-C	-2.42	2400-2500	2.3	PIFA	UFL	790
207	SAA	SN6506-11-080-C	-2.42	2400-2500	2.4	PIFA	UFL	800
208	SAA	SN6506-11-081-C	-2.42	2400-2500	2.4	PIFA	UFL	810
209	SAA	SN6506-11-082-C	-2.42	2400-2500	2.4	PIFA	UFL	820
210	SAA	SN6506-11-083-C	-2.42	2400-2500	2.5	PIFA	UFL	830
211	SAA	SN6506-11-084-C	-2.42	2400-2500	2.5	PIFA	UFL	840
212	SAA	SN6506-11-085-C	-2.42	2400-2500	2.5	PIFA	UFL	850
213	SAA	SN6506-11-086-C	-2.42	2400-2500	2.5	PIFA	UFL	860
214	SAA	SN6506-11-087-C	-2.42	2400-2500	2.6	PIFA	UFL	870
215	SAA	SN6506-11-088-C	-2.42	2400-2500	2.6	PIFA	UFL	880
216	SAA	SN6506-11-089-C	-2.42	2400-2500	2.6	PIFA	UFL	890
217	SAA	SN6506-11-090-C	-2.42	2400-2500	2.6	PIFA	UFL	900
218	SAA	SN6506-11-091-C	-2.42	2400-2500	2.7	PIFA	UFL	910
219	SAA	SN6506-11-092-C	-2.42	2400-2500	2.7	PIFA	UFL	920
220	SAA	SN6506-11-093-C	-2.42	2400-2500	2.7	PIFA	UFL	930
221	SAA	SN6506-11-094-C	-2.42	2400-2500	2.7	PIFA	UFL	940
222	SAA	SN6506-11-095-C	-2.42	2400-2500	2.8	PIFA	UFL	950
223	SAA	SN6506-11-096-C	-2.42	2400-2500	2.8	PIFA	UFL	960
224	SAA	SN6506-11-097-C	-2.42	2400-2500	2.8	PIFA	UFL	970
225	SAA	SN6506-11-098-C	-2.42	2400-2500	2.8	PIFA	UFL	980
226	SAA	SN6506-11-099-C	-2.42	2400-2500	2.9	PIFA	UFL	990
227	SAA	SN6506-11-100-C	-2.42	2400-2500	2.9	PIFA	UFL	1000
228	SAA	SN6506-11-101-C	-2.42	2400-2500	2.9	PIFA	UFL	1010
229	SAA	SN6506-11-102-C	-2.42	2400-2500	3.0	PIFA	UFL	1020
230	SAA	SN6506-11-103-C	-2.42	2400-2500	3.0	PIFA	UFL	1030
231	SAA	SN6506-11-104-C	-2.42	2400-2500	3.0	PIFA	UFL	1040
232	SAA	SN6506-11-105-C	-2.42	2400-2500	3.0	PIFA	UFL	1050
233	SAA	SN6506-11-106-C	-2.42	2400-2500	3.1	PIFA	UFL	1060
234	SAA	SN6506-11-107-C	-2.42	2400-2500	3.1	PIFA	UFL	1070
235	SAA	SN6506-11-108-C	-2.42	2400-2500	3.1	PIFA	UFL	1080



A D T

Antenna No.	Brand	Model	Antenna Gain(dBi) <exclude cable loss>	Frequency range (MHz to MHz)	Cable Loss(dB)	Antenna Type	Connector Type	Cable Length (mm)
236	SAA	SN6506-11-109-C	-2.42	2400-2500	3.1	PIFA	UFL	1090
237	SAA	SN6506-11-110-C	-2.42	2400-2500	3.2	PIFA	UFL	1100
238	SAA	SN6506-11-111-C	-2.42	2400-2500	3.2	PIFA	UFL	1110
239	SAA	SN6506-11-112-C	-2.42	2400-2500	3.2	PIFA	UFL	1120
240	SAA	SN6506-11-113-C	-2.42	2400-2500	3.2	PIFA	UFL	1130
241	SAA	SN6506-11-114-C	-2.42	2400-2500	3.3	PIFA	UFL	1140
242	SAA	SN6506-11-115-C	-2.42	2400-2500	3.3	PIFA	UFL	1150
243	SAA	SN6506-11-116-C	-2.42	2400-2500	3.3	PIFA	UFL	1160
244	SAA	SN6506-11-117-C	-2.42	2400-2500	3.3	PIFA	UFL	1170
245	SAA	SN6506-11-118-C	-2.42	2400-2500	3.4	PIFA	UFL	1180
246	SAA	SN6506-11-119-C	-2.42	2400-2500	3.4	PIFA	UFL	1190
247	SAA	SN6506-11-120-C	-2.42	2400-2500	3.4	PIFA	UFL	1200
248	SAA	SN6506-11-121-C	-2.42	2400-2500	3.5	PIFA	UFL	1210
249	SAA	SN6506-11-122-C	-2.42	2400-2500	3.5	PIFA	UFL	1220
250	SAA	SN6506-11-123-C	-2.42	2400-2500	3.5	PIFA	UFL	1230
251	SAA	SN6506-11-124-C	-2.42	2400-2500	3.5	PIFA	UFL	1240
252	SAA	SN6506-11-125-C	-2.42	2400-2500	3.6	PIFA	UFL	1250
253	SAA	SN6506-11-126-C	-2.42	2400-2500	3.6	PIFA	UFL	1260
254	SAA	SN6506-11-127-C	-2.42	2400-2500	3.6	PIFA	UFL	1270
255	SAA	SN6506-11-128-C	-2.42	2400-2500	3.6	PIFA	UFL	1280
256	SAA	SN6506-11-129-C	-2.42	2400-2500	3.7	PIFA	UFL	1290
257	SAA	SN6506-11-130-C	-2.42	2400-2500	3.7	PIFA	UFL	1300
258	SAA	SN6506-11-131-C	-2.42	2400-2500	3.7	PIFA	UFL	1310
259	SAA	SN6506-11-132-C	-2.42	2400-2500	3.7	PIFA	UFL	1320
260	SAA	SN6506-11-133-C	-2.42	2400-2500	3.8	PIFA	UFL	1330
261	SAA	SN6506-11-134-C	-2.42	2400-2500	3.8	PIFA	UFL	1340
262	SAA	SN6506-11-135-C	-2.42	2400-2500	3.8	PIFA	UFL	1350
263	SAA	SN6506-11-136-C	-2.42	2400-2500	3.8	PIFA	UFL	1360
264	SAA	SN6506-11-137-C	-2.42	2400-2500	3.9	PIFA	UFL	1370
265	SAA	SN6506-11-138-C	-2.42	2400-2500	3.9	PIFA	UFL	1380
266	SAA	SN6506-11-139-C	-2.42	2400-2500	3.9	PIFA	UFL	1390
267	SAA	SN6506-11-140-C	-2.42	2400-2500	4.0	PIFA	UFL	1400
268	SAA	SN6506-11-141-C	-2.42	2400-2500	4.0	PIFA	UFL	1410
269	SAA	SN6506-11-142-C	-2.42	2400-2500	4.0	PIFA	UFL	1420
270	SAA	SN6506-11-143-C	-2.42	2400-2500	4.0	PIFA	UFL	1430



A D T

Antenna No.	Brand	Model	Antenna Gain(dBi) <exclude cable loss>	Frequency range (MHz to MHz)	Cable Loss(dB)	Antenna Type	Connector Type	Cable Length (mm)
271	SAA	SN6506-11-144-C	-2.42	2400-2500	4.1	PIFA	UFL	1440
272	SAA	SN6506-11-145-C	-2.42	2400-2500	4.1	PIFA	UFL	1450
273	SAA	SN6506-11-146-C	-2.42	2400-2500	4.1	PIFA	UFL	1460
274	SAA	SN6506-11-147-C	-2.42	2400-2500	4.1	PIFA	UFL	1470
275	SAA	SN6506-11-148-C	-2.42	2400-2500	4.2	PIFA	UFL	1480
276	SAA	SN6506-11-149-C	-2.42	2400-2500	4.2	PIFA	UFL	1490
277	SAA	SN6506-11-150-C	-2.42	2400-2500	4.2	PIFA	UFL	1500
278	SAA	SN6506-11-151-C	-2.42	2400-2500	4.2	PIFA	UFL	1510
279	SAA	SN6506-11-152-C	-2.42	2400-2500	4.3	PIFA	UFL	1520
280	SAA	SN6506-11-153-C	-2.42	2400-2500	4.3	PIFA	UFL	1530
281	SAA	SN6506-11-154-C	-2.42	2400-2500	4.3	PIFA	UFL	1540
282	SAA	SN6506-11-155-C	-2.42	2400-2500	4.3	PIFA	UFL	1550
283	SAA	SN6506-11-156-C	-2.42	2400-2500	4.4	PIFA	UFL	1560
284	SAA	SN6506-11-157-C	-2.42	2400-2500	4.4	PIFA	UFL	1570
285	SAA	SN6506-11-158-C	-2.42	2400-2500	4.4	PIFA	UFL	1580
286	SAA	SN6506-11-159-C	-2.42	2400-2500	4.5	PIFA	UFL	1590
287	SAA	SN6506-11-160-C	-2.42	2400-2500	4.5	PIFA	UFL	1600
288	SAA	SN6506-11-161-C	-2.42	2400-2500	4.5	PIFA	UFL	1610
289	SAA	SN6506-11-162-C	-2.42	2400-2500	4.5	PIFA	UFL	1620
290	SAA	SN6506-11-163-C	-2.42	2400-2500	4.6	PIFA	UFL	1630
291	SAA	SN6506-11-164-C	-2.42	2400-2500	4.6	PIFA	UFL	1640
292	SAA	SN6506-11-165-C	-2.42	2400-2500	4.6	PIFA	UFL	1650
293	SAA	SN6506-11-166-C	-2.42	2400-2500	4.6	PIFA	UFL	1660
294	SAA	SN6506-11-167-C	-2.42	2400-2500	4.7	PIFA	UFL	1670
295	SAA	SN6506-11-168-C	-2.42	2400-2500	4.7	PIFA	UFL	1680
296	SAA	SN6506-11-169-C	-2.42	2400-2500	4.7	PIFA	UFL	1690
297	SAA	SN6506-11-170-C	-2.42	2400-2500	4.7	PIFA	UFL	1700
298	SAA	SN6506-11-171-C	-2.42	2400-2500	4.8	PIFA	UFL	1710
299	SAA	SN6506-11-172-C	-2.42	2400-2500	4.8	PIFA	UFL	1720
300	SAA	SN6506-11-173-C	-2.42	2400-2500	4.8	PIFA	UFL	1730



Antenna No.	Brand	Model	Antenna Gain(dBi) <exclude cable loss>	Frequency range (MHz to MHz)	Cable Loss(dB)	Antenna Type	Connector Type	Cable Length (mm)
301	SAA	SN6506-11-174-C	-2.42	2400-2500	4.8	PIFA	UFL	1740
302	SAA	SN6506-11-175-C	-2.42	2400-2500	4.9	PIFA	UFL	1750
303	SAA	SN6506-11-176-C	-2.42	2400-2500	4.9	PIFA	UFL	1760
304	SAA	SN6506-11-177-C	-2.42	2400-2500	4.9	PIFA	UFL	1770
305	SAA	SN6506-11-178-C	-2.42	2400-2500	5.0	PIFA	UFL	1780
306	SAA	SN6506-11-179-C	-2.42	2400-2500	5.0	PIFA	UFL	1790
307	SAA	SN6506-11-180-C	-2.42	2400-2500	5.0	PIFA	UFL	1800
308	SAA	SN6506-11-200-C	-2.42	2400-2500	5.5	PIFA	UFL	2000

From the above antennas for BT used, the **Ant. No.: 3** (BT max antenna gain: -0.82dBi) were selected as representative value for the test and its data was recorded in this report.

6. The EUT incorporates a MIMO function without beamforming.

MODULATION MODE	DATA RATE (MCS)	TX & RX CONFIGURATION	
802.11a	6 ~ 54Mbps	2TX	2RX
802.11b	1 ~ 11Mbps	2TX	2RX
802.11g	6 ~ 54Mbps	2TX	2RX
802.11n (HT20)	MCS 0~7	2TX	2RX
	MCS 8~15	2TX	2RX
802.11n (HT40) (5GHz)	MCS 0~7	2TX	2RX
	MCS 8~15	2TX	2RX
802.11ac (VHT20) (5GHz)	MCS0~8 (256QAM) Nss= 1	2TX	2RX
	MCS0~8 (256QAM) Nss= 2	2TX	2RX
802.11ac (VHT40) (5GHz)	MCS0~9 (256QAM) Nss= 1	2TX	2RX
	MCS0~9 (256QAM) Nss= 2	2TX	2RX
802.11ac (VHT80) (5GHz)	MCS0~9 (256QAM) Nss= 1	2TX	2RX
	MCS0~9 (256QAM) Nss= 2	2TX	2RX

Note: The modulation and bandwidth are similar for 802.11n mode for 20MHz (40MHz) and 802.11ac mode for 20MHz (40MHz), therefore investigated worst case to representative mode in test report. (Final test mode refer section 3.2.1)

7. The above EUT information was declared by the manufacturer and for more detailed features description, please refer to the manufacturer's specifications or User's Manual.

3.2 DESCRIPTION OF TEST MODES

Operated in 5150 ~ 5250MHz band:

4 channels are provided for 802.11a, 802.11n (HT20), 802.11ac (VHT20):

CHANNEL	FREQUENCY	CHANNEL	FREQUENCY
36	5180 MHz	44	5220 MHz
40	5200 MHz	48	5240 MHz

2 channels are provided for 802.11n (HT40), 802.11ac (VHT40):

CHANNEL	FREQUENCY	CHANNEL	FREQUENCY
38	5190 MHz	46	5230 MHz

1 channel is provided for 802.11ac (VHT80):

CHANNEL	FREQUENCY
42	5210 MHz

Operated in 5250 ~ 5350MHz band:

4 channels are provided for 802.11a, 802.11n (HT20), 802.11ac (VHT20):

CHANNEL	FREQUENCY	CHANNEL	FREQUENCY
52	5260 MHz	60	5300 MHz
56	5280 MHz	64	5320 MHz

2 channels are provided for 802.11n (HT40), 802.11ac (VHT40):

CHANNEL	FREQUENCY	CHANNEL	FREQUENCY
54	5270 MHz	62	5310 MHz

1 channel is provided for 802.11ac (VHT80):

CHANNEL	FREQUENCY
58	5290 MHz



Operated in 5470MHz ~ 5725MHz bands:

11 channels are provided for 802.11a, 802.11n (HT20), 802.11ac (VHT20):

CHANNEL	FREQUENCY	CHANNEL	FREQUENCY
100	5500 MHz	124	5620 MHz
104	5520 MHz	128	5640 MHz
108	5540 MHz	132	5660 MHz
112	5560 MHz	136	5680 MHz
116	5580 MHz	140	5700 MHz
120	5600 MHz		

5 channels are provided for 802.11n (HT40), 802.11ac (VHT40):

CHANNEL	FREQUENCY	CHANNEL	FREQUENCY
102	5510 MHz	126	5630 MHz
110	5550 MHz	134	5670 MHz
118	5590 MHz		

2 channels are provided for 802.11ac (VHT80):

CHANNEL	FREQUENCY
106	5530 MHz
122	5610 MHz

Operated in 5725 ~ 5850MHz band:

5 channels are provided for 802.11a, 802.11n (HT20), 802.11ac (VHT20):

CHANNEL	FREQUENCY	CHANNEL	FREQUENCY
149	5745 MHz	161	5805 MHz
153	5765 MHz	165	5825 MHz
157	5785 MHz		

2 channels are provided for 802.11n (HT40), 802.11ac (VHT40):

CHANNEL	FREQUENCY
151	5755 MHz
159	5795 MHz

1 channel is provided for 802.11ac (VHT80):

CHANNEL	FREQUENCY
155	5775 MHz



A D T

3.2.1 TEST MODE APPLICABILITY AND TESTED CHANNEL DETAIL

EUT CONFIGURE MODE	APPLICABLE TO				DESCRIPTION
	PLC	RE < 1G	RE ≥ 1G	APCM	
-	√	√	√	√	-

Where **PLC**: Power Line Conducted Emission **RE < 1G**: Radiated Emission below 1GHz
RE ≥ 1G: Radiated Emission above 1GHz **APCM**: Antenna Port Conducted Measurement

NOTE: 1. The EUT's antenna (PIFA) had been pre-tested on the positioned of each 3 axis. The worst case was found when positioned on **X-plane (below 1GHz)** and **Z-plane (above 1GHz)**.

POWER LINE CONDUCTED EMISSION TEST:

- Pre-Scan has been conducted to determine the worst-case mode from all possible combinations between available modulations, data rates and antenna ports (if EUT with antenna diversity architecture).
- Following channel(s) was (were) selected for the final test as listed below.

MODE	AVAILABLE CHANNEL	TESTED CHANNEL	MODULATION TECHNOLOGY	MODULATION TYPE	DATA RATE (MBPS)
802.11ac (VHT20)	36 to 165	157	OFDM	BPSK	6.5

RADIATED EMISSION TEST (BELOW 1 GHz):

- Pre-Scan has been conducted to determine the worst-case mode from all possible combinations between available modulations, data rates and antenna ports (if EUT with antenna diversity architecture).
- Following channel(s) was (were) selected for the final test as listed below.

MODE	AVAILABLE CHANNEL	TESTED CHANNEL	MODULATION TECHNOLOGY	MODULATION TYPE	DATA RATE (Mbps)
802.11ac (VHT20)	36 to 165	157	OFDM	BPSK	6.5

RADIATED EMISSION TEST (ABOVE 1 GHz):

- Pre-Scan has been conducted to determine the worst-case mode from all possible combinations between available modulations, data rates and antenna ports (if EUT with antenna diversity architecture).
- Following channel(s) was (were) selected for the final test as listed below.

MODE	AVAILABLE CHANNEL	TESTED CHANNEL	MODULATION TECHNOLOGY	MODULATI ON TYPE	DATA RATE (Mbps)
802.11a	36 to 165	36, 40, 48, 52, 60, 64, 100, 120, 140, 149, 157, 165	OFDM	BPSK	6
802.11ac (VHT20)	36 to 165	36, 40, 48, 52, 60, 64, 100, 120, 140, 149, 157, 165	OFDM	BPSK	6.5
802.11ac (VHT40)	38 to 159	38, 46, 54, 62, 102, 118, 134, 151, 159	OFDM	BPSK	13.5
802.11ac (VHT80)	42 to 155	42, 58, 106, 122, 155	OFDM	BPSK	29.3

ANTENNA PORT CONDUCTED MEASUREMENT:

- Pre-Scan has been conducted to determine the worst-case mode from all possible combinations between available modulations, data rates and antenna ports (if EUT with antenna diversity architecture).
- Following channel(s) was (were) selected for the final test as listed below.

MODE	AVAILABLE CHANNEL	TESTED CHANNEL	MODULATION TECHNOLOGY	MODULATI ON TYPE	DATA RATE (Mbps)
802.11a	36 to 165	36, 40, 48, 52, 60, 64, 100, 120, 140, 149, 157, 165	OFDM	BPSK	6
802.11ac (VHT20)	36 to 165	36, 40, 48, 52, 60, 64, 100, 120, 140, 149, 157, 165	OFDM	BPSK	6.5
802.11ac (VHT40)	38 to 159	38, 46, 54, 62, 102, 118, 134, 151, 159	OFDM	BPSK	13.5
802.11ac (VHT80)	42 to 155	42, 58, 106, 122, 155	OFDM	BPSK	29.3



A D T

TEST CONDITION:

APPLICABLE TO	ENVIRONMENTAL CONDITIONS	INPUT POWER (SYSTEM)	TESTED BY
PLC	26deg. C, 74%RH	120Vac, 60Hz	Ping Liu
RE<1G	21deg. C, 65%RH	120Vac, 60Hz	Andy Ho
RE≥1G	24deg. C, 70%RH	120Vac, 60Hz	Nelson Teng
APCM	25deg. C, 60%RH	120Vac, 60Hz	Robert Cheng



3.3 GENERAL DESCRIPTION OF APPLIED STANDARDS

The EUT is a RF product. According to the specifications of the manufacturer, it must comply with the requirements of the following standards:

FCC Part 15, Subpart E (15.407)

789033 D02 General UNII Test Procedures New Rules v01

662911 D01 Multiple Transmitter Output v02r01

ANSI C63.10-2009

All test items have been performed and recorded as per the above standards.

Note: The EUT has been verified to comply with the requirements of FCC Part 15, Subpart B, Class B (DoC). The test report has been issued separately.



A D T

3.4 DUTY CYCLE OF TEST SIGNAL

If duty cycle of test signal is $\geq 98\%$, duty factor is not required.

If duty cycle of test signal is $< 98\%$, duty factor shall be considered.

802.11a: Duty cycle = $1.435 \text{ ms} / 1.4475 \text{ ms} = 0.991$

802.11ac (VHT20): Duty cycle = $1.3575 \text{ ms} / 1.36875 \text{ ms} = 0.992$

802.11ac (VHT40): Duty cycle = $0.6745 \text{ ms} / 0.683 \text{ ms} = 0.988$

802.11ac (VHT80): Duty cycle = $0.3355 \text{ ms} / 0.3435 \text{ ms} = 0.977$, Duty factor = $10 * \log(1/0.977) = 0.1$

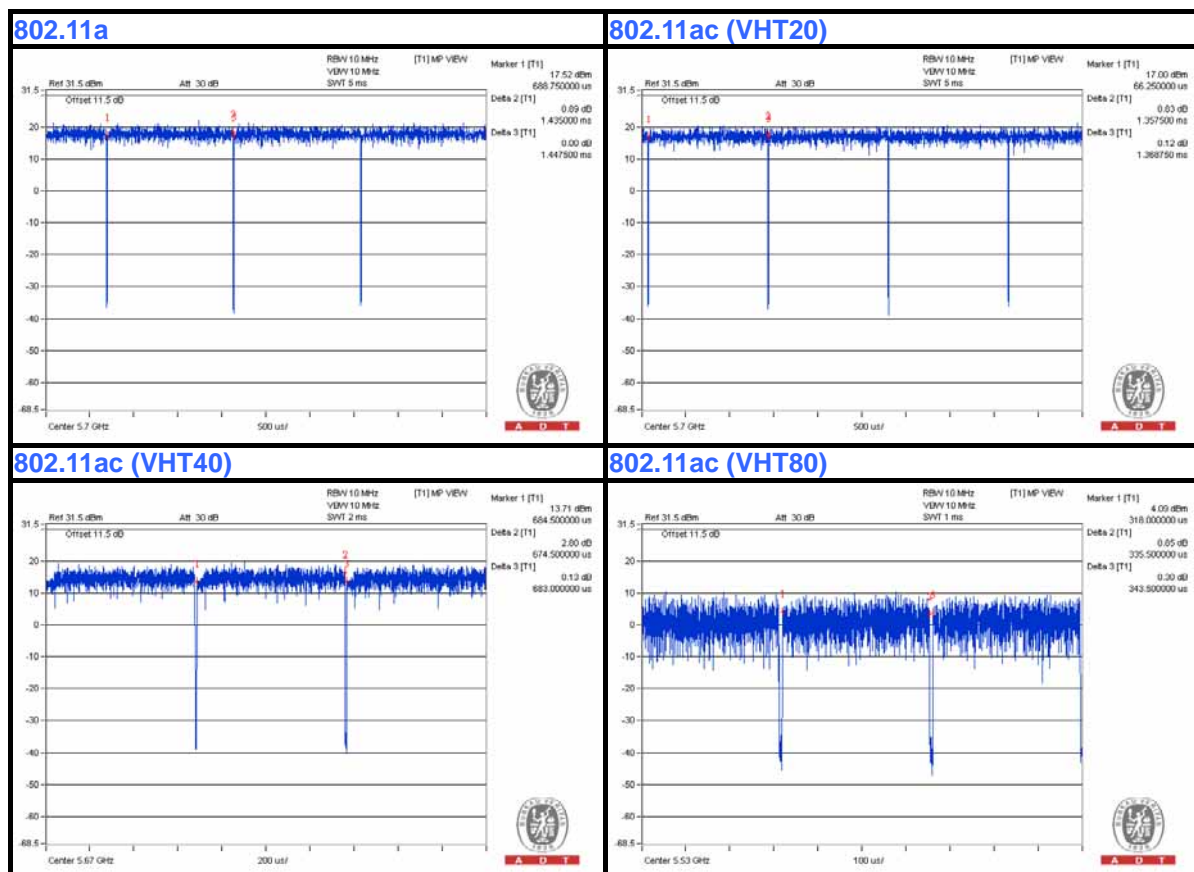

3.5 DESCRIPTION OF SUPPORT UNITS

The EUT has been tested as an independent unit together with other necessary accessories or support units. The following support units or accessories were used to form a representative test configuration during the tests.

No.	Product	Brand	Model No.	Serial No.	FCC ID
1	NOTEBOOK COMPUTER	DELL	PP32LA	HSLB32S	FCC DoC
2	TEST TOOL	FOXCONN	NA	NA	NA

No.	Signal cable description
1	NA
2	Data cable, 0.1m

Note: The power cords of the above support units were unshielded (1.8m).

3.6 CONFIGURATION OF SYSTEM UNDER TEST

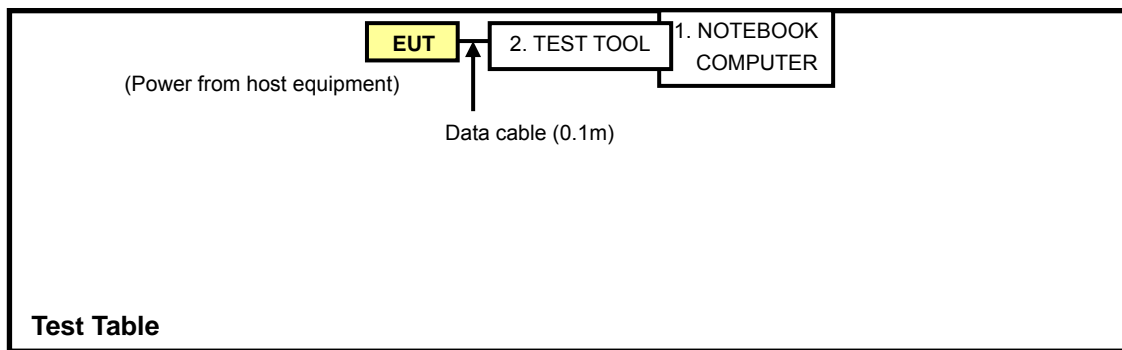



A D T

4. TEST TYPES AND RESULTS

4.1 CONDUCTED EMISSION MEASUREMENT

4.1.1 LIMITS OF CONDUCTED EMISSION MEASUREMENT

FREQUENCY OF EMISSION (MHz)	CONDUCTED LIMIT (dBµV)	
	Quasi-peak	Average
0.15-0.5	66 to 56	56 to 46
0.5-5	56	46
5-30	60	50

- NOTE:**
- The lower limit shall apply at the transition frequencies.
 - The limit decreases in line with the logarithm of the frequency in the range of 0.15 to 0.50 MHz.

4.1.2 TEST INSTRUMENTS

DESCRIPTION & MANUFACTURER	MODEL NO.	SERIAL NO.	CALIBRATED DATE	CALIBRATED UNTIL
Test Receiver ROHDE & SCHWARZ	ESCS 30	100375	Apr. 29, 2014	Apr. 28, 2015
Line-Impedance Stabilization Network (for EUT) SCHWARZBECK	NSLK8127	8127-522	Sep. 12, 2013	Sep. 11, 2014
Line-Impedance Stabilization Network (for Peripheral)	ENV216	100071	Nov. 13, 2013	Nov. 12, 2014
RF Cable (JYEBAO)	5DFB	COCCAB-001	Mar. 10, 2014	Mar. 09, 2015
50 ohms Terminator	N/A	EMC-03	Sep. 24, 2013	Sep. 23, 2014
50 ohms Terminator	N/A	EMC-02	Oct. 01, 2013	Sep. 30, 2014
Software ADT	BV ADT_Cond_V7.3.7. 3	NA	NA	NA

Note:

- The calibration interval of the above test instruments is 12 months and the calibrations are traceable to NML/ROC and NIST/USA.
- The test was performed in Shielded Room No. C.
- The VCCI Con C Registration No. is C-3611.
- Tested Date: May 29, 2014

4.1.3 TEST PROCEDURES

- a. The EUT was placed 0.4 meters from the conducting wall of the shielded room with EUT being connected to the power mains through a line impedance stabilization network (LISN). Other support units were connected to the power mains through another LISN.
- b. The two LISNs provide 50 ohm/ 50uH of coupling impedance for the measuring instrument.
- c. Both lines of the power mains connected to the EUT were checked for maximum conducted interference.
- d. The frequency range from 150kHz to 30MHz was searched. Emission level under (Limit – 20dB) was not recorded.

NOTE:

1. The resolution bandwidth of test receiver is 9kHz for Quasi-peak detection (QP) & Average detection (AV).

4.1.4 DEVIATION FROM TEST STANDARD

No deviation

4.1.5 TEST SETUP

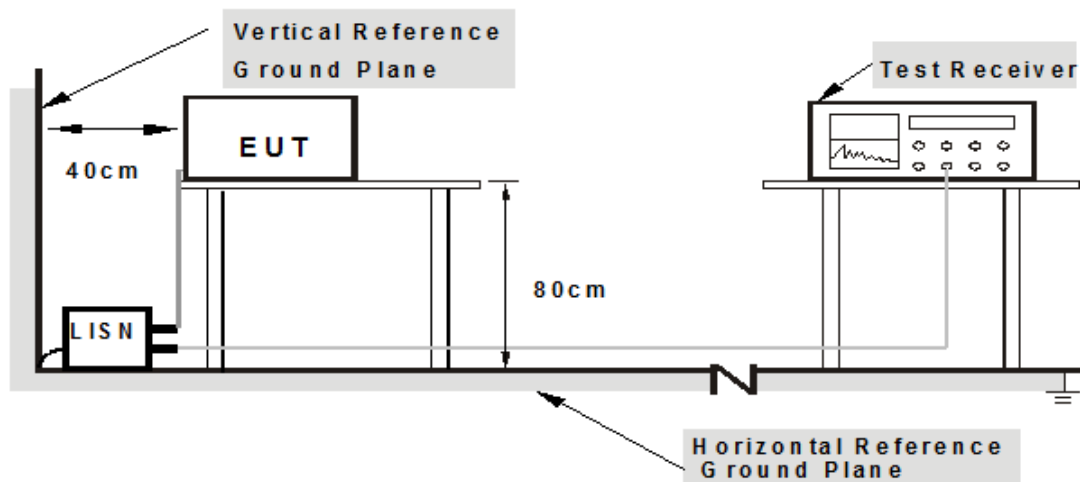

Note: 1. Support units were connected to second LISN.

For the actual test configuration, please refer to the related item – Photographs of the Test Configuration.

4.1.6 EUT OPERATING CONDITIONS

1. Connect the EUT with the support unit 1 (Notebook Computer) which is placed on a testing table.
2. The communication partner run test program “QA Tool[V1.0.3.0]” to enable EUT under transmission/receiving condition continuously at specific channel frequency.

4.1.7 TEST RESULTS

PHASE	Line (L)	DETECTOR FUNCTION	Quasi-Peak (QP) / Average (AV)
--------------	----------	--------------------------	--------------------------------

No	Freq. [MHz]	Corr. Factor (dB)	Reading Value [dB (uV)]		Emission Level [dB (uV)]		Limit [dB (uV)]		Margin (dB)	
			Q.P.	AV.	Q.P.	AV.	Q.P.	AV.	Q.P.	AV.
1	0.56797	0.10	38.73	25.67	38.83	25.77	56.00	46.00	-17.17	-20.23
2	0.63828	0.11	40.07	24.65	40.18	24.76	56.00	46.00	-15.82	-21.24
3	0.79063	0.12	34.88	22.77	35.00	22.89	56.00	46.00	-21.00	-23.11
4	0.94297	0.13	31.89	15.97	32.02	16.10	56.00	46.00	-23.98	-29.90
5	3.14453	0.22	27.48	21.19	27.70	21.41	56.00	46.00	-28.30	-24.59
6	18.18750	0.67	27.53	22.26	28.20	22.93	60.00	50.00	-31.80	-27.07

REMARKS:

1. Q.P. and AV. are abbreviations of quasi-peak and average individually.
2. The emission levels of other frequencies were very low against the limit.
3. Margin value = Emission Level – Limit value
4. Correction Factor = Insertion loss + Cable loss
5. Emission Level = Correction Factor + Reading Value

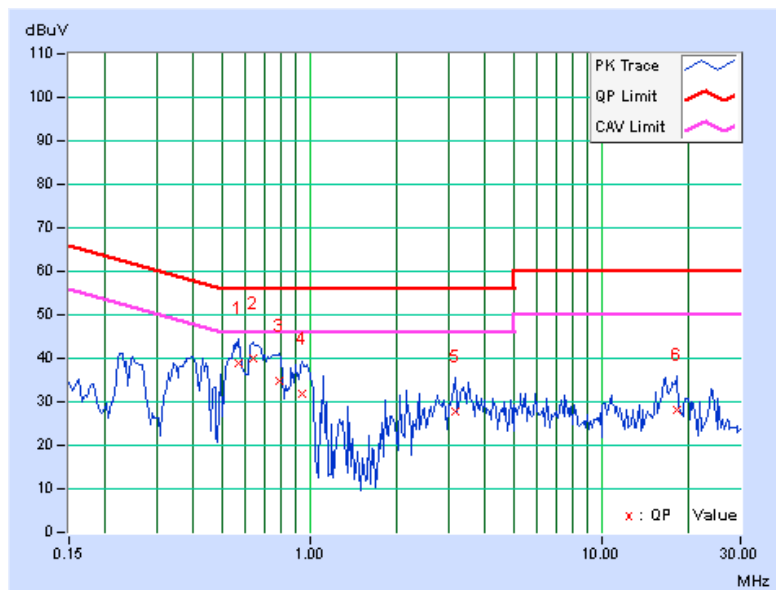

PHASE	Neutral (N)	DETECTOR FUNCTION	Quasi-Peak (QP) / Average (AV)
-------	-------------	-------------------	--------------------------------

No	Freq. [MHz]	Corr. Factor [dB]	Reading Value [dB (uV)]		Emission Level [dB (uV)]		Limit [dB (uV)]		Margin (dB)	
			Q.P.	AV.	Q.P.	AV.	Q.P.	AV.	Q.P.	AV.
1	0.22422	0.07	42.81	31.90	42.88	31.97	62.66	52.66	-19.78	-20.69
2	0.46641	0.09	38.17	25.05	38.26	25.14	56.58	46.58	-18.31	-21.43
3	0.56406	0.10	38.71	25.85	38.81	25.95	56.00	46.00	-17.19	-20.05
4	0.67344	0.11	40.73	27.09	40.84	27.20	56.00	46.00	-15.16	-18.80
5	0.77500	0.11	35.75	21.00	35.86	21.11	56.00	46.00	-20.14	-24.89
6	1.16797	0.14	34.30	18.66	34.44	18.80	56.00	46.00	-21.56	-27.20

REMARKS:

1. Q.P. and AV. are abbreviations of quasi-peak and average individually.
2. The emission levels of other frequencies were very low against the limit.
3. Margin value = Emission Level – Limit value
4. Correction Factor = Insertion loss + Cable loss
5. Emission Level = Correction Factor + Reading Value

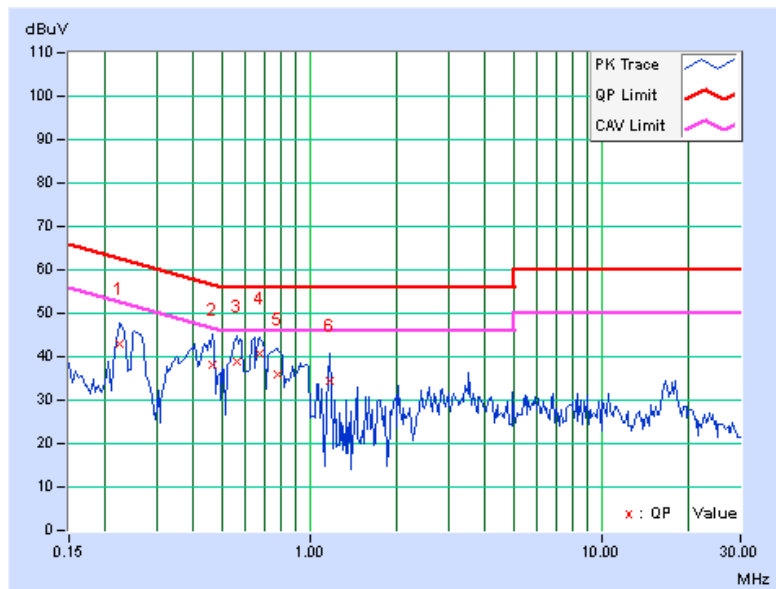

4.2 RADIATED EMISSION AND BANDEDGE MEASUREMENT

4.2.1 LIMITS OF RADIATED EMISSION AND BANDEDGE MEASUREMENT

Radiated emissions which fall in the restricted bands must comply with the radiated emission limits specified as below table:

Frequencies (MHz)	Field strength (microvolts/meter)	Measurement distance (meters)
0.009-0.490	2400/F(kHz)	300
0.490-1.705	24000/F(kHz)	30
1.705-30.0	30	30
30-88	100	3
88-216	150	3
216-960	200	3
Above 960	500	3

NOTE:

1. The lower limit shall apply at the transition frequencies.
2. Emission level (dBuV/m) = 20 log Emission level (uV/m).
3. For frequencies above 1000MHz, the field strength limits are based on average detector, however, the peak field strength of any emission shall not exceed the maximum permitted average limits, specified above by more than 20dB under any condition of modulation.



4.2.2 LIMITS OF UNWANTED EMISSION OUT OF THE RESTRICTED BANDS

APPLICABLE TO	LIMIT	
789033 D02 General UNII Test Procedures New Rules v01	FIELD STRENGTH AT 3m	
	PK:74 (dBµV/m)	AV:54 (dBµV/m)
APPLICABLE TO	EIRP LIMIT	EQUIVALENT FIELD STRENGTH AT 3m
15.407(b)(1)	PK:-27 (dBm/MHz)	PK:68.2(dBµV/m)
15.407(b)(2)		
15.407(b)(3)		
15.407(b)(4)	PK:-27 (dBm/MHz) ^{*1} PK:-17 (dBm/MHz) ^{*2}	PK: 68.2(dBµV/m) ^{*1} PK:78.2 (dBµV/m) ^{*2}

NOTE: ^{*1} beyond 10MHz of the band edge ^{*2} within 10 MHz of band edge

The following formula is used to convert the equipment isotropic radiated power (eirp) to field strength:

$$E = \frac{1000000\sqrt{30P}}{3} \mu\text{V/m, where } P \text{ is the eirp (Watts).}$$



A D T

4.2.3 TEST INSTRUMENTS

DESCRIPTION & MANUFACTURER	MODEL NO.	SERIAL NO.	CALIBRATED DATE	CALIBRATED UNTIL
MXE EMI Receiver Agilent	N9038A	MY50010156	Jan. 15, 2014	Jan. 14, 2015
Pre-Amplifier Mini-Circuits	ZFL-1000VH2 B	AMP-ZFL-04	Nov. 13, 2013	Nov. 12, 2014
Trilog Broadband Antenna SCHWARZBECK	VULB 9168	9168-361	Feb. 27, 2014	Feb. 26, 2015
RF Cable	NA	CHHCAB_001	Oct. 06, 2013	Oct. 05, 2014
Spectrum Analyzer R&S	FSV40	100964	July 15, 2013	July 14, 2014
Horn_Antenna AISI	AIH.8018	0000220091110	Dec. 06, 2013	Dec. 05, 2014
Pre-Amplifier Agilent	8449B	3008A01923	Oct. 29, 2013	Oct. 28, 2014
RF Cable	NA	RF104-205 RF104-207 RF104-202	Dec. 12, 2013	Dec. 11, 2014
Spectrum Analyzer Agilent	E4446A	MY48250253	Aug. 28, 2013	Aug. 27, 2014
Pre-Amplifier SPACEK LABS	SLKKa-48-6	9K16	Nov. 13, 2013	Nov. 12, 2014
Horn_Antenna SCHWARZBECK	BBHA 9170	9170-424	Oct. 08, 2013	Oct. 07, 2014
Software	ADT_Radiated _V8.7.07	NA	NA	NA
Antenna Tower & Turn Table CT	NA	NA	NA	NA

Note:

1. The calibration interval of the above test instruments is 12 months and the calibrations are traceable to NML/ROC and NIST/USA.
2. The horn antenna, preamplifier (model: 8449B) are used only for the measurement of emission frequency above 1GHz if tested.
- 3 The test was performed in 966 Chamber No. H.
4. The FCC Site Registration No. is 797305.
- 5 The CANADA Site Registration No. is IC 7450H-3.
- 6 Tested Date: May 27 to June 13, 2014

4.2.4 TEST PROCEDURES

- a. The EUT was placed on the top of a rotating table 0.8 meters above the ground at 3 meter chamber room for test. The table was rotated 360 degrees to determine the position of the highest radiation.
- b. The EUT was set 3 meters away from the interference-receiving antenna, which was mounted on the top of a variable-height antenna tower.
- c. The height of antenna is varied from one meter to four meters above the ground to determine the maximum value of the field strength. Both horizontal and vertical polarizations of the antenna are set to make the measurement.
- d. For each suspected emission, the EUT was arranged to its worst case and then the antenna was tuned to heights from 1 meter to 4 meters and the rotatable table was turned from 0 degrees to 360 degrees to find the maximum reading.
- e. The test-receiver system was set to quasi-peak detect function and specified bandwidth with maximum hold mode when the test frequency is below 1 GHz.
- f. The test-receiver system was set to peak and average detect function and specified bandwidth with maximum hold mode when the test frequency is above 1 GHz. If the peak reading value also meets average limit, measurement with the average detector is unnecessary.

Note:

1. The resolution bandwidth and video bandwidth of test receiver/spectrum analyzer is 120kHz for Quasi-peak detection (QP) at frequency below 1GHz.
2. The resolution bandwidth of test receiver/spectrum analyzer is 1 MHz and the video bandwidth is 3 MHz for Peak detection (PK) at frequency above 1GHz.
3. The resolution bandwidth of test receiver/spectrum analyzer is 1MHz and the video bandwidth is 3MHz for RMS Average (Duty cycle < 98%) for Average detection (AV) at frequency above 1GHz, then the measurement results was added to a correction factor ($10 \log(1/\text{duty cycle})$).
4. The resolution bandwidth of test receiver/spectrum analyzer is 1MHz and the video bandwidth is 10Hz (Duty cycle $\geq 98\%$) for Average detection (AV) at frequency above 1GHz.
5. All modes of operation were investigated and the worst-case emissions are reported.

4.2.5 DEVIATION FROM TEST STANDARD

No deviation

4.2.6 TEST SETUP

<Frequency Range below 1GHz>

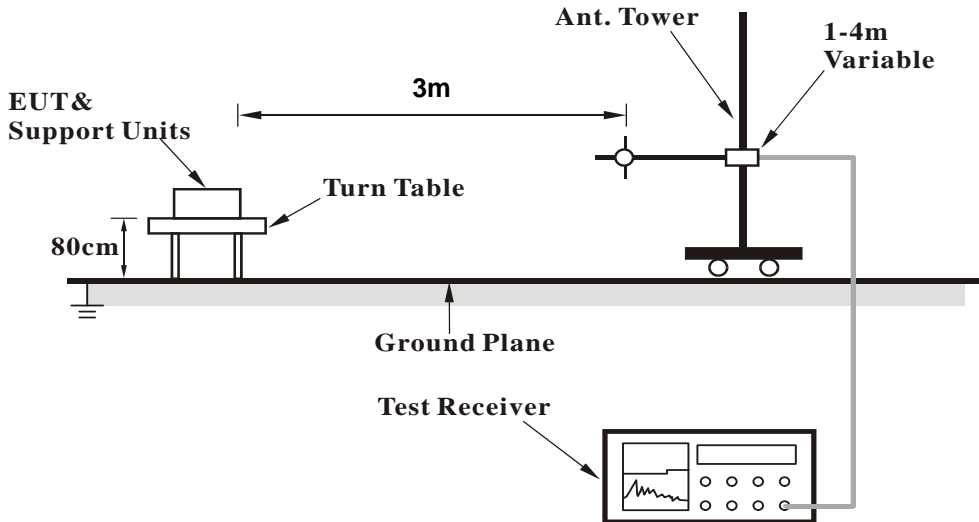

<Frequency Range above 1GHz>

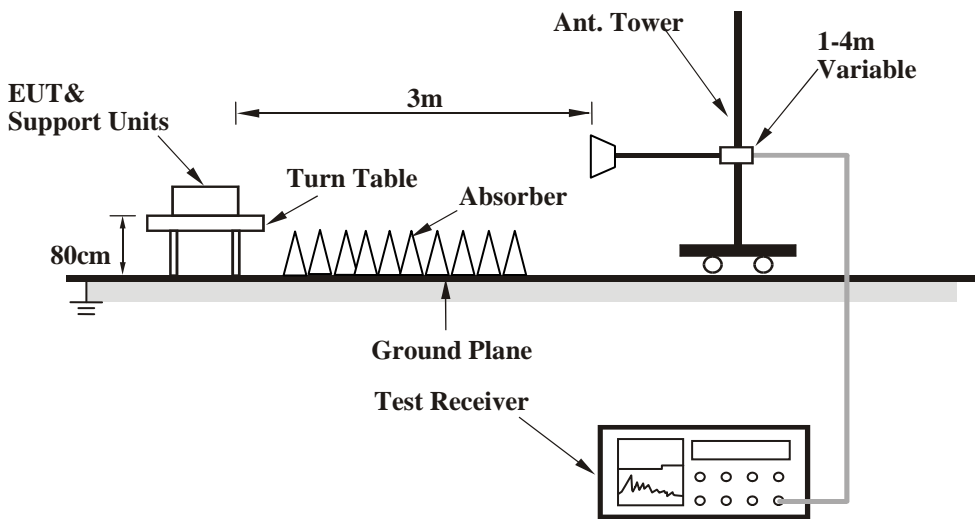

For the actual test configuration, please refer to the related item – Photographs of the Test Configuration.

4.2.7 EUT OPERATING CONDITION

Same as 4.1.6



A D T

4.2.8 TEST RESULTS

BELOW 1GHz WORST-CASE DATA

802.11ac (VHT20)

CHANNEL	TX Channel 157	DETECTOR FUNCTION	Quasi-Peak (QP)
FREQUENCY RANGE	Below 1GHz		

ANTENNA POLARITY & TEST DISTANCE: HORIZONTAL AT 3 M

NO.	FREQ. (MHz)	EMISSION LEVEL (dBuV/m)	LIMIT (dBuV/m)	MARGIN (dB)	ANTENNA HEIGHT (m)	TABLE ANGLE (Degree)	RAW VALUE (dBuV)	CORRECTION FACTOR (dB/m)
1	78.16	33.3 QP	40.0	-6.7	2.00 H	237	50.53	-17.25
2	215.46	36.3 QP	43.5	-7.2	1.50 H	0	52.07	-15.74
3	239.57	41.6 QP	46.0	-4.4	1.50 H	0	55.45	-13.81
4	293.31	36.4 QP	46.0	-9.6	1.50 H	0	48.37	-11.97
5	407.96	34.7 QP	46.0	-11.3	2.00 H	207	43.87	-9.13
6	696.05	36.6 QP	46.0	-9.4	1.00 H	307	39.75	-3.17

ANTENNA POLARITY & TEST DISTANCE: VERTICAL AT 3 M

NO.	FREQ. (MHz)	EMISSION LEVEL (dBuV/m)	LIMIT (dBuV/m)	MARGIN (dB)	ANTENNA HEIGHT (m)	TABLE ANGLE (Degree)	RAW VALUE (dBuV)	CORRECTION FACTOR (dB/m)
1	82.28	30.5 QP	40.0	-9.5	1.00 V	300	48.56	-18.05
2	157.46	31.7 QP	43.5	-11.8	1.00 V	265	44.20	-12.51
3	234.57	37.9 QP	46.0	-8.1	1.00 V	306	52.18	-14.24
4	297.53	35.5 QP	46.0	-10.5	2.00 V	36	47.32	-11.83
5	749.89	37.9 QP	46.0	-8.1	1.50 V	291	39.54	-1.64
6	850.09	36.0 QP	46.0	-10.0	1.00 V	242	36.33	-0.32

REMARKS:

1. Emission Level(dBuV/m) = Raw Value(dBuV) + Correction Factor(dB/m)
2. Correction Factor(dB/m) = Antenna Factor(dB/m) + Cable Factor(dB) – Pre-Amplifier Factor(dB)
3. The other emission levels were very low against the limit.
4. Margin value = Emission Level – Limit value



A D T

ABOVE 1GHz DATA

802.11a

CHANNEL	TX Channel 36	DETECTOR FUNCTION	Peak (PK)
FREQUENCY RANGE	1GHz ~ 40GHz		Average (AV)

ANTENNA POLARITY & TEST DISTANCE: HORIZONTAL AT 3 M

NO.	FREQ. (MHz)	EMISSION LEVEL (dBuV/m)	LIMIT (dBuV/m)	MARGIN (dB)	ANTENNA HEIGHT (m)	TABLE ANGLE (Degree)	RAW VALUE (dBuV)	CORRECTION FACTOR (dB/m)
1	5150.00	70.1 PK	74.0	-3.9	1.35 H	92	29.54	40.56
2	5150.00	48.6 AV	54.0	-5.4	1.35 H	92	8.04	40.56
3	*5180.00	111.2 PK			1.35 H	62	70.56	40.64
4	*5180.00	102.4 AV			1.35 H	62	61.76	40.64
5	#10360.00	55.2 PK	74.0	-18.8	1.03 H	146	8.45	46.75
6	#10360.00	43.6 AV	54.0	-10.4	1.03 H	146	-3.15	46.75
7	15540.00	69.5 PK	74.0	-4.5	1.02 H	280	18.30	51.20
8	15540.00	53.8 AV	54.0	-0.2	1.02 H	280	2.60	51.20

ANTENNA POLARITY & TEST DISTANCE: VERTICAL AT 3 M

NO.	FREQ. (MHz)	EMISSION LEVEL (dBuV/m)	LIMIT (dBuV/m)	MARGIN (dB)	ANTENNA HEIGHT (m)	TABLE ANGLE (Degree)	RAW VALUE (dBuV)	CORRECTION FACTOR (dB/m)
1	5150.00	73.3 PK	74.0	-0.7	1.03 V	280	32.74	40.56
2	5150.00	50.9 AV	54.0	-3.1	1.03 V	280	10.34	40.56
3	*5180.00	114.6 PK			1.03 V	280	73.96	40.64
4	*5180.00	105.7 AV			1.03 V	280	65.06	40.64
5	#10360.00	53.7 PK	74.0	-20.3	1.14 V	81	6.95	46.75
6	#10360.00	41.5 AV	54.0	-12.5	1.14 V	81	-5.25	46.75
7	15540.00	65.2 PK	74.0	-8.8	1.26 V	23	14.00	51.20
8	15540.00	52.3 AV	54.0	-1.7	1.26 V	23	1.10	51.20

REMARKS:

1. Emission Level(dBuV/m) = Raw Value(dBuV) + Correction Factor(dB/m)
2. Correction Factor(dB/m) = Antenna Factor(dB/m) + Cable Factor(dB) – Pre-Amplifier Factor(dB)
3. The other emission levels were very low against the limit.
4. Margin value = Emission Level – Limit value
5. " * ": Fundamental frequency.
6. " # ": The radiated frequency is out of the restricted band.



A D T

CHANNEL	TX Channel 40	DETECTOR FUNCTION	Peak (PK)
FREQUENCY RANGE	1GHz ~ 40GHz		Average (AV)

ANTENNA POLARITY & TEST DISTANCE: HORIZONTAL AT 3 M

NO.	FREQ. (MHz)	EMISSION LEVEL (dBuV/m)	LIMIT (dBuV/m)	MARGIN (dB)	ANTENNA HEIGHT (m)	TABLE ANGLE (Degree)	RAW VALUE (dBuV)	CORRECTION FACTOR (dB/m)
1	*5200.00	109.4 PK			1.29 H	69	68.72	40.68
2	*5200.00	100.6 AV			1.29 H	69	59.92	40.68
3	#10400.00	55.5 PK	74.0	-18.5	1.04 H	131	8.79	46.71
4	#10400.00	41.6 AV	54.0	-12.4	1.04 H	131	-5.11	46.71
5	15600.00	69.4 PK	74.0	-4.6	1.00 H	278	18.12	51.28
6	15600.00	53.5 AV	54.0	-0.5	1.00 H	278	2.22	51.28

ANTENNA POLARITY & TEST DISTANCE: VERTICAL AT 3 M

NO.	FREQ. (MHz)	EMISSION LEVEL (dBuV/m)	LIMIT (dBuV/m)	MARGIN (dB)	ANTENNA HEIGHT (m)	TABLE ANGLE (Degree)	RAW VALUE (dBuV)	CORRECTION FACTOR (dB/m)
1	*5200.00	113.3 PK			1.05 V	290	72.62	40.68
2	*5200.00	104.3 AV			1.05 V	290	63.62	40.68
3	#10400.00	53.3 PK	74.0	-20.7	1.12 V	76	6.59	46.71
4	#10400.00	40.2 AV	54.0	-13.8	1.12 V	76	-6.51	46.71
5	15600.00	64.6 PK	74.0	-9.4	1.24 V	19	13.32	51.28
6	15600.00	51.8 AV	54.0	-2.2	1.24 V	19	0.52	51.28

REMARKS:

1. Emission Level(dBuV/m) = Raw Value(dBuV) + Correction Factor(dB/m)
2. Correction Factor(dB/m) = Antenna Factor(dB/m) + Cable Factor(dB) – Pre-Amplifier Factor(dB)
3. The other emission levels were very low against the limit.
4. Margin value = Emission Level – Limit value
5. " * ": Fundamental frequency.
6. " # ": The radiated frequency is out of the restricted band.



A D T

CHANNEL	TX Channel 48	DETECTOR FUNCTION	Peak (PK)
FREQUENCY RANGE	1GHz ~ 40GHz		Average (AV)

ANTENNA POLARITY & TEST DISTANCE: HORIZONTAL AT 3 M

NO.	FREQ. (MHz)	EMISSION LEVEL (dBuV/m)	LIMIT (dBuV/m)	MARGIN (dB)	ANTENNA HEIGHT (m)	TABLE ANGLE (Degree)	RAW VALUE (dBuV)	CORRECTION FACTOR (dB/m)
1	*5240.00	110.1 PK			1.39 H	65	69.35	40.75
2	*5240.00	101.3 AV			1.39 H	65	60.55	40.75
3	#10480.00	55.3 PK	74.0	-18.7	1.06 H	144	8.50	46.80
4	#10480.00	43.9 AV	54.0	-10.1	1.06 H	144	-2.90	46.80
5	15720.00	66.7 PK	74.0	-7.3	1.00 H	271	15.36	51.34
6	15720.00	53.0 AV	54.0	-1.0	1.00 H	271	1.66	51.34

ANTENNA POLARITY & TEST DISTANCE: VERTICAL AT 3 M

NO.	FREQ. (MHz)	EMISSION LEVEL (dBuV/m)	LIMIT (dBuV/m)	MARGIN (dB)	ANTENNA HEIGHT (m)	TABLE ANGLE (Degree)	RAW VALUE (dBuV)	CORRECTION FACTOR (dB/m)
1	*5240.00	114.0 PK			1.00 V	283	73.25	40.75
2	*5240.00	105.1 AV			1.00 V	283	64.35	40.75
3	#10480.00	53.8 PK	74.0	-20.2	1.15 V	75	7.00	46.80
4	#10480.00	41.4 AV	54.0	-12.6	1.15 V	75	-5.40	46.80
5	15720.00	64.7 PK	74.0	-9.3	1.31 V	34	13.36	51.34
6	15720.00	52.0 AV	54.0	-2.0	1.31 V	34	0.66	51.34

REMARKS:

1. Emission Level(dBuV/m) = Raw Value(dBuV) + Correction Factor(dB/m)
2. Correction Factor(dB/m) = Antenna Factor(dB/m) + Cable Factor(dB) – Pre-Amplifier Factor(dB)
3. The other emission levels were very low against the limit.
4. Margin value = Emission Level – Limit value
5. " * ": Fundamental frequency.
6. " # ": The radiated frequency is out of the restricted band.



A D T

CHANNEL	TX Channel 52	DETECTOR FUNCTION	Peak (PK)
FREQUENCY RANGE	1GHz ~ 40GHz		Average (AV)

ANTENNA POLARITY & TEST DISTANCE: HORIZONTAL AT 3 M

NO.	FREQ. (MHz)	EMISSION LEVEL (dBuV/m)	LIMIT (dBuV/m)	MARGIN (dB)	ANTENNA HEIGHT (m)	TABLE ANGLE (Degree)	RAW VALUE (dBuV)	CORRECTION FACTOR (dB/m)
1	*5260.00	111.4 PK			1.34 H	76	70.61	40.79
2	*5260.00	101.7 AV			1.34 H	76	60.91	40.79
3	#10520.00	55.0 PK	74.0	-19.0	1.00 H	143	8.14	46.86
4	#10520.00	43.5 AV	54.0	-10.5	1.00 H	143	-3.36	46.86
5	15780.00	67.9 PK	74.0	-6.1	1.01 H	273	16.46	51.44
6	15780.00	53.4 AV	54.0	-0.6	1.01 H	273	1.96	51.44

ANTENNA POLARITY & TEST DISTANCE: VERTICAL AT 3 M

NO.	FREQ. (MHz)	EMISSION LEVEL (dBuV/m)	LIMIT (dBuV/m)	MARGIN (dB)	ANTENNA HEIGHT (m)	TABLE ANGLE (Degree)	RAW VALUE (dBuV)	CORRECTION FACTOR (dB/m)
1	*5260.00	114.8 PK			1.04 V	280	74.01	40.79
2	*5260.00	105.7 AV			1.04 V	280	64.91	40.79
3	#10520.00	53.4 PK	74.0	-20.6	1.16 V	77	6.54	46.86
4	#10520.00	41.3 AV	54.0	-12.7	1.16 V	77	-5.56	46.86
5	15780.00	65.8 PK	74.0	-8.2	1.31 V	11	14.36	51.44
6	15780.00	52.8 AV	54.0	-1.2	1.31 V	11	1.36	51.44

REMARKS:

1. Emission Level(dBuV/m) = Raw Value(dBuV) + Correction Factor(dB/m)
2. Correction Factor(dB/m) = Antenna Factor(dB/m) + Cable Factor(dB) – Pre-Amplifier Factor(dB)
3. The other emission levels were very low against the limit.
4. Margin value = Emission Level – Limit value
5. " * ": Fundamental frequency.
6. " # ": The radiated frequency is out of the restricted band.



A D T

CHANNEL	TX Channel 60	DETECTOR FUNCTION	Peak (PK)
FREQUENCY RANGE	1GHz ~ 40GHz		Average (AV)

ANTENNA POLARITY & TEST DISTANCE: HORIZONTAL AT 3 M

NO.	FREQ. (MHz)	EMISSION LEVEL (dBuV/m)	LIMIT (dBuV/m)	MARGIN (dB)	ANTENNA HEIGHT (m)	TABLE ANGLE (Degree)	RAW VALUE (dBuV)	CORRECTION FACTOR (dB/m)
1	*5300.00	111.9 PK			1.37 H	78	71.04	40.86
2	*5300.00	102.3 AV			1.37 H	78	61.44	40.86
3	10600.00	55.7 PK	74.0	-18.3	1.00 H	148	8.64	47.06
4	10600.00	44.0 AV	54.0	-10.0	1.00 H	148	-3.06	47.06
5	15900.00	66.3 PK	74.0	-7.7	1.00 H	273	14.75	51.55
6	15900.00	53.5 AV	54.0	-0.5	1.00 H	273	1.95	51.55

ANTENNA POLARITY & TEST DISTANCE: VERTICAL AT 3 M

NO.	FREQ. (MHz)	EMISSION LEVEL (dBuV/m)	LIMIT (dBuV/m)	MARGIN (dB)	ANTENNA HEIGHT (m)	TABLE ANGLE (Degree)	RAW VALUE (dBuV)	CORRECTION FACTOR (dB/m)
1	*5300.00	115.3 PK			1.06 V	284	74.44	40.86
2	*5300.00	106.2 AV			1.06 V	284	65.34	40.86
3	10600.00	53.1 PK	74.0	-20.9	1.15 V	84	6.04	47.06
4	10600.00	40.8 AV	54.0	-13.2	1.15 V	84	-6.26	47.06
5	15900.00	65.0 PK	74.0	-9.0	1.36 V	20	13.45	51.55
6	15900.00	52.3 AV	54.0	-1.7	1.36 V	20	0.75	51.55

REMARKS:

1. Emission Level(dBuV/m) = Raw Value(dBuV) + Correction Factor(dB/m)
2. Correction Factor(dB/m) = Antenna Factor(dB/m) + Cable Factor(dB) – Pre-Amplifier Factor(dB)
3. The other emission levels were very low against the limit.
4. Margin value = Emission Level – Limit value
5. " * ": Fundamental frequency.



A D T

CHANNEL	TX Channel 64	DETECTOR FUNCTION	Peak (PK)
FREQUENCY RANGE	1GHz ~ 40GHz		Average (AV)

ANTENNA POLARITY & TEST DISTANCE: HORIZONTAL AT 3 M

NO.	FREQ. (MHz)	EMISSION LEVEL (dBuV/m)	LIMIT (dBuV/m)	MARGIN (dB)	ANTENNA HEIGHT (m)	TABLE ANGLE (Degree)	RAW VALUE (dBuV)	CORRECTION FACTOR (dB/m)
1	*5320.00	111.4 PK			1.36 H	60	70.51	40.89
2	*5320.00	101.7 AV			1.36 H	60	60.81	40.89
3	5350.00	70.3 PK	74.0	-3.7	1.36 H	60	29.36	40.94
4	5350.00	45.4 AV	54.0	-8.6	1.36 H	60	4.46	40.94
5	10640.00	54.9 PK	74.0	-19.1	1.00 H	148	7.86	47.04
6	10640.00	43.7 AV	54.0	-10.3	1.00 H	148	-3.34	47.04
7	15960.00	69.3 PK	74.0	-4.7	1.02 H	288	17.77	51.53
8	15960.00	53.5 AV	54.0	-0.5	1.02 H	288	1.97	51.53

ANTENNA POLARITY & TEST DISTANCE: VERTICAL AT 3 M

NO.	FREQ. (MHz)	EMISSION LEVEL (dBuV/m)	LIMIT (dBuV/m)	MARGIN (dB)	ANTENNA HEIGHT (m)	TABLE ANGLE (Degree)	RAW VALUE (dBuV)	CORRECTION FACTOR (dB/m)
1	*5320.00	114.9 PK			1.09 V	281	74.01	40.89
2	*5320.00	105.6 AV			1.09 V	281	64.71	40.89
3	5350.00	72.2 PK	74.0	-1.8	1.04 V	355	31.26	40.94
4	5350.00	47.4 AV	54.0	-6.6	1.04 V	355	6.46	40.94
5	10640.00	53.6 PK	74.0	-20.4	1.16 V	74	6.56	47.04
6	10640.00	41.4 AV	54.0	-12.6	1.16 V	74	-5.64	47.04
7	15960.00	65.7 PK	74.0	-8.3	1.31 V	0	14.17	51.53
8	15960.00	52.8 AV	54.0	-1.2	1.31 V	0	1.27	51.53

REMARKS:

1. Emission Level(dBuV/m) = Raw Value(dBuV) + Correction Factor(dB/m)
2. Correction Factor(dB/m) = Antenna Factor(dB/m) + Cable Factor(dB) – Pre-Amplifier Factor(dB)
3. The other emission levels were very low against the limit.
4. Margin value = Emission Level – Limit value
5. " * ": Fundamental frequency.



A D T

CHANNEL	TX Channel 100	DETECTOR FUNCTION	Peak (PK)
FREQUENCY RANGE	1GHz ~ 40GHz		Average (AV)

ANTENNA POLARITY & TEST DISTANCE: HORIZONTAL AT 3 M

NO.	FREQ. (MHz)	EMISSION LEVEL (dBuV/m)	LIMIT (dBuV/m)	MARGIN (dB)	ANTENNA HEIGHT (m)	TABLE ANGLE (Degree)	RAW VALUE (dBuV)	CORRECTION FACTOR (dB/m)
1	5460.00	58.7 PK	74.0	-15.3	1.33 H	86	17.58	41.12
2	5460.00	42.2 AV	54.0	-11.8	1.33 H	86	1.08	41.12
3	#5470.00	71.4 PK	74.0	-2.6	1.33 H	360	30.26	41.14
4	#5470.00	50.3 AV	54.0	-3.7	1.33 H	360	9.16	41.14
5	*5500.00	112.3 PK			1.33 H	86	71.10	41.20
6	*5500.00	102.8 AV			1.33 H	86	61.60	41.20
7	11000.00	55.3 PK	74.0	-18.7	1.04 H	150	7.89	47.41
8	11000.00	43.7 AV	54.0	-10.3	1.04 H	150	-3.71	47.41
9	#16500.00	70.0 PK	74.0	-4.0	1.04 H	263	17.04	52.96
10	#16500.00	53.9 AV	54.0	-0.1	1.04 H	263	0.94	52.96

ANTENNA POLARITY & TEST DISTANCE: VERTICAL AT 3 M

NO.	FREQ. (MHz)	EMISSION LEVEL (dBuV/m)	LIMIT (dBuV/m)	MARGIN (dB)	ANTENNA HEIGHT (m)	TABLE ANGLE (Degree)	RAW VALUE (dBuV)	CORRECTION FACTOR (dB/m)
1	5460.00	60.4 PK	74.0	-13.6	1.08 V	347	19.28	41.12
2	5460.00	45.0 AV	54.0	-9.0	1.08 V	347	3.88	41.12
3	#5470.00	73.6 PK	74.0	-0.4	1.08 V	347	32.46	41.14
4	#5470.00	52.0 AV	54.0	-2.0	1.08 V	347	10.86	41.14
5	*5500.00	115.4 PK			1.09 V	294	74.20	41.20
6	*5500.00	106.0 AV			1.09 V	294	64.80	41.20
7	11000.00	53.7 PK	74.0	-20.3	1.16 V	88	6.29	47.41
8	11000.00	41.2 AV	54.0	-12.8	1.16 V	88	-6.21	47.41
9	#16500.00	64.8 PK	74.0	-9.2	1.36 V	33	11.84	52.96
10	#16500.00	51.9 AV	54.0	-2.1	1.36 V	33	-1.06	52.96

REMARKS:

1. Emission Level(dBuV/m) = Raw Value(dBuV) + Correction Factor(dB/m)
2. Correction Factor(dB/m) = Antenna Factor(dB/m) + Cable Factor(dB) – Pre-Amplifier Factor(dB)
3. The other emission levels were very low against the limit.
4. Margin value = Emission Level – Limit value
5. " * ": Fundamental frequency.
6. " # ": The radiated frequency is out of the restricted band.



A D T

CHANNEL	TX Channel 120	DETECTOR FUNCTION	Peak (PK)
FREQUENCY RANGE	1GHz ~ 40GHz		Average (AV)

ANTENNA POLARITY & TEST DISTANCE: HORIZONTAL AT 3 M

NO.	FREQ. (MHz)	EMISSION LEVEL (dBuV/m)	LIMIT (dBuV/m)	MARGIN (dB)	ANTENNA HEIGHT (m)	TABLE ANGLE (Degree)	RAW VALUE (dBuV)	CORRECTION FACTOR (dB/m)
1	*5600.00	114.1 PK			1.35 H	62	72.74	41.36
2	*5600.00	104.3 AV			1.35 H	62	62.94	41.36
3	7466.67	50.6 PK	74.0	-23.4	1.00 H	251	5.20	45.40
4	7466.67	37.6 AV	54.0	-16.4	1.00 H	251	-7.80	45.40
5	11200.00	55.6 PK	74.0	-18.4	1.10 H	152	8.48	47.12
6	11200.00	44.1 AV	54.0	-9.9	1.10 H	152	-3.02	47.12
7	#16800.00	67.4 PK	74.0	-6.6	1.00 H	270	13.65	53.75
8	#16800.00	53.2 AV	54.0	-0.8	1.00 H	270	-0.55	53.75

ANTENNA POLARITY & TEST DISTANCE: VERTICAL AT 3 M

NO.	FREQ. (MHz)	EMISSION LEVEL (dBuV/m)	LIMIT (dBuV/m)	MARGIN (dB)	ANTENNA HEIGHT (m)	TABLE ANGLE (Degree)	RAW VALUE (dBuV)	CORRECTION FACTOR (dB/m)
1	*5600.00	118.1 PK			1.30 V	163	76.74	41.36
2	*5600.00	108.8 AV			1.30 V	163	67.44	41.36
3	7466.67	51.7 PK	74.0	-22.3	1.09 V	143	6.30	45.40
4	7466.67	38.9 AV	54.0	-15.1	1.09 V	143	-6.50	45.40
5	11200.00	54.3 PK	74.0	-19.7	1.12 V	85	7.18	47.12
6	11200.00	41.9 AV	54.0	-12.1	1.12 V	85	-5.22	47.12
7	#16800.00	64.7 PK	74.0	-9.3	1.27 V	8	10.95	53.75
8	#16800.00	51.2 AV	54.0	-2.8	1.27 V	8	-2.55	53.75

REMARKS:

1. Emission Level(dBuV/m) = Raw Value(dBuV) + Correction Factor(dB/m)
2. Correction Factor(dB/m) = Antenna Factor(dB/m) + Cable Factor(dB) – Pre-Amplifier Factor(dB)
3. The other emission levels were very low against the limit.
4. Margin value = Emission Level – Limit value
5. " * ": Fundamental frequency.
6. " # ": The radiated frequency is out of the restricted band.



A D T

CHANNEL	TX Channel 140	DETECTOR FUNCTION	Peak (PK)
FREQUENCY RANGE	1GHz ~ 40GHz		Average (AV)

ANTENNA POLARITY & TEST DISTANCE: HORIZONTAL AT 3 M

NO.	FREQ. (MHz)	EMISSION LEVEL (dBuV/m)	LIMIT (dBuV/m)	MARGIN (dB)	ANTENNA HEIGHT (m)	TABLE ANGLE (Degree)	RAW VALUE (dBuV)	CORRECTION FACTOR (dB/m)
1	*5700.00	110.6 PK			1.43 H	70	69.15	41.45
2	*5700.00	101.1 AV			1.43 H	70	59.65	41.45
3	#5725.00	71.2 PK	74.0	-2.8	1.43 H	70	29.72	41.48
4	#5725.00	50.1 AV	54.0	-3.9	1.43 H	70	8.62	41.48
5	11400.00	55.1 PK	74.0	-18.9	1.05 H	131	8.01	47.09
6	11400.00	43.6 AV	54.0	-10.4	1.05 H	131	-3.49	47.09
7	#17100.00	69.9 PK	74.0	-4.1	1.00 H	269	15.54	54.36
8	#17100.00	53.8 AV	54.0	-0.2	1.00 H	269	-0.56	54.36

ANTENNA POLARITY & TEST DISTANCE: VERTICAL AT 3 M

NO.	FREQ. (MHz)	EMISSION LEVEL (dBuV/m)	LIMIT (dBuV/m)	MARGIN (dB)	ANTENNA HEIGHT (m)	TABLE ANGLE (Degree)	RAW VALUE (dBuV)	CORRECTION FACTOR (dB/m)
1	*5700.00	114.5 PK			1.41 V	354	73.05	41.45
2	*5700.00	104.6 AV			1.41 V	354	63.15	41.45
3	#5725.00	73.4 PK	74.0	-0.6	1.41 V	350	31.92	41.48
4	#5725.00	51.8 AV	54.0	-2.2	1.41 V	350	10.32	41.48
5	11400.00	53.6 PK	74.0	-20.4	1.12 V	87	6.51	47.09
6	11400.00	41.2 AV	54.0	-12.8	1.12 V	87	-5.89	47.09
7	#17100.00	64.5 PK	74.0	-9.5	1.32 V	21	10.14	54.36
8	#17100.00	52.0 AV	54.0	-2.0	1.32 V	21	-2.36	54.36

REMARKS:

1. Emission Level(dBuV/m) = Raw Value(dBuV) + Correction Factor(dB/m)
2. Correction Factor(dB/m) = Antenna Factor(dB/m) + Cable Factor(dB) – Pre-Amplifier Factor(dB)
3. The other emission levels were very low against the limit.
4. Margin value = Emission Level – Limit value
5. " * ": Fundamental frequency.
6. " # ": The radiated frequency is out of the restricted band.



A D T

CHANNEL	TX Channel 149	DETECTOR FUNCTION	Peak (PK)
FREQUENCY RANGE	1GHz ~ 40GHz		Average (AV)

ANTENNA POLARITY & TEST DISTANCE: HORIZONTAL AT 3 M

NO.	FREQ. (MHz)	EMISSION LEVEL (dBuV/m)	LIMIT (dBuV/m)	MARGIN (dB)	ANTENNA HEIGHT (m)	TABLE ANGLE (Degree)	RAW VALUE (dBuV)	CORRECTION FACTOR (dB/m)
1	#5715.00	68.5 PK	74.0	-5.5	1.20 H	293	27.04	41.46
2	#5715.00	50.8 AV	54.0	-3.2	1.20 H	293	9.34	41.46
3	#5725.00	72.2 PK	78.2	-6.0	1.20 H	293	30.72	41.48
4	*5745.00	107.5 PK			1.21 H	312	66.00	41.50
5	*5745.00	97.8 AV			1.21 H	312	56.30	41.50
6	11490.00	54.8 PK	74.0	-19.2	1.00 H	133	7.66	47.14
7	11490.00	43.3 AV	54.0	-10.7	1.00 H	133	-3.84	47.14
8	#17235.00	63.9 PK	74.0	-10.1	1.02 H	293	9.04	54.86
9	#17235.00	50.1 AV	54.0	-3.9	1.02 H	293	-4.76	54.86

ANTENNA POLARITY & TEST DISTANCE: VERTICAL AT 3 M

NO.	FREQ. (MHz)	EMISSION LEVEL (dBuV/m)	LIMIT (dBuV/m)	MARGIN (dB)	ANTENNA HEIGHT (m)	TABLE ANGLE (Degree)	RAW VALUE (dBuV)	CORRECTION FACTOR (dB/m)
1	#5715.00	71.7 PK	74.0	-2.3	1.24 V	90	30.24	41.46
2	#5715.00	52.8 AV	54.0	-1.2	1.24 V	90	11.34	41.46
3	#5725.00	77.1 PK	78.2	-1.1	1.24 V	90	35.62	41.48
4	*5745.00	112.0 PK			1.24 V	90	70.50	41.50
5	*5745.00	102.3 AV			1.24 V	90	60.80	41.50
6	11490.00	53.0 PK	74.0	-21.0	1.11 V	91	5.86	47.14
7	11490.00	39.8 AV	54.0	-14.2	1.11 V	91	-7.34	47.14
8	#17235.00	63.7 PK	74.0	-10.3	1.18 V	29	8.84	54.86
9	#17235.00	50.3 AV	54.0	-3.7	1.18 V	29	-4.56	54.86

REMARKS:

1. Emission Level(dBuV/m) = Raw Value(dBuV) + Correction Factor(dB/m)
2. Correction Factor(dB/m) = Antenna Factor(dB/m) + Cable Factor(dB) – Pre-Amplifier Factor(dB)
3. The other emission levels were very low against the limit.
4. Margin value = Emission Level – Limit value
5. " * " : Fundamental frequency.
6. " # " : The radiated frequency is out of the restricted band.



A D T

CHANNEL	TX Channel 157	DETECTOR FUNCTION	Peak (PK)
FREQUENCY RANGE	1GHz ~ 40GHz		Average (AV)

ANTENNA POLARITY & TEST DISTANCE: HORIZONTAL AT 3 M

NO.	FREQ. (MHz)	EMISSION LEVEL (dBuV/m)	LIMIT (dBuV/m)	MARGIN (dB)	ANTENNA HEIGHT (m)	TABLE ANGLE (Degree)	RAW VALUE (dBuV)	CORRECTION FACTOR (dB/m)
1	#5715.00	63.8 PK	74.0	-10.2	1.17 H	312	22.34	41.46
2	#5715.00	47.1 AV	54.0	-6.9	1.17 H	312	5.64	41.46
3	#5725.00	64.3 PK	78.2	-13.9	1.17 H	312	22.82	41.48
4	*5785.00	113.0 PK			1.17 H	312	71.45	41.55
5	*5785.00	103.7 AV			1.17 H	312	62.15	41.55
6	#5850.00	62.4 PK	78.2	-15.8	1.17 H	312	20.72	41.68
7	11570.00	58.3 PK	74.0	-15.7	1.00 H	152	11.11	47.19
8	11570.00	45.6 AV	54.0	-8.4	1.00 H	152	-1.59	47.19
9	#17355.00	63.7 PK	74.0	-10.3	1.04 H	306	8.62	55.08
10	#17355.00	50.0 AV	54.0	-4.0	1.04 H	306	-5.08	55.08

ANTENNA POLARITY & TEST DISTANCE: VERTICAL AT 3 M

NO.	FREQ. (MHz)	EMISSION LEVEL (dBuV/m)	LIMIT (dBuV/m)	MARGIN (dB)	ANTENNA HEIGHT (m)	TABLE ANGLE (Degree)	RAW VALUE (dBuV)	CORRECTION FACTOR (dB/m)
1	#5715.00	65.4 PK	74.0	-8.6	1.21 V	85	23.94	41.46
2	#5715.00	48.5 AV	54.0	-5.5	1.21 V	85	7.04	41.46
3	#5725.00	68.9 PK	78.2	-9.3	1.01 V	89	27.42	41.48
4	*5785.00	117.4 PK			1.21 V	85	75.85	41.55
5	*5785.00	108.0 AV			1.21 V	85	66.45	41.55
6	#5850.00	66.3 PK	78.2	-11.9	1.22 V	100	24.62	41.68
7	11570.00	55.4 PK	74.0	-18.6	1.12 V	75	8.21	47.19
8	11570.00	43.3 AV	54.0	-10.7	1.12 V	75	-3.89	47.19
9	#17355.00	63.4 PK	74.0	-10.6	1.21 V	14	8.32	55.08
10	#17355.00	50.2 AV	54.0	-3.8	1.21 V	14	-4.88	55.08

REMARKS:

1. Emission Level(dBuV/m) = Raw Value(dBuV) + Correction Factor(dB/m)
2. Correction Factor(dB/m) = Antenna Factor(dB/m) + Cable Factor(dB) – Pre-Amplifier Factor(dB)
3. The other emission levels were very low against the limit.
4. Margin value = Emission Level – Limit value
5. " * ": Fundamental frequency.
6. " # ": The radiated frequency is out of the restricted band.



A D T

CHANNEL	TX Channel 165	DETECTOR FUNCTION	Peak (PK)
FREQUENCY RANGE	1GHz ~ 40GHz		Average (AV)

ANTENNA POLARITY & TEST DISTANCE: HORIZONTAL AT 3 M

NO.	FREQ. (MHz)	EMISSION LEVEL (dBuV/m)	LIMIT (dBuV/m)	MARGIN (dB)	ANTENNA HEIGHT (m)	TABLE ANGLE (Degree)	RAW VALUE (dBuV)	CORRECTION FACTOR (dB/m)
1	*5825.00	110.2 PK			1.23 H	297	68.58	41.62
2	*5825.00	100.2 AV			1.23 H	297	58.58	41.62
3	#5850.00	74.6 PK	78.2	-3.6	1.21 H	276	32.92	41.68
4	#5860.00	68.8 PK	74.0	-5.2	1.21 H	276	27.09	41.71
5	#5860.00	50.8 AV	54.0	-3.2	1.21 H	276	9.09	41.71
6	11650.00	57.2 PK	74.0	-16.8	1.00 H	131	9.97	47.23
7	11650.00	44.0 AV	54.0	-10.0	1.00 H	131	-3.23	47.23
8	#17475.00	64.1 PK	74.0	-9.9	1.00 H	294	8.79	55.31
9	#17475.00	50.4 AV	54.0	-3.6	1.00 H	294	-4.91	55.31

ANTENNA POLARITY & TEST DISTANCE: VERTICAL AT 3 M

NO.	FREQ. (MHz)	EMISSION LEVEL (dBuV/m)	LIMIT (dBuV/m)	MARGIN (dB)	ANTENNA HEIGHT (m)	TABLE ANGLE (Degree)	RAW VALUE (dBuV)	CORRECTION FACTOR (dB/m)
1	*5825.00	114.7 PK			1.21 V	98	73.08	41.62
2	*5825.00	105.4 AV			1.21 V	98	63.78	41.62
3	#5850.00	77.8 PK	78.2	-0.4	1.21 V	98	36.12	41.68
4	#5860.00	70.9 PK	74.0	-3.1	1.21 V	98	29.19	41.71
5	#5860.00	52.3 AV	54.0	-1.7	1.21 V	98	10.59	41.71
6	11650.00	56.4 PK	74.0	-17.6	1.16 V	81	9.17	47.23
7	11650.00	43.2 AV	54.0	-10.8	1.16 V	81	-4.03	47.23
8	#17475.00	63.6 PK	74.0	-10.4	1.15 V	15	8.29	55.31
9	#17475.00	50.4 AV	54.0	-3.6	1.15 V	15	-4.91	55.31

REMARKS:

1. Emission Level(dBuV/m) = Raw Value(dBuV) + Correction Factor(dB/m)
2. Correction Factor(dB/m) = Antenna Factor(dB/m) + Cable Factor(dB) – Pre-Amplifier Factor(dB)
3. The other emission levels were very low against the limit.
4. Margin value = Emission Level – Limit value
5. " * ": Fundamental frequency.
6. " # ": The radiated frequency is out of the restricted band.



A D T

802.11ac (VHT20)

CHANNEL	TX Channel 36	DETECTOR FUNCTION	Peak (PK)
FREQUENCY RANGE	1GHz ~ 40GHz		Average (AV)

ANTENNA POLARITY & TEST DISTANCE: HORIZONTAL AT 3 M

NO.	FREQ. (MHz)	EMISSION LEVEL (dBuV/m)	LIMIT (dBuV/m)	MARGIN (dB)	ANTENNA HEIGHT (m)	TABLE ANGLE (Degree)	RAW VALUE (dBuV)	CORRECTION FACTOR (dB/m)
1	5150.00	71.3 PK	74.0	-2.7	1.35 H	83	30.74	40.56
2	5150.00	50.8 AV	54.0	-3.2	1.35 H	83	10.24	40.56
3	*5180.00	112.4 PK			1.35 H	83	71.76	40.64
4	*5180.00	102.8 AV			1.35 H	83	62.16	40.64
5	#10360.00	55.5 PK	74.0	-18.5	1.09 H	144	8.75	46.75
6	#10360.00	44.0 AV	54.0	-10.0	1.09 H	144	-2.75	46.75
7	15540.00	69.8 PK	74.0	-4.2	1.00 H	266	18.60	51.20
8	15540.00	53.9 AV	54.0	-0.1	1.00 H	266	2.70	51.20

ANTENNA POLARITY & TEST DISTANCE: VERTICAL AT 3 M

NO.	FREQ. (MHz)	EMISSION LEVEL (dBuV/m)	LIMIT (dBuV/m)	MARGIN (dB)	ANTENNA HEIGHT (m)	TABLE ANGLE (Degree)	RAW VALUE (dBuV)	CORRECTION FACTOR (dB/m)
1	5150.00	73.5 PK	74.0	-0.5	1.30 V	285	32.94	40.56
2	5150.00	51.7 AV	54.0	-2.3	1.30 V	285	11.14	40.56
3	*5180.00	115.1 PK			1.30 V	285	74.46	40.64
4	*5180.00	105.7 AV			1.30 V	285	65.06	40.64
5	#10360.00	53.8 PK	74.0	-20.2	1.21 V	80	7.05	46.75
6	#10360.00	41.0 AV	54.0	-13.0	1.21 V	80	-5.75	46.75
7	15540.00	65.1 PK	74.0	-8.9	1.32 V	47	13.90	51.20
8	15540.00	52.0 AV	54.0	-2.0	1.32 V	47	0.80	51.20

REMARKS:

1. Emission Level(dBuV/m) = Raw Value(dBuV) + Correction Factor(dB/m)
2. Correction Factor(dB/m) = Antenna Factor(dB/m) + Cable Factor(dB) – Pre-Amplifier Factor(dB)
3. The other emission levels were very low against the limit.
4. Margin value = Emission Level – Limit value
5. " * ": Fundamental frequency.
6. " # ": The radiated frequency is out of the restricted band.



A D T

CHANNEL	TX Channel 40	DETECTOR FUNCTION	Peak (PK)
FREQUENCY RANGE	1GHz ~ 40GHz		Average (AV)

ANTENNA POLARITY & TEST DISTANCE: HORIZONTAL AT 3 M

NO.	FREQ. (MHz)	EMISSION LEVEL (dBuV/m)	LIMIT (dBuV/m)	MARGIN (dB)	ANTENNA HEIGHT (m)	TABLE ANGLE (Degree)	RAW VALUE (dBuV)	CORRECTION FACTOR (dB/m)
1	*5200.00	113.9 PK			1.30 H	52	73.22	40.68
2	*5200.00	103.8 AV			1.30 H	52	63.12	40.68
3	#10400.00	55.5 PK	74.0	-18.5	1.15 H	157	8.79	46.71
4	#10400.00	44.0 AV	54.0	-10.0	1.15 H	157	-2.71	46.71
5	15600.00	69.2 PK	74.0	-4.8	1.00 H	274	17.92	51.28
6	15600.00	53.2 AV	54.0	-0.8	1.00 H	274	1.92	51.28

ANTENNA POLARITY & TEST DISTANCE: VERTICAL AT 3 M

NO.	FREQ. (MHz)	EMISSION LEVEL (dBuV/m)	LIMIT (dBuV/m)	MARGIN (dB)	ANTENNA HEIGHT (m)	TABLE ANGLE (Degree)	RAW VALUE (dBuV)	CORRECTION FACTOR (dB/m)
1	*5200.00	117.5 PK			1.29 V	159	76.82	40.68
2	*5200.00	108.4 AV			1.29 V	159	67.72	40.68
3	#10400.00	54.3 PK	74.0	-19.7	1.10 V	87	7.59	46.71
4	#10400.00	42.0 AV	54.0	-12.0	1.10 V	87	-4.71	46.71
5	15600.00	65.0 PK	74.0	-9.0	1.23 V	0	13.72	51.28
6	15600.00	51.3 AV	54.0	-2.7	1.23 V	0	0.02	51.28

REMARKS:

1. Emission Level(dBuV/m) = Raw Value(dBuV) + Correction Factor(dB/m)
2. Correction Factor(dB/m) = Antenna Factor(dB/m) + Cable Factor(dB) – Pre-Amplifier Factor(dB)
3. The other emission levels were very low against the limit.
4. Margin value = Emission Level – Limit value
5. " * ": Fundamental frequency.
6. " # ": The radiated frequency is out of the restricted band.



A D T

CHANNEL	TX Channel 48	DETECTOR FUNCTION	Peak (PK)
FREQUENCY RANGE	1GHz ~ 40GHz		Average (AV)

ANTENNA POLARITY & TEST DISTANCE: HORIZONTAL AT 3 M

NO.	FREQ. (MHz)	EMISSION LEVEL (dBuV/m)	LIMIT (dBuV/m)	MARGIN (dB)	ANTENNA HEIGHT (m)	TABLE ANGLE (Degree)	RAW VALUE (dBuV)	CORRECTION FACTOR (dB/m)
1	*5240.00	112.1 PK			1.36 H	78	71.35	40.75
2	*5240.00	102.9 AV			1.36 H	78	62.15	40.75
3	#10480.00	55.1 PK	74.0	-18.9	1.02 H	164	8.30	46.80
4	#10480.00	43.6 AV	54.0	-10.4	1.02 H	164	-3.20	46.80
5	15720.00	69.6 PK	74.0	-4.4	1.00 H	290	18.26	51.34
6	15720.00	53.6 AV	54.0	-0.4	1.00 H	290	2.26	51.34

ANTENNA POLARITY & TEST DISTANCE: VERTICAL AT 3 M

NO.	FREQ. (MHz)	EMISSION LEVEL (dBuV/m)	LIMIT (dBuV/m)	MARGIN (dB)	ANTENNA HEIGHT (m)	TABLE ANGLE (Degree)	RAW VALUE (dBuV)	CORRECTION FACTOR (dB/m)
1	*5240.00	115.7 PK			1.07 V	308	74.95	40.75
2	*5240.00	106.2 AV			1.07 V	308	65.45	40.75
3	#10480.00	54.1 PK	74.0	-19.9	1.16 V	82	7.30	46.80
4	#10480.00	41.3 AV	54.0	-12.7	1.16 V	82	-5.50	46.80
5	15720.00	64.6 PK	74.0	-9.4	1.30 V	34	13.26	51.34
6	15720.00	51.5 AV	54.0	-2.5	1.30 V	34	0.16	51.34

REMARKS:

1. Emission Level(dBuV/m) = Raw Value(dBuV) + Correction Factor(dB/m)
2. Correction Factor(dB/m) = Antenna Factor(dB/m) + Cable Factor(dB) – Pre-Amplifier Factor(dB)
3. The other emission levels were very low against the limit.
4. Margin value = Emission Level – Limit value
5. " * ": Fundamental frequency.
6. " # ": The radiated frequency is out of the restricted band.



A D T

CHANNEL	TX Channel 52	DETECTOR FUNCTION	Peak (PK)
FREQUENCY RANGE	1GHz ~ 40GHz		Average (AV)

ANTENNA POLARITY & TEST DISTANCE: HORIZONTAL AT 3 M

NO.	FREQ. (MHz)	EMISSION LEVEL (dBuV/m)	LIMIT (dBuV/m)	MARGIN (dB)	ANTENNA HEIGHT (m)	TABLE ANGLE (Degree)	RAW VALUE (dBuV)	CORRECTION FACTOR (dB/m)
1	*5260.00	114.0 PK			1.39 H	47	73.21	40.79
2	*5260.00	104.2 AV			1.39 H	47	63.41	40.79
3	#10520.00	56.0 PK	74.0	-18.0	1.15 H	145	9.14	46.86
4	#10520.00	44.4 AV	54.0	-9.6	1.15 H	145	-2.46	46.86
5	15780.00	69.8 PK	74.0	-4.2	1.06 H	293	18.36	51.44
6	15780.00	53.9 AV	54.0	-0.1	1.06 H	293	2.46	51.44

ANTENNA POLARITY & TEST DISTANCE: VERTICAL AT 3 M

NO.	FREQ. (MHz)	EMISSION LEVEL (dBuV/m)	LIMIT (dBuV/m)	MARGIN (dB)	ANTENNA HEIGHT (m)	TABLE ANGLE (Degree)	RAW VALUE (dBuV)	CORRECTION FACTOR (dB/m)
1	*5260.00	118.0 PK			1.32 V	151	77.21	40.79
2	*5260.00	108.6 AV			1.32 V	151	67.81	40.79
3	#10520.00	54.0 PK	74.0	-20.0	1.18 V	85	7.14	46.86
4	#10520.00	41.6 AV	54.0	-12.4	1.18 V	85	-5.26	46.86
5	15780.00	65.0 PK	74.0	-9.0	1.25 V	0	13.56	51.44
6	15780.00	51.3 AV	54.0	-2.7	1.25 V	0	-0.14	51.44

REMARKS:

1. Emission Level(dBuV/m) = Raw Value(dBuV) + Correction Factor(dB/m)
2. Correction Factor(dB/m) = Antenna Factor(dB/m) + Cable Factor(dB) – Pre-Amplifier Factor(dB)
3. The other emission levels were very low against the limit.
4. Margin value = Emission Level – Limit value
5. " * ": Fundamental frequency.
6. " # ": The radiated frequency is out of the restricted band.



A D T

CHANNEL	TX Channel 60	DETECTOR FUNCTION	Peak (PK)
FREQUENCY RANGE	1GHz ~ 40GHz		Average (AV)

ANTENNA POLARITY & TEST DISTANCE: HORIZONTAL AT 3 M

NO.	FREQ. (MHz)	EMISSION LEVEL (dBuV/m)	LIMIT (dBuV/m)	MARGIN (dB)	ANTENNA HEIGHT (m)	TABLE ANGLE (Degree)	RAW VALUE (dBuV)	CORRECTION FACTOR (dB/m)
1	*5300.00	113.7 PK			1.44 H	43	72.84	40.86
2	*5300.00	103.9 AV			1.44 H	43	63.04	40.86
3	10600.00	56.6 PK	74.0	-17.4	1.19 H	151	9.54	47.06
4	10600.00	44.8 AV	54.0	-9.2	1.19 H	151	-2.26	47.06
5	15900.00	69.5 PK	74.0	-4.5	1.03 H	271	17.95	51.55
6	15900.00	53.6 AV	54.0	-0.4	1.03 H	271	2.05	51.55

ANTENNA POLARITY & TEST DISTANCE: VERTICAL AT 3 M

NO.	FREQ. (MHz)	EMISSION LEVEL (dBuV/m)	LIMIT (dBuV/m)	MARGIN (dB)	ANTENNA HEIGHT (m)	TABLE ANGLE (Degree)	RAW VALUE (dBuV)	CORRECTION FACTOR (dB/m)
1	*5300.00	117.8 PK			1.30 V	163	76.94	40.86
2	*5300.00	108.3 AV			1.30 V	163	67.44	40.86
3	10600.00	53.7 PK	74.0	-20.3	1.13 V	93	6.64	47.06
4	10600.00	41.5 AV	54.0	-12.5	1.13 V	93	-5.56	47.06
5	15900.00	65.6 PK	74.0	-8.4	1.26 V	7	14.05	51.55
6	15900.00	51.8 AV	54.0	-2.2	1.26 V	7	0.25	51.55

REMARKS:

1. Emission Level(dBuV/m) = Raw Value(dBuV) + Correction Factor(dB/m)
2. Correction Factor(dB/m) = Antenna Factor(dB/m) + Cable Factor(dB) – Pre-Amplifier Factor(dB)
3. The other emission levels were very low against the limit.
4. Margin value = Emission Level – Limit value
5. " * ": Fundamental frequency.



A D T

CHANNEL	TX Channel 64	DETECTOR FUNCTION	Peak (PK)
FREQUENCY RANGE	1GHz ~ 40GHz		Average (AV)

ANTENNA POLARITY & TEST DISTANCE: HORIZONTAL AT 3 M

NO.	FREQ. (MHz)	EMISSION LEVEL (dBuV/m)	LIMIT (dBuV/m)	MARGIN (dB)	ANTENNA HEIGHT (m)	TABLE ANGLE (Degree)	RAW VALUE (dBuV)	CORRECTION FACTOR (dB/m)
1	*5320.00	114.0 PK			1.32 H	43	73.11	40.89
2	*5320.00	104.0 AV			1.32 H	43	63.11	40.89
3	5350.00	71.3 PK	74.0	-2.7	1.32 H	43	30.36	40.94
4	5350.00	51.4 AV	54.0	-2.6	1.32 H	43	10.46	40.94
5	10640.00	55.3 PK	74.0	-18.7	1.19 H	153	8.26	47.04
6	10640.00	43.5 AV	54.0	-10.5	1.19 H	153	-3.54	47.04
7	15960.00	69.4 PK	74.0	-4.6	1.00 H	287	17.87	51.53
8	15960.00	53.6 AV	54.0	-0.4	1.00 H	287	2.07	51.53

ANTENNA POLARITY & TEST DISTANCE: VERTICAL AT 3 M

NO.	FREQ. (MHz)	EMISSION LEVEL (dBuV/m)	LIMIT (dBuV/m)	MARGIN (dB)	ANTENNA HEIGHT (m)	TABLE ANGLE (Degree)	RAW VALUE (dBuV)	CORRECTION FACTOR (dB/m)
1	*5320.00	115.6 PK			1.04 V	354	74.72	40.89
2	*5320.00	105.3 AV			1.04 V	354	64.41	40.89
3	5350.00	73.5 PK	74.0	-0.5	1.04 V	355	32.56	40.94
4	5350.00	53.3 AV	54.0	-0.7	1.04 V	355	12.36	40.94
5	10640.00	53.9 PK	74.0	-20.1	1.14 V	87	6.86	47.04
6	10640.00	41.6 AV	54.0	-12.4	1.14 V	87	-5.44	47.04
7	15960.00	65.1 PK	74.0	-8.9	1.22 V	0	13.57	51.53
8	15960.00	51.4 AV	54.0	-2.6	1.22 V	0	-0.13	51.53

REMARKS:

1. Emission Level(dBuV/m) = Raw Value(dBuV) + Correction Factor(dB/m)
2. Correction Factor(dB/m) = Antenna Factor(dB/m) + Cable Factor(dB) – Pre-Amplifier Factor(dB)
3. The other emission levels were very low against the limit.
4. Margin value = Emission Level – Limit value
5. " * ": Fundamental frequency.



A D T

CHANNEL	TX Channel 100	DETECTOR FUNCTION	Peak (PK)
FREQUENCY RANGE	1GHz ~ 40GHz		Average (AV)

ANTENNA POLARITY & TEST DISTANCE: HORIZONTAL AT 3 M

NO.	FREQ. (MHz)	EMISSION LEVEL (dBuV/m)	LIMIT (dBuV/m)	MARGIN (dB)	ANTENNA HEIGHT (m)	TABLE ANGLE (Degree)	RAW VALUE (dBuV)	CORRECTION FACTOR (dB/m)
1	5460.00	55.4 PK	74.0	-18.6	1.37 H	65	14.28	41.12
2	5460.00	41.6 AV	54.0	-12.4	1.37 H	65	0.48	41.12
3	#5470.00	71.3 PK	74.0	-2.7	1.37 H	65	30.16	41.14
4	#5470.00	48.1 AV	54.0	-5.9	1.37 H	65	6.96	41.14
5	*5500.00	110.5 PK			1.37 H	65	69.30	41.20
6	*5500.00	101.8 AV			1.37 H	65	60.60	41.20
7	11000.00	55.5 PK	74.0	-18.5	1.09 H	137	8.09	47.41
8	11000.00	44.2 AV	54.0	-9.8	1.09 H	137	-3.21	47.41
9	#16500.00	68.8 PK	74.0	-5.2	1.03 H	279	15.84	52.96
10	#16500.00	53.2 AV	54.0	-0.8	1.03 H	279	0.24	52.96

ANTENNA POLARITY & TEST DISTANCE: VERTICAL AT 3 M

NO.	FREQ. (MHz)	EMISSION LEVEL (dBuV/m)	LIMIT (dBuV/m)	MARGIN (dB)	ANTENNA HEIGHT (m)	TABLE ANGLE (Degree)	RAW VALUE (dBuV)	CORRECTION FACTOR (dB/m)
1	5460.00	57.2 PK	74.0	-16.8	1.08 V	177	16.08	41.12
2	5460.00	43.7 AV	54.0	-10.3	1.08 V	177	2.58	41.12
3	#5470.00	73.4 PK	74.0	-0.6	1.08 V	177	32.26	41.14
4	#5470.00	49.5 AV	54.0	-4.5	1.08 V	177	8.36	41.14
5	*5500.00	115.2 PK			1.08 V	177	74.00	41.20
6	*5500.00	105.1 AV			1.08 V	177	63.90	41.20
7	11000.00	53.5 PK	74.0	-20.5	1.11 V	89	6.09	47.41
8	11000.00	41.2 AV	54.0	-12.8	1.11 V	89	-6.21	47.41
9	#16500.00	64.6 PK	74.0	-9.4	1.36 V	43	11.64	52.96
10	#16500.00	51.8 AV	54.0	-2.2	1.36 V	43	-1.16	52.96

REMARKS:

1. Emission Level(dBuV/m) = Raw Value(dBuV) + Correction Factor(dB/m)
2. Correction Factor(dB/m) = Antenna Factor(dB/m) + Cable Factor(dB) – Pre-Amplifier Factor(dB)
3. The other emission levels were very low against the limit.
4. Margin value = Emission Level – Limit value
5. " * ": Fundamental frequency.
6. " # ": The radiated frequency is out of the restricted band.



A D T

CHANNEL	TX Channel 120	DETECTOR FUNCTION	Peak (PK)
FREQUENCY RANGE	1GHz ~ 40GHz		Average (AV)

ANTENNA POLARITY & TEST DISTANCE: HORIZONTAL AT 3 M

NO.	FREQ. (MHz)	EMISSION LEVEL (dBuV/m)	LIMIT (dBuV/m)	MARGIN (dB)	ANTENNA HEIGHT (m)	TABLE ANGLE (Degree)	RAW VALUE (dBuV)	CORRECTION FACTOR (dB/m)
1	*5600.00	110.9 PK			1.33 H	66	69.54	41.36
2	*5600.00	101.3 AV			1.33 H	66	59.94	41.36
3	11200.00	54.7 PK	74.0	-19.3	1.00 H	161	7.58	47.12
4	11200.00	43.5 AV	54.0	-10.5	1.00 H	161	-3.62	47.12
5	#16800.00	69.3 PK	74.0	-4.7	1.05 H	283	15.55	53.75
6	#16800.00	53.3 AV	54.0	-0.7	1.05 H	283	-0.45	53.75

ANTENNA POLARITY & TEST DISTANCE: VERTICAL AT 3 M

NO.	FREQ. (MHz)	EMISSION LEVEL (dBuV/m)	LIMIT (dBuV/m)	MARGIN (dB)	ANTENNA HEIGHT (m)	TABLE ANGLE (Degree)	RAW VALUE (dBuV)	CORRECTION FACTOR (dB/m)
1	*5600.00	114.4 PK			1.03 V	294	73.04	41.36
2	*5600.00	105.3 AV			1.03 V	294	63.94	41.36
3	11200.00	53.8 PK	74.0	-20.2	1.15 V	82	6.68	47.12
4	11200.00	41.3 AV	54.0	-12.7	1.15 V	82	-5.82	47.12
5	#16800.00	65.4 PK	74.0	-8.6	1.36 V	0	11.65	53.75
6	#16800.00	52.7 AV	54.0	-1.3	1.36 V	0	-1.05	53.75

REMARKS:

1. Emission Level(dBuV/m) = Raw Value(dBuV) + Correction Factor(dB/m)
2. Correction Factor(dB/m) = Antenna Factor(dB/m) + Cable Factor(dB) – Pre-Amplifier Factor(dB)
3. The other emission levels were very low against the limit.
4. Margin value = Emission Level – Limit value
5. " * ": Fundamental frequency.
6. " # ": The radiated frequency is out of the restricted band.



A D T

CHANNEL	TX Channel 140	DETECTOR FUNCTION	Peak (PK)
FREQUENCY RANGE	1GHz ~ 40GHz		Average (AV)

ANTENNA POLARITY & TEST DISTANCE: HORIZONTAL AT 3 M

NO.	FREQ. (MHz)	EMISSION LEVEL (dBuV/m)	LIMIT (dBuV/m)	MARGIN (dB)	ANTENNA HEIGHT (m)	TABLE ANGLE (Degree)	RAW VALUE (dBuV)	CORRECTION FACTOR (dB/m)
1	*5700.00	109.3 PK			1.30 H	73	67.85	41.45
2	*5700.00	100.6 AV			1.30 H	73	59.15	41.45
3	#5725.00	68.3 PK	74.0	-5.7	1.30 H	73	26.82	41.48
4	#5725.00	50.6 AV	54.0	-3.4	1.30 H	73	9.12	41.48
5	11400.00	55.8 PK	74.0	-18.2	1.00 H	121	8.71	47.09
6	11400.00	41.7 AV	54.0	-12.3	1.00 H	121	-5.39	47.09
7	#17100.00	69.3 PK	74.0	-4.7	1.04 H	283	14.94	54.36
8	#17100.00	53.3 AV	54.0	-0.7	1.04 H	283	-1.06	54.36

ANTENNA POLARITY & TEST DISTANCE: VERTICAL AT 3 M

NO.	FREQ. (MHz)	EMISSION LEVEL (dBuV/m)	LIMIT (dBuV/m)	MARGIN (dB)	ANTENNA HEIGHT (m)	TABLE ANGLE (Degree)	RAW VALUE (dBuV)	CORRECTION FACTOR (dB/m)
1	*5700.00	113.3 PK			1.00 V	178	71.85	41.45
2	*5700.00	103.4 AV			1.00 V	178	61.95	41.45
3	#5725.00	70.4 PK	74.0	-3.6	1.00 V	180	28.92	41.48
4	#5725.00	52.8 AV	54.0	-1.2	1.00 V	180	11.32	41.48
5	11400.00	53.0 PK	74.0	-21.0	1.07 V	63	5.91	47.09
6	11400.00	39.7 AV	54.0	-14.3	1.07 V	63	-7.39	47.09
7	#17100.00	64.7 PK	74.0	-9.3	1.23 V	16	10.34	54.36
8	#17100.00	51.8 AV	54.0	-2.2	1.23 V	16	-2.56	54.36

REMARKS:

1. Emission Level(dBuV/m) = Raw Value(dBuV) + Correction Factor(dB/m)
2. Correction Factor(dB/m) = Antenna Factor(dB/m) + Cable Factor(dB) – Pre-Amplifier Factor(dB)
3. The other emission levels were very low against the limit.
4. Margin value = Emission Level – Limit value
5. " * ": Fundamental frequency.
6. " # ": The radiated frequency is out of the restricted band.



A D T

CHANNEL	TX Channel 149	DETECTOR FUNCTION	Peak (PK)
FREQUENCY RANGE	1GHz ~ 40GHz		Average (AV)

ANTENNA POLARITY & TEST DISTANCE: HORIZONTAL AT 3 M

NO.	FREQ. (MHz)	EMISSION LEVEL (dBuV/m)	LIMIT (dBuV/m)	MARGIN (dB)	ANTENNA HEIGHT (m)	TABLE ANGLE (Degree)	RAW VALUE (dBuV)	CORRECTION FACTOR (dB/m)
1	#5715.00	68.1 PK	74.0	-5.9	1.20 H	300	26.64	41.46
2	#5715.00	50.7 AV	54.0	-3.3	1.20 H	300	9.24	41.46
3	#5725.00	72.5 PK	78.2	-5.7	1.20 H	300	31.02	41.48
4	*5745.00	106.6 PK			1.16 H	308	65.10	41.50
5	*5745.00	97.5 AV			1.16 H	308	56.00	41.50
6	11490.00	54.8 PK	74.0	-19.2	1.00 H	127	7.66	47.14
7	11490.00	43.5 AV	54.0	-10.5	1.00 H	127	-3.64	47.14
8	#17235.00	63.9 PK	74.0	-10.1	1.05 H	304	9.04	54.86
9	#17235.00	50.2 AV	54.0	-3.8	1.05 H	304	-4.66	54.86

ANTENNA POLARITY & TEST DISTANCE: VERTICAL AT 3 M

NO.	FREQ. (MHz)	EMISSION LEVEL (dBuV/m)	LIMIT (dBuV/m)	MARGIN (dB)	ANTENNA HEIGHT (m)	TABLE ANGLE (Degree)	RAW VALUE (dBuV)	CORRECTION FACTOR (dB/m)
1	#5715.00	71.4 PK	74.0	-2.6	1.24 V	101	29.94	41.46
2	#5715.00	52.7 AV	54.0	-1.3	1.24 V	101	11.24	41.46
3	#5725.00	78.1 PK	78.2	-0.1	1.24 V	101	36.62	41.48
4	*5745.00	111.4 PK			1.24 V	103	69.90	41.50
5	*5745.00	102.1 AV			1.24 V	103	60.60	41.50
6	11490.00	52.9 PK	74.0	-21.1	1.11 V	80	5.76	47.14
7	11490.00	39.7 AV	54.0	-14.3	1.11 V	80	-7.44	47.14
8	#17235.00	63.4 PK	74.0	-10.6	1.18 V	43	8.54	54.86
9	#17235.00	50.0 AV	54.0	-4.0	1.18 V	43	-4.86	54.86

REMARKS:

1. Emission Level(dBuV/m) = Raw Value(dBuV) + Correction Factor(dB/m)
2. Correction Factor(dB/m) = Antenna Factor(dB/m) + Cable Factor(dB) – Pre-Amplifier Factor(dB)
3. The other emission levels were very low against the limit.
4. Margin value = Emission Level – Limit value
5. " * " : Fundamental frequency.
6. " # " : The radiated frequency is out of the restricted band.



A D T

CHANNEL	TX Channel 157	DETECTOR FUNCTION	Peak (PK)
FREQUENCY RANGE	1GHz ~ 40GHz		Average (AV)

ANTENNA POLARITY & TEST DISTANCE: HORIZONTAL AT 3 M

NO.	FREQ. (MHz)	EMISSION LEVEL (dBuV/m)	LIMIT (dBuV/m)	MARGIN (dB)	ANTENNA HEIGHT (m)	TABLE ANGLE (Degree)	RAW VALUE (dBuV)	CORRECTION FACTOR (dB/m)
1	#5715.00	63.5 PK	74.0	-10.5	1.12 H	315	22.04	41.46
2	#5715.00	47.0 AV	54.0	-7.0	1.12 H	315	5.54	41.46
3	#5725.00	63.7 PK	78.2	-14.5	1.22 H	319	22.22	41.48
4	*5785.00	114.5 PK			1.16 H	303	72.95	41.55
5	*5785.00	105.7 AV			1.16 H	303	64.15	41.55
6	#5850.00	62.1 PK	78.2	-16.1	1.15 H	317	20.42	41.68
7	11570.00	59.7 PK	74.0	-14.3	1.00 H	140	12.51	47.19
8	11570.00	46.3 AV	54.0	-7.7	1.00 H	140	-0.89	47.19

ANTENNA POLARITY & TEST DISTANCE: VERTICAL AT 3 M

NO.	FREQ. (MHz)	EMISSION LEVEL (dBuV/m)	LIMIT (dBuV/m)	MARGIN (dB)	ANTENNA HEIGHT (m)	TABLE ANGLE (Degree)	RAW VALUE (dBuV)	CORRECTION FACTOR (dB/m)
1	#5715.00	65.2 PK	74.0	-8.8	1.26 V	99	23.74	41.46
2	#5715.00	48.3 AV	54.0	-5.7	1.26 V	99	6.84	41.46
3	#5725.00	68.4 PK	78.2	-9.8	1.03 V	84	26.92	41.48
4	*5785.00	118.3 PK			1.23 V	87	76.75	41.55
5	*5785.00	109.7 AV			1.23 V	87	68.15	41.55
6	#5850.00	66.3 PK	78.2	-11.9	1.26 V	111	24.62	41.68
7	11570.00	55.8 PK	74.0	-18.2	1.13 V	80	8.61	47.19
8	11570.00	44.3 AV	54.0	-9.7	1.13 V	80	-2.89	47.19
9	#17355.00	64.0 PK	74.0	-10.0	1.23 V	35	8.92	55.08
10	#17355.00	50.7 AV	54.0	-3.3	1.23 V	35	-4.38	55.08

REMARKS:

1. Emission Level(dBuV/m) = Raw Value(dBuV) + Correction Factor(dB/m)
2. Correction Factor(dB/m) = Antenna Factor(dB/m) + Cable Factor(dB) – Pre-Amplifier Factor(dB)
3. The other emission levels were very low against the limit.
4. Margin value = Emission Level – Limit value
5. " * ": Fundamental frequency.
6. " # ": The radiated frequency is out of the restricted band.



A D T

CHANNEL	TX Channel 165	DETECTOR FUNCTION	Peak (PK)
FREQUENCY RANGE	1GHz ~ 40GHz		Average (AV)

ANTENNA POLARITY & TEST DISTANCE: HORIZONTAL AT 3 M

NO.	FREQ. (MHz)	EMISSION LEVEL (dBuV/m)	LIMIT (dBuV/m)	MARGIN (dB)	ANTENNA HEIGHT (m)	TABLE ANGLE (Degree)	RAW VALUE (dBuV)	CORRECTION FACTOR (dB/m)
1	*5825.00	110.5 PK			1.28 H	286	68.88	41.62
2	*5825.00	100.7 AV			1.28 H	286	59.08	41.62
3	#5850.00	74.6 PK	78.2	-3.6	1.25 H	286	32.92	41.68
4	#5860.00	68.9 PK	74.0	-5.1	1.18 H	263	27.19	41.71
5	#5860.00	51.0 AV	54.0	-3.0	1.18 H	263	9.29	41.71
6	11650.00	56.5 PK	74.0	-17.5	1.00 H	140	9.27	47.23
7	11650.00	43.6 AV	54.0	-10.4	1.00 H	140	-3.63	47.23
8	#17475.00	64.7 PK	74.0	-9.3	1.00 H	293	9.39	55.31
9	#17475.00	50.6 AV	54.0	-3.4	1.00 H	293	-4.71	55.31

ANTENNA POLARITY & TEST DISTANCE: VERTICAL AT 3 M

NO.	FREQ. (MHz)	EMISSION LEVEL (dBuV/m)	LIMIT (dBuV/m)	MARGIN (dB)	ANTENNA HEIGHT (m)	TABLE ANGLE (Degree)	RAW VALUE (dBuV)	CORRECTION FACTOR (dB/m)
1	*5825.00	114.7 PK			1.22 V	100	73.08	41.62
2	*5825.00	105.1 AV			1.22 V	100	63.48	41.62
3	#5850.00	77.6 PK	78.2	-0.6	1.22 V	98	35.92	41.68
4	#5860.00	71.1 PK	74.0	-2.9	1.17 V	105	29.39	41.71
5	#5860.00	52.4 AV	54.0	-1.6	1.17 V	105	10.69	41.71
6	11650.00	56.1 PK	74.0	-17.9	1.16 V	89	8.87	47.23
7	11650.00	43.1 AV	54.0	-10.9	1.16 V	89	-4.13	47.23
8	#17475.00	64.0 PK	74.0	-10.0	1.21 V	40	8.69	55.31
9	#17475.00	50.6 AV	54.0	-3.4	1.21 V	40	-4.71	55.31

REMARKS:

1. Emission Level(dBuV/m) = Raw Value(dBuV) + Correction Factor(dB/m)
2. Correction Factor(dB/m) = Antenna Factor(dB/m) + Cable Factor(dB) – Pre-Amplifier Factor(dB)
3. The other emission levels were very low against the limit.
4. Margin value = Emission Level – Limit value
5. " * ": Fundamental frequency.
6. " # ": The radiated frequency is out of the restricted band.



A D T

802.11ac (VHT40)

CHANNEL	TX Channel 38	DETECTOR FUNCTION	Peak (PK)
FREQUENCY RANGE	1GHz ~ 40GHz		Average (AV)

ANTENNA POLARITY & TEST DISTANCE: HORIZONTAL AT 3 M

NO.	FREQ. (MHz)	EMISSION LEVEL (dBuV/m)	LIMIT (dBuV/m)	MARGIN (dB)	ANTENNA HEIGHT (m)	TABLE ANGLE (Degree)	RAW VALUE (dBuV)	CORRECTION FACTOR (dB/m)
1	5150.00	62.1 PK	74.0	-11.9	1.29 H	135	21.54	40.56
2	5150.00	51.1 AV	54.0	-2.9	1.29 H	135	10.54	40.56
3	*5190.00	103.9 PK			1.27 H	143	63.24	40.66
4	*5190.00	95.9 AV			1.27 H	143	55.24	40.66
5	#10380.00	55.5 PK	74.0	-18.5	1.09 H	125	8.77	46.73
6	#10380.00	41.7 AV	54.0	-12.3	1.09 H	125	-5.03	46.73
7	15570.00	67.4 PK	74.0	-6.6	1.01 H	264	16.16	51.24
8	15570.00	51.8 AV	54.0	-2.2	1.01 H	264	0.56	51.24

ANTENNA POLARITY & TEST DISTANCE: VERTICAL AT 3 M

NO.	FREQ. (MHz)	EMISSION LEVEL (dBuV/m)	LIMIT (dBuV/m)	MARGIN (dB)	ANTENNA HEIGHT (m)	TABLE ANGLE (Degree)	RAW VALUE (dBuV)	CORRECTION FACTOR (dB/m)
1	5150.00	63.6 PK	74.0	-10.4	1.28 V	121	23.04	40.56
2	5150.00	53.2 AV	54.0	-0.8	1.28 V	121	12.64	40.56
3	*5190.00	106.5 PK			1.28 V	275	65.84	40.66
4	*5190.00	98.5 AV			1.28 V	275	57.84	40.66
5	#10380.00	53.4 PK	74.0	-20.6	1.10 V	77	6.67	46.73
6	#10380.00	40.4 AV	54.0	-13.6	1.10 V	77	-6.33	46.73
7	15570.00	64.6 PK	74.0	-9.4	1.28 V	15	13.36	51.24
8	15570.00	51.7 AV	54.0	-2.3	1.28 V	15	0.46	51.24

REMARKS:

1. Emission Level(dBuV/m) = Raw Value(dBuV) + Correction Factor(dB/m)
2. Correction Factor(dB/m) = Antenna Factor(dB/m) + Cable Factor(dB) – Pre-Amplifier Factor(dB)
3. The other emission levels were very low against the limit.
4. Margin value = Emission Level – Limit value
5. " * ": Fundamental frequency.
6. " # ": The radiated frequency is out of the restricted band.



A D T

CHANNEL	TX Channel 46	DETECTOR FUNCTION	Peak (PK)
FREQUENCY RANGE	1GHz ~ 40GHz		Average (AV)

ANTENNA POLARITY & TEST DISTANCE: HORIZONTAL AT 3 M

NO.	FREQ. (MHz)	EMISSION LEVEL (dBuV/m)	LIMIT (dBuV/m)	MARGIN (dB)	ANTENNA HEIGHT (m)	TABLE ANGLE (Degree)	RAW VALUE (dBuV)	CORRECTION FACTOR (dB/m)
1	*5230.00	109.6 PK			1.35 H	49	68.86	40.74
2	*5230.00	99.5 AV			1.35 H	49	58.76	40.74
3	#10460.00	55.5 PK	74.0	-18.5	1.20 H	172	8.73	46.77
4	#10460.00	44.0 AV	54.0	-10.0	1.20 H	172	-2.77	46.77
5	15690.00	68.9 PK	74.0	-5.1	1.00 H	282	17.60	51.30
6	15690.00	53.2 AV	54.0	-0.8	1.00 H	282	1.90	51.30

ANTENNA POLARITY & TEST DISTANCE: VERTICAL AT 3 M

NO.	FREQ. (MHz)	EMISSION LEVEL (dBuV/m)	LIMIT (dBuV/m)	MARGIN (dB)	ANTENNA HEIGHT (m)	TABLE ANGLE (Degree)	RAW VALUE (dBuV)	CORRECTION FACTOR (dB/m)
1	*5230.00	114.9 PK			1.30 V	171	74.16	40.74
2	*5230.00	104.0 AV			1.30 V	171	63.26	40.74
3	#10460.00	54.6 PK	74.0	-19.4	1.16 V	89	7.83	46.77
4	#10460.00	42.2 AV	54.0	-11.8	1.16 V	89	-4.57	46.77
5	15690.00	64.9 PK	74.0	-9.1	1.27 V	1	13.60	51.30
6	15690.00	51.0 AV	54.0	-3.0	1.27 V	1	-0.30	51.30

REMARKS:

1. Emission Level(dBuV/m) = Raw Value(dBuV) + Correction Factor(dB/m)
2. Correction Factor(dB/m) = Antenna Factor(dB/m) + Cable Factor(dB) – Pre-Amplifier Factor(dB)
3. The other emission levels were very low against the limit.
4. Margin value = Emission Level – Limit value
5. " * ": Fundamental frequency.
6. " # ": The radiated frequency is out of the restricted band.



A D T

CHANNEL	TX Channel 54	DETECTOR FUNCTION	Peak (PK)
FREQUENCY RANGE	1GHz ~ 40GHz		Average (AV)

ANTENNA POLARITY & TEST DISTANCE: HORIZONTAL AT 3 M

NO.	FREQ. (MHz)	EMISSION LEVEL (dBuV/m)	LIMIT (dBuV/m)	MARGIN (dB)	ANTENNA HEIGHT (m)	TABLE ANGLE (Degree)	RAW VALUE (dBuV)	CORRECTION FACTOR (dB/m)
1	*5270.00	108.8 PK			1.35 H	40	68.00	40.80
2	*5270.00	99.0 AV			1.35 H	40	58.20	40.80
3	#10540.00	55.4 PK	74.0	-18.6	1.20 H	156	8.48	46.92
4	#10540.00	44.0 AV	54.0	-10.0	1.20 H	156	-2.92	46.92
5	15810.00	69.0 PK	74.0	-5.0	1.00 H	267	17.51	51.49
6	15810.00	53.5 AV	54.0	-0.5	1.00 H	267	2.01	51.49

ANTENNA POLARITY & TEST DISTANCE: VERTICAL AT 3 M

NO.	FREQ. (MHz)	EMISSION LEVEL (dBuV/m)	LIMIT (dBuV/m)	MARGIN (dB)	ANTENNA HEIGHT (m)	TABLE ANGLE (Degree)	RAW VALUE (dBuV)	CORRECTION FACTOR (dB/m)
1	*5270.00	115.3 PK			1.32 V	171	74.50	40.80
2	*5270.00	104.4 AV			1.32 V	171	63.60	40.80
3	#10540.00	54.5 PK	74.0	-19.5	1.16 V	104	7.58	46.92
4	#10540.00	42.0 AV	54.0	-12.0	1.16 V	104	-4.92	46.92
5	15810.00	65.5 PK	74.0	-8.5	1.22 V	16	14.01	51.49
6	15810.00	51.3 AV	54.0	-2.7	1.22 V	16	-0.19	51.49

REMARKS:

1. Emission Level(dBuV/m) = Raw Value(dBuV) + Correction Factor(dB/m)
2. Correction Factor(dB/m) = Antenna Factor(dB/m) + Cable Factor(dB) – Pre-Amplifier Factor(dB)
3. The other emission levels were very low against the limit.
4. Margin value = Emission Level – Limit value
5. " * ": Fundamental frequency.
6. " # ": The radiated frequency is out of the restricted band.



AVDT

CHANNEL	TX Channel 62	DETECTOR FUNCTION	Peak (PK)
FREQUENCY RANGE	1GHz ~ 40GHz		Average (AV)

ANTENNA POLARITY & TEST DISTANCE: HORIZONTAL AT 3 M

NO.	FREQ. (MHz)	EMISSION LEVEL (dBuV/m)	LIMIT (dBuV/m)	MARGIN (dB)	ANTENNA HEIGHT (m)	TABLE ANGLE (Degree)	RAW VALUE (dBuV)	CORRECTION FACTOR (dB/m)
1	*5310.00	103.9 PK			1.31 H	248	63.03	40.87
2	*5310.00	96.2 AV			1.31 H	248	55.33	40.87
3	5350.00	63.9 PK	74.0	-10.1	1.31 H	248	22.96	40.94
4	5350.00	49.3 AV	54.0	-4.7	1.31 H	248	8.36	40.94
5	10620.00	55.7 PK	74.0	-18.3	1.00 H	110	8.66	47.04
6	10620.00	41.4 AV	54.0	-12.6	1.00 H	110	-5.64	47.04
7	15930.00	67.7 PK	74.0	-6.3	1.00 H	284	16.16	51.54
8	15930.00	51.7 AV	54.0	-2.3	1.00 H	284	0.16	51.54

ANTENNA POLARITY & TEST DISTANCE: VERTICAL AT 3 M

NO.	FREQ. (MHz)	EMISSION LEVEL (dBuV/m)	LIMIT (dBuV/m)	MARGIN (dB)	ANTENNA HEIGHT (m)	TABLE ANGLE (Degree)	RAW VALUE (dBuV)	CORRECTION FACTOR (dB/m)
1	*5310.00	108.5 PK			1.13 V	176	67.63	40.87
2	*5310.00	100.6 AV			1.13 V	176	59.73	40.87
3	5350.00	66.8 PK	74.0	-7.2	1.22 V	184	25.86	40.94
4	5350.00	53.4 AV	54.0	-0.6	1.22 V	184	12.46	40.94
5	10620.00	52.7 PK	74.0	-21.3	1.03 V	54	5.66	47.04
6	10620.00	39.2 AV	54.0	-14.8	1.03 V	54	-7.84	47.04
7	15930.00	63.9 PK	74.0	-10.1	1.20 V	6	12.36	51.54
8	15930.00	50.9 AV	54.0	-3.1	1.20 V	6	-0.64	51.54

REMARKS:

1. Emission Level(dBuV/m) = Raw Value(dBuV) + Correction Factor(dB/m)
2. Correction Factor(dB/m) = Antenna Factor(dB/m) + Cable Factor(dB) – Pre-Amplifier Factor(dB)
3. The other emission levels were very low against the limit.
4. Margin value = Emission Level – Limit value
5. " * ": Fundamental frequency.



A D T

CHANNEL	TX Channel 102	DETECTOR FUNCTION	Peak (PK)
FREQUENCY RANGE	1GHz ~ 40GHz		Average (AV)

ANTENNA POLARITY & TEST DISTANCE: HORIZONTAL AT 3 M

NO.	FREQ. (MHz)	EMISSION LEVEL (dBuV/m)	LIMIT (dBuV/m)	MARGIN (dB)	ANTENNA HEIGHT (m)	TABLE ANGLE (Degree)	RAW VALUE (dBuV)	CORRECTION FACTOR (dB/m)
1	5460.00	56.9 PK	74.0	-17.1	1.26 H	149	15.78	41.12
2	5460.00	45.3 AV	54.0	-8.7	1.26 H	149	4.18	41.12
3	#5470.00	67.0 PK	74.0	-7.0	1.26 H	149	25.86	41.14
4	#5470.00	51.2 AV	54.0	-2.8	1.26 H	149	10.06	41.14
5	*5510.00	103.5 PK			1.26 H	149	62.28	41.22
6	*5510.00	95.8 AV			1.26 H	149	54.58	41.22
7	11020.00	55.6 PK	74.0	-18.4	1.12 H	114	8.26	47.34
8	11020.00	41.8 AV	54.0	-12.2	1.12 H	114	-5.54	47.34
9	#16530.00	67.7 PK	74.0	-6.3	1.00 H	288	14.71	52.99
10	#16530.00	51.9 AV	54.0	-2.1	1.00 H	288	-1.09	52.99

ANTENNA POLARITY & TEST DISTANCE: VERTICAL AT 3 M

NO.	FREQ. (MHz)	EMISSION LEVEL (dBuV/m)	LIMIT (dBuV/m)	MARGIN (dB)	ANTENNA HEIGHT (m)	TABLE ANGLE (Degree)	RAW VALUE (dBuV)	CORRECTION FACTOR (dB/m)
1	5460.00	58.7 PK	74.0	-15.3	1.21 V	173	17.58	41.12
2	5460.00	47.7 AV	54.0	-6.3	1.21 V	173	6.58	41.12
3	#5470.00	69.0 PK	74.0	-5.0	1.21 V	173	27.86	41.14
4	#5470.00	53.3 AV	54.0	-0.7	1.21 V	173	12.16	41.14
5	*5510.00	107.1 PK			1.18 V	185	65.88	41.22
6	*5510.00	99.0 AV			1.18 V	185	57.78	41.22
7	11020.00	54.0 PK	74.0	-20.0	1.14 V	76	6.66	47.34
8	11020.00	41.6 AV	54.0	-12.4	1.14 V	76	-5.74	47.34
9	#16530.00	64.3 PK	74.0	-9.7	1.23 V	3	11.31	52.99
10	#16530.00	50.2 AV	54.0	-3.8	1.23 V	3	-2.79	52.99

REMARKS:

1. Emission Level(dBuV/m) = Raw Value(dBuV) + Correction Factor(dB/m)
2. Correction Factor(dB/m) = Antenna Factor(dB/m) + Cable Factor(dB) – Pre-Amplifier Factor(dB)
3. The other emission levels were very low against the limit.
4. Margin value = Emission Level – Limit value
5. " * ": Fundamental frequency.
6. " # ": The radiated frequency is out of the restricted band.



A D T

CHANNEL	TX Channel 118	DETECTOR FUNCTION	Peak (PK)
FREQUENCY RANGE	1GHz ~ 40GHz		Average (AV)

ANTENNA POLARITY & TEST DISTANCE: HORIZONTAL AT 3 M

NO.	FREQ. (MHz)	EMISSION LEVEL (dBuV/m)	LIMIT (dBuV/m)	MARGIN (dB)	ANTENNA HEIGHT (m)	TABLE ANGLE (Degree)	RAW VALUE (dBuV)	CORRECTION FACTOR (dB/m)
1	*5590.00	112.3 PK			1.32 H	58	70.96	41.34
2	*5590.00	104.3 AV			1.32 H	58	62.96	41.34
3	#5725.00	49.7 PK	74.0	-24.3	1.32 H	58	8.22	41.48
4	#5725.00	38.7 AV	54.0	-15.3	1.32 H	58	-2.78	41.48
5	11180.00	55.5 PK	74.0	-18.5	1.25 H	179	8.40	47.10
6	11180.00	43.9 AV	54.0	-10.1	1.25 H	179	-3.20	47.10
7	#16770.00	69.6 PK	74.0	-4.4	1.02 H	272	15.94	53.66
8	#16770.00	53.7 AV	54.0	-0.3	1.02 H	272	0.04	53.66

ANTENNA POLARITY & TEST DISTANCE: VERTICAL AT 3 M

NO.	FREQ. (MHz)	EMISSION LEVEL (dBuV/m)	LIMIT (dBuV/m)	MARGIN (dB)	ANTENNA HEIGHT (m)	TABLE ANGLE (Degree)	RAW VALUE (dBuV)	CORRECTION FACTOR (dB/m)
1	*5590.00	116.8 PK			1.30 V	299	75.46	41.34
2	*5590.00	108.2 AV			1.30 V	299	66.86	41.34
3	#5725.00	51.9 PK	74.0	-22.1	1.30 V	299	10.42	41.48
4	#5725.00	40.5 AV	54.0	-13.5	1.30 V	299	-0.98	41.48
5	11180.00	55.1 PK	74.0	-18.9	1.18 V	84	8.00	47.10
6	11180.00	42.5 AV	54.0	-11.5	1.18 V	84	-4.60	47.10
7	#16770.00	65.0 PK	74.0	-9.0	1.28 V	16	11.34	53.66
8	#16770.00	51.3 AV	54.0	-2.7	1.28 V	16	-2.36	53.66

REMARKS:

1. Emission Level(dBuV/m) = Raw Value(dBuV) + Correction Factor(dB/m)
2. Correction Factor(dB/m) = Antenna Factor(dB/m) + Cable Factor(dB) – Pre-Amplifier Factor(dB)
3. The other emission levels were very low against the limit.
4. Margin value = Emission Level – Limit value
5. " * ": Fundamental frequency.
6. " # ": The radiated frequency is out of the restricted band.



A D T

CHANNEL	TX Channel 134	DETECTOR FUNCTION	Peak (PK)
FREQUENCY RANGE	1GHz ~ 40GHz		Average (AV)

ANTENNA POLARITY & TEST DISTANCE: HORIZONTAL AT 3 M

NO.	FREQ. (MHz)	EMISSION LEVEL (dBuV/m)	LIMIT (dBuV/m)	MARGIN (dB)	ANTENNA HEIGHT (m)	TABLE ANGLE (Degree)	RAW VALUE (dBuV)	CORRECTION FACTOR (dB/m)
1	*5670.00	110.2 PK			1.38 H	44	68.77	41.43
2	*5670.00	102.3 AV			1.38 H	44	60.87	41.43
3	#5725.00	68.7 PK	74.0	-5.3	1.38 H	44	27.22	41.48
4	#5725.00	51.2 AV	54.0	-2.8	1.38 H	44	9.72	41.48
5	11340.00	53.2 PK	74.0	-20.8	1.21 H	186	6.12	47.08
6	11340.00	43.2 AV	54.0	-10.8	1.21 H	186	-3.88	47.08
7	#17010.00	66.6 PK	74.0	-7.4	1.03 H	266	12.37	54.23
8	#17010.00	51.0 AV	54.0	-3.0	1.03 H	266	-3.23	54.23

ANTENNA POLARITY & TEST DISTANCE: VERTICAL AT 3 M

NO.	FREQ. (MHz)	EMISSION LEVEL (dBuV/m)	LIMIT (dBuV/m)	MARGIN (dB)	ANTENNA HEIGHT (m)	TABLE ANGLE (Degree)	RAW VALUE (dBuV)	CORRECTION FACTOR (dB/m)
1	*5670.00	114.7 PK			1.27 V	283	73.27	41.43
2	*5670.00	106.7 AV			1.27 V	283	65.27	41.43
3	#5725.00	70.2 PK	74.0	-3.8	1.26 V	277	28.72	41.48
4	#5725.00	53.5 AV	54.0	-0.5	1.26 V	277	12.02	41.48
5	11340.00	53.6 PK	74.0	-20.4	1.17 V	82	6.52	47.08
6	11340.00	41.3 AV	54.0	-12.7	1.17 V	82	-5.78	47.08
7	#17010.00	63.3 PK	74.0	-10.7	1.29 V	26	9.07	54.23
8	#17010.00	49.5 AV	54.0	-4.5	1.29 V	26	-4.73	54.23

REMARKS:

1. Emission Level(dBuV/m) = Raw Value(dBuV) + Correction Factor(dB/m)
2. Correction Factor(dB/m) = Antenna Factor(dB/m) + Cable Factor(dB) – Pre-Amplifier Factor(dB)
3. The other emission levels were very low against the limit.
4. Margin value = Emission Level – Limit value
5. " * ": Fundamental frequency.
6. " # ": The radiated frequency is out of the restricted band.



A D T

CHANNEL	TX Channel 151	DETECTOR FUNCTION	Peak (PK)
FREQUENCY RANGE	1GHz ~ 40GHz		Average (AV)

ANTENNA POLARITY & TEST DISTANCE: HORIZONTAL AT 3 M

NO.	FREQ. (MHz)	EMISSION LEVEL (dBuV/m)	LIMIT (dBuV/m)	MARGIN (dB)	ANTENNA HEIGHT (m)	TABLE ANGLE (Degree)	RAW VALUE (dBuV)	CORRECTION FACTOR (dB/m)
1	#5715.00	67.3 PK	74.0	-6.7	1.19 H	297	25.84	41.46
2	#5715.00	50.2 AV	54.0	-3.8	1.19 H	297	8.74	41.46
3	#5725.00	70.4 PK	78.2	-7.8	1.19 H	295	28.92	41.48
4	*5755.00	104.3 PK			1.20 H	311	62.79	41.51
5	*5755.00	95.6 AV			1.20 H	311	54.09	41.51
6	11510.00	53.2 PK	74.0	-20.8	1.00 H	131	6.05	47.15
7	11510.00	41.9 AV	54.0	-12.1	1.00 H	131	-5.25	47.15
8	#17265.00	63.7 PK	74.0	-10.3	1.07 H	298	8.76	54.94
9	#17265.00	49.7 AV	54.0	-4.3	1.07 H	298	-5.24	54.94

ANTENNA POLARITY & TEST DISTANCE: VERTICAL AT 3 M

NO.	FREQ. (MHz)	EMISSION LEVEL (dBuV/m)	LIMIT (dBuV/m)	MARGIN (dB)	ANTENNA HEIGHT (m)	TABLE ANGLE (Degree)	RAW VALUE (dBuV)	CORRECTION FACTOR (dB/m)
1	#5715.00	72.3 PK	74.0	-1.7	1.27 V	107	30.84	41.46
2	#5715.00	52.4 AV	54.0	-1.6	1.27 V	107	10.94	41.46
3	#5725.00	77.8 PK	78.2	-0.4	1.02 V	64	36.32	41.48
4	*5755.00	110.2 PK			1.00 V	103	68.69	41.51
5	*5755.00	100.0 AV			1.00 V	103	58.49	41.51
6	11510.00	51.3 PK	74.0	-22.7	1.10 V	54	4.15	47.15
7	11510.00	37.6 AV	54.0	-16.4	1.10 V	54	-9.55	47.15
8	#17265.00	63.9 PK	74.0	-10.1	1.13 V	23	8.96	54.94
9	#17265.00	50.5 AV	54.0	-3.5	1.13 V	23	-4.44	54.94

REMARKS:

1. Emission Level(dBuV/m) = Raw Value(dBuV) + Correction Factor(dB/m)
2. Correction Factor(dB/m) = Antenna Factor(dB/m) + Cable Factor(dB) – Pre-Amplifier Factor(dB)
3. The other emission levels were very low against the limit.
4. Margin value = Emission Level – Limit value
5. " * " : Fundamental frequency.
6. " # " : The radiated frequency is out of the restricted band.



A D T

CHANNEL	TX Channel 159	DETECTOR FUNCTION	Peak (PK)
FREQUENCY RANGE	1GHz ~ 40GHz		Average (AV)

ANTENNA POLARITY & TEST DISTANCE: HORIZONTAL AT 3 M

NO.	FREQ. (MHz)	EMISSION LEVEL (dBuV/m)	LIMIT (dBuV/m)	MARGIN (dB)	ANTENNA HEIGHT (m)	TABLE ANGLE (Degree)	RAW VALUE (dBuV)	CORRECTION FACTOR (dB/m)
1	*5795.00	107.4 PK			1.11 H	313	65.84	41.56
2	*5795.00	98.3 AV			1.11 H	313	56.74	41.56
3	#5850.00	72.6 PK	78.2	-5.6	1.15 H	280	30.92	41.68
4	#5860.00	68.5 PK	74.0	-5.5	1.13 H	251	26.79	41.71
5	#5860.00	50.8 AV	54.0	-3.2	1.13 H	251	9.09	41.71
6	11590.00	55.3 PK	74.0	-18.7	1.00 H	140	8.09	47.21
7	11590.00	43.2 AV	54.0	-10.8	1.00 H	140	-4.01	47.21
8	#17385.00	63.4 PK	74.0	-10.6	1.02 H	296	8.29	55.11
9	#17385.00	49.8 AV	54.0	-4.2	1.02 H	296	-5.31	55.11

ANTENNA POLARITY & TEST DISTANCE: VERTICAL AT 3 M

NO.	FREQ. (MHz)	EMISSION LEVEL (dBuV/m)	LIMIT (dBuV/m)	MARGIN (dB)	ANTENNA HEIGHT (m)	TABLE ANGLE (Degree)	RAW VALUE (dBuV)	CORRECTION FACTOR (dB/m)
1	*5795.00	113.6 PK			1.00 V	89	72.04	41.56
2	*5795.00	103.1 AV			1.00 V	89	61.54	41.56
3	#5850.00	76.5 PK	78.2	-1.7	1.22 V	90	34.82	41.68
4	#5860.00	70.9 PK	74.0	-3.1	1.19 V	106	29.19	41.71
5	#5860.00	52.2 AV	54.0	-1.8	1.19 V	106	10.49	41.71
6	11590.00	57.2 PK	74.0	-16.8	1.17 V	85	9.99	47.21
7	11590.00	44.6 AV	54.0	-9.4	1.17 V	85	-2.61	47.21
8	#17385.00	63.4 PK	74.0	-10.6	1.16 V	27	8.29	55.11
9	#17385.00	50.0 AV	54.0	-4.0	1.16 V	27	-5.11	55.11

REMARKS:

1. Emission Level(dBuV/m) = Raw Value(dBuV) + Correction Factor(dB/m)
2. Correction Factor(dB/m) = Antenna Factor(dB/m) + Cable Factor(dB) – Pre-Amplifier Factor(dB)
3. The other emission levels were very low against the limit.
4. Margin value = Emission Level – Limit value
5. " * ": Fundamental frequency.
6. " # ": The radiated frequency is out of the restricted band.



A D T

802.11ac (VHT80)

CHANNEL	TX Channel 42	DETECTOR FUNCTION	Peak (PK)
FREQUENCY RANGE	1GHz ~ 40GHz		Average (AV)

ANTENNA POLARITY & TEST DISTANCE: HORIZONTAL AT 3 M

NO.	FREQ. (MHz)	EMISSION LEVEL (dBuV/m)	LIMIT (dBuV/m)	MARGIN (dB)	ANTENNA HEIGHT (m)	TABLE ANGLE (Degree)	RAW VALUE (dBuV)	CORRECTION FACTOR (dB/m)
1	5150.00	65.4 PK	74.0	-8.6	1.51 H	127	24.84	40.56
2	5150.00	52.5 AV	54.0	-1.5	1.51 H	127	11.94	40.56
3	*5210.00	101.4 PK			1.23 H	131	60.70	40.70
4	*5210.00	91.3 AV			1.23 H	131	50.60	40.70
5	5350.00	51.3 PK	74.0	-22.7	1.23 H	131	10.36	40.94
6	5350.00	37.6 AV	54.0	-16.4	1.23 H	131	-3.34	40.94
7	#10420.00	56.1 PK	74.0	-17.9	1.04 H	126	9.37	46.73
8	#10420.00	42.0 AV	54.0	-12.0	1.04 H	126	-4.73	46.73
9	15630.00	64.5 PK	74.0	-9.5	1.07 H	269	13.21	51.29
10	15630.00	48.9 AV	54.0	-5.1	1.07 H	269	-2.39	51.29

ANTENNA POLARITY & TEST DISTANCE: VERTICAL AT 3 M

NO.	FREQ. (MHz)	EMISSION LEVEL (dBuV/m)	LIMIT (dBuV/m)	MARGIN (dB)	ANTENNA HEIGHT (m)	TABLE ANGLE (Degree)	RAW VALUE (dBuV)	CORRECTION FACTOR (dB/m)
1	5150.00	65.9 PK	74.0	-8.1	1.16 V	262	25.34	40.56
2	5150.00	52.7 AV	54.0	-1.3	1.16 V	262	12.14	40.56
3	*5210.00	103.5 PK			1.14 V	261	62.80	40.70
4	*5210.00	97.5 AV			1.14 V	261	56.80	40.70
5	5350.00	52.5 PK	74.0	-21.5	1.14 V	261	11.56	40.94
6	5350.00	39.5 AV	54.0	-14.5	1.14 V	261	-1.44	40.94
7	#10420.00	53.6 PK	74.0	-20.4	1.06 V	75	6.87	46.73
8	#10420.00	40.4 AV	54.0	-13.6	1.06 V	75	-6.33	46.73
9	15630.00	64.7 PK	74.0	-9.3	1.25 V	22	13.41	51.29
10	15630.00	51.8 AV	54.0	-2.2	1.25 V	22	0.51	51.29

REMARKS:

1. Emission Level(dBuV/m) = Raw Value(dBuV) + Correction Factor(dB/m)
2. Correction Factor(dB/m) = Antenna Factor(dB/m) + Cable Factor(dB) – Pre-Amplifier Factor(dB)
3. The other emission levels were very low against the limit.
4. Margin value = Emission Level – Limit value
5. " * ": Fundamental frequency.
6. " # ": The radiated frequency is out of the restricted band.



A D T

CHANNEL	TX Channel 58	DETECTOR FUNCTION	Peak (PK)
FREQUENCY RANGE	1GHz ~ 40GHz		Average (AV)

ANTENNA POLARITY & TEST DISTANCE: HORIZONTAL AT 3 M

NO.	FREQ. (MHz)	EMISSION LEVEL (dBuV/m)	LIMIT (dBuV/m)	MARGIN (dB)	ANTENNA HEIGHT (m)	TABLE ANGLE (Degree)	RAW VALUE (dBuV)	CORRECTION FACTOR (dB/m)
1	*5290.00	104.9 PK			1.27 H	277	64.06	40.84
2	*5290.00	94.4 AV			1.27 H	277	53.56	40.84
3	5358.66	65.2 PK	74.0	-8.8	1.25 H	277	24.25	40.95
4	5358.66	50.1 AV	54.0	-3.9	1.25 H	277	9.15	40.95
5	#10580.00	56.4 PK	74.0	-17.6	1.03 H	137	9.38	47.02
6	#10580.00	42.4 AV	54.0	-11.6	1.03 H	137	-4.62	47.02
7	15870.00	65.0 PK	74.0	-9.0	1.00 H	266	13.47	51.53
8	15870.00	49.4 AV	54.0	-4.6	1.00 H	266	-2.13	51.53

ANTENNA POLARITY & TEST DISTANCE: VERTICAL AT 3 M

NO.	FREQ. (MHz)	EMISSION LEVEL (dBuV/m)	LIMIT (dBuV/m)	MARGIN (dB)	ANTENNA HEIGHT (m)	TABLE ANGLE (Degree)	RAW VALUE (dBuV)	CORRECTION FACTOR (dB/m)
1	*5290.00	108.9 PK			1.25 V	100	68.06	40.84
2	*5290.00	98.4 AV			1.25 V	100	57.56	40.84
3	5352.42	68.8 PK	74.0	-5.2	1.25 V	100	27.86	40.94
4	5352.42	53.5 AV	54.0	-0.5	1.25 V	100	12.56	40.94
5	#10580.00	54.0 PK	74.0	-20.0	1.05 V	72	6.98	47.02
6	#10580.00	40.6 AV	54.0	-13.4	1.05 V	72	-6.42	47.02
7	15870.00	64.7 PK	74.0	-9.3	1.27 V	16	13.17	51.53
8	15870.00	51.8 AV	54.0	-2.2	1.27 V	16	0.27	51.53

REMARKS:

1. Emission Level(dBuV/m) = Raw Value(dBuV) + Correction Factor(dB/m)
2. Correction Factor(dB/m) = Antenna Factor(dB/m) + Cable Factor(dB) – Pre-Amplifier Factor(dB)
3. The other emission levels were very low against the limit.
4. Margin value = Emission Level – Limit value
5. " * ": Fundamental frequency.
6. " # ": The radiated frequency is out of the restricted band.



A D T

CHANNEL	TX Channel 106	DETECTOR FUNCTION	Peak (PK)
FREQUENCY RANGE	1GHz ~ 40GHz		Average (AV)

ANTENNA POLARITY & TEST DISTANCE: HORIZONTAL AT 3 M

NO.	FREQ. (MHz)	EMISSION LEVEL (dBuV/m)	LIMIT (dBuV/m)	MARGIN (dB)	ANTENNA HEIGHT (m)	TABLE ANGLE (Degree)	RAW VALUE (dBuV)	CORRECTION FACTOR (dB/m)
1	5460.00	65.4 PK	74.0	-8.6	1.19 H	124	24.28	41.12
2	5460.00	49.3 AV	54.0	-4.7	1.19 H	124	8.18	41.12
3	#5470.00	56.8 PK	74.0	-17.2	1.19 H	124	15.66	41.14
4	#5470.00	51.6 AV	54.0	-2.4	1.19 H	124	10.46	41.14
5	*5530.00	103.1 PK			1.19 H	124	61.86	41.24
6	*5530.00	92.8 AV			1.19 H	124	51.56	41.24
7	11060.00	56.0 PK	74.0	-18.0	1.05 H	139	8.80	47.20
8	11060.00	42.1 AV	54.0	-11.9	1.05 H	139	-5.10	47.20
9	#16590.00	64.6 PK	74.0	-9.4	1.00 H	275	11.53	53.07
10	#16590.00	49.1 AV	54.0	-4.9	1.00 H	275	-3.97	53.07

ANTENNA POLARITY & TEST DISTANCE: VERTICAL AT 3 M

NO.	FREQ. (MHz)	EMISSION LEVEL (dBuV/m)	LIMIT (dBuV/m)	MARGIN (dB)	ANTENNA HEIGHT (m)	TABLE ANGLE (Degree)	RAW VALUE (dBuV)	CORRECTION FACTOR (dB/m)
1	5460.00	67.6 PK	74.0	-6.4	1.27 V	12	26.48	41.12
2	5460.00	51.6 AV	54.0	-2.4	1.27 V	12	10.48	41.12
3	#5470.00	68.3 PK	74.0	-5.7	1.25 V	6	27.16	41.14
4	#5470.00	53.6 AV	54.0	-0.4	1.25 V	6	12.46	41.14
5	*5530.00	107.7 PK			1.25 V	6	66.46	41.24
6	*5530.00	96.0 AV			1.25 V	6	54.76	41.24
7	11060.00	52.9 PK	74.0	-21.1	1.04 V	62	5.70	47.20
8	11060.00	40.0 AV	54.0	-14.0	1.04 V	62	-7.20	47.20
9	#16590.00	64.7 PK	74.0	-9.3	1.29 V	19	11.63	53.07
10	#16590.00	51.5 AV	54.0	-2.5	1.29 V	19	-1.57	53.07

REMARKS:

1. Emission Level(dBuV/m) = Raw Value(dBuV) + Correction Factor(dB/m)
2. Correction Factor(dB/m) = Antenna Factor(dB/m) + Cable Factor(dB) – Pre-Amplifier Factor(dB)
3. The other emission levels were very low against the limit.
4. Margin value = Emission Level – Limit value
5. " * ": Fundamental frequency.
6. " # ": The radiated frequency is out of the restricted band.



A D T

CHANNEL	TX Channel 122	DETECTOR FUNCTION	Peak (PK)
FREQUENCY RANGE	1GHz ~ 40GHz		Average (AV)

ANTENNA POLARITY & TEST DISTANCE: HORIZONTAL AT 3 M

NO.	FREQ. (MHz)	EMISSION LEVEL (dBuV/m)	LIMIT (dBuV/m)	MARGIN (dB)	ANTENNA HEIGHT (m)	TABLE ANGLE (Degree)	RAW VALUE (dBuV)	CORRECTION FACTOR (dB/m)
1	5460.00	67.3 PK	74.0	-6.7	1.22 H	154	26.18	41.12
2	5460.00	48.7 AV	54.0	-5.3	1.22 H	154	7.58	41.12
3	#5470.00	69.2 PK	74.0	-4.8	1.23 H	154	28.06	41.14
4	#5470.00	50.4 AV	54.0	-3.6	1.23 H	154	9.26	41.14
5	*5610.00	106.6 PK			1.23 H	154	65.23	41.37
6	*5610.00	98.3 AV			1.23 H	154	56.93	41.37
7	11220.00	54.9 PK	74.0	-19.1	1.05 H	114	7.78	47.12
8	11220.00	41.3 AV	54.0	-12.7	1.05 H	114	-5.82	47.12
9	#16830.00	63.9 PK	74.0	-10.1	1.04 H	280	10.05	53.85
10	#16830.00	48.5 AV	54.0	-5.5	1.04 H	280	-5.35	53.85

ANTENNA POLARITY & TEST DISTANCE: VERTICAL AT 3 M

NO.	FREQ. (MHz)	EMISSION LEVEL (dBuV/m)	LIMIT (dBuV/m)	MARGIN (dB)	ANTENNA HEIGHT (m)	TABLE ANGLE (Degree)	RAW VALUE (dBuV)	CORRECTION FACTOR (dB/m)
1	5460.00	69.2 PK	74.0	-4.8	1.21 V	10	28.08	41.12
2	5460.00	50.8 AV	54.0	-3.2	1.21 V	10	9.68	41.12
3	#5470.00	70.5 PK	74.0	-3.5	1.21 V	10	29.36	41.14
4	#5470.00	52.8 AV	54.0	-1.2	1.21 V	10	11.66	41.14
5	*5610.00	112.7 PK			1.21 V	10	71.33	41.37
6	*5610.00	102.5 AV			1.21 V	10	61.13	41.37
7	11220.00	53.6 PK	74.0	-20.4	1.11 V	77	6.48	47.12
8	11220.00	40.9 AV	54.0	-13.1	1.11 V	77	-6.22	47.12
9	#16830.00	64.1 PK	74.0	-9.9	1.30 V	7	10.25	53.85
10	#16830.00	51.5 AV	54.0	-2.5	1.30 V	7	-2.35	53.85

REMARKS:

1. Emission Level(dBuV/m) = Raw Value(dBuV) + Correction Factor(dB/m)
2. Correction Factor(dB/m) = Antenna Factor(dB/m) + Cable Factor(dB) – Pre-Amplifier Factor(dB)
3. The other emission levels were very low against the limit.
4. Margin value = Emission Level – Limit value
5. " * ": Fundamental frequency.
6. " # ": The radiated frequency is out of the restricted band.



A D T

CHANNEL	TX Channel 155	DETECTOR FUNCTION	Peak (PK)
FREQUENCY RANGE	1GHz ~ 40GHz		Average (AV)

ANTENNA POLARITY & TEST DISTANCE: HORIZONTAL AT 3 M

NO.	FREQ. (MHz)	EMISSION LEVEL (dBuV/m)	LIMIT (dBuV/m)	MARGIN (dB)	ANTENNA HEIGHT (m)	TABLE ANGLE (Degree)	RAW VALUE (dBuV)	CORRECTION FACTOR (dB/m)
1	#5715.00	68.8 PK	74.0	-5.2	1.21 H	273	27.34	41.46
2	#5715.00	50.7 AV	54.0	-3.3	1.21 H	273	9.24	41.46
3	#5725.00	72.4 PK	78.2	-5.8	1.22 H	281	30.92	41.48
4	*5775.00	97.8 PK			1.19 H	326	56.27	41.53
5	*5775.00	89.7 AV			1.19 H	326	48.17	41.53
6	#5850.00	63.2 PK	78.2	-15.0	1.19 H	326	21.52	41.68
7	#5860.00	61.8 PK	74.0	-12.2	1.18 H	338	20.09	41.71
8	#5860.00	46.8 AV	54.0	-7.2	1.18 H	338	5.09	41.71
9	11550.00	57.4 PK	74.0	-16.6	1.00 H	139	10.22	47.18
10	11550.00	34.9 AV	54.0	-19.1	1.00 H	139	-12.28	47.18
11	#17325.00	64.3 PK	74.0	-9.7	1.02 H	301	9.24	55.06
12	#17325.00	50.5 AV	54.0	-3.5	1.02 H	301	-4.56	55.06

ANTENNA POLARITY & TEST DISTANCE: VERTICAL AT 3 M

NO.	FREQ. (MHz)	EMISSION LEVEL (dBuV/m)	LIMIT (dBuV/m)	MARGIN (dB)	ANTENNA HEIGHT (m)	TABLE ANGLE (Degree)	RAW VALUE (dBuV)	CORRECTION FACTOR (dB/m)
1	#5715.00	71.9 PK	74.0	-2.1	1.26 V	103	30.44	41.46
2	#5715.00	51.9 AV	54.0	-2.1	1.26 V	103	10.44	41.46
3	#5725.00	76.4 PK	78.2	-1.8	1.02 V	88	34.92	41.48
4	*5775.00	105.0 PK			1.00 V	88	63.47	41.53
5	*5775.00	94.4 AV			1.00 V	88	52.87	41.53
6	#5850.00	67.4 PK	78.2	-10.8	1.34 V	130	25.72	41.68
7	#5860.00	65.7 PK	74.0	-8.3	1.34 V	141	23.99	41.71
8	#5860.00	48.4 AV	54.0	-5.6	1.34 V	141	6.69	41.71
9	11550.00	51.2 PK	74.0	-22.8	1.09 V	51	4.02	47.18
10	11550.00	34.3 AV	54.0	-19.7	1.09 V	51	-12.88	47.18
11	#17325.00	63.4 PK	74.0	-10.6	1.16 V	33	8.34	55.06
12	#17325.00	50.0 AV	54.0	-4.0	1.16 V	33	-5.06	55.06

REMARKS:

1. Emission Level(dBuV/m) = Raw Value(dBuV) + Correction Factor(dB/m)
2. Correction Factor(dB/m) = Antenna Factor(dB/m) + Cable Factor(dB) – Pre-Amplifier Factor(dB)
3. The other emission levels were very low against the limit.
4. Margin value = Emission Level – Limit value
5. " * ": Fundamental frequency.
6. " # ": The radiated frequency is out of the restricted band.



A D T

4.3 TRANSMIT POWER MEASUREMENT

4.3.1 LIMITS OF TRANSMIT POWER MEASUREMENT

Operation Band	EUT Category		LIMIT
U-NII-1		Outdoor Access Point	1 Watt (30 dBm) (Max. e.i.r.p \leq 125mW(21 dBm) at any elevation angle above 30 degrees as measured from the horizon)
		Fixed point-to-point Access Point	1 Watt (30 dBm)
		Indoor Access Point	1 Watt (30 dBm)
	√	Mobile and Portable client device	250mW (24 dBm)
U-NII-2A	---		250mW (24 dBm) or 11 dBm+10 log B*
U-NII-2C	---		250mW (24 dBm) or 11 dBm+10 log B*
U-NII-3	---		1 Watt (30 dBm)

Note: Where B is the 26dB emission bandwidth in MHz.

Per KDB 662911 D01 Multiple Transmitter Output Method of conducted output power measurement on IEEE 802.11 devices,

Array Gain = 0 dB (i.e., no array gain) for NANT \leq 4;

Array Gain = 0 dB (i.e., no array gain) for channel widths \geq 40 MHz for any NANT;

Array Gain = 5 log(NANT/NSS) dB or 3 dB, whichever is less for 20-MHz channel widths with NANT \geq 5.

For power measurements on all other devices: Array Gain = 10 log(NANT/NSS) dB.



A D T

4.3.2 TEST INSTRUMENTS

FOR POWER OUTPUT MEASUREMENT

DESCRIPTION & MANUFACTURER	MODEL NO.	SERIAL NO.	CALIBRATED DATE	CALIBRATED UNTIL
Power meter Anritsu	ML2495A	1014008	Apr. 30, 2014	Apr. 29, 2015
Power sensor Anritsu	MA2411B	0917122	Apr. 30, 2014	Apr. 29, 2015

Note:

1. The calibration interval of the above test instruments is 12 months and the calibrations are traceable to NML/ROC and NIST/USA.
2. Tested date : May 16, 2014

FOR 26dB OCCUPIED BANDWIDTH

DESCRIPTION & MANUFACTURER	MODEL NO.	SERIAL NO.	CALIBRATED DATE	CALIBRATED UNTIL
SPECTRUM ANALYZER R&S	FSV 40	100964	July 15, 2013	July 14, 2014

Note:

1. The calibration interval of the above test instruments is 12 months and the calibrations are traceable to NML/ROC and NIST/USA.
2. Tested date : May 16, 2014

4.3.3 TEST PROCEDURE

FOR POWER OUTPUT MEASUREMENT

Method PM is used to perform output power measurement, trigger and gating function of wide band power meter is enabled to measure max output power of TX on burst. Duty factor is not added to measured value.

FOR 26dB OCCUPIED BANDWIDTH

1. Set RBW = approximately 1% of the emission bandwidth.
2. Set the VBW > RBW.
3. Detector = Peak.
4. Trace mode = max hold.
5. Measure the maximum width of the emission that is 26 dB down from the peak of the emission. Compare this with the RBW setting of the analyzer. Readjust RBW and repeat measurement as needed until the RBW/EBW ratio is approximately 1%.

4.3.4 DEVIATION FROM TEST STANDARD

No deviation

4.3.5 TEST SETUP

FOR POWER OUTPUT MEASUREMENT

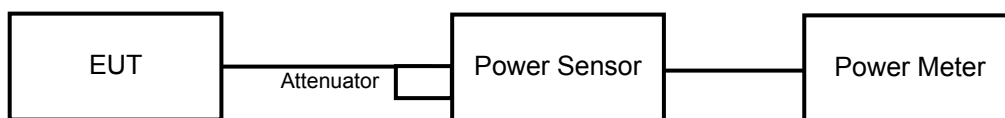

FOR 26dB OCCUPIED BANDWIDTH

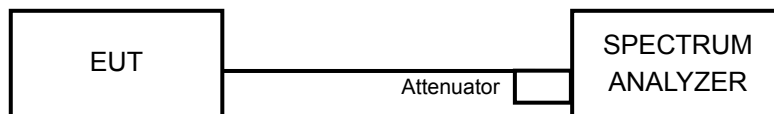

4.3.6 EUT OPERATING CONDITIONS

The software provided by client to enable the EUT under transmission condition continuously at specific channel frequencies individually.



4.3.7 TEST RESULTS

802.11a

CHAN.	CHAN. FREQ. (MHz)	AVERAGE POWER (dBm)		TOTAL POWER (mW)	TOTAL POWER (dBm)	POWER LIMIT (dBm)	PASS / FAIL
		CHAIN 0	CHAIN 1				
36	5180	17.80	18.00	123.352	20.91	24	PASS
40	5200	16.21	14.96	73.116	18.64	24	PASS
48	5240	17.48	16.83	104.171	20.18	24	PASS
52	5260	18.17	17.58	122.895	20.90	24	PASS
60	5300	18.88	17.85	138.222	21.41	24	PASS
64	5320	17.90	18.10	126.225	21.01	24	PASS
100	5500	18.70	18.30	141.739	21.51	24	PASS
120	5600	17.83	17.79	120.791	20.82	24	PASS
140	5700	16.30	16.80	90.521	19.57	24	PASS
149	5745	15.83	13.60	61.191	17.87	30	PASS
157	5785	20.72	20.64	233.91	23.69	30	PASS
165	5825	16.18	16.32	84.35	19.26	30	PASS

26dB OCCUPIED BANDWIDTH:

CHANNEL	CHANNEL FREQUENCY (MHz)	26dBc BANDWIDTH (MHz)	
		CHAIN 0	CHAIN 1
36	5180	33.66	33.79
40	5200	25.43	20.65
48	5240	29.78	29.09
52	5260	32.77	30.31
60	5300	32.50	27.15
64	5320	27.55	30.23
100	5500	31.59	33.40
120	5600	32.05	31.65
140	5700	22.52	24.88

Note: For U-NII-2A, U-NII-2C Band output power limitation is determined based on 26dBc bandwidth.



A D T

Power Limit = 11dBm + 10logB < U-NII-2A, U-NII-2C >			
Channel Number	Freq.(MHz)	Min. B(MHz)	Determined Conducted Limit (dBm)
52	5260	30.31	25.81 > 24
60	5300	27.15	25.33 > 24
64	5320	27.55	25.4 > 24
100	5500	31.59	25.99 > 24
120	5600	31.65	26 > 24
140	5700	22.52	24.52 > 24

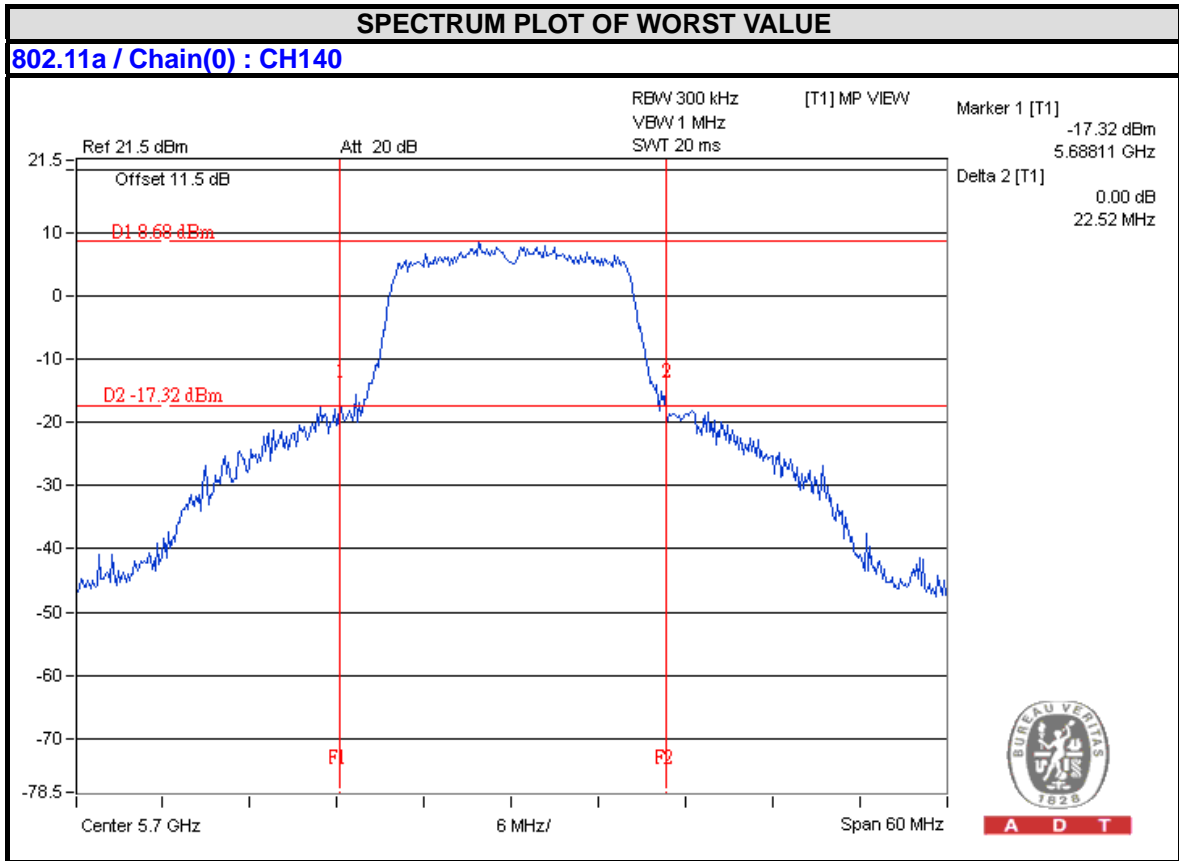



802.11ac (VHT20)

CHAN.	CHAN. FREQ. (MHz)	AVERAGE POWER (dBm)		TOTAL POWER (mW)	TOTAL POWER (dBm)	POWER LIMIT (dBm)	PASS / FAIL
		CHAIN 0	CHAIN 1				
36	5180	19.30	17.50	141.348	21.50	24	PASS
40	5200	18.50	16.71	117.676	20.71	24	PASS
48	5240	18.93	18.24	144.844	21.61	24	PASS
52	5260	17.73	17.52	115.787	20.64	24	PASS
60	5300	17.71	17.33	113.095	20.53	24	PASS
64	5320	18.80	18.60	148.302	21.71	24	PASS
100	5500	17.10	16.90	100.264	20.01	24	PASS
120	5600	18.14	17.82	125.697	20.99	24	PASS
140	5700	15.60	15.50	71.789	18.56	24	PASS
149	5745	13.29	12.59	39.485	15.96	30	PASS
157	5785	22.34	21.97	328.794	25.17	30	PASS
165	5825	15.88	15.68	75.709	18.79	30	PASS

26dB OCCUPIED BANDWIDTH:

CHANNEL	CHANNEL FREQUENCY (MHz)	26dBc BANDWIDTH (MHz)	
		CHAIN 0	CHAIN 1
36	5180	39.52	33.01
40	5200	34.65	29.13
48	5240	35.22	31.84
52	5260	33.30	32.02
60	5300	30.83	31.00
64	5320	37.04	34.24
100	5500	28.41	23.57
120	5600	36.30	30.22
140	5700	24.78	21.29

Note: For U-NII-2A, U-NII-2C Band output power limitation is determined based on 26dBc bandwidth.



A D T

Power Limit = 11dBm + 10logB < U-NII-2A, U-NII-2C >			
Channel Number	Freq.(MHz)	Min. B(MHz)	Determined Conducted Limit (dBm)
52	5260	32.02	26.05 > 24
60	5300	30.83	25.88 > 24
64	5320	34.24	26.34 > 24
100	5500	23.57	24.72 > 24
120	5600	30.22	25.8 > 24
140	5700	21.29	24.28 > 24

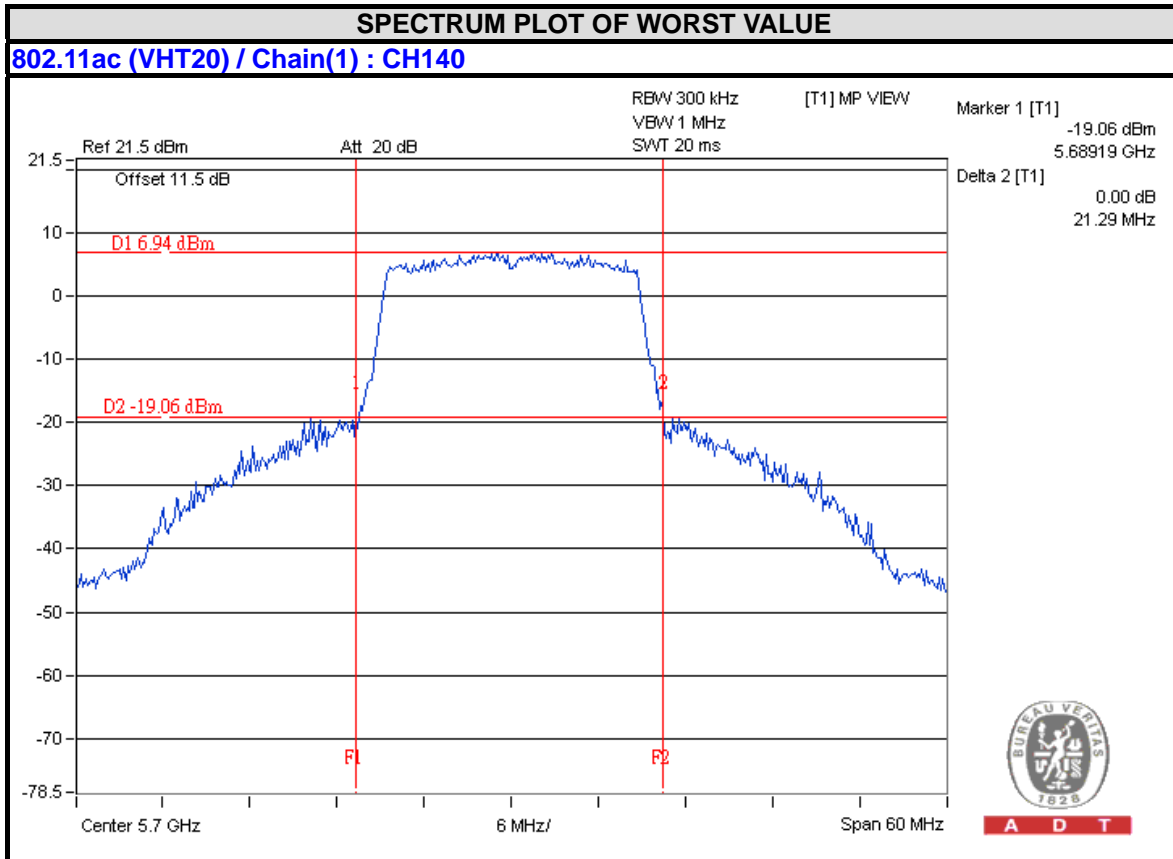



A D T

802.11ac (VHT40)

CHAN.	CHAN. FREQ. (MHz)	AVERAGE POWER (dBm)		TOTAL POWER (mW)	TOTAL POWER (dBm)	POWER LIMIT (dBm)	PASS / FAIL
		CHAIN 0	CHAIN 1				
38	5190	13.57	12.33	39.851	16.00	24	PASS
46	5230	18.04	17.52	120.174	20.80	24	PASS
54	5270	18.07	17.83	124.795	20.96	24	PASS
62	5310	14.98	13.86	55.799	17.47	24	PASS
102	5510	13.04	11.98	35.913	15.55	24	PASS
118	5590	18.26	17.62	124.798	20.96	24	PASS
134	5670	17.08	16.98	100.938	20.04	24	PASS
151	5755	14.45	15.03	59.703	17.76	30	PASS
159	5795	18.76	18.48	145.631	21.63	30	PASS

26dB OCCUPIED BANDWIDTH:

CHANNEL	CHANNEL FREQUENCY (MHz)	26dBc BANDWIDTH (MHz)	
		CHAIN 0	CHAIN 1
38	5190	42.22	41.95
46	5230	75.62	69.29
54	5270	84.44	78.73
62	5310	44.67	42.16
102	5510	42.30	42.07
118	5590	83.07	75.45
134	5670	73.66	74.98

Note: For U-NII-2A, U-NII-2C Band output power limitation is determined based on 26dBc bandwidth.



A D T

Power Limit = 11dBm + 10logB < U-NII-2A, U-NII-2C >			
Channel Number	Freq.(MHz)	Min. B(MHz)	Determined Conducted Limit (dBm)
54	5270	78.73	29.96 > 24
62	5310	42.16	27.24 > 24
102	5510	42.07	27.23 > 24
118	5590	75.45	29.77 > 24
134	5670	73.66	29.67 > 24

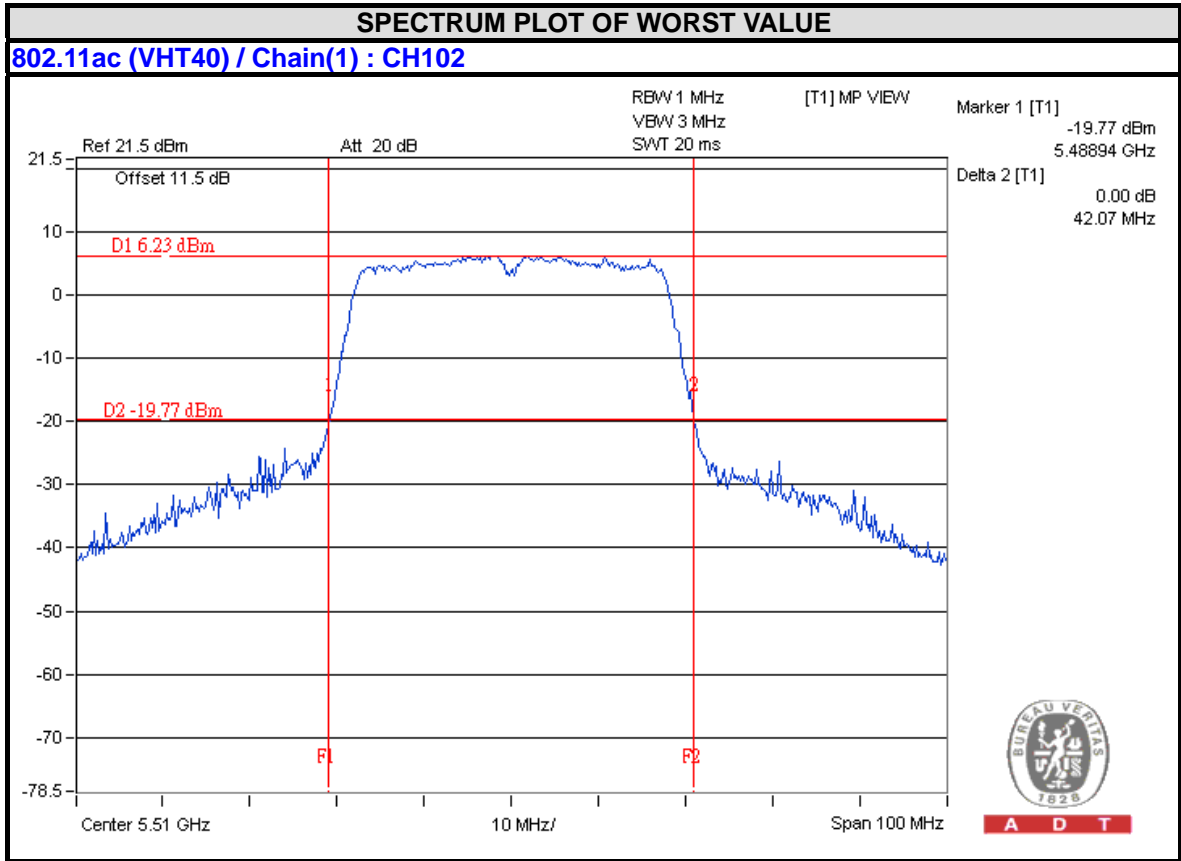



802.11ac (VHT80)

CHAN.	CHAN. FREQ. (MHz)	AVERAGE POWER (dBm)		TOTAL POWER (mW)	TOTAL POWER (dBm)	POWER LIMIT (dBm)	PASS / FAIL
		CHAIN 0	CHAIN 1				
42	5210	11.45	13.21	34.905	15.43	24	PASS
58	5290	12.93	13.03	39.725	15.99	24	PASS
106	5530	11.46	10.68	25.691	14.10	24	PASS
122	5610	19.65	19.46	180.565	22.57	24	PASS
155	5775	12.64	13.47	40.598	16.09	30	PASS

26dB OCCUPIED BANDWIDTH:

CHANNEL	CHANNEL FREQUENCY (MHz)	26dBc BANDWIDTH (MHz)	
		CHAIN 0	CHAIN 1
42	5210	81.14	81.23
58	5290	81.41	81.06
106	5530	85.33	81.43
122	5610	143.12	144.47

Note: For U-NII-2A, U-NII-2C Band output power limitation is determined based on 26dBc bandwidth.

Power Limit = 11dBm + 10logB < U-NII-2A, U-NII-2C >			
Channel Number	Freq.(MHz)	Min. B(MHz)	Determined Conducted Limit (dBm)
58	5290	81.06	30.08 > 24
106	5530	81.43	30.1 > 24
122	5610	143.12	32.55 > 24



A D T

SPECTRUM PLOT OF WORST VALUE

802.11ac (VHT80) / Chain(1) : CH58

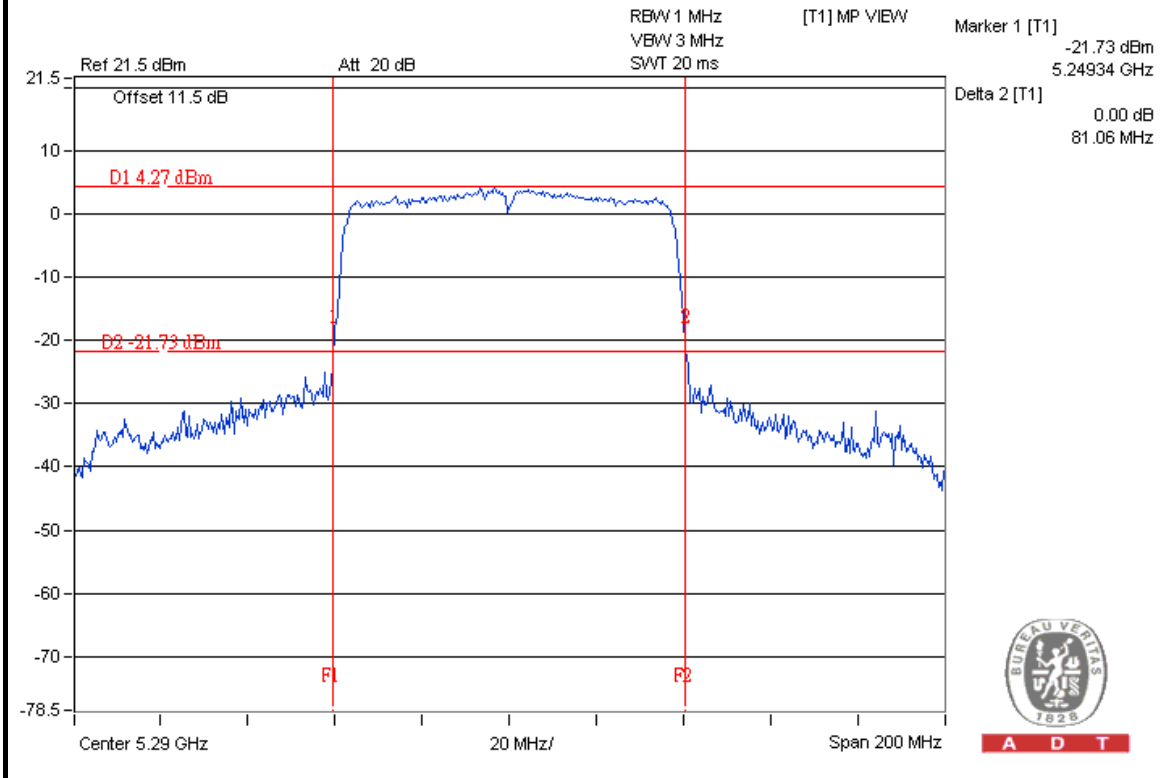

A D T



A D T

4.4 PEAK POWER SPECTRAL DENSITY MEASUREMENT

4.4.1 LIMITS OF PEAK POWER SPECTRAL DENSITY MEASUREMENT

Operation Band	EUT Category		LIMIT
U-NII-1		Outdoor Access Point	17dBm/ MHz
		Fixed point-to-point Access Point	
		Indoor Access Point	
	√	Mobile and Portable client device	11dBm/ MHz
U-NII-2A	---		11dBm/ MHz
U-NII-2C	---		11dBm/ MHz
U-NII-3	---		30dBm/ 500kHz

4.4.2 TEST INSTRUMENTS

DESCRIPTION & MANUFACTURER	MODEL NO.	SERIAL NO.	CALIBRATED DATE	CALIBRATED UNTIL
SPECTRUM ANALYZER R&S	FSV 40	100964	July 15, 2013	July 14, 2014

Note:

1. The calibration interval of the above test instruments is 12 months and the calibrations are traceable to NML/ROC and NIST/USA.
2. Tested date : May 16, 2014



A D T

4.4.3 TEST PROCEDURES

For U-NII-1, U-NII-2A & U-NII-2C:

1. Set span to encompass the entire emission bandwidth (EBW) of the signal.
2. Set RBW = 1 MHz, Set VBW \geq 3 MHz, Detector = RMS
3. Sweep time = auto, trigger set to “free run”.
4. Trace average at least 100 traces in power averaging mode.
5. Record the max value and for duty cycle of test signal is $<$ 98% add 10 log (1/duty cycle)

For U-NII-3:

1. Set span to encompass the entire emission bandwidth (EBW) of the signal.
2. Set RBW = 300 kHz, Set VBW \geq 1 MHz, Detector = RMS
3. Use the peak marker function to determine the maximum power level in any 300 kHz band segment within the fundamental EBW.
4. Scale the observed power level to an equivalent value in 500 kHz by adjusting (reducing) the measured power by a bandwidth correction factor (BWCF) where $BWCF = 10\log(500\text{ kHz}/300\text{ kHz})$
5. Sweep time = auto, trigger set to “free run”.
6. Trace average at least 100 traces in power averaging mode.
7. Record the max value and for duty cycle of test signal is $<$ 98% add 10 log (1/duty cycle)

4.4.4 DEVIATION FROM TEST STANDARD

No deviation

4.4.5 TEST SETUP

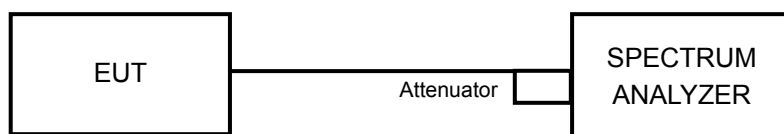

4.4.6 EUT OPERATING CONDITIONS

Same as 4.3.6



A D T

4.4.7 TEST RESULTS

For U-NII-1, U-NII-2A & U-NII-2C:

802.11a

CHANNEL	CHANNEL FREQUENCY (MHz)	PSD (dBm)		TOTAL POWER DENSITY (dBm)	MAX. LIMIT (dBm)	PASS/FAIL
		CHAIN 0	CHAIN 1			
36	5180	4.91	5.02	7.98	10.76	PASS
40	5200	3.09	1.99	5.58	10.76	PASS
48	5240	4.35	4.00	7.19	10.76	PASS
52	5260	4.97	4.50	7.75	10.76	PASS
60	5300	5.78	4.66	8.27	10.76	PASS
64	5320	4.84	5.30	8.09	10.76	PASS
100	5500	5.77	5.70	8.75	11	PASS
120	5600	4.77	4.94	7.87	11	PASS
140	5700	3.13	3.46	6.31	11	PASS

NOTE: 1. Method a) of power density measurement of KDB 662911 is using for calculating total power density. Total power density is summing entire spectra across corresponding frequency bins on the various outputs by computer.

2. **5150~5250MHz:** Directional gain = $10 \log[(10^{G1/20} + 10^{G2/20})^2 / 2]$ = 6.24dBi > 6dBi , so the power density limit shall be reduced to $11-(6.24-6) = 10.76$ dBm.

5250~5350MHz: Directional gain = $10 \log[(10^{G1/20} + 10^{G2/20})^2 / 2]$ = 6.24dBi > 6dBi , so the power density limit shall be reduced to $11-(6.24-6) = 10.76$ dBm.

5470~5725MHz: Directional gain = 5.94 dBi + $10 \log(2)$ = 5.94 dBi < 6dBi , so the power density limit shall not be reduced.



802.11ac (VHT20)

CHANNEL	CHANNEL FREQUENCY (MHz)	PSD (dBm)		TOTAL POWER DENSITY (dBm)	MAX. LIMIT (dBm)	PASS/FAIL
		CHAIN 0	CHAIN 1			
36	5180	5.84	4.35	8.17	10.76	PASS
40	5200	5.04	3.88	7.51	10.76	PASS
48	5240	5.21	4.72	7.98	10.76	PASS
52	5260	4.38	4.05	7.23	10.76	PASS
60	5300	4.50	4.11	7.32	10.76	PASS
64	5320	5.73	5.27	8.52	10.76	PASS
100	5500	3.71	3.42	6.58	11	PASS
120	5600	4.27	4.04	7.17	11	PASS
140	5700	2.40	2.27	5.35	11	PASS

NOTE: 1. Method a) of power density measurement of KDB 662911 is using for calculating total power density. Total power density is summing entire spectra across corresponding frequency bins on the various outputs by computer.

2. **5150~5250MHz:** Directional gain = $10 \log[(10^{G1/20} + 10^{G2/20})^2 / 2] = 6.24\text{dBi} > 6\text{dBi}$, so the power density limit shall be reduced to $11-(6.24-6) = 10.76\text{dBm}$.

5250~5350MHz: Directional gain = $10 \log[(10^{G1/20} + 10^{G2/20})^2 / 2] = 6.24\text{dBi} > 6\text{dBi}$, so the power density limit shall be reduced to $11-(6.24-6) = 10.76\text{dBm}$.

5470~5725MHz: Directional gain = $5.94\text{dBi} + 10\log(2) = 5.94\text{dBi} < 6\text{dBi}$, so the power density limit shall not be reduced.



A D T

802.11ac (VHT40)

CHANNEL	CHANNEL FREQUENCY (MHz)	PSD (dBm)		TOTAL POWER DENSITY (dBm)	MAX. LIMIT (dBm)	PASS/FAIL
		CHAIN 0	CHAIN 1			
38	5190	-3.06	-4.09	-0.53	10.76	PASS
46	5230	1.36	0.90	4.15	10.76	PASS
54	5270	1.36	1.23	4.31	10.76	PASS
62	5310	-1.53	-2.74	0.92	10.76	PASS
102	5510	-3.25	-4.30	-0.73	11	PASS
118	5590	1.91	1.74	4.84	11	PASS
134	5670	0.68	0.59	3.65	11	PASS

NOTE: 1. Method a) of power density measurement of KDB 662911 is using for calculating total power density. Total power density is summing entire spectra across corresponding frequency bins on the various outputs by computer.

2. **5150~5250MHz:** Directional gain = $10 \log[(10^{G1/20} + 10^{G2/20})^2 / 2]$ = 6.24dBi > 6dBi , so the power density limit shall be reduced to $11-(6.24-6) = 10.76\text{dBm}$.

5250~5350MHz: Directional gain = $10 \log[(10^{G1/20} + 10^{G2/20})^2 / 2]$ = 6.24dBi > 6dBi , so the power density limit shall be reduced to $11-(6.24-6) = 10.76\text{dBm}$.

5470~5725MHz: Directional gain = $5.94\text{dBi} + 10\log(2) = 5.94\text{dBi} < 6\text{dBi}$, so the power density limit shall not be reduced.



802.11ac (VHT80)

CHANNEL	CHANNEL FREQUENCY (MHz)	PSD W/O DUTY FACTOR (dBm)		DUTY FACTOR (dB)	TOTAL PSD WITH DUTY FACTOR (dBm)	MAX. LIMIT (dBm)	PASS / FAIL
		CHAIN 0	CHAIN 1				
42	5210	-7.76	-6.64	0.1	-4.05	10.76	PASS
58	5290	-6.65	-6.47	0.1	-3.45	10.76	PASS
106	5530	-7.31	-8.28	0.1	-4.66	11	PASS
122	5610	-0.05	-0.22	0.1	2.98	11	PASS

NOTE: 1. Method a) of power density measurement of KDB 662911 is using for calculating total power density. Total power density is summing entire spectra across corresponding frequency bins on the various outputs by computer.

2. **5150~5250MHz:** Directional gain = $10 \log[(10^{G1/20} + 10^{G2/20})^2 / 2]$ = 6.24dBi > 6dBi , so the power density limit shall be reduced to $11-(6.24-6) = 10.76$ dBm.

5250~5350MHz: Directional gain = $10 \log[(10^{G1/20} + 10^{G2/20})^2 / 2]$ = 6.24dBi > 6dBi , so the power density limit shall be reduced to $11-(6.24-6) = 10.76$ dBm.

5470~5725MHz: Directional gain = 5.94 dBi + $10 \log(2)$ = 5.94 dBi < 6dBi , so the power density limit shall not be reduced.

3. Refer to section 3.4 for duty cycle spectrum plot.

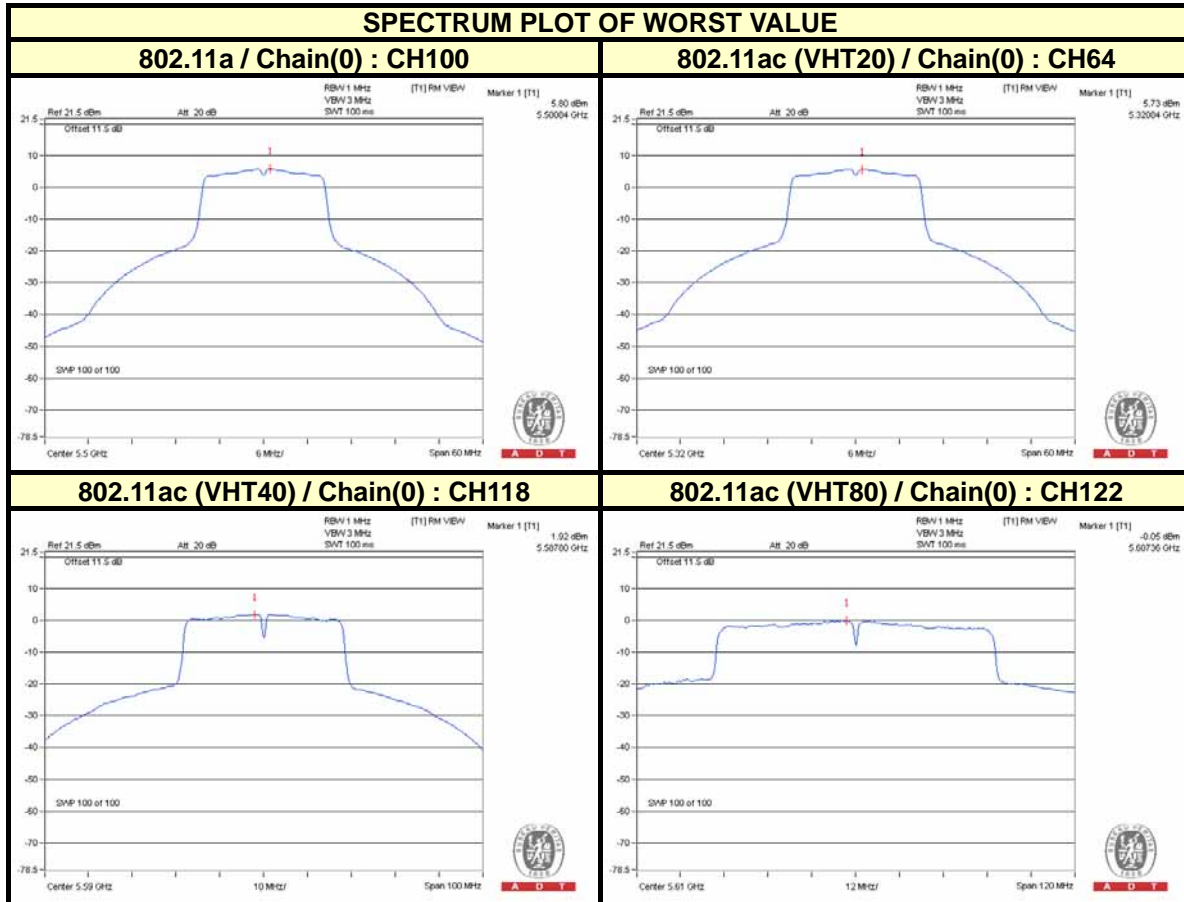



For U-NII-3:

802.11a

TX CHAIN	CHANNEL	FREQUENCY (MHz)	PSD (dBm/300kHz)	PSD (dBm/500kHz)	10 log (N=2) dB	TOTAL PSD (dBm/500kHz)	LIMIT (dBm/500kHz)	PASS /FAIL
0	149	5745	-4.72	-2.50	3.01	0.51	29.67	PASS
	157	5785	-0.14	2.08	3.01	5.09	29.67	PASS
	165	5825	-4.11	-1.89	3.01	1.12	29.67	PASS
1	149	5745	-6.77	-4.55	3.01	-1.54	29.67	PASS
	157	5785	-0.20	2.02	3.01	5.03	29.67	PASS
	165	5825	-4.67	-2.45	3.01	0.56	29.67	PASS

NOTE: 1. 5725~5825MHz: Directional gain = $10 \log[(10^{G1/20} + 10^{G2/20})^2 / 2]$ = 6.33dBi > 6dBi , so the power density limit shall be reduced to 30-(6.33-6) = 29.67dBm.

802.11ac (VHT20)

TX CHAIN	CHANNEL	FREQUENCY (MHz)	PSD (dBm/300kHz)	PSD (dBm/500kHz)	10 log (N=2) dB	TOTAL PSD (dBm/500kHz)	LIMIT (dBm/500kHz)	PASS /FAIL
0	149	5745	-7.36	-5.14	3.01	-2.13	29.67	PASS
	157	5785	0.08	2.30	3.01	5.31	29.67	PASS
	165	5825	-5.01	-2.79	3.01	0.22	29.67	PASS
1	149	5745	-6.88	-4.66	3.01	-1.65	29.67	PASS
	157	5785	-0.09	2.13	3.01	5.14	29.67	PASS
	165	5825	-5.28	-3.06	3.01	-0.05	29.67	PASS

NOTE: 1. 5725~5825MHz: Directional gain = $10 \log[(10^{G1/20} + 10^{G2/20})^2 / 2]$ = 6.33dBi > 6dBi , so the power density limit shall be reduced to 30-(6.33-6) = 29.67dBm.

802.11ac (VHT40)

TX CHAIN	CHANNEL	FREQUENCY (MHz)	PSD (dBm/300kHz)	PSD (dBm/500kHz)	10 log (N=2) dB	TOTAL PSD (dBm/500kHz)	LIMIT (dBm/500kHz)	PASS /FAIL
0	151	5755	-9.84	-7.62	3.01	-4.61	30	PASS
	159	5795	-5.89	-3.67	3.01	-0.66	30	PASS
1	151	5755	-9.76	-7.54	3.01	-4.53	30	PASS
	159	5795	-6.21	-3.99	3.01	-0.98	30	PASS

NOTE: 1. 5725~5825MHz: Directional gain = $10 \log[(10^{G1/20} + 10^{G2/20})^2 / 2]$ = 6.33dBi > 6dBi , so the power density limit shall be reduced to 30-(6.33-6) = 29.67dBm.



A D T

802.11ac (VHT80)

TX CHAIN	CHANNEL	FREQUENCY (MHz)	PSD W/O DUTY FACTOR		10 log (N=2) dB	DUTY FACTOR (dB)	TOTAL PSD WITH DUTY FACTOR (dBm/500kHz)	LIMIT (dBm/500kHz)	PASS /FAIL
			(dBm/300kHz)	(dBm/500kHz)					
0	155	5775	-14.67	-12.45	3.01	0.1	-9.34	29.67	PASS
1	155	5775	-14.26	-12.04	3.01	0.1	-8.93	29.67	PASS

NOTE: 1. 5725~5825MHz: Directional gain = $10 \log[(10^{G1/20} + 10^{G2/20})^2 / 2]$ = 6.33dBi > 6dBi , so the power density limit shall be reduced to $30-(6.33-6) = 29.67$ dBm.

2. Refer to section 3.4 for duty cycle spectrum plot.

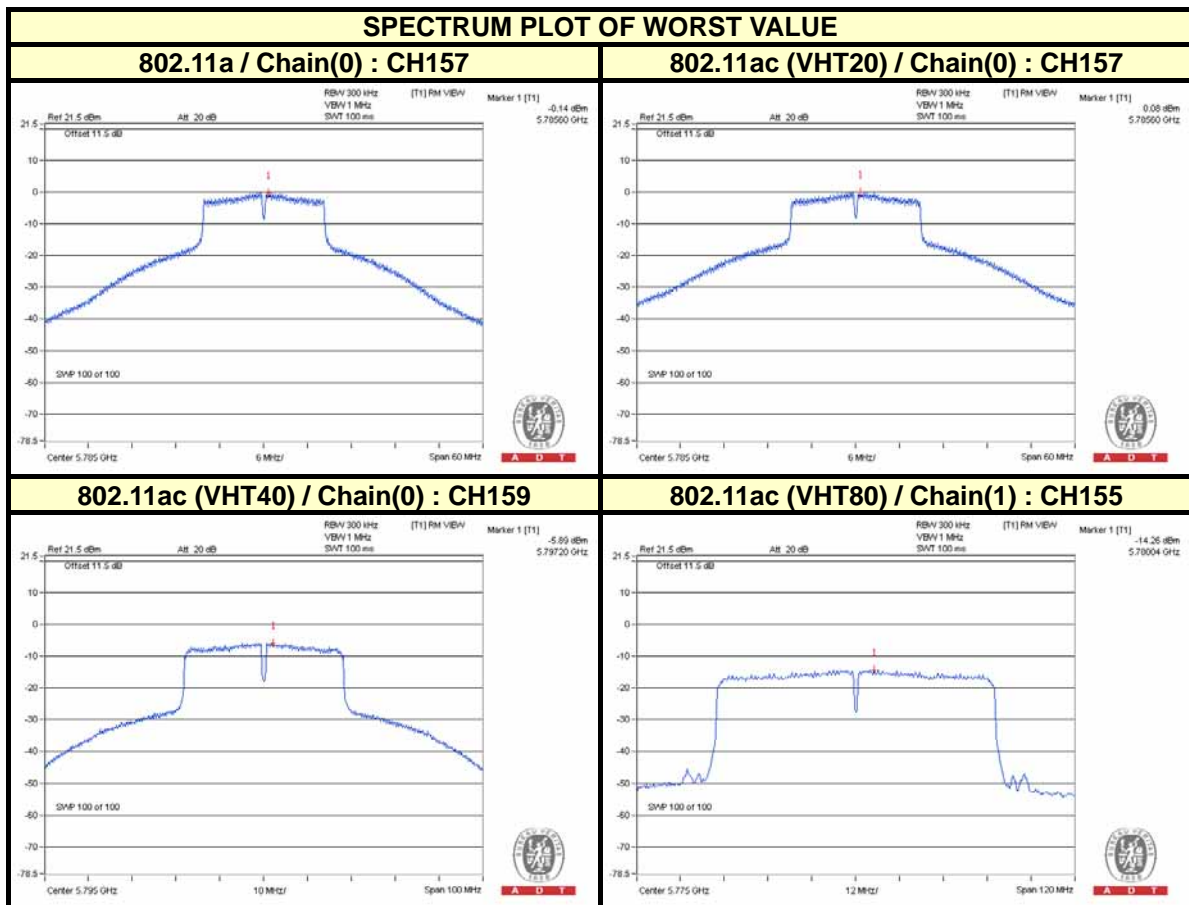



A D T

4.5 FREQUENCY STABILITY

4.5.1 LIMITS OF FREQUENCY STABILITY MEASUREMENT

The frequency of the carrier signal shall be maintained within band of operation

4.5.2 TEST INSTRUMENTS

DESCRIPTION & MANUFACTURER	MODEL NO.	SERIAL NO.	CALIBRATED DATE	CALIBRATED UNTIL
SPECTRUM ANALYZER R&S	FSV 40	100964	July 15, 2013	July 14, 2014
Temperature Humidity Chamber & GIANTFORCE	GTH-150-40-SP -AR	MAA0812-008	Jan. 13, 2014	Jan. 12, 2015

Note:

1. The calibration interval of the above test instruments is 12 months and the calibrations are traceable to NML/ROC and NIST/USA.
2. Tested date : May 16, 2014

4.5.3 TEST PROCEDURE

1. The EUT was placed inside the environmental test chamber and powered by nominal DC voltage.
2. Turn the EUT on and couple its output to a spectrum analyzer.
3. Turn the EUT off and set the chamber to the highest temperature specified.
4. Allow sufficient time (approximately 30 min) for the temperature of the chamber to stabilize, turn the EUT on and measure the operating frequency after 2, 5, and 10 minutes.
5. Repeat step 2 and 3 with the temperature chamber set to the lowest temperature.
6. The test chamber was allowed to stabilize at +20 degree C for a minimum of 30 minutes. The supply voltage was then adjusted on the EUT from 85% to 115% and the frequency record.

4.5.4 DEVIATION FROM TEST STANDARD

No deviation

4.5.5 TEST SETUP

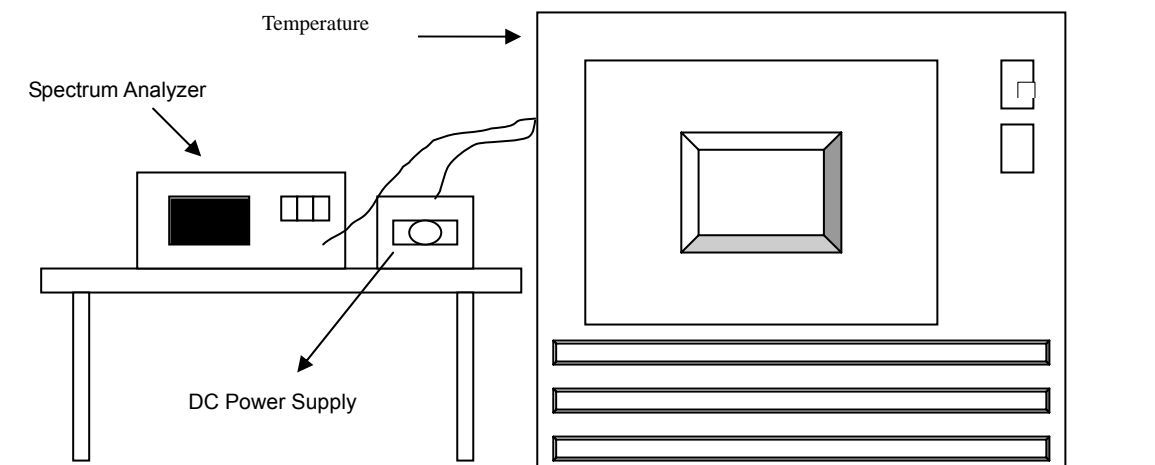

4.5.6 EUT OPERATING CONDITION

Set the EUT transmit at un-modulation mode to test frequency stability.



A D T

4.5.7 TEST RESULTS

FREQUENCY STABILITY VERSUS TEMP.									
OPERATING FREQUENCY: 5320MHz									
TEMP. (°C)	POWER SUPPLY (Vdc)	0 MINUTE		2 MINUTE		5 MINUTE		10 MINUTE	
		Measured Frequency	Frequency Drift	Measured Frequency	Frequency Drift	Measured Frequency	Frequency Drift	Measured Frequency	Frequency Drift
		(MHz)	%	(MHz)	%	(MHz)	%	(MHz)	%
50	3.3	5320.0149	0.00028	5320.0145	0.00027	5320.015	0.00028	5320.0142	0.00027
40	3.3	5320.0156	0.00029	5320.0185	0.00035	5320.0167	0.00031	5320.0171	0.00032
30	3.3	5320.0001	0.00000	5320.0018	0.00003	5319.998	-0.00004	5320.0009	0.00002
20	3.3	5319.9984	-0.00003	5319.9941	-0.00011	5319.9935	-0.00012	5319.9958	-0.00008
10	3.3	5320.0033	0.00006	5320.0076	0.00014	5320.0074	0.00014	5320.0053	0.00010
0	3.3	5319.9774	-0.00042	5319.974	-0.00049	5319.9773	-0.00043	5319.9772	-0.00043
-10	3.3	5319.9998	0.00000	5320.0027	0.00005	5320.0029	0.00005	5320.0031	0.00006
-20	3.3	5320.0171	0.00032	5320.0175	0.00033	5320.017	0.00032	5320.0188	0.00035
-30	3.3	5319.9797	-0.00038	5319.9816	-0.00035	5319.9778	-0.00042	5319.9815	-0.00035

FREQUENCY STABILITY VERSUS VOLTAGE									
OPERATING FREQUENCY: 5320MHz									
TEMP. (°C)	POWER SUPPLY (Vdc)	0 MINUTE		2 MINUTE		5 MINUTE		10 MINUTE	
		Measured Frequency	Frequency Drift	Measured Frequency	Frequency Drift	Measured Frequency	Frequency Drift	Measured Frequency	Frequency Drift
		(MHz)	%	(MHz)	%	(MHz)	%	(MHz)	%
20	3.795	5319.9993	-0.00001	5319.9935	-0.00012	5319.9937	-0.00012	5319.9957	-0.00008
	3.3	5319.9984	-0.00003	5319.9941	-0.00011	5319.9935	-0.00012	5319.9958	-0.00008
	2.805	5319.9976	-0.00005	5319.9943	-0.00011	5319.9927	-0.00014	5319.996	-0.00008

4.6 6dB BANDWIDTH MEASUREMENT

4.6.1 LIMITS OF 6dB BANDWIDTH MEASUREMENT

The minimum of 6dB Bandwidth Measurement is 0.5 MHz.

4.6.2 TEST INSTRUMENTS

DESCRIPTION & MANUFACTURER	MODEL NO.	SERIAL NO.	CALIBRATED DATE	CALIBRATED UNTIL
SPECTRUM ANALYZER R&S	FSV 40	100964	July 15, 2013	July 14, 2014

Note:

1. The calibration interval of the above test instruments is 12 months and the calibrations are traceable to NML/ROC and NIST/USA.
2. Tested date : May 16, 2014

4.6.3 TEST PROCEDURE

1. Set resolution bandwidth (RBW) = 100kHz.
2. Set the video bandwidth (VBW) ≥ 3 x RBW, Detector = Peak.
3. Trace mode = max hold.
4. Sweep = auto couple.
5. Measure the maximum width of the emission that is constrained by the frequencies associated with the two amplitude points (upper and lower) that are attenuated by 6 dB relative to the maximum level measured in the fundamental emission

4.6.4 DEVIATION FROM TEST STANDARD

No deviation

4.6.5 TEST SETUP

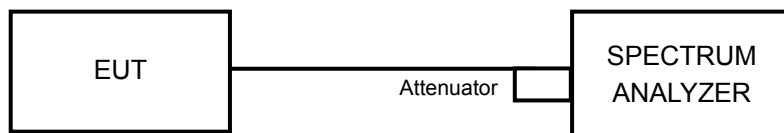

4.6.6 EUT OPERATING CONDITIONS

The software provided by client to enable the EUT under transmission condition continuously at lowest, middle and highest channel frequencies individually.



A D T

4.6.7 TEST RESULTS

802.11a

CHANNEL	CHANNEL FREQUENCY (MHz)	6dB BANDWIDTH (MHz)		MINIMUM LIMIT (MHz)	PASS / FAIL
		CHAIN 0	CHAIN 1		
149	5745	16.32	16.36	0.5	PASS
157	5785	16.43	16.39	0.5	PASS
165	5825	16.34	16.33	0.5	PASS

802.11ac (VHT20)

CHANNEL	CHANNEL FREQUENCY (MHz)	6dB BANDWIDTH (MHz)		MINIMUM LIMIT (MHz)	PASS / FAIL
		CHAIN 0	CHAIN 1		
149	5745	16.94	17.09	0.5	PASS
157	5785	17.62	17.59	0.5	PASS
165	5825	16.98	17.09	0.5	PASS

802.11ac (VHT40)

CHANNEL	CHANNEL FREQUENCY (MHz)	6dB BANDWIDTH (MHz)		MINIMUM LIMIT (MHz)	PASS / FAIL
		CHAIN 0	CHAIN 1		
151	5755	35.34	35.34	0.5	PASS
159	5795	35.28	35.30	0.5	PASS

802.11ac (VHT80)

CHANNEL	CHANNEL FREQUENCY (MHz)	6dB BANDWIDTH (MHz)		MINIMUM LIMIT (MHz)	PASS / FAIL
		CHAIN 0	CHAIN 1		
155	5775	75.34	75.36	0.5	PASS



A D T

SPECTRUM PLOT OF WORST VALUE

802.11a / Chain(0) : CH149

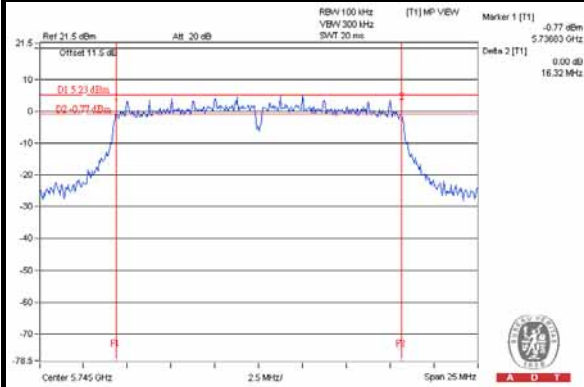

802.11ac (VHT20) / Chain(0) : CH149

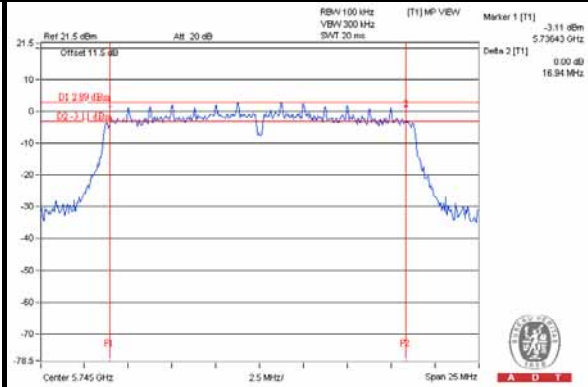

802.11ac (VHT40) / Chain(0) : CH159

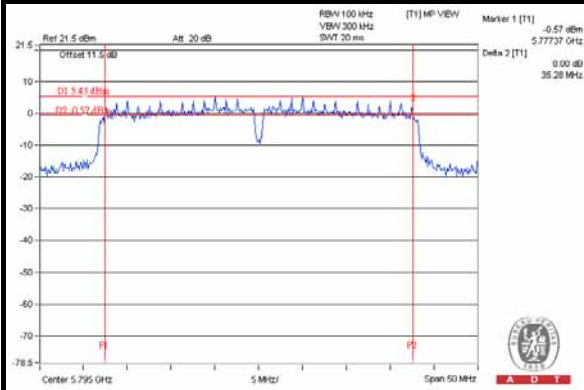

802.11ac (VHT80) / Chain(0) : CH155

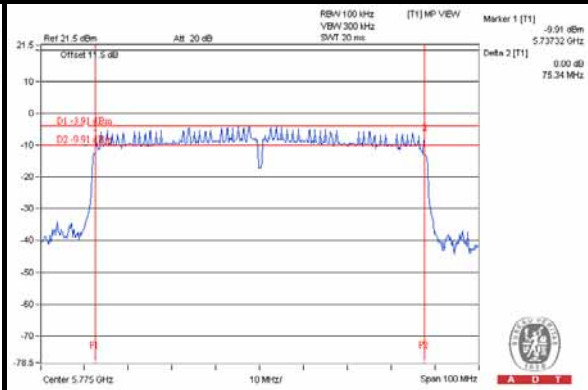



5. PHOTOGRAPHS OF THE TEST CONFIGURATION

Please refer to the attached file (Test Setup Photo).



A D T

6. INFORMATION ON THE TESTING LABORATORIES

We, Bureau Veritas Consumer Products Services (H.K.) Ltd., Taoyuan Branch, were founded in 1988 to provide our best service in EMC, Radio, Telecom and Safety consultation. Our laboratories are accredited and approved according to ISO/IEC 17025.

If you have any comments, please feel free to contact us at the following:

Linko EMC/RF Lab:

Tel: 886-2-26052180

Fax: 886-2-26052943

Hsin Chu EMC/RF Lab:

Tel: 886-3-5935343

Fax: 886-3-5935342

Hwa Ya EMC/RF/Safety/Telecom Lab:

Tel: 886-3-3183232

Fax: 886-3-3270892

Email: service.adt@tw.bureauveritas.com

Web Site: www.bureauveritas-adt.com

The address and road map of all our labs can be found in our web site also.



A D T

7. APPENDIX A - MODIFICATIONS RECORDERS FOR ENGINEERING CHANGES TO THE EUT BY THE LAB

No modifications were made to the EUT by the lab during the test.

--- END ---