



# DFS TEST REPORT (Slave Mode)

**REPORT NO.:** RF140515E03-3

**MODEL NO.:** J20H084ac, J20H084

**FCC ID:** AK8J20H084AC

**RECEIVED:** May 15, 2014

**TESTED:** July 15, 2014

**ISSUED:** July 29, 2014

**APPLICANT:** Sony Corporation

**ADDRESS:** 1-7-1 Konan Minato-ku Tokyo, 108-0075  
Japan

**ISSUED BY:** Bureau Veritas Consumer Products Services  
(H.K.) Ltd., Taoyuan Branch Hsin Chu Laboratory

**LAB ADDRESS :** No. 81-1, Lu Liao Keng, 9th Ling, Wu Lung Tsuen,  
Chiung Lin Hsiang, Hsin Chu Hsien 307, Taiwan,  
R.O.C.

This report should not be used by the client to claim product certification, approval, or endorsement by TAF or any government agencies.



This report is for your exclusive use. Any copying or replication of this report to or for any other person or entity, or use of our name or trademark, is permitted only with our prior written permission. This report sets forth our findings solely with respect to the test samples identified herein. The results set forth in this report are not indicative or representative of the quality or characteristics of the lot from which a test sample was taken or any similar or identical product unless specifically and expressly noted. Our report includes all of the tests requested by you and the results thereof based upon the information that you provided to us. You have 60 days from date of issuance of this report to notify us of any material error or omission caused by our negligence, provided, however, that such notice shall be in writing and shall specifically address the issue you wish to raise. A failure to raise such issue within the prescribed time shall constitute your unqualified acceptance of the completeness of this report, the tests conducted and the correctness of the report contents. Unless specific mention, the uncertainty of measurement has been explicitly taken into account to declare the compliance or non-compliance to the specification



# Table of Contents

RELEASE CONTROL RECORD.....	3
1. CERTIFICATION .....	4
2. EUT INFORMATION.....	5
2.1 OPERATING FREQUENCY BANDS AND MODE OF EUT .....	5
2.2 EUT SOFTWARE AND FIRMWARE VERSION .....	5
2.3 DESCRIPTION OF AVAILABLE ANTENNAS TO THE EUT .....	5
2.4 EUT MAXIMUM CONDUCTED POWER.....	6
2.5 EUT MAXIMUM EIRP POWER .....	7
2.6 TRANSMIT POWER CONTROL (TPC).....	8
2.7 STATEMENT OF MAUNFACTURER .....	8
3. U-NII DFS RULE REQUIREMENTS .....	9
3.1 WORKING MODES AND REQUIRED TEST ITEMS .....	9
3.2 TEST LIMITS AND RADAR SIGNAL PARAMETERS .....	10
4. TEST & SUPPORT EQUIPMENT LIST .....	14
4.1 TEST INSTRUMENTS .....	14
4.2 DESCRIPTION OF SUPPORT UNITS .....	14
5. TEST PROCEDURE .....	15
5.1 BVADT DFS MEASUREMENT SYSTEM:.....	15
5.2 CALIBRATION OF DFS DETECTION THRESHOLD LEVEL:.....	16
5.3 DEVIATION FROM TEST STANDARD .....	17
5.4 CONDUCTED TEST SETUP CONFIGURATION.....	17
5.4.1 CLIENT WITHOUT RADAR DETECTION MODE.....	17
6. TEST RESULTS .....	18
6.1 SUMMARY OF TEST RESULTS .....	18
6.2 DETAILED TEST RESULTS.....	19
6.2.1 TEST MODE: DEVICE OPERATING IN CLIENT WITHOUT RADAR DETECTION MODE.....	19
6.2.1.1 DFS DETECTION THRESHOLD .....	19
6.2.1.2 CHANNEL CLOSING TRANSMISSION AND CHANNEL MOVE TIME.....	20
6.2.1.3 NON- OCCUPANCY PERIOD .....	21
6.2.1.4 NON-ASSOCIATED TEST .....	23
6.2.1.5 NON- CO-CHANNEL TEST.....	23
7. INFORMATION ON THE TESTING LABORATORIES .....	24
8. APPENDIX-A.....	25
9. APPENDIX B - MODIFICATIONS RECORDERS FOR ENGINEERING CHANGES TO THE EUT BY THE LAB.....	27



A D T

## RELEASE CONTROL RECORD

ISSUE NO.	REASON FOR CHANGE	DATE ISSUED
RF140515E03-3	Original release	July 29, 2014



A D T

## 1. CERTIFICATION

**PRODUCT:** WLAN Module  
**BRAND NAME :** FOXCONN  
**MODEL NO.:** J20H084ac, J20H084  
**TEST SAMPLE:** ENGINEERING SAMPLE  
**APPLICANT:** Sony Corporation  
**TESTED:** July 15, 2014  
**STANDARDS:** FCC Part 15, Subpart E (Section 15.407)  
FCC KDB 905462 D02

The above equipment (Model: J20H084ac) has been tested by **Bureau Veritas Consumer Products Services (H.K.) Ltd., Taoyuan Branch**, and was in compliance with the requirement of the above standards. The test record, data evaluation & Equipment Under Test (EUT) configurations represented herein are true and accurate accounts of the measurements of the sample's EMC characteristics under the conditions specified in this report.

**PREPARED BY :** Phoenix Huang , **DATE:** July 29, 2014  
( Phoenix Huang, Specialist )

**APPROVED BY :** May Chen , **DATE:** July 29, 2014  
( May Chen, Manager )



## 2. EUT INFORMATION

### 2.1 OPERATING FREQUENCY BANDS AND MODE OF EUT

TABLE 1: OPERATING FREQUENCY BANDS AND MODE OF EUT

OPERATIONAL MODE	OPERATING FREQUENCY RANGE	
	5250~5350MHz	5470~5725MHz
Client without radar detection and ad hoc function	✓	✓

### 2.2 EUT SOFTWARE AND FIRMWARE VERSION

TABLE 2: THE EUT SOFTWARE/FIRMWARE VERSION

PLATFORM	NO.	PRODUCT	MODEL NO.	SOFTWARE/FIRMWARE VERSION
Linux	1	WLAN Module	J20H084ac	4.2.1.29 Jul 11 2014 22:20:33

### 2.3 DESCRIPTION OF AVAILABLE ANTENNAS TO THE EUT

TABLE 3: ANTENNA LIST

For WLAN								
Antenna No.	Transmitter Circuit	Brand	Model	Antenna Gain(dBi) < including cable loss>	Frequency range (GHz)	Antenna Type	Connector Type	Cable Length
1	Chain (0)	Foxconn WiFi	J20H084	2.81	2.4	PCB printing	NA	NA
				3.05	2.45			
				3.40	2.5			
				3.50	5.15			
				3.28	5.45			
3.79	5.85							
2	Chain (1)	Foxconn WiFi	J20H084	2.93	2.4	PCB printing	NA	NA
				2.91	2.45			
				2.76	2.5			
				2.96	5.15			
				2.57	5.45			
2.82	5.85							



## 2.4 EUT MAXIMUM CONDUCTED POWER

**TABLE 4: THE MEASURED CONDUCTED OUTPUT POWER**

### IEEE 802.11a

Ant. No.	FREQUENCY BAND (MHz)	MAX. POWER	
		OUTPUT POWER(dBm)	OUTPUT POWER(mW)
1	5250~5350	21.41	138.222
1	5470~5725	21.51	141.739

### IEEE 802.11ac (VHT20)

Ant. No.	FREQUENCY BAND (MHz)	MAX. POWER	
		OUTPUT POWER(dBm)	OUTPUT POWER(mW)
1	5250~5350	21.71	148.302
1	5470~5725	20.99	125.699

### IEEE 802.11ac (VHT40)

Ant. No.	FREQUENCY BAND (MHz)	MAX. POWER	
		OUTPUT POWER(dBm)	OUTPUT POWER(mW)
1	5250~5350	20.96	124.795
1	5470~5725	20.96	124.798

### IEEE 802.11ac (VHT80)

Ant. No.	FREQUENCY BAND (MHz)	MAX. POWER	
		OUTPUT POWER(dBm)	OUTPUT POWER(mW)
1	5250~5350	15.99	39.725
1	5470~5725	22.57	180.585



A D T

## 2.5 EUT MAXIMUM EIRP POWER

TABLE 5: THE EIRP OUTPUT POWER LIST

### IEEE 802.11a

Ant. No.	FREQUENCY BAND (MHz)	MAX. POWER	
		OUTPUT POWER(dBm)	OUTPUT POWER(mW)
1	5250~5350	24.91	309.441
1	5470~5725	24.79	301.640

### IEEE 802.11ac (VHT20)

Ant. No.	FREQUENCY BAND (MHz)	MAX. POWER	
		OUTPUT POWER(dBm)	OUTPUT POWER(mW)
1	5250~5350	25.21	332.007
1	5470~5725	24.27	267.501

### IEEE 802.11ac (VHT40)

Ant. No.	FREQUENCY BAND (MHz)	MAX. POWER	
		OUTPUT POWER(dBm)	OUTPUT POWER(mW)
1	5250~5350	24.46	279.381
1	5470~5725	24.24	265.587

### IEEE 802.11ac (VHT80)

Ant. No.	FREQUENCY BAND (MHz)	MAX. POWER	
		OUTPUT POWER(dBm)	OUTPUT POWER(mW)
1	5250~5350	19.49	88.933
1	5470~5725	25.85	384.267



A D T

## 2.6 TRANSMIT POWER CONTROL (TPC)

U-NII devices operating in the 5.25-5.35 GHz band and the 5.47-5.725 GHz band shall employ a TPC mechanism. The U-NII device is required to have the capability to operate at least 6 dB below the mean EIRP value of 30 dBm. A TPC mechanism is not required for systems with an EIRP of less than 500 mW.

Maximum EIRP of this device is 384.267mW which less than 500mW, therefore it's not require TPC function.

## 2.7 STATEMENT OF MAUNFACTURER

This device (Client) is without radar detection, then the manufacturer statement confirming that information regarding the parameters of the detected Radar Waveforms is not available to the end user. **And the device doesn't have Ad Hoc mode on DFS frequency band.**



### 3. U-NII DFS RULE REQUIREMENTS

#### 3.1 WORKING MODES AND REQUIRED TEST ITEMS

The manufacturer shall state whether the UUT is capable of operating as a Master and/or a Client. If the UUT is capable of operating in more than one operating mode then each operating mode shall be tested separately. See tables 6 and 7 for the applicability of DFS requirements for each of the operational modes.

**TABLE 6: APPLICABILITY OF DFS REQUIREMENTS PRIOR TO USE A CHANNEL**

Requirement	Operational Mode		
	Master	Client without radar detection	Client with radar detection
Non-Occupancy Period	✓	Not required	✓
DFS Detection Threshold	✓	Not required	✓
Channel Availability Check Time	✓	Not required	Not required
U-NII Detection Bandwidth	✓	Not required	✓

**TABLE 7: APPLICABILITY OF DFS REQUIREMENTS DURING NORMAL OPERATION**

Requirement	Operational Mode	
	Master or Client with radar detection	Client without radar detection
DFS Detection Threshold	✓	Not required
Channel Closing Transmission Time	✓	✓
Channel Move Time	✓	✓
U-NII Detection Bandwidth	✓	Not required

Additional requirements for devices with multiple bandwidth modes	Master or Client with radar detection	Client without radar detection
U-NII Detection Bandwidth and Statistical Performance Check	All BW modes must be tested	Not required
Channel Move Time and Channel Closing Transmission Time	Test using widest BW mode available	Test using the widest BW mode available for the link
All other tests	Any single BW mode	Not required
<b>Note:</b> Frequencies selected for statistical performance check (Section 7.8.4) should include several frequencies within the radar detection bandwidth and frequencies near the edge of the radar detection bandwidth. For 802.11 devices it is suggested to select frequencies in all 20 MHz channel blocks and a null frequencies between the bonded 20 MHz channel blocks.		



A D T

### 3.2 TEST LIMITS AND RADAR SIGNAL PARAMETERS

#### DETECTION THRESHOLD VALUES

**TABLE 8: DFS DETECTION THRESHOLDS FOR MASTER DEVICES AND CLIENT DEVICES WITH RADAR DETECTION**

Maximum Transmit Power	Value (See Notes 1, 2, and 3)
EIRP $\geq$ 200 milliwatt	-64 dBm
EIRP $<$ 200 milliwatt and power spectral density $<$ 10 dBm/MHz	-62 dBm
EIRP $<$ 200 milliwatt that do not meet the power spectral density requirement	-64 dBm

**Note 1:** This is the level at the input of the receiver assuming a 0 dBi receive antenna.

**Note 2:** Throughout these test procedures an additional 1 dB has been added to the amplitude of the test transmission waveforms to account for variations in measurement equipment. This will ensure that the test signal is at or above the detection threshold level to trigger a DFS response.

**Note 3:** EIRP is based on the highest antenna gain. For MIMO devices refer to KDB Publication 662911 D01.



A D T

**TABLE 9: DFS RESPONSE REQUIREMENT VALUES**

Parameter	Value
Non-occupancy period	Minimum 30 minutes
Channel Availability Check Time	60 seconds
Channel Move Time	10 seconds See Note 1.
Channel Closing Transmission Time	200 milliseconds + an aggregate of 60 milliseconds over remaining 10 second period. See Notes 1 and 2.
U-NII Detection Bandwidth	Minimum 100% of the U-NII 99% transmission power bandwidth. See Note 3

**Note 1:** Channel Move Time and the Channel Closing Transmission Time should be performed with Radar Type 0. The measurement timing begins at the end of the Radar Type 0 burst.

**Note 2:** The Channel Closing Transmission Time is comprised of 200 milliseconds starting at the beginning of the Channel Move Time plus any additional intermittent control signals required to facilitate a Channel move (an aggregate of 60 milliseconds) during the remainder of the 10 second period. The aggregate duration of control signals will not count quiet periods in between transmissions.

**Note 3:** During the U-NII Detection Bandwidth detection test, radar type 0 should be used. For each frequency step the minimum percentage of detection is 90 percent. Measurements are performed with no data traffic.

### **PARAMETERS OF DFS TEST SIGNALS**

Step intervals of 0.1 microsecond for Pulse Width, 1 microsecond for PRI, 1 MHz for chirp width and 1 for the number of pulses will be utilized for the random determination of specific test waveforms.



**TABLE 10: SHORT PULSE RADAR TEST WAVEFORMS**

Radar Type	Pulse Width (μsec)	PRI (μsec)	Number of Pulses	Minimum Percentage of Successful Detection	Minimum Number of Trials
0	1	1428	18	See Note 1	See Note 1
1	1	Test A: 15 unique PRI values randomly selected from the list of 23 PRI values in Table 5a ----- Test B: 15 unique PRI values randomly selected within the range of 518-3066 μsec, with a minimum increment of 1 μsec, excluding PRI values selected in Test A	$\text{Roundup} \left\{ \begin{array}{l} \left( \frac{1}{360} \right) \\ \left( \frac{19 \cdot 10^6}{\text{PRI}_{\mu\text{sec}}} \right) \end{array} \right\}$	60%	30
2	1-5	150-230	23-29	60%	30
3	6-10	200-500	16-18	60%	30
4	11-20	200-500	12-16	60%	30
Aggregate (Radar Types 1-4)				80%	120
<b>Note 1:</b> Short Pulse Radar Type 0 should be used for the detection bandwidth test, channel move time, and channel closing time tests.					



A D T

**TABLE 11: LONG PULSE RADAR TEST WAVEFORM**

<b>RADAR TYPE</b>	<b>PULSE WIDTH (μsec)</b>	<b>CHIRP WIDTH (MHz)</b>	<b>PRI (μsec)</b>	<b>NUMBER OF PULSES PER BURST</b>	<b>NUMBER OF BURSTS</b>	<b>MINIMUM PERCENTAGE OF SUCCESSFUL DETECTION</b>	<b>MINIMUM NUMBER OF TRIALS</b>
5	50-100	5-20	1000-2000	1-3	8-20	80%	30

**TABLE 12: FREQUENCY HOPPING RADAR TEST WAVEFORM**

<b>RADAR TYPE</b>	<b>PULSE WIDTH (μsec)</b>	<b>PRI (μsec)</b>	<b>PULSES PER HOP</b>	<b>HOPPING RATE (kHz)</b>	<b>HOPPING SEQUENCE LENGTH (msec)</b>	<b>MINIMUM PERCENTAGE OF SUCCESSFUL DETECTION</b>	<b>MINIMUM NUMBER OF TRIALS</b>
6	1	333	9	0.333	300	70%	30



A D T

## 4. TEST & SUPPORT EQUIPMENT LIST

### 4.1 TEST INSTRUMENTS

TABLE 13: TEST INSTRUMENTS LIST

DESCRIPTION & MANUFACTURER	MODEL NO.	SERILA NO.	CALIBRATED DATE	CALIBRATED UNTIL
Spectrum Analyzer R&S	FSW8	101497	Aug. 07, 2013	Aug 06, 2014
Vector Signal Generator R&S	SMJ100A	101878	Aug. 13, 2013	Aug 12, 2014

### 4.2 DESCRIPTION OF SUPPORT UNITS

TABLE 14: SUPPORT UNIT INFORMATION

NO.	PRODUCT	BRAND	MODEL NO.	ID	SPEC.
1	WIRELESS AC MODULE	D-Link	WMC-AC01	RRK2012060056-1	The maximum EIRP is 27.64 dBm, Antenna Gain is 3.428dBi

**NOTE:** This device was functioned as a  Master  Slave device during the DFS test.

TABLE 15: SOFTWARE/FIRMWARE INFORMATION

NO.	PRODUCT	MODEL NO.	SOFTWARE/FIRMWARE VERSION
1.	WIRELESS AC MODULE	WMC-AC01	1.00 Wed 06 Mar 2013

Note: This module WMC-AC01 was installed in the DIR-868L AP.

## 5. TEST PROCEDURE

### 5.1 BVADT DFS MEASUREMENT SYSTEM:

A complete BVADT DFS Measurement System consists of two subsystems: (1) the Radar Signal Generating Subsystem and (2) the Traffic Monitoring Subsystem. The control PC is necessary for generating the Radar waveforms in Table 10, 11 and 12. The traffic monitoring subsystem is specified to the type of unit under test (UUT).

### CONDUCTED SETUP CONFIGURATION OF ADT DFS MEASUREMENT SYSTEM

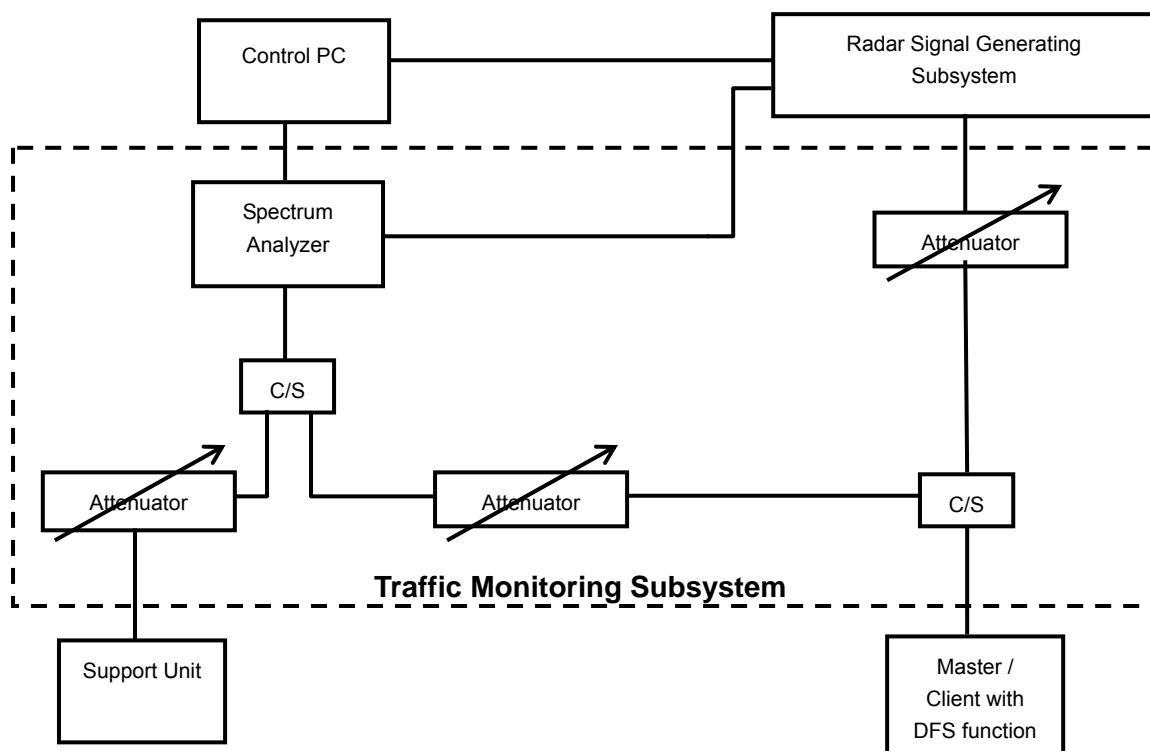

The test transmission will always be from the Master Device to the Client Device. While the Client device is set up to associate with the Master device and play the MPEG file (6  $\frac{1}{2}$  Magic Hours) from Master device, the designated MPEG test file and instructions are located at:

<http://ntiacsd.ntia.doc.gov/dfs/>.

## 5.2 CALIBRATION OF DFS DETECTION THRESHOLD LEVEL:

The measured channel is 5500 MHz in 20MHz Bandwidth and 5530MHz in 80MHz Bandwidth. The radar signal was the same as transmitted channels, and injected into the antenna port of AP (master) or Client Device with Radar Detection, measured the channel closing transmission time and channel move time. The Master antenna gain is 3.428dBi and required detection threshold is -59.572dBm (= -64 +1 +3.428). The calibrated conducted detection threshold level is set to -59.572 dBm.

### CONDUCTED SETUP CONFIGURATION OF CALIBRATION OF DFS DETECTION THRESHOLD LEVEL

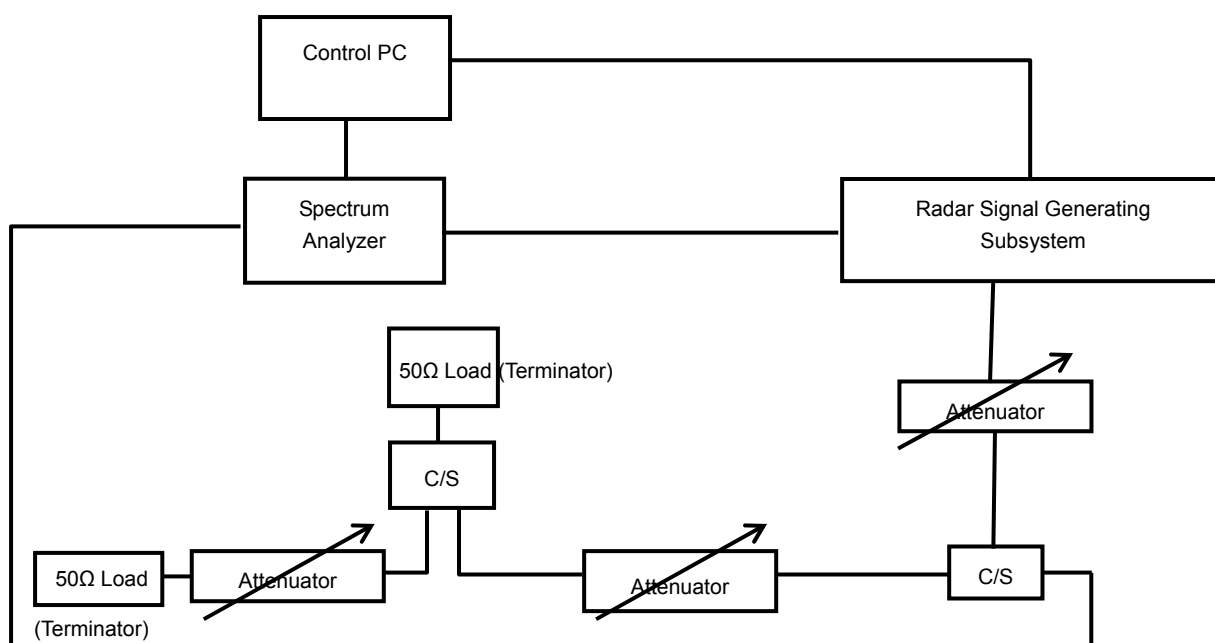



### 5.3 DEVIATION FROM TEST STANDARD

No deviation.

### 5.4 CONDUCTED TEST SETUP CONFIGURATION

#### 5.4.1 CLIENT WITHOUT RADAR DETECTION MODE

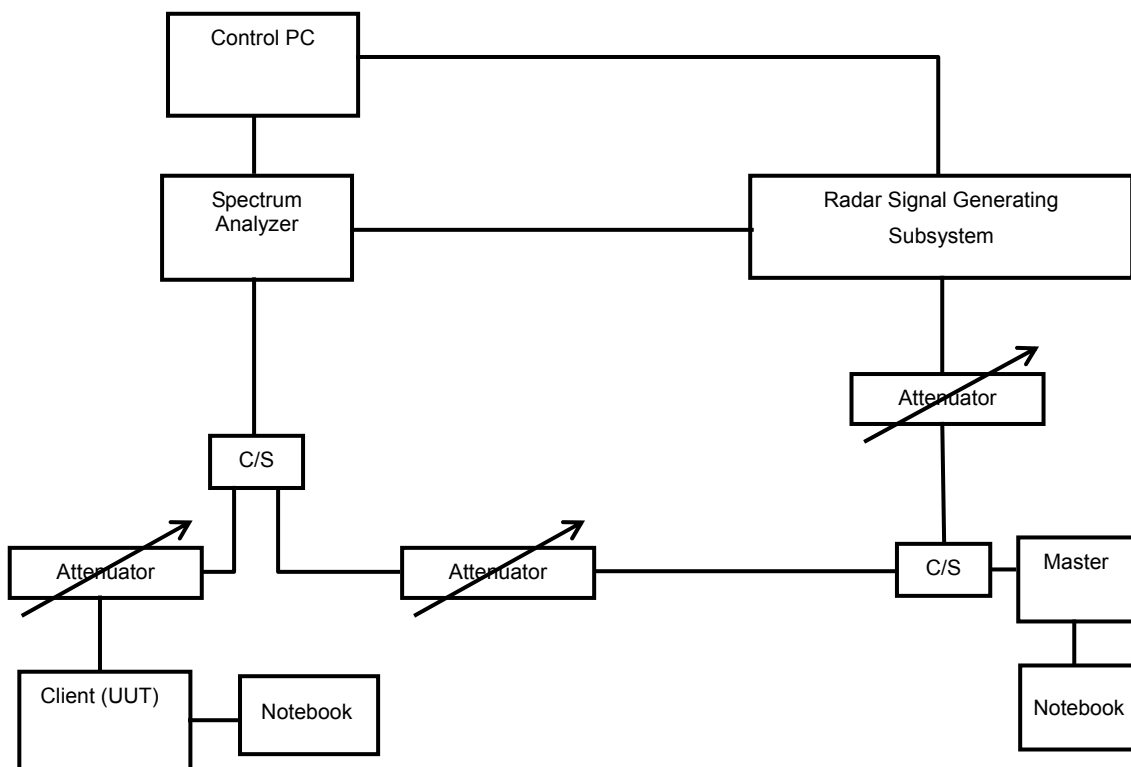

The UUT is a U-NII Device operating in Client mode without radar detection. The radar test signals are injected into the Master Device.



A D T

## 6. TEST RESULTS

### 6.1 SUMMARY OF TEST RESULTS

CLAUSE	TEST PARAMETER	REMARKS	PASS/FAIL
15.407	DFS Detection Threshold	Not Applicable	NA
15.407	Channel Availability Check Time	Not Applicable	NA
15.407	Channel Move Time	Applicable	Pass
15.407	Channel Closing Transmission Time	Applicable	Pass
15.407	Non- Occupancy Period	Applicable	Pass
15.407	U-NII Detection Bandwidth	Not Applicable	NA
15.407	Non-associated test	Applicable	Pass
15.407	Non-Co-Channel test	Applicable	Pass

## 6.2 DETAILED TEST RESULTS

### 6.2.1 TEST MODE: DEVICE OPERATING IN CLIENT WITHOUT RADAR DETECTION MODE.

The radar test signals are injected into the Master Device.  
 This test was investigated for different bandwidth (20MHz · 40MHz and 80MHz).  
 The following plots was done on 80MHz as a representative

#### 6.2.1.1 DFS DETECTION THRESHOLD

The required detection threshold is  $-59.572\text{dBm}$  ( $= -64 + 3.428 + 1$ ). The conducted radar burst level is set to  $-59.572\text{dBm}$ .

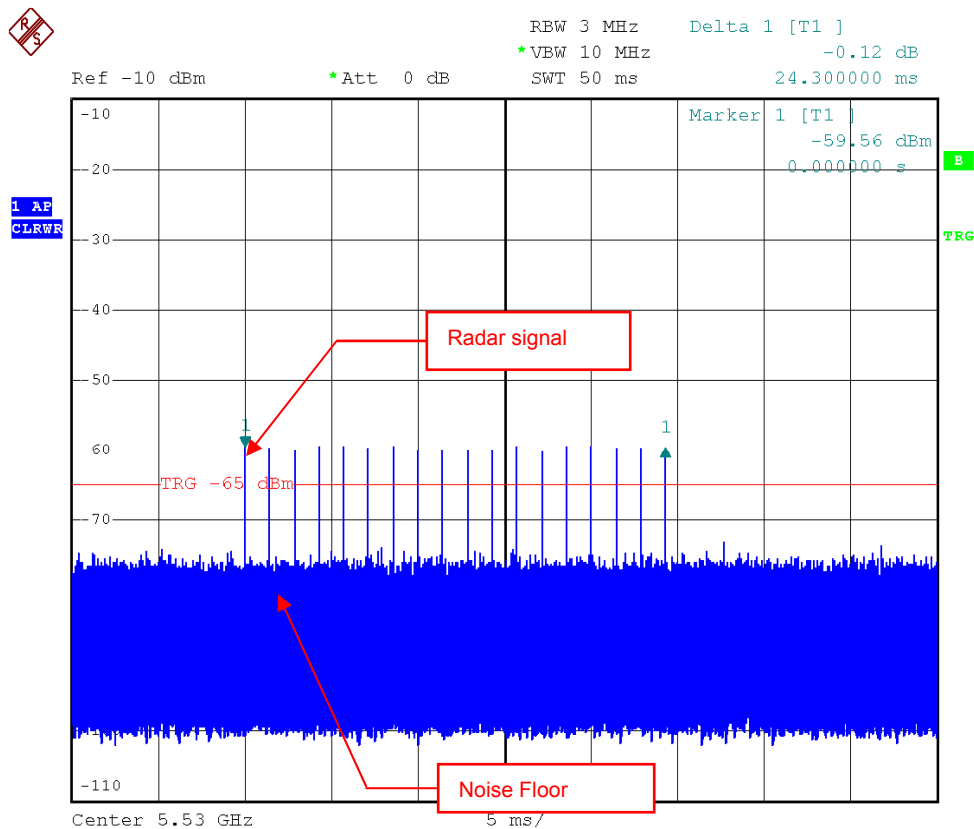

Radar Signal 0

### 6.2.1.2 CHANNEL CLOSING TRANSMISSION AND CHANNEL MOVE TIME

Channel Closing Transmission Time & Channel Move Time @ CH 106

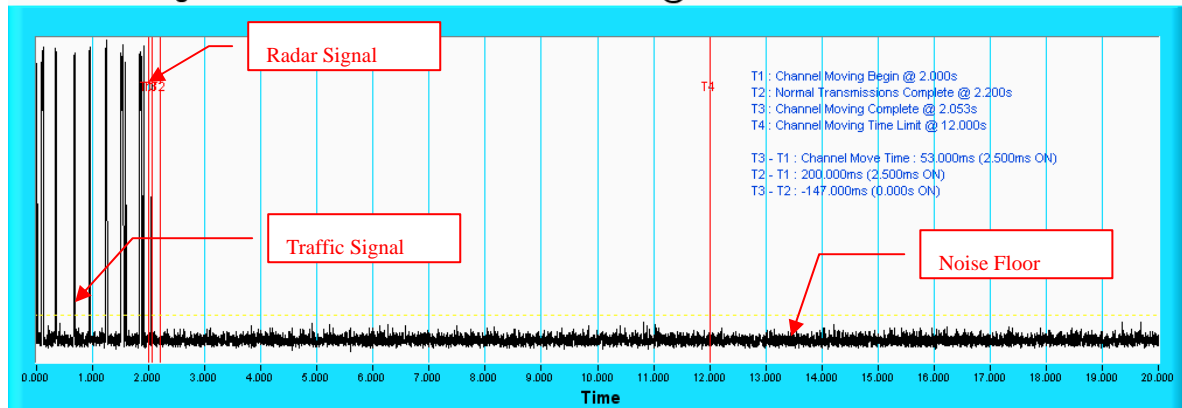

**NOTE:** T1 denotes the start of Channel Move Time upon the end of the last Radar burst. T2 denotes the data transmission time of 200ms from T1. T4 denotes the 10 second from T1 to observe the aggregate duration of transmissions.

Channel Closing Transmission Time & Channel Move Time @ CH 106

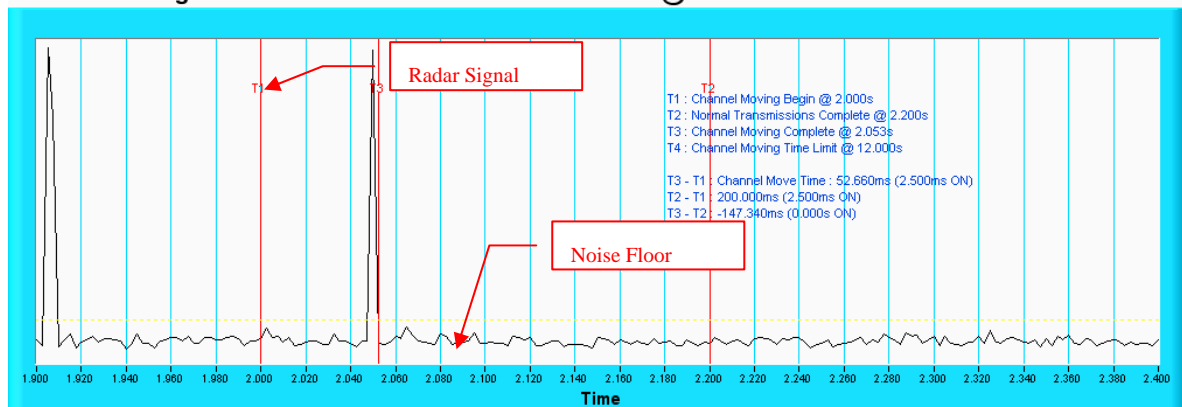

**NOTE:** An expanded plot for the device vacates the channel in the required 500ms.

### 6.2.1.3 NON- OCCUPANCY PERIOD

#### ASSOCIATED TEST

1) Test results demonstrating an associated client link is established with the master on a test frequency.

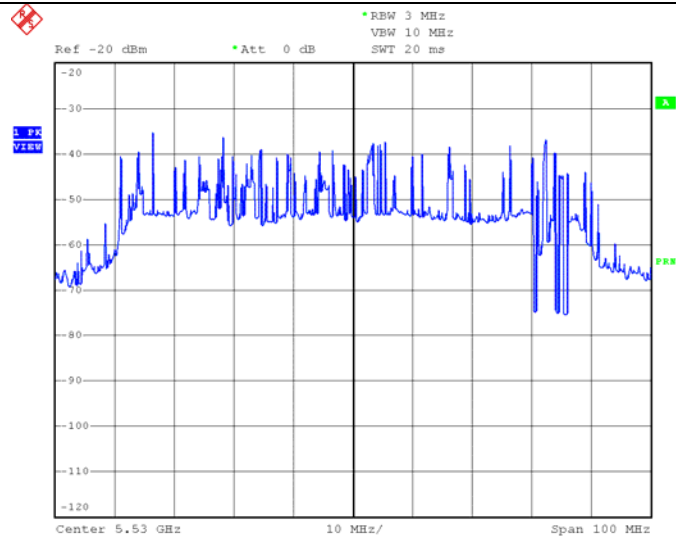

**EUT (Client) links with master on 5530MHz**

2) The client and DFS-certified master device are associated, and the movie can be streamed as specified in the DFS Order for a non-occupancy period test.

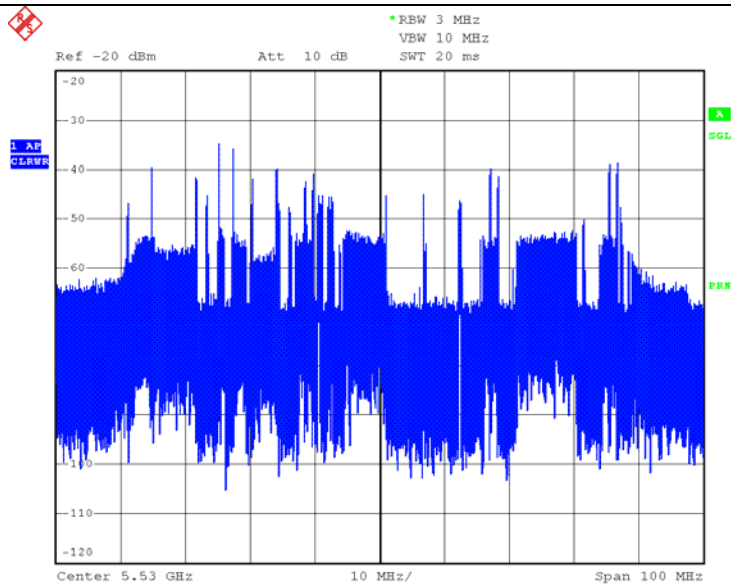

**Client plays a specified files via master.**

3). The device transmits one type of radar as specified in the DFS Order.

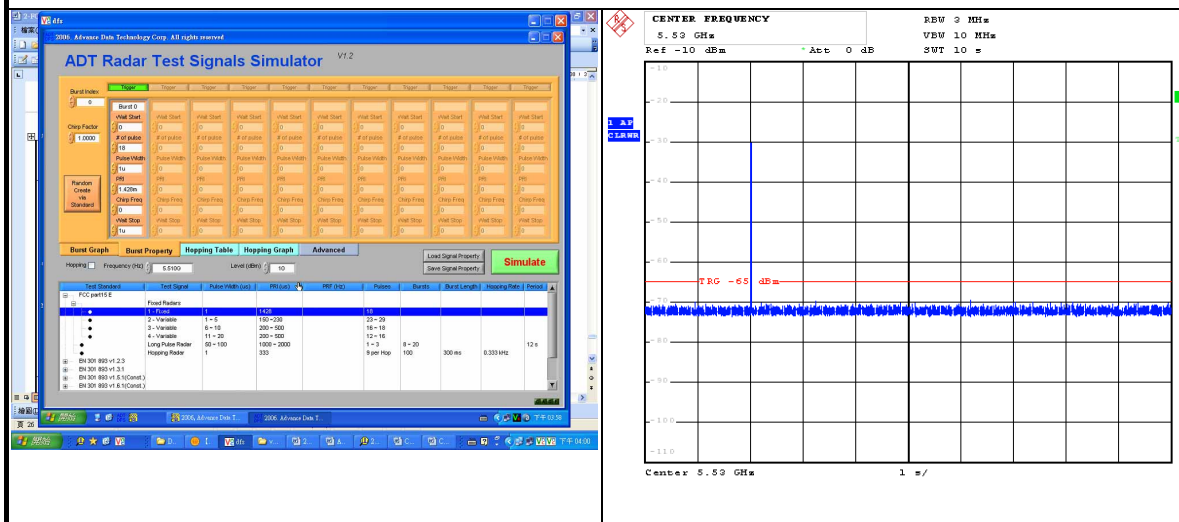

Radar 0 is used to test during DFS testing.

4) The test frequency has been monitored to ensure no transmission of any type has occurred for 30 minutes;

Note: If the client moves with the master, the device is considered compliant if nothing appears in the client non-occupancy period test. For devices that shut down (rather than moving channels), no beacons should appear;

5) An analyzer plot that contains a single 30-minute sweep on the original test frequency.

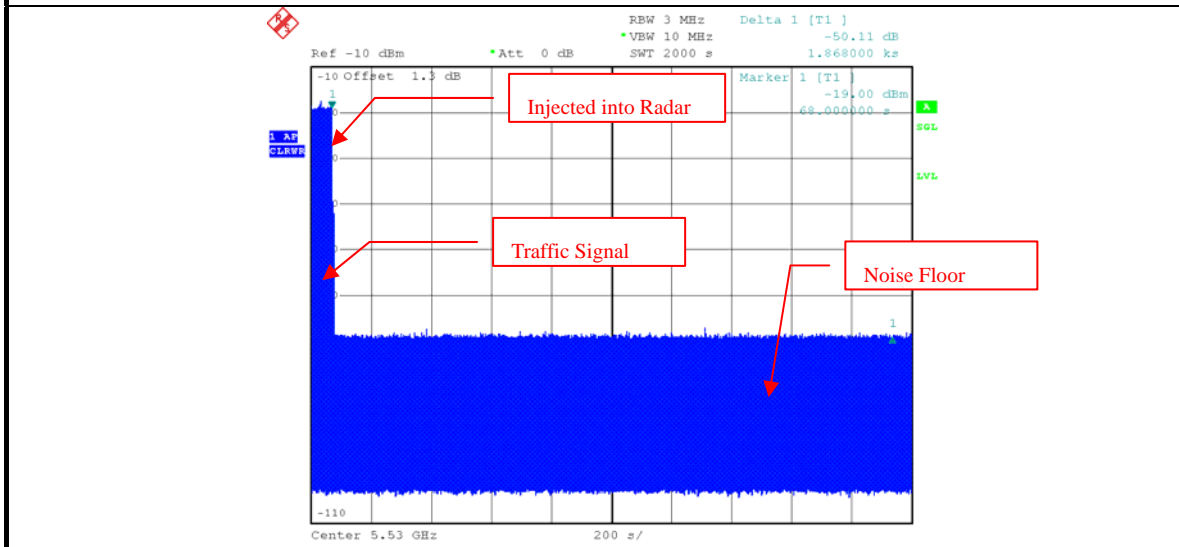

#### 6.2.1.4 NON-ASSOCIATED TEST

Master was off.

During the 30 minutes observation time, The UUT did not make any transmissions in the DFS band after UUT power up.

##### Non - Associated Test @ CH 106 - 5530 MHz

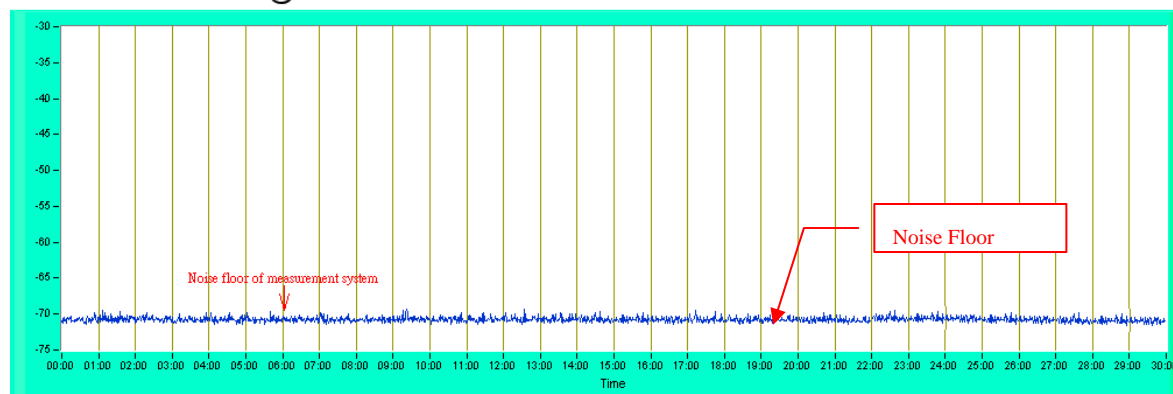

#### 6.2.1.5 NON- CO-CHANNEL TEST

The UUT was investigated after radar was detected the channel and made sure no co-channel operation with radars.



A D T

## 7. INFORMATION ON THE TESTING LABORATORIES

We, Bureau Veritas Consumer Products Services (H.K.) Ltd., Taoyuan Branch, were founded in 1988 to provide our best service in EMC, Radio, Telecom and Safety consultation. Our laboratories are accredited and approved according to ISO/IEC 17025.

If you have any comments, please feel free to contact us at the following:

**Linko EMC/RF Lab:**

Tel: 886-2-26052180

Fax: 886-2-26052943

**Hsin Chu EMC/RF Lab:**

Tel: 886-3-5935343

Fax: 886-3-5935342

**Hwa Ya EMC/RF/Safety/Telecom Lab:**

Tel: 886-3-3183232

Fax: 886-3-3270892

**Email:** [service.adt@tw.bureauveritas.com](mailto:service.adt@tw.bureauveritas.com)

**Web Site:** [www.bureauveritas-adt.com](http://www.bureauveritas-adt.com)

The address and road map of all our labs can be found in our web site also.





A D T

## 8. APPENDIX-A

### NON BEACON ON DFS BAND

- 1) Test results demonstrating no any beacon on DFS band after power up.
- 2) Observation time is 10min after power up.

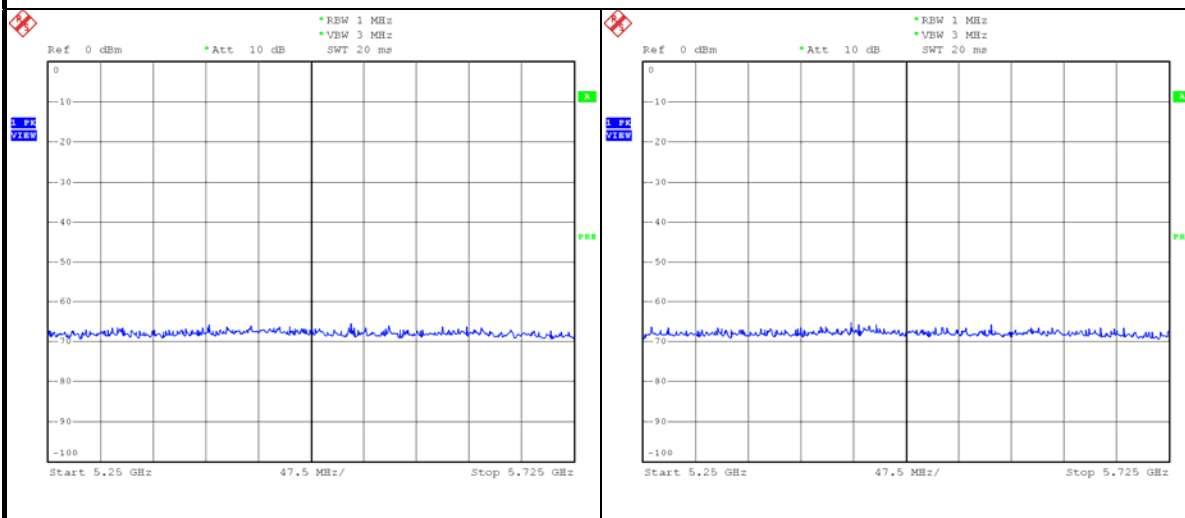

**EUT (Client) links with master on 11ac (VHT20) mode**

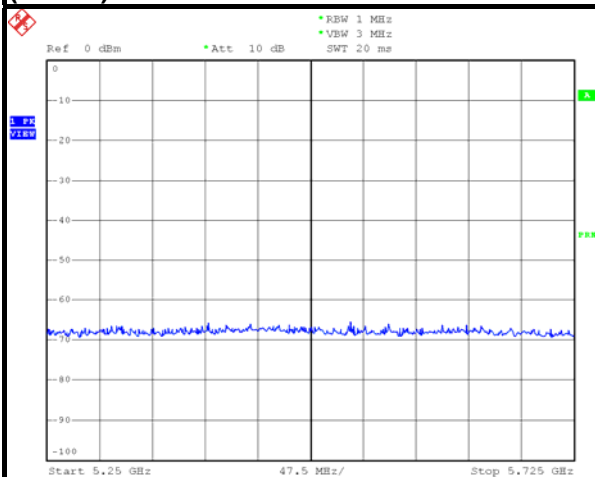

**EUT (Client) links with master on 11ac (VHT40) mode**

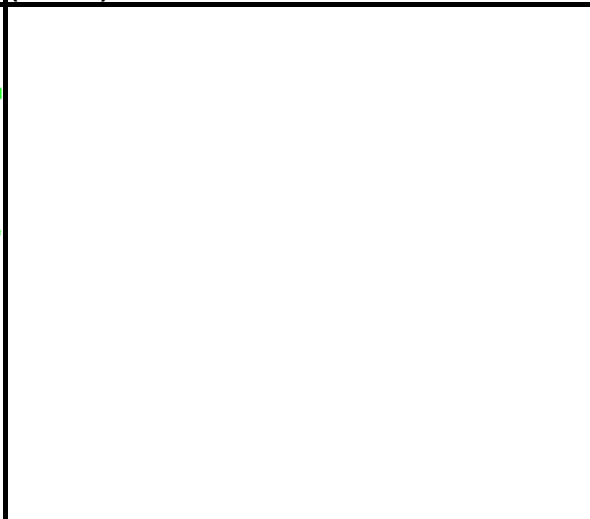

**EUT (Client) links with master on 11ac (VHT80) mode**



**BAND EDGE AT NEARBY DFS BAND**

1) Test results demonstrating last channel (20dB BW) shall not exceed the band edge on 5150~5250MHz.

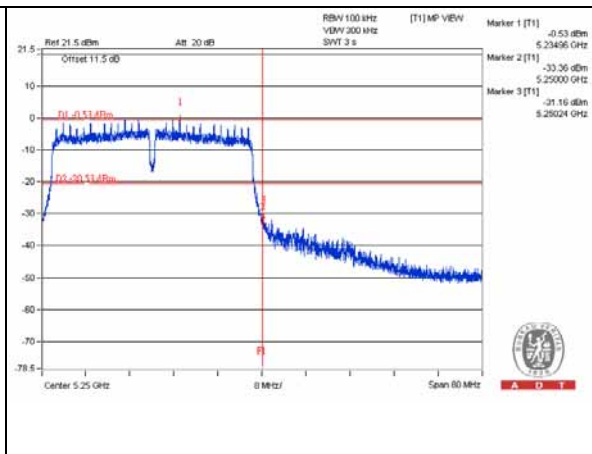
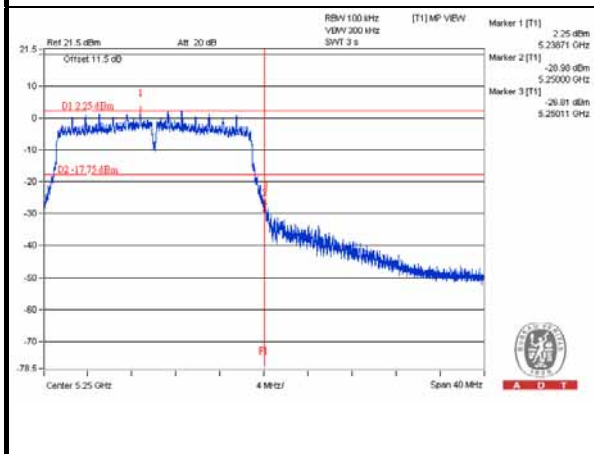

**EUT (Client) links with master on 11ac (VHT20) mode**

**EUT (Client) links with master on 11ac (VHT40) mode**

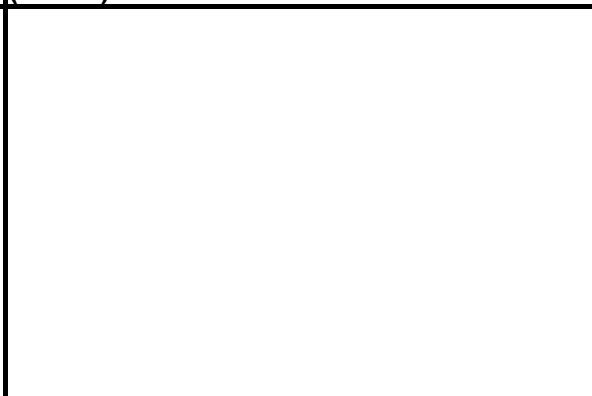
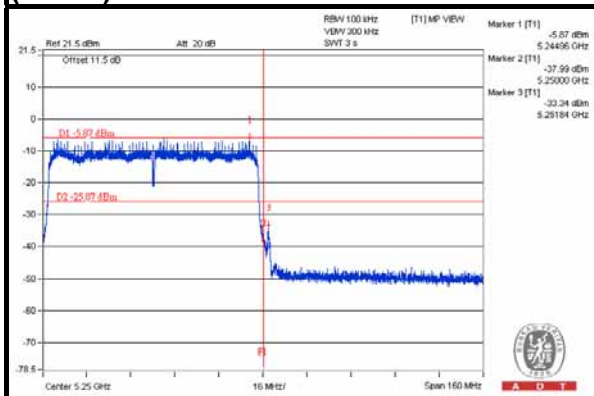

**EUT (Client) links with master on 11ac (VHT80) mode**





A D T

## 9. APPENDIX B - MODIFICATIONS RECORDERS FOR ENGINEERING CHANGES TO THE EUT BY THE LAB

No modifications were made to the EUT by the lab during the test.

--- END ---