

DFS TEST REPORT

(for 5GHz WLAN)

Project No. : JB-Z0432
Client : Sony Corporation
Client's Address : 1-7-1 Konan Minato-ku Tokyo, 108-0075 Japan
Product Name : Communication Module
Model No. : FLE01WBM
FCC ID : AK8FLE01WBM
Test Standard : 47 CFR Part 15 Subpart E
Sample Receipt Date : June 22, 2018
Test Date : July 09, 2018
Report Date : July 26, 2018
Test Result : Complied

Notice:

- * These test results relate only to the items (combination equipment, test configuration, operation condition etc.) tested.
- * This report shall not be reproduced except in full, without written approval of the laboratory.
- * This report must not be used by the client to claim product endorsement by A2LA or any agency of the U.S.
- * Hereby certify that no party is subject to a denial of federal benefits pursuant to section 5301 of the Anti-Drug Abuse Act.
- * All test results are traceable to the national and / or international standards.
- * The testing in which "Non-accreditation" is displayed is outside the accreditation scopes in Sony Global Manufacturing & Operations Corporation EMC/RF Test Laboratory.

Reported by:

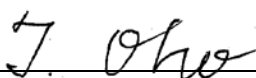

Takanori Oho
Technical Manager
EMC/RF Test Laboratory, Main Lab.
Design Technology Division

Approved Signatory:

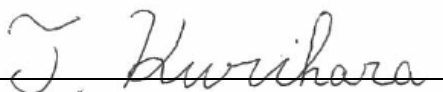

Teruki Kurihara
Technical Manager
EMC/RF Test Laboratory, Main Lab.
Design Technology Division



TESTING CERT #3203.01

TABLE OF CONTENTS

1.	General Information.....	3
	1.1. Description of Equipment Under Test (EUT).....	3
	1.2. Summary of Test Result.....	3
	1.3. Tested Methodology	4
	1.4. Measurement Procedures	4
	1.5. Test Facility.....	5
	1.6. Uncertainty	5
2.	System Test Configuration.....	6
	2.1. Validation	6
	2.2. Test Operating Conditions	6
	2.3. Special Accessories	6
	2.4. EUT Modifications	6
	2.5. Configuration of Tested System	7
3.	Test Data.....	8
4.	Method of Calculation	9
5.	List of Test Equipment.....	9
6.	Photographs of test setup.....	10

Note

- indicates that the listed condition, standard or equipment is applicable for this report.
- indicates that the listed condition, standard or equipment is not applicable for this report.

Revision History

Revision	Date	Overview	Page
JB-Z0432 (Original)	July 26, 2018	-	-

1. General Information

1.1. Description of Equipment Under Test (EUT)

General Specification

Test Sample Condition : Prototype Pre-production Mass-production
 Product Name : Communication Module
 Trade Name : SONY
 Model No. : FLE01WBM
 Serial No. : 4
 Power Rating of the EUT : DC 3.3 V (The EUT is supplied with the power from the host device)

Similar model(s) to be covered by this report

Model No. : None

Radio Specification

Function of the Equipment : Transceiver
 Operating Frequency :

IEEE Standard	Operating Frequency Band [MHz]			
	U-NII-1	U-NII-2A	U-NII-2C	U-NII-3
802.11a	5180 to 5240	5260 to 5320	5500 to 5700	5745 to 5825
802.11n(HT20)			5500 to 5720	
802.11ac(VHT20)				
802.11n(HT40)	5190 to 5230	5270 to 5310	5510 to 5670	5755 to 5795
802.11ac(VHT40)			5510 to 5710	
802.11ac(VHT80)				
	5210 to 5290		5530 to 5690	5775

Modulation Type : OFDM
 Antenna Type : Inverted-F antenna
 Antenna connector Type : None
 Antenna Gain : 0.0 dBi
 Operating Temperature : -30 to +85 deg.C

1.2. Summary of Test Result

Test Item	Operational Mode: Client Without Radar Detection	Results
U-NII Detection Bandwidth	Not required	N/A
Initial Channel Availability Check Time	Not required	N/A
Radar Burst at the Beginning of the Channel Availability Check Time	Not required	N/A
Radar Burst at the End of the Channel Availability Check Time	Not required	N/A
In-Service Monitoring for Channel Move Time, Channel Closing Transmission Time	Yes (See data)	Complied
In-Service Monitoring for Non-Occupancy Period	Yes (See data)	Complied
Statistical Performance Check	Not required	N/A

Other Requirements

§15.31(e) Supply voltage requirement : Complied (The EUT was provided with stable DC 3.3V from the host device)
 §15.203 / 212 Antenna requirement : Complied (Users cannot replace the external antenna, since it's mounted to the inside of the host device)

1.3. Tested Methodology

Test Standard : 47 CFR Part15 Subpart E Section 15.407
 Test Method : KDB 905462 D02 UNII DFS Compliance Procedures New Rules v02

1.4. Measurement Procedures

We performed the measurements in accordance with NV3-10, available upon the request.

- No deviation
- Deviation from the above procedure

The summary of the above procedure is mentioned below;

Dynamic Frequency Selection (for Client device without radar detection)

1. As master device, Access Point AIR-CAP3702E-B-K9 (FCC ID: LDK102087) is used.
2. Master device communicates with client device (EUT) by transmitting/receiving a data packet.

Applicability of DFS requirements during normal operation:

Requirements for devices with multiple bandwidth modes	Client Without Radar Detection
Channel Move Time, Channel Closing Transmission Time, Non-Occupancy Period	Test using the widest BW mode available for the link

3. Vector Signal Generator set to the Short Pulse Radar Type 0 and level of Detection Threshold + 1dB at antenna port of the master device.

Radar Test Waveform:

Radar Type	Pulse Width [µsec]	PRI [µsec]	Number of Pulses	Minimum Percentage of Successful Detection	Minimum Number of Trials
0	1	1428	18	-	-

*Note 1 : Short Pulse Radar Type 0 is used for the channel move time, and channel closing time tests.

DFS Detection Thresholds for Master Devices:

Maximum Transmit Power	Value
EIRP ≥ 200 [mW]	-64 dBm
EIRP < 200 [mW] and power spectral density < 10 [dBm/MHz]	-62 dBm
EIRP < 200 [mW] that do not meet the power spectral density requirement	-64 dBm

*Note 1 : This is the level at the input of the receiver assuming a 0 dBi receive antenna.

*Note 2 : Throughout these test procedures an additional 1 dB has been added to the amplitude of the test transmission waveforms to account for variations in measurement equipment. This will ensure that the test signal is at or above the detection threshold level to trigger a DFS response.

*Note 3 : EIRP is based on the highest antenna gain. For MIMO devices refer to KDB Publication 662911 D01.

4. As Channel Move Time and Channel Closing Transmission Time testing, EUT transmissions are observed on spectrum analyzer from the end of radar burst until after 10sec.

As Non-Occupancy Period testing, EUT transmissions are observed on spectrum analyzer more than 30 minutes after the Channel Move.

Spectrum Analyzer Settings:

Parameter	Value
RBW	3 MHz
VBW	10 MHz
Span	Zero Span
Detector	Positive Peak
Trace	Clear / Write (Single Sweep)
Sweep Point	30001

DFS Response Requirement Values:

Parameter	Value	Remark
Non-Occupancy Period	Minimum 30 [min]	-
Channel Move Time	10 [sec]	See Note 1
Channel Closing Transmission Time	200 [msec] + an aggregate of 60 [msec] over remaining 10 [sec] period	See Note 1, 2

*Note 1 : Channel Move Time and the Channel Closing Transmission Time should be performed with Radar Type 0. The measurement timing begins at the end of the Radar Type 0 burst.

*Note 2 : The Channel Closing Transmission Time is comprised of 200 msec starting at the beginning of the Channel Move Time plus any additional intermittent control signals required to facilitate a Channel move (an aggregate of 60 msec) during the remainder of the 10 second period. The aggregate duration of control signals will not count quiet periods in between transmissions.

1.5. Test Facility

Test Facility Name : Sony Global Manufacturing & Operations Corporation
EMC/RF Test Laboratory, Main Lab.
Address : Kisarazu Site 8-4 Shiomi Kisarazu-shi, Chiba, 292-0834 Japan
Phone : +81 438 37 2750

A2LA Certificate No. : 3203.01
Cert. Validated Date : Oct. 31, 2019

Dynamic Frequency Selection

Shielded Room

 4th Site SR1

1.6. Uncertainty

Test Item	Frequency	4th Site SR1
Power Spectrum : Conducted	1 GHz - 6 GHz	± 1.25 dB
Time	-	± 3.00 %

2. System Test Configuration

2.1. Validation

The system was configured for testing in a typical (as a customer would normally use it).
The tests were conducted with the worst case modes as follows.

2.2. Test Operating Conditions

The tests have been carried out the following conditions:

Test Items	Operating Mode	Test Channels
Dynamic Frequency Selection	802.11ac (VHT80)	5290MHz

The Software for Operating Mode

Software Name : iperf
Software Version : 2.0.3

2.3. Special Accessories

Special accessories needed for connecting the EUT to achieve compliance:

Item	Manufacturer	Model No.	Serial No.	Remark
Personal Computer	SONY	VPCZ21ADZ	27546912 1009099	-
AC Adaptor	SONY	VGP-AC19V41	148753041 0999737	-

2.4. EUT Modifications

- No equipment modification to achieve compliance to the standard levels was done during the tests.
 Equipment was modified to achieve compliance to the standard level as below.

Responsible Party Signature

Typed/ Print Name :
Responsible Party :
Position :
Date :

2.5. Configuration of Tested System

Dynamic Frequency Selection Measurements

[EUT and Associated Equipment (AE)]

Symbol	EUT / AE	Item	Manufacturer	Model No.	Serial No.
A	EUT	Communication Module	SONY	FLE01WBM	4
B	AE	Head Mounted Display	SONY	FL-E01	4
C	AE	Lithium Ion Battery Pack	SONY	NP-BX1	FER2K9W 229RUVY
D	AE	Lithium Ion Battery Pack	SONY	NP-BX1	2BM2M89 2XZFKSR
E	AE	Jig Board	-	-	013
F	AE	Access Point	Cisco	AIR-CAP3702E-B-K9	FJC2105M41N
G	AE	AC Adaptor	Cisco	EADP-18MBB	DAB1445M1XV
H	AE	Personal Computer	SONY	SVS1311ADZB	27554083 1002141
I	AE	AC Adaptor	SONY	VGP-AC19V31	148095471 0305356

[Type of Cable]

Symbol	Description	Identification (Manufacturer etc.)	Shielded Yes / No	Ferrite Core	Length (m)	Bundled
1	Flexible Flat Cable	-	NO	NO	0.1	-
2	DC Cable	-	NO	Fixed x1	1.85	-
3	AC Cable	-	NO	NO	1.9	-
4	LAN Cable	MCO	NO	NO	5.0	-
5	DC Cable	-	NO	NO	1.70	-
6	AC Cable	HEWTECH	NO	NO	1.45	-

[Connecting Diagram]

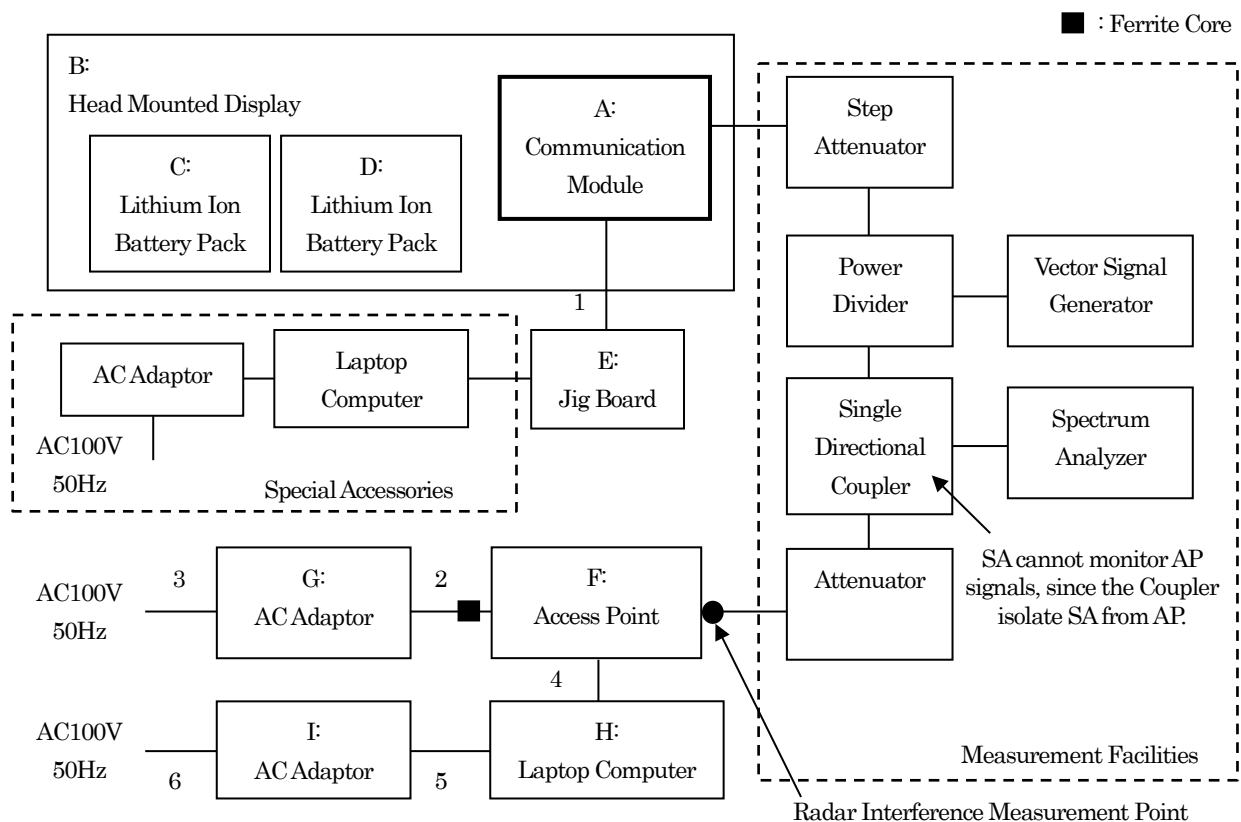

3. Test Data

3.1. Dynamic Frequency Selection Measurement

- 1) Ambient temperature : 20.5 deg.C
- 2) Relative humidity : 58 %
- 3) Date of measurement : July 09, 2018
- 4) Measured by : M.KOUGA

Test Parameter Settings

- Radar interference level : -63dBm (-64dBm Detection Threshold + 1dB, at antenna gain 0dBi)
- Channel loading : More than approximately 17%
- Sweep point of the spectrum analyzer : 30001 (Dwell time per sampling bin is 0.5msec in sweep time 15sec)

Test Result

Test Item		Transmission bins	Tested Time	Limit	Results
Channel Move Time		-	0.645 sec	10 sec	Complied
Channel Closing Transmission Time	Data Transmission	172 pts.	86 msec	200 msec	Complied
	aggregate of control signals	8 pts.	4 msec	60 msec	Complied
Non-Occupancy Period		0 pts.	-	30 sec	Complied

[Radar Interference Level Plot]

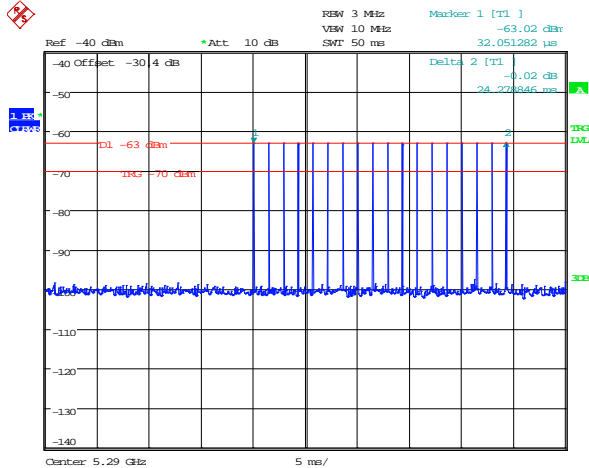

Date: 9.JUL.2018 14:36:56

[EUT Transmit Level / Channel Loading Plot]

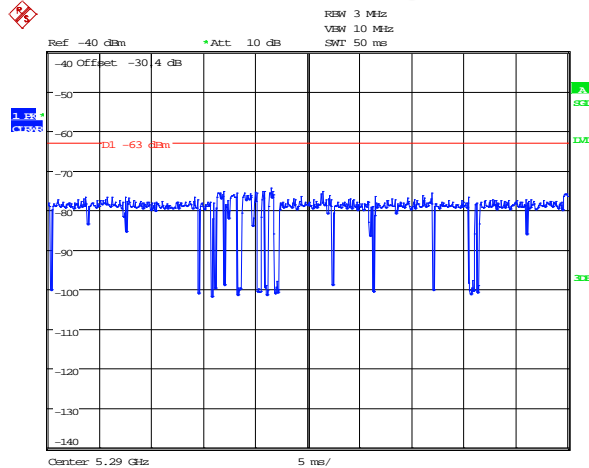

Date: 9.JUL.2018 15:48:42

[Channel Move Time / Channel Closing Transmission Time Plot]

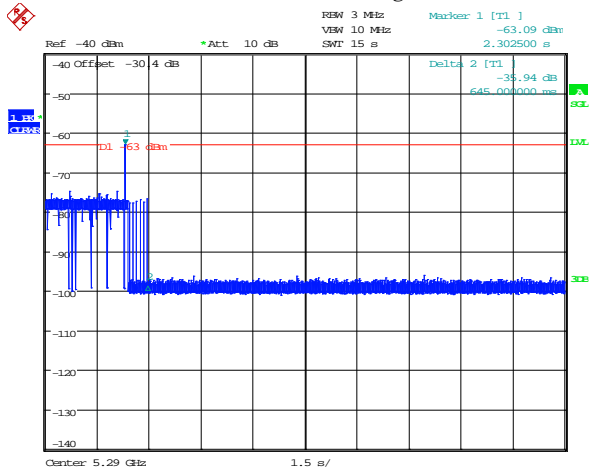

Date: 9.JUL.2018 16:55:46

[Non-Occupancy Period Plot]

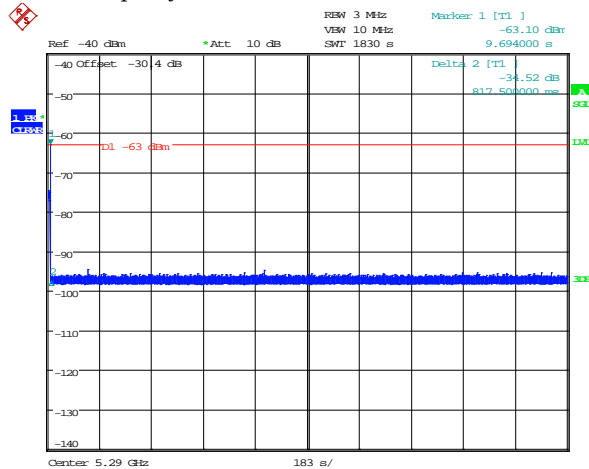

Date: 9.JUL.2018 19:07:46

4. Method of Calculation

4.1. Dynamic Frequency Selection Measurement

Method of calculation : Software
 Software Name : SW-304
 Software Version : Ver.2.0

Channel Closing Transmission Time

Dwell [msec] = S [msec] / B [point]
 Tested Time [msec] = N [point] * Dwell [msec]

Note (a) Dwell : Dwell time per spectrum analyzer sampling bin.
 (b) S : Sweep time settings on the spectrum analyzer.
 (c) B : Number of spectrum analyzer sampling bins.
 (d) N : Number of spectrum analyzer sampling bins showing a U-NII transmission.

5. List of Test Equipment

All test results are traceable to the national and/or international standards.

5.1. Dynamic Frequency Selection Measurement

4th Site Shielded Room 1

	Ctrl.#	Equipment	Model No.	Serial No.	Manufacturer	Cal.Int.	Last Cal.
x	-	Shield Room	B83117-B2432-T161	P26428	Albatross Project	-	-
x	W0099	Signal Generator	MG3710A	6201371416	Anritsu	12	18.04.02
x	W0100	Spectrum Analyzer	MS2692A	6201338954	Anritsu	12	18.04.03
x	W0110	10dB Attenuator	6610_SK-50-1	0002	HUBER + SUHNER	12	17.08.03
x	WC0002	RF Cable	SUCOFLEX 102	34124/2	HUBER + SUHNER	12	17.08.03
x	WC0003	RF Cable	SUCOFLEX 102	34127/2	HUBER + SUHNER	12	17.08.03
x	WC0004	RF Cable	SUCOFLEX 102	34288/2	HUBER + SUHNER	12	17.08.03
x	WC0005	RF Cable	SUCOFLEX 102	34287/2	HUBER + SUHNER	12	17.08.03
x	WC0006	RF Cable	SUCOFLEX 102	34289/2	HUBER + SUHNER	12	17.08.03
-	WC0007	RF Cable	SUCOFLEX 102	34286/2	HUBER + SUHNER	12	17.08.03
x	W0060	Directional Coupler	4244-20	03926	Narda	12	18.04.03
x	W0021	Power Divider	11636B	57395	Agilent Technologies	12	17.08.04
x	W0138	Step Attenuator	8496H	MY42147804	Agilent Technologies	12	17.08.03
x	M0421	Step Attenuator	8494H	3837M01145	Hewlett-Packard	12	17.10.31
x	M0719	Thermometer	TH-321	140053	AS ONE	12	18.04.11

About calibration interval:

Valid until the end of the month listed in "Cal. Int." column.