

# RADIO TEST REPORT

(for Bluetooth Low Energy)

Project No. : JB-Z0418

Client : Sony Corporation

Address : 1-7-1 Konan Minato-ku Tokyo, 108-0075 Japan

Type of Equipment : Communication Module

Model No. : FLE01WBM

FCC ID : AK8FLE01WBM

Regulation Applied : 47 CFR Part 15 Subpart C

**Final Judgment** : **Passed**

Sample Receipt : May 14, 2018

Testing : May 31, 2018 - July 18, 2018

Reported : July 24, 2018

Reported by :

Approved Signatory :

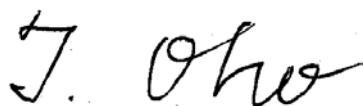

Takanori Oho  
 Technical Manager  
 EMC/RF Test Laboratory, Main Lab.  
 Design Technology Division  
 Sony Global Manufacturing & Operations Corporation

Teruki Kurihara  
 Technical Manager  
 EMC/RF Test Laboratory, Main Lab.  
 Design Technology Division  
 Sony Global Manufacturing & Operations Corporation

**Notice**

- \* These test results relate only to the items (combination equipment, test configuration, operation condition etc.) tested.
  - \* This report shall not be reproduced except in full, without written approval of the laboratory.
  - \* This report must not be used by the client to claim product endorsement by A2LA or any agency of the U.S. Government.
  - \* All test results are traceable to the national and / or international standards.
- The testing in which "Non-accreditation" is displayed is outside the accreditation scopes in Sony Global Manufacturing & Operations Corporation EMC/RF Test Laboratory.*



**Sony Global Manufacturing & Operations Corporation EMC/RF Test Laboratory, Main Lab.**

A2LA Cert. #3203.01

Kisarazu Site 8-4 Shiomi Kisarazu-shi Chiba, 292-0834 Japan  
 PHONE +81-(438) 37-2750 FAX +81-(438) 37-1021

## TABLE OF CONTENTS

<b>1. General Information.....</b>	<b>3</b>
1.1. Description of Equipment Under Test (EUT).....	3
1.2. Summary of Test Result.....	3
1.3. Tested Methodology .....	4
1.4. Measurement Procedures .....	4
1.5. Test Facility.....	7
1.6. Uncertainty .....	8
<b>2. System Test Configuration .....</b>	<b>8</b>
2.1. Validation .....	9
2.2. Test Operating Conditions .....	9
2.3. EUT Modifications .....	9
2.4. Configuration of Tested System .....	10
<b>3. Test Data.....</b>	<b>13</b>
3.1. AC Power-line Conducted Emissions .....	13
3.2. 6dB Bandwidth.....	14
3.3. Maximum Peak Conducted Output Power.....	15
3.4. Power Spectral Density .....	16
3.5. Radiated Spurious Emissions.....	17
3.6. Conducted Spurious Emissions for Band Edge.....	38
<b>4. Method of Calculation .....</b>	<b>39</b>
<b>5. List of Test Equipment.....</b>	<b>41</b>
5.1. AC Power-line Conducted Emissions .....	41
5.2. Antenna-port Conducted Measurements.....	41
5.3. Radiated Spurious Emissions.....	42
<b>6. Photographs of test setup.....</b>	<b>43</b>
6.1. AC Power-line Conducted Emissions Measurement Photo(s) .....	43
6.2. Antenna-port Conducted Measurements Photo(s) .....	43
6.3. Radiated Spurious Emissions Measurement Photo(s).....	44

Note

- indicates that the listed condition, standard or equipment is applicable for this report.  
-indicates that the listed condition, standard or equipment is not applicable for this report.

## 1. General Information

### 1.1. Description of Equipment Under Test (EUT)

#### General specification

Test Sample Condition :  Prototype  Pre-production  Mass-production  
 Type of Equipment : Communication Module  
 Trade Name : SONY  
 Model No. : FLE01WBM  
 Serial No. : 1  
 Power Rating : DC 3.3V (The EUT was supplied with the power from the host device)

#### Radio specification

Function of the Equipment : Transceiver  
 Operating Frequency : 2402 - 2480 MHz  
 Modulation Type : GFSK  
 Channel Spacing : 2 MHz  
 Channel Bandwidth : 2 MHz  
 Number of channels : 40  
 Antenna Type : Inverted-F Antenna  
 Antenna connector Type : None  
 Antenna Gain : 1.1 dBi  
 Operating Temperature : -30 to +85 deg.C

### 1.2. Summary of Test Result

47 CFR Part 15 Subpart C § 15.247 [DTS]

Test Item	Worst Margin	Test Frequency band	Results
AC Power-line Conducted Emissions	23.8 dB (AV) 9.409 MHz N	150 kHz - 30 MHz	Complied
	23.8 dB (AV) 9.408 MHz L1		
6dB Bandwidth	Refer to the test data	Carrier	Complied
Maximum Peak Conducted Output Power	29.64 dB	Carrier	Complied
Power Spectral Density	23.19 dB	Carrier	Complied
Radiated Spurious Emissions	10.7 dB (AV) 3388.108 MHz Vertical	9 kHz - 25 GHz (excluding carrier and band edge)	Complied
Conducted Spurious Emissions for Band Edge *1	28.01 dB 2399.98 MHz	Carrier band edge	Complied

\*1: Conducted Spurious Emission was tested for the only frequencies in the non-restricted carrier band edges, since the spurious emissions in other non-restricted band were complied with Radiated Spurious Emission measurement.

#### Other requirements

Part 15.31(e) Supply voltage requirement

: Complied (The EUT is provided with stable DC 3.3V from the host device)

Part 15.203 / 212 Antenna requirement

: Complied (Users cannot replace the external antenna, since it is mounted to the EUT inside)

1.3. Tested Methodology

Test Standard : 47 CFR Part15 Subpart C  
 Test Method : ANSI C63.10 - 2013  
 KDB 558074 D01 DTS Meas. Guidance v04

Test Condition

AC Power-line Conducted Emissions

Dimensions of the EUT table : 0.8 m height, 2 m width and 1 m depth.

Radiated Spurious Emissions

Test Distance :  3 m  10m (9 kHz - 30 MHz)  
 3 m  10m (30 - 1000 MHz)  
 3 m (1 - 25 GHz)

Dimensions of the EUT table

Below 1GHz : 0.8 m height, 0.5 m width and 1 m depth.  
 Above 1GHz : 1.5 m height, 2 m width and 1 m depth.

1.4. Measurement Procedures

We performed the measurements in accordance with NV3-06, available upon the request.

- No deviation
- Deviation from the above procedure

\_\_\_\_\_

The summary of the above procedure is mentioned below

Antenna-port Conducted Measurement

1. Antenna-port of the EUT was connected to the power sensor (Maximum peak conducted output power) or spectrum analyzer. (other test items).
2. For each EUT operation mode, the Antenna-port Conducted Measurements were measured with power meter or spectrum analyzer.

Test Item	Detector	RBW
<b>* Antenna-port Conducted Measurements</b>		
6dB Bandwidth	Peak	100 kHz
Maximum Peak Conducted Output Power	Peak	-
Power Spectral Density	Peak	3 kHz
Conducted Spurious Emissions for Band Edge	Peak	100 kHz

AC Power-line Conducted Emissions

1. The non-conductive table (EUT table) made of ( FRP,  wood,  other non-conductive material) was placed 0.4 m from its rear to the vertical reference ground plane.
2. The EUT was placed on the center of tabletop and its rear was flush with the rear of the table, connected through a LISN to the input power mains.
3. The LISN was placed in 80 cm from the nearest part of the EUT chassis.
4. The excess length of the AC cable between the EUT and the LISN receptacle, or an adaptor or extension cable connected to and measured with LISN, was folded back and forth at the center of the lead to form a bundle not exceeding 40 cm in length.
5. The connection of the all other equipment to the second LISN was performed. The second LISN was terminated with a 50-ohm terminator.
6. Interconnecting cables that hang closer than 40 cm to the horizontal reference ground plane was folded back and forth forming a bundle 30 to 40 cm long, hanging approximately in the middle between the horizontal reference ground plane and the tabletop.
7. Find the worst mode and arrangement of the EUT according to the follows;
  - Connecting all peripherals and change the position of peripherals and cables.
  - Changing the all test operation modes of the EUT.
  - On every condition, exploring the highest emissions with the spectrum analyzer.  
(150kHz - 30 MHz, peak detector, RBW: 10 kHz)
8. On the worst condition of the EUT found in above, choose the 6 highest emissions on the spectrum data. The final measurements carried out on these emissions with EMI test receiver.  
(quasi-peak and average detector, RBW: 9 kHz)

Radiated Spurious Emissions

1. The non-conductive table (EUT table) made of ( FRP,  Styrene Foam,  other non-conductive material) was placed in the center of the turntable.
2. The EUT was placed on the center of the tabletop.
3. The test antenna was placed away from the EUT at test distance.
4. The limits compensated the distance factor with follows;
 

9 kHz - 490 kHz [Limit at 3m]	= [Limit at 300m] + 40log (300[m] / 3[m])
490 kHz - 30 MHz [Limit at 3m]	= [Limit at 30m] + 40log (30[m] / 3[m])
5. Find the worst arrangement of the EUT as follows;
  - Rotate the turntable and/or scanning the antenna.
  - On every condition, explore the highest emissions with the spectrum analyzer.  
(9 kHz - 25 GHz, peak detector)

6. On the worst arrangement of the EUT found in above, choose the three highest harmonics or spurious emissions on the spectrum data.(\*excluding carrier band edges)  
 The final measurements are performed with all test operating modes for these emissions as follows;

The test antenna and the turntable were performed with follows;

	9 kHz - 30 MHz	30 MHz - 1000 MHz	1 GHz - 25 GHz
Antenna	Loop Antenna	Bi-conical Antenna, Log-periodic Antenna	Horn Antenna
Antenna scanning range	1m, Vertical, 360 degrees	1 - 4m, Horizontal and Vertical	1 - 4m *, Horizontal and Vertical
Turntable rotating range	360 degrees	360 degrees	360 degrees

\*: When the measurement frequencies above 1 GHz, final measurements are performed keeping the antenna in the "cone of radiation" from EUT area and pointed at the area both in azimuth and elevation, with polarization oriented for maximum response.

Instruments settings were carried out with follows;

	9 kHz - 90 kHz 110 kHz - 490 kHz	90 kHz- 110 kHz 490 kHz - 30 MHz	30 MHz - 1000 MHz	1 GHz - 25 GHz
Detector	Peak / Average	Quasi-peak	Quasi-peak	Peak / Average
RBW	200 Hz (6dB) or 9 kHz (6dB) *1	200 Hz (6dB) or 9 kHz (6dB) *1	120 kHz (6dB)	1 MHz (6dB)
VBW	N/A	N/A	N/A	3 MHz (for peak) 10 kHz (for average) *2
Instrument	EMI test receiver	EMI test receiver	EMI test receiver	Spectrum analyzer

\*1: When the measurement frequencies below 150 kHz, RBW: 200 Hz was used.

\*2: VBW setting (for average) was higher than 1/T. (T is the minimum transmission duration)

7. If the final measurement result exceeded the limit in non-restricted band(excluding carrier band edges), the measurement is carried out additionally with follows;

Measurement points

- Fundamental Frequency
- Frequency that exceeded the limit in non-restricted band (excluding carrier band edges)

	9 kHz - 150 kHz	150 kHz - 30 MHz	30 MHz - 25 GHz
Detector	Peak	Peak	Peak
RBW	300 Hz (6dB) *	10 kHz (6dB) *	100 kHz (6dB)
Instrument	Spectrum analyzer	Spectrum analyzer	Spectrum analyzer

\*: Correction factor of RBW was compensated to a measurement result by the following formula.

$$C.F. \text{ of RBW [dB]} = 10 * \log (100 \text{ kHz} / \text{used RBW})$$

8. If the final average measurement result exceeded the limit in the authorized band edge, the integration method is carried out with follows;

	2483.5 - 2485.5 MHz
Detector	Peak
RBW	100 kHz (6dB)
Instrument	Spectrum analyzer
Function	Channel Power (integration BW : 1 MHz)

9. Although these tests were performed other than open field area test site, adequate comparison measurements were confirmed against 30 m open field area test site. Therefore sufficient tests were made to demonstrate that the alternative site produces results that correlate with the ones of tests made in an open field based on KDB 414788 D01.

## 1.5. Test Facility

## Address of Test Facility

Test Facility Name : Sony Global Manufacturing & Operations Corporation  
EMC/ RF Test Laboratory, Main Lab.  
Address : Kisarazu Site 8-4 Shiomi Kisarazu-shi Chiba, 292-0834 Japan  
Phone : +81 438 37 2750

## AC Power-line Conducted Emissions

## Shielded Room

4th Site  EMC Site

## Radiated Spurious Emission

## Semi-Anechoic chamber

4th Site  EMC Site

## Antenna-port Conducted Measurements \*

## Shielded Room

4th Site SR1

\*Note: This item contains the following

- 6dB Bandwidth
- Maximum Peak Conducted Output Power
- Power Spectral Density
- Conducted Spurious Emissions for Band Edge

## A2LA Accreditation for Test Facility

The above test facility has been fully reported to A2LA and accepted as follows:

A2LA Certificate No. : 3203.01  
Cert. Validated Date : 31 Oct 2019

## 1.6. Uncertainty

Test Item	Frequency	4th Site SR1
Conducted Output Power	1 - 6 GHz	± 0.84 dB
Power Spectral Density, Conducted Spurious Emissions	below 6 GHz	± 1.25 dB

Test Item	Frequency	Distance	4th Site
AC Power-line Conducted Emissions	150kHz - 30MHz	-	± 3.34 dB
Radiated Emissions	9kHz - 30 MHz	3m	± 2.60 dB
	30 - 300 MHz	3m	± 2.61 dB
	300 - 1000 MHz	3m	± 2.59 dB
	1 - 7 GHz	3m	± 2.84 dB
	7 - 18 GHz	3m	± 2.84 dB
	18 - 26.5 GHz	3m	± 2.84 dB

Test Item	Frequency	Distance	EMC Site
AC Power-line Conducted Emissions	150kHz - 30MHz	-	± 3.34 dB
Radiated Emissions	9kHz - 30 MHz	3m	± 3.13 dB
	30 - 300 MHz	3m	± 3.14 dB
	300 - 1000 MHz	3m	± 3.12 dB
	1 - 6 GHz	3m	± 3.33 dB
	6 - 18 GHz	3m	± 3.33 dB
	18 - 26.5 GHz	3m	± 3.33 dB



## 2. System Test Configuration

### 2.1. Validation

The system was configured for testing in a typical (as a customer would normally use it).  
The tests were conducted with the worst case modes as follows.

### 2.2. Test Operating Conditions

The tests have been carried out the following conditions.

Test Items	Operating Mode	Data Rate	Test Channels
AC Power-line Conducted Emissions	Bluetooth Low Energy	1 Mbps	2480 MHz *1
Radiated Spurious Emissions (below 1GHz)	Bluetooth Low Energy	1 Mbps	2442 MHz *1
6dB Bandwidth, Maximum Peak Conducted Output Power, Power Spectral Density, Radiated Spurious Emissions (above 1GHz)	Bluetooth Low Energy	1 Mbps	2402 MHz, 2442 MHz, 2480 MHz
Conducted Spurious Emissions for Band Edge	Bluetooth Low Energy	1 Mbps	2402 MHz

Note:

\*1: The test was performed with the representative mode that had been found as the worst emissions while exploratory testing.

The Software for Operating Mode

Nam : labtool

Version : 2.0.0.59

Special accessories needed for connecting the EUT to achieve compliance:

Item	Manufacturer	Model No.	Serial No.	Remark
Personal Computer	lenovo	X230	38-35674	-
AC Adaptor	lenovo	42T4418	Z1ZGWG08PAWL	-

### 2.3. EUT Modifications

- No equipment modification to achieve compliance to the standard levels was done during the tests.  
 Equipment was modified to achieve compliance to the standard level as below.

Responsible Party Signature

\_\_\_\_\_

Typed/ Print Name :

Responsible Party :

Position :

Date :

## 2.4. Configuration of Tested System

### Antenna-port Conducted Measurements

The equipment under test (EUT)

Symbol	Item	Manufacturer	Model No.	Serial No.
A	Communication Module	SONY	FLE01WBM	1

Support equipment for operation

Symbol	Item	Manufacturer	Model No.	Serial No.
B	JIG Board	-	-	-
C	Regulated DC Power Supply	KENWOOD	PW18-1.3AT	7030091

Type of cable

Symbol	Description	Identification (Manufacturer etc.)	Shielded YES / NO	Ferrite Core	Length (m)	Bundled
1	DC Cable	-	NO	NO	1.0	-
2	DC Cable	-	NO	NO	1.0	-
3	AC Cable	-	NO	NO	2.0	-

### System configuration

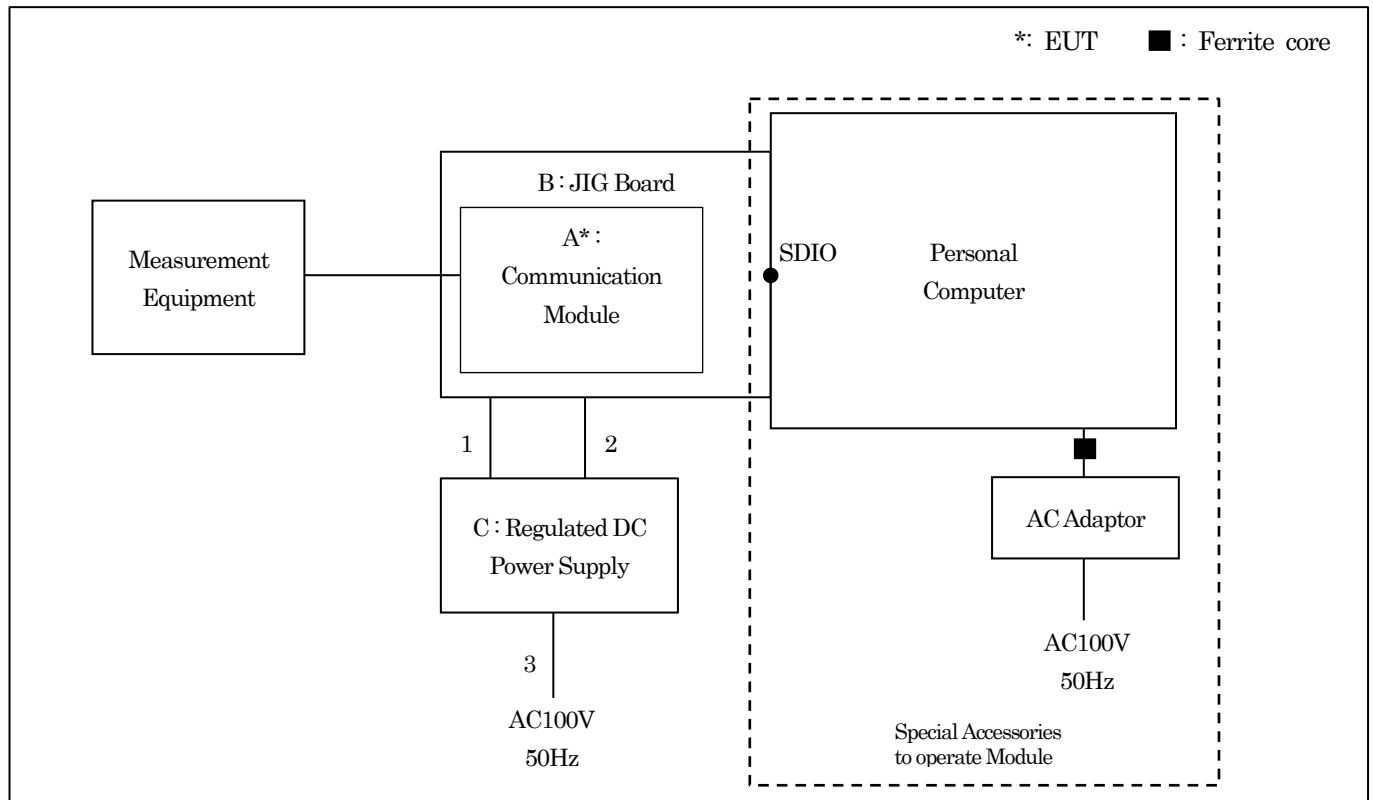

AC Power-line Conducted Emissions

The equipment under test (EUT)

Symbol	Item	Manufacturer	Model No.	Serial No.
A-1	Communication Module	SONY	FLE01WBM	1
A-2	Antenna	SONY	-	-

Support equipment for operation

Symbol	Item	Manufacturer	Model No.	Serial No.
B	JIG Board	-	-	-
C	Regulated DC Power Supply	KENWOOD	PW18-1.3AT	7030091

Type of cable

Symbol	Description	Identification (Manufacturer etc.)	Shielded YES / NO	Ferrite Core	Length (m)	Bundled
1	DC Cable	-	No	No	1.8	-
2	DC Cable	-	No	No	2.0	-
3	AC Cable	-	No	No	2.0	Bundled
4	Antenna Cable	-	No	No	0.5	-

System configuration

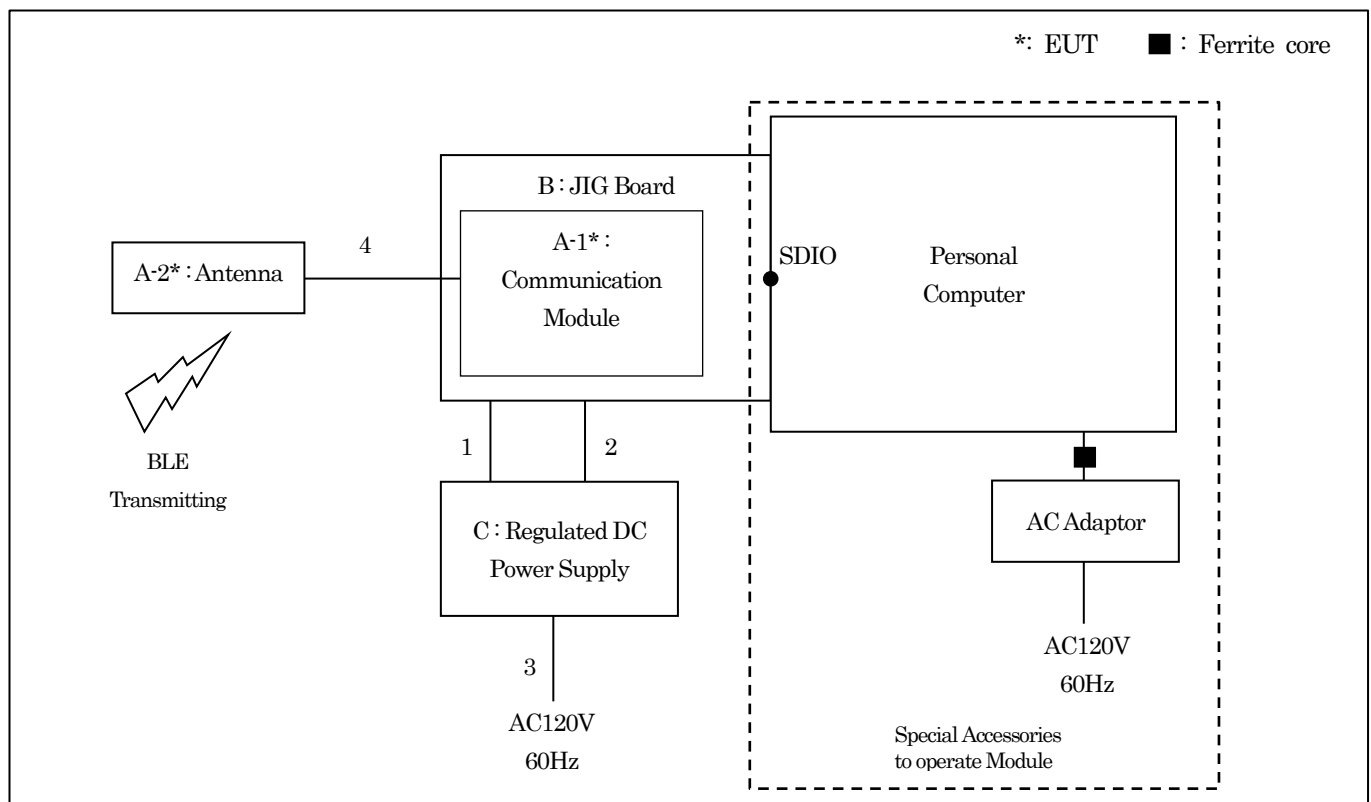

Radiated Spurious Emissions Measurement

The equipment under test (EUT)

Symbol	Item	Manufacturer	Model No.	Serial No.
A-1	Communication Module	SONY	FLE01WBM	1
A-2	Antenna	SONY	-	-

Support equipment for operation

Symbol	Item	Manufacturer	Model No.	Serial No.
B	JIG Board	-	-	-
C	Regulated DC Power Supply	KENWOOD	PWR18-2P	6120013

Type of cable

Symbol	Description	Identification (Manufacturer etc.)	Shielded YES / NO	Ferrite Core	Length (m)	Bundled
1	DC Cable	-	No	No	1.8	-
2	DC Cable	-	No	No	2.0	-
3	AC Cable	-	No	No	2.0	-
4	Antenna Cable	-	No	No	0.5	-

System configuration

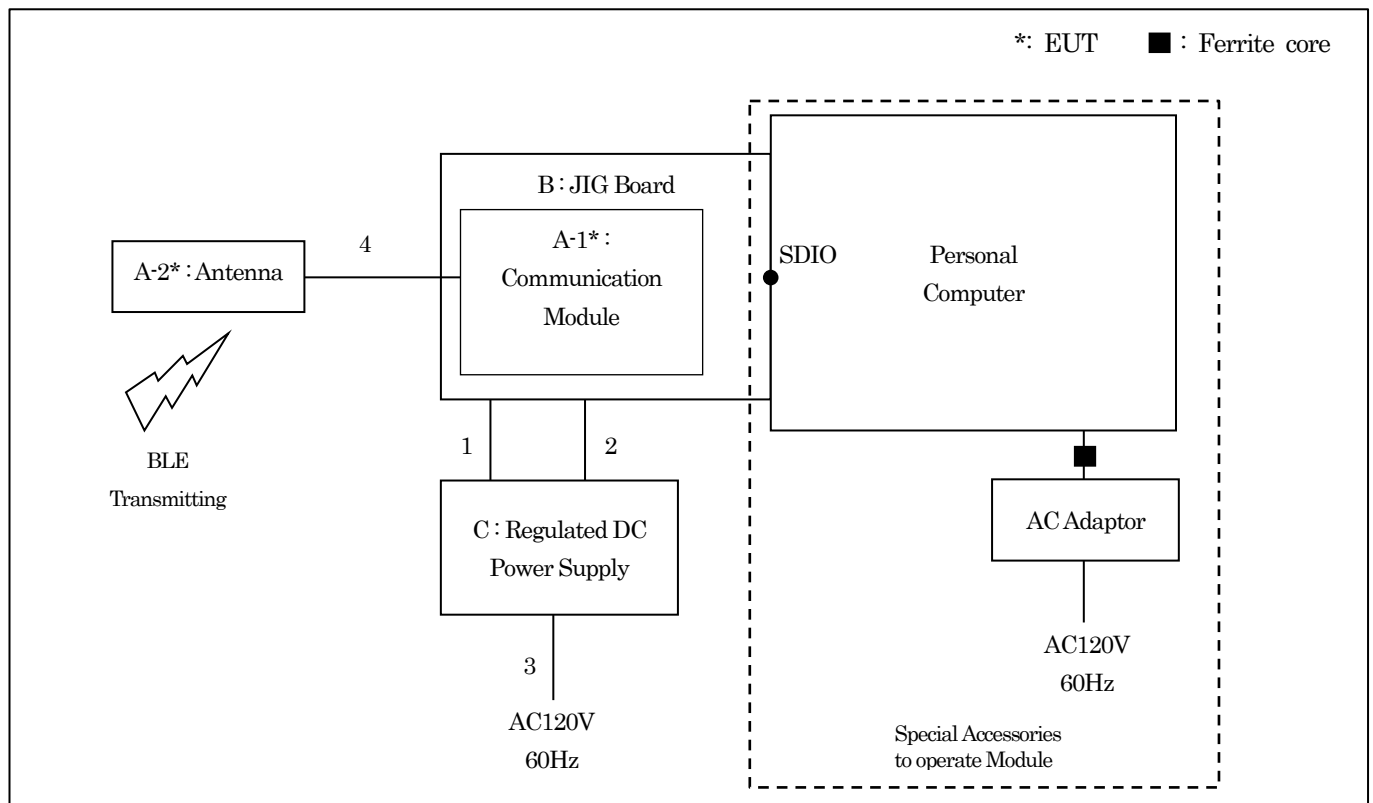

### 3. Test Data

#### 3.1. AC Power-line Conducted Emissions

1) Date of measurement : July 11, 2018

[Bluetooth Low Energy (1 Mbps) / 2480 MHz]

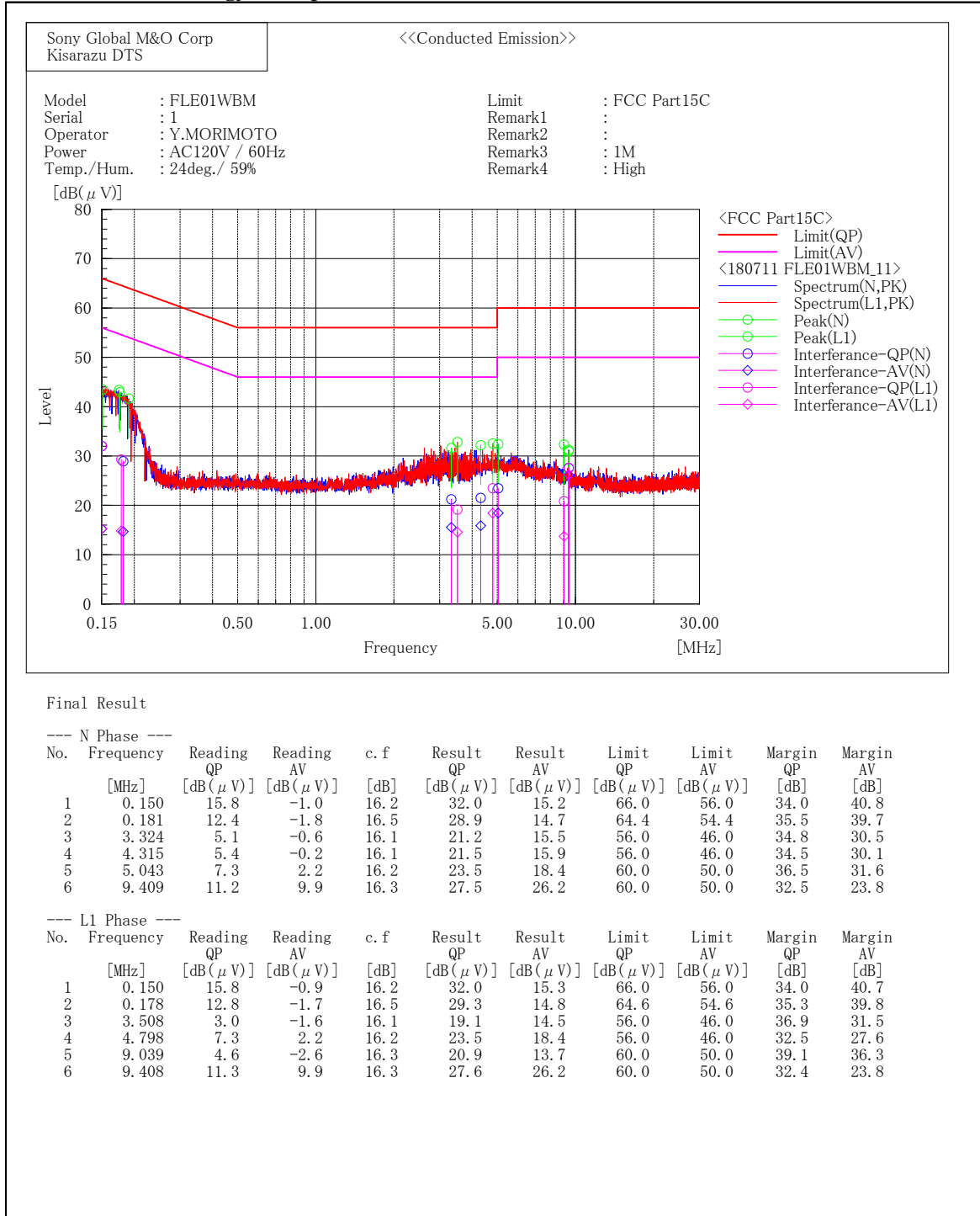

3.2. 6dB Bandwidth

- 1) Ambient temperature : 24.9deg.C
- 2) Relative humidity : 63.6 %
- 3) Date of measurement : May 31, 2018
- 4) Measured by : M.KOUGA
- 5) Operating mode : Transmitting mode

Mode	Rate [Mbps]	Channel [MHz]	Result [MHz]	Limit [MHz]
BLE	1	2402	0.685	0.5
		2442	0.685	0.5
		2480	0.694	0.5

[Bluetooth Low Energy / 2402 MHz]

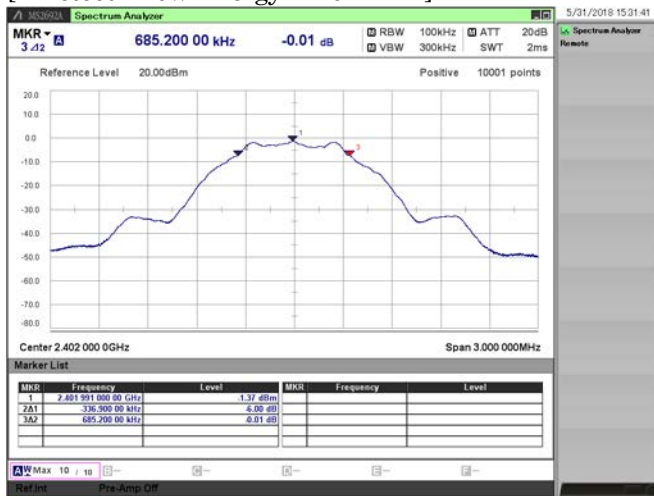

[Bluetooth Low Energy / 2442 MHz]

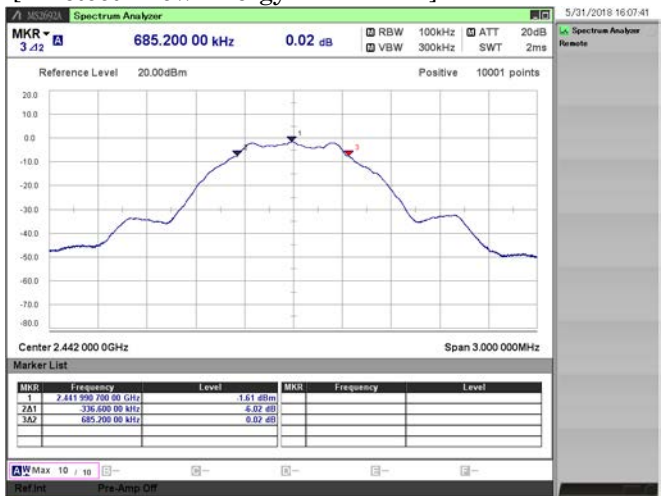

[Bluetooth Low Energy / 2480 MHz]

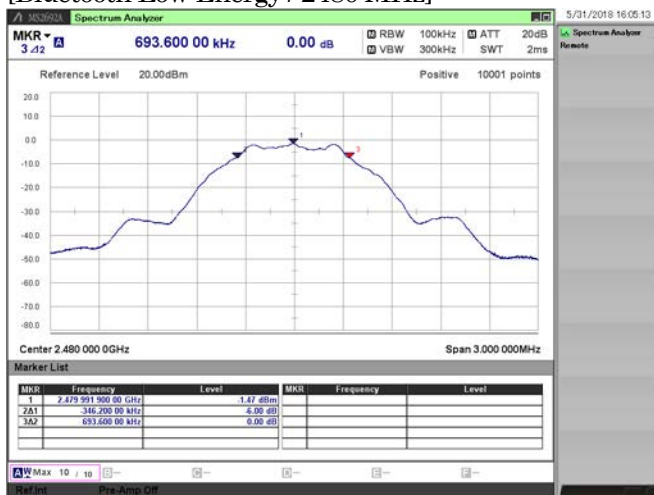

## 3.3. Maximum Peak Conducted Output Power

- 1) Ambient temperature : 24.9deg.C
- 2) Relative humidity : 63.6 %
- 3) Date of measurement : May 31, 2018
- 4) Measured by : M.KOUGA
- 5) Operating mode : Transmitting mode

## Maximum Peak Conducted Output Power

Mode	Rate [Mbps]	Channel [MHz]	Reading(PK) [dBm]	C.F. [dB]	Result(PK) [dBm]	Result(PK) [W]	Limit [dBm]	Margin [dB]
BLE	1	2402	-0.51	0.87	0.36	0.00109	30.0	29.64
		2442	-0.53	0.87	0.34	0.00108	30.0	29.66
		2480	-0.58	0.87	0.29	0.00107	30.0	29.71

## Maximum Average Conducted Output Power (for SAR measurement)

Mode	Rate [Mbps]	Channel [MHz]	Reading(AV) [dBm]	C.F. [dB]	Duty Factor [dB]	Result(AV) [dBm]	Result(AV) [W]
BLE	1	2402	-2.77	0.87	2.20	0.30	0.00107
		2442	-2.80	0.87	2.20	0.27	0.00106
		2480	-2.85	0.87	2.20	0.22	0.00105

### 3.4. Power Spectral Density

- 1) Ambient temperature : 24.9deg.C
- 2) Relative humidity : 63.6 %
- 3) Date of measurement : May 31, 2018
- 4) Measured by : M.KOUGA
- 5) Operating mode : Transmitting mode

Mode	Rate [Mbps]	Channel [MHz]	Reading(PK) [dBm]	C.F. [dB]	Result(PK) [dBm]	Limit [dBm]	Margin [dB]
BLE	1	2402	-16.06	0.87	-15.19	8.0	23.19
		2442	-16.33	0.87	-15.46	8.0	23.46
		2480	-16.23	0.87	-15.36	8.0	23.36

[Bluetooth Low Energy / 2402 MHz]

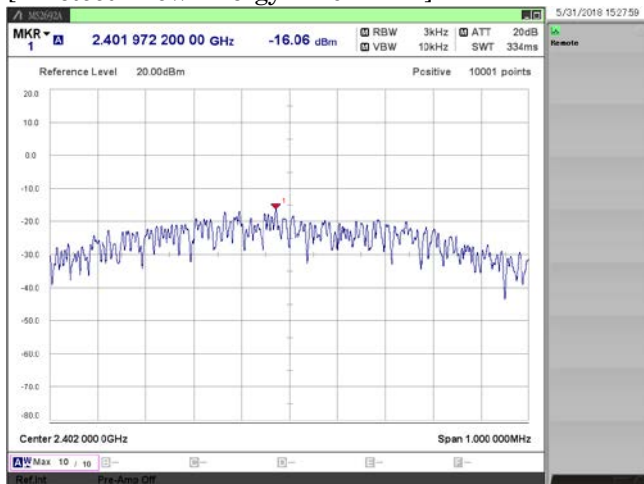

[Bluetooth Low Energy / 2442 MHz]

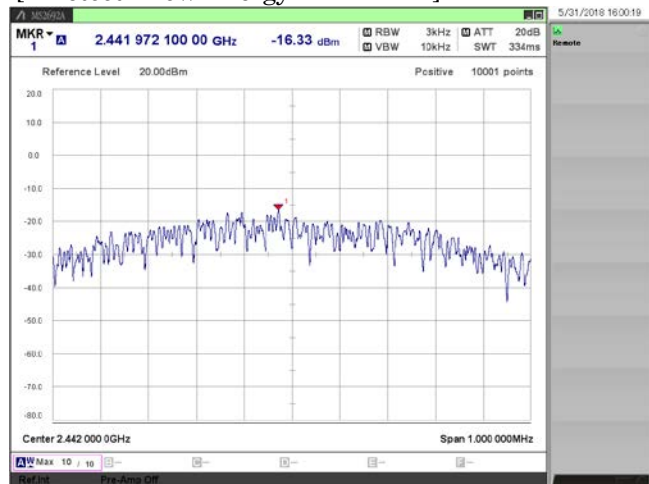

[Bluetooth Low Energy / 2480 MHz]

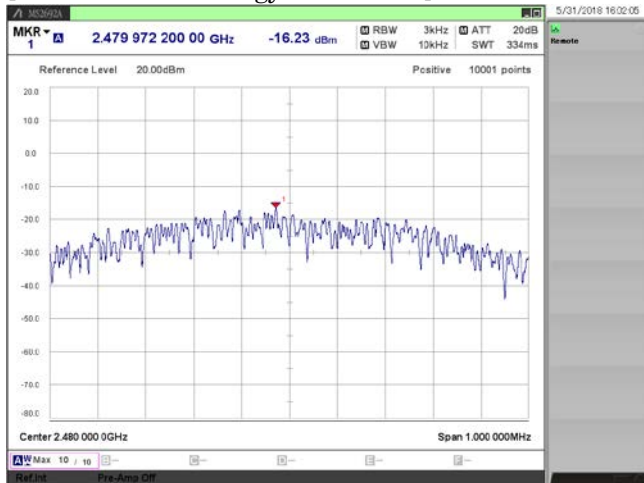



### 3.5. Radiated Spurious Emissions

1) Date of measurement

9 kHz - 30 MHz : June 04, 2018 (all mode)  
 30 MHz - 1000 MHz : July 08, 2018 (all mode)  
 1 GHz - 6GHz : July 18, 2018 (all mode)  
 6GHz - 18GHz : June 02, 2018 (all mode)  
 18GHz - 24.835GHz : June 03, 2018 (all mode)

9 kHz - 30 MHz

[Bluetooth Low Energy (1 Mbps) / 2442 MHz]

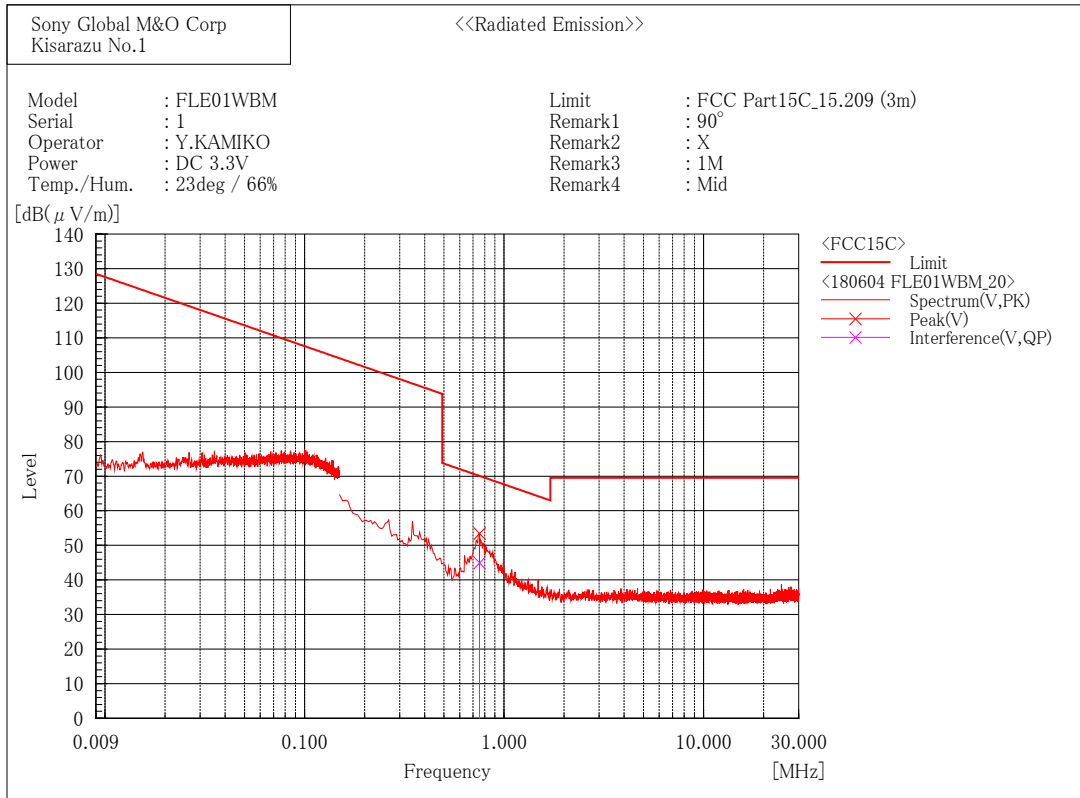

Final Result

--- Vertical Polarization (QP)---

No.	Frequency [MHz]	Reading [dB(μV)]	c.f [dB(1/m)]	Result [dB(μV/m)]	Limit [dB(μV/m)]	Margin [dB]	Height [cm]	Angle [°]
1	0.753	25.4	19.5	44.9	70.1	25.2	100.0	268.0

30 MHz - 1000 MHz  
 [Bluetooth Low Energy (1 Mbps) / 2442 MHz]

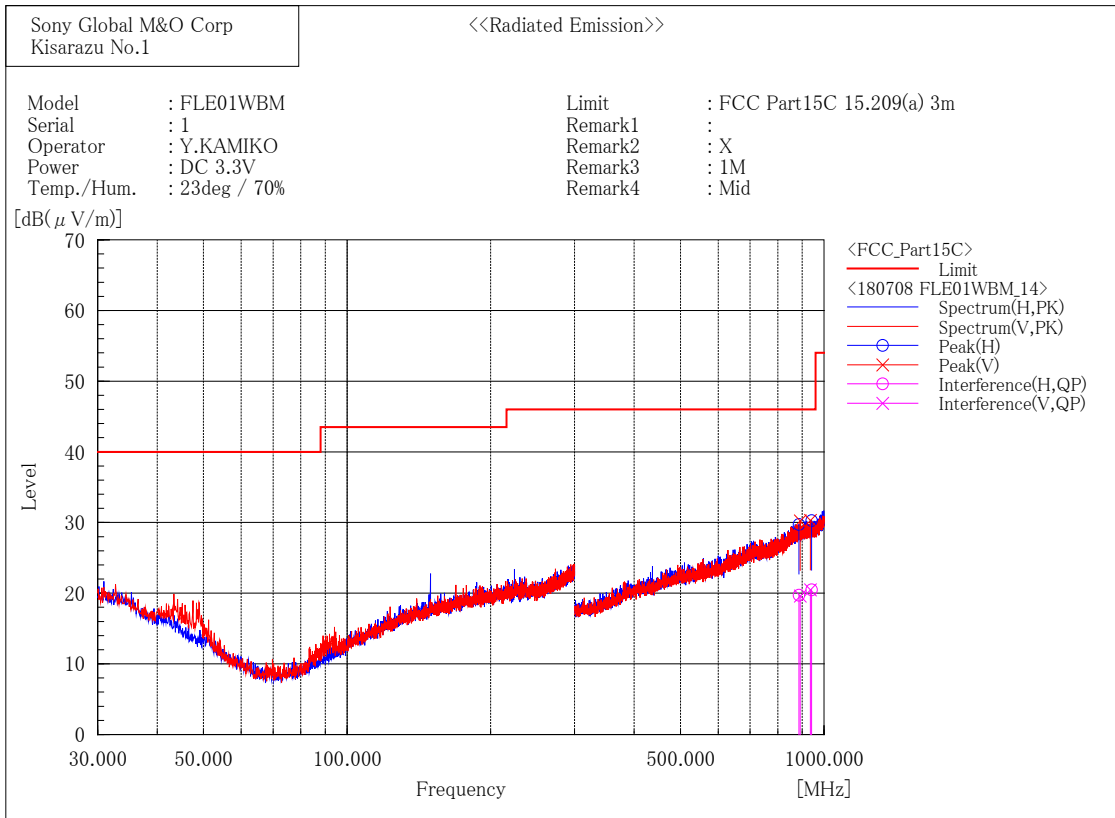

Final Result

--- Horizontal Polarization (QP) ---

No.	Frequency [MHz]	Reading [dB(μV)]	c. f [dB(1/m)]	Result [dB(μV/m)]	Limit [dB(μV/m)]	Margin [dB]	Height [cm]	Angle [°]
1	886.367	19.5	0.2	19.7	46.0	26.3	176.9	281.3
2	942.133	19.4	1.1	20.5	46.0	25.5	282.9	17.2

--- Vertical Polarization (QP) ---

No.	Frequency [MHz]	Reading [dB(μV)]	c. f [dB(1/m)]	Result [dB(μV/m)]	Limit [dB(μV/m)]	Margin [dB]	Height [cm]	Angle [°]
1	890.800	19.3	0.3	19.6	46.0	26.4	400.0	108.0
2	936.067	19.5	1.0	20.5	46.0	25.5	119.0	107.2

1 GHz - 6 GHz

[Bluetooth Low Energy (1 Mbps) / 2402 MHz]

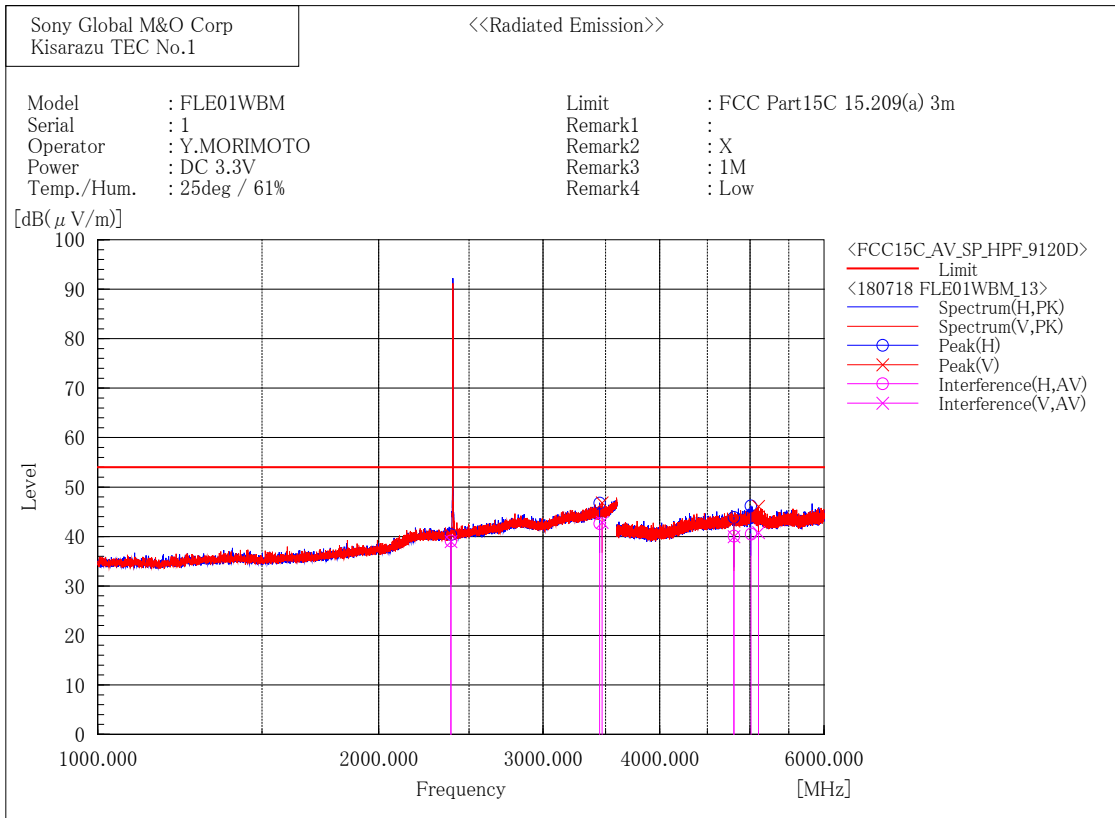

Final Result

--- Horizontal Polarization (AV) ---

No.	Frequency [MHz]	Reading [dB(μV)]	c. f [dB(1/m)]	Result [dB(μV/m)]	Limit [dB(μV/m)]	Margin [dB]	Height [cm]	Angle [°]
1	2390.000	37.6	1.5	39.1	54.0	14.9	200.8	286.7
2	3449.657	37.8	4.8	42.6	54.0	11.4	194.6	291.0
3	4803.995	29.1	11.0	40.1	54.0	13.9	127.0	88.0
4	5010.805	29.1	11.4	40.5	54.0	13.5	314.9	92.0

--- Vertical Polarization (AV) ---

No.	Frequency [MHz]	Reading [dB(μV)]	c. f [dB(1/m)]	Result [dB(μV/m)]	Limit [dB(μV/m)]	Margin [dB]	Height [cm]	Angle [°]
1	2390.000	37.5	1.5	39.0	54.0	15.0	178.5	36.2
2	3470.854	37.9	5.0	42.9	54.0	11.1	364.4	65.8
3	4804.333	29.0	11.0	40.0	54.0	14.0	148.7	58.4
4	5103.686	29.3	11.5	40.8	54.0	13.2	148.1	19.1

[Bluetooth Low Energy (1 Mbps) / 2442 MHz]

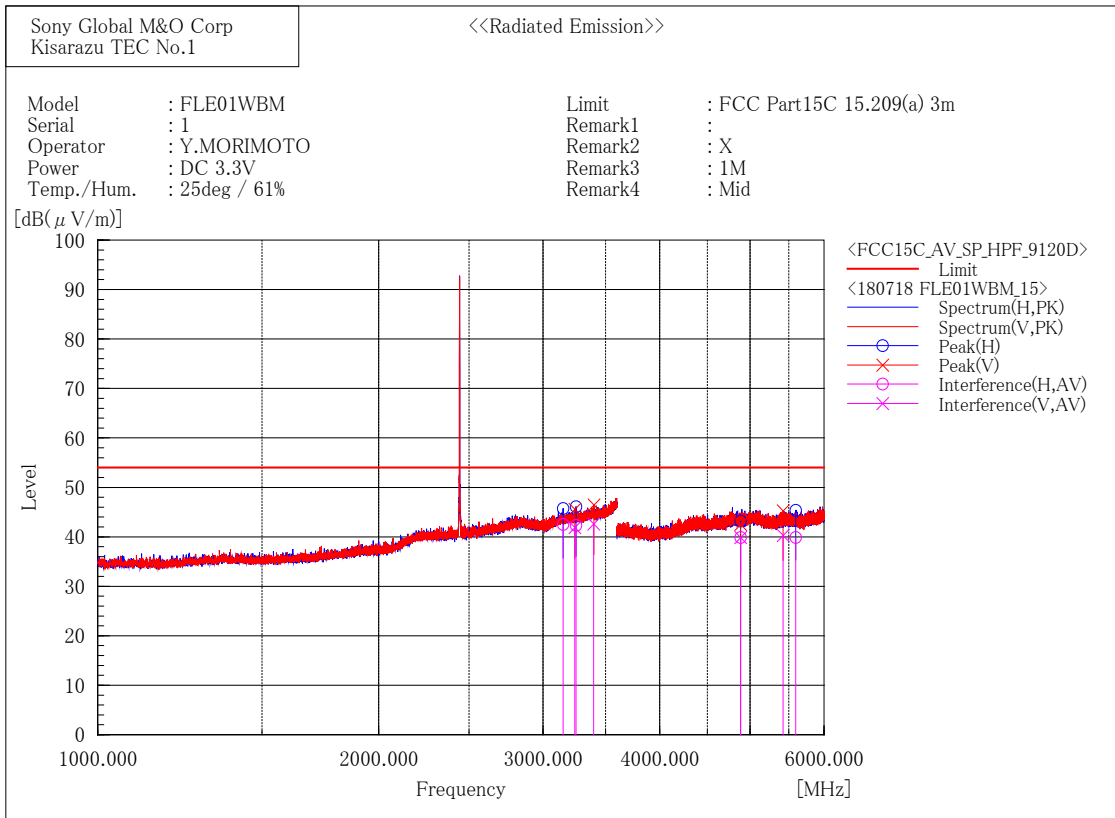

Final Result

--- Horizontal Polarization (AV)---

No.	Frequency [MHz]	Reading [dB(μV)]	c. f [dB(1/m)]	Result [dB(μV/m)]	Limit [dB(μV/m)]	Margin [dB]	Height [cm]	Angle [°]
1	3152.237	38.0	4.5	42.5	54.0	11.5	292.4	53.9
2	3254.298	37.9	4.4	42.3	54.0	11.7	106.9	254.2
3	4883.060	29.2	10.7	39.9	54.0	14.1	247.7	166.1
4	5595.236	28.7	11.2	39.9	54.0	14.1	228.1	265.8

--- Vertical Polarization (AV)---

No.	Frequency [MHz]	Reading [dB(μV)]	c. f [dB(1/m)]	Result [dB(μV/m)]	Limit [dB(μV/m)]	Margin [dB]	Height [cm]	Angle [°]
1	3244.420	37.5	4.4	41.9	54.0	12.1	219.1	273.9
2	3399.915	38.0	4.6	42.6	54.0	11.4	216.6	199.7
3	4884.412	29.2	10.7	39.9	54.0	14.1	177.2	154.4
4	5423.760	29.0	11.3	40.3	54.0	13.7	143.4	178.0

[Bluetooth Low Energy (1 Mbps) / 2480 MHz]

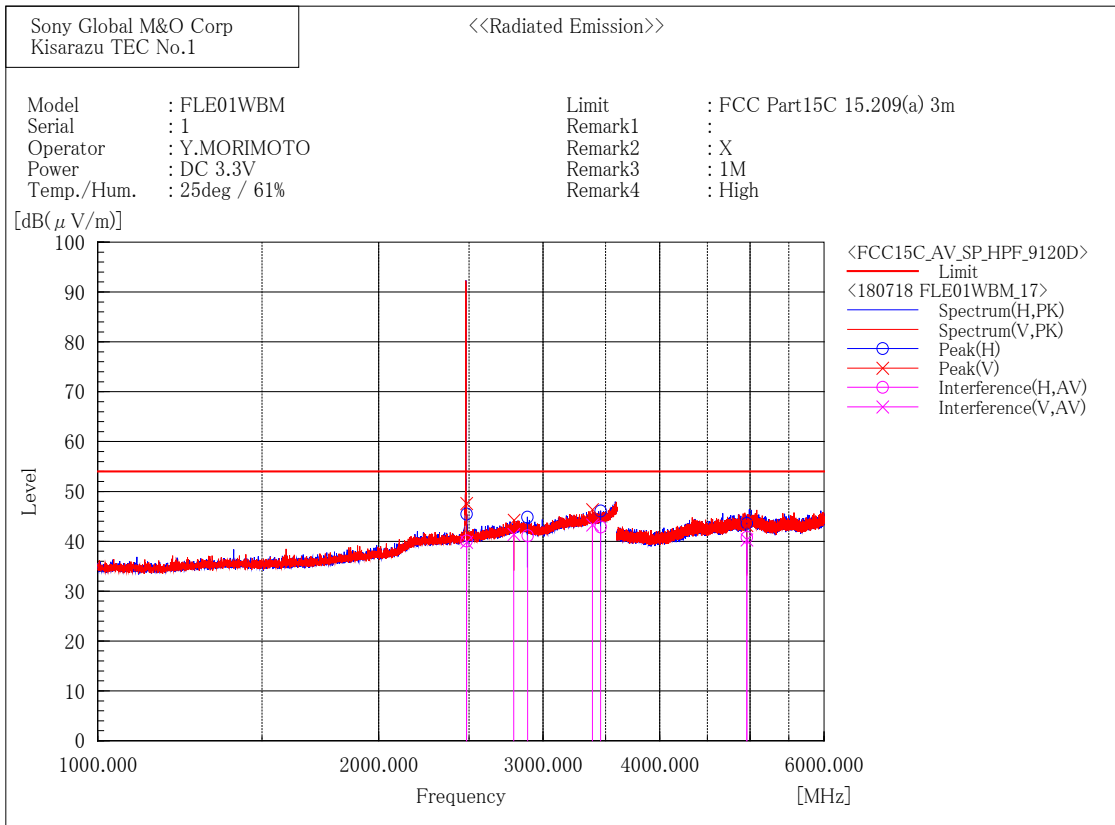

Final Result

--- Horizontal Polarization (AV)---

No.	Frequency [MHz]	Reading [dB(μV)]	c. f [dB(1/m)]	Result [dB(μV/m)]	Limit [dB(μV/m)]	Margin [dB]	Height [cm]	Angle [°]
1	2483.500	38.2	1.9	40.1	54.0	14.0	100.0	88.0
2	2887.363	37.5	3.6	41.1	54.0	12.9	184.7	159.5
3	3458.292	38.0	4.9	42.9	54.0	11.1	386.3	176.1
4	4959.682	29.8	11.0	40.8	54.0	13.2	114.7	20.2

--- Vertical Polarization (AV)---

No.	Frequency [MHz]	Reading [dB(μV)]	c. f [dB(1/m)]	Result [dB(μV/m)]	Limit [dB(μV/m)]	Margin [dB]	Height [cm]	Angle [°]
1	2483.500	37.9	1.9	39.8	54.0	14.2	374.7	320.2
2	2791.609	38.1	3.3	41.4	54.0	12.6	161.7	119.3
3	3388.108	38.7	4.6	43.3	54.0	10.7	184.7	126.3
4	4959.528	29.3	11.0	40.3	54.0	13.7	100.0	333.9

[Bluetooth Low Energy (1 Mbps) / 2402 MHz]

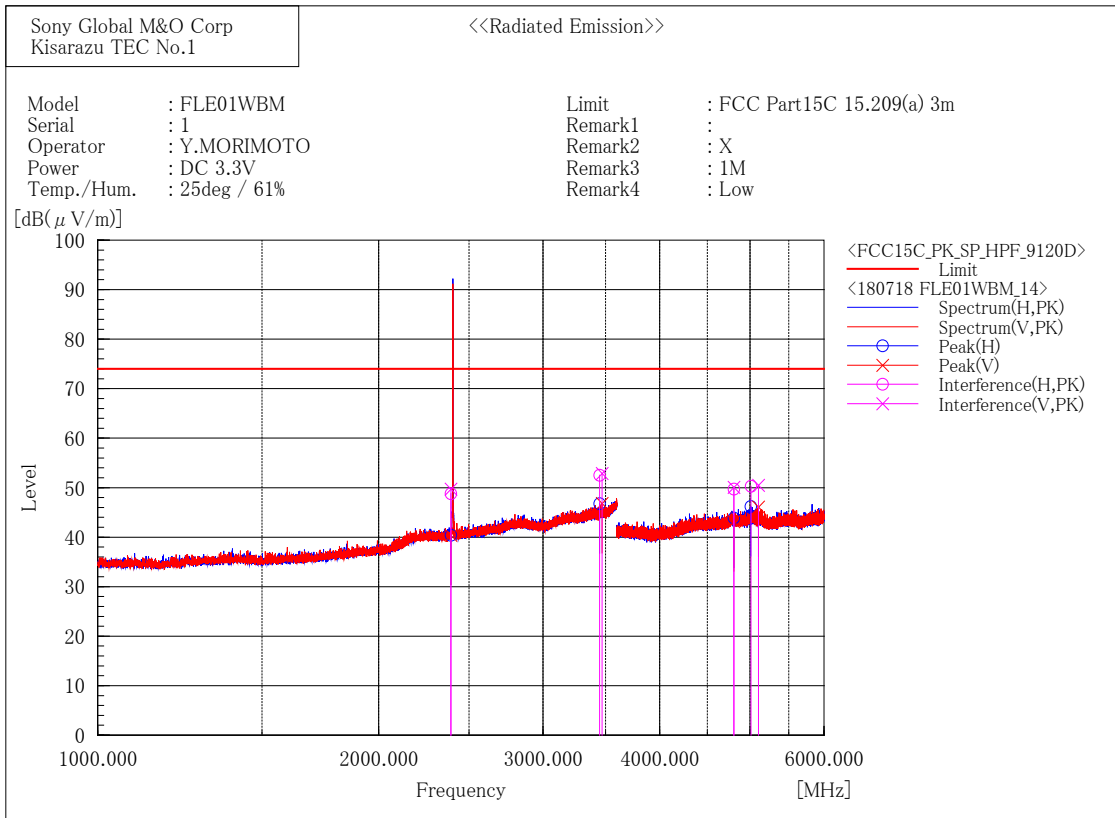

Final Result

--- Horizontal Polarization (PK)---

No.	Frequency [MHz]	Reading [dB(μV)]	c. f [dB(1/m)]	Result [dB(μV/m)]	Limit [dB(μV/m)]	Margin [dB]	Height [cm]	Angle [°]
1	2390.000	47.3	1.5	48.8	74.0	25.2	200.8	288.7
2	3448.784	47.7	4.8	52.5	74.0	21.5	194.6	289.8
3	4804.844	38.7	11.0	49.7	74.0	24.3	127.0	86.0
4	5011.145	38.9	11.4	50.3	74.0	23.7	314.9	90.8

--- Vertical Polarization (PK)---

No.	Frequency [MHz]	Reading [dB(μV)]	c. f [dB(1/m)]	Result [dB(μV/m)]	Limit [dB(μV/m)]	Margin [dB]	Height [cm]	Angle [°]
1	2390.000	48.2	1.5	49.7	74.0	24.3	178.5	38.1
2	3471.171	47.9	5.0	52.9	74.0	21.1	364.4	64.3
3	4804.608	39.1	11.0	50.1	74.0	23.9	148.7	56.4
4	5103.891	39.0	11.5	50.5	74.0	23.5	148.1	17.2

[Bluetooth Low Energy (1 Mbps) / 2442 MHz]

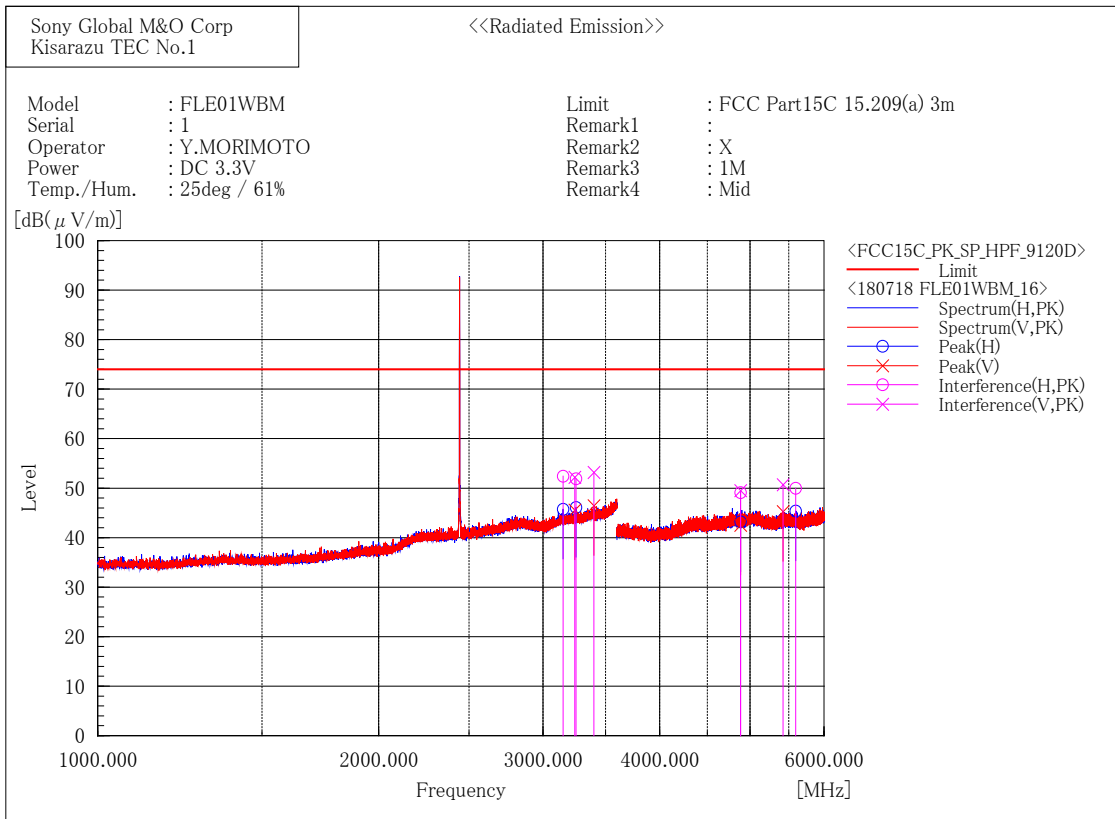

Final Result

--- Horizontal Polarization (PK)---

No.	Frequency [MHz]	Reading [dB(μV)]	c. f [dB(1/m)]	Result [dB(μV/m)]	Limit [dB(μV/m)]	Margin [dB]	Height [cm]	Angle [°]
1	3152.934	47.9	4.5	52.4	74.0	21.6	292.4	52.0
2	3253.835	47.5	4.4	51.9	74.0	22.1	106.9	252.1
3	4883.444	38.4	10.7	49.1	74.0	24.9	247.7	168.2
4	5593.994	38.8	11.2	50.0	74.0	24.0	228.1	265.8

--- Vertical Polarization (PK)---

No.	Frequency [MHz]	Reading [dB(μV)]	c. f [dB(1/m)]	Result [dB(μV/m)]	Limit [dB(μV/m)]	Margin [dB]	Height [cm]	Angle [°]
1	3245.197	47.8	4.4	52.2	74.0	21.8	219.1	275.8
2	3400.181	48.6	4.6	53.2	74.0	20.8	216.6	201.7
3	4884.691	38.8	10.7	49.5	74.0	24.5	177.2	156.5
4	5424.117	39.4	11.3	50.7	74.0	23.3	143.4	176.0

[Bluetooth Low Energy (1 Mbps) / 2480 MHz]

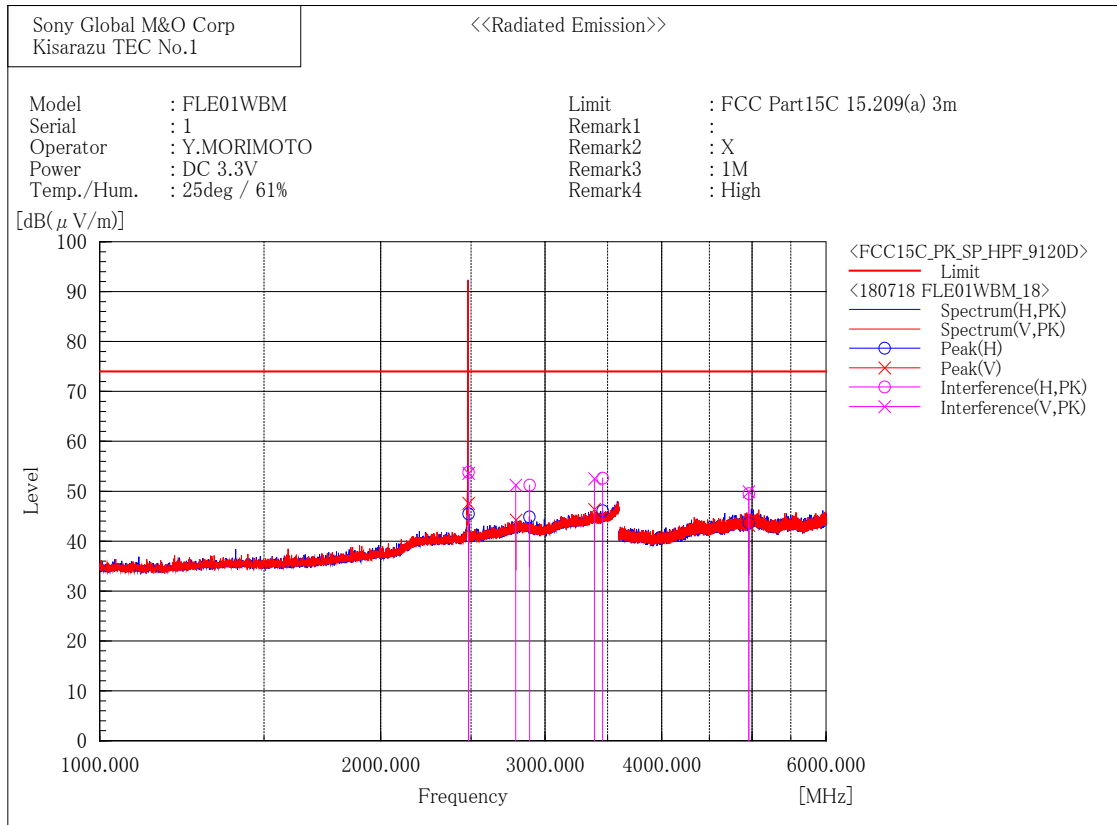

Final Result

--- Horizontal Polarization (PK)---

No.	Frequency [MHz]	Reading [dB(μV)]	c. f [dB(1/m)]	Result [dB(μV/m)]	Limit [dB(μV/m)]	Margin [dB]	Height [cm]	Angle [°]
1	2483.500	51.9	1.9	53.8	74.0	20.3	100.0	89.9
2	2887.505	47.6	3.6	51.2	74.0	22.8	184.7	157.5
3	3458.660	47.7	4.9	52.6	74.0	21.4	386.3	174.2
4	4959.166	38.5	11.0	49.5	74.0	24.5	114.7	22.2

--- Vertical Polarization (PK)---

No.	Frequency [MHz]	Reading [dB(μV)]	c. f [dB(1/m)]	Result [dB(μV/m)]	Limit [dB(μV/m)]	Margin [dB]	Height [cm]	Angle [°]
1	2483.500	51.7	1.9	53.6	74.0	20.4	374.7	322.2
2	2791.094	47.9	3.3	51.2	74.0	22.8	161.7	117.1
3	3387.626	47.9	4.6	52.5	74.0	21.5	184.7	124.8
4	4960.394	38.9	11.0	49.9	74.0	24.1	100.0	335.8



6 GHz - 18 GHz  
 [Bluetooth Low Energy (1 Mbps) / 2402 MHz]

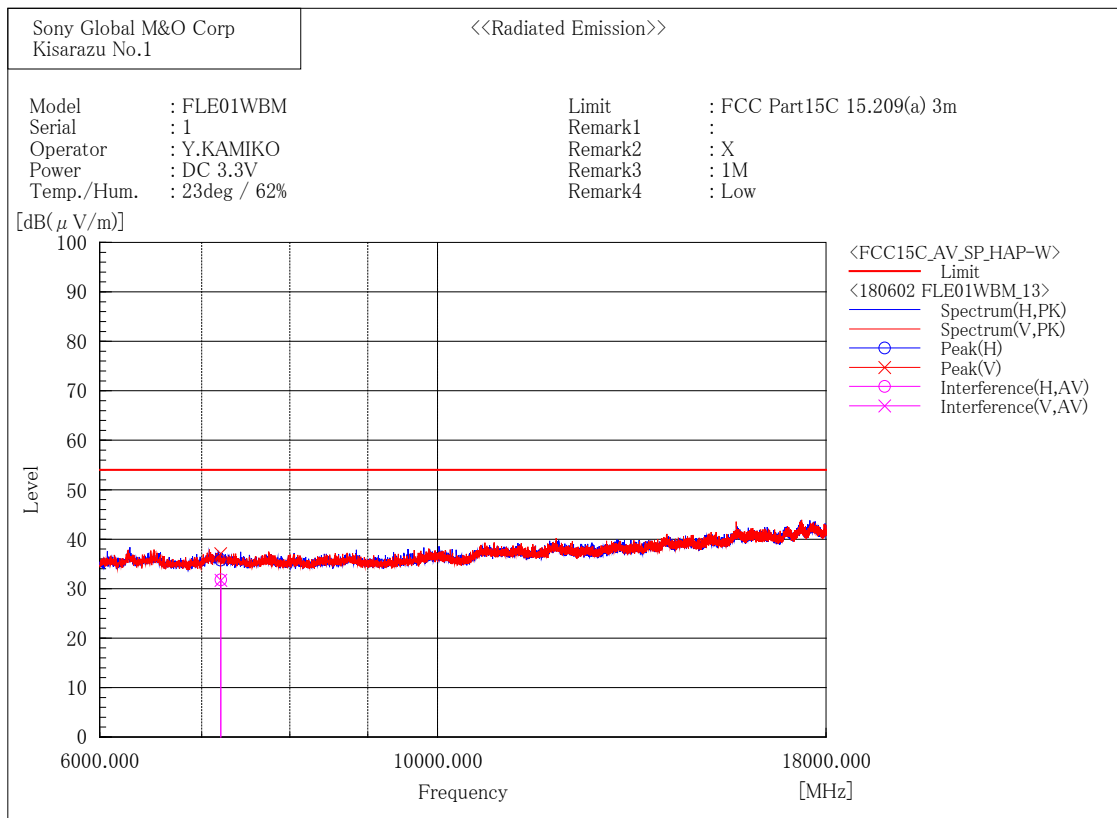

Final Result

--- Horizontal Polarization (AV)---

No.	Frequency [MHz]	Reading [dB(μV)]	c. f [dB(1/m)]	Result [dB(μV/m)]	Limit [dB(μV/m)]	Margin [dB]	Height [cm]	Angle [°]
1	7205.370	40.9	-9.1	31.8	54.0	22.2	358.0	45.0

--- Vertical Polarization (AV)---

No.	Frequency [MHz]	Reading [dB(μV)]	c. f [dB(1/m)]	Result [dB(μV/m)]	Limit [dB(μV/m)]	Margin [dB]	Height [cm]	Angle [°]
1	7206.266	40.8	-9.1	31.7	54.0	22.3	393.0	169.4

[Bluetooth Low Energy (1 Mbps) / 2442 MHz]

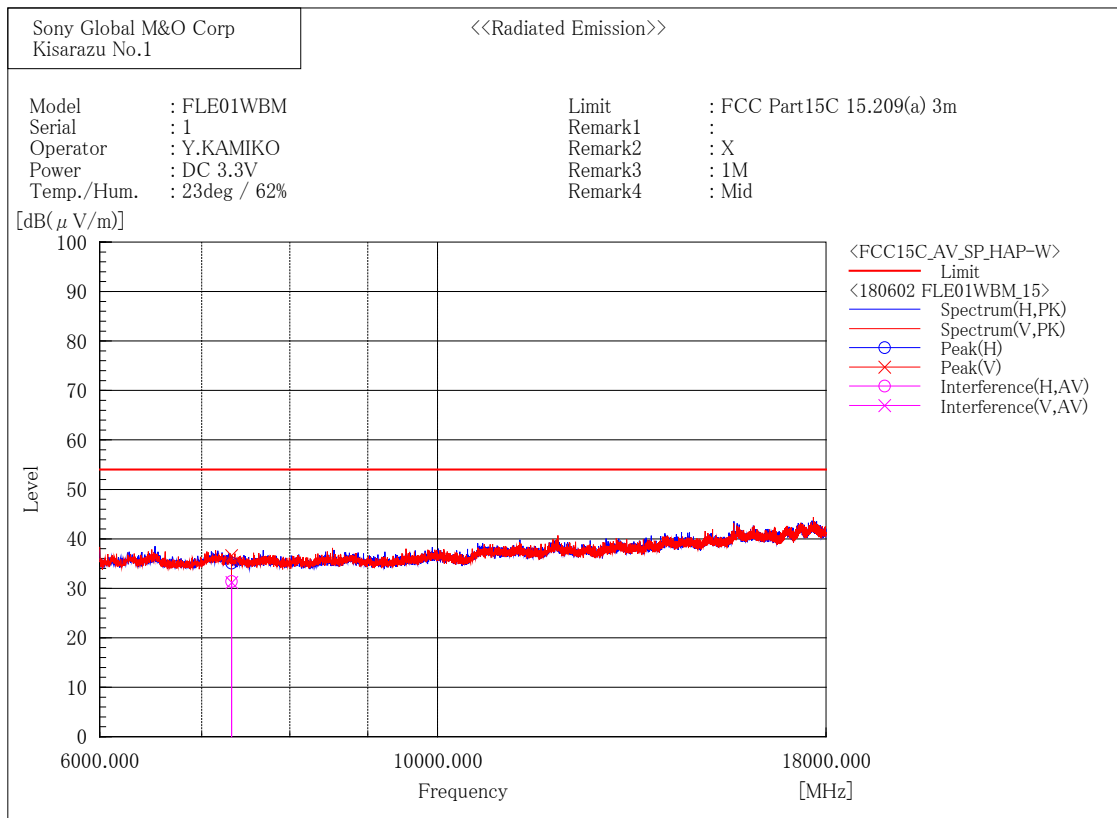

Final Result

--- Horizontal Polarization (AV)---

No.	Frequency [MHz]	Reading [dB(μV)]	c. f [dB(1/m)]	Result [dB(μV/m)]	Limit [dB(μV/m)]	Margin [dB]	Height [cm]	Angle [°]
1	7325.162	41.0	-9.6	31.4	54.0	22.6	378.0	33.0

--- Vertical Polarization (AV)---

No.	Frequency [MHz]	Reading [dB(μV)]	c. f [dB(1/m)]	Result [dB(μV/m)]	Limit [dB(μV/m)]	Margin [dB]	Height [cm]	Angle [°]
1	7325.657	40.8	-9.6	31.2	54.0	22.8	354.8	150.0

[Bluetooth Low Energy (1 Mbps) / 2480 MHz]

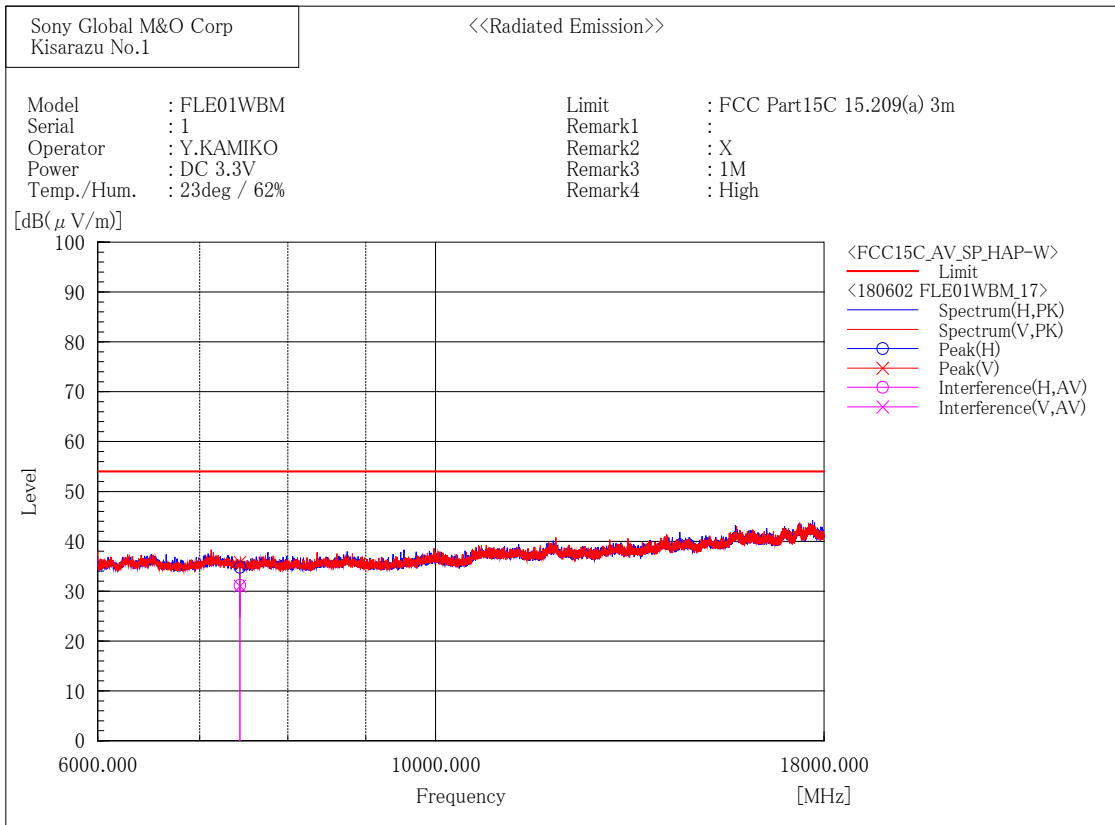

Final Result

--- Horizontal Polarization (AV)---

No.	Frequency [MHz]	Reading [dB(μV)]	c. f [dB(1/m)]	Result [dB(μV/m)]	Limit [dB(μV/m)]	Margin [dB]	Height [cm]	Angle [°]
1	7439.024	41.0	-9.8	31.2	54.0	22.8	347.0	43.9

--- Vertical Polarization (AV)---

No.	Frequency [MHz]	Reading [dB(μV)]	c. f [dB(1/m)]	Result [dB(μV/m)]	Limit [dB(μV/m)]	Margin [dB]	Height [cm]	Angle [°]
1	7440.670	40.8	-9.8	31.0	54.0	23.0	341.6	144.5

[Bluetooth Low Energy (1 Mbps) / 2402 MHz]

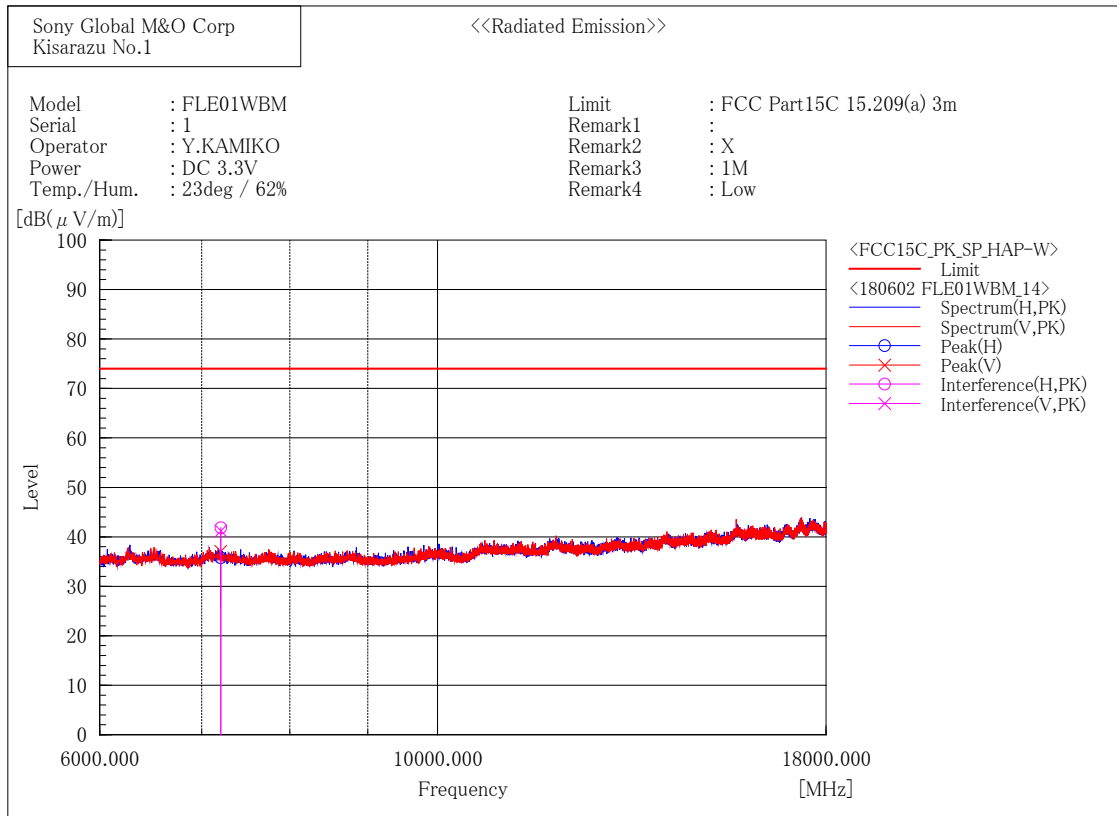

Final Result

--- Horizontal Polarization (PK)---

No.	Frequency [MHz]	Reading [dB(μV)]	c. f [dB(1/m)]	Result [dB(μV/m)]	Limit [dB(μV/m)]	Margin [dB]	Height [cm]	Angle [°]
1	7205.658	50.9	-9.1	41.8	74.0	32.2	358.0	45.0

--- Vertical Polarization (PK)---

No.	Frequency [MHz]	Reading [dB(μV)]	c. f [dB(1/m)]	Result [dB(μV/m)]	Limit [dB(μV/m)]	Margin [dB]	Height [cm]	Angle [°]
1	7205.263	50.3	-9.1	41.2	74.0	32.8	367.1	157.4

[Bluetooth Low Energy (1 Mbps) / 2442 MHz]

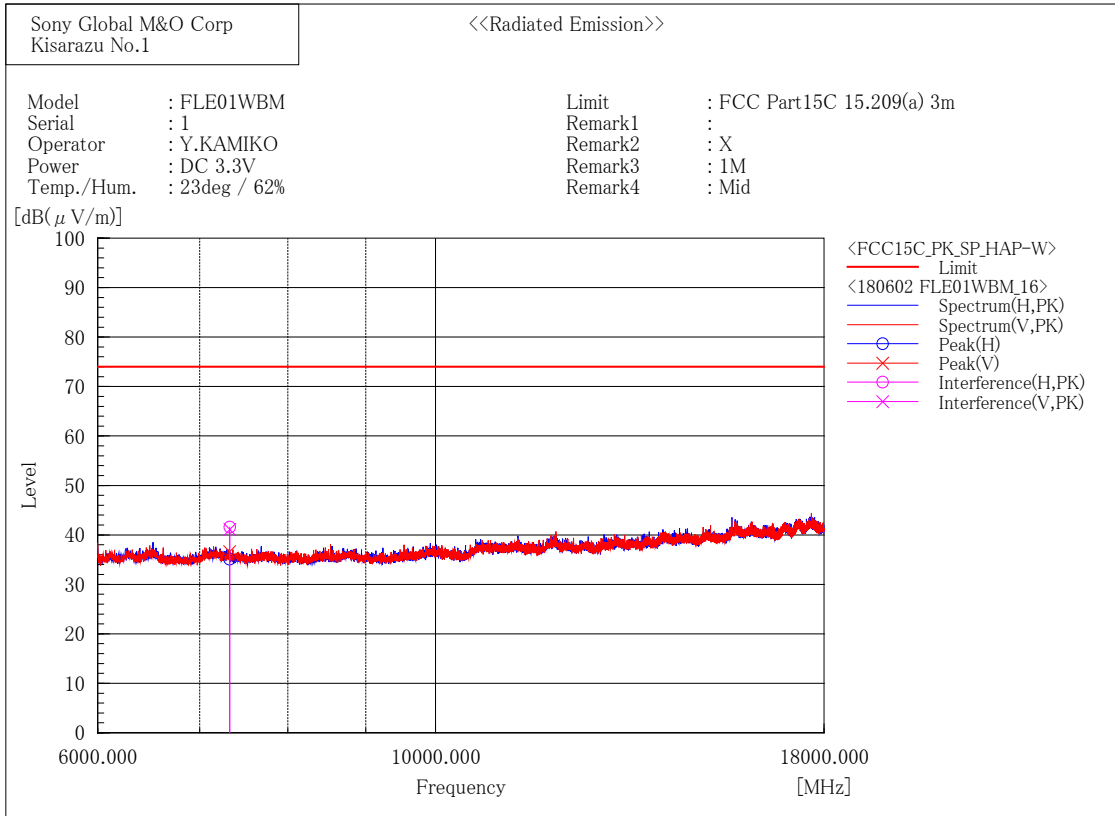

Final Result

--- Horizontal Polarization (PK)---

No.	Frequency [MHz]	Reading [dB(μV)]	c. f [dB(1/m)]	Result [dB(μV/m)]	Limit [dB(μV/m)]	Margin [dB]	Height [cm]	Angle [°]
1	7325.908	51.2	-9.6	41.6	74.0	32.4	379.0	11.1

--- Vertical Polarization (PK)---

No.	Frequency [MHz]	Reading [dB(μV)]	c. f [dB(1/m)]	Result [dB(μV/m)]	Limit [dB(μV/m)]	Margin [dB]	Height [cm]	Angle [°]
1	7325.799	50.7	-9.6	41.1	74.0	32.9	354.8	150.0

[Bluetooth Low Energy (1 Mbps) / 2480 MHz]

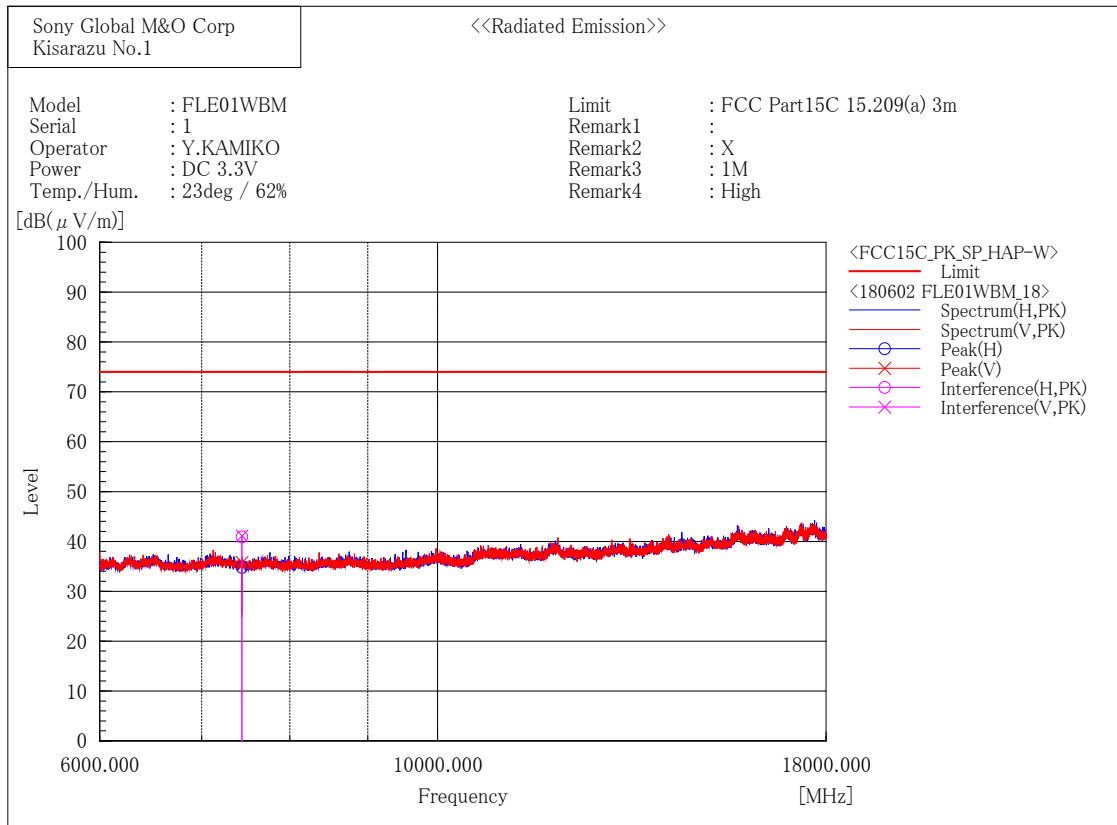

Final Result

--- Horizontal Polarization (PK)---

No.	Frequency [MHz]	Reading [dB(μV)]	c. f [dB(1/m)]	Result [dB(μV/m)]	Limit [dB(μV/m)]	Margin [dB]	Height [cm]	Angle [°]
1	7439.141	50.7	-9.8	40.9	74.0	33.1	347.0	43.9

--- Vertical Polarization (PK)---

No.	Frequency [MHz]	Reading [dB(μV)]	c. f [dB(1/m)]	Result [dB(μV/m)]	Limit [dB(μV/m)]	Margin [dB]	Height [cm]	Angle [°]
1	7440.150	50.9	-9.8	41.1	74.0	32.9	391.0	178.8

18 GHz - 24.835 GHz  
 [Bluetooth Low Energy (1 Mbps) / 2402 MHz]

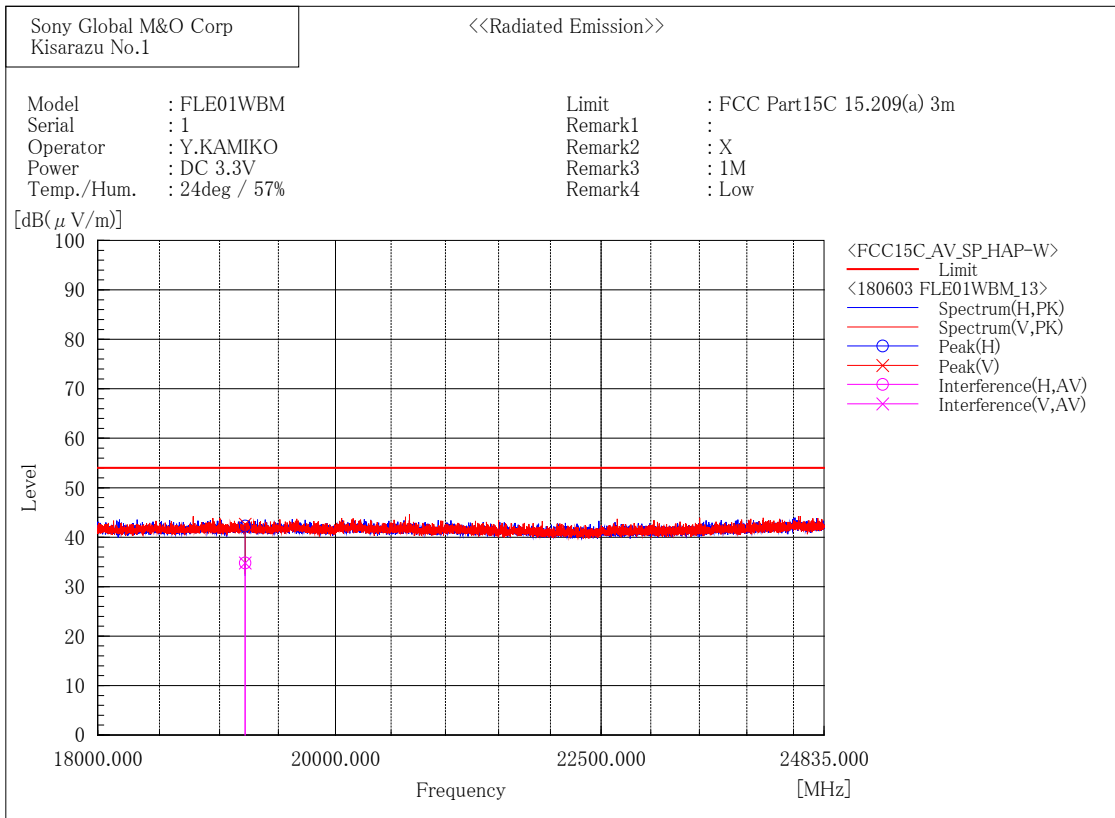

Final Result

--- Horizontal Polarization (AV) ---

No.	Frequency [MHz]	Reading [dB(μV)]	c. f [dB(1/m)]	Result [dB(μV/m)]	Limit [dB(μV/m)]	Margin [dB]	Height [cm]	Angle [°]
1	19215.878	29.4	5.4	34.8	54.0	19.2	353.0	125.9

--- Vertical Polarization (AV) ---

No.	Frequency [MHz]	Reading [dB(μV)]	c. f [dB(1/m)]	Result [dB(μV/m)]	Limit [dB(μV/m)]	Margin [dB]	Height [cm]	Angle [°]
1	19216.222	29.4	5.4	34.8	54.0	19.2	416.4	129.4

[Bluetooth Low Energy (1 Mbps) / 2442 MHz]

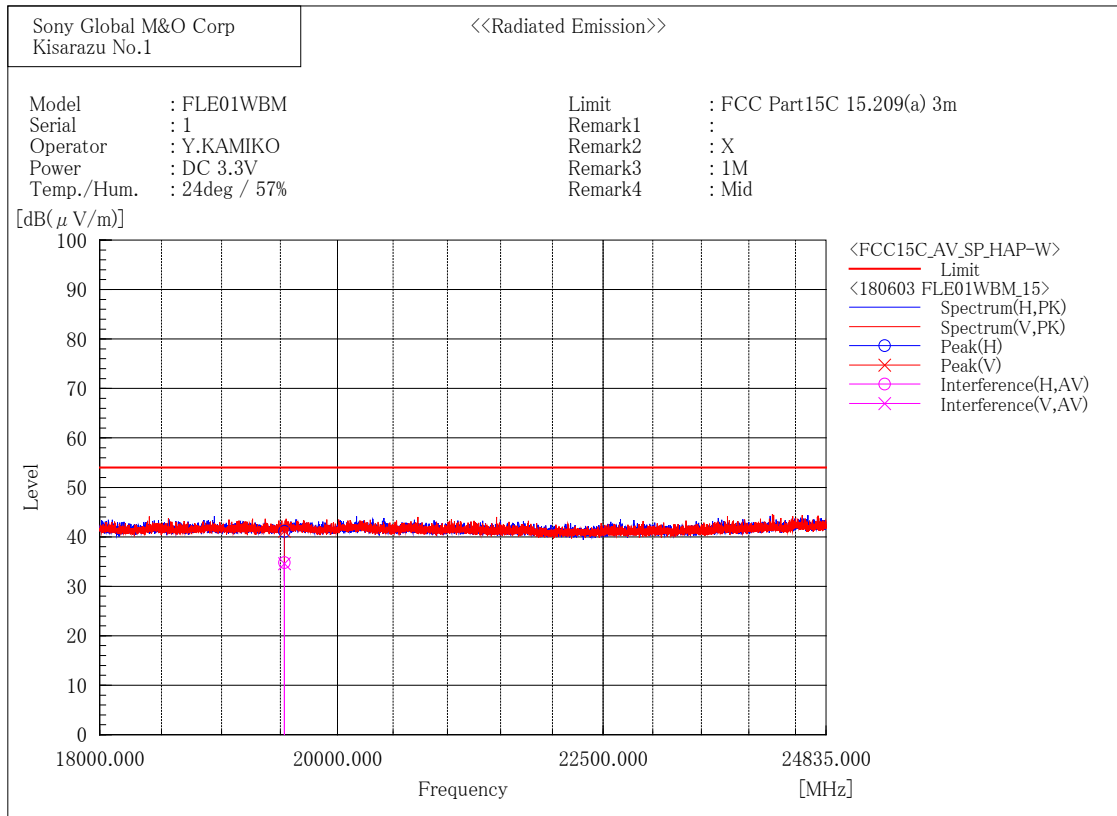

Final Result

--- Horizontal Polarization (AV)---

No.	Frequency [MHz]	Reading [dB(μV)]	c. f [dB(1/m)]	Result [dB(μV/m)]	Limit [dB(μV/m)]	Margin [dB]	Height [cm]	Angle [°]
1	19535.036	29.3	5.5	34.8	54.0	19.2	431.0	214.7

--- Vertical Polarization (AV)---

No.	Frequency [MHz]	Reading [dB(μV)]	c. f [dB(1/m)]	Result [dB(μV/m)]	Limit [dB(μV/m)]	Margin [dB]	Height [cm]	Angle [°]
1	19536.194	29.1	5.5	34.6	54.0	19.4	135.6	148.5



[Bluetooth Low Energy (1 Mbps) / 2480 MHz]

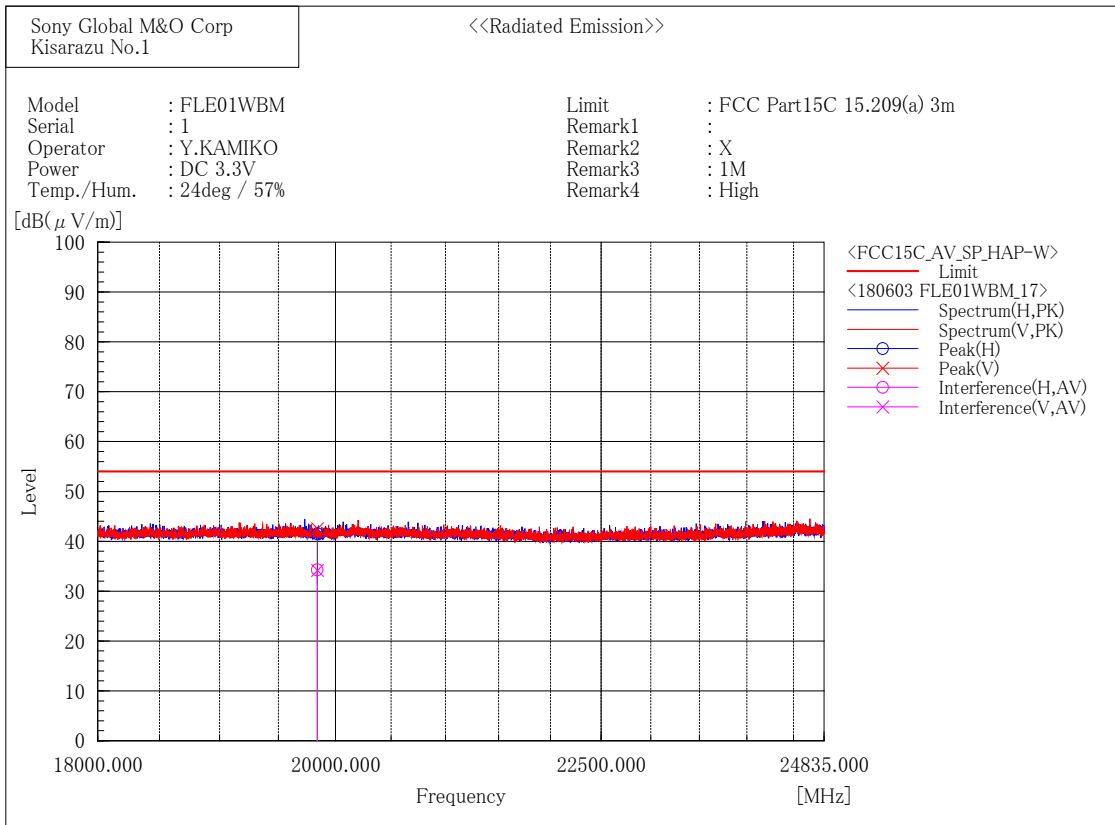

Final Result

--- Horizontal Polarization (AV)---

No.	Frequency [MHz]	Reading [dB(μV)]	c. f [dB(1/m)]	Result [dB(μV/m)]	Limit [dB(μV/m)]	Margin [dB]	Height [cm]	Angle [°]
1	19839.170	28.8	5.5	34.3	54.0	19.7	211.5	164.4

--- Vertical Polarization (AV)---

No.	Frequency [MHz]	Reading [dB(μV)]	c. f [dB(1/m)]	Result [dB(μV/m)]	Limit [dB(μV/m)]	Margin [dB]	Height [cm]	Angle [°]
1	19841.102	28.7	5.5	34.2	54.0	19.8	258.2	132.5

[Bluetooth Low Energy (1 Mbps) / 2402 MHz]

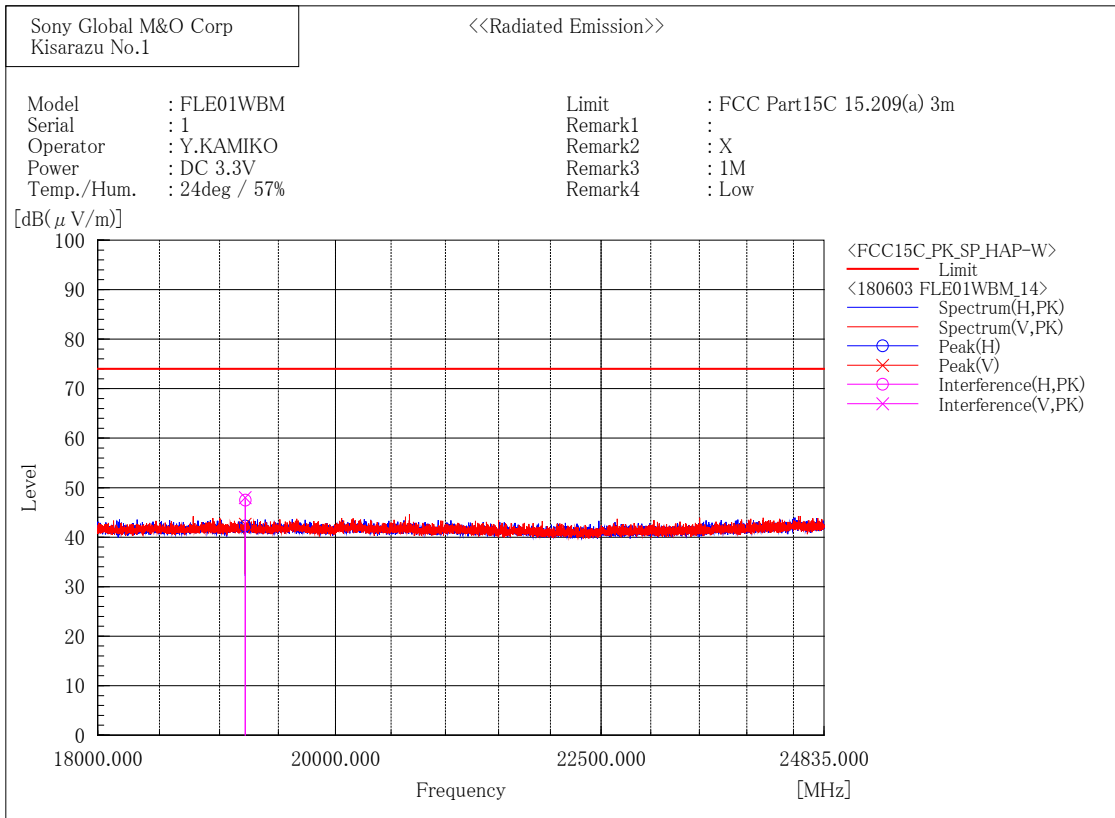

Final Result

--- Horizontal Polarization (PK)---

No.	Frequency [MHz]	Reading [dB(μV)]	c. f [dB(1/m)]	Result [dB(μV/m)]	Limit [dB(μV/m)]	Margin [dB]	Height [cm]	Angle [°]
1	19217.734	42.1	5.4	47.5	74.0	26.5	353.0	127.2

--- Vertical Polarization (PK)---

No.	Frequency [MHz]	Reading [dB(μV)]	c. f [dB(1/m)]	Result [dB(μV/m)]	Limit [dB(μV/m)]	Margin [dB]	Height [cm]	Angle [°]
1	19216.250	42.6	5.4	48.0	74.0	26.0	416.4	129.4

[Bluetooth Low Energy (1 Mbps) / 2442 MHz]

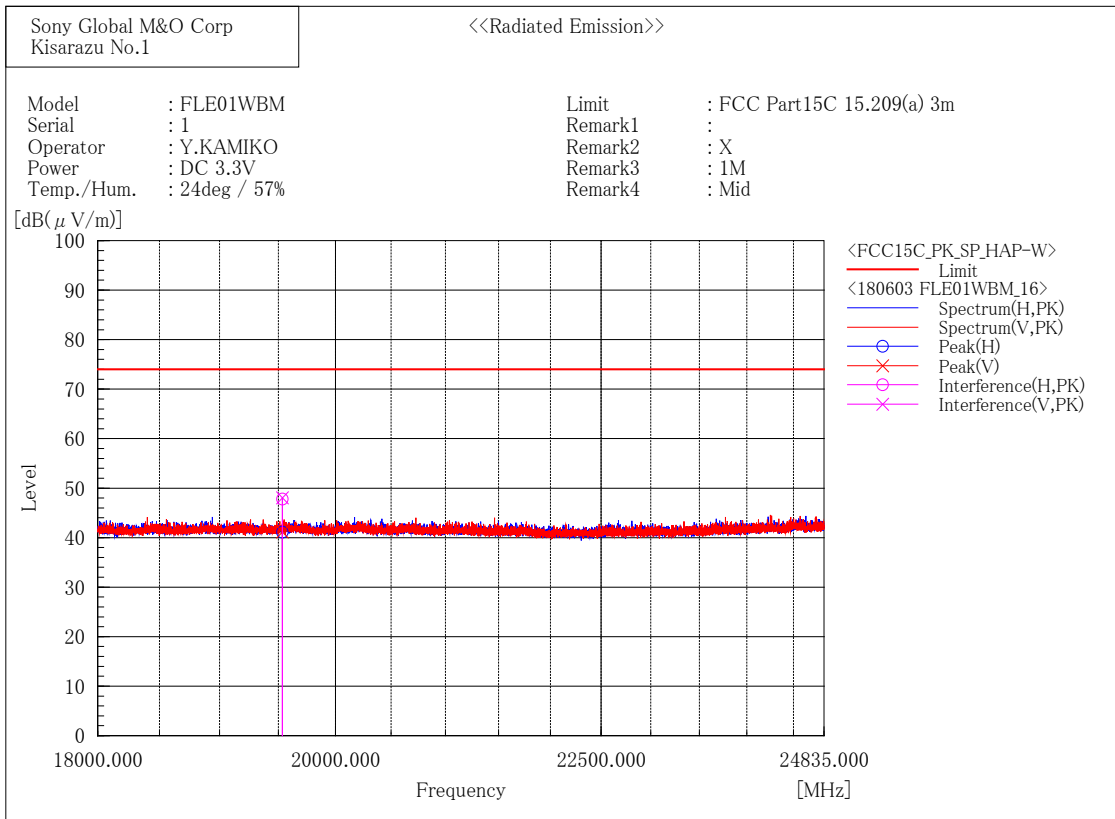

Final Result

--- Horizontal Polarization (PK)---

No.	Frequency [MHz]	Reading [dB(μV)]	c. f [dB(1/m)]	Result [dB(μV/m)]	Limit [dB(μV/m)]	Margin [dB]	Height [cm]	Angle [°]
1	19535.530	42.3	5.5	47.8	74.0	26.2	431.0	214.7

--- Vertical Polarization (PK)---

No.	Frequency [MHz]	Reading [dB(μV)]	c. f [dB(1/m)]	Result [dB(μV/m)]	Limit [dB(μV/m)]	Margin [dB]	Height [cm]	Angle [°]
1	19534.866	42.6	5.5	48.1	74.0	25.9	135.6	150.6

[Bluetooth Low Energy (1 Mbps) / 2480 MHz]

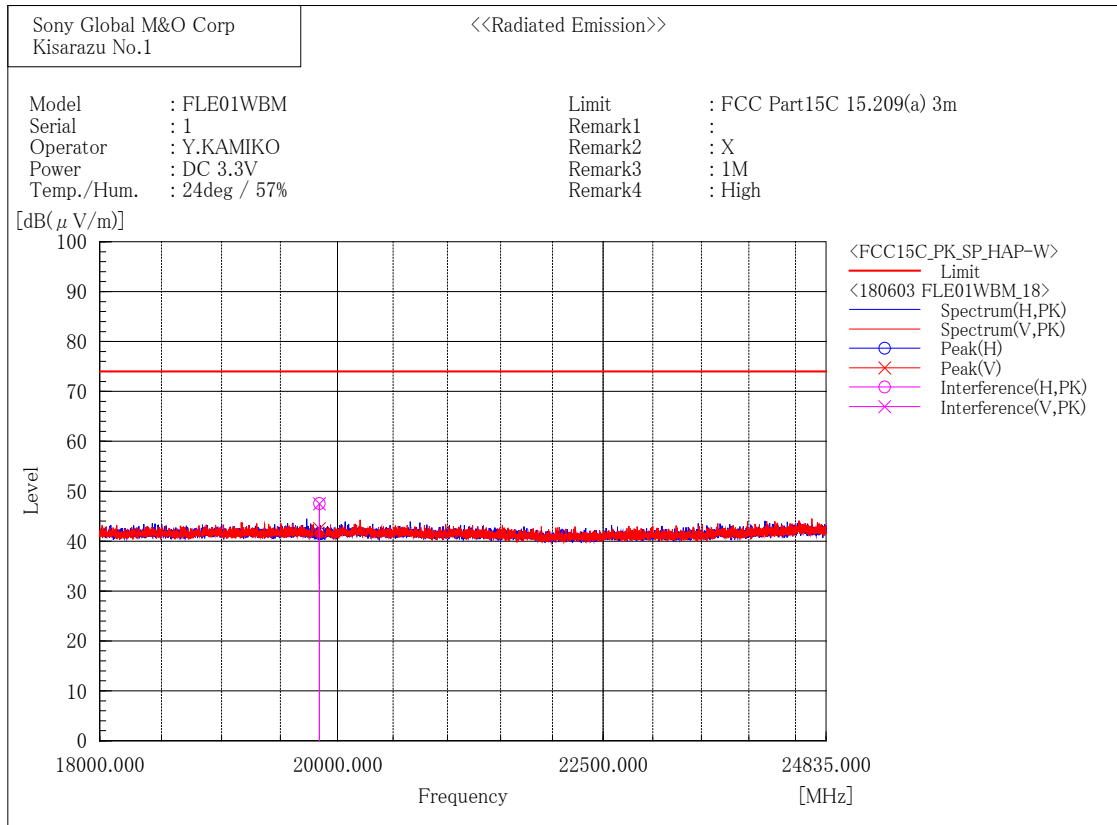

Final Result

--- Horizontal Polarization (PK)---

No.	Frequency [MHz]	Reading [dB(μV)]	c. f [dB(1/m)]	Result [dB(μV/m)]	Limit [dB(μV/m)]	Margin [dB]	Height [cm]	Angle [°]
1	19840.782	42.1	5.5	47.6	74.0	26.4	211.5	162.4

--- Vertical Polarization (PK)---

No.	Frequency [MHz]	Reading [dB(μV)]	c. f [dB(1/m)]	Result [dB(μV/m)]	Limit [dB(μV/m)]	Margin [dB]	Height [cm]	Angle [°]
1	19840.564	42.0	5.5	47.5	74.0	26.5	258.2	132.5

2.4GHz Restricted-Band Edge (Plot data)

These plot data show peak (trace blue) and average (trace black) spectrum for worst case emissions in the restricted-band edges. (Restricted band edges: below 2390 MHz and above 2483.5 MHz)  
The result of the final radiated emissions measurement refers in previous pages.

[Bluetooth Low Energy / 2402 MHz]

Horizontal

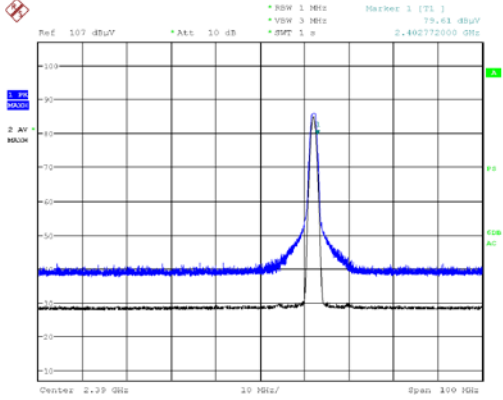

Vertical

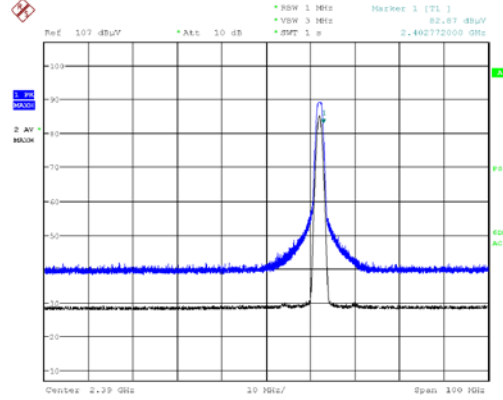

[Bluetooth Low Energy / 2480 MHz]

Horizontal

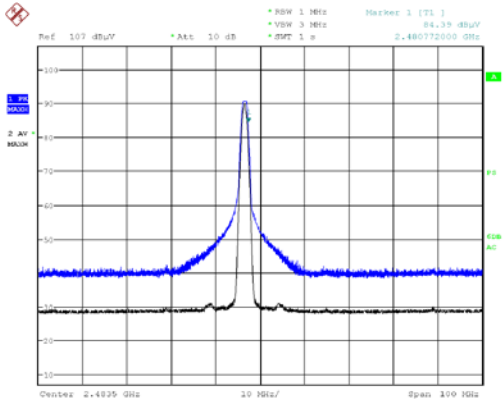

Vertical

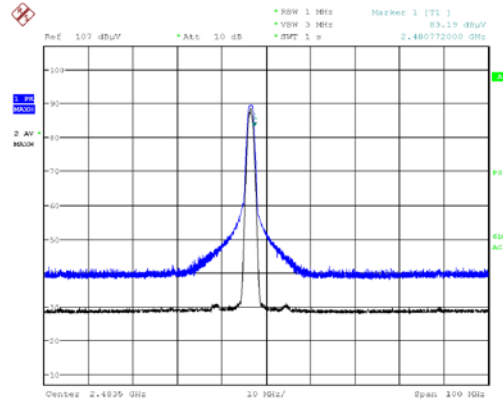

### 3.6. Conducted Spurious Emissions for Band Edge

- 1) Ambient temperature : 24.9deg.C
- 2) Relative humidity : 63.6 %
- 3) Date of measurement : May 31, 2018
- 4) Measured by : M.KOUGA
- 5) Operating mode : Transmitting mode

Mode	Rate [Mbps]	Channel [MHz]	Frequency [MHz]	Reading(PK) [dBm]	C.F. [dB]	Result [dBm]	Limit [dBm]	Margin [dB]
BLE	1	2402	2401.99	-1.34	0.87	-0.47	-	-
			2399.98	-49.35	0.87	-48.48	-20.47	28.01

[Bluetooth Low Energy / 2402 MHz]

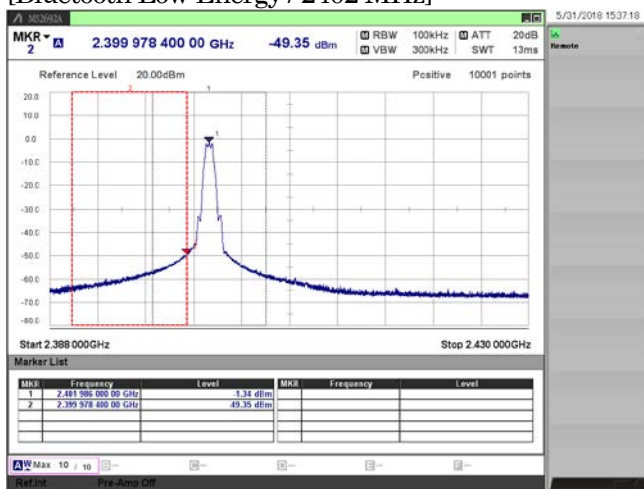

## 4. Method of Calculation

### 4.1. AC Power-line Conducted Emissions Measurement

Method of calculation : Software  
 The Software for Calculation Name : EP5/ CE  
 Version : Ver5.0.0

$$\text{Test Result [ dBuV ]} = \text{Meter Reading [ dBuV ]} + \text{C.F. [ dB ]}$$

Notes :

- (a) Meter Reading : Reading of the EMI test receiver or spectrum analyzer.
- (b) C.F. : System Loss + Correction Factor of LISN.

### 4.2. Maximum Peak Conducted Output Power Measurement

Method of calculation : Software  
 The Software for Calculation Name : SW-316  
 Version : Ver.1.3

$$\text{Test Result (PK) [ dBm ]} = \text{Meter Reading [ dBm ]} + \text{C.F. [ dB ]}$$

$$\text{Test Result (AV) [ dBm ]} = \text{Meter Reading [ dBm ]} + \text{C.F. [ dB ]} + \text{Duty Factor [ dB ]}$$

Notes :

- (a) Meter Reading : Reading of the power meter.
- (b) C.F. : Attenuator Loss + EUT Cable Loss
- (c) Duty Factor :  $10\log \{(\text{Tx ON Time} + \text{Tx OFF Time}) / (\text{Tx ON Time})\}$

### 4.3. Power Density Measurement

Method of calculation : Software  
 The Software for Calculation Name : SW-316  
 Version : Ver.1.3

$$\text{Test Result [ dBm ]} = \text{Meter Reading [ dBm ]} + \text{C.F. [ dB ]}$$

Notes :

- (a) Meter Reading : Reading of the spectrum analyzer.
- (b) C.F. : System Cable Loss + Attenuator Loss + EUT Cable Loss

## 4.4. Radiated Spurious Emission Measurement

Method of calculation : Software  
The Software for Calculation Name : V-Scan  
Version : Ver. 4.0.30

$$\text{Test Result [ dBuV/m ]} = \text{Meter Reading [ dBuV ]} + \text{C.F. [ dB/m ]}$$

Notes :

- (a) Meter Reading : Reading of the EMI test receiver or spectrum analyzer.  
(b) C.F. :  Antenna Factor (including Balun Loss) + System GainLoss  
:  Antenna Factor (including Balun Loss) + System GainLoss + 20 log (3 m/ 10 m)

## 4.5. Conducted Spurious Emission for Band Edge Measurement

Method of calculation : Software  
The Software for Calculation Name : SW-316  
Version : Ver.1.3

$$\text{Test Result [ dBm ]} = \text{Meter Reading [ dBm ]} + \text{C.F. [ dB ]}$$

Notes :

- (a) Meter Reading : Reading of the spectrum analyzer.  
(b) C.F. : System Cable Loss + Attenuator Loss + EUT Cable Loss



## 5. List of Test Equipment

All test results are traceable to the national and/or international standards.

### 5.1. AC Power-line Conducted Emissions

#### 4th Site Shielded Room

	Ctrl#	Equipment	Model No.	Serial No.	Manufacturer	Cal.Interval	Last Cal.
x	-	Shield Room	-	-	TDK	-	-
x	M0575	EMI Receiver	ESCI	100161	Rohde & Schwarz	12 months	18.04.18
x	CS0043	4th Site CE Cable SYSTEM	-	-	EMC/RF Test Lab.	12 months	18.06.01
x	M0664	6dB Attenuator	6806.01A	N/A	HUBER+SUHNER AG	12 months	18.06.01
x	M0619	HIGH FREQUENCY FUSE	MP612A	N/A	Anritsu	12 months	18.06.01
x	M0514	LISN	ENV216	100424	Rohde & Schwarz	12 months	18.04.17
x	M0505	LISN	ENV216	100425	Rohde & Schwarz	12 months	18.04.17
-	M2289	LISN	KNW-407	8-1182-12	Kyoritsu	12 months	18.04.23
-	M2290	LISN	KNW-242C	8-1183-1	Kyoritsu	12 months	18.04.23
x	M0153	50 ohm Terminator	CT-01	N/A	TME	12 months	17.12.04
-	M0597	50 ohm Terminator	CT-01	N/A	TME	12 months	17.12.04
-	M2292	50 ohm Terminator	T1302	N/A	Stack	12 months	18.04.23
-	M2293	50 ohm Terminator	T1302	N/A	Stack	12 months	18.04.23
x	M0690	Thermometer	AD-5640A	201304	AND	12 months	17.11.14

### 5.2. Antenna-port Conducted Measurements

#### 4th Site Shielded Room 1

	Ctrl#	Equipment	Model No.	Serial No.	Manufacturer	Cal.Interval	Last Cal.
x	-	Shield Room	B83117-B2432-T161	P26428	Albatross Project	-	-
-	W0140	Spectrum Analyzer	FSU26	200717	Rohde & Schwarz	12 months	17.08.25
x	W0100	Spectrum Analyzer	MS2692A	6201338954	Anritsu	12 months	18.04.24
x	W0006	Power Meter	N1911A	MY50000295	Keysight Technologies	12 months	17.10.10
x	W0007	Power Sensor	N1922A	MY50180022	Keysight Technologies	12 months	17.10.10
-	W0029	10dB Attenuator	8493C	76549	Keysight Technologies	12 months	17.08.01
-	WC0002	RF Cable	SUCOFLEX 102	34124/2	HUBER + SUHNER	12 months	17.08.03
-	WC0003	RF Cable	SUCOFLEX 102	34127/2	HUBER + SUHNER	12 months	17.08.03
-	WC0004	RF Cable	SUCOFLEX 102	34288/2	HUBER + SUHNER	12 months	17.08.03
x	WC0005	RF Cable	SUCOFLEX 102	34287/2	HUBER + SUHNER	12 months	17.08.03
-	WC0006	RF Cable	SUCOFLEX 102	34289/2	HUBER + SUHNER	12 months	17.08.03
-	WC0007	RF Cable	SUCOFLEX 102	34286/2	HUBER + SUHNER	12 months	17.08.03
x	M0720	Thermometer	TH-321	140036	AS ONE	12 months	17.06.09

## 5.3. Radiated Spurious Emissions

## EMC Site 10m Semi-Anechoic Chamber

	Ctrl#	Equipment	Model No.	Serial No.	Manufacturer	Cal.Int.	Last Cal.
x	M0115	Semi-Anechoic Chamber	-	7D1-8A11	Otsuka Science	12	18.06.02
x	M0686	EMI Receiver	N9038A	MY52260113	Keysight Technologies	12	17.11.20
x	M0562	EMI Receiver	ESU26	100068	Rohde & Schwarz	12	17.06.29
x	M0959	EMI Receiver	ESU40	100041	Rohde & Schwarz	12	18.01.31
x	A0073	Loop Antenna	HFH2-Z2	100171	Rohde & Schwarz	12	17.11.01
x	A0089	Biconical Antenna	BBA9106	VHA91032835	Schwarzbeck	12	17.12.15
x	A0088	Log periodic Antenna	UHALP9108A1	0649	Schwarzbeck	12	17.12.15
x	A0064	Horn Antenna	BBHA9120D	746	Schwarzbeck	12	17.11.18
x	A0078	Horn Antenna	HAP06-18W	00000070	TOYO Corporation	12	17.11.18
x	A0058	Horn Antenna	HAP18-26W	00000016	TOYO Corporation	12	17.12.01
x	CS0017	N-RE Cable SYSTEM 1	-	-	EMC/RF Test Lab.	12	17.11.17
x	CS0018	N-RE Cable SYSTEM 2	-	-	EMC/RF Test Lab.	12	17.11.17
x	CS0045	N-3m EMF Cable SYSTEM	-	-	EMC/RF Test Lab.	12	17.11.17
x	CS0074/0075	N-RE Cable SYSTEM 4	-	-	EMC/RF Test Lab.	12	17.11.17
x	M0126	Step Attenuator	8494H	3837M01144	Keysight Technologies	12	18.06.02
x	M0752	Pre Amplifier	310N	320621	SONOMA INSTRUMENT	12	17.11.17
x	M0128	3dB Attenuator	8491A	53541	Keysight Technologies	12	17.11.17
x	M0609	3dB Attenuator	8491B	MY39265960	Keysight Technologies	12	17.11.17
x	M0737	GHz Filter Box	FB-G1	001	Sony Global M&O	12	17.11.17
x	M0687	Thermo Meter	AD-5640A	201301	A&D	12	17.10.06

About calibration interval

Valid until the end of the month listed in "Cal. Int." column.