

SONY[®]

5-007-634-11(1)

FM/AM Bluetooth[®] Car Audio

Operating Instructions

GB

Mode d'emploi

FR

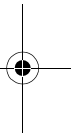
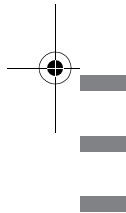

Owner's Record

The model and serial numbers are located on the bottom of the unit.

Record the serial number in the space provided below.

Refer to these numbers whenever you call upon your Sony dealer regarding this product.

Model No. DSX-GS900

Serial No. _____

To cancel the demonstration (DEMO) display, see page 6.

For the connection/installation, see page 10.

**Pour annuler l'affichage de démonstration (DEMO),
reportez-vous à la page 6.**

Pour le raccordement/l'installation, reportez-vous à la page 10.



* 5 0 0 7 6 3 4 1 1 * (1)

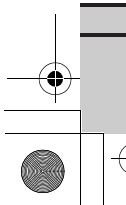

DSX-GS900

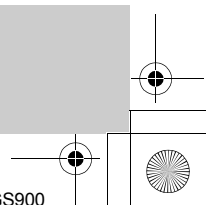
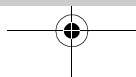

DSX-GS900



Warning

For safety, be sure to install this unit in the dashboard of the car as the left side of the unit becomes hot during use.
For details, see "Connection/Installation" (page 10).

The nameplate indicating operating voltage, etc., is located on the bottom of the chassis.

The validity of the CE marking is restricted to only those countries where it is legally enforced, mainly in the countries EEA (European Economic Area) and Switzerland.

WARNING

FOR THE CUSTOMERS IN THE USA. NOT APPLICABLE IN CANADA, INCLUDING IN THE PROVINCE OF QUEBEC.

POUR LES CLIENTS AUX ÉTATS-UNIS. NON APPLICABLE AU CANADA, Y COMPRIS LA PROVINCE DE QUÉBEC.

This equipment has been tested and found to comply with the limits for a Class B digital device, pursuant to Part 15 of the FCC Rules.

These limits are designed to provide reasonable protection against harmful interference in a residential installation. This equipment generates, uses, and can radiate radio frequency energy and, if not installed and used in accordance with the instructions, may cause harmful interference to radio communications. However, there is no guarantee that interference will not occur in a particular installation. If this equipment does cause harmful interference to radio or television reception, which can be determined by turning the equipment off and on, the user is encouraged to try to correct the interference by one or more of the following measures:

- Reorient or relocate the receiving antenna.
- Increase the separation between the equipment and receiver.
- Connect the equipment into an outlet on a circuit different from that to which the receiver is connected.
- Consult the dealer or an experienced radio/TV technician for help.

You are cautioned that any changes or modifications not expressly approved in this manual could void your authority to operate this equipment.

This device complies with part 15 of FCC Rules and Innovation, Science and Economic Development Canada's licence-exempt RSS(s). Operation is subject to the following two conditions:

- (1) this device may not cause harmful interference, and
- (2) this device must accept any interference received, including interference that may cause undesired operation.

This transmitter must not be co-located or operated in conjunction with any other antenna or transmitter.

This equipment complies with FCC/ISED radiation exposure limits set forth for an uncontrolled environment and meets the FCC radio frequency (RF) Exposure Guidelines and RSS-102 of the ISED radio frequency (RF) Exposure rules as this equipment has very low levels of RF energy.

If you have any questions about this product:

Visit: <https://www.sony.com/electronics/support>

Contact: Sony Customer Information Service Center at 1-800-222-7669

Write: Sony Customer Information Service Center
12451 Gateway Blvd., Fort Myers, FL 33913

Supplier's Declaration of Conformity

Trade Name: SONY

Model: DSX-GS900

Responsible Party: Sony Electronics Inc.

Address: 16535 Via Esprillo, San Diego, CA 92127
U.S.A.

Telephone Number: [858-942-2230](tel:858-942-2230)

This device complies with part 15 of the FCC rules. Operation is subject to the following two conditions:

- (1) This device may not cause harmful interference, and
- (2) this device must accept any interference received, including interference that may cause undesired operation.

For the State of California, USA only

Perchlorate Material – special handling may apply,
See

www.dtsc.ca.gov/hazardouswaste/perchlorate



WARNING: Do not ingest battery, Chemical Burn Hazard.

The remote commander contains a coin/button cell battery. If the coin/button cell battery is swallowed, it can cause severe internal burns in just 2 hours and can lead to death. Keep new and used batteries away from children. If the battery compartment does not close securely, stop using the product and keep it away from children. If you think batteries might have been swallowed or placed inside any part of the body, seek immediate medical attention.

Note on the lithium battery

Do not expose the battery to excessive heat such as direct sunlight, fire or the like.

Warning if your car's ignition has no ACC position

Be sure to set the AUTO OFF function. The unit will shut off completely and automatically in the set time after the unit is turned off and the clock is displayed (i.e. press and hold OFF for 1 second), which prevents battery drain. If you do not set the AUTO OFF function, press and hold OFF until the display disappears each time you turn the ignition off.

Disclaimer regarding services offered by third parties

Services offered by third parties may be changed, suspended, or terminated without prior notice. Sony does not bear any responsibility in these sorts of situations.

Important notice

Caution

IN NO EVENT SHALL SONY BE LIABLE FOR ANY INCIDENTAL, INDIRECT OR CONSEQUENTIAL DAMAGES OR OTHER DAMAGES INCLUDING, WITHOUT LIMITATION, LOSS OF PROFITS, LOSS OF REVENUE, LOSS OF DATA, LOSS OF USE OF THE PRODUCT OR ANY ASSOCIATED EQUIPMENT, DOWNTIME, AND PURCHASER'S TIME RELATED TO OR ARISING OUT OF THE USE OF THIS PRODUCT, ITS HARDWARE AND/OR ITS SOFTWARE.

Dear customer, this product includes a radio transmitter.

Please check your vehicle operation manual or contact the manufacturer of your vehicle or your vehicle dealer, before you install this product into your vehicle.

Emergency calls

This BLUETOOTH car handsfree and the electronic device connected to the handsfree operate using radio signals, cellular, and landline networks as well as user-programmed function, which cannot guarantee connection under all conditions. Therefore do not rely solely upon any electronic device for essential communications (such as medical emergencies).

On BLUETOOTH communication

- Microwaves emitting from a BLUETOOTH device may affect the operation of electronic medical devices. Turn off this unit and other BLUETOOTH devices in the following locations, as it may cause an accident.
 - where inflammable gas is present, in a hospital, train, airplane, or petrol station
 - near automatic doors or a fire alarm
- This unit supports security capabilities that comply with the BLUETOOTH standard to provide a secure connection when the BLUETOOTH wireless technology is used, but security may not be enough depending on the setting. Be careful when communicating using BLUETOOTH wireless technology.
- We do not take any responsibility for the leakage of information during BLUETOOTH communication.

If you have any questions or problems concerning your unit that are not covered in this manual, consult your nearest Sony dealer.

3GB

DSX-GS900

Guide to Parts and Controls

Main Unit and Remote Commander

Main unit

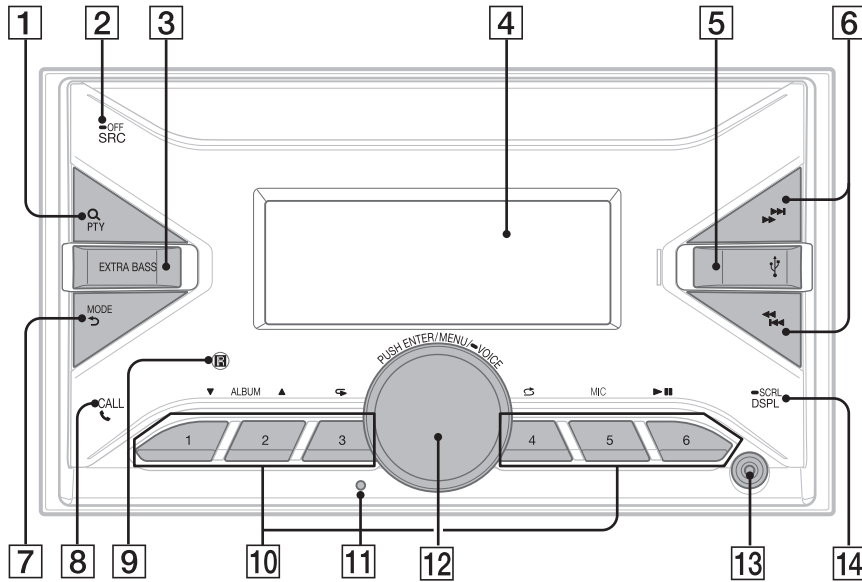

- 1 Q (browse)**
During playback:
Enters the browse mode.
(Not available when a USB device in Android™ mode or iPod is connected.)
PTY (program type)
During FM reception:
Selects PTY in RDS.
- 2 SRC (source)**
Turns on the power.
Changes the source.
OFF
Press and hold for 1 second to turn the source off and display the clock.
Press and hold for more than 2 seconds to turn off the power and the display.
If the unit is turned off and the display disappears, operation by the remote commander is not available.
- 3 EXTRA BASS**
Reinforces bass sound in synchronization with the volume level.
Press to change the EXTRA BASS setting: [1], [2], [OFF].
- 4 Display window**
- 5 USB port**
- 6 <<</>>> (SEEK -/+)**
During radio reception:
Tunes in radio stations automatically.
Press and hold to tune manually.
<<</>>> (prev/next)
<<</>>> (fast-reverse/fast-forward)
- 7 MODE**
< (back)
Returns to the previous display.
- 8 CALL**
Enters the call menu. Receives/ends a call.
Press and hold for more than 2 seconds to switch the BLUETOOTH signal.

9 Receptor for the remote commander

10 Number buttons (1 to 6)

Receives preset radio stations.
Press and hold to preset stations.

ALBUM ▼/▲

Skips an album for audio device.
Press and hold to skip albums continuously.
(Not available when a USB device in Android mode or iPod is connected.)
Press ▲ to thumbs up, or ▼ to thumbs down in Pandora®.

↺ (repeat)

(Not available when a USB device in Android mode is connected.)

↻ (shuffle)

(Not available when a USB device in Android mode is connected.)

MIC

▶|| (play/pause)

11 Reset button (page 6)

12 Control dial

Adjusts the volume.

PUSH ENTER

Enters the selected item.
Press SRC, rotate then press to change the source (timeout in 2 seconds).

MENU

Opens the setup menu.

● VOICE

Press and hold for more than 2 seconds to activate voice dial, voice recognition (Android smartphone only), or the Siri function (iPhone only).

13 AUX input jack

14 DSPL (display)

Changes display items.

● SCRL (scroll)

Press and hold to scroll a display item.

RM-X231 Remote commander

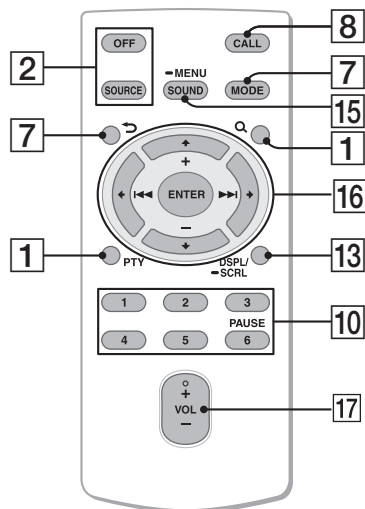

The VOL (volume) + button has a tactile dot.

15 SOUND

Opens the SOUND menu directly.

● MENU

Press and hold to open the setup menu.

16 ◀/▶/↶/↷

Selects a setup item, etc.

ENTER

Enters the selected item.

Press and hold for more than 2 seconds to establish or terminate the "Sony | Music Center" function.

◀◀/▶▶ (prev/next)

+/- (album +/-)

17 VOL (volume) +/-

Remove the insulation film before use.



5GB

DSX-GS900

Basic Operations

Resetting the Unit

Before operating the unit for the first time, after replacing the car battery, or changing the connections, you must reset the unit. Press the reset button with a ball-point pen, etc.

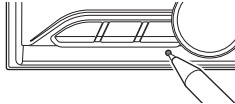

Note

Resetting the unit will erase the clock setting and some stored contents.

Pairing with a Bluetooth Device

When connecting a BLUETOOTH device for the first time, mutual registration (called "pairing") is required. Pairing enables this unit and other devices to recognize each other. This unit can connect two BLUETOOTH devices (two mobile phones, or a mobile phone and an audio device).



- 1 Press MENU, then rotate and press the control dial to select [BLUETOOTH] → [PAIRING] → [DEVICE 1]/[DEVICE 2]*.

Ⓚ flashes while the unit is in pairing standby mode.

* [DEVICE 1] or [DEVICE 2] will be changed to the paired device name after pairing is complete.

- 2 Perform pairing on the BLUETOOTH device so it detects this unit.
 - 3 Select your model name shown in the display of the BLUETOOTH device*.
- When pairing is made, Ⓚ stays lit.

* If passkey input is required on the BLUETOOTH device, input [0000].

Canceling the Demonstration Mode

You can cancel the demonstration display which appears when the source is off and the clock is displayed.

- 1 Press MENU, rotate the control dial to select [GENERAL], then press it.
- 2 Rotate the control dial to select [DEMO], then press it.
- 3 Rotate the control dial to select [DEMO-OFF], then press it.
The setting is complete.
- 4 Press ↵ (back) twice.
The display returns to normal reception/play mode.

Updating the Firmware

To update the firmware, visit the support site on the back cover, then follow the online instructions.

Notes

- Using a USB device (not supplied) is required for updating the firmware. Store the updater in the USB device, and connect the device to the USB port, then perform the update operation.
- Updating the firmware takes a few minutes to complete. During the update, do not turn the ignition to the OFF position, nor remove the USB device.

Additional Information

Precautions

- Cool off the unit beforehand if your car has been parked in direct sunlight.
- Do not leave audio devices brought in inside the car, or it may cause malfunction due to high temperature in direct sunlight.
- Power antenna (aerial) extends automatically.

To maintain high sound quality

Do not splash liquid onto the unit.

Playback order of audio files

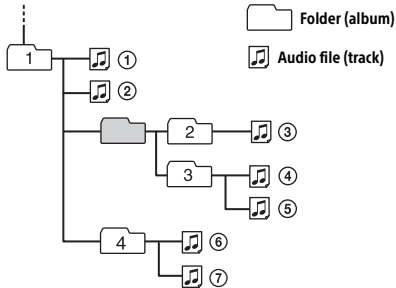

About iPod

- You can connect to the following iPod models. Update your iPod devices to the latest software before use.

Compatible iPhone/iPod models

| Compatible Model | Bluetooth® | USB |
|------------------|------------|-----|
| iPhone XR | ✓ | ✓ |
| iPhone Xs max | ✓ | ✓ |
| iPhone Xs | ✓ | ✓ |
| iPhone X | ✓ | ✓ |
| iPhone 8 | ✓ | ✓ |
| iPhone 8 Plus | ✓ | ✓ |
| iPhone 7 | ✓ | ✓ |
| iPhone 7 Plus | ✓ | ✓ |
| iPhone SE | ✓ | ✓ |
| iPhone 6s | ✓ | ✓ |
| iPhone 6s Plus | ✓ | ✓ |
| iPhone 6 | ✓ | ✓ |
| iPhone 6 Plus | ✓ | ✓ |

| Compatible Model | Bluetooth® | USB |
|-----------------------------|------------|-----|
| iPhone 5s | ✓ | ✓ |
| iPhone 5c | ✓ | ✓ |
| iPhone 5 | ✓ | ✓ |
| iPhone 4s | ✓ | ✓ |
| iPod touch (6th generation) | ✓ | ✓ |
| iPod touch (5th generation) | ✓ | ✓ |
| iPod nano (7th generation) | | ✓ |

- Use of the Made for Apple badge means that an accessory has been designed to connect specifically to the Apple product(s) identified in the badge, and has been certified by the developer to meet Apple performance standards. Apple is not responsible for the operation of this device or its compliance with safety and regulatory standards. Please note that the use of this accessory with an Apple product may affect wireless performance.

If you have any questions or problems concerning your unit that are not covered in this manual, consult your nearest Sony dealer.

Maintenance

Replacing the lithium battery (CR2025) of the remote commander

When the battery becomes weak, the range of the remote commander becomes shorter.

CAUTION

Danger of explosion if battery is incorrectly replaced. Replace only with the same or equivalent type.

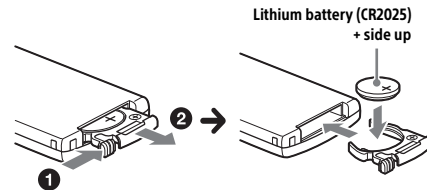

Note on the lithium battery

Keep the lithium battery out of the reach of children. Should the battery be swallowed, immediately consult a doctor.

7GB

Specifications

FOR THE CUSTOMERS IN THE USA. NOT APPLICABLE IN CANADA, INCLUDING IN THE PROVINCE OF QUEBEC.

POUR LES CLIENTS AUX ÉTATS-UNIS. NON APPLICABLE AU CANADA, Y COMPRIS LA PROVINCE DE QUÉBEC.

AUDIO POWER SPECIFICATIONS



CTA2006 Standard
Power Output: 45 Watts RMS × 4 at 4 Ohms < 1% THD+N
SN Ratio: 80 dBA
(reference: 1 Watt into 4 Ohms)

Tuner section

FM

Tuning range: 87.5 MHz – 107.9 MHz
Usable sensitivity: 8 dBf
Signal-to-noise ratio: 73 dB
Separation: 50 dB at 1 kHz

AM

Tuning range: 530 kHz – 1,710 kHz
Sensitivity: 26 μ V

USB Player section

Interface: USB (High speed)
Maximum current:
Front: 1 A
Rear: 1.5 A
Maximum number of recognizable files(tracks): 10,000
Compatible Android Open Accessory protocol (AOA): 2.0
Corresponding codec:
MP3 (.mp3)
Bit rate: 8 kbps – 320 kbps (Supports VBR (Variable Bit Rate))
Sampling rate: 16 kHz – 48 kHz
WMA (.wma)
Bit rate: 32 kbps – 192 kbps (Supports VBR (Variable Bit Rate))
Sampling rate: 32 kHz, 44.1 kHz, 48 kHz
AAC (.m4a, .mp4)
Bit rate: 8 kbps – 320 kbps
Sampling rate: 11.025 kHz – 48 kHz
WAV (.wav)
Bit depth: 16 bit
Sampling rate: 44.1 kHz, 48 kHz
FLAC (.flac)
Bit depth: 16 bit, 24 bit
Sampling rate: 44.1 kHz, 48 kHz

Wireless Communication

Communication System:
BLUETOOTH Standard version 3.0
Output:
BLUETOOTH Standard Power Class 2
(Max. Conducted +1 dBm)
Maximum communication range*1:
Line of sight approx. 10 m (33 ft)
Frequency band:
2.4 GHz band (2.4000 GHz – 2.4835 GHz)
Modulation method: FHSS
Compatible BLUETOOTH Profiles*2:
A2DP (Advanced Audio Distribution Profile) 1.3
AVRCP (Audio Video Remote Control Profile) 1.5
HFP (Handsfree Profile) 1.6
PBAP (Phone Book Access Profile)
SPP (Serial Port Profile)
Corresponding codec:
SBC (.sbc), AAC (.m4a)

*1 The actual range will vary depending on factors such as obstacles between devices, magnetic fields around a microwave oven, static electricity, reception sensitivity, antenna (aerial)'s performance, operating system, software application, etc.

*2 BLUETOOTH standard profiles indicate the purpose of BLUETOOTH communication between devices.

Power amplifier section

Output: Speaker outputs
Speaker impedance: 2 Ω /4 Ω – 8 Ω
Maximum power output: 100 W × 4 (at 2 Ω / 4 Ω)

General

Power requirements: 12 V DC car battery (negative ground (earth))
Rated current consumption: 10 A
Dimensions:
Approx. 178 mm × 100 mm × 177 mm
(7 1/8 in × 4 in × 7 in) (w/h/d)
Mounting dimensions:
Approx. 182 mm × 111 mm × 159 mm
(7 1/4 in × 4 3/8 in × 6 3/8 in) (w/h/d)
Mass: Approx. 1.0 kg (2 lb 4 oz)
Package contents:
Main unit (1)
Remote commander (1): RM-X231
Parts for installation and connections (1 set)
Optional accessories/equipment:
SiriusXM Connect Vehicle Tuner: SXV100, SXV200, SXV300
Cable for steering wheel remote input: RC-SR1

Ask the dealer for detailed information.

Design and specifications are subject to change without notice.

8GB



Copyrights

(((SiriusXM))) READY

SiriusXM Connect Vehicle Tuner and Subscription sold separately.

www.siriusxm.com

Sirius, XM and all related marks and logos are trademarks of Sirius XM Radio Inc. All rights reserved.

The Bluetooth® word mark and logos are registered trademarks owned by the Bluetooth SIG, Inc. and any use of such marks by Sony Corporation is under license. Other trademarks and trade names are those of their respective owners.

Windows Media is either a registered trademark or trademark of Microsoft Corporation in the United States and/or other countries.

This product is protected by certain intellectual property rights of Microsoft Corporation. Use or distribution of such technology outside of this product is prohibited without a license from Microsoft or an authorized Microsoft subsidiary.

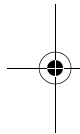

Apple, iPhone, iPod, iPod nano, iPod touch, and Siri are trademarks of Apple Inc., registered in the U.S. and other countries.

PANDORA, the PANDORA logo, and the Pandora trade dress are trademarks or registered trademarks of Pandora Media, LLC. Used with permission.

Android is a trademark of Google LLC.

libFLAC

Copyright (C) 2000-2009 Josh Coalson

Copyright (C) 2011-2013 Xiph.Org Foundation

Redistribution and use in source and binary forms, with or without modification, are permitted provided that the following conditions are met:

- Redistributions of source code must retain the above copyright notice, this list of conditions and the following disclaimer.
- Redistributions in binary form must reproduce the above copyright notice, this list of conditions and the following disclaimer in the documentation and/or other materials provided with the distribution.
- Neither the name of the Xiph.org Foundation nor the names of its contributors may be used to endorse or promote products derived from this software without specific prior written permission.

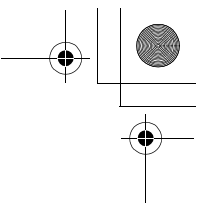

THIS SOFTWARE IS PROVIDED BY THE COPYRIGHT HOLDERS AND CONTRIBUTORS "AS IS" AND ANY EXPRESS OR IMPLIED WARRANTIES, INCLUDING, BUT NOT LIMITED TO, THE IMPLIED WARRANTIES OF MERCHANTABILITY AND FITNESS FOR A PARTICULAR PURPOSE ARE DISCLAIMED. IN NO EVENT SHALL THE FOUNDATION OR CONTRIBUTORS BE LIABLE FOR ANY DIRECT, INDIRECT, INCIDENTAL, SPECIAL, EXEMPLARY, OR CONSEQUENTIAL DAMAGES (INCLUDING, BUT NOT LIMITED TO, PROCUREMENT OF SUBSTITUTE GOODS OR SERVICES; LOSS OF USE, DATA, OR PROFITS; OR BUSINESS INTERRUPTION) HOWEVER CAUSED AND ON ANY THEORY OF LIABILITY, WHETHER IN CONTRACT, STRICT LIABILITY, OR TORT (INCLUDING NEGLIGENCE OR OTHERWISE) ARISING IN ANY WAY OUT OF THE USE OF THIS SOFTWARE, EVEN IF ADVISED OF THE POSSIBILITY OF SUCH DAMAGE.



9GB

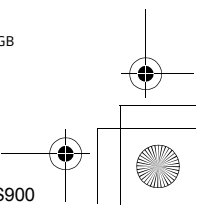
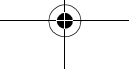
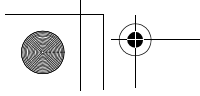

DSX-GS900

Connection/Installation

Cautions

- Run all ground (earth) leads to a common ground (earth) point.
- Do not get the leads trapped under a screw, or caught in moving parts (e.g., seat railing).
- Before making connections, turn the car ignition off to avoid short circuits.
- Connect the **yellow** and **red** power supply leads only after all other leads have been connected.
- Be sure to insulate any loose unconnected leads with electrical tape for safety.
- Choose the installation location carefully so that the unit will not interfere with normal driving operations.
- Avoid installing the unit in areas subject to dust, dirt, excessive vibration, or high temperature, such as in direct sunlight or near heater ducts.
- Use only the supplied mounting hardware for a safe and secure installation.

Note on the power supply lead (yellow)

When connecting this unit in combination with other stereo components, the amperage rating of the car circuit to which the unit is connected must be higher than the sum of each component's fuse amperage rating.

Note on installing in cars with a start-stop system

The unit may restart when starting the engine from start-stop. In this case, turn off the start-stop system of your car.

Mounting angle adjustment

Adjust the mounting angle to less than 30°.

Parts List for Installation

- ① Mounting screws (5 × max. 8 mm (7/32 × max. 5/16 in)) (4)
- ② Power supply leads (1)



- ③ Microphone (1)
- ④ Double-sided tape (1)

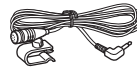

- ⑤ Flat-mount base (1)



This parts list does not include all the package contents.

Connection

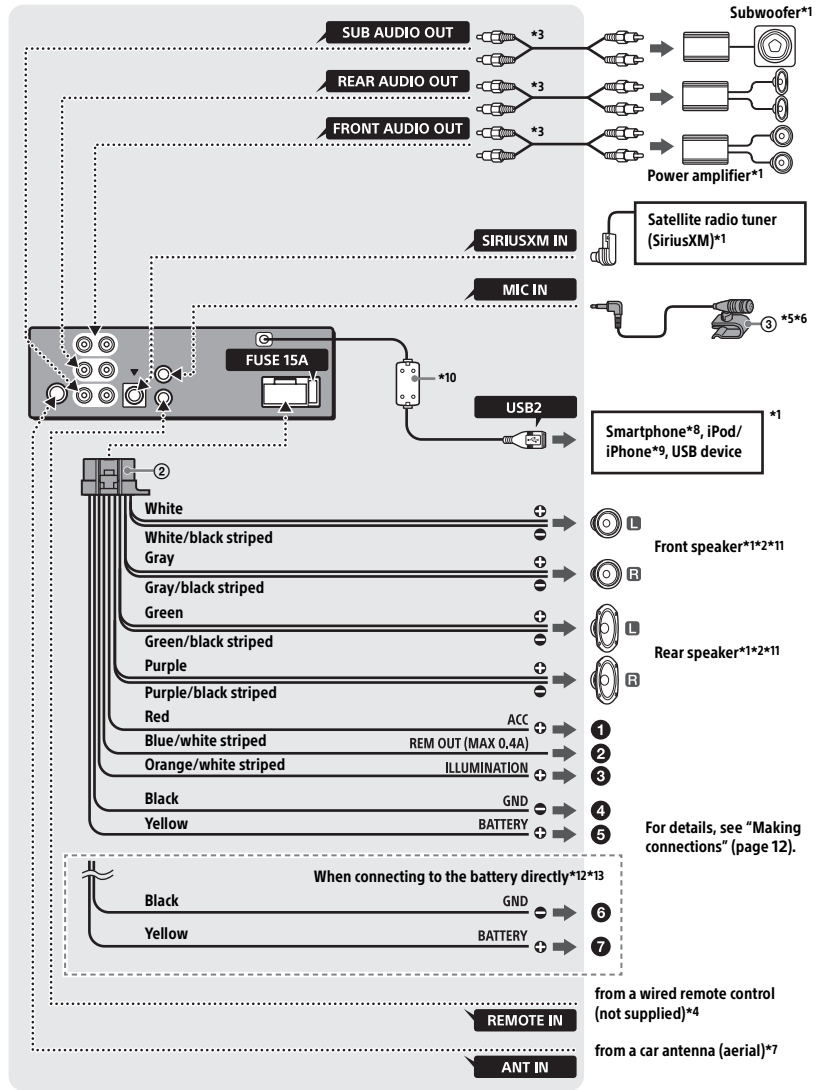

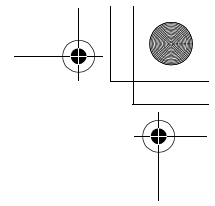
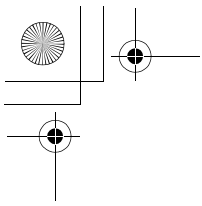

- *1 Not supplied
- *2 Speaker impedance: $4\ \Omega - 8\ \Omega \times 4$
- *3 RCA pin cord (not supplied)
- *4 Depending on the type of car, use an adaptor for a wired remote control (not supplied). For details on using the wired remote control, see "Using the wired remote control" (page 14).
- *5 Whether in use or not, route the microphone input cord such that it does not interfere with driving operations. Secure the cord with a clamp, etc., if it is installed around your feet.
- *6 For details on installing the microphone, see "Installing the microphone" (page 13).
- *7 Depending on the type of car, use an adaptor (not supplied) if the antenna (aerial) connector does not fit.
- *8 To connect a smartphone to the main unit, an appropriate cable (not supplied) is required.
- *9 To connect an iPod/iPhone, use the USB connection cable for iPod (not supplied).
- *10 Ferrite sleeve
- *11 Use speakers with 50W RMS or higher power input capacity. Using Sony XB series full range speakers is recommended.
- *12 When the amperage rating of the fuse used on your car is 10 A, make the power connection to the battery directly to avoid short circuits.
- *13 Before connection, arranging the yellow and black leads of the power connector is required.

Making connections

- 1 To the +12 V power terminal which is energized when the ignition switch is set to the accessory position**
If there is no accessory position, connect to the +12 V power (battery) terminal which is energized at all times.
Be sure to first connect the black ground (earth) lead to a common ground (earth) point.
- 2 To the power antenna (aerial) control lead or the power supply lead of the antenna (aerial) booster**
It is not necessary to connect this lead if there is no power antenna (aerial) or antenna (aerial) booster, or with a manually-operated telescopic antenna (aerial).
To AMP REMOTE IN of an optional power amplifier
This connection is only for amplifiers and a power antenna (aerial). Connecting any other system may damage the unit.

- 3 To a car's illumination signal**
Be sure to first connect the black ground (earth) lead to a common ground (earth) point.
- 4 To a common ground (earth) point**
First connect the black ground (earth) lead, then connect the yellow and red power supply leads.
- 5 To the +12 V power terminal which is energized at all times**
Be sure to first connect the black ground (earth) lead to a common ground (earth) point.

When connecting to the battery directly
When the amperage rating of the fuse used on your car is 10 A, make the power connection to the battery directly to avoid short circuits.

- 6 to a metal point of car**
- 7 to the positive battery terminal**

Notes

- Despite connecting to the power supply lead of the car, the unit may not fully provide its performance due to insufficient power. In this case, make the power connection to the battery directly.
- All power wires connected to the positive battery post should be fused within 450 mm (18 in) of the battery post, and before they pass through any metal.
- Make sure that the car's battery wires connected to the car (ground (earth) to chassis)* are of a wire gauge at least equal to that of the main power wire connected from the battery to the head unit.
- During full-power operation, a current of more than 15 A will run through the system. Therefore, make sure that the wires to be connected to the +12 V and GND terminals of this unit are at least 14-Gauge (AWG14) or have a sectional area of more than 2mm^2 ($3/32$ in).
When making the speaker parallel connection, use wires with more than 12-Gauge (AWG12) or wire that have a sectional area of more than 3.5mm^2 ($5/32$ in).

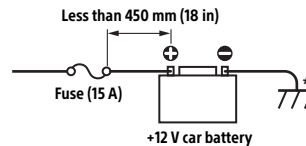

If you have any questions or problems concerning the connection, consult the dealer for details.

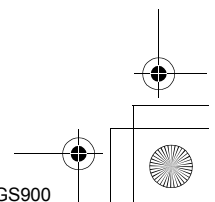
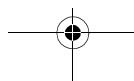
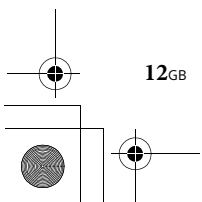
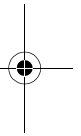
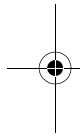

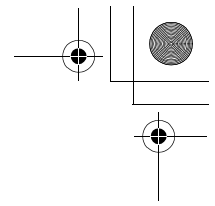
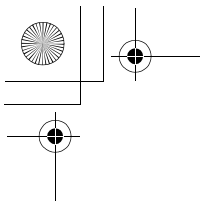

Subwoofer Easy Connection

You can use a subwoofer without a power amplifier when it is connected to a rear speaker lead.

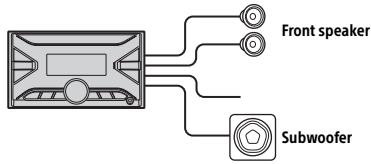

Note

Use a subwoofer with an impedance of $4\ \Omega$ to $8\ \Omega$, and with adequate power handling capacities to avoid damage.

Memory hold connection

When the yellow power supply lead is connected, power will always be supplied to the memory circuit even when the ignition switch is turned off.

Speaker connection

- Before connecting the speakers, turn the unit off.
- Use speakers with a $2\ \Omega$ impedance or $4\ \Omega$ to $8\ \Omega$ impedance, and with adequate power handling capacities to avoid damage.

Speaker Parallel Connection

When making the speaker parallel connection for a high volume playback, be sure to:

- Make the power connection to the battery directly.
- Set [SPEAKER LOAD] in [GENERAL] to [2 Ohm].

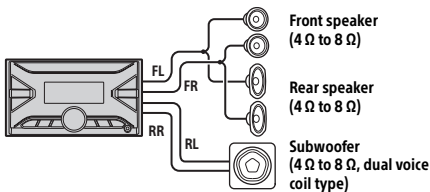

Note

When using a subwoofer with dual voice coil, or using a subwoofer by connecting the right and left rear speaker leads, be sure to set [SPEAKER LOAD] in [GENERAL] to [2 Ohm].

Installing the microphone

To capture your voice during handsfree calling, you need to install the microphone ③.

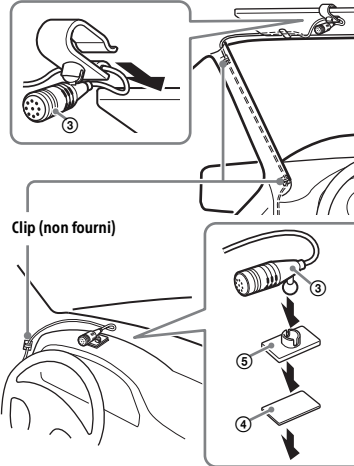

Cautions

- It is extremely dangerous if the cord becomes wound around the steering column or gearstick. Be sure to keep it and other parts from interfering with your driving operations.
- If airbags or any other shock-absorbing equipment is in your car, contact the store where you purchased this unit, or the car dealer, before installation.

Note

Before attaching the double-sided tape ④, clean the surface of the dashboard with a dry cloth.

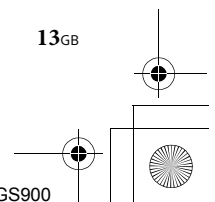
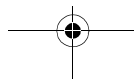
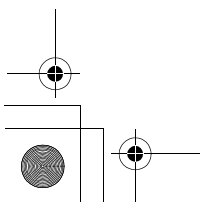
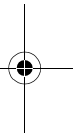
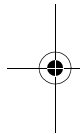

Using the wired remote control

When using the steering wheel remote control

Installation of the connection cable RC-SR1 (not supplied) is required before use.

- 1 To enable the steering wheel remote control, select [STEERING] → [EDIT CUSTOM] to make the registration.

When the registration completes, the steering wheel remote control becomes available.

Notes on installing the connection cable RC-SR1 (not supplied)

- Refer to the support sites on the back cover for details, then connect each lead properly to the appropriate leads. Making an improper connection may damage the unit.
- Depending on the type of car, be sure to insulate the unused leads with electrical tape for safety.
- Do not connect this cable when the steering wheel remote control is not used.
- Consulting the dealer or an experienced technician for help is recommended.

When using the wired remote control

- 1 To enable the wired remote control, set [STR CONTROL] in [STEERING] to [PRESET].

Installation

Mounting the unit in the dashboard

For Japanese cars, see "Mounting the unit in a Japanese car" (page 14).

Mounting the unit with an installation kit (not supplied)

You can use a commercially available double DIN installation kit. Choose an installation kit with the following panel frame size.

Larger than 172 mm × 97 mm (6 7/8 in × 3 7/8 in) (w/h), with an inner corner radius of less than 0.5 mm (1/32 in).

Note

Be sure to use the mounting screws ①.

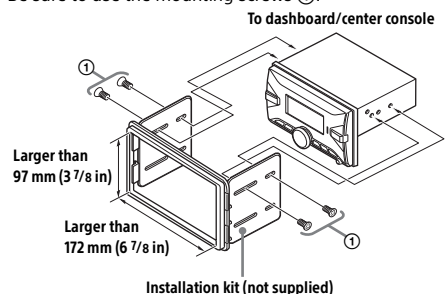

Mounting the unit in a Japanese car

You may not be able to install this unit in some makes of Japanese cars. In such a case, consult your Sony dealer.

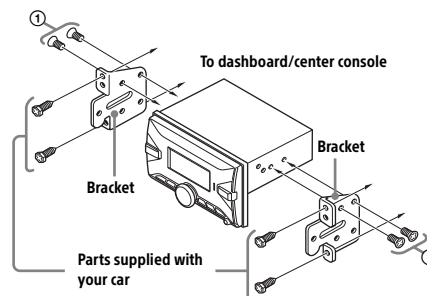

When mounting this unit to the preinstalled brackets of your car, use the mounting screws ① in the appropriate screw holes based on your car: T for TOYOTA and N for NISSAN.

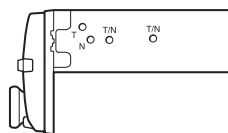

Note

To prevent malfunction, install only with the mounting screws ①.

Resetting the unit

For details, see "Resetting the Unit" (page 6).

Fuse replacement

When replacing the fuse, be sure to use one matching the amperage rating stated on the original fuse. If the fuse blows, check the power connection and replace the fuse. If the fuse blows again after replacement, there may be an internal malfunction. In such a case, consult your nearest Sony dealer.

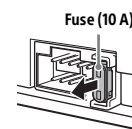

Support site

If you have any questions or for the latest support information on this product, please visit the web site below:

Site d'assistance

Si vous avez des questions ou si vous souhaitez consulter les toutes dernières informations techniques sur ce produit, rendez-vous sur le site Web suivant :

<https://www.sony.com/am/support>

If you have any questions/problems regarding this product, try the following:

- 1 **Read Troubleshooting in Help Guide (online manual).**
- 2 **Please contact (U.S.A. only);**
Call 1-800-222-7669
URL <https://www.SONY.com>

Help Guide (online manual)

For details on the functions and operations that are not covered in this manual, please visit the web site below:

Guide d'aide (manuel en ligne)

Pour plus de détails sur les fonctions et opérations qui ne sont pas abordées dans ce mode d'emploi, veuillez visiter le site Web ci-dessous :

http://rd1.sony.net/help/ev/xxx-xxxx/h_zz/

Made for
 iPhone | iPod

pandora® 
READY

 **Bluetooth®**

©2019 Sony Corporation Printed in Thailand

<https://www.sony.net/>

DSX-GS900