

FCC Test Report

FCC ID : AK8DHUKSY22
Equipment : WLAN/BT Module
Model No. : DHUK-SY22
Brand Name : Wistron NeWeb Corporation
Applicant : Sony Corporation
Address : 1-7-1 Konan Minato-ku, Tokyo ,108-0075 Japan
Standard : 47 CFR FCC Part 15.407
Received Date : Jul. 26, 2019
Tested Date : Aug. 13 ~ Oct. 01, 2019

We, International Certification Corp., would like to declare that the tested sample has been evaluated and in compliance with the requirement of the above standards. The test results contained in this report refer exclusively to the product. It may be duplicated completely for legal use with the approval of the applicant. It shall not be reproduced except in full without the written approval of our laboratory.

Reviewed by:



Along Chen / Assistant Manager

Approved by:



Gary Chang / Manager



Table of Contents

1	GENERAL DESCRIPTION	5
1.1	Information.....	5
1.2	Local Support Equipment List	8
1.3	Test Setup Chart	8
1.4	The Equipment List	9
1.5	Testing Applied Standards	10
1.6	Deviation from Test Standard and Measurement Procedure.....	10
1.7	Measurement Uncertainty	11
2	TEST CONFIGURATION	12
2.1	Testing Condition	12
2.2	The Worst Test Modes and Channel Details	12
3	TRANSMITTER TEST RESULTS.....	14
3.1	Conducted Emissions.....	14
3.2	Emission Bandwidth	19
3.3	RF Output Power.....	36
3.4	Peak Power Spectral Density.....	40
3.5	Transmitter Radiated and Band Edge Emissions	58
3.6	Frequency Stability.....	139
4	TEST LABORATORY INFORMATION	141

Release Record

Report No.	Version	Description	Issued Date
FR972601AN	Rev. 01	Initial issue	Oct. 22, 2019

Summary of Test Results

FCC Rules	Test Items	Measured	Result
15.207	Conducted Emissions	[dBuV]: 0.168MHz 50.48 (Margin -14.60dB) - QP	Pass
15.407(b) 15.209	Radiated Emissions	[dBuV/m at 3m]: 11650.00MHz 53.60 (Margin -0.40dB) - AV	Pass
15.407(a)	Emission Bandwidth	Meet the requirement of limit	Pass
15.407(e)	6dB bandwidth	Meet the requirement of limit	Pass
15.407(a)	RF Output Power	Max Power [dBm]: 5150~5250MHz: 12.08 5250~5350MHz: 19.01 5470~5725MHz: 19.57 5725~5850MHz: 19.16	Pass
15.407(a)	Peak Power Spectral Density	Meet the requirement of limit	Pass
15.407(g)	Frequency Stability	Meet the requirement of limit	Pass
15.203	Antenna Requirement	Meet the requirement of limit	Pass

Declaration of Conformity:

The test results with all measurement uncertainty excluded are presented in accordance with the regulation limits or requirements declared by manufacturers.

Comments and Explanations:

The declared of product specification for EUT presented in the report are provided by the manufacturer, and the manufacturer takes all the responsibilities for the accuracy of product specification.

1 General Description

1.1 Information

1.1.1 Specification of the Equipment under Test (EUT)

RF General Information					
Frequency Range (MHz)	IEEE Std. 802.11	Ch. Freq. (MHz)	Channel Number	Transmit Chains (N _{TX})	Data Rate
5150-5250 5250-5350 5470-5725 5725-5850	a	5180-5240 5260-5320 5500-5700 5745-5825	36-48 [4] 52-64 [4] 100-140 [8] 149-165 [5]	2	6-54 Mbps
5150-5250 5250-5350 5470-5725 5725-5850	n (HT20)	5180-5240 5260-5320 5500-5700 5745-5825	36-48 [4] 52-64 [4] 100-140 [8] 149-165 [5]	2	MCS 0-15
5150-5250 5250-5350 5470-5725 5725-5850	n (HT40)	5190-5230 5270-5310 5510-5670 5755-5795	38-46 [2] 54-62 [2] 102-134 [3] 151-159 [2]	2	MCS 0-15
5150-5250 5250-5350 5470-5725 5725-5850	ac (VHT20)	5180-5240 5260-5320 5500-5700 5745-5825	36-48 [4] 52-64 [4] 100-140 [8] 149-165 [5]	2	MCS 0-9
5150-5250 5250-5350 5470-5725 5725-5850	ac (VHT40)	5190-5230 5270-5310 5510-5670 5755-5795	38-46 [2] 54-62 [2] 102-134 [3] 151-159 [2]	2	MCS 0-9
5150-5250 5250-5350 5470-5725 5725-5850	ac (VHT80)	5210 5290 5530 5775	42 [1] 58 [1] 106 [1] 155 [1]	2	MCS 0-9

Note 1: RF output power specifies that Maximum Conducted Output Power.
 Note 2: 802.11a/n/ac uses a combination of OFDM-BPSK, QPSK, 16QAM, 64QAM, 256QAM modulation.
 Note 3: The device has disabled the 5600-5650MHz band by S/W setting.

1.1.2 Antenna Details

Ant. No.	Model	Type	Connector	Operating Frequencies (MHz) / Antenna Gain (dBi)				
				2400~2483.5	5150~5250	5250~5350	5470~5725	5725~5850
1	ANT 0	PIFA	No	-0.52	3.96	4.24	4.21	3.74
	ANT 1	PIFA	No	2.82	1.71	1.91	1.91	1.89

1.1.3 Power Supply Type of Equipment under Test (EUT)

Power Supply Type	3.3Vdc from host
--------------------------	------------------

1.1.4 Channel List

802.11 a / HT20 / VHT20		HT40 / VHT40	
Channel	Frequency(MHz)	Channel	Frequency(MHz)
36	5180	38	5190
40	5200	46	5230
44	5220	54	5270
48	5240	62	5310
52	5260	102	5510
56	5280	110	5550
60	5300	134	5670
64	5320	151	5755
100	5500	159	5795
104	5520	VHT80	
108	5540	42	5210
112	5560	58	5290
116	5580	106	5530
132	5660	155	5775
136	5680		
140	5700	---	---
149	5745	---	---
153	5765	---	---
157	5785	---	---
161	5805	---	---
165	5825	---	---

1.1.5 Test Tool and Duty Cycle

Test Tool	Realtek, Ver. 0.0006.00.20180227		
Duty Cycle and Duty Factor	Mode	Duty Cycle (%)	Duty Factor (dB)
	11a	97.46%	0.11
	VHT20	97.30%	0.12
	VHT40	94.28%	0.26
	VHT80	90.00%	0.46

1.1.6 Power Index of Test Tool

Modulation Mode	Test Frequency (MHz)	Power Index
11a	5180	46/46
11a	5200	46/46
11a	5240	46/46
11a	5260	63/63
11a	5300	63/63
11a	5320	63/63
11a	5500	56/59
11a	5580	60/63
11a	5700	59/59
11a	5745	60/60
11a	5785	57/57
11a	5825	57/57
VHT20	5180	46/46
VHT20	5200	46/46
VHT20	5240	46/46
VHT20	5260	63/63
VHT20	5300	63/63
VHT20	5320	63/63
VHT20	5500	56/59
VHT20	5580	60/63
VHT20	5700	58/58
VHT20	5745	61/61
VHT20	5785	58/58
VHT20	5825	58/58

Modulation Mode	Test Frequency (MHz)	Power Index
VHT40	5190	44/44
VHT40	5230	45/45
VHT40	5270	63/63
VHT40	5310	50/50
VHT40	5510	52/52
VHT40	5550	63/63
VHT40	5670	60/60
VHT40	5755	63/63
VHT40	5795	63/63
VHT80	5210	46/46
VHT80	5290	48/48
VHT80	5530	48/51
VHT80	5775	63/63

1.2 Local Support Equipment List

Support Equipment List					
No.	Equipment	Brand	Model	FCC ID	Remarks
1	Notebook	DELL	Latitude E6430	DoC	---
2	Fixture	---	---	---	Provided by applicant

1.3 Test Setup Chart

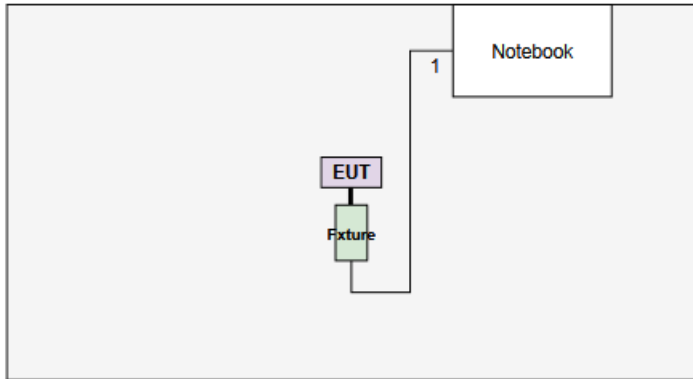
Test Setup Diagram	
	
No.	Signal cable / Length (m)
1	USB, 1m shielded.

1.4 The Equipment List

Test Item	Conducted Emission				
Test Site	Conduction room 1 / (CO01-WS)				
Instrument	Manufacturer	Model No.	Serial No.	Calibration Date	Calibration Until
Receiver	R&S	ESR3	101657	Jan. 08, 2019	Jan. 07, 2020
LISN	SCHWARZBECK	Schwarzbeck 8127	8127-667	Nov. 05, 2018	Nov. 04, 2019
RF Cable-CON	Woken	CFD200-NL	CFD200-NL-001	Oct. 23, 2018	Oct. 23, 2019
Measurement Software	AUDIX	e3	6.120210k	NA	NA

Note: Calibration Interval of instruments listed above is one year.

Test Item	Radiated Emission				
Test Site	966 chamber1 / (03CH01-WS)				
Instrument	Manufacturer	Model No.	Serial No.	Calibration Date	Calibration Until
Spectrum Analyzer	R&S	FSV40	101498	Dec. 27, 2018	Dec. 26, 2019
Receiver	R&S	ESR3	101658	Dec. 11, 2018	Dec. 10, 2019
Bilog Antenna	SCHWARZBECK	VULB9168	VULB9168-522	Jul. 12, 2019	Jul. 11, 2020
Horn Antenna 1G-18G	SCHWARZBECK	BBHA 9120 D	BBHA 9120 D 1096	Dec. 18, 2018	Dec. 17, 2019
Horn Antenna 18G-40G	SCHWARZBECK	BBHA 9170	BBHA 9170517	Nov. 15, 2018	Nov. 14, 2019
Loop Antenna	R&S	HFH2-Z2	100330	Nov. 09, 2018	Nov. 08, 2019
Loop Antenna Cable	KOAX KABEL	101354-BW	101354-BW	Oct. 08, 2018	Oct. 07, 2019
Preamplifier	EMC	EMC02325	980225	Jul. 09, 2019	Jul. 08, 2020
Preamplifier	Agilent	83017A	MY39501308	Oct. 04, 2018	Oct. 03, 2019
Preamplifier	EMC	EMC184045B	980192	Aug. 01, 2019	Jul. 31, 2020
RF Cable	EMC	EMC105-SM-SM-8000	180512	Oct. 22, 2018	Oct. 21, 2019
RF Cable	HUBER+SUHNER	SUCOFLEX104	MY16018/4	Oct. 22, 2018	Oct. 21, 2019
RF Cable	HUBER+SUHNER	SUCOFLEX104	MY16015/4	Oct. 22, 2018	Oct. 21, 2019
LF cable 3M	Woken	CFD400NL-LW	CFD400NL-003	Oct. 22, 2018	Oct. 21, 2019
LF cable 10M	EMCC	CFD400-E	CFD400-001	Oct. 22, 2018	Oct. 21, 2019
Measurement Software	AUDIX	e3	6.120210g	NA	NA

Note: Calibration Interval of instruments listed above is one year.

Test Item	RF Conducted				
Test Site	(TH01-WS)				
Instrument	Manufacturer	Model No.	Serial No.	Calibration Date	Calibration Until
Spectrum Analyzer	R&S	FSV40	101063	Apr. 17, 2019	Apr. 16, 2020
TEMP&HUMIDITY CHAMBER	GIANT FORCE	GCT-225-40-SP-SD	MAF1212-002	Dec. 05, 2018	Dec. 04, 2019
Power Meter	Anritsu	ML2495A	1241002	Oct. 09, 2018	Oct. 08, 2019
Power Sensor	Anritsu	MA2411B	1207366	Oct. 09, 2018	Oct. 08, 2019
DC POWER SOURCE	GW INSTRUK	GPC-6030D	EM892433	Oct. 25, 2018	Oct. 24, 2019
Measurement Software	SENSE-15407_NII	SENSE-15407_NII	V5.10	NA	NA
Note: Calibration Interval of instruments listed above is one year.					

1.5 Testing Applied Standards

According to the specification of EUT, the EUT must comply with following standards and KDB documents.

47 CFR FCC Part 15.407

ANSI C63.10-2013

FCC KDB 789033 D02 General UNII Test Procedures New Rules v02r01

FCC KDB 662911 D01 Multiple Transmitter Output v02r01

FCC KDB 412172 D01 Determining ERP and EIRP v01r01

1.6 Deviation from Test Standard and Measurement Procedure

None

1.7 Measurement Uncertainty

ISO/IEC 17025 requires that an estimate of the measurement uncertainties associated with the emissions test results be included in the report. The measurement uncertainties given below are based on a 95% confidence level (based on a coverage factor (k=2))

Measurement Uncertainty	
Parameters	Uncertainty
Bandwidth	±34.130 Hz
Conducted power	±0.808 dB
Frequency error	±1×10 ⁻⁹
Power density	±0.583 dB
Conducted emission	±2.715 dB
AC conducted emission	±2.92 dB
Radiated emission ≤ 1GHz	±3.41 dB
Radiated emission > 1GHz	±4.59 dB
Time	±0.1%
Temperature	±0.4 °C

2 Test Configuration

2.1 Testing Condition

Test Item	Test Site	Ambient Condition	Tested By
AC Conduction	CO01-WS	23°C / 60%	Alex Tsai
Radiated Emissions	03CH01-WS	25-26°C / 61-63%	Akun Chung Roger Lu
RF Conducted	TH01-WS	22°C / 63%	Brad Wu

- FCC Designation No.: TW2732
- FCC site registration No.: 181692
- ISED#: 10807A
- CAB identifier: TW2732

2.2 The Worst Test Modes and Channel Details

Frequency band 5150~5350 MHz / 5470~5725 MHz				
Test item	Modulation Mode	Test Frequency (MHz)	Data Rate	Test Configuration
Conducted Emissions	VHT40	5550	MCS 0	---
Radiated Emissions ≤1GHz	VHT40	5550	MCS 0	---
RF Output Power	11a	5180 / 5200 / 5240 / 5260 / 5300 5320 / 5500 / 5580 / 5700	6 Mbps	---
	HT20	5180 / 5200 / 5240 / 5260 / 5300 5320 / 5500 / 5580 / 5700	MCS 0	
	HT40	5190 / 5230/ 5270 / 5310 / 5510 5550 / 5670	MCS 0	
	VHT20	5180 / 5200 / 5240 / 5260 / 5300 5320 / 5500 / 5580 / 5700	MCS 0	
	VHT40	5190 / 5230/ 5270 / 5310 / 5510 5550 / 5670	MCS 0	
	VHT80	5210 / 5290 / 5530	MCS 0	
Radiated Emissions >1GHz Emission Bandwidth Peak Power Spectral Density	11a	5180 / 5200 / 5240 / 5260 / 5300 5320 / 5500 / 5580 / 5700	6 Mbps	---
	VHT20	5180 / 5200 / 5240 / 5260 / 5300 5320 / 5500 / 5580 / 5700	MCS 0	
	VHT40	5190 / 5230/ 5270 / 5310 / 5510 5550 / 5670	MCS 0	
	VHT80	5210 / 5290 / 5530	MCS 0	
Frequency Stability	Un-modulation	5200	---	---

NOTE:

1. The EUT was pretested with 3 orientations placed on the table for the radiated emission measurement – X, Y, and Z-plane. The **Y-plane** results were found as the worst case and were shown in this report.

Frequency band 5725-5850 MHz				
Test item	Modulation Mode	Test Frequency (MHz)	Data Rate	Test Configuration
Conducted Emissions	VHT80	5775	MCS 0	---
Radiated Emissions ≤ 1 GHz	VHT80	5775	MCS 0	---
RF Output Power	11a	5745 / 5785 / 5825	6 Mbps	---
	HT20	5745 / 5785 / 5825	MCS 0	
	HT40	5755 / 5795	MCS 0	
	VHT20	5745 / 5785 / 5825	MCS 0	
	VHT40	5755 / 5795	MCS 0	
	VHT80	5775	MCS 0	
Radiated Emissions > 1 GHz Emission Bandwidth 6dB bandwidth Peak Power Spectral Density	11a	5745 / 5785 / 5825	6 Mbps	---
	VHT20	5745 / 5785 / 5825	MCS 0	
	VHT40	5755 / 5795	MCS 0	
	VHT80	5775	MCS 0	
Frequency Stability	Un-modulation	5785	---	---

NOTE:

1. The EUT was pretested with 3 orientations placed on the table for the radiated emission measurement – X, Y, and Z-plane. The **Y-plane** results were found as the worst case and were shown in this report.

3 Transmitter Test Results

3.1 Conducted Emissions

3.1.1 Limit of Conducted Emissions

Conducted Emissions Limit		
Frequency Emission (MHz)	Quasi-Peak	Average
0.15-0.5	66 - 56 *	56 - 46 *
0.5-5	56	46
5-30	60	50

Note 1: * Decreases with the logarithm of the frequency.

3.1.2 Test Procedures

1. The device is placed on a test table, raised 80 cm above the reference ground plane. The vertical conducting plane is located 40 cm to the rear of the device.
2. The device is connected to line impedance stabilization network (LISN) and other accessories are connected to other LISN. Measured levels of AC power line conducted emission are across the 50 Ω LISN port.
3. AC conducted emission measurements is made over frequency range from 150 kHz to 30 MHz.
4. This measurement was performed with AC 120V/60Hz

3.1.3 Test Setup

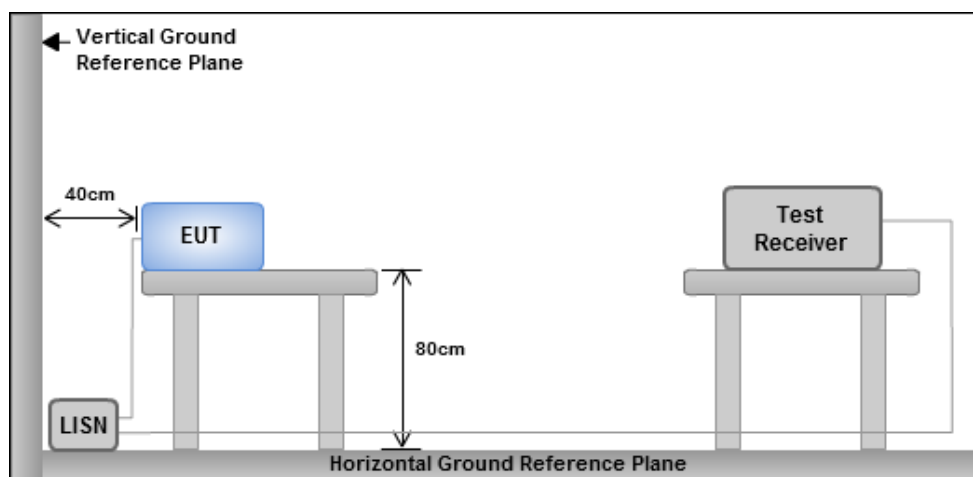

- Note: 1. Support units were connected to second LISN.
 2. Both of LISNs (AMN) are 80 cm from EUT and at least 80 cm from other units and other metal planes

3.1.4 Test Result of Conducted Emissions

Modulation	VHT40	Test Freq. (MHz)	5550
Power Phase	Line		

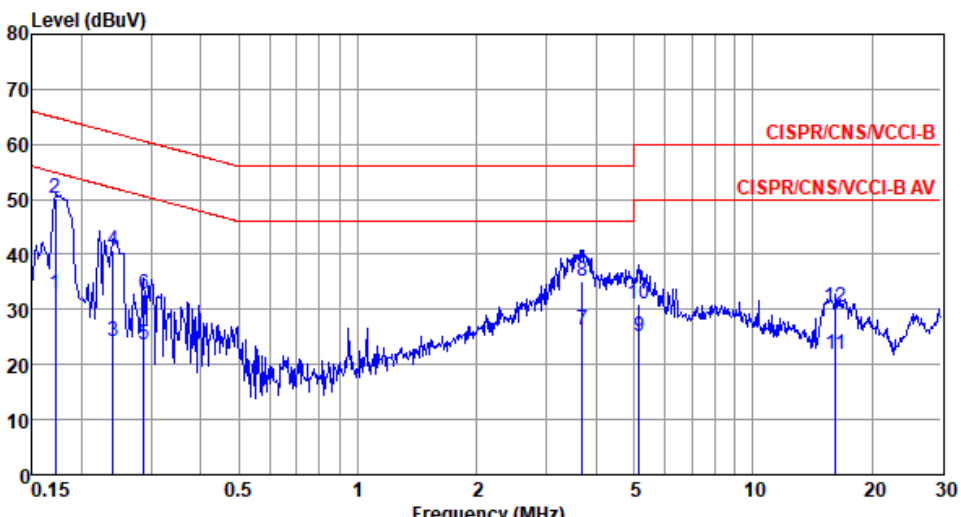

	Freq MHz	Level dBuA	Limit Line dBuA	Over Limit dB	Read Level dBuA	LISN factor dB	cable loss dB	Remark
1	0.171	32.70	54.90	-22.20	23.11	9.53	0.06	Average
2*	0.171	50.23	64.90	-14.67	40.64	9.53	0.06	QP
3	0.240	24.35	52.08	-27.73	14.73	9.55	0.07	Average
4	0.240	40.69	62.08	-21.39	31.07	9.55	0.07	QP
5	0.288	23.54	50.59	-27.05	13.90	9.56	0.08	Average
6	0.288	32.66	60.59	-27.93	23.02	9.56	0.08	QP
7	3.700	26.34	46.00	-19.66	16.46	9.61	0.27	Average
8	3.700	35.15	56.00	-20.85	25.27	9.61	0.27	QP
9	5.139	25.21	50.00	-24.79	15.27	9.62	0.32	Average
10	5.139	30.99	60.00	-29.01	21.05	9.62	0.32	QP
11	16.226	21.95	50.00	-28.05	11.72	9.66	0.57	Average
12	16.226	30.36	60.00	-29.64	20.13	9.66	0.57	QP

Note 1: Level (dBuV) = Read Level (dBuV) + LISN Factor (dB) + Cable Loss (dB).
 Note 2: Over Limit (dB) = Level (dBuV) – Limit Line (dBuV).

Modulation	VHT40	Test Freq. (MHz)	5550
Power Phase	Neutral		

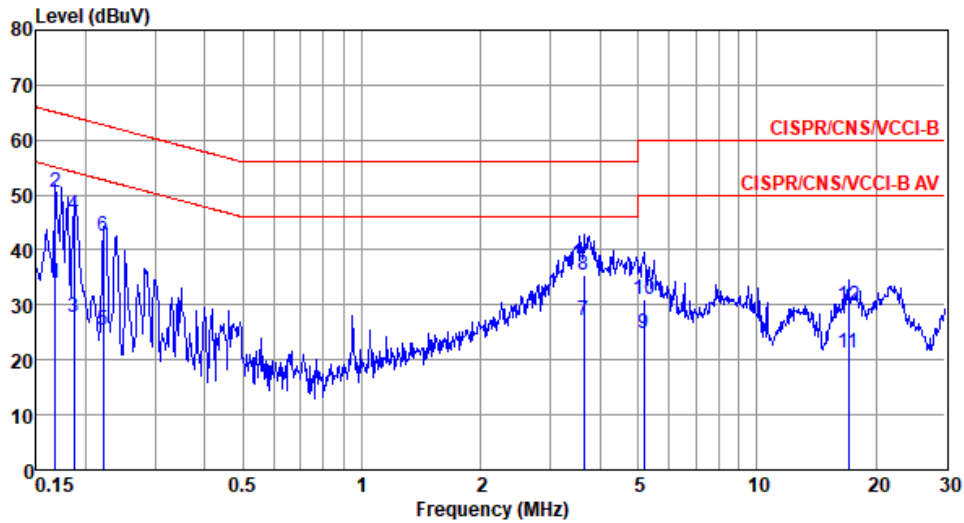

	Freq MHz	Level dBuA	Limit Line dBuA	Over Limit dB	Read Level dBuA	LISN factor dB	cable loss dB	Remark
1	0.168	34.03	55.08	-21.05	24.40	9.57	0.06	Average
2*	0.168	50.48	65.08	-14.60	40.85	9.57	0.06	QP
3	0.186	27.74	54.20	-26.46	18.09	9.58	0.07	Average
4	0.186	46.42	64.20	-17.78	36.77	9.58	0.07	QP
5	0.222	25.53	52.74	-27.21	15.88	9.58	0.07	Average
6	0.222	42.50	62.74	-20.24	32.85	9.58	0.07	QP
7	3.642	27.05	46.00	-18.95	17.13	9.66	0.26	Average
8	3.642	35.28	56.00	-20.72	25.36	9.66	0.26	QP
9	5.166	24.89	50.00	-25.11	14.90	9.67	0.32	Average
10	5.166	31.03	60.00	-28.97	21.04	9.67	0.32	QP
11	17.018	21.39	50.00	-28.61	11.02	9.79	0.58	Average
12	17.018	29.94	60.00	-30.06	19.57	9.79	0.58	QP

Note 1: Level (dBuV) = Read Level (dBuV) + LISN Factor (dB) + Cable Loss (dB).
 2: Over Limit (dB) = Level (dBuV) – Limit Line (dBuV).

Modulation	VHT80	Test Freq. (MHz)	5775
Power Phase	Line		

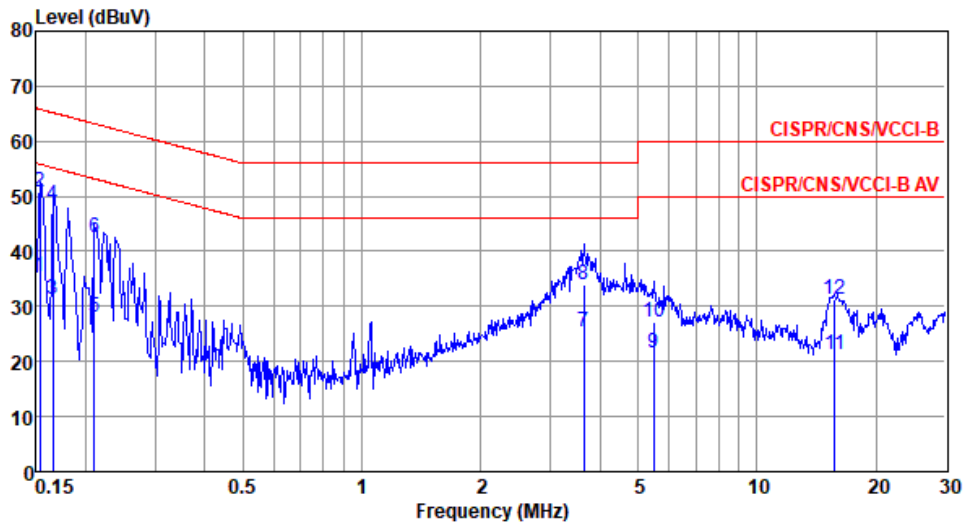

	Freq MHz	Level dBuA	Limit Line dBuA	Over Limit dB	Read Level dBuA	LISN factor dB	cable loss dB	Remark
1	0.153	35.57	55.82	-20.25	25.99	9.53	0.05	Average
2*	0.153	50.76	65.82	-15.06	41.18	9.53	0.05	QP
3	0.165	31.34	55.21	-23.87	21.75	9.53	0.06	Average
4	0.165	48.44	65.21	-16.77	38.85	9.53	0.06	QP
5	0.211	28.07	53.18	-25.11	18.46	9.54	0.07	Average
6	0.211	42.47	63.18	-20.71	32.86	9.54	0.07	QP
7	3.642	25.52	46.00	-20.48	15.65	9.61	0.26	Average
8	3.642	33.99	56.00	-22.01	24.12	9.61	0.26	QP
9	5.476	21.58	50.00	-28.42	11.63	9.62	0.33	Average
10	5.476	27.20	60.00	-32.80	17.25	9.62	0.33	QP
11	15.718	21.30	50.00	-28.70	11.07	9.66	0.57	Average
12	15.718	31.16	60.00	-28.84	20.93	9.66	0.57	QP

Note 1: Level (dBuV) = Read Level (dBuV) + LISN Factor (dB) + Cable Loss (dB).
 Note 2: Over Limit (dB) = Level (dBuV) – Limit Line (dBuV).

Modulation	VHT80	Test Freq. (MHz)	5775
Power Phase	Neutral		

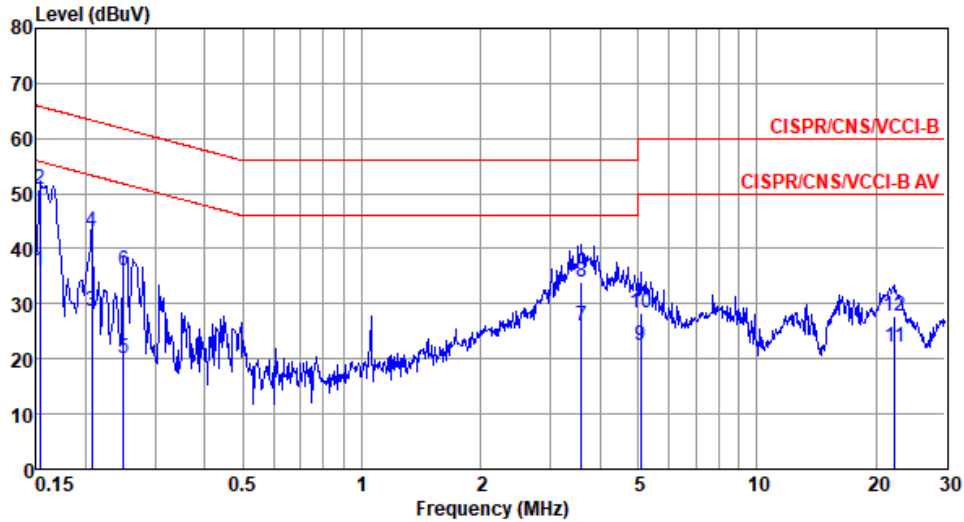

	Freq MHz	Level dBuA	Limit Line dBuA	Over Limit dB	Read Level dBuA	LISN factor dB	cable loss dB	Remark
1	0.153	36.06	55.82	-19.76	26.44	9.57	0.05	Average
2*	0.153	50.85	65.82	-14.97	41.23	9.57	0.05	QP
3	0.207	28.58	53.32	-24.74	18.93	9.58	0.07	Average
4	0.207	42.97	63.32	-20.35	33.32	9.58	0.07	QP
5	0.249	20.11	51.78	-31.67	10.45	9.59	0.07	Average
6	0.249	36.01	61.78	-25.77	26.35	9.59	0.07	QP
7	3.603	26.02	46.00	-19.98	16.10	9.66	0.26	Average
8	3.603	34.00	56.00	-22.00	24.08	9.66	0.26	QP
9	5.085	22.52	50.00	-27.48	12.53	9.67	0.32	Average
10	5.085	28.24	60.00	-31.76	18.25	9.67	0.32	QP
11	22.298	22.22	50.00	-27.78	11.77	9.81	0.64	Average
12	22.298	27.77	60.00	-32.23	17.32	9.81	0.64	QP

Note 1: Level (dBuV) = Read Level (dBuV) + LISN Factor (dB) + Cable Loss (dB).
 2: Over Limit (dB) = Level (dBuV) – Limit Line (dBuV).

3.2 Emission Bandwidth

3.2.1 Limit of Emission Bandwidth

Within the 5.725-5.85 GHz band, the minimum 6 dB bandwidth of U-NII devices shall be at least 500 kHz.

3.2.2 Test Procedures

26dB Bandwidth

1. Set RBW = approximately 1% of the emission bandwidth.
2. Set the VBW > RBW, Detector = Peak.
3. Trace mode = max hold.
4. Measure the maximum width of the emission that is 26 dB down from the peak of the emission.

Occupied Bandwidth

1. Set RBW = 1 % to 5 % of the OBW.
2. Set VBW \geq 3 RBW.
3. Sample detection and single sweep mode shall be used.
4. Use the 99 % power bandwidth function of the instrument.

6dB Bandwidth

1. Set RBW = 100kHz, VBW = 300kHz.
2. Detector = Peak, Trace mode = max hold.
3. Allow the trace to stabilize.
4. Measure the maximum width of the emission that is constrained by the frequencies associated with the two outermost amplitude points (upper and lower frequencies) that are attenuated by 6 dB relative to the maximum level measured in the fundamental emission.

3.2.3 Test Setup

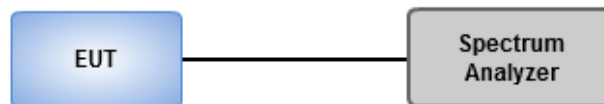

3.2.4 Test Result of Emission Bandwidth

Summary

Mode	Max-N dB (Hz)	Max-OBW (Hz)	ITU-Code	Min-N dB (Hz)	Min-OBW (Hz)
5.15-5.25GHz	-	-	-	-	-
802.11a_Nss1,(6Mbps)_2TX	20.725M	16.57M	16M6D1D	19.928M	16.498M
802.11ac VHT20_Nss1,(MCS0)_2TX	21.594M	17.656M	17M7D1D	20.87M	17.511M
802.11ac VHT40_Nss1,(MCS0)_2TX	43.623M	36.614M	36M6D1D	42.899M	36.469M
802.11ac VHT80_Nss1,(MCS0)_2TX	82.899M	75.832M	75M8D1D	82.319M	75.543M
5.25-5.35GHz	-	-	-	-	-
802.11a_Nss1,(6Mbps)_2TX	31.159M	16.715M	16M7D1D	25M	16.57M
802.11ac VHT20_Nss1,(MCS0)_2TX	31.159M	17.8M	17M8D1D	23.986M	17.656M
802.11ac VHT40_Nss1,(MCS0)_2TX	71.739M	36.903M	36M9D1D	43.188M	36.469M
802.11ac VHT80_Nss1,(MCS0)_2TX	82.319M	75.543M	75M5D1D	82.029M	75.543M
5.47-5.725GHz	-	-	-	-	-
802.11a_Nss1,(6Mbps)_2TX	37.391M	17.004M	17M0D1D	20.87M	16.57M
802.11ac VHT20_Nss1,(MCS0)_2TX	39.058M	18.017M	18M0D1D	21.014M	17.583M
802.11ac VHT40_Nss1,(MCS0)_2TX	81.159M	38.495M	38M5D1D	43.478M	36.469M
802.11ac VHT80_Nss1,(MCS0)_2TX	83.768M	75.832M	75M8D1D	81.739M	75.832M
5.725-5.85GHz	-	-	-	-	-
802.11a_Nss1,(6Mbps)_2TX	16.304M	16.715M	16M7D1D	16.304M	16.498M
802.11ac VHT20_Nss1,(MCS0)_2TX	17.029M	17.8M	17M8D1D	16.014M	17.583M
802.11ac VHT40_Nss1,(MCS0)_2TX	36.232M	37.482M	37M5D1D	35.072M	36.758M
802.11ac VHT80_Nss1,(MCS0)_2TX	75.362M	76.7M	76M7D1D	75.362M	75.832M

Max-N dB = Maximum6dB downbandwidth for 5.725-5.85GHz band / Maximum26dB downbandwidth for other band;

Max-OBW = Maximum99% occupied bandwidth;

Min-N dB = Minimum6dB downbandwidth for 5.725-5.85GHz band / Maximum26dB downbandwidth for other band;

Min-OBW = Minimum99% occupied bandwidth;

Result

Mode	Result	Limit (Hz)	Port 1-N dB (Hz)	Port 1-OBW (Hz)	Port 2-N dB (Hz)	Port 2-OBW (Hz)
802.11a_Nss1,(6Mbps)_2TX	-	-	-	-	-	-
5180MHz	Pass	Inf	20M	16.57M	20.58M	16.57M
5200MHz	Pass	Inf	19.928M	16.57M	20.362M	16.57M
5240MHz	Pass	Inf	19.928M	16.498M	20.725M	16.57M
5260MHz	Pass	Inf	31.159M	16.715M	25.652M	16.715M
5300MHz	Pass	Inf	25.435M	16.715M	25.217M	16.643M
5320MHz	Pass	Inf	25M	16.643M	25.145M	16.57M
5500MHz	Pass	Inf	32.029M	16.932M	21.449M	16.57M
5580MHz	Pass	Inf	37.391M	17.004M	26.159M	16.715M
5700MHz	Pass	Inf	27.464M	16.715M	20.87M	16.57M
5745MHz	Pass	500k	16.304M	16.715M	16.304M	16.57M
5785MHz	Pass	500k	16.304M	16.57M	16.304M	16.57M
5825MHz	Pass	500k	16.304M	16.57M	16.304M	16.498M
802.11ac VHT20_Nss1,(MCS0)_2TX	-	-	-	-	-	-
5180MHz	Pass	Inf	21.087M	17.583M	20.942M	17.583M
5200MHz	Pass	Inf	21.594M	17.583M	20.942M	17.511M
5240MHz	Pass	Inf	21.594M	17.656M	20.87M	17.583M
5260MHz	Pass	Inf	30.652M	17.8M	27.536M	17.728M
5300MHz	Pass	Inf	31.159M	17.656M	23.986M	17.656M
5320MHz	Pass	Inf	26.449M	17.656M	26.014M	17.728M
5500MHz	Pass	Inf	27.101M	17.728M	23.768M	17.583M
5580MHz	Pass	Inf	39.058M	18.017M	26.232M	17.656M
5700MHz	Pass	Inf	28.188M	17.728M	21.014M	17.656M
5745MHz	Pass	500k	16.522M	17.8M	17.029M	17.583M
5785MHz	Pass	500k	16.522M	17.728M	16.957M	17.656M
5825MHz	Pass	500k	16.884M	17.656M	16.014M	17.583M
802.11ac VHT40_Nss1,(MCS0)_2TX	-	-	-	-	-	-
5190MHz	Pass	Inf	43.333M	36.614M	43.333M	36.614M
5230MHz	Pass	Inf	43.623M	36.469M	42.899M	36.614M
5270MHz	Pass	Inf	71.739M	36.903M	58.986M	36.758M
5310MHz	Pass	Inf	43.188M	36.469M	43.188M	36.614M
5510MHz	Pass	Inf	44.783M	36.758M	44.203M	36.469M
5550MHz	Pass	Inf	81.159M	38.495M	65.217M	36.758M
5670MHz	Pass	Inf	74.203M	37.048M	43.478M	36.614M

Mode	Result	Limit (Hz)	Port 1-N dB (Hz)	Port 1-OBW (Hz)	Port 2-N dB (Hz)	Port 2-OBW (Hz)
5755MHz	Pass	500k	35.652M	37.482M	35.072M	36.758M
5795MHz	Pass	500k	36.232M	37.482M	35.797M	36.758M
802.11ac VHT80_Nss1,(MCS0)_2TX	-	-	-	-	-	-
5210MHz	Pass	Inf	82.899M	75.832M	82.319M	75.543M
5290MHz	Pass	Inf	82.029M	75.543M	82.319M	75.543M
5530MHz	Pass	Inf	83.768M	75.832M	81.739M	75.832M
5775MHz	Pass	500k	75.362M	76.7M	75.362M	75.832M

Port X-N dB = Port X6dB downbandwidth for 5.725-5.85GHz band / 26dB downbandwidth for other band
Port X-OBW = Port X99% occupied bandwidth;

802.11a_Nss1,(6Mbps)_2TX

EBW

5180MHz

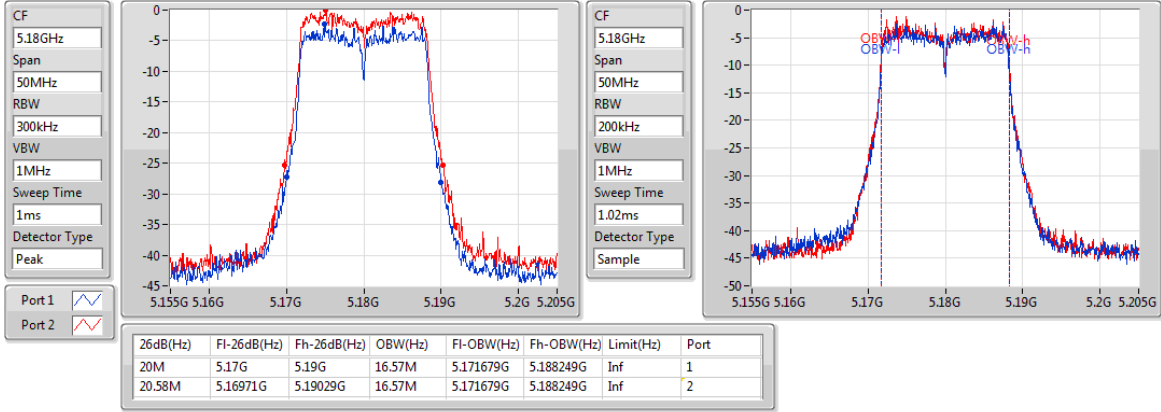

802.11a_Nss1,(6Mbps)_2TX

EBW

5200MHz

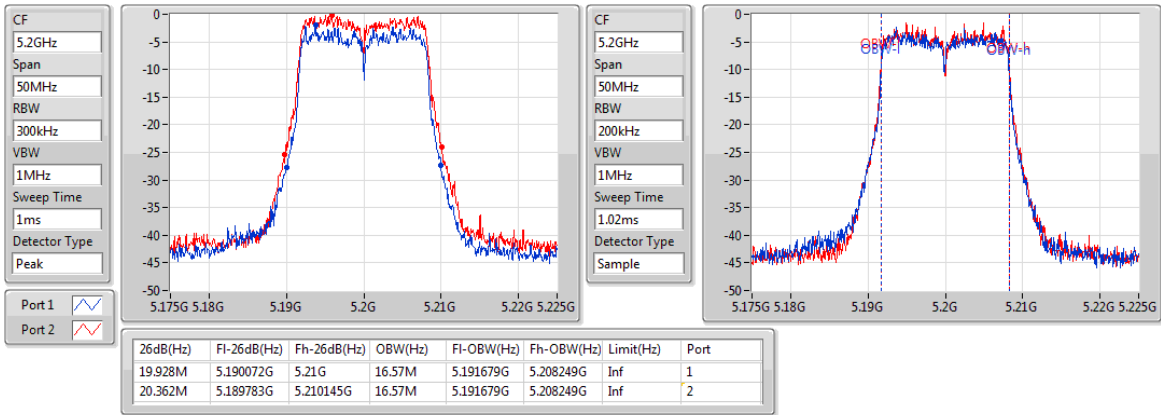

802.11a_Nss1,(6Mbps)_2TX

EBW

5240MHz

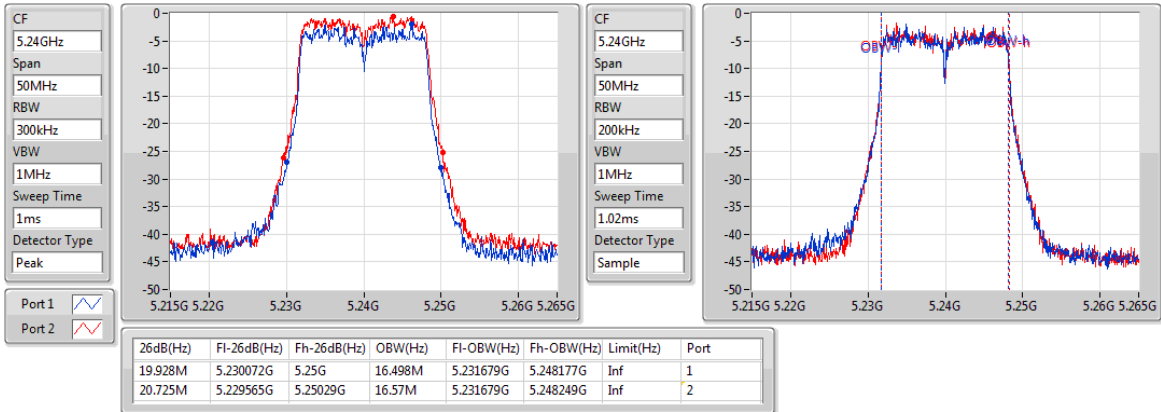

802.11a_Nss1,(6Mbps)_2TX

EBW

5260MHz

CF
5.26GHz
Span
50MHz
RBW
300kHz
VBW
1MHz
Sweep Time
1ms
Detector Type
Peak

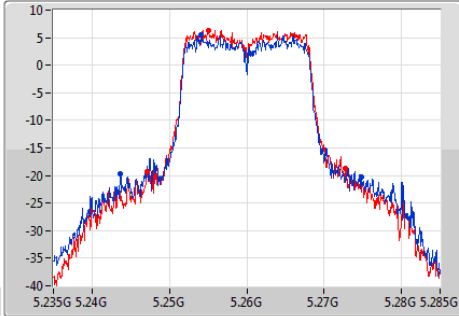

CF
5.26GHz
Span
50MHz
RBW
200kHz
VBW
1MHz
Sweep Time
1.02ms
Detector Type
Sample

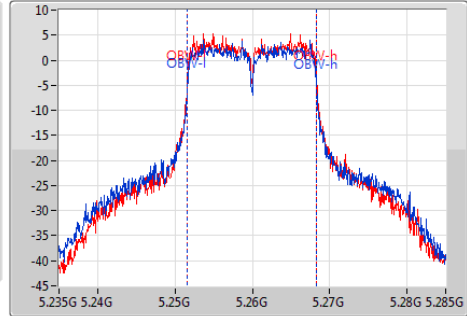

26dB(Hz)	Fl-26dB(Hz)	Fh-26dB(Hz)	OBW(Hz)	Fl-OBW(Hz)	Fh-OBW(Hz)	Limit(Hz)	Port
31.159M	5.243623G	5.274783G	16.715M	5.251606G	5.268321G	Inf	1
25.652M	5.247101G	5.272754G	16.715M	5.251606G	5.268321G	Inf	2

802.11a_Nss1,(6Mbps)_2TX

EBW

5300MHz

CF
5.3GHz
Span
50MHz
RBW
300kHz
VBW
1MHz
Sweep Time
1ms
Detector Type
Peak

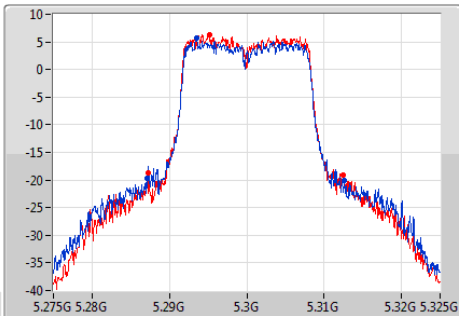

CF
5.3GHz
Span
50MHz
RBW
200kHz
VBW
1MHz
Sweep Time
1.02ms
Detector Type
Sample

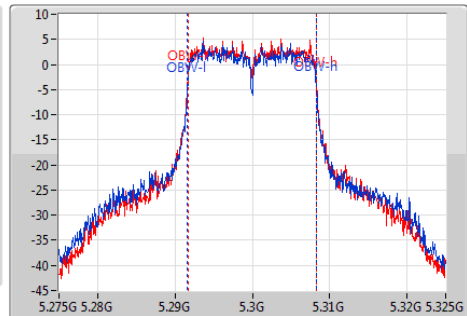

26dB(Hz)	Fl-26dB(Hz)	Fh-26dB(Hz)	OBW(Hz)	Fl-OBW(Hz)	Fh-OBW(Hz)	Limit(Hz)	Port
25.435M	5.287101G	5.312536G	16.715M	5.291606G	5.308321G	Inf	1
25.217M	5.287246G	5.312464G	16.643M	5.291679G	5.308321G	Inf	2

802.11a_Nss1,(6Mbps)_2TX

EBW

5320MHz

CF
5.32GHz
Span
50MHz
RBW
300kHz
VBW
1MHz
Sweep Time
1ms
Detector Type
Peak

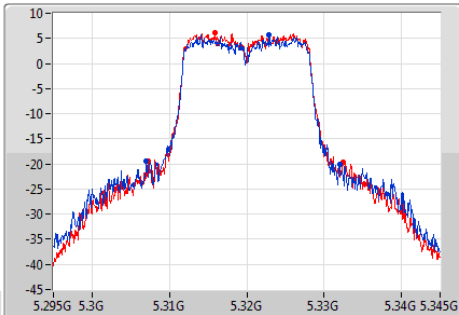

CF
5.32GHz
Span
50MHz
RBW
200kHz
VBW
1MHz
Sweep Time
1.02ms
Detector Type
Sample

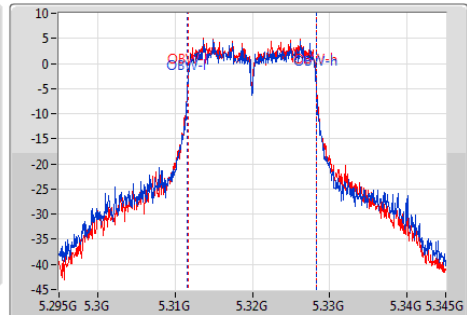

26dB(Hz)	Fl-26dB(Hz)	Fh-26dB(Hz)	OBW(Hz)	Fl-OBW(Hz)	Fh-OBW(Hz)	Limit(Hz)	Port
25M	5.307029G	5.332029G	16.643M	5.311606G	5.328249G	Inf	1
25.145M	5.307319G	5.332464G	16.57M	5.311679G	5.328249G	Inf	2

802.11a_Nss1,(6Mbps)_2TX

EBW

5500MHz

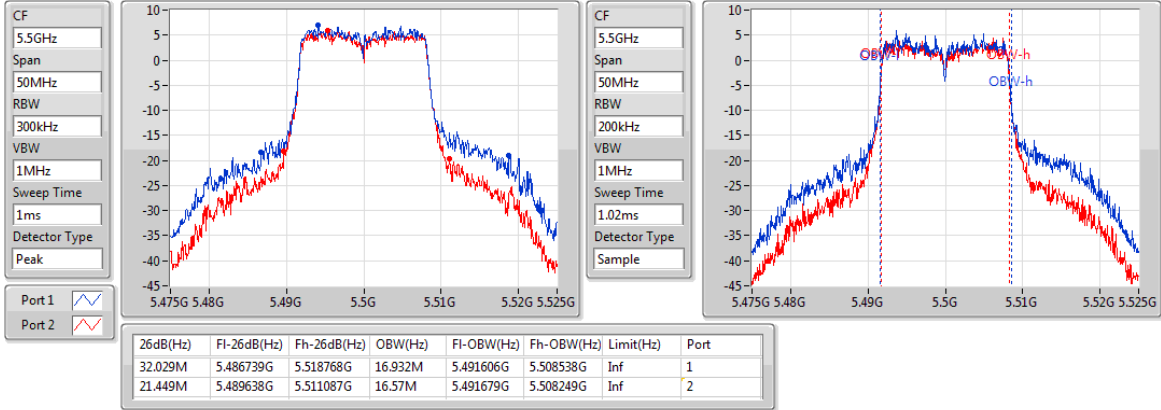

802.11a_Nss1,(6Mbps)_2TX

EBW

5580MHz

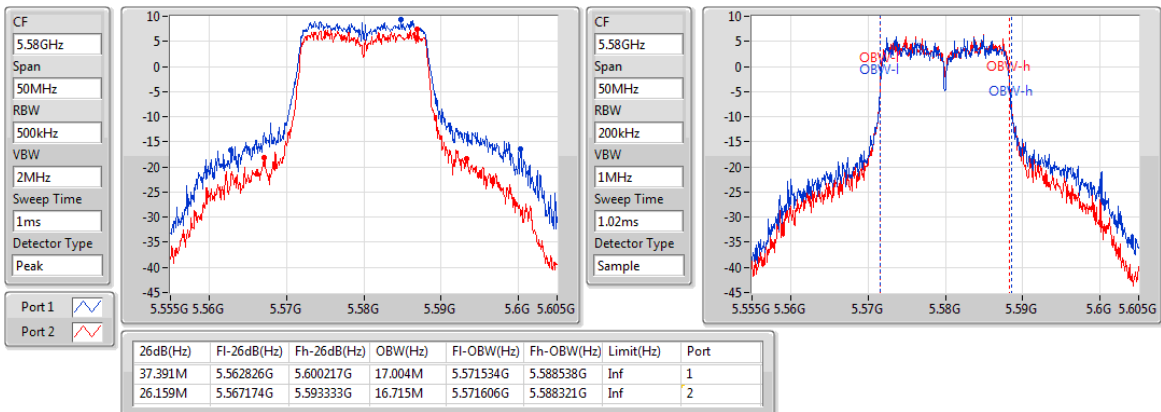

802.11a_Nss1,(6Mbps)_2TX

EBW

5700MHz

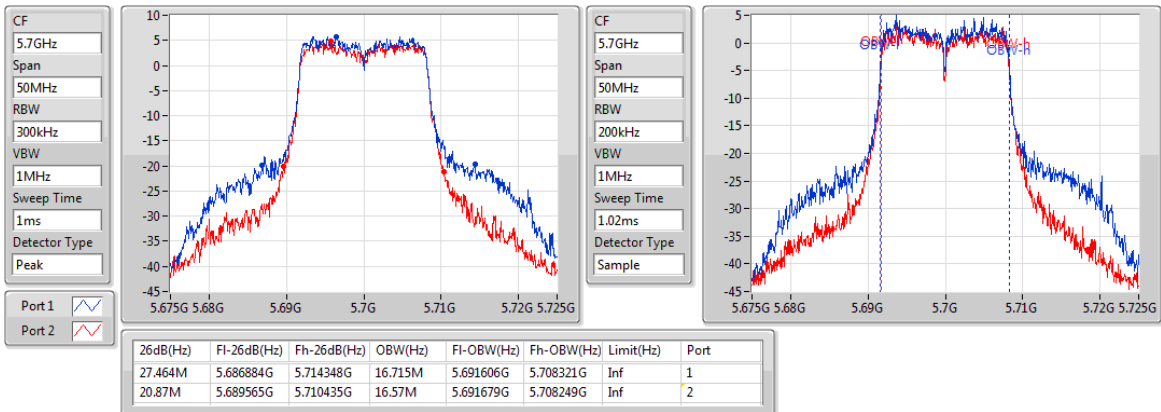

802.11a_Nss1,(6Mbps)_2TX

EBW

5745MHz

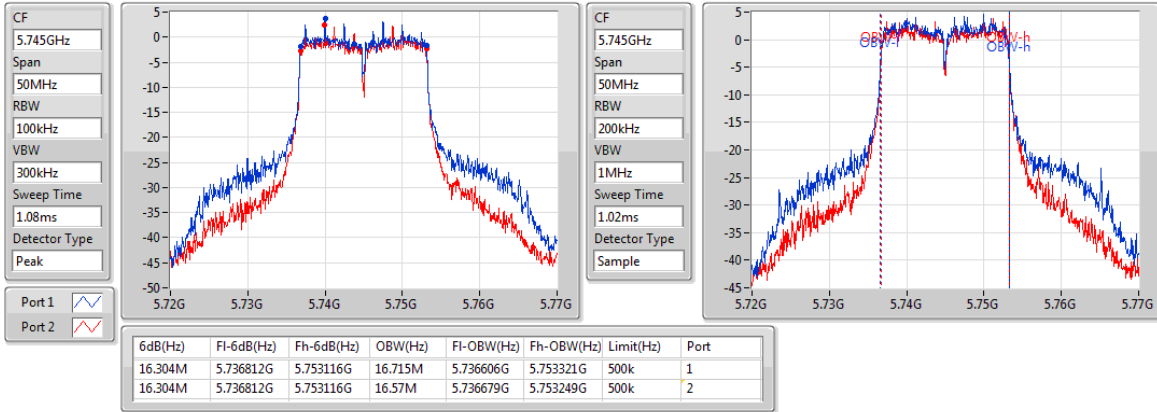

802.11a_Nss1,(6Mbps)_2TX

EBW

5785MHz

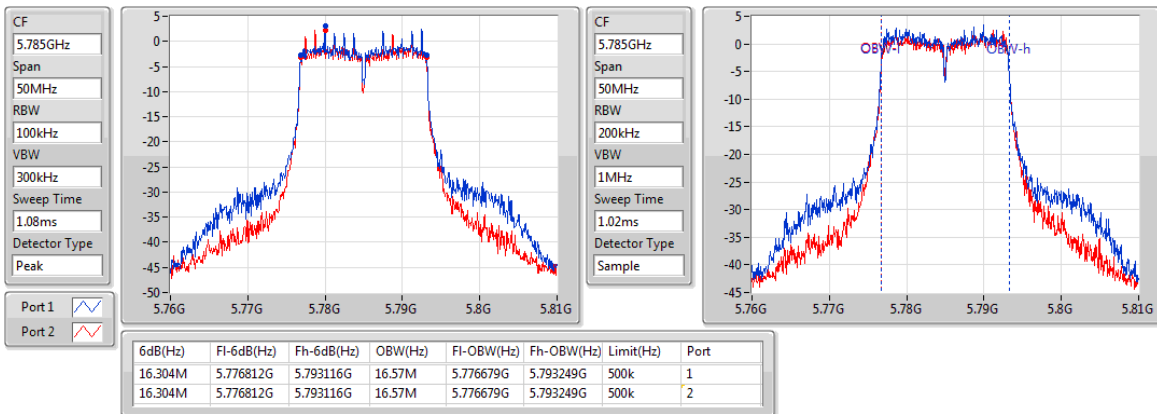

802.11a_Nss1,(6Mbps)_2TX

EBW

5825MHz

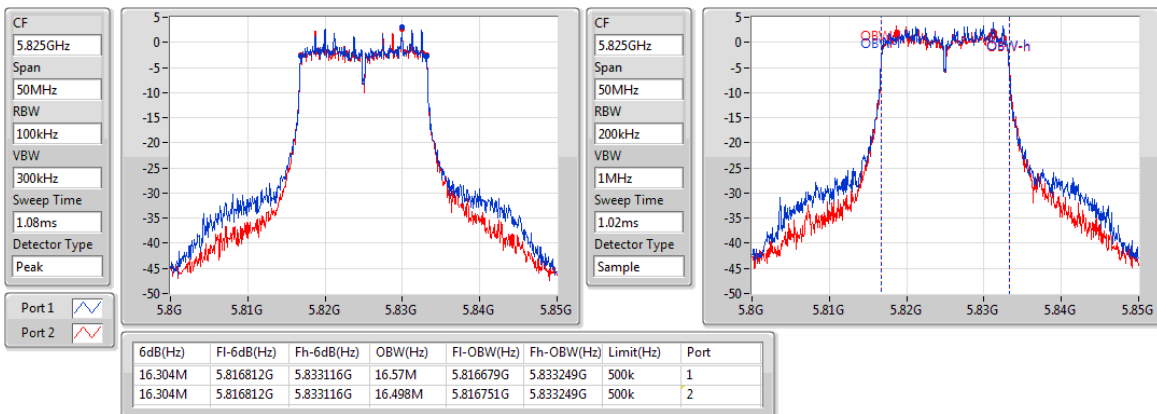

802.11ac VHT20_Nss1,(MCS0)_2TX

EBW

5180MHz

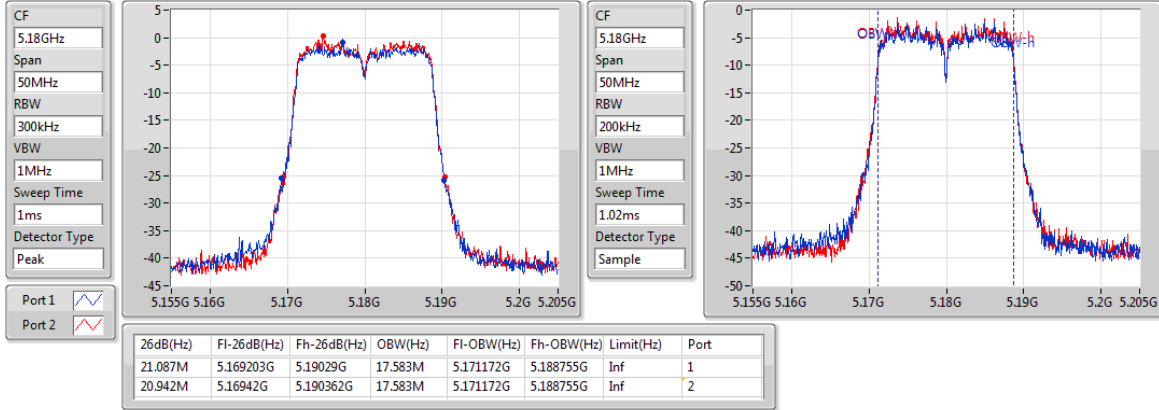

802.11ac VHT20_Nss1,(MCS0)_2TX

EBW

5200MHz

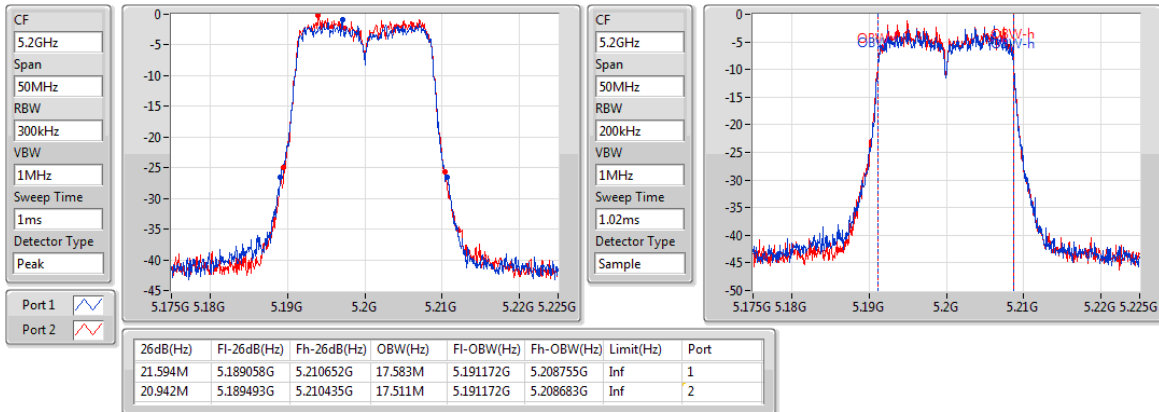

802.11ac VHT20_Nss1,(MCS0)_2TX

EBW

5240MHz

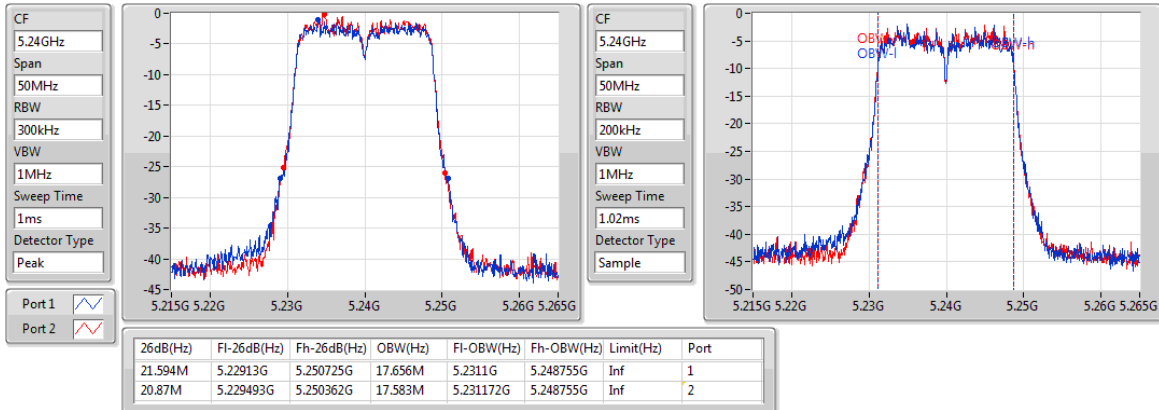

802.11ac VHT20_Nss1,(MCS0)_2TX

EBW

5260MHz

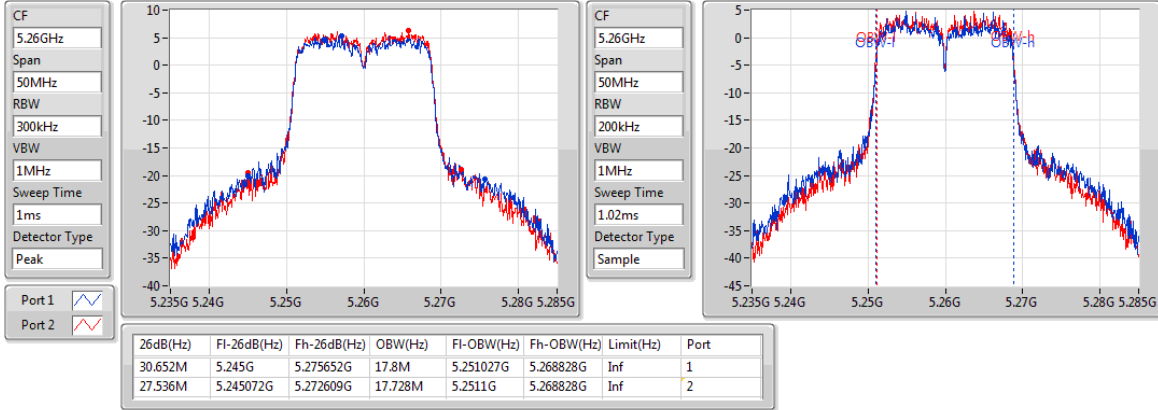

802.11ac VHT20_Nss1,(MCS0)_2TX

EBW

5300MHz

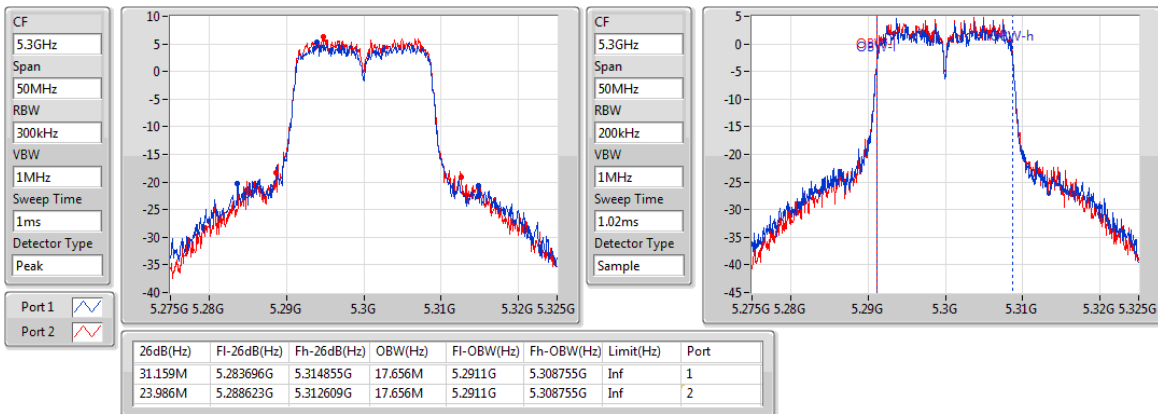

802.11ac VHT20_Nss1,(MCS0)_2TX

EBW

5320MHz

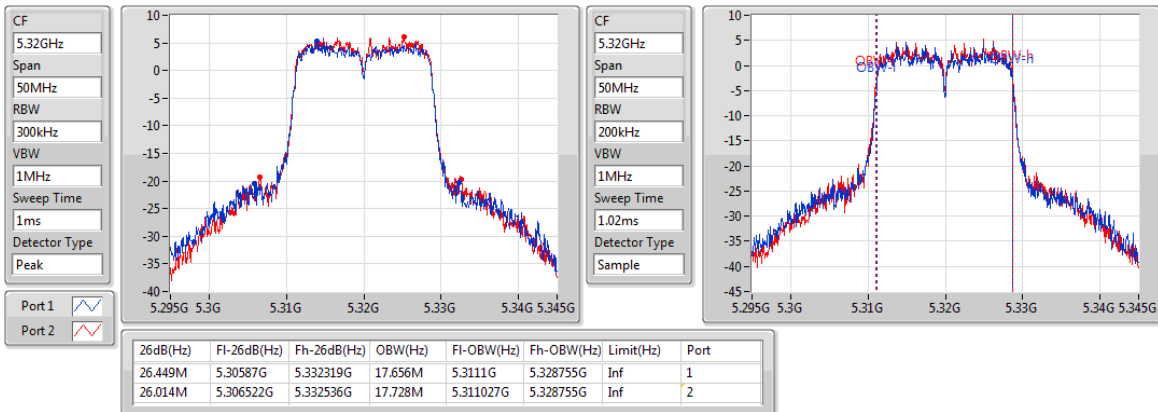

802.11ac VHT20_Nss1,(MCS0)_2TX

EBW

5500MHz

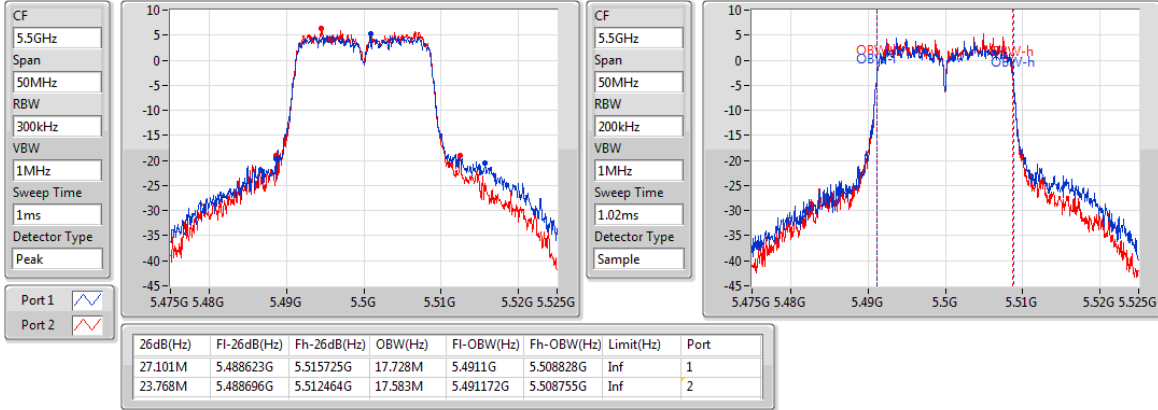

802.11ac VHT20_Nss1,(MCS0)_2TX

EBW

5580MHz

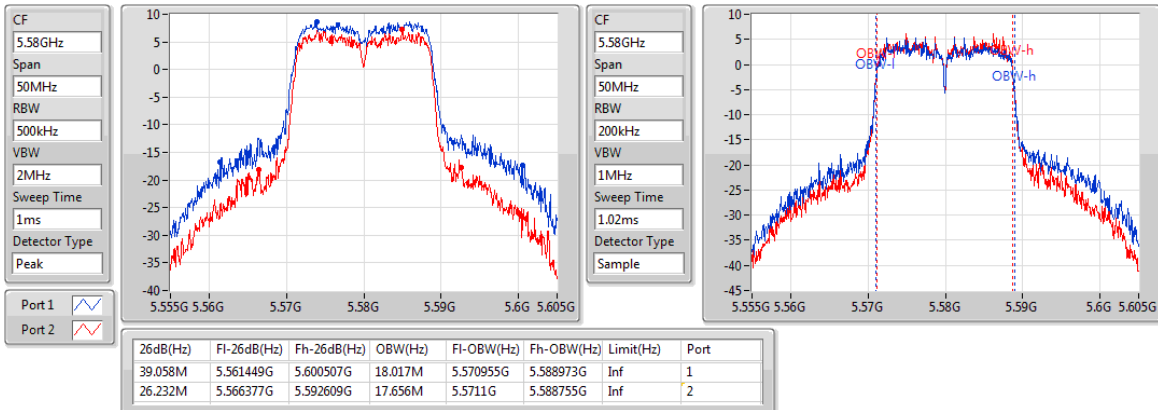

802.11ac VHT20_Nss1,(MCS0)_2TX

EBW

5700MHz

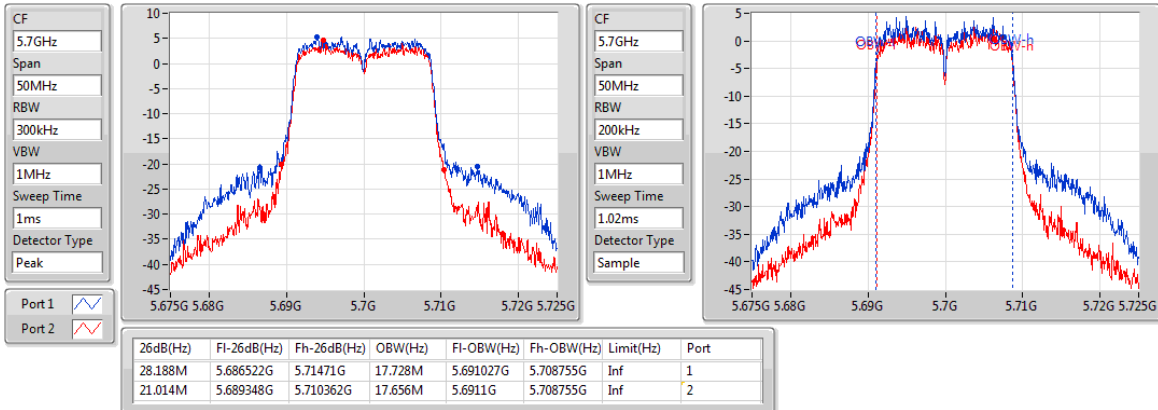

802.11ac VHT20_Nss1,(MCS0)_2TX

EBW

5745MHz

CF
5.745GHz
Span
50MHz
RBW
100kHz
VBW
300kHz
Sweep Time
1.08ms
Detector Type
Peak

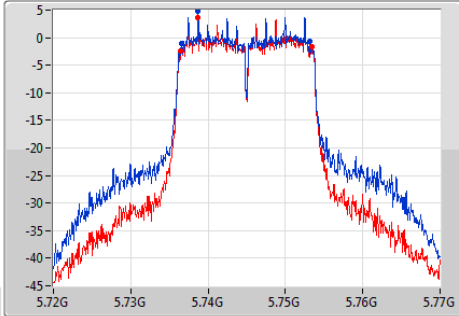

CF
5.745GHz
Span
50MHz
RBW
200kHz
VBW
1MHz
Sweep Time
1.02ms
Detector Type
Sample

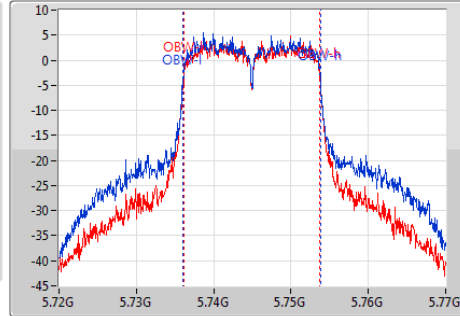

6dB(Hz)	Fl-6dB(Hz)	Fh-6dB(Hz)	OBW(Hz)	Fl-OBW(Hz)	Fh-OBW(Hz)	Limit(Hz)	Port
16.522M	5.736594G	5.753116G	17.8M	5.736027G	5.753828G	500k	1
17.029M	5.736449G	5.753478G	17.583M	5.736172G	5.753755G	500k	2

802.11ac VHT20_Nss1,(MCS0)_2TX

EBW

5785MHz

CF
5.785GHz
Span
50MHz
RBW
100kHz
VBW
300kHz
Sweep Time
1.08ms
Detector Type
Peak

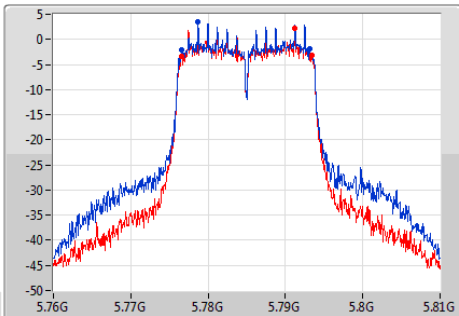

CF
5.785GHz
Span
50MHz
RBW
200kHz
VBW
1MHz
Sweep Time
1.02ms
Detector Type
Sample

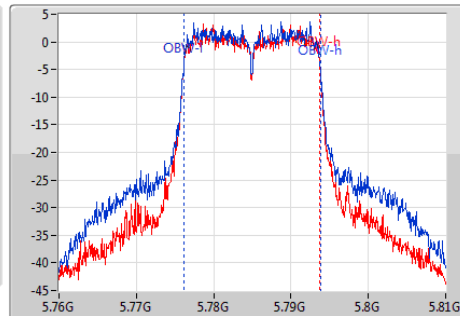

6dB(Hz)	Fl-6dB(Hz)	Fh-6dB(Hz)	OBW(Hz)	Fl-OBW(Hz)	Fh-OBW(Hz)	Limit(Hz)	Port
16.522M	5.776594G	5.793116G	17.728M	5.7761G	5.793828G	500k	1
16.957M	5.776522G	5.793478G	17.656M	5.7761G	5.793755G	500k	2

802.11ac VHT20_Nss1,(MCS0)_2TX

EBW

5825MHz

CF
5.825GHz
Span
50MHz
RBW
100kHz
VBW
300kHz
Sweep Time
1.08ms
Detector Type
Peak

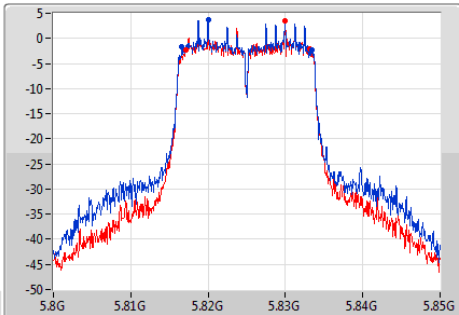

CF
5.825GHz
Span
50MHz
RBW
200kHz
VBW
1MHz
Sweep Time
1.02ms
Detector Type
Sample

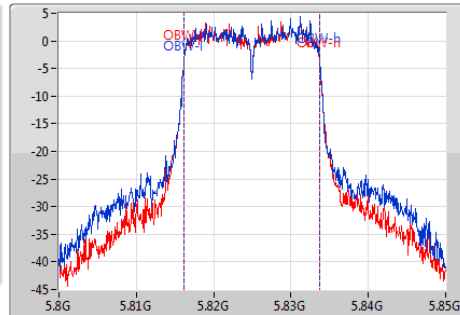

6dB(Hz)	Fl-6dB(Hz)	Fh-6dB(Hz)	OBW(Hz)	Fl-OBW(Hz)	Fh-OBW(Hz)	Limit(Hz)	Port
16.884M	5.816594G	5.833478G	17.656M	5.8161G	5.833755G	500k	1
16.014M	5.817101G	5.833116G	17.583M	5.816172G	5.833755G	500k	2

802.11ac VHT40_Nss1,(MCS0)_2TX

EBW

5190MHz

CF
5.19GHz
Span
100MHz
RBW
500kHz
VBW
2MHz
Sweep Time
1ms
Detector Type
Peak

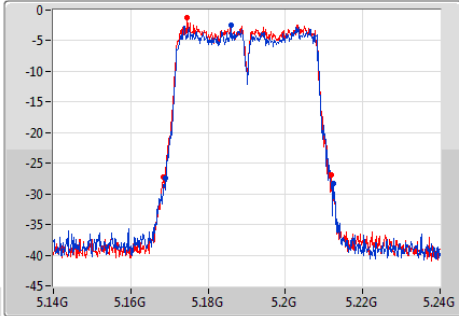

CF
5.19GHz
Span
100MHz
RBW
500kHz
VBW
2MHz
Sweep Time
1ms
Detector Type
Sample

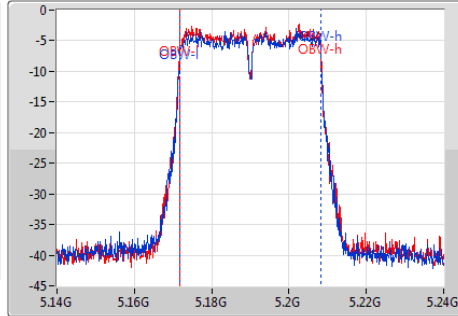

26dB(Hz)	Fl-26dB(Hz)	Fh-26dB(Hz)	OBW(Hz)	Fl-OBW(Hz)	Fh-OBW(Hz)	Limit(Hz)	Port
43.333M	5.168986G	5.212319G	36.614M	5.171621G	5.208234G	Inf	1
43.333M	5.168551G	5.211884G	36.614M	5.171621G	5.208234G	Inf	2

802.11ac VHT40_Nss1,(MCS0)_2TX

EBW

5230MHz

CF
5.23GHz
Span
100MHz
RBW
500kHz
VBW
2MHz
Sweep Time
1ms
Detector Type
Peak

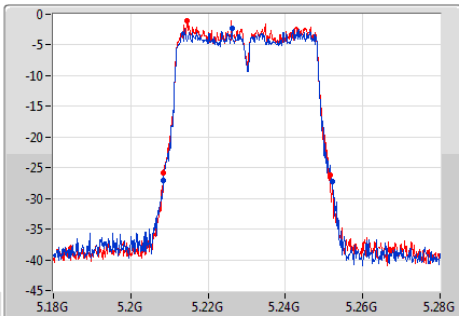

CF
5.23GHz
Span
100MHz
RBW
500kHz
VBW
2MHz
Sweep Time
1ms
Detector Type
Sample

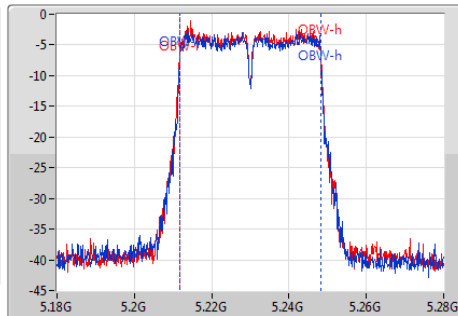

26dB(Hz)	Fl-26dB(Hz)	Fh-26dB(Hz)	OBW(Hz)	Fl-OBW(Hz)	Fh-OBW(Hz)	Limit(Hz)	Port
43.623M	5.208551G	5.252174G	36.469M	5.211766G	5.248234G	Inf	1
42.899M	5.208551G	5.251449G	36.614M	5.211621G	5.248234G	Inf	2

802.11ac VHT40_Nss1,(MCS0)_2TX

EBW

5270MHz

CF
5.27GHz
Span
100MHz
RBW
1MHz
VBW
3MHz
Sweep Time
1ms
Detector Type
Peak

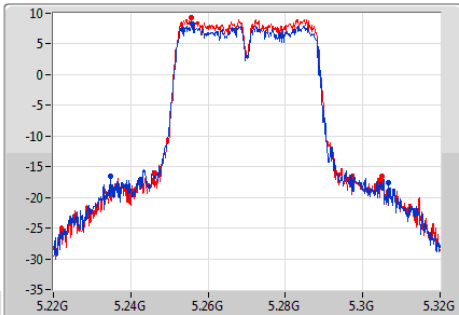

CF
5.27GHz
Span
100MHz
RBW
500kHz
VBW
2MHz
Sweep Time
1ms
Detector Type
Sample

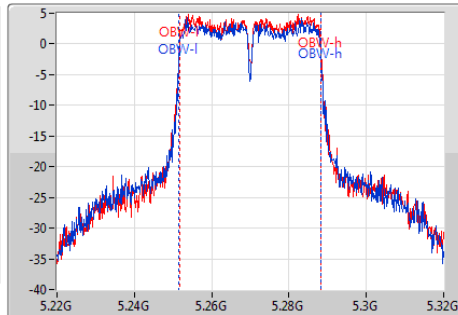

26dB(Hz)	Fl-26dB(Hz)	Fh-26dB(Hz)	OBW(Hz)	Fl-OBW(Hz)	Fh-OBW(Hz)	Limit(Hz)	Port
71.739M	5.234783G	5.306522G	36.903M	5.251476G	5.288379G	Inf	1
58.986M	5.246087G	5.305072G	36.758M	5.251621G	5.288379G	Inf	2

802.11ac VHT40_Nss1,(MCS0)_2TX

EBW

5310MHz

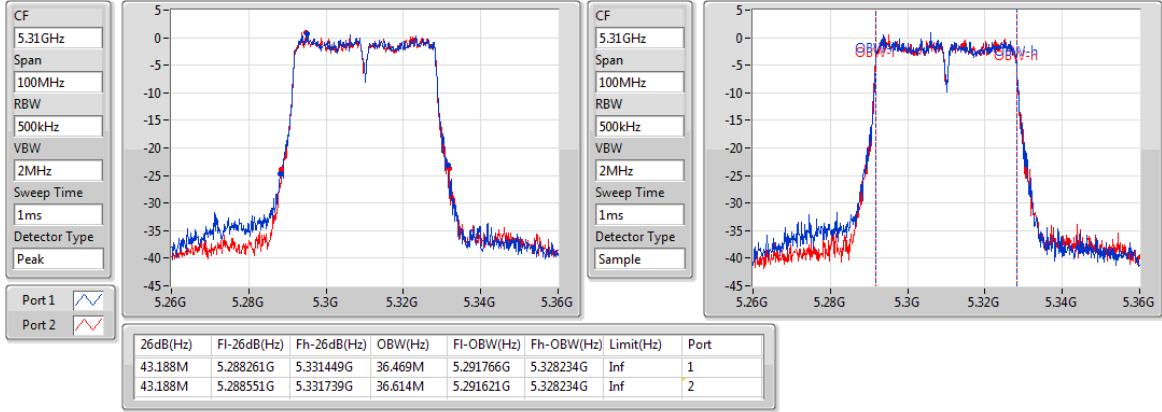

802.11ac VHT40_Nss1,(MCS0)_2TX

EBW

5510MHz

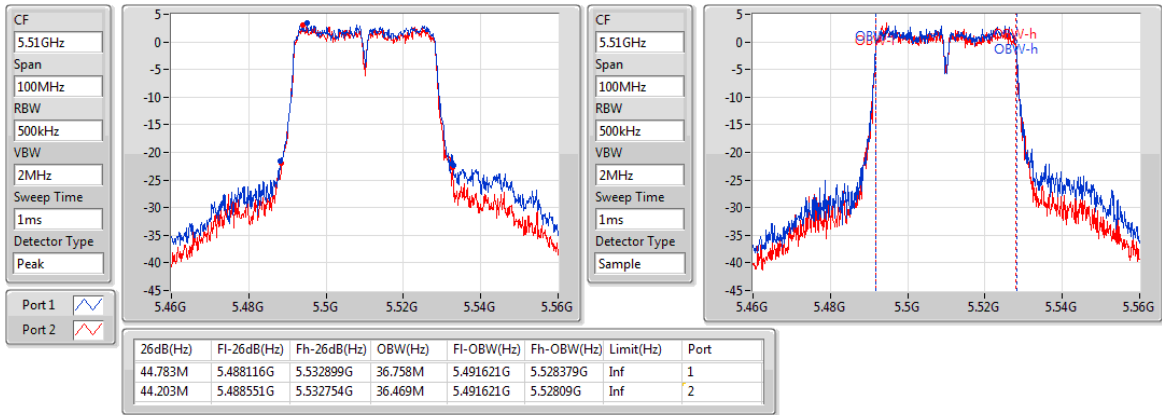

802.11ac VHT40_Nss1,(MCS0)_2TX

EBW

5550MHz

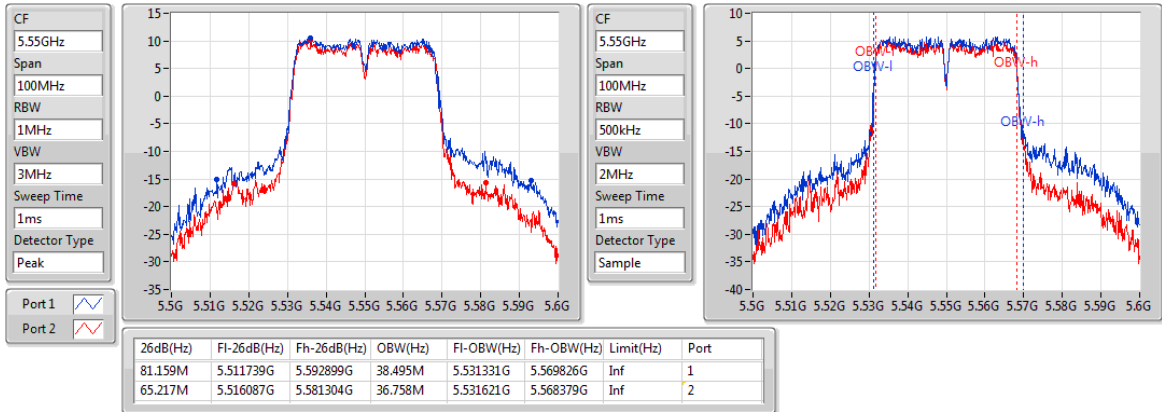

802.11ac VHT40_Nss1,(MCS0)_2TX

EBW

5670MHz

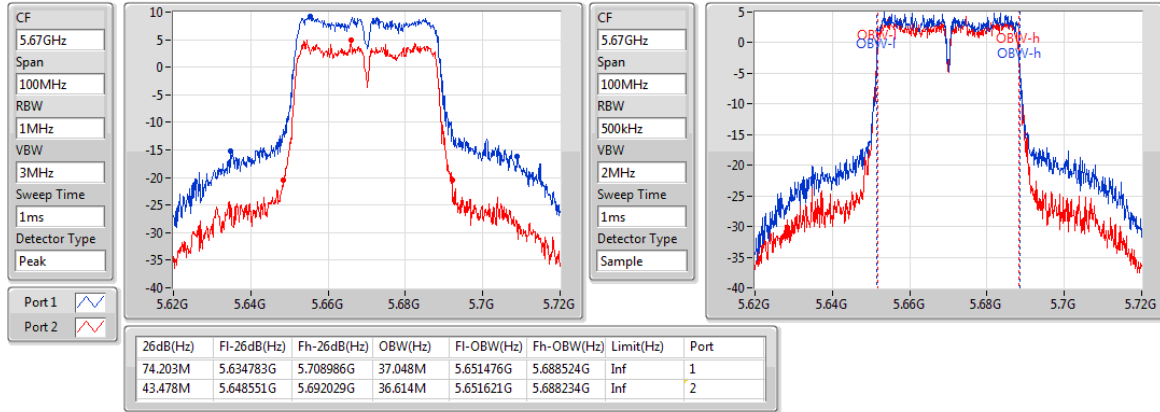

802.11ac VHT40_Nss1,(MCS0)_2TX

EBW

5755MHz

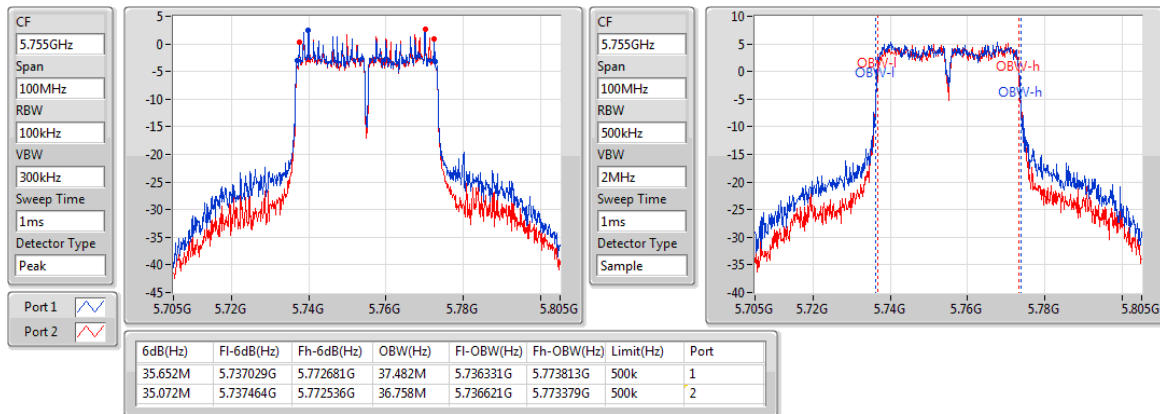

802.11ac VHT40_Nss1,(MCS0)_2TX

EBW

5795MHz

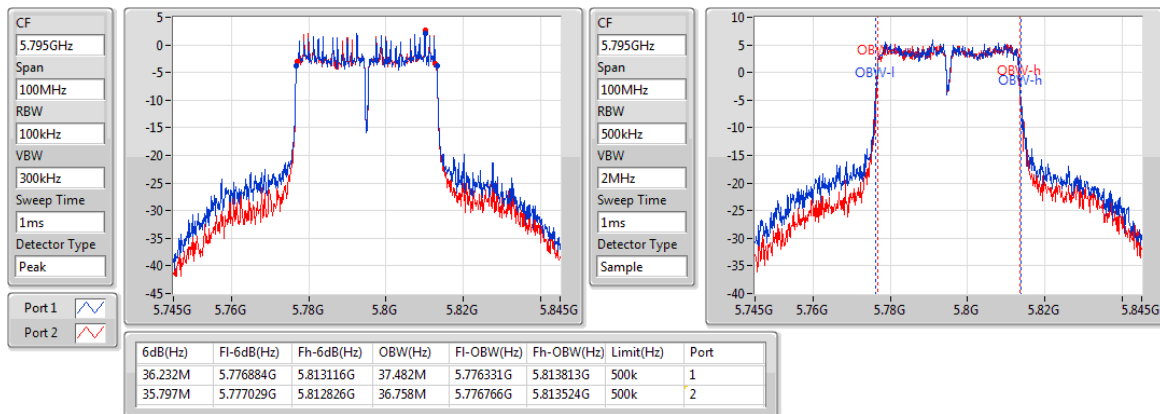

802.11ac VHT80_Nss1,(MCS0)_2TX

EBW

5210MHz

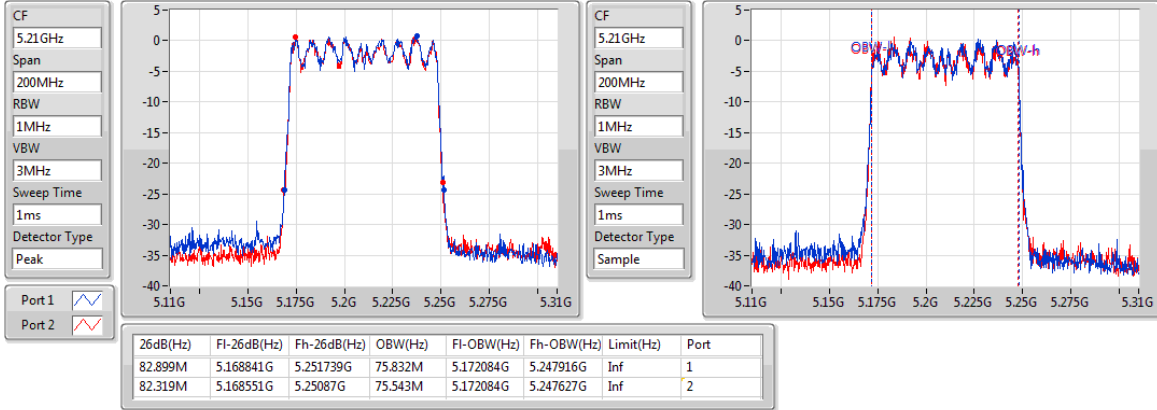

802.11ac VHT80_Nss1,(MCS0)_2TX

EBW

5290MHz

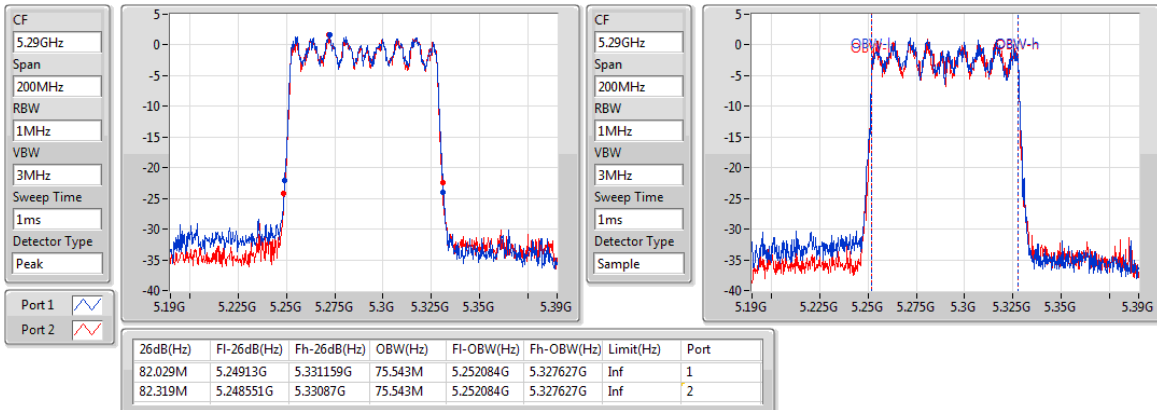

802.11ac VHT80_Nss1,(MCS0)_2TX

EBW

5530MHz

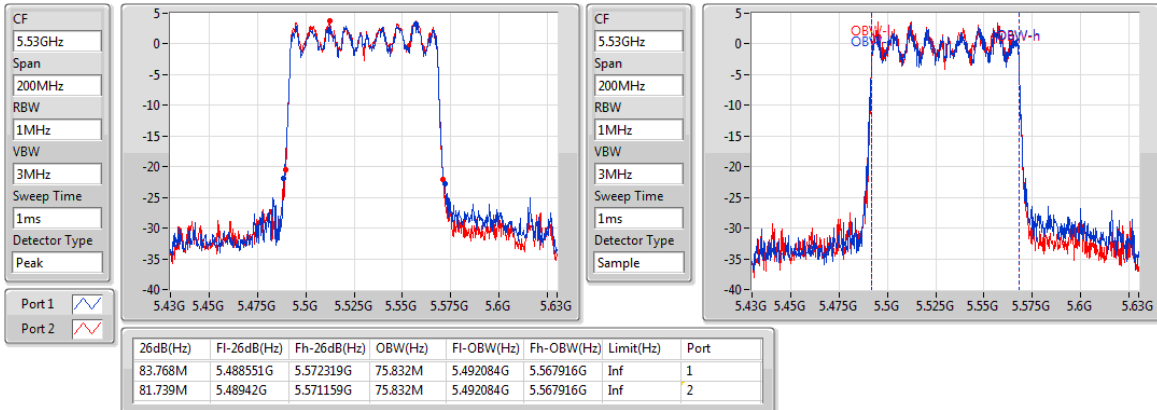

802.11ac VHT80_Nss1,(MCS0)_2TX

EBW

5775MHz

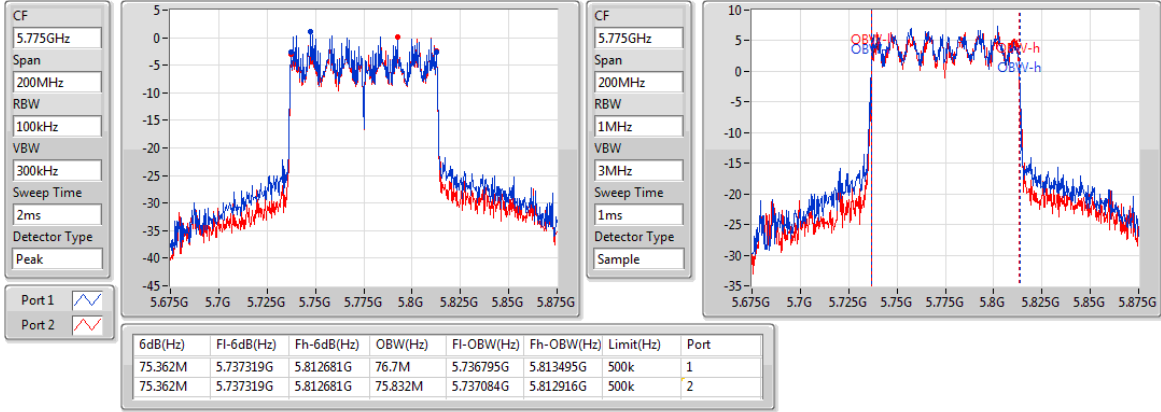

3.3 RF Output Power

3.3.1 Limit of RF Output Power

Frequency band 5150-5250 MHz		
Operating Mode		Limit
<input type="checkbox"/>	Outdoor access point	Conducted Power: 1 W The maximum e.i.r.p. at any elevation angle above 30 degrees as measured from the horizon must not exceed 125 mW (21 dBm)
<input type="checkbox"/>	Indoor access point	Conducted Power: 1 W
<input type="checkbox"/>	Fixed point-to-point access points	Conducted Power: 1 W
<input checked="" type="checkbox"/>	Client devices	Conducted Power: 250 mW

Frequency Band (MHz)	Limit
<input checked="" type="checkbox"/> 5250 ~ 5350	Conducted Power: 250mW or 11dBm+10 log B
<input checked="" type="checkbox"/> 5470 ~ 5725	Conducted Power: 250mW or 11dBm+10 log B
<input checked="" type="checkbox"/> 5725 ~ 5850	Conducted Power: 1 W

Note: "B" is the 26dB emission bandwidth in MHz.

3.3.2 Test Procedures

Method PM-G (Measurement using a gated RF average power meter)

Measurements is performed using a wideband gated RF power meter provided that the gate parameters are adjusted such that the power is measured only when the EUT is transmitting at its maximum power control level. Since the measurement is made only during the ON time of the transmitter, no duty cycle correction factor is required.

3.3.3 Test Setup

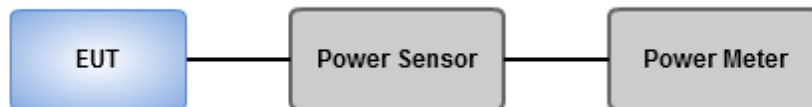

3.3.4 Test Result of Maximum Conducted Output Power

Summary

Mode	Total Power (dBm)	Total Power (W)	EIRP (dBm)	EIRP (W)
5.15-5.25GHz	-	-	-	-
802.11a_Nss1,(6Mbps)_2TX	12.08	0.01614	16.04	0.04018
802.11ac VHT20_Nss1,(MCS0)_2TX	11.99	0.01581	15.95	0.03936
802.11ac VHT40_Nss1,(MCS0)_2TX	11.97	0.01574	15.93	0.03917
802.11ac VHT80_Nss1,(MCS0)_2TX	12.01	0.01589	15.97	0.03954
5.25-5.35GHz	-	-	-	-
802.11a_Nss1,(6Mbps)_2TX	19.01	0.07962	23.25	0.21135
802.11ac VHT20_Nss1,(MCS0)_2TX	18.98	0.07907	23.22	0.20989
802.11ac VHT40_Nss1,(MCS0)_2TX	18.89	0.07745	23.13	0.20559
802.11ac VHT80_Nss1,(MCS0)_2TX	13.04	0.02014	17.28	0.05346
5.47-5.725GHz	-	-	-	-
802.11a_Nss1,(6Mbps)_2TX	19.47	0.08851	23.68	0.23335
802.11ac VHT20_Nss1,(MCS0)_2TX	19.29	0.08492	23.50	0.22387
802.11ac VHT40_Nss1,(MCS0)_2TX	19.57	0.09057	23.78	0.23878
802.11ac VHT80_Nss1,(MCS0)_2TX	15.14	0.03266	19.35	0.08610
5.725-5.85GHz	-	-	-	-
802.11a_Nss1,(6Mbps)_2TX	17.97	0.06266	21.71	0.14825
802.11ac VHT20_Nss1,(MCS0)_2TX	17.98	0.06281	21.72	0.14859
802.11ac VHT40_Nss1,(MCS0)_2TX	19.08	0.08091	22.82	0.19143
802.11ac VHT80_Nss1,(MCS0)_2TX	19.16	0.08241	22.90	0.19498

Result

Mode	Result	DG (dBi)	Port 1 (dBm)	Port 2 (dBm)	Total Power (dBm)	Power Limit (dBm)	EIRP (dBm)	EIRP Limit (dBm)
802.11a_Nss1,(6Mbps)_2TX	-	-	-	-	-	-	-	-
5180MHz	Pass	3.96	9.11	9.03	12.08	24.00	16.04	30.00
5200MHz	Pass	3.96	9.15	8.95	12.06	24.00	16.02	30.00
5240MHz	Pass	3.96	9.06	8.85	11.97	24.00	15.93	30.00
5260MHz	Pass	4.24	15.96	15.83	18.91	24.00	23.15	30.00
5300MHz	Pass	4.24	16.03	15.89	18.97	24.00	23.21	30.00
5320MHz	Pass	4.24	16.07	15.92	19.01	24.00	23.25	30.00
5500MHz	Pass	4.21	14.87	15.34	18.12	24.00	22.33	30.00
5580MHz	Pass	4.21	16.36	16.55	19.47	24.00	23.68	30.00
5700MHz	Pass	4.21	14.57	13.95	17.28	24.00	21.49	30.00
5745MHz	Pass	3.74	15.09	14.82	17.97	30.00	21.71	36.00
5785MHz	Pass	3.74	14.17	14.02	17.11	30.00	20.85	36.00
5825MHz	Pass	3.74	14.25	14.06	17.17	30.00	20.91	36.00
802.11ac VHT20_Nss1,(MCS0)_2TX	-	-	-	-	-	-	-	-
5180MHz	Pass	3.96	9.05	8.91	11.99	24.00	15.95	30.00
5200MHz	Pass	3.96	9.01	8.86	11.95	24.00	15.91	30.00
5240MHz	Pass	3.96	8.93	8.80	11.88	24.00	15.84	30.00
5260MHz	Pass	4.24	15.89	15.93	18.92	24.00	23.16	30.00
5300MHz	Pass	4.24	15.91	16.02	18.98	24.00	23.22	30.00
5320MHz	Pass	4.24	15.82	15.91	18.88	24.00	23.12	30.00
5500MHz	Pass	4.21	14.79	15.24	18.03	24.00	22.24	30.00
5580MHz	Pass	4.21	16.13	16.43	19.29	24.00	23.50	30.00
5700MHz	Pass	4.21	14.05	13.36	16.73	24.00	20.94	30.00
5745MHz	Pass	3.74	15.02	14.91	17.98	30.00	21.72	36.00
5785MHz	Pass	3.74	14.13	14	17.08	30.00	20.82	36.00
5825MHz	Pass	3.74	14.21	14.02	17.13	30.00	20.87	36.00
802.11ac VHT40_Nss1,(MCS0)_2TX	-	-	-	-	-	-	-	-
5190MHz	Pass	3.96	8.72	8.71	11.73	24.00	15.69	30.00
5230MHz	Pass	3.96	9.03	8.89	11.97	24.00	15.93	30.00
5270MHz	Pass	4.24	15.83	15.92	18.89	24.00	23.13	30.00
5310MHz	Pass	4.24	10.56	10.67	13.63	24.00	17.87	30.00
5510MHz	Pass	4.21	13.32	13.14	16.24	24.00	20.45	30.00
5550MHz	Pass	4.21	16.57	16.54	19.57	24.00	23.78	30.00
5670MHz	Pass	4.21	15.33	14.54	17.96	24.00	22.17	30.00

Mode	Result	DG (dBi)	Port 1 (dBm)	Port 2 (dBm)	Total Power (dBm)	Power Limit (dBm)	EIRP (dBm)	EIRP Limit (dBm)
5755MHz	Pass	3.74	16.14	16	19.08	30.00	22.82	36.00
5795MHz	Pass	3.74	16.02	16.01	19.03	30.00	22.77	36.00
802.11ac VHT80_Nss1,(MCS0)_2TX	-	-	-	-	-	-	-	-
5210MHz	Pass	3.96	9.09	8.90	12.01	24.00	15.97	30.00
5290MHz	Pass	4.24	10.21	9.85	13.04	24.00	17.28	30.00
5530MHz	Pass	4.21	12.15	12.11	15.14	24.00	19.35	30.00
5775MHz	Pass	3.74	16.45	15.83	19.16	30.00	22.90	36.00

DG = Directional Gain; **Port X** = Port X output power

3.4 Peak Power Spectral Density

3.4.1 Limit of Peak Power Spectral Density

Frequency band 5150-5250 MHz		
Operating Mode		Limit
<input type="checkbox"/>	Outdoor access point	17 dBm / MHz
<input type="checkbox"/>	Indoor access point	17 dBm / MHz
<input type="checkbox"/>	Fixed point-to-point access points	17 dBm / MHz
<input checked="" type="checkbox"/>	Client devices	11 dBm / MHz

Frequency Band (MHz)		Limit
<input checked="" type="checkbox"/>	5250 ~ 5350	11 dBm / MHz
<input checked="" type="checkbox"/>	5470 ~ 5725	11 dBm / MHz
<input checked="" type="checkbox"/>	5725 ~ 5850	30 dBm /500 kHz

3.4.2 Test Procedures

For 5150 ~ 5250 MHz / 5250 ~ 5350 MHz / 5470 ~ 5725 MHz

Duty cycle \geq 98 %

1. Set RBW = 1 MHz, VBW = 3 MHz, Sweep time = auto, Detector = RMS.
2. Trace average 100 traces.
3. Use the peak marker function to determine the maximum amplitude level.

Duty cycle $<$ 98 %

1. Set RBW = 1 MHz, VBW = 3 MHz, Detector = RMS.
2. Set sweep time $\geq 10 * (\text{number of points in sweep}) * (\text{total on/off period of the transmitted signal})$.
3. Perform a single sweep.
4. Use the peak marker function to determine the maximum amplitude level.
5. Add $10 \log(1/x)$, where x is the duty cycle.

For 5725 ~ 5850 MHz

Duty cycle \geq 98 %

1. Set RBW = 500 kHz, VBW = 3 MHz, Sweep time = auto, Detector = RMS.
2. Trace average 100 traces.
3. Use the peak marker function to determine the maximum amplitude level.

Duty cycle $<$ 98 %

1. Set RBW = 500 kHz, VBW = 3 MHz, Detector = RMS.
2. Set sweep time $\geq 10 * (\text{number of points in sweep}) * (\text{total on/off period of the transmitted signal})$.
3. Perform a single sweep.
4. Use the peak marker function to determine the maximum amplitude level.
5. Add $10 \log(1/x)$, where x is the duty cycle.

3.4.3 Test Setup

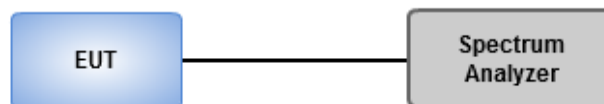

3.4.4 Test Result of Peak Power Spectral Density

Summary

Mode	PD (dBm/RBW)	EIRP PD (dBm/RBW)
5.15-5.25GHz	-	-
802.11a_Nss1,(6Mbps)_2TX	-1.44	4.48
802.11ac VHT20_Nss1,(MCS0)_2TX	-1.8	4.12
802.11ac VHT40_Nss1,(MCS0)_2TX	-5.25	0.67
802.11ac VHT80_Nss1,(MCS0)_2TX	-6.19	-0.27
5.25-5.35GHz	-	-
802.11a_Nss1,(6Mbps)_2TX	4.99	11.15
802.11ac VHT20_Nss1,(MCS0)_2TX	4.79	10.95
802.11ac VHT40_Nss1,(MCS0)_2TX	1.78	7.94
802.11ac VHT80_Nss1,(MCS0)_2TX	-5.4	0.76
5.47-5.725GHz	-	-
802.11a_Nss1,(6Mbps)_2TX	6.61	12.76
802.11ac VHT20_Nss1,(MCS0)_2TX	5.88	12.03
802.11ac VHT40_Nss1,(MCS0)_2TX	3.16	9.31
802.11ac VHT80_Nss1,(MCS0)_2TX	-3.47	2.68
5.725-5.85GHz	-	-
802.11a_Nss1,(6Mbps)_2TX	3.1	8.97
802.11ac VHT20_Nss1,(MCS0)_2TX	3.31	9.18
802.11ac VHT40_Nss1,(MCS0)_2TX	1.25	7.12
802.11ac VHT80_Nss1,(MCS0)_2TX	-0.95	4.92

RBW = 500kHz for 5.725-5.85GHz band / 1MHz for other band;

Result

Mode	Result	DG (dBi)	Port 1 (dBm/RBW)	Port 2 (dBm/RBW)	PD (dBm/RBW)	PD Limit (dBm/RBW)	EIRP PD (dBm/RBW)	EIRP PD Limit (dBm/RBW)
802.11a_Nss1,(6Mbps)_2TX	-	-	-	-	-	-	-	-
5180MHz	Pass	5.92	-4.83	-3.96	-1.44	11.00	4.48	17.00
5200MHz	Pass	5.92	-4.81	-4.13	-1.47	11.00	4.45	17.00
5240MHz	Pass	5.92	-4.89	-4.34	-1.60	11.00	4.32	17.00
5260MHz	Pass	6.16	1.52	2.41	4.99	10.84	11.15	17.00
5300MHz	Pass	6.16	1.51	2.32	4.93	10.84	11.09	17.00
5320MHz	Pass	6.16	1.43	2.19	4.84	10.84	11.00	17.00
5500MHz	Pass	6.15	3.93	3.27	6.61	10.85	12.76	17.00
5580MHz	Pass	6.15	3.02	3.48	6.27	10.85	12.42	17.00
5700MHz	Pass	6.15	1.84	0.9	4.38	10.85	10.53	17.00
5745MHz	Pass	5.87	0.39	-0.19	3.10	30.00	8.97	36.00
5785MHz	Pass	5.87	-0.74	-1.21	2.01	30.00	7.88	36.00
5825MHz	Pass	5.87	-0.68	-0.92	2.20	30.00	8.07	36.00
802.11ac VHT20_Nss1,(MCS0)_2TX	-	-	-	-	-	-	-	-
5180MHz	Pass	5.92	-5.18	-4.4	-1.80	11.00	4.12	17.00
5200MHz	Pass	5.92	-5.19	-4.5	-1.82	11.00	4.10	17.00
5240MHz	Pass	5.92	-5.38	-4.8	-2.09	11.00	3.83	17.00
5260MHz	Pass	6.16	1.23	2.31	4.79	10.84	10.95	17.00
5300MHz	Pass	6.16	1.19	2.08	4.65	10.84	10.81	17.00
5320MHz	Pass	6.16	1.13	1.98	4.58	10.84	10.74	17.00
5500MHz	Pass	6.15	1.25	1.91	4.59	10.85	10.74	17.00
5580MHz	Pass	6.15	2.6	3.13	5.88	10.85	12.03	17.00
5700MHz	Pass	6.15	1.1	0.05	3.61	10.85	9.76	17.00
5745MHz	Pass	5.87	0.55	0.05	3.31	30.00	9.18	36.00
5785MHz	Pass	5.87	-0.67	-1.07	2.11	30.00	7.98	36.00
5825MHz	Pass	5.87	-0.56	-0.74	2.33	30.00	8.20	36.00
802.11ac VHT40_Nss1,(MCS0)_2TX	-	-	-	-	-	-	-	-
5190MHz	Pass	5.92	-9.02	-8.27	-5.69	11.00	0.23	17.00
5230MHz	Pass	5.92	-8.56	-7.9	-5.25	11.00	0.67	17.00
5270MHz	Pass	6.16	-1.76	-0.73	1.78	10.84	7.94	17.00
5310MHz	Pass	6.16	-5.59	-5.57	-2.57	10.84	3.59	17.00
5510MHz	Pass	6.15	-2.75	-3.07	0.05	10.85	6.20	17.00
5550MHz	Pass	6.15	0.43	-0.14	3.16	10.85	9.31	17.00
5670MHz	Pass	6.15	-0.71	-1.63	1.86	10.85	8.01	17.00

Mode	Result	DG (dBi)	Port 1 (dBm/RBW)	Port 2 (dBm/RBW)	PD (dBm/RBW)	PD Limit (dBm/RBW)	EIRP PD (dBm/RBW)	EIRP PD Limit (dBm/RBW)
5755MHz	Pass	5.87	-1.79	-2.02	1.05	30.00	6.92	36.00
5795MHz	Pass	5.87	-1.8	-1.69	1.25	30.00	7.12	36.00
802.11ac VHT80_Nss1,(MCS0)_2TX	-	-	-	-	-	-	-	-
5210MHz	Pass	5.92	-9.1	-9.22	-6.19	11.00	-0.27	17.00
5290MHz	Pass	6.16	-8.24	-8.57	-5.40	10.84	0.76	17.00
5530MHz	Pass	6.15	-6.6	-6.31	-3.47	10.85	2.68	17.00
5775MHz	Pass	5.87	-3.67	-4.07	-0.95	30.00	4.92	36.00

DG = Directional Gain; **RBW** = 500kHz for 5.725-5.85GHz band / 1MHz for other band;

PD = trace bin-by-bin of each transmits port summing can be performed maximum power density; **Port X** = Port Xpower density;

Note:

For 5150~5250MHz:

Directional gain = $10 \times \log\left(\frac{10^{3.96/20} + 10^{1.71/20}}{2}\right) = 5.92$ dBi.

For 5250~5350MHz:

Directional gain = $10 \times \log\left(\frac{10^{4.24/20} + 10^{1.91/20}}{2}\right) = 6.16$ dBi.

For 5470~5725MHz:

Directional gain = $10 \times \log\left(\frac{10^{4.21/20} + 10^{1.91/20}}{2}\right) = 6.15$ dBi.

For 5725~5850MHz:

Directional gain = $10 \times \log\left(\frac{10^{3.74/20} + 10^{1.89/20}}{2}\right) = 5.87$ dBi.

802.11a_Nss1,(6Mbps)_2TX

PSD

5180MHz

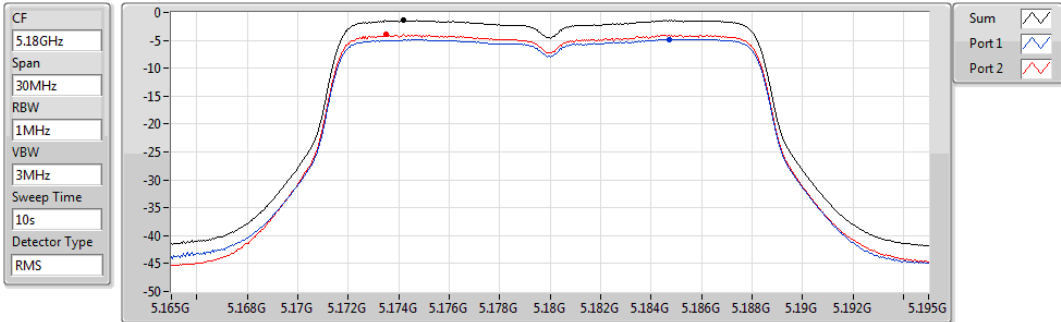

Sum	PD	Port 1	Port 2
(dBm/1MHz)	(dBm/1MHz)	(dBm/1MHz)	(dBm/1MHz)
-1.44	-1.44	-4.83	-3.96

802.11a_Nss1,(6Mbps)_2TX

PSD

5200MHz

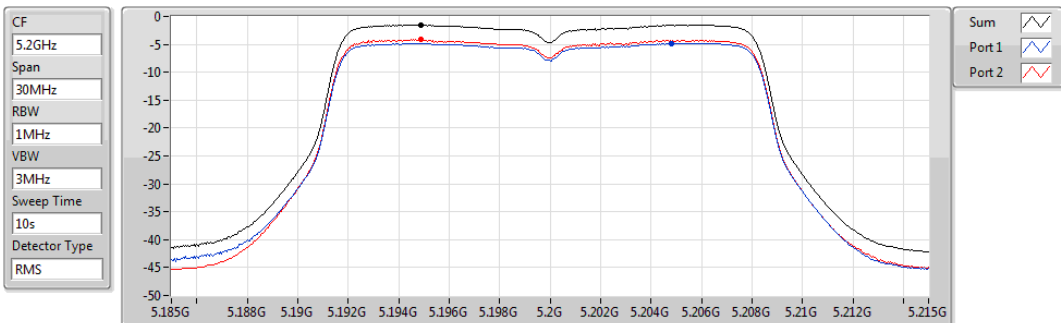

Sum	PD	Port 1	Port 2
(dBm/1MHz)	(dBm/1MHz)	(dBm/1MHz)	(dBm/1MHz)
-1.47	-1.47	-4.81	-4.13

802.11a_Nss1,(6Mbps)_2TX

PSD

5240MHz

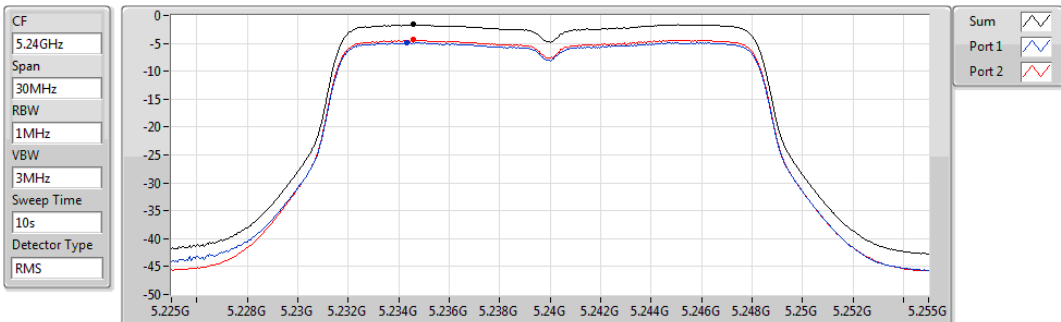

Sum	PD	Port 1	Port 2
(dBm/1MHz)	(dBm/1MHz)	(dBm/1MHz)	(dBm/1MHz)
-1.60	-1.60	-4.89	-4.34

802.11a_Nss1,(6Mbps)_2TX

PSD

5260MHz

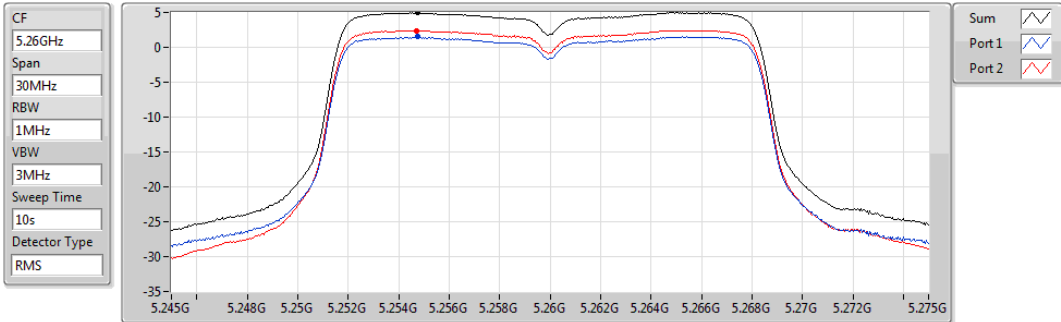

Sum	PD	Port 1	Port 2
(dBm/RBW)	(dBm/RBW)	(dBm/RBW)	(dBm/RBW)
4.99	4.99	1.52	2.41

802.11a_Nss1,(6Mbps)_2TX

PSD

5300MHz

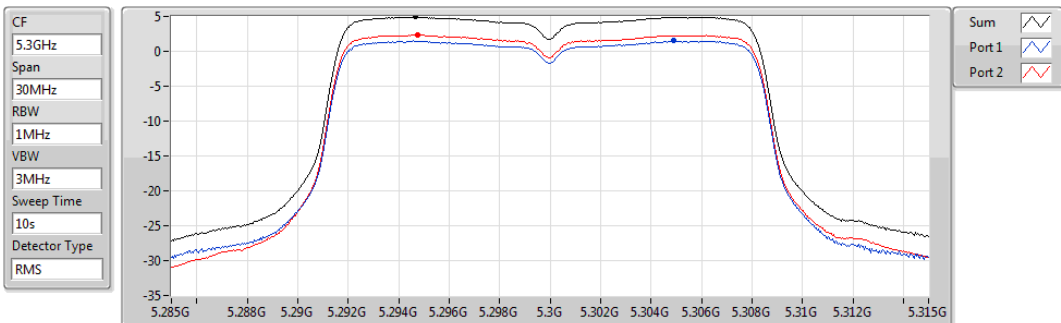

Sum	PD	Port 1	Port 2
(dBm/RBW)	(dBm/RBW)	(dBm/RBW)	(dBm/RBW)
4.93	4.93	1.51	2.32

802.11a_Nss1,(6Mbps)_2TX

PSD

5320MHz

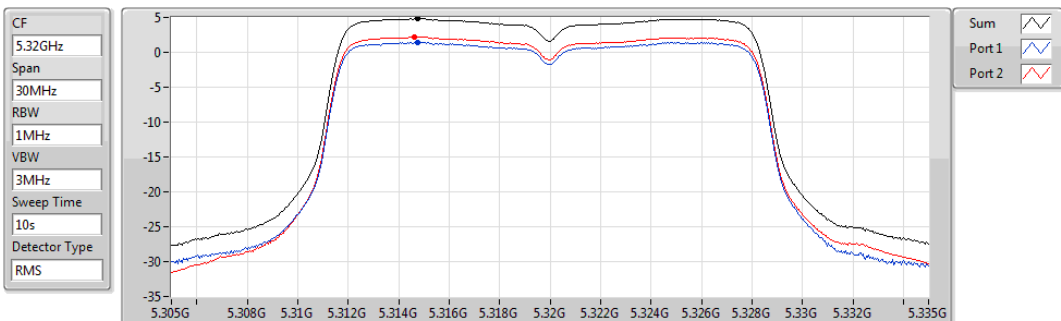

Sum	PD	Port 1	Port 2
(dBm/RBW)	(dBm/RBW)	(dBm/RBW)	(dBm/RBW)
4.84	4.84	1.43	2.19

802.11a_Nss1,(6Mbps)_2TX

PSD

5500MHz

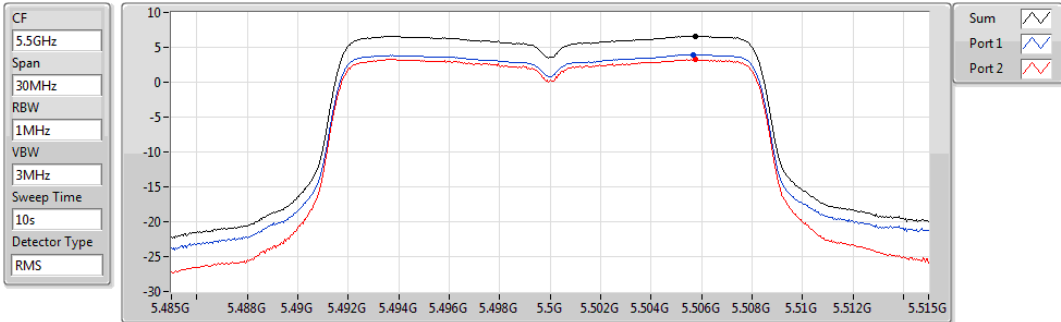

Sum	PD	Port 1	Port 2
(dBm/RBW)	(dBm/RBW)	(dBm/RBW)	(dBm/RBW)
6.61	6.61	3.93	3.27

802.11a_Nss1,(6Mbps)_2TX

PSD

5580MHz

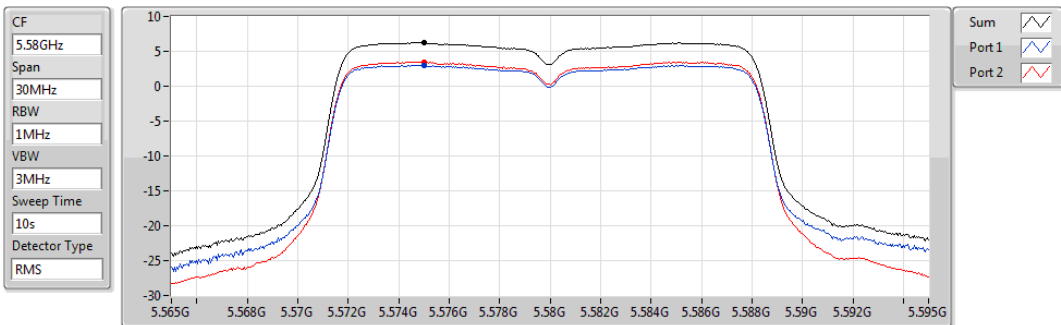

Sum	PD	Port 1	Port 2
(dBm/RBW)	(dBm/RBW)	(dBm/RBW)	(dBm/RBW)
6.27	6.27	3.02	3.48

802.11a_Nss1,(6Mbps)_2TX

PSD

5700MHz

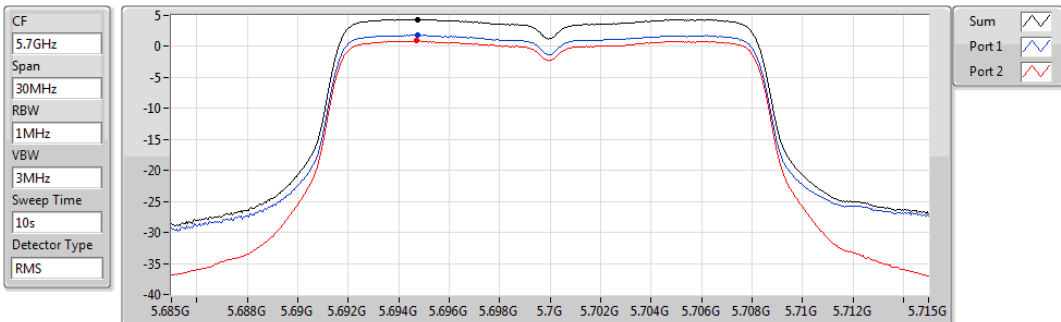

Sum	PD	Port 1	Port 2
(dBm/RBW)	(dBm/RBW)	(dBm/RBW)	(dBm/RBW)
4.38	4.38	1.84	0.90

802.11a_Nss1,(6Mbps)_2TX

PSD

5745MHz

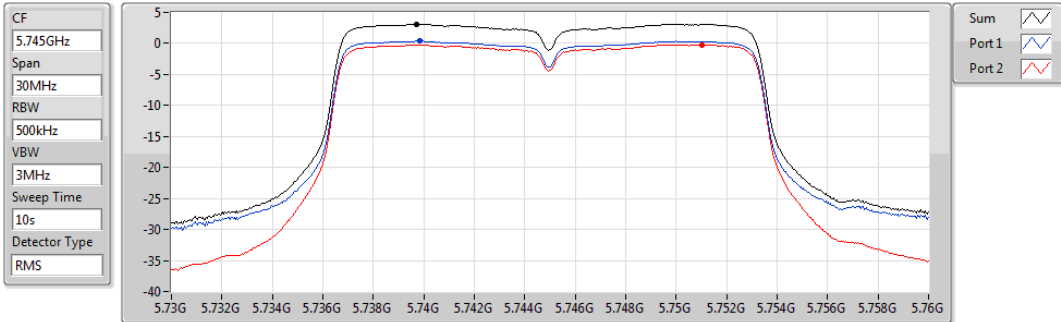

Sum	PD	Port 1	Port 2
(dBm/RBW)	(dBm/RBW)	(dBm/RBW)	(dBm/RBW)
3.10	3.10	0.39	-0.19

802.11a_Nss1,(6Mbps)_2TX

PSD

5785MHz

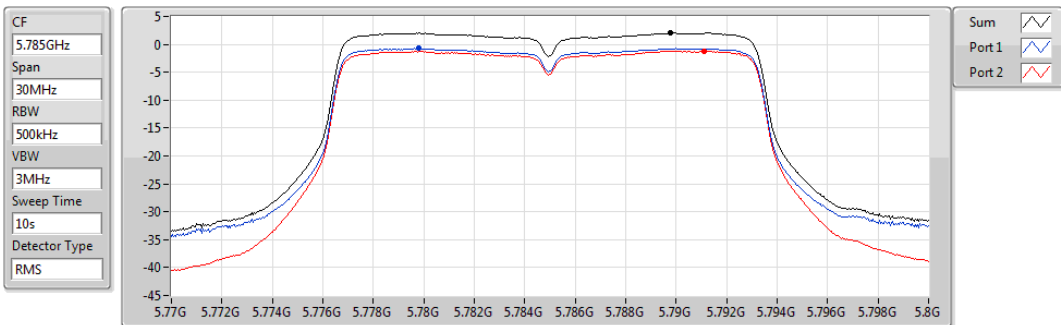

Sum	PD	Port 1	Port 2
(dBm/RBW)	(dBm/RBW)	(dBm/RBW)	(dBm/RBW)
2.01	2.01	-0.74	-1.21

802.11a_Nss1,(6Mbps)_2TX

PSD

5825MHz

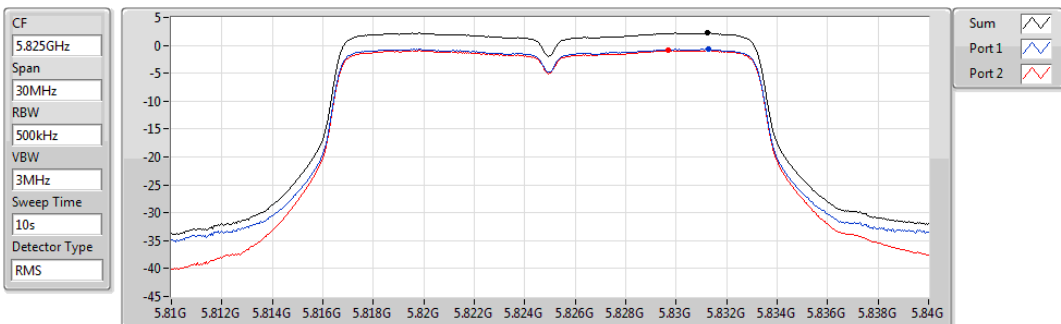

Sum	PD	Port 1	Port 2
(dBm/RBW)	(dBm/RBW)	(dBm/RBW)	(dBm/RBW)
2.20	2.20	-0.68	-0.92

802.11ac VHT20_Nss1,(MCS0)_2TX

PSD

5180MHz

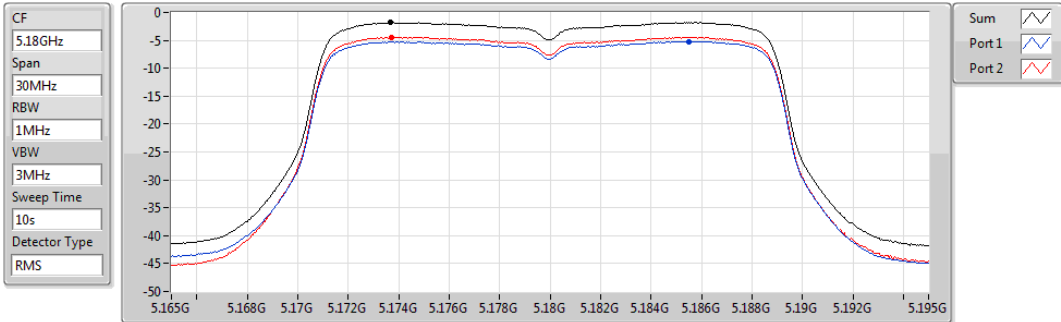

Sum	PD	Port 1	Port 2
(dBm/RBW)	(dBm/RBW)	(dBm/RBW)	(dBm/RBW)
-1.80	-1.80	-5.18	-4.40

802.11ac VHT20_Nss1,(MCS0)_2TX

PSD

5200MHz

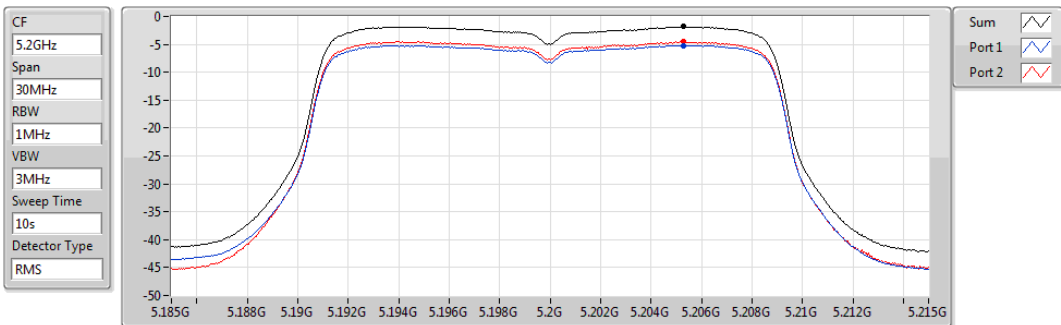

Sum	PD	Port 1	Port 2
(dBm/RBW)	(dBm/RBW)	(dBm/RBW)	(dBm/RBW)
-1.82	-1.82	-5.19	-4.50

802.11ac VHT20_Nss1,(MCS0)_2TX

PSD

5240MHz

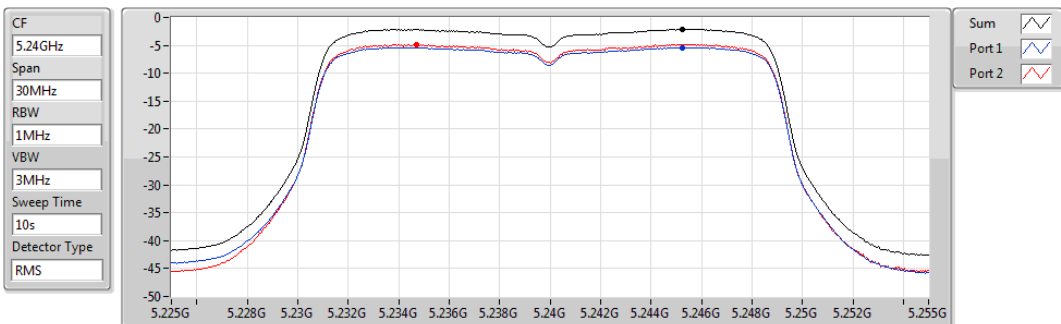

Sum	PD	Port 1	Port 2
(dBm/RBW)	(dBm/RBW)	(dBm/RBW)	(dBm/RBW)
-2.09	-2.09	-5.38	-4.80

802.11ac VHT20_Nss1,(MCS0)_2TX

PSD

5260MHz

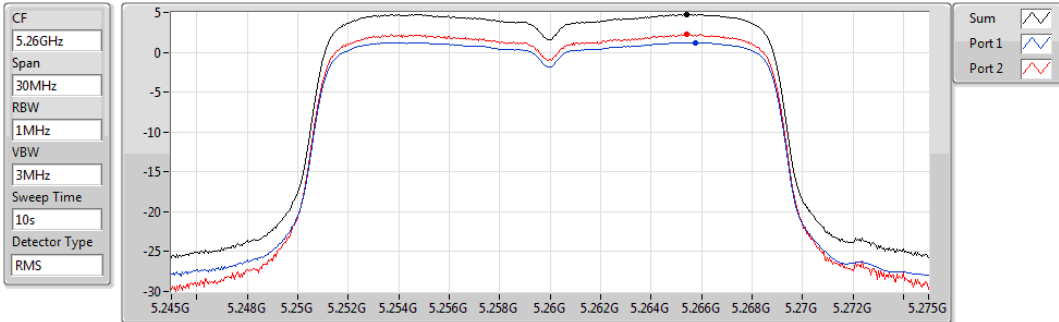

Sum	PD	Port 1	Port 2
(dBm/1MHz)	(dBm/1MHz)	(dBm/1MHz)	(dBm/1MHz)
4.79	4.79	1.23	2.31

802.11ac VHT20_Nss1,(MCS0)_2TX

PSD

5300MHz

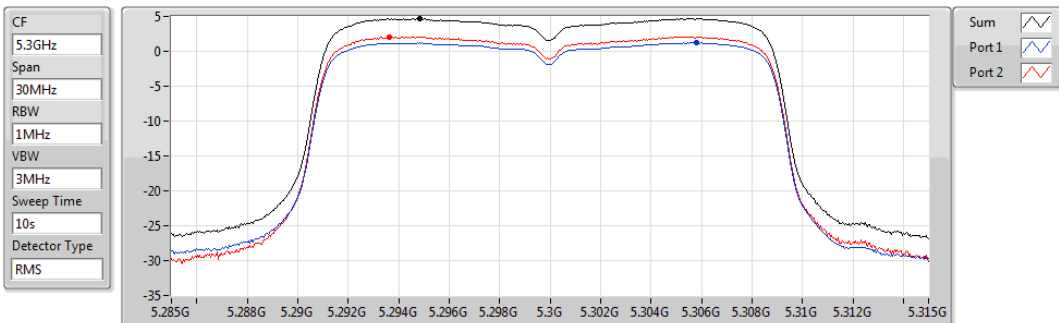

Sum	PD	Port 1	Port 2
(dBm/1MHz)	(dBm/1MHz)	(dBm/1MHz)	(dBm/1MHz)
4.65	4.65	1.19	2.08

802.11ac VHT20_Nss1,(MCS0)_2TX

PSD

5320MHz

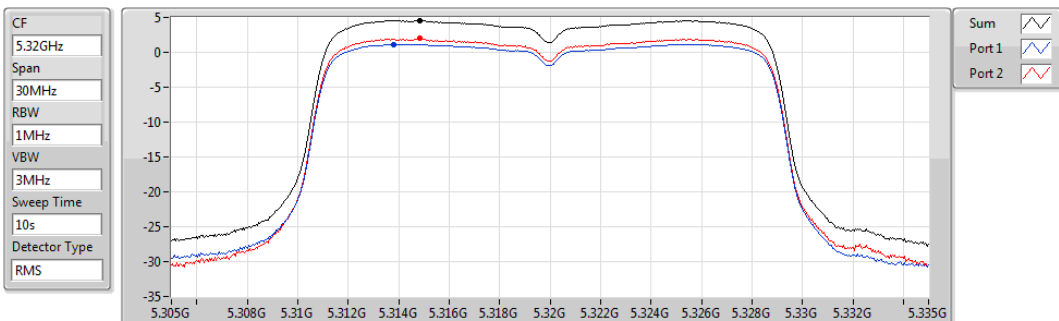

Sum	PD	Port 1	Port 2
(dBm/1MHz)	(dBm/1MHz)	(dBm/1MHz)	(dBm/1MHz)
4.58	4.58	1.13	1.98

802.11ac VHT20_Nss1,(MCS0)_2TX

PSD

5500MHz

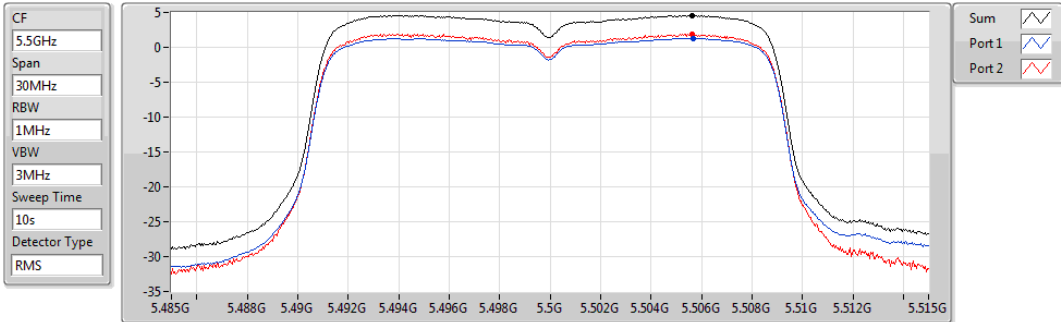

Sum	PD	Port 1	Port 2
(dBm/RBW)	(dBm/RBW)	(dBm/RBW)	(dBm/RBW)
4.59	4.59	1.25	1.91

802.11ac VHT20_Nss1,(MCS0)_2TX

PSD

5580MHz

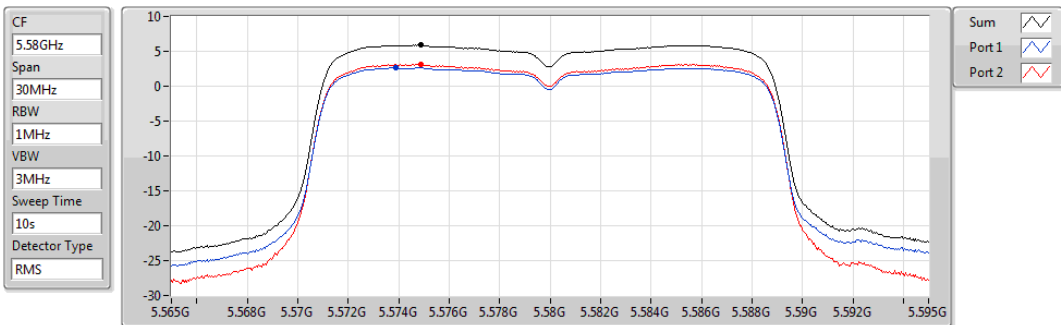

Sum	PD	Port 1	Port 2
(dBm/RBW)	(dBm/RBW)	(dBm/RBW)	(dBm/RBW)
5.88	5.88	2.60	3.13

802.11ac VHT20_Nss1,(MCS0)_2TX

PSD

5700MHz

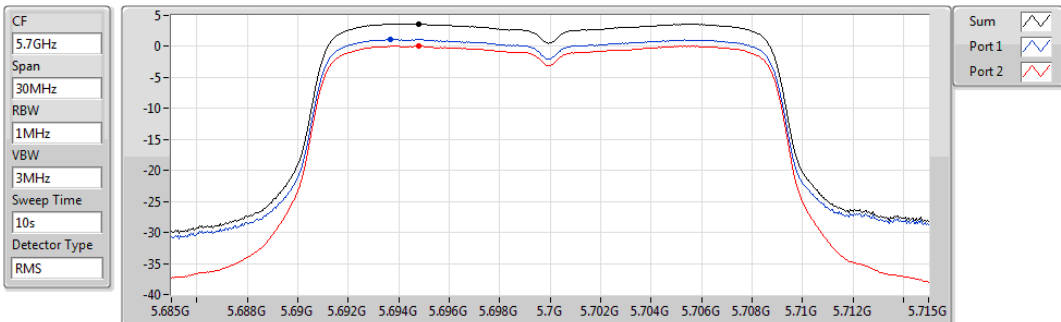

Sum	PD	Port 1	Port 2
(dBm/RBW)	(dBm/RBW)	(dBm/RBW)	(dBm/RBW)
3.61	3.61	1.10	0.05

802.11ac VHT20_Nss1,(MCS0)_2TX

PSD

5745MHz

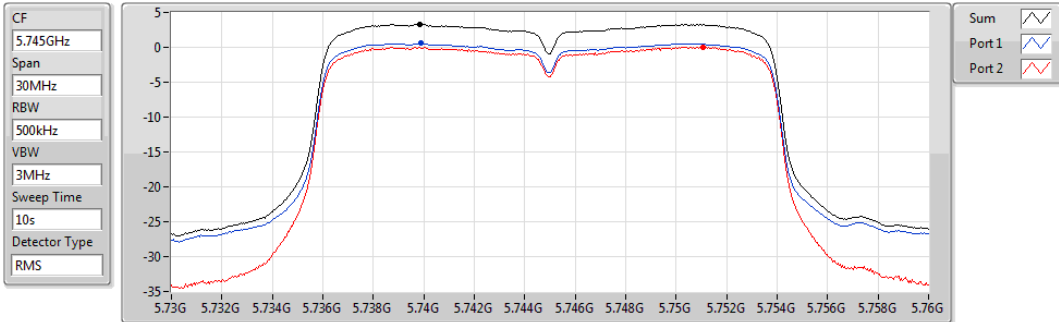

Sum	PD	Port 1	Port 2
(dBm/RBW)	(dBm/RBW)	(dBm/RBW)	(dBm/RBW)
3.31	3.31	0.55	0.05

802.11ac VHT20_Nss1,(MCS0)_2TX

PSD

5785MHz

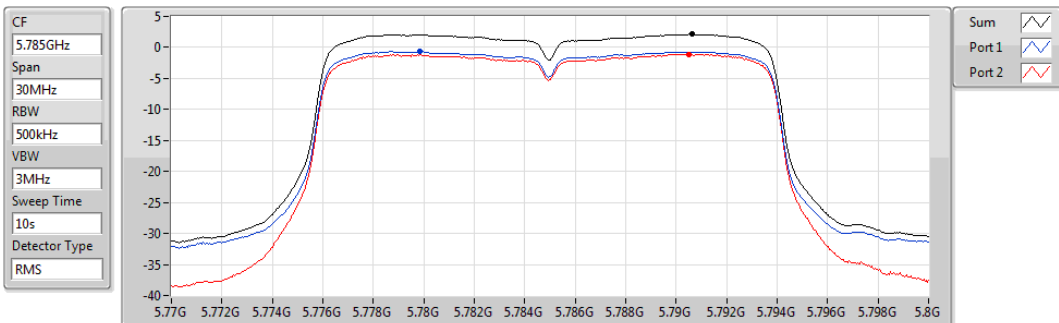

Sum	PD	Port 1	Port 2
(dBm/RBW)	(dBm/RBW)	(dBm/RBW)	(dBm/RBW)
2.11	2.11	-0.67	-1.07

802.11ac VHT20_Nss1,(MCS0)_2TX

PSD

5825MHz

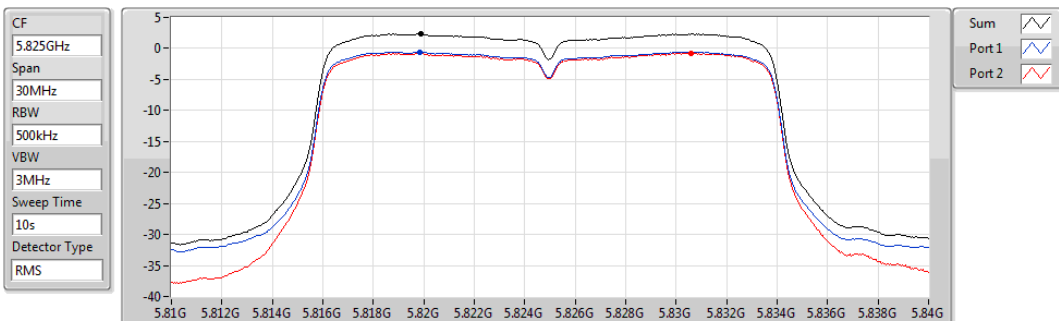

Sum	PD	Port 1	Port 2
(dBm/RBW)	(dBm/RBW)	(dBm/RBW)	(dBm/RBW)
2.33	2.33	-0.56	-0.74

802.11ac VHT40_Nss1,(MCS0)_2TX

PSD

5190MHz

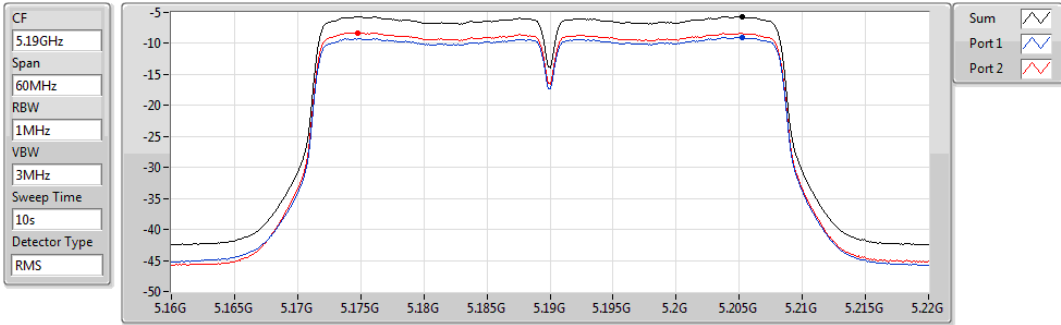

Sum	PD	Port 1	Port 2
(dBm/RBW)	(dBm/RBW)	(dBm/RBW)	(dBm/RBW)
-5.69	-5.69	-9.02	-8.27

802.11ac VHT40_Nss1,(MCS0)_2TX

PSD

5230MHz

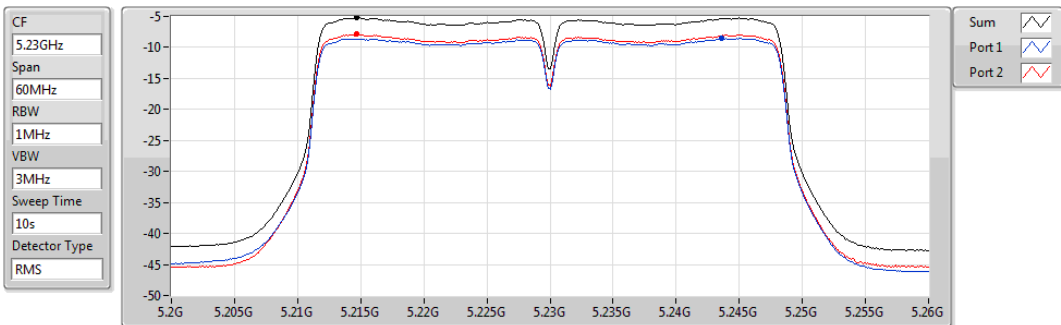

Sum	PD	Port 1	Port 2
(dBm/RBW)	(dBm/RBW)	(dBm/RBW)	(dBm/RBW)
-5.25	-5.25	-8.56	-7.90

802.11ac VHT40_Nss1,(MCS0)_2TX

PSD

5270MHz

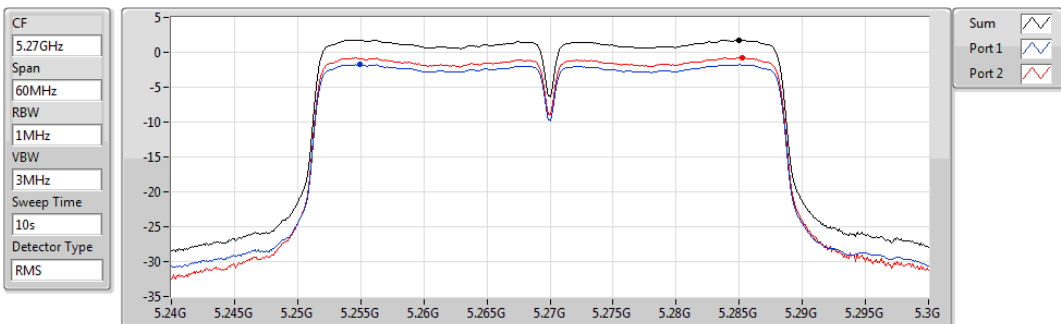

Sum	PD	Port 1	Port 2
(dBm/RBW)	(dBm/RBW)	(dBm/RBW)	(dBm/RBW)
1.78	1.78	-1.76	-0.73

802.11ac VHT40_Nss1,(MCS0)_2TX

PSD

5310MHz

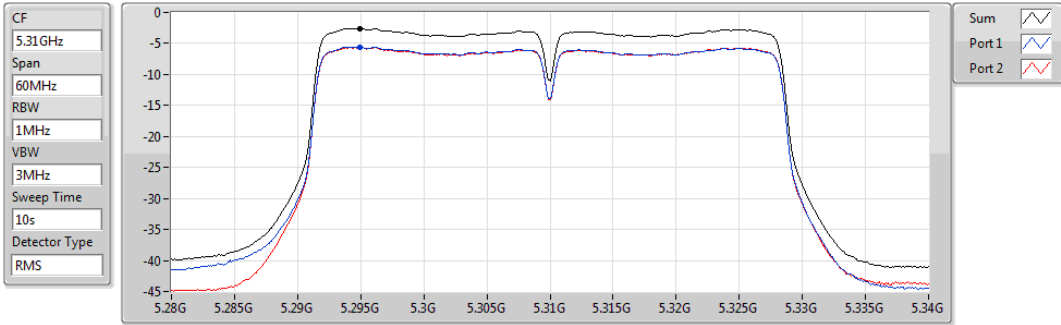

Sum	PD	Port 1	Port 2
(dBm/100kHz)	(dBm/100kHz)	(dBm/100kHz)	(dBm/100kHz)
-2.57	-2.57	-5.59	-5.57

802.11ac VHT40_Nss1,(MCS0)_2TX

PSD

5510MHz

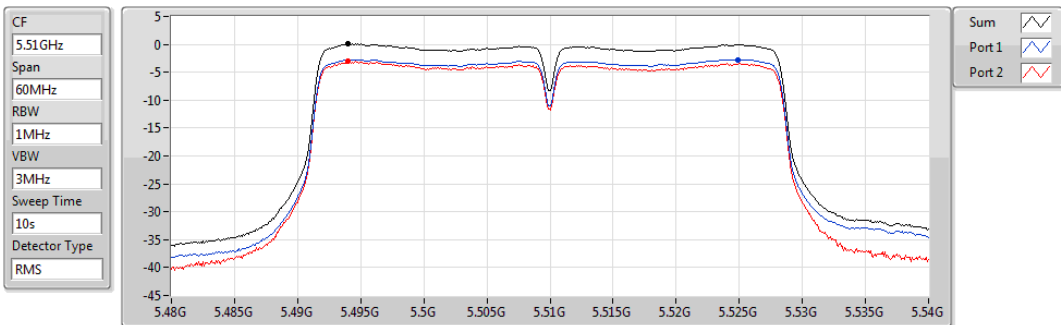

Sum	PD	Port 1	Port 2
(dBm/100kHz)	(dBm/100kHz)	(dBm/100kHz)	(dBm/100kHz)
0.05	0.05	-2.75	-3.07

802.11ac VHT40_Nss1,(MCS0)_2TX

PSD

5550MHz

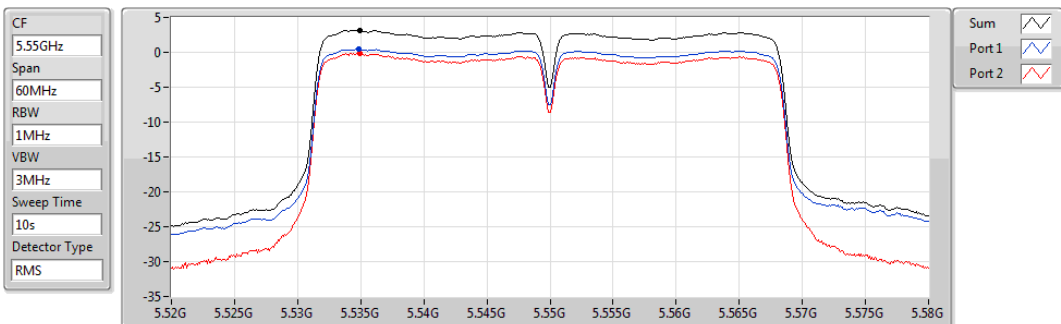

Sum	PD	Port 1	Port 2
(dBm/100kHz)	(dBm/100kHz)	(dBm/100kHz)	(dBm/100kHz)
3.16	3.16	0.43	-0.14

802.11ac VHT40_Nss1,(MCS0)_2TX

PSD

5670MHz

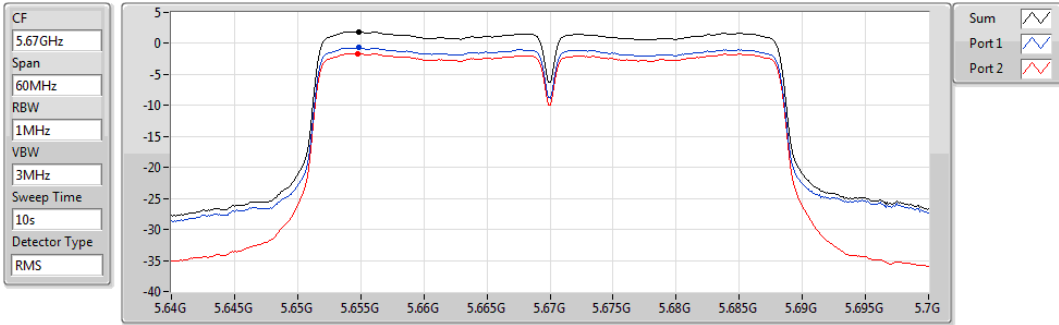

Sum	PD	Port 1	Port 2
(dBm/1MHz)	(dBm/1MHz)	(dBm/1MHz)	(dBm/1MHz)
1.86	1.86	-0.71	-1.63

802.11ac VHT40_Nss1,(MCS0)_2TX

PSD

5755MHz

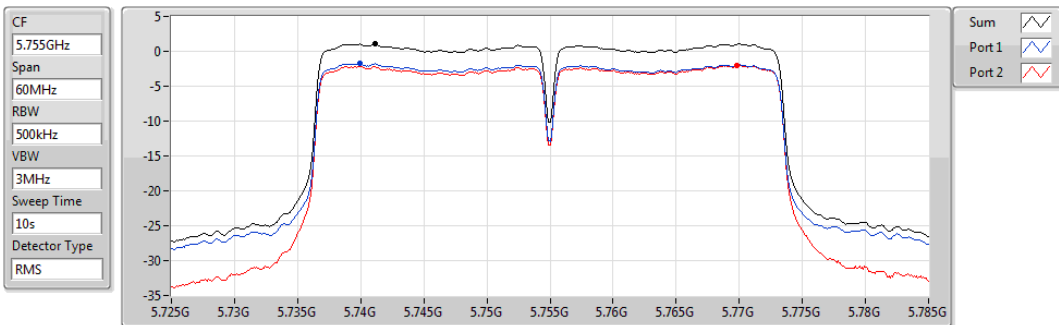

Sum	PD	Port 1	Port 2
(dBm/1MHz)	(dBm/1MHz)	(dBm/1MHz)	(dBm/1MHz)
1.05	1.05	-1.79	-2.02

802.11ac VHT40_Nss1,(MCS0)_2TX

PSD

5795MHz

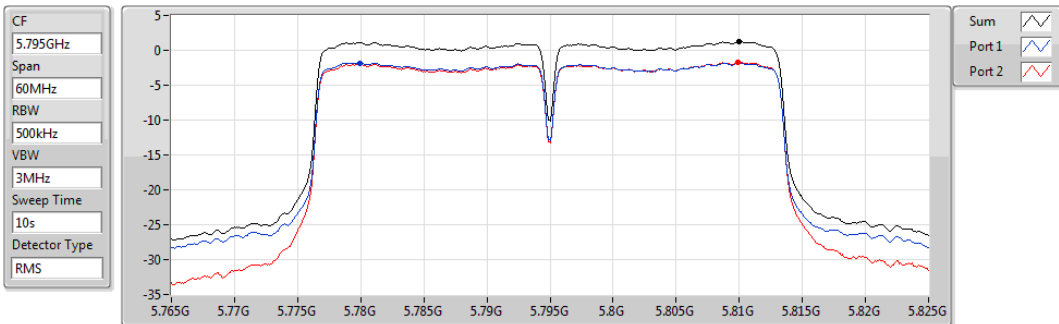

Sum	PD	Port 1	Port 2
(dBm/1MHz)	(dBm/1MHz)	(dBm/1MHz)	(dBm/1MHz)
1.25	1.25	-1.80	-1.69

802.11ac VHT80_Nss1,(MCS0)_2TX

PSD

5210MHz

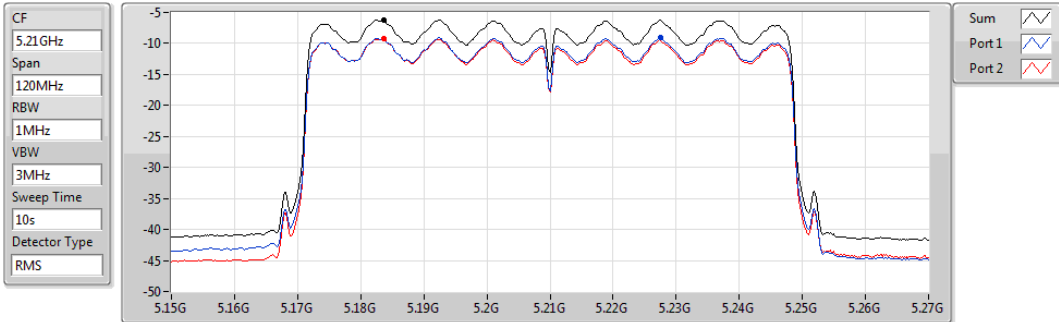

Sum	PD	Port 1	Port 2
(dBm/RBW)	(dBm/RBW)	(dBm/RBW)	(dBm/RBW)
-6.19	-6.19	-9.10	-9.22

802.11ac VHT80_Nss1,(MCS0)_2TX

PSD

5290MHz

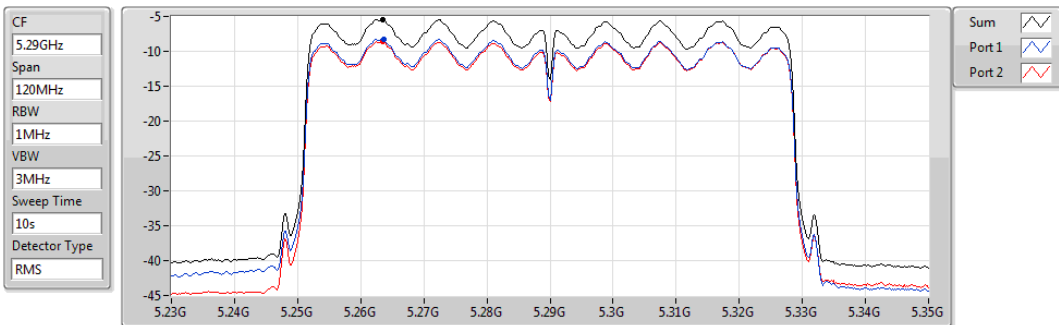

Sum	PD	Port 1	Port 2
(dBm/RBW)	(dBm/RBW)	(dBm/RBW)	(dBm/RBW)
-5.40	-5.40	-8.24	-8.57

802.11ac VHT80_Nss1,(MCS0)_2TX

PSD

5530MHz

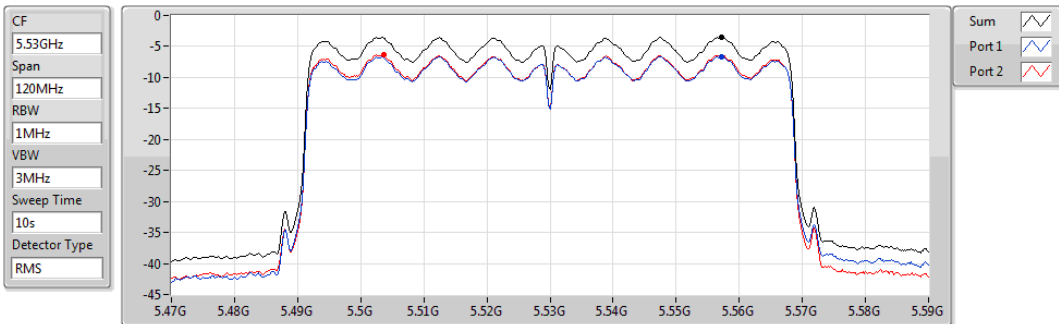

Sum	PD	Port 1	Port 2
(dBm/RBW)	(dBm/RBW)	(dBm/RBW)	(dBm/RBW)
-3.47	-3.47	-6.60	-6.31

802.11ac VHT80_Nss1,(MCS0)_2TX

PSD

5775MHz

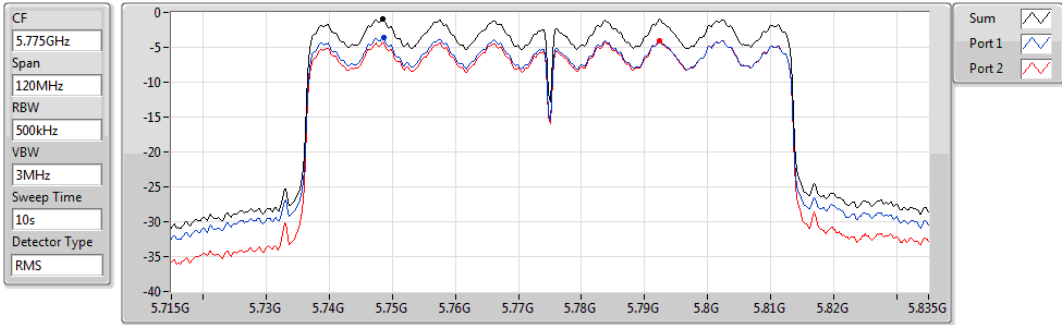

Sum	PD	Port 1	Port 2
(dBm/RBW)	(dBm/RBW)	(dBm/RBW)	(dBm/RBW)
-0.95	-0.95	-3.67	-4.07

3.5 Transmitter Radiated and Band Edge Emissions

3.5.1 Limit of Transmitter Radiated and Band Edge Emissions

Restricted Band Emissions Limit			
Frequency Range (MHz)	Field Strength (uV/m)	Field Strength (dBuV/m)	Measure Distance (m)
0.009~0.490	2400/F(kHz)	48.5 - 13.8	300
0.490~1.705	24000/F(kHz)	33.8 - 23	30
1.705~30.0	30	29	30
30~88	100	40	3
88~216	150	43.5	3
216~960	200	46	3
Above 960	500	54	3

Note 1:
Qusai-Peak value is measured for frequency below 1GHz except for 9–90 kHz, 110–490 kHz frequency band. Peak and average value are measured for frequency above 1GHz. The limit on average radio frequency emission is as above table. The limit on peak radio frequency emissions is 20 dB above the maximum permitted average emission limit

Note 2:
Measurements may be performed at a distance other than what is specified provided. When performing measurements at a distance other than that specified, the results shall be extrapolated to the specified distance using an extrapolation factor as below, Frequency at or above 30 MHz: 20 dB/decade Frequency below 30 MHz: 40 dB/decade.

Un-restricted band emissions above 1GHz Limit	
Operating Band	Limit
5.15 - 5.25 GHz	e.i.r.p. -27 dBm [68.2 dBuV/m@3m]
5.25 - 5.35 GHz	e.i.r.p. -27 dBm [68.2 dBuV/m@3m]
5.47 - 5.725 GHz	e.i.r.p. -27 dBm [68.2 dBuV/m@3m]
5.725 - 5.850 GHz	All emissions shall be limited to a level of -27 dBm/MHz at 75 MHz or more above or below the band edge increasing linearly to 10 dBm/MHz at 25 MHz above or below the band edge, and from 25 MHz above or below the band edge increasing linearly to a level of 15.6 dBm/MHz at 5 MHz above or below the band edge, and from 5 MHz above or below the band edge increasing linearly to a level of 27 dBm/MHz at the band edge.

Note 1: Measurements may be performed at a distance other than the limit distance provided they are not performed in the near field and the emissions to be measured can be detected by the measurement equipment. When performing measurements at a distance other than that specified, the results shall be extrapolated to the specified distance using an extrapolation factor of 20 dB/decade (inverse of linear distance for field-strength measurements, inverse of linear distance-squared for power-density measurements).

3.5.2 Test Procedures

1. Measurement is made at a semi-anechoic chamber that incorporates a turntable allowing a EUT rotation of 360°. A continuously-rotating, remotely-controlled turntable is installed at the test site to support the EUT and facilitate determination of the direction of maximum radiation for each EUT emission frequency. The EUT is placed at test table. For emissions testing at or below 1 GHz, the table height is 80 cm above the reference ground plane. For emission measurements above 1 GHz, the table height is 1.5 m
2. Measurement is made with the antenna positioned in both the horizontal and vertical planes of polarization. The measurement antenna is varied in height (1m ~ 4m) above the reference ground plane to obtain the maximum signal strength. Distance between EUT and antenna is 3 m.
3. This investigation is performed with the EUT rotated 360°, the antenna height scanned between 1 m and 4 m, and the antenna rotated to repeat the measurements for both the horizontal and vertical antenna polarizations.

Note:

1. 120kHz measurement bandwidth of test receiver and Quasi-peak detector is for radiated emission below 1GHz.
2. RBW=1MHz, VBW=3MHz and Peak detector is for peak measured value of radiated emission above 1GHz.
3. RBW=1MHz, VBW=1/T and Peak detector is for average measured value of radiated emission above 1GHz.

3.5.3 Test Setup

Radiated Emissions below 1 GHz

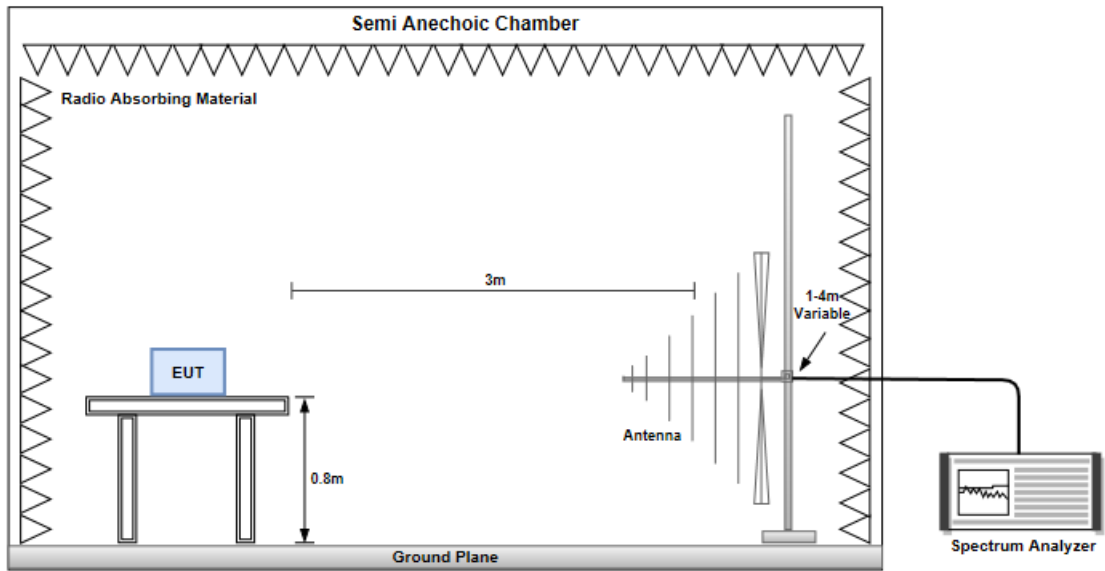

Radiated Emissions above 1 GHz

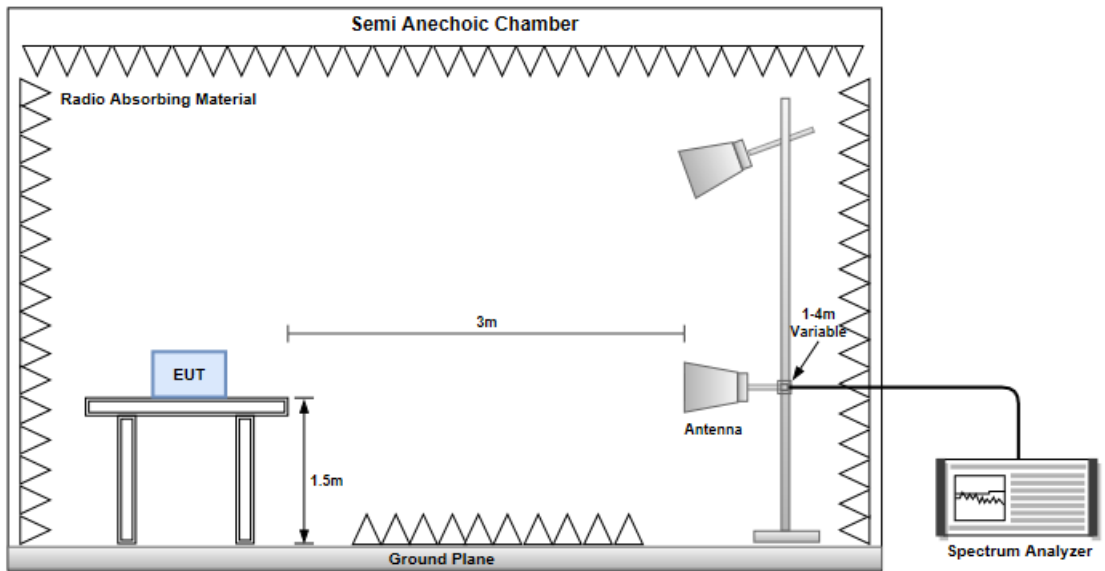

3.5.4 Transmitter Radiated Unwanted Emissions (Below 1GHz)

Modulation	VHT40	Test Freq. (MHz)	5550
Polarization	Horizontal		

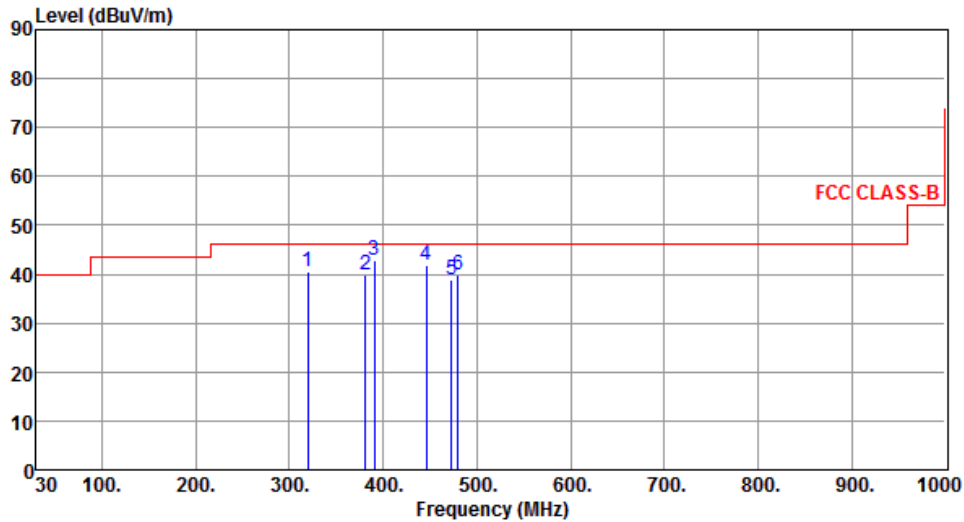

	Freq. MHz	Emission level dBuV/m	Limit dBuV/m	Margin dB	SA reading dBuV	Factor dB	Remark	ANT High cm	Turn Table deg
1	320.03	40.35	46.00	-5.65	47.77	-7.42	Peak	---	---
2	381.14	39.84	46.00	-6.16	45.78	-5.94	Peak	---	---
3	390.84	42.73	46.00	-3.27	48.42	-5.69	Peak	---	---
4	446.13	41.85	46.00	-4.15	45.99	-4.14	Peak	---	---
5	473.29	38.72	46.00	-7.28	42.40	-3.68	QP	175	203
6	480.08	40.01	46.00	-5.99	43.58	-3.57	QP	175	203

Note 1: Emission Level (dBuV/m) = SA Reading (dBuV/m) + Factor* (dB)

*Factor includes antenna factor , cable loss and amplifier gain

Note 2: Margin (dB) = Emission level (dBuV/m) – Limit (dBuV/m).

Note 3: All spurious emissions below 30MHz are more than 20 dB below the limit.

Modulation	VHT40	Test Freq. (MHz)	5550
Polarization	Vertical		

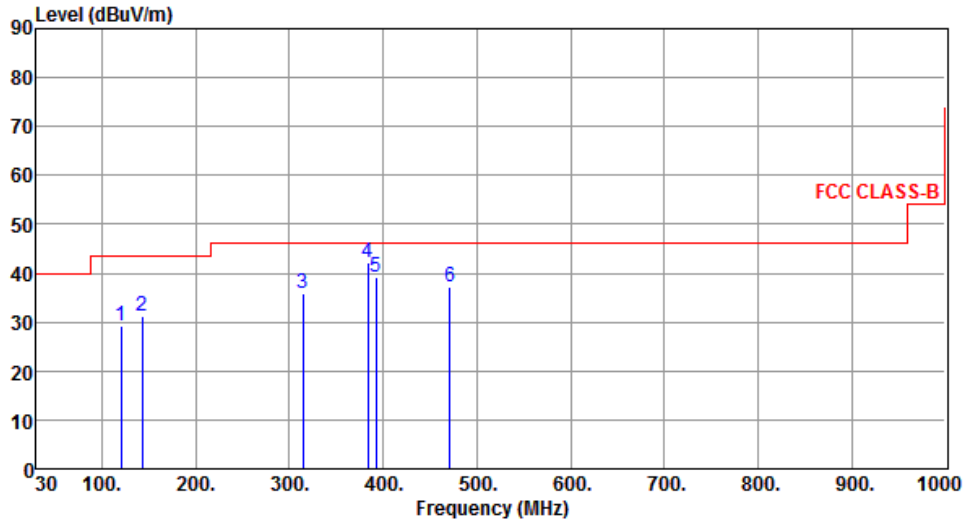

	Freq. MHz	Emission level dBuV/m	Limit dBuV/m	Margin dB	SA reading dBuV	Factor dB	Remark	ANT High cm	Turn Table deg
1	120.21	29.36	43.50	-14.14	40.04	-10.68	Peak	---	---
2	142.52	31.21	43.50	-12.29	39.99	-8.78	Peak	---	---
3	314.21	35.73	46.00	-10.27	43.31	-7.58	Peak	---	---
4	384.05	42.11	46.00	-3.89	47.98	-5.87	Peak	---	---
5	392.78	39.06	46.00	-6.94	44.70	-5.64	QP	121	90
6	471.35	37.13	46.00	-8.87	40.82	-3.69	Peak	---	---

Note 1: Emission Level (dBuV/m) = SA Reading (dBuV/m) + Factor* (dB)

*Factor includes antenna factor , cable loss and amplifier gain

Note 2: Margin (dB) = Emission level (dBuV/m) – Limit (dBuV/m).

Note 3: All spurious emissions below 30MHz are more than 20 dB below the limit.

Modulation	VHT80	Test Freq. (MHz)	5775
Polarization	Horizontal		

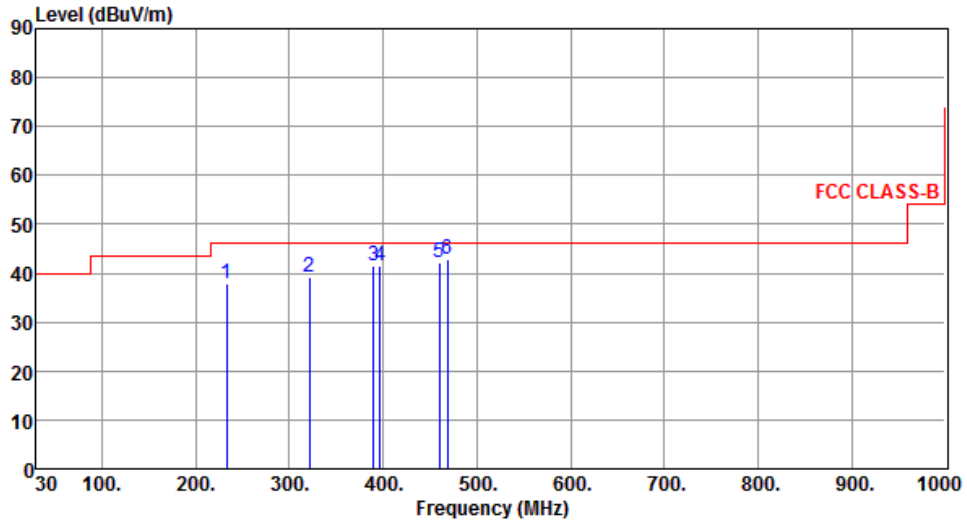

	Freq. MHz	Emission level dBuV/m	Limit dBuV/m	Margin dB	SA reading dBuV	Factor dB	Remark	ANT High cm	Turn Table deg
1	232.73	37.83	46.00	-8.17	49.07	-11.24	Peak	---	---
2	321.00	39.30	46.00	-6.70	46.70	-7.40	Peak	---	---
3	389.87	41.60	46.00	-4.40	47.32	-5.72	Peak	---	---
4	396.66	41.44	46.00	-4.56	47.03	-5.59	Peak	---	---
5	459.71	42.26	46.00	-3.74	46.19	-3.93	Peak	---	---
6	468.44	42.79	46.00	-3.21	46.52	-3.73	Peak	---	---

Note 1: Emission Level (dBuV/m) = SA Reading (dBuV/m) + Factor* (dB)

*Factor includes antenna factor , cable loss and amplifier gain

Note 2: Margin (dB) = Emission level (dBuV/m) – Limit (dBuV/m).

Note 3: All spurious emissions below 30MHz are more than 20 dB below the limit.

Modulation	VHT80	Test Freq. (MHz)	5775
Polarization	Vertical		

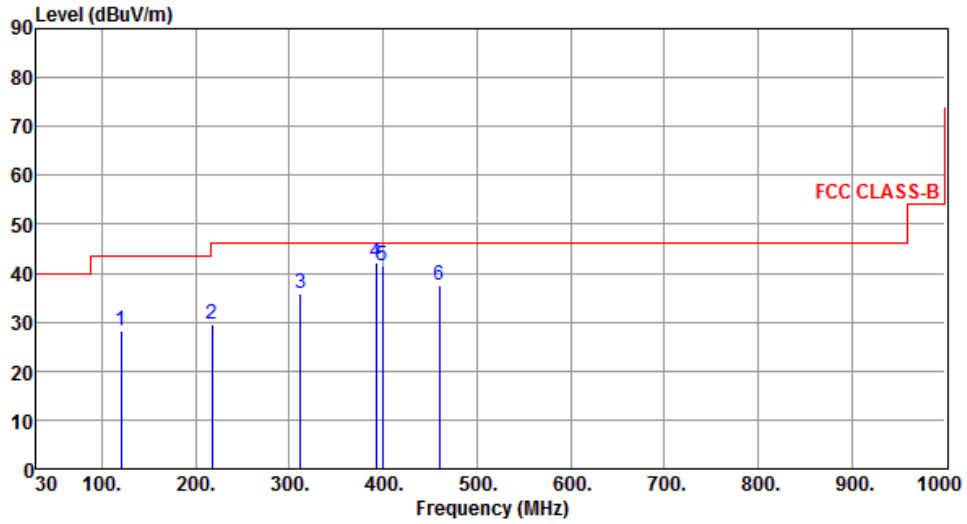

	Freq. MHz	Emission level dBuV/m	Limit dBuV/m	Margin dB	SA reading dBuV	Factor dB	Remark	ANT High cm	Turn Table deg
1	120.21	28.37	43.50	-15.13	39.05	-10.68	Peak	---	---
2	217.21	29.41	46.00	-16.59	41.52	-12.11	Peak	---	---
3	312.27	35.74	46.00	-10.26	43.40	-7.66	Peak	---	---
4	392.78	42.27	46.00	-3.73	47.91	-5.64	Peak	---	---
5	399.57	41.51	46.00	-4.49	47.08	-5.57	Peak	---	---
6	459.71	37.66	46.00	-8.34	41.59	-3.93	Peak	---	---

Note 1: Emission Level (dBuV/m) = SA Reading (dBuV/m) + Factor* (dB)

*Factor includes antenna factor , cable loss and amplifier gain

Note 2: Margin (dB) = Emission level (dBuV/m) – Limit (dBuV/m).

Note 3: All spurious emissions below 30MHz are more than 20 dB below the limit.

3.5.5 Transmitter Radiated Unwanted Emissions (Above 1GHz) for 11a

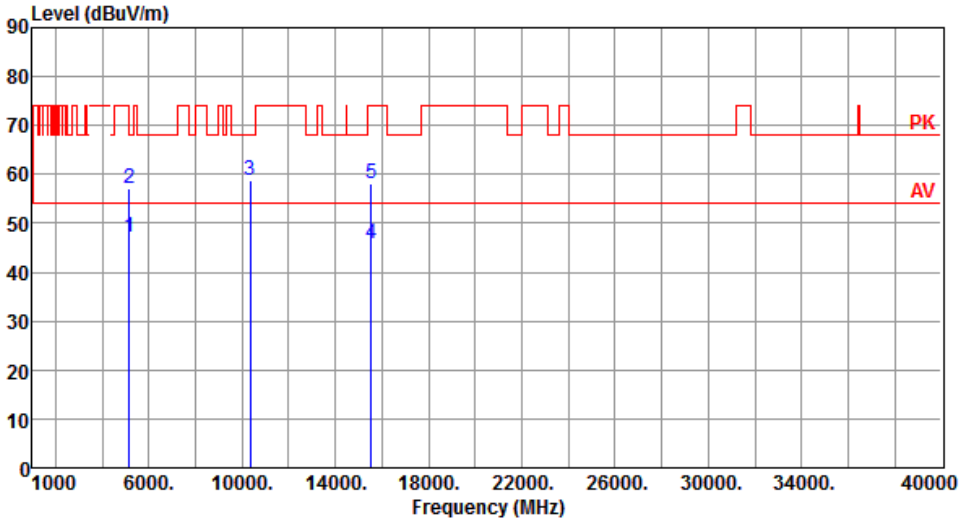
Modulation	11a	Test Freq. (MHz)	5180																																																																		
Polarization	Horizontal																																																																				
																																																																					
	<table border="1"> <thead> <tr> <th>Freq.</th> <th>Emission level</th> <th>Limit</th> <th>Margin</th> <th>SA reading</th> <th>Factor</th> <th>Remark</th> <th>ANT High</th> <th>Turn Table</th> </tr> <tr> <th>MHz</th> <th>dBuV/m</th> <th>dBuV/m</th> <th>dB</th> <th>dBuV</th> <th>dB</th> <th></th> <th>cm</th> <th>deg</th> </tr> </thead> <tbody> <tr> <td>1</td> <td>5150.00</td> <td>47.07</td> <td>54.00</td> <td>-6.93</td> <td>42.53</td> <td>4.54</td> <td>Average</td> <td>100</td> <td>48</td> </tr> <tr> <td>2</td> <td>5150.00</td> <td>57.24</td> <td>74.00</td> <td>-16.76</td> <td>52.70</td> <td>4.54</td> <td>Peak</td> <td>100</td> <td>48</td> </tr> <tr> <td>3</td> <td>10360.00</td> <td>58.62</td> <td>68.20</td> <td>-9.58</td> <td>44.84</td> <td>13.78</td> <td>Peak</td> <td>152</td> <td>241</td> </tr> <tr> <td>4</td> <td>15540.00</td> <td>45.80</td> <td>54.00</td> <td>-8.20</td> <td>31.52</td> <td>14.28</td> <td>Average</td> <td>100</td> <td>345</td> </tr> <tr> <td>5</td> <td>15540.00</td> <td>58.14</td> <td>74.00</td> <td>-15.86</td> <td>43.86</td> <td>14.28</td> <td>Peak</td> <td>100</td> <td>345</td> </tr> </tbody> </table>	Freq.	Emission level	Limit	Margin	SA reading	Factor	Remark	ANT High	Turn Table	MHz	dBuV/m	dBuV/m	dB	dBuV	dB		cm	deg	1	5150.00	47.07	54.00	-6.93	42.53	4.54	Average	100	48	2	5150.00	57.24	74.00	-16.76	52.70	4.54	Peak	100	48	3	10360.00	58.62	68.20	-9.58	44.84	13.78	Peak	152	241	4	15540.00	45.80	54.00	-8.20	31.52	14.28	Average	100	345	5	15540.00	58.14	74.00	-15.86	43.86	14.28	Peak	100	345
Freq.	Emission level	Limit	Margin	SA reading	Factor	Remark	ANT High	Turn Table																																																													
MHz	dBuV/m	dBuV/m	dB	dBuV	dB		cm	deg																																																													
1	5150.00	47.07	54.00	-6.93	42.53	4.54	Average	100	48																																																												
2	5150.00	57.24	74.00	-16.76	52.70	4.54	Peak	100	48																																																												
3	10360.00	58.62	68.20	-9.58	44.84	13.78	Peak	152	241																																																												
4	15540.00	45.80	54.00	-8.20	31.52	14.28	Average	100	345																																																												
5	15540.00	58.14	74.00	-15.86	43.86	14.28	Peak	100	345																																																												
<p>Note 1: Emission Level (dBuV/m) = SA Reading (dBuV/m) + Factor* (dB) *Factor includes antenna factor , cable loss and amplifier gain Note 2: Margin (dB) = Emission level (dBuV/m) – Limit (dBuV/m).</p>																																																																					

Modulation	11a	Test Freq. (MHz)	5180
Polarization	Vertical		

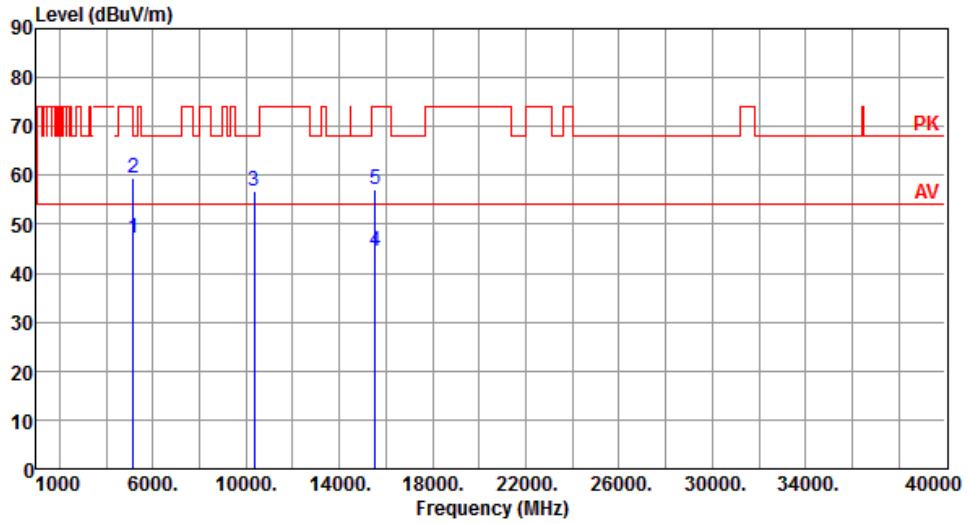

	Freq. MHz	Emission level dBuV/m	Limit dBuV/m	Margin dB	SA reading dBuV	Factor dB	Remark	ANT High cm	Turn Table deg
1	5150.00	47.15	54.00	-6.85	42.61	4.54	Average	337	3
2	5150.00	59.33	74.00	-14.67	54.79	4.54	Peak	337	3
3	10360.00	56.64	68.20	-11.56	42.86	13.78	Peak	100	186
4	15540.00	44.49	54.00	-9.51	30.21	14.28	Average	100	110
5	15540.00	57.17	74.00	-16.83	42.89	14.28	Peak	100	110

Note 1: Emission Level (dBuV/m) = SA Reading (dBuV/m) + Factor* (dB)

*Factor includes antenna factor , cable loss and amplifier gain

Note 2: Margin (dB) = Emission level (dBuV/m) – Limit (dBuV/m).

Modulation	11a	Test Freq. (MHz)	5200
Polarization	Horizontal		

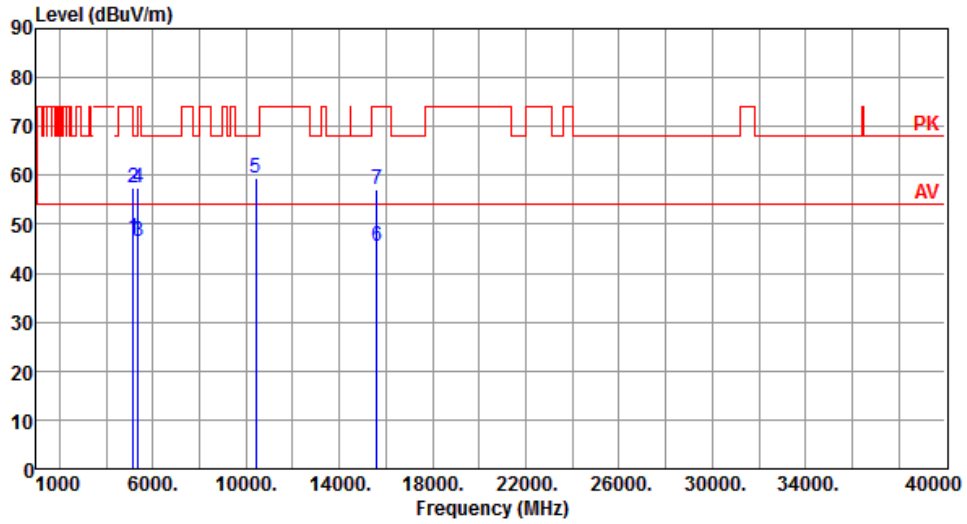

	Freq. MHz	Emission level dBuV/m	Limit dBuV/m	Margin dB	SA reading dBuV	Factor dB	Remark	ANT High cm	Turn Table deg
1	5150.00	47.07	54.00	-6.93	42.53	4.54	Average	100	50
2	5150.00	57.44	74.00	-16.56	52.90	4.54	Peak	100	50
3	5350.00	46.59	54.00	-7.41	42.46	4.13	Average	100	50
4	5350.00	57.37	74.00	-16.63	53.24	4.13	Peak	100	50
5	10400.00	59.41	68.20	-8.79	45.52	13.89	Peak	162	247
6	15600.00	45.62	54.00	-8.38	31.52	14.10	Average	100	23
7	15600.00	56.98	74.00	-17.02	42.88	14.10	Peak	100	23

Note 1: Emission Level (dBuV/m) = SA Reading (dBuV/m) + Factor* (dB)

*Factor includes antenna factor , cable loss and amplifier gain

Note 2: Margin (dB) = Emission level (dBuV/m) – Limit (dBuV/m).

Modulation	11a	Test Freq. (MHz)	5200
Polarization	Vertical		

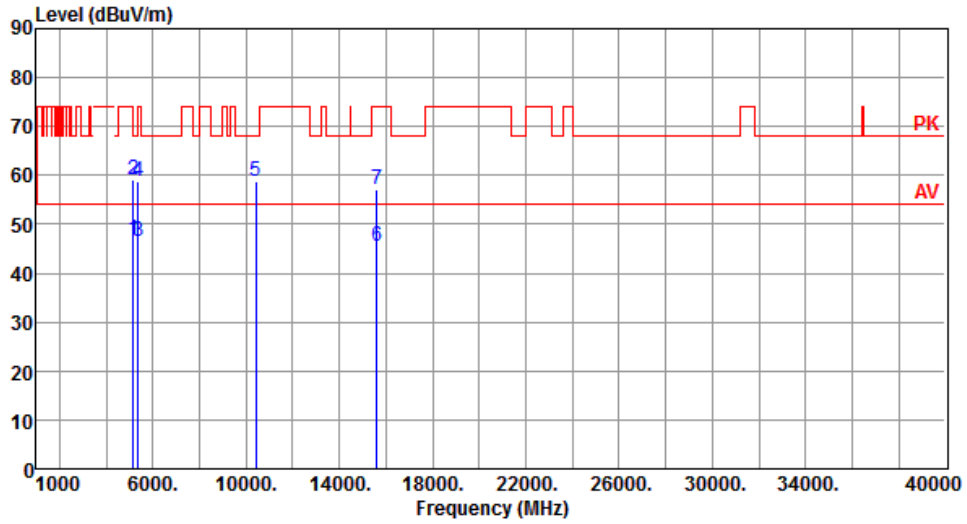

	Freq. MHz	Emission level dBuV/m	Limit dBuV/m	Margin dB	SA reading dBuV	Factor dB	Remark	ANT High cm	Turn Table deg
1	5150.00	46.80	54.00	-7.20	42.26	4.54	Average	315	2
2	5150.00	59.07	74.00	-14.93	54.53	4.54	Peak	315	2
3	5350.00	46.40	54.00	-7.60	42.27	4.13	Average	315	2
4	5350.00	58.64	74.00	-15.36	54.51	4.13	Peak	315	2
5	10400.00	58.74	68.20	-9.46	44.85	13.89	Peak	132	183
6	15600.00	45.46	54.00	-8.54	31.36	14.10	Average	100	99
7	15600.00	56.98	74.00	-17.02	42.88	14.10	Peak	100	99

Note 1: Emission Level (dBuV/m) = SA Reading (dBuV/m) + Factor* (dB)

*Factor includes antenna factor , cable loss and amplifier gain

Note 2: Margin (dB) = Emission level (dBuV/m) – Limit (dBuV/m).

Modulation	11a	Test Freq. (MHz)	5240
Polarization	Horizontal		

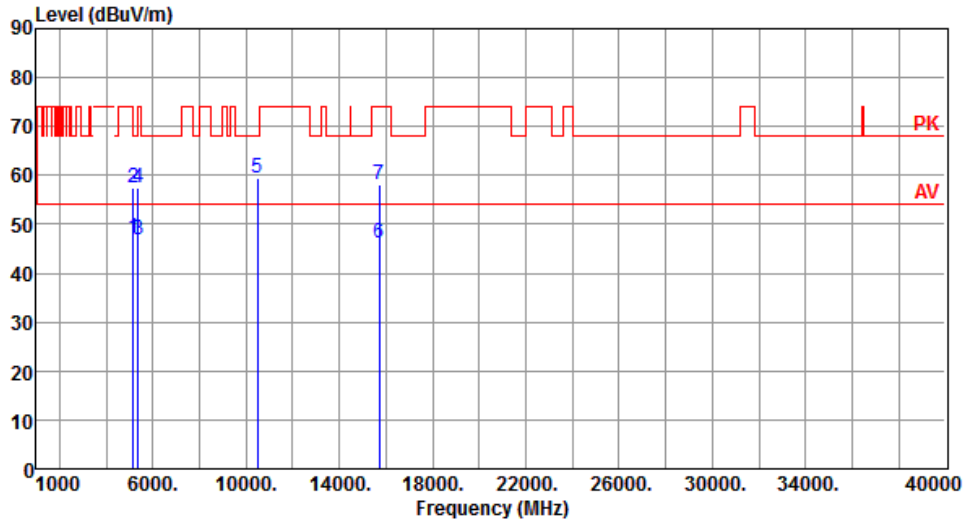

	Freq. MHz	Emission level dBuV/m	Limit dBuV/m	Margin dB	SA reading dBuV	Factor dB	Remark	ANT High cm	Turn Table deg
1	5150.00	47.06	54.00	-6.94	42.52	4.54	Average	100	65
2	5150.00	57.51	74.00	-16.49	52.97	4.54	Peak	100	65
3	5350.00	46.81	54.00	-7.19	42.68	4.13	Average	100	65
4	5350.00	57.33	74.00	-16.67	53.20	4.13	Peak	100	65
5	10480.00	59.56	68.20	-8.64	45.68	13.88	Peak	159	245
6	15720.00	46.06	54.00	-7.94	32.17	13.89	Average	100	348
7	15720.00	58.14	74.00	-15.86	44.25	13.89	Peak	100	348

Note 1: Emission Level (dBuV/m) = SA Reading (dBuV/m) + Factor* (dB)

*Factor includes antenna factor , cable loss and amplifier gain

Note 2: Margin (dB) = Emission level (dBuV/m) – Limit (dBuV/m).

Modulation	11a	Test Freq. (MHz)	5240
Polarization	Vertical		

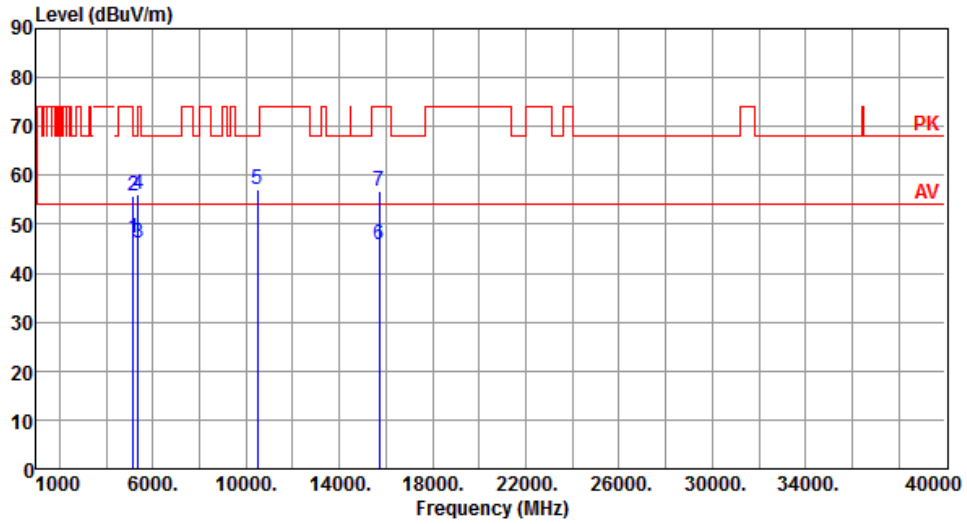

	Freq. MHz	Emission level dBuV/m	Limit dBuV/m	Margin dB	SA reading dBuV	Factor dB	Remark	ANT High cm	Turn Table deg
1	5150.00	47.17	54.00	-6.83	42.63	4.54	Average	328	359
2	5150.00	55.83	74.00	-18.17	51.29	4.54	Peak	328	359
3	5350.00	46.29	54.00	-7.71	42.16	4.13	Average	328	359
4	5350.00	55.98	74.00	-18.02	51.85	4.13	Peak	328	359
5	10480.00	57.16	68.20	-11.04	43.28	13.88	Peak	113	186
6	15720.00	45.90	54.00	-8.10	32.01	13.89	Average	100	178
7	15720.00	56.75	74.00	-17.25	42.86	13.89	Peak	100	178

Note 1: Emission Level (dBuV/m) = SA Reading (dBuV/m) + Factor* (dB)

*Factor includes antenna factor , cable loss and amplifier gain

Note 2: Margin (dB) = Emission level (dBuV/m) – Limit (dBuV/m).

Modulation	11a	Test Freq. (MHz)	5260
Polarization	Horizontal		

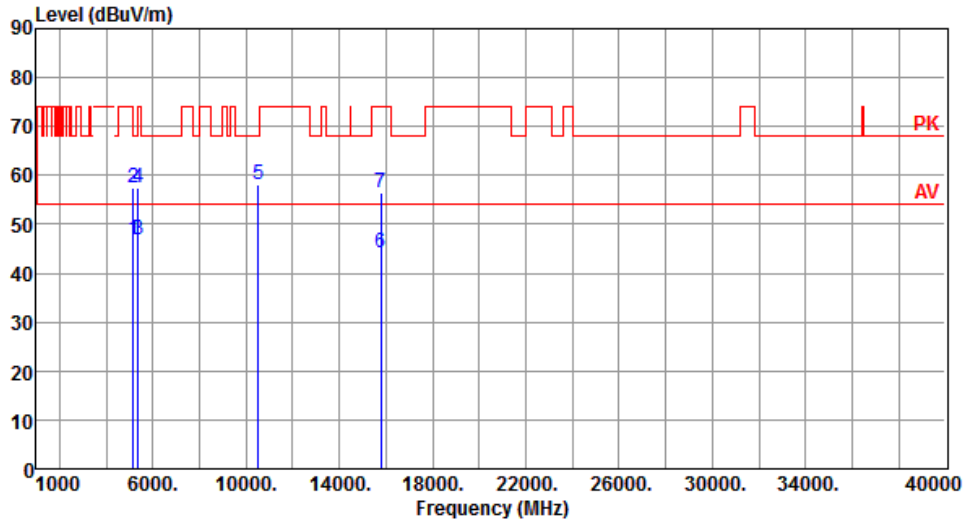

	Freq. MHz	Emission level dBuV/m	Limit dBuV/m	Margin dB	SA reading dBuV	Factor dB	Remark	ANT High cm	Turn Table deg
1	5150.00	46.90	54.00	-7.10	42.36	4.54	Average	100	59
2	5150.00	57.30	74.00	-16.70	52.76	4.54	Peak	100	59
3	5350.00	46.98	54.00	-7.02	42.85	4.13	Average	100	59
4	5350.00	57.36	74.00	-16.64	53.23	4.13	Peak	100	59
5	10520.00	58.23	68.20	-9.97	44.35	13.88	Peak	200	245
6	15780.00	44.16	54.00	-9.84	30.33	13.83	Average	100	55
7	15780.00	56.41	74.00	-17.59	42.58	13.83	Peak	100	55

Note 1: Emission Level (dBuV/m) = SA Reading (dBuV/m) + Factor* (dB)

*Factor includes antenna factor , cable loss and amplifier gain

Note 2: Margin (dB) = Emission level (dBuV/m) – Limit (dBuV/m).

Modulation	11a	Test Freq. (MHz)	5260
Polarization	Vertical		

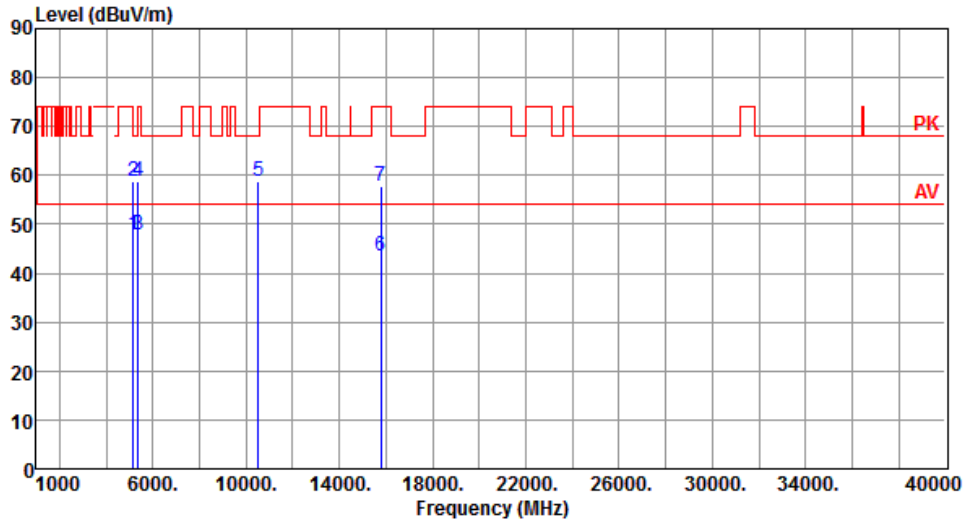

	Freq. MHz	Emission level dBuV/m	Limit dBuV/m	Margin dB	SA reading dBuV	Factor dB	Remark	ANT High cm	Turn Table deg
1	5150.00	47.80	54.00	-6.20	43.26	4.54	Average	342	2
2	5150.00	58.80	74.00	-15.20	54.26	4.54	Peak	342	2
3	5350.00	47.68	54.00	-6.32	43.55	4.13	Average	342	2
4	5350.00	58.65	74.00	-15.35	54.52	4.13	Peak	342	2
5	10520.00	58.73	68.20	-9.47	44.85	13.88	Peak	100	183
6	15780.00	43.45	54.00	-10.55	29.62	13.83	Average	100	150
7	15780.00	57.72	74.00	-16.28	43.89	13.83	Peak	100	150

Note 1: Emission Level (dBuV/m) = SA Reading (dBuV/m) + Factor* (dB)

*Factor includes antenna factor , cable loss and amplifier gain

Note 2: Margin (dB) = Emission level (dBuV/m) – Limit (dBuV/m).

Modulation	11a	Test Freq. (MHz)	5300
Polarization	Horizontal		

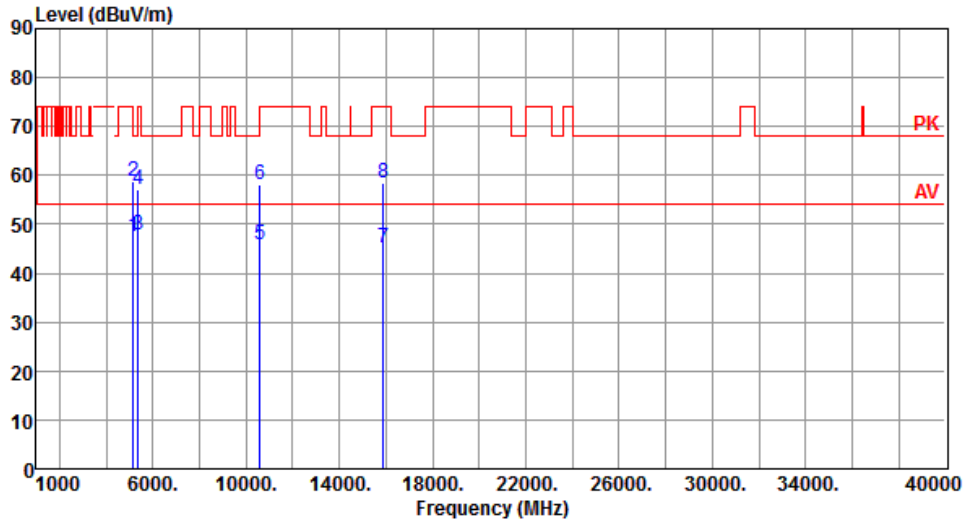

	Freq. MHz	Emission level dBuV/m	Limit dBuV/m	Margin dB	SA reading dBuV	Factor dB	Remark	ANT High cm	Turn Table deg
1	5150.00	47.41	54.00	-6.59	42.87	4.54	Average	100	45
2	5150.00	58.90	74.00	-15.10	54.36	4.54	Peak	100	45
3	5350.00	47.77	54.00	-6.23	43.64	4.13	Average	100	45
4	5350.00	57.00	74.00	-17.00	52.87	4.13	Peak	100	45
5	10600.00	45.77	54.00	-8.23	31.92	13.85	Average	160	245
6	10600.00	58.21	74.00	-15.79	44.36	13.85	Peak	160	245
7	15900.00	45.07	54.00	-8.93	31.25	13.82	Average	100	53
8	15900.00	58.45	74.00	-15.55	44.63	13.82	Peak	100	53

Note 1: Emission Level (dBuV/m) = SA Reading (dBuV/m) + Factor* (dB)

*Factor includes antenna factor , cable loss and amplifier gain

Note 2: Margin (dB) = Emission level (dBuV/m) – Limit (dBuV/m).

Modulation	11a	Test Freq. (MHz)	5300
Polarization	Vertical		

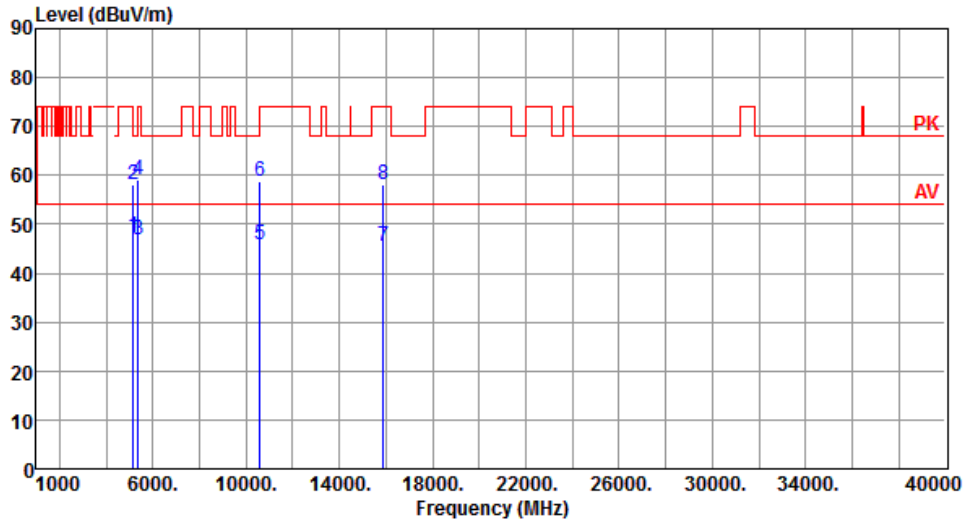

	Freq. MHz	Emission level dBuV/m	Limit dBuV/m	Margin dB	SA reading dBuV	Factor dB	Remark	ANT High cm	Turn Table deg
1	5150.00	47.39	54.00	-6.61	42.85	4.54	Average	325	355
2	5150.00	58.13	74.00	-15.87	53.59	4.54	Peak	325	355
3	5350.00	46.98	54.00	-7.02	42.85	4.13	Average	325	355
4	5350.00	59.08	74.00	-14.92	54.95	4.13	Peak	325	355
5	10600.00	45.77	54.00	-8.23	31.92	13.85	Average	100	177
6	10600.00	58.78	74.00	-15.22	44.93	13.85	Peak	100	177
7	15900.00	45.46	54.00	-8.54	31.64	13.82	Average	100	142
8	15900.00	58.14	74.00	-15.86	44.32	13.82	Peak	100	142

Note 1: Emission Level (dBuV/m) = SA Reading (dBuV/m) + Factor* (dB)

*Factor includes antenna factor , cable loss and amplifier gain

Note 2: Margin (dB) = Emission level (dBuV/m) – Limit (dBuV/m).

Modulation	11a	Test Freq. (MHz)	5320
Polarization	Horizontal		

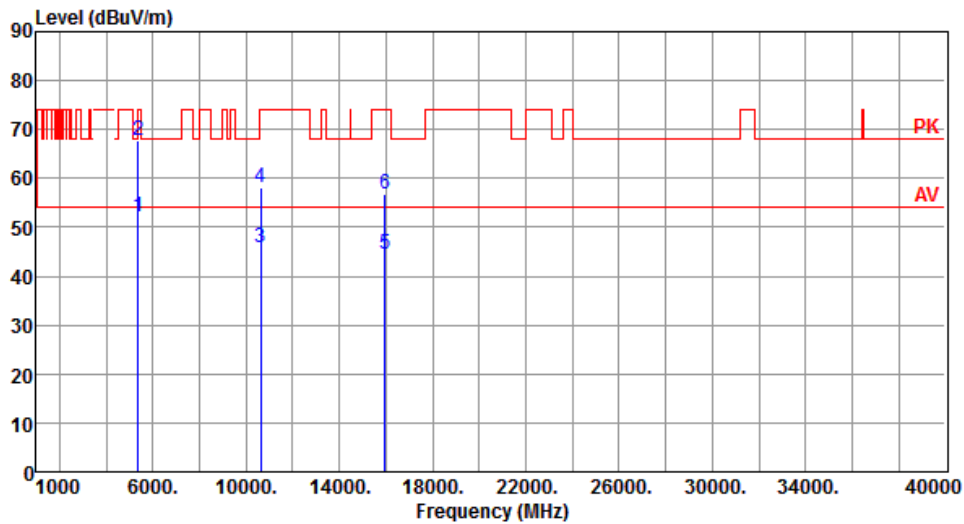

	Freq. MHz	Emission level dBuV/m	Limit dBuV/m	Margin dB	SA reading dBuV	Factor dB	Remark	ANT High cm	Turn Table deg
1	5350.00	51.98	54.00	-2.02	47.85	4.13	Average	100	56
2	5350.00	67.81	74.00	-6.19	63.68	4.13	Peak	100	56
3	10640.00	45.79	54.00	-8.21	31.94	13.85	Average	166	242
4	10640.00	58.19	74.00	-15.81	44.34	13.85	Peak	166	242
5	15960.00	44.40	54.00	-9.60	30.64	13.76	Average	100	60
6	15960.00	56.75	74.00	-17.25	42.99	13.76	Peak	100	60

Note 1: Emission Level (dBuV/m) = SA Reading (dBuV/m) + Factor* (dB)

*Factor includes antenna factor , cable loss and amplifier gain

Note 2: Margin (dB) = Emission level (dBuV/m) – Limit (dBuV/m).

Modulation	11a	Test Freq. (MHz)	5320
Polarization	Vertical		

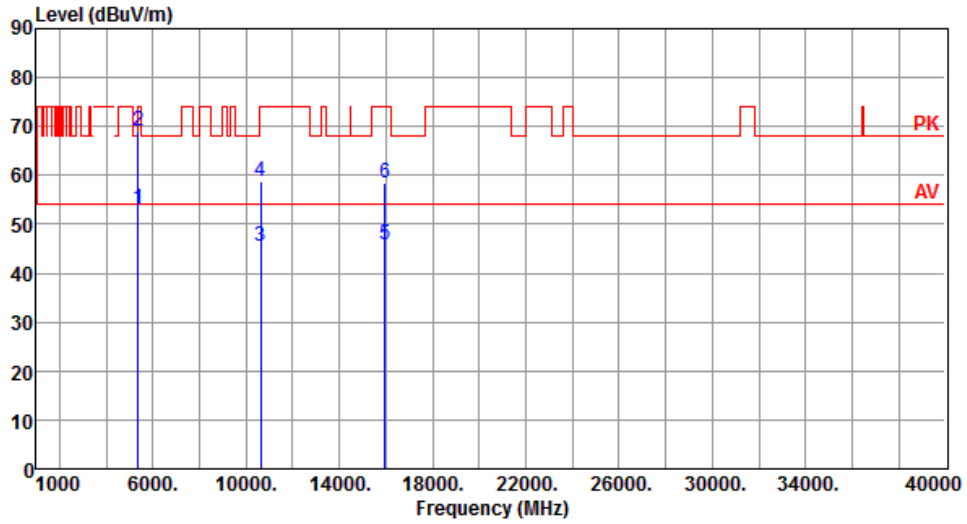

	Freq. MHz	Emission level dBuV/m	Limit dBuV/m	Margin dB	SA reading dBuV	Factor dB	Remark	ANT High cm	Turn Table deg
1	5350.00	53.07	54.00	-0.93	48.94	4.13	Average	335	356
2	5350.00	69.01	74.00	-4.99	64.88	4.13	Peak	335	356
3	10640.00	45.44	54.00	-8.56	31.59	13.85	Average	113	186
4	10640.00	58.70	74.00	-15.30	44.85	13.85	Peak	113	186
5	15960.00	45.72	54.00	-8.28	31.96	13.76	Average	145	149
6	15960.00	58.31	74.00	-15.69	44.55	13.76	Peak	145	149

Note 1: Emission Level (dBuV/m) = SA Reading (dBuV/m) + Factor* (dB)

*Factor includes antenna factor , cable loss and amplifier gain

Note 2: Margin (dB) = Emission level (dBuV/m) – Limit (dBuV/m).

Modulation	11a	Test Freq. (MHz)	5500
Polarization	Horizontal		

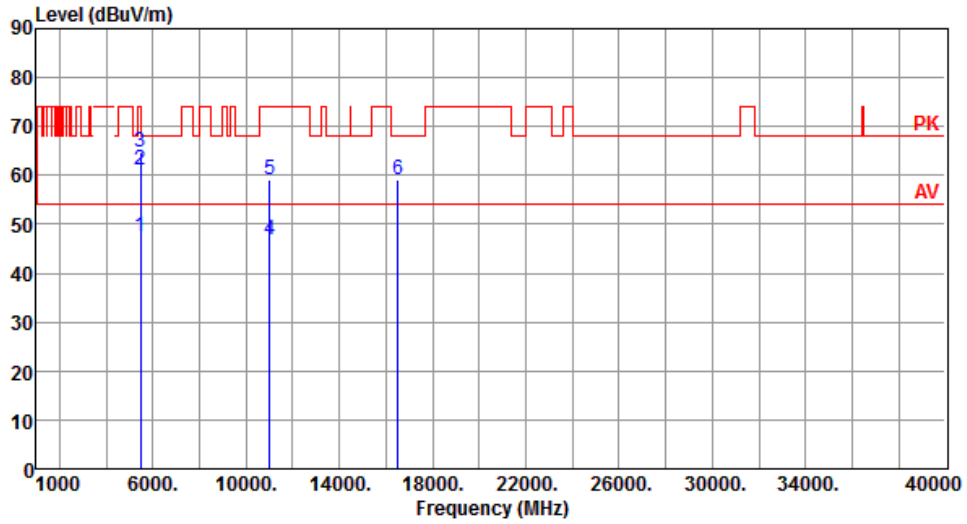

	Freq. MHz	Emission level dBuV/m	Limit dBuV/m	Margin dB	SA reading dBuV	Factor dB	Remark	ANT High cm	Turn Table deg
1	5460.00	47.49	54.00	-6.51	42.85	4.64	Average	100	47
2	5460.00	61.20	74.00	-12.80	56.56	4.64	Peak	100	47
3	5470.00	64.66	68.20	-3.54	60.01	4.65	Peak	100	47
4	11000.00	46.82	54.00	-7.18	32.57	14.25	Average	100	95
5	11000.00	59.10	74.00	-14.90	44.85	14.25	Peak	100	95
6	16500.00	59.00	68.20	-9.20	43.27	15.73	Peak	100	5

Note 1: Emission Level (dBuV/m) = SA Reading (dBuV/m) + Factor* (dB)

*Factor includes antenna factor , cable loss and amplifier gain

Note 2: Margin (dB) = Emission level (dBuV/m) – Limit (dBuV/m).

Modulation	11a	Test Freq. (MHz)	5500
Polarization	Vertical		

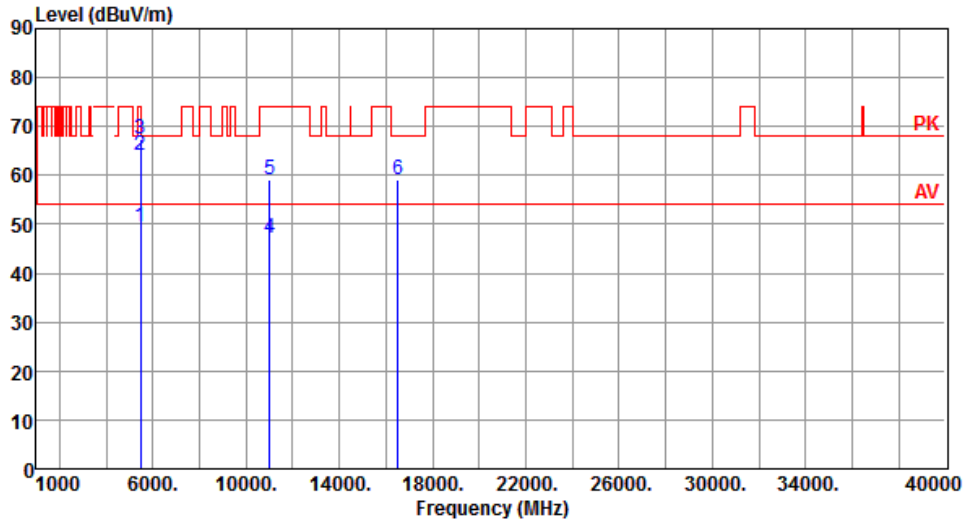

	Freq. MHz	Emission level dBuV/m	Limit dBuV/m	Margin dB	SA reading dBuV	Factor dB	Remark	ANT High cm	Turn Table deg
1	5460.00	49.63	54.00	-4.37	44.99	4.64	Average	344	3
2	5460.00	64.09	74.00	-9.91	59.45	4.64	Peak	344	3
3	5470.00	67.49	68.20	-0.71	62.84	4.65	Peak	344	3
4	11000.00	47.08	54.00	-6.92	32.83	14.25	Average	187	200
5	11000.00	59.21	74.00	-14.79	44.96	14.25	Peak	187	200
6	16500.00	58.98	68.20	-9.22	43.25	15.73	Peak	100	146

Note 1: Emission Level (dBuV/m) = SA Reading (dBuV/m) + Factor* (dB)

*Factor includes antenna factor , cable loss and amplifier gain

Note 2: Margin (dB) = Emission level (dBuV/m) – Limit (dBuV/m).

Modulation	11a	Test Freq. (MHz)	5580
Polarization	Horizontal		

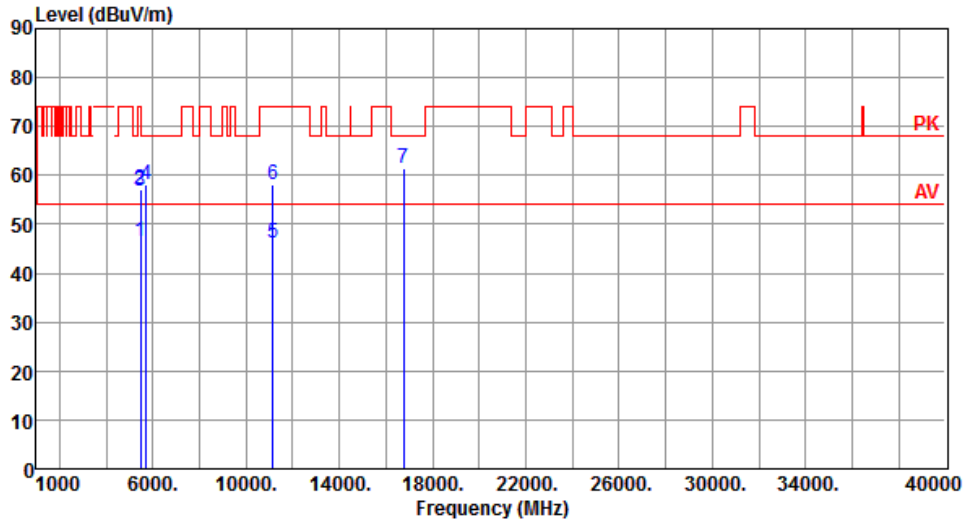

	Freq. MHz	Emission level dBuV/m	Limit dBuV/m	Margin dB	SA reading dBuV	Factor dB	Remark	ANT High cm	Turn Table deg
1	5460.00	46.65	54.00	-7.35	42.01	4.64	Average	100	47
2	5460.00	57.21	74.00	-16.79	52.57	4.64	Peak	100	47
3	5470.00	56.95	68.20	-11.25	52.30	4.65	Peak	100	47
4	5725.00	57.96	68.20	-10.24	52.71	5.25	Peak	100	47
5	11160.00	46.17	54.00	-7.83	32.28	13.89	Average	100	99
6	11160.00	58.28	74.00	-15.72	44.39	13.89	Peak	100	99
7	16740.00	61.34	68.20	-6.86	44.26	17.08	Peak	100	3

Note 1: Emission Level (dBuV/m) = SA Reading (dBuV/m) + Factor* (dB)

*Factor includes antenna factor , cable loss and amplifier gain

Note 2: Margin (dB) = Emission level (dBuV/m) – Limit (dBuV/m).

Modulation	11a	Test Freq. (MHz)	5580
Polarization	Vertical		

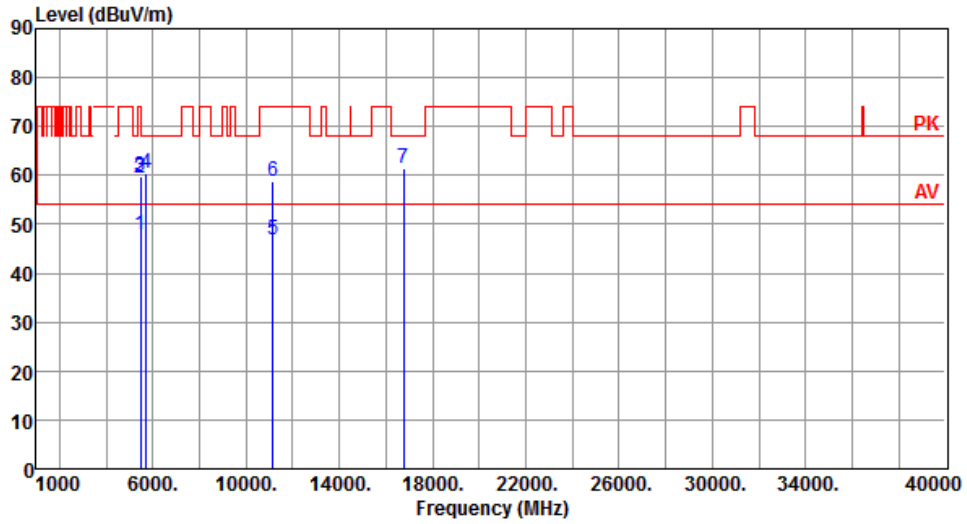

	Freq. MHz	Emission level dBuV/m	Limit dBuV/m	Margin dB	SA reading dBuV	Factor dB	Remark	ANT High cm	Turn Table deg
1	5460.00	47.88	54.00	-6.12	43.24	4.64	Average	332	6
2	5460.00	59.50	74.00	-14.50	54.86	4.64	Peak	332	6
3	5470.00	59.85	68.20	-8.35	55.20	4.65	Peak	332	6
4	5725.00	60.42	68.20	-7.78	55.17	5.25	Peak	332	6
5	11160.00	46.73	54.00	-7.27	32.84	13.89	Average	177	206
6	11160.00	58.73	74.00	-15.27	44.84	13.89	Peak	177	206
7	16740.00	61.55	68.20	-6.65	44.47	17.08	Peak	100	136

Note 1: Emission Level (dBuV/m) = SA Reading (dBuV/m) + Factor* (dB)

*Factor includes antenna factor , cable loss and amplifier gain

Note 2: Margin (dB) = Emission level (dBuV/m) – Limit (dBuV/m).

Modulation	11a	Test Freq. (MHz)	5700
Polarization	Horizontal		

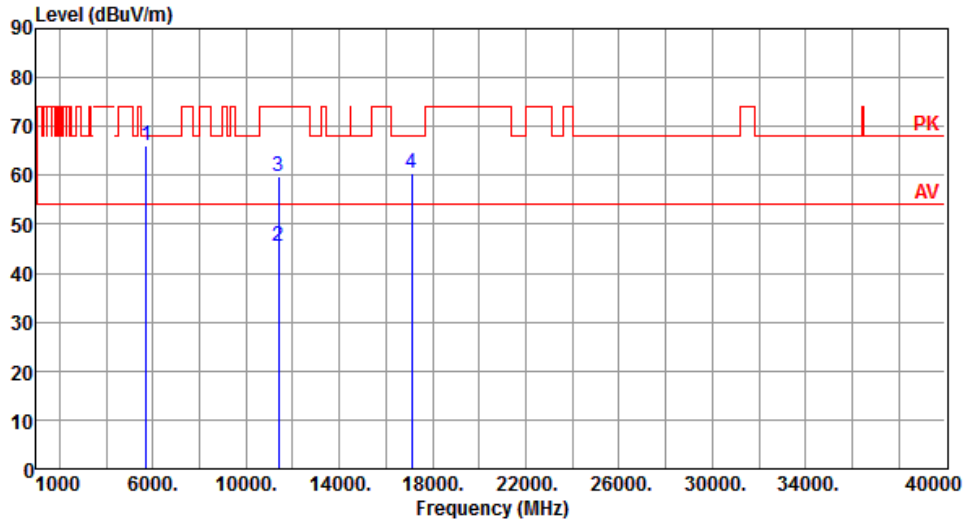

	Freq. MHz	Emission level dBuV/m	Limit dBuV/m	Margin dB	SA reading dBuV	Factor dB	Remark	ANT High cm	Turn Table deg
1	5725.00	65.93	68.20	-2.27	60.68	5.25	Peak	100	48
2	11400.00	45.54	54.00	-8.46	31.54	14.00	Average	100	106
3	11400.00	59.66	74.00	-14.34	45.66	14.00	Peak	100	106
4	17100.00	60.51	68.20	-7.69	43.58	16.93	Peak	100	2

Note 1: Emission Level (dBuV/m) = SA Reading (dBuV/m) + Factor* (dB)

*Factor includes antenna factor , cable loss and amplifier gain

Note 2: Margin (dB) = Emission level (dBuV/m) – Limit (dBuV/m).

Modulation	11a	Test Freq. (MHz)	5700
Polarization	Vertical		

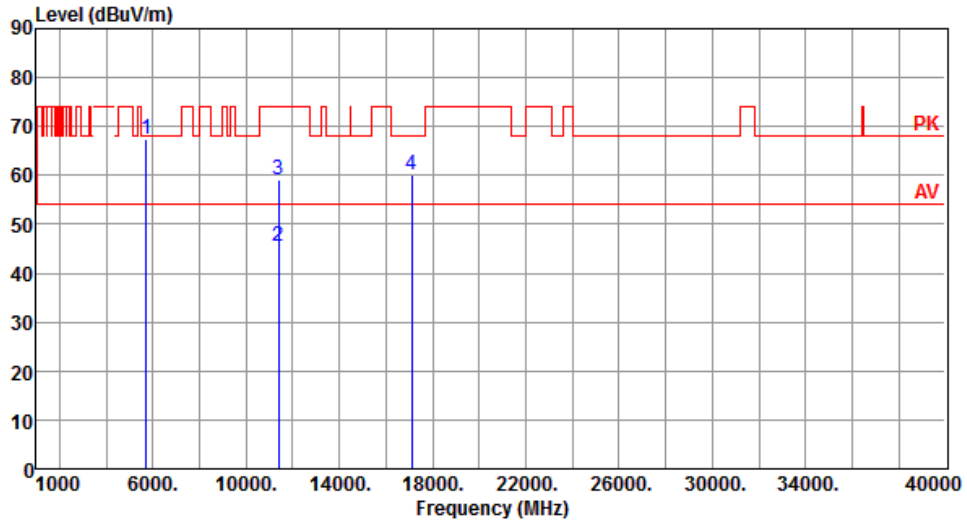

	Freq. MHz	Emission level dBuV/m	Limit dBuV/m	Margin dB	SA reading dBuV	Factor dB	Remark	ANT High cm	Turn Table deg
1	5725.00	67.58	68.20	-0.62	62.33	5.25	Peak	350	10
2	11400.00	45.62	54.00	-8.38	31.62	14.00	Average	238	198
3	11400.00	59.22	74.00	-14.78	45.22	14.00	Peak	238	198
4	17100.00	60.13	68.20	-8.07	43.20	16.93	Peak	100	140

Note 1: Emission Level (dBuV/m) = SA Reading (dBuV/m) + Factor* (dB)

*Factor includes antenna factor , cable loss and amplifier gain

Note 2: Margin (dB) = Emission level (dBuV/m) – Limit (dBuV/m).

Modulation	11a	Test Freq. (MHz)	5745
Polarization	Horizontal		

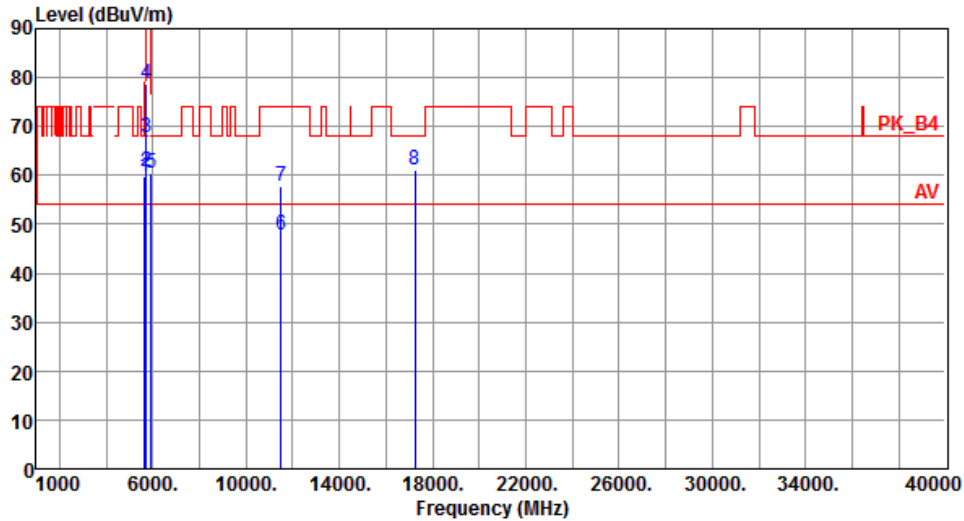

	Freq. MHz	Emission level dBuV/m	Limit dBuV/m	Margin dB	SA reading dBuV	Factor dB	Remark	ANT High cm	Turn Table deg
1	5650.00	59.81	68.20	-8.39	54.84	4.97	Peak	268	322
2	5700.00	60.80	105.20	-44.40	55.64	5.16	Peak	268	322
3	5720.00	67.80	110.80	-43.00	62.57	5.23	Peak	268	322
4	5725.00	78.85	122.20	-43.35	73.60	5.25	Peak	268	322
5	5925.00	60.34	68.20	-7.86	54.25	6.09	Peak	268	322
6	11490.00	47.97	54.00	-6.03	33.85	14.12	Average	341	138
7	11490.00	57.71	74.00	-16.29	43.59	14.12	Peak	341	138
8	17235.00	61.08	68.20	-7.12	43.85	17.23	Peak	100	52

Note 1: Emission Level (dBuV/m) = SA Reading (dBuV/m) + Factor* (dB)

*Factor includes antenna factor , cable loss and amplifier gain

Note 2: Margin (dB) = Emission level (dBuV/m) – Limit (dBuV/m).

Modulation	11a	Test Freq. (MHz)	5745
Polarization	Vertical		

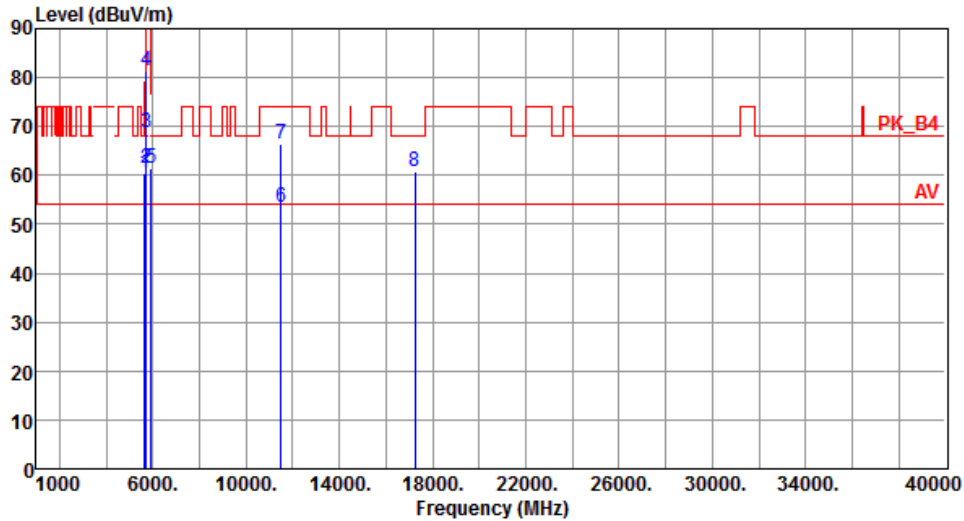

	Freq. MHz	Emission level dBuV/m	Limit dBuV/m	Margin dB	SA reading dBuV	Factor dB	Remark	ANT High cm	Turn Table deg
1	5650.00	60.38	68.20	-7.82	55.41	4.97	Peak	339	1
2	5700.00	61.40	105.20	-43.80	56.24	5.16	Peak	339	1
3	5720.00	68.72	110.80	-42.08	63.49	5.23	Peak	339	1
4	5725.00	81.42	122.20	-40.78	76.17	5.25	Peak	339	1
5	5925.00	61.29	68.20	-6.91	55.20	6.09	Peak	339	1
6	11490.00	53.56	54.00	-0.44	39.44	14.12	Average	182	200
7	11490.00	66.27	74.00	-7.73	52.15	14.12	Peak	182	200
8	17235.00	60.78	68.20	-7.42	43.55	17.23	Peak	100	201

Note 1: Emission Level (dBuV/m) = SA Reading (dBuV/m) + Factor* (dB)

*Factor includes antenna factor , cable loss and amplifier gain

Note 2: Margin (dB) = Emission level (dBuV/m) – Limit (dBuV/m).

Modulation	11a	Test Freq. (MHz)	5785
Polarization	Horizontal		

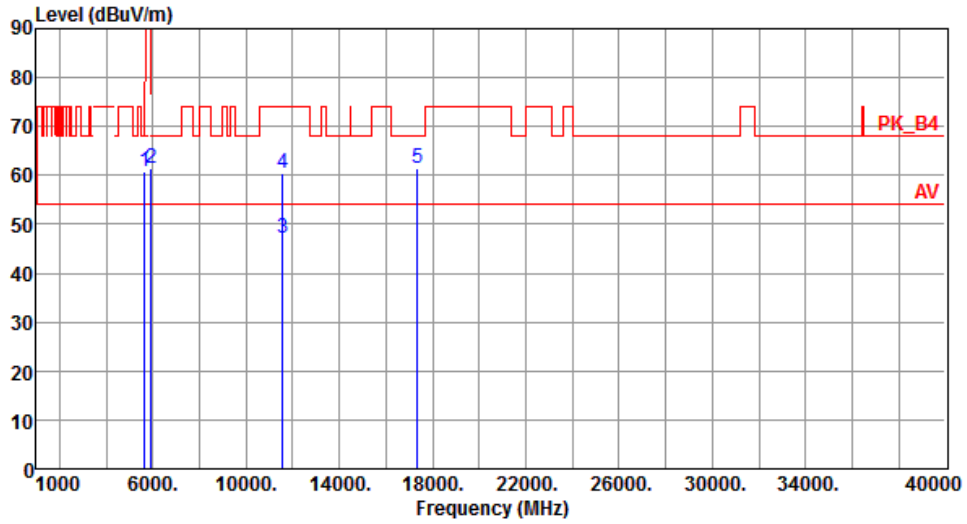

	Freq. MHz	Emission level dBuV/m	Limit dBuV/m	Margin dB	SA reading dBuV	Factor dB	Remark	ANT High cm	Turn Table deg
1	5650.00	60.86	68.20	-7.34	55.89	4.97	Peak	258	326
2	5925.00	61.50	68.20	-6.70	55.41	6.09	Peak	258	326
3	11570.00	47.09	54.00	-6.91	33.14	13.95	Average	364	139
4	11570.00	60.45	74.00	-13.55	46.50	13.95	Peak	364	139
5	17355.00	61.45	68.20	-6.75	43.83	17.62	Peak	100	52

Note 1: Emission Level (dBuV/m) = SA Reading (dBuV/m) + Factor* (dB)

*Factor includes antenna factor , cable loss and amplifier gain

Note 2: Margin (dB) = Emission level (dBuV/m) – Limit (dBuV/m).

Modulation	11a	Test Freq. (MHz)	5785
Polarization	Vertical		

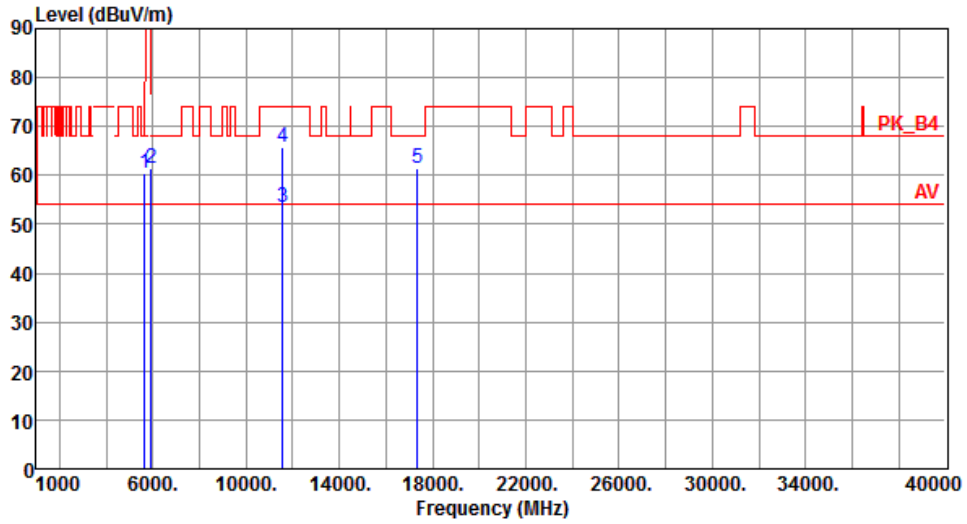

	Freq. MHz	Emission level dBuV/m	Limit dBuV/m	Margin dB	SA reading dBuV	Factor dB	Remark	ANT High cm	Turn Table deg
1	5650.00	60.38	68.20	-7.82	55.41	4.97	Peak	368	7
2	5925.00	61.44	68.20	-6.76	55.35	6.09	Peak	368	7
3	11570.00	53.53	54.00	-0.47	39.58	13.95	Average	181	192
4	11570.00	65.90	74.00	-8.10	51.95	13.95	Peak	181	192
5	17355.00	61.46	68.20	-6.74	43.84	17.62	Peak	100	201

Note 1: Emission Level (dBuV/m) = SA Reading (dBuV/m) + Factor* (dB)

*Factor includes antenna factor , cable loss and amplifier gain

Note 2: Margin (dB) = Emission level (dBuV/m) – Limit (dBuV/m).

Modulation	11a	Test Freq. (MHz)	5825
Polarization	Horizontal		

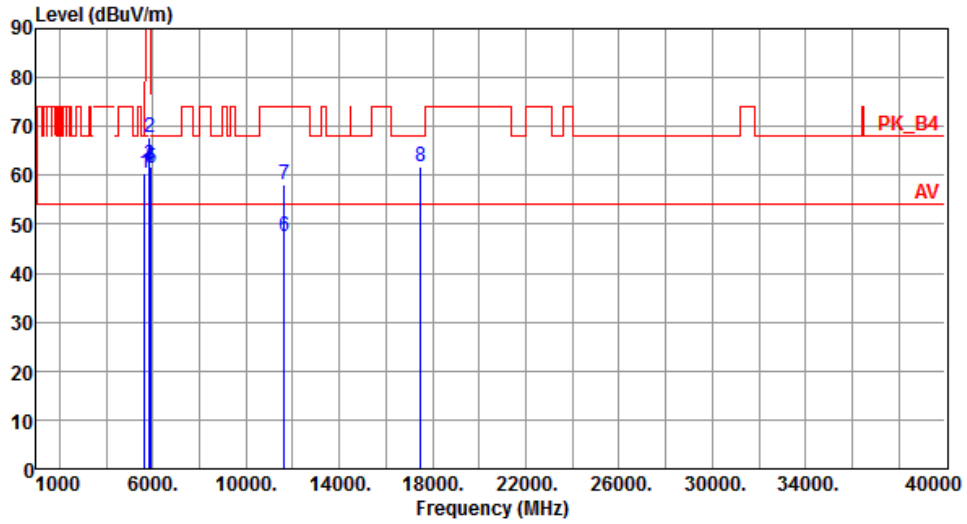

	Freq. MHz	Emission level dBuV/m	Limit dBuV/m	Margin dB	SA reading dBuV	Factor dB	Remark	ANT High cm	Turn Table deg
1	5650.00	60.51	68.20	-7.69	55.54	4.97	Peak	293	330
2	5850.00	67.66	122.20	-54.54	61.85	5.81	Peak	293	330
3	5855.00	62.07	110.80	-48.73	56.24	5.83	Peak	293	330
4	5875.00	61.76	105.20	-43.44	55.86	5.90	Peak	293	330
5	5925.00	61.50	68.20	-6.70	55.41	6.09	Peak	293	330
6	11650.00	47.58	54.00	-6.42	33.96	13.62	Average	324	153
7	11650.00	58.17	74.00	-15.83	44.55	13.62	Peak	324	153
8	17475.00	61.73	68.20	-6.47	43.83	17.90	Peak	100	53

Note 1: Emission Level (dBuV/m) = SA Reading (dBuV/m) + Factor* (dB)

*Factor includes antenna factor , cable loss and amplifier gain

Note 2: Margin (dB) = Emission level (dBuV/m) – Limit (dBuV/m).

Modulation	11a	Test Freq. (MHz)	5825
Polarization	Vertical		

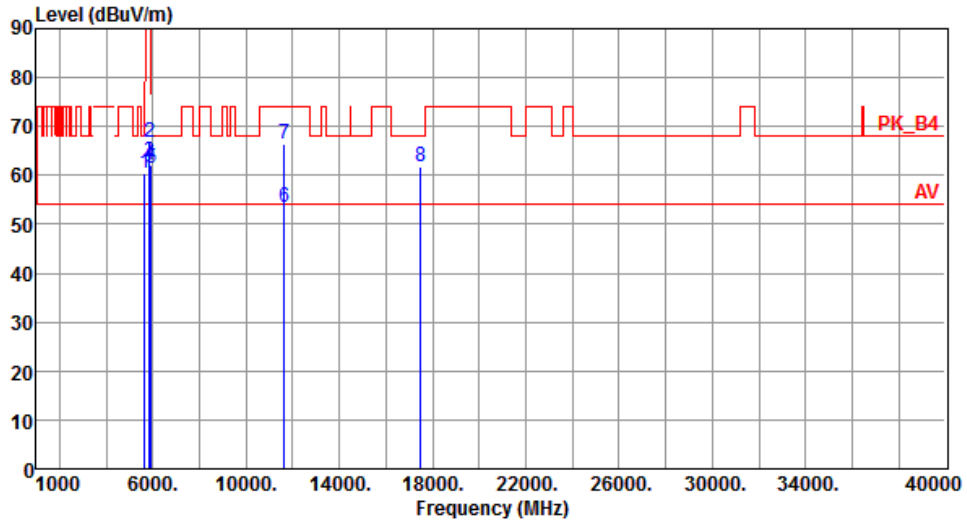

	Freq. MHz	Emission level dBuV/m	Limit dBuV/m	Margin dB	SA reading dBuV	Factor dB	Remark	ANT High cm	Turn Table deg
1	5650.00	60.38	68.20	-7.82	55.41	4.97	Peak	309	0
2	5850.00	66.79	122.20	-55.41	60.98	5.81	Peak	309	0
3	5855.00	62.68	110.80	-48.12	56.85	5.83	Peak	309	0
4	5875.00	62.01	105.20	-43.19	56.11	5.90	Peak	309	0
5	5925.00	61.43	68.20	-6.77	55.34	6.09	Peak	309	0
6	11650.00	53.60	54.00	-0.40	39.98	13.62	Average	167	191
7	11650.00	66.37	74.00	-7.63	52.75	13.62	Peak	167	191
8	17475.00	61.71	68.20	-6.49	43.81	17.90	Peak	100	208

Note 1: Emission Level (dBuV/m) = SA Reading (dBuV/m) + Factor* (dB)

*Factor includes antenna factor , cable loss and amplifier gain

Note 2: Margin (dB) = Emission level (dBuV/m) – Limit (dBuV/m).

3.5.6 Transmitter Radiated Unwanted Emissions (Above 1GHz) for VHT20

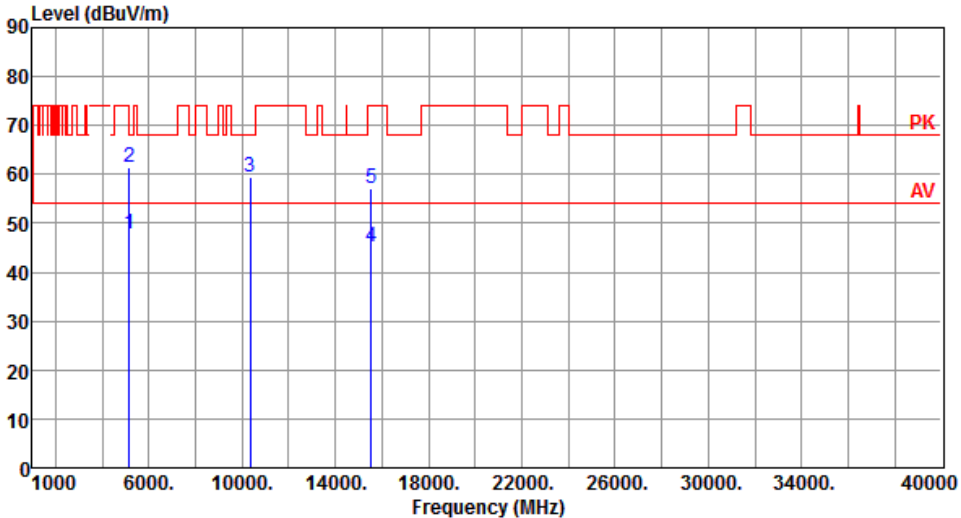
Modulation	VHT20	Test Freq. (MHz)	5180																																																																									
Polarization	Horizontal																																																																											
																																																																												
	<table border="1"> <thead> <tr> <th>Freq.</th> <th>Emission level</th> <th>Limit</th> <th>Margin</th> <th>SA reading</th> <th>Factor</th> <th>Remark</th> <th>ANT High</th> <th>Turn Table</th> </tr> <tr> <th>MHz</th> <th>dBuV/m</th> <th>dBuV/m</th> <th>dB</th> <th>dBuV</th> <th>dB</th> <th></th> <th>cm</th> <th>deg</th> </tr> </thead> <tbody> <tr> <td>1</td> <td>5150.00</td> <td>47.82</td> <td>54.00</td> <td>-6.18</td> <td>43.28</td> <td>4.54</td> <td>Average</td> <td>100</td> <td>57</td> </tr> <tr> <td>2</td> <td>5150.00</td> <td>61.41</td> <td>74.00</td> <td>-12.59</td> <td>56.87</td> <td>4.54</td> <td>Peak</td> <td>100</td> <td>57</td> </tr> <tr> <td>3</td> <td>10360.00</td> <td>59.30</td> <td>68.20</td> <td>-8.90</td> <td>45.52</td> <td>13.78</td> <td>Peak</td> <td>152</td> <td>244</td> </tr> <tr> <td>4</td> <td>15540.00</td> <td>45.13</td> <td>54.00</td> <td>-8.87</td> <td>30.85</td> <td>14.28</td> <td>Average</td> <td>100</td> <td>22</td> </tr> <tr> <td>5</td> <td>15540.00</td> <td>57.14</td> <td>74.00</td> <td>-16.86</td> <td>42.86</td> <td>14.28</td> <td>Peak</td> <td>100</td> <td>22</td> </tr> </tbody> </table>	Freq.	Emission level	Limit	Margin	SA reading	Factor	Remark	ANT High	Turn Table	MHz	dBuV/m	dBuV/m	dB	dBuV	dB		cm	deg	1	5150.00	47.82	54.00	-6.18	43.28	4.54	Average	100	57	2	5150.00	61.41	74.00	-12.59	56.87	4.54	Peak	100	57	3	10360.00	59.30	68.20	-8.90	45.52	13.78	Peak	152	244	4	15540.00	45.13	54.00	-8.87	30.85	14.28	Average	100	22	5	15540.00	57.14	74.00	-16.86	42.86	14.28	Peak	100	22							
Freq.	Emission level	Limit	Margin	SA reading	Factor	Remark	ANT High	Turn Table																																																																				
MHz	dBuV/m	dBuV/m	dB	dBuV	dB		cm	deg																																																																				
1	5150.00	47.82	54.00	-6.18	43.28	4.54	Average	100	57																																																																			
2	5150.00	61.41	74.00	-12.59	56.87	4.54	Peak	100	57																																																																			
3	10360.00	59.30	68.20	-8.90	45.52	13.78	Peak	152	244																																																																			
4	15540.00	45.13	54.00	-8.87	30.85	14.28	Average	100	22																																																																			
5	15540.00	57.14	74.00	-16.86	42.86	14.28	Peak	100	22																																																																			
<p>Note 1: Emission Level (dBuV/m) = SA Reading (dBuV/m) + Factor* (dB) *Factor includes antenna factor , cable loss and amplifier gain Note 2: Margin (dB) = Emission level (dBuV/m) – Limit (dBuV/m).</p>																																																																												

Modulation	VHT20	Test Freq. (MHz)	5180
Polarization	Vertical		

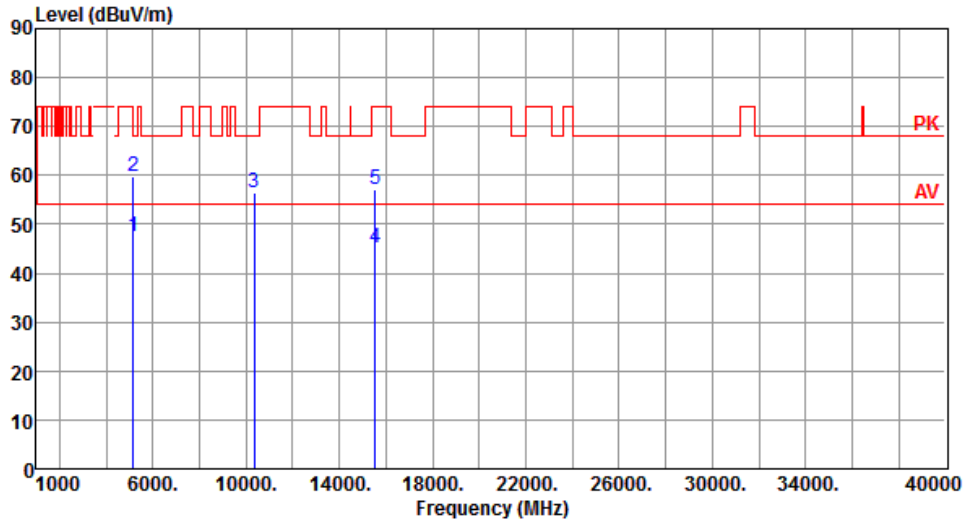

	Freq. MHz	Emission level dBuV/m	Limit dBuV/m	Margin dB	SA reading dBuV	Factor dB	Remark	ANT High cm	Turn Table deg
1	5150.00	47.38	54.00	-6.62	42.84	4.54	Average	335	359
2	5150.00	59.65	74.00	-14.35	55.11	4.54	Peak	335	359
3	10360.00	56.47	68.20	-11.73	42.69	13.78	Peak	133	182
4	15540.00	45.14	54.00	-8.86	30.86	14.28	Average	100	114
5	15540.00	57.14	74.00	-16.86	42.86	14.28	Peak	100	114

Note 1: Emission Level (dBuV/m) = SA Reading (dBuV/m) + Factor* (dB)

*Factor includes antenna factor , cable loss and amplifier gain

Note 2: Margin (dB) = Emission level (dBuV/m) – Limit (dBuV/m).

Modulation	VHT20	Test Freq. (MHz)	5200
Polarization	Horizontal		

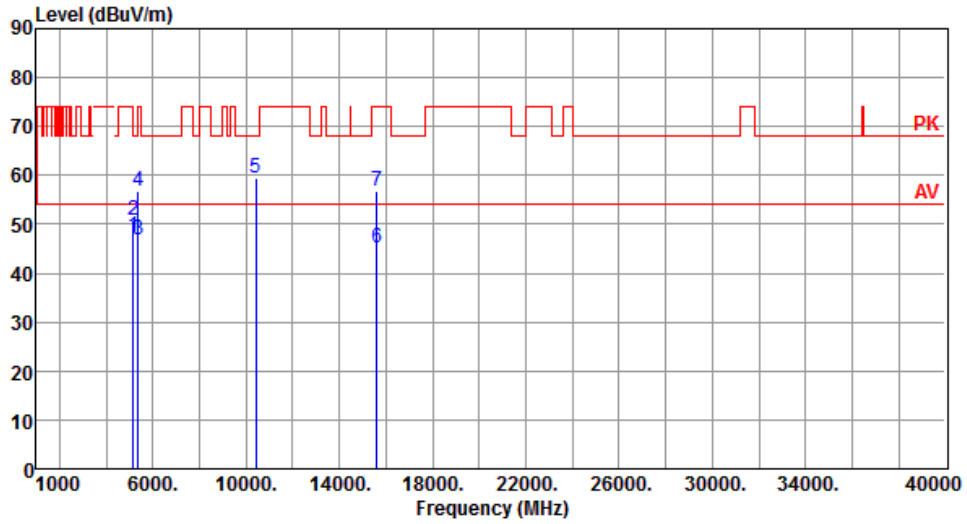

	Freq. MHz	Emission level dBuV/m	Limit dBuV/m	Margin dB	SA reading dBuV	Factor dB	Remark	ANT High cm	Turn Table deg
1	5150.00	47.40	54.00	-6.60	42.86	4.54	Average	100	47
2	5150.00	50.76	74.00	-23.24	46.22	4.54	Peak	100	47
3	5350.00	46.70	54.00	-7.30	42.57	4.13	Average	100	47
4	5350.00	56.70	74.00	-17.30	52.57	4.13	Peak	100	47
5	10400.00	59.31	68.20	-8.89	45.42	13.89	Peak	152	244
6	15600.00	45.30	54.00	-8.70	31.20	14.10	Average	100	22
7	15600.00	56.95	74.00	-17.05	42.85	14.10	Peak	100	22

Note 1: Emission Level (dBuV/m) = SA Reading (dBuV/m) + Factor* (dB)

*Factor includes antenna factor , cable loss and amplifier gain

Note 2: Margin (dB) = Emission level (dBuV/m) – Limit (dBuV/m).

Modulation	VHT20	Test Freq. (MHz)	5200
Polarization	Vertical		

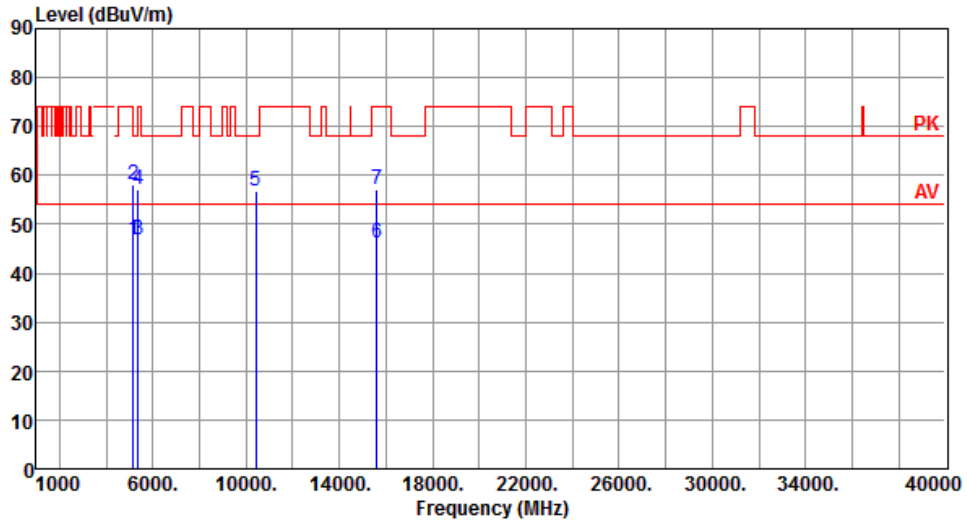

	Freq. MHz	Emission level dBuV/m	Limit dBuV/m	Margin dB	SA reading dBuV	Factor dB	Remark	ANT High cm	Turn Table deg
1	5150.00	46.91	54.00	-7.09	42.37	4.54	Average	321	351
2	5150.00	58.13	74.00	-15.87	53.59	4.54	Peak	321	351
3	5350.00	46.70	54.00	-7.30	42.57	4.13	Average	321	351
4	5350.00	57.06	74.00	-16.94	52.93	4.13	Peak	321	351
5	10400.00	56.74	68.20	-11.46	42.85	13.89	Peak	115	183
6	15600.00	46.10	54.00	-7.90	32.00	14.10	Average	122	186
7	15600.00	57.00	74.00	-17.00	42.90	14.10	Peak	122	186

Note 1: Emission Level (dBuV/m) = SA Reading (dBuV/m) + Factor* (dB)

*Factor includes antenna factor , cable loss and amplifier gain

Note 2: Margin (dB) = Emission level (dBuV/m) – Limit (dBuV/m).

Modulation	VHT20	Test Freq. (MHz)	5240
Polarization	Horizontal		

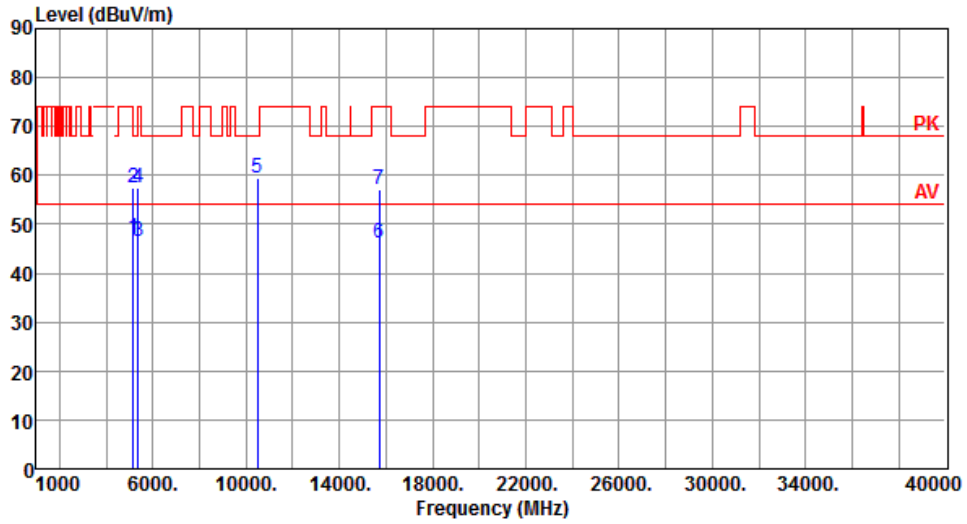

	Freq. MHz	Emission level dBuV/m	Limit dBuV/m	Margin dB	SA reading dBuV	Factor dB	Remark	ANT High cm	Turn Table deg
1	5150.00	47.09	54.00	-6.91	42.55	4.54	Average	100	52
2	5150.00	57.41	74.00	-16.59	52.87	4.54	Peak	100	52
3	5350.00	46.64	54.00	-7.36	42.51	4.13	Average	100	52
4	5350.00	57.36	74.00	-16.64	53.23	4.13	Peak	100	52
5	10480.00	59.31	68.20	-8.89	45.43	13.88	Peak	165	254
6	15720.00	46.14	54.00	-7.86	32.25	13.89	Average	100	36
7	15720.00	57.13	74.00	-16.87	43.24	13.89	Peak	100	36

Note 1: Emission Level (dBuV/m) = SA Reading (dBuV/m) + Factor* (dB)

*Factor includes antenna factor , cable loss and amplifier gain

Note 2: Margin (dB) = Emission level (dBuV/m) – Limit (dBuV/m).

Modulation	VHT20	Test Freq. (MHz)	5240
Polarization	Vertical		

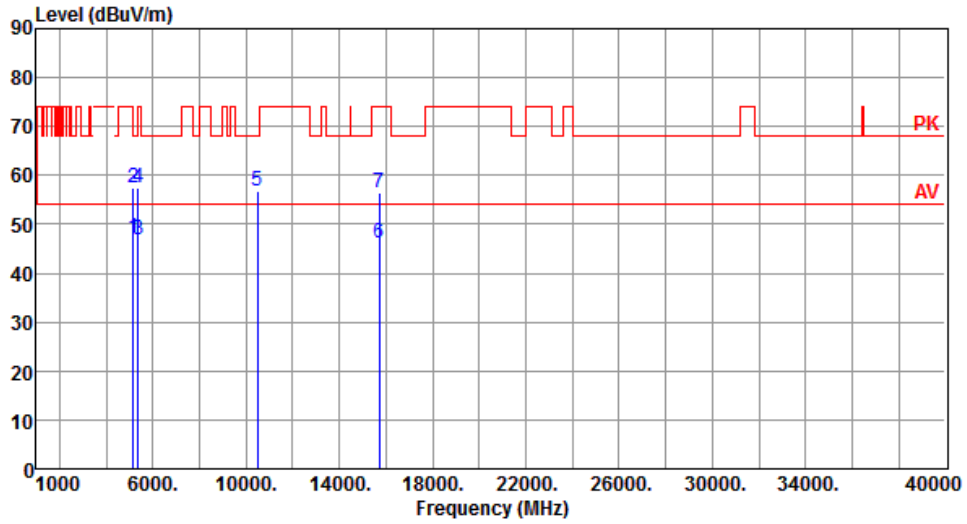

	Freq. MHz	Emission level dBuV/m	Limit dBuV/m	Margin dB	SA reading dBuV	Factor dB	Remark	ANT High cm	Turn Table deg
1	5150.00	47.06	54.00	-6.94	42.52	4.54	Average	325	3
2	5150.00	57.42	74.00	-16.58	52.88	4.54	Peak	325	3
3	5350.00	46.74	54.00	-7.26	42.61	4.13	Average	325	3
4	5350.00	57.37	74.00	-16.63	53.24	4.13	Peak	325	3
5	10480.00	56.72	68.20	-11.48	42.84	13.88	Peak	115	175
6	15720.00	46.00	54.00	-8.00	32.11	13.89	Average	100	182
7	15720.00	56.42	74.00	-17.58	42.53	13.89	Peak	100	182

Note 1: Emission Level (dBuV/m) = SA Reading (dBuV/m) + Factor* (dB)

*Factor includes antenna factor , cable loss and amplifier gain

Note 2: Margin (dB) = Emission level (dBuV/m) – Limit (dBuV/m).

Modulation	VHT20	Test Freq. (MHz)	5260
Polarization	Horizontal		

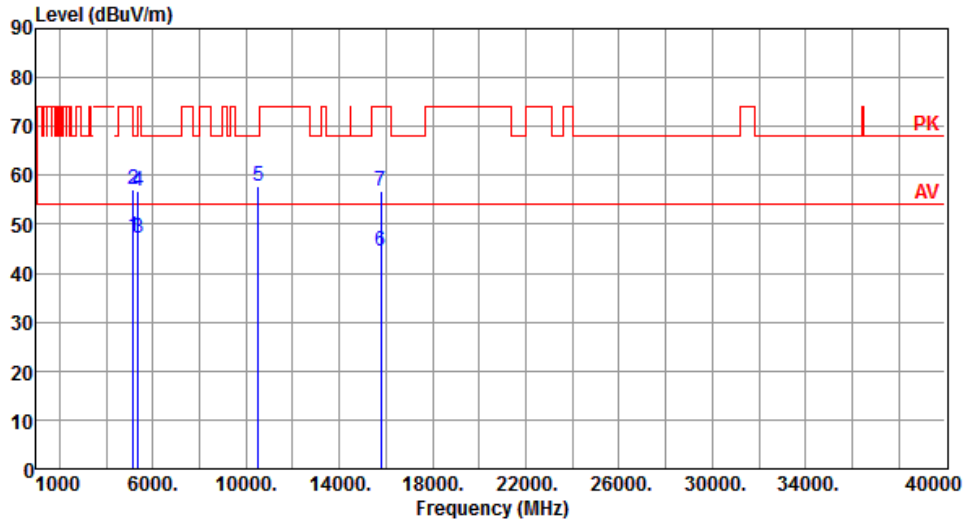

	Freq. MHz	Emission level dBuV/m	Limit dBuV/m	Margin dB	SA reading dBuV	Factor dB	Remark	ANT High cm	Turn Table deg
1	5150.00	47.45	54.00	-6.55	42.91	4.54	Average	100	52
2	5150.00	57.24	74.00	-16.76	52.70	4.54	Peak	100	52
3	5350.00	47.05	54.00	-6.95	42.92	4.13	Average	100	52
4	5350.00	56.77	74.00	-17.23	52.64	4.13	Peak	100	52
5	10520.00	57.82	68.20	-10.38	43.94	13.88	Peak	170	242
6	15780.00	44.49	54.00	-9.51	30.66	13.83	Average	100	63
7	15780.00	56.73	74.00	-17.27	42.90	13.83	Peak	100	63

Note 1: Emission Level (dBuV/m) = SA Reading (dBuV/m) + Factor* (dB)

*Factor includes antenna factor , cable loss and amplifier gain

Note 2: Margin (dB) = Emission level (dBuV/m) – Limit (dBuV/m).

Modulation	VHT20	Test Freq. (MHz)	5260
Polarization	Vertical		

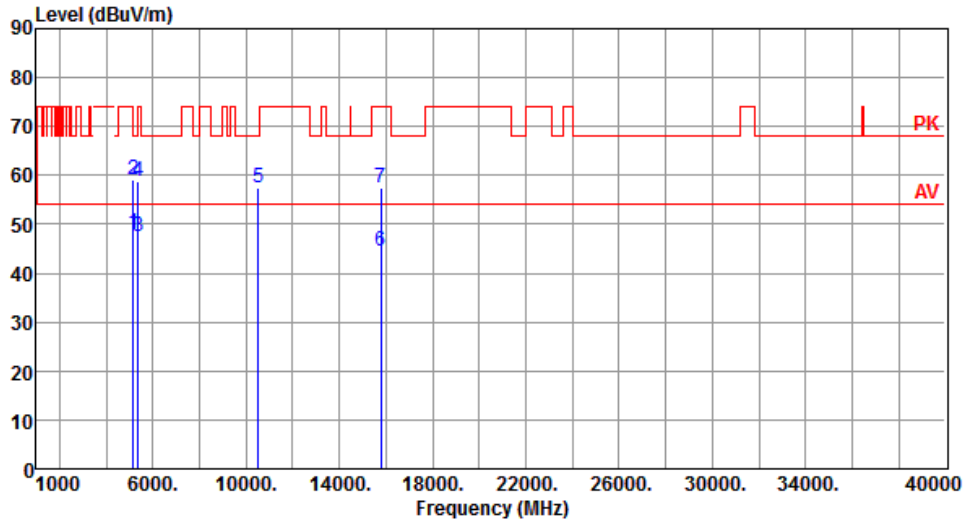

	Freq. MHz	Emission level dBuV/m	Limit dBuV/m	Margin dB	SA reading dBuV	Factor dB	Remark	ANT High cm	Turn Table deg
1	5150.00	48.20	54.00	-5.80	43.66	4.54	Average	362	352
2	5150.00	58.97	74.00	-15.03	54.43	4.54	Peak	362	352
3	5350.00	47.47	54.00	-6.53	43.34	4.13	Average	362	352
4	5350.00	58.87	74.00	-15.13	54.74	4.13	Peak	362	352
5	10520.00	57.42	68.20	-10.78	43.54	13.88	Peak	362	344
6	15780.00	44.52	54.00	-9.48	30.69	13.83	Average	100	142
7	15780.00	57.34	74.00	-16.66	43.51	13.83	Peak	100	142

Note 1: Emission Level (dBuV/m) = SA Reading (dBuV/m) + Factor* (dB)

*Factor includes antenna factor , cable loss and amplifier gain

Note 2: Margin (dB) = Emission level (dBuV/m) – Limit (dBuV/m).

Modulation	VHT20	Test Freq. (MHz)	5300
Polarization	Horizontal		

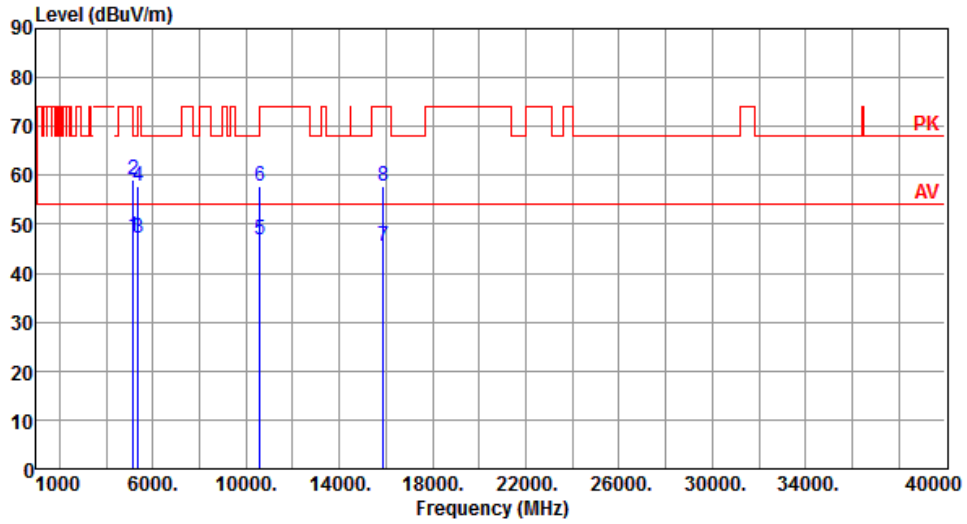

	Freq. MHz	Emission level dBuV/m	Limit dBuV/m	Margin dB	SA reading dBuV	Factor dB	Remark	ANT High cm	Turn Table deg
1	5150.00	47.48	54.00	-6.52	42.94	4.54	Average	100	59
2	5150.00	59.17	74.00	-14.83	54.63	4.54	Peak	100	59
3	5350.00	47.30	54.00	-6.70	43.17	4.13	Average	100	59
4	5350.00	57.66	74.00	-16.34	53.53	4.13	Peak	100	59
5	10600.00	46.80	54.00	-7.20	32.95	13.85	Average	162	252
6	10600.00	57.74	74.00	-16.26	43.89	13.85	Peak	162	252
7	15900.00	45.51	54.00	-8.49	31.69	13.82	Average	100	153
8	15900.00	57.78	74.00	-16.22	43.96	13.82	Peak	100	153

Note 1: Emission Level (dBuV/m) = SA Reading (dBuV/m) + Factor* (dB)

*Factor includes antenna factor , cable loss and amplifier gain

Note 2: Margin (dB) = Emission level (dBuV/m) – Limit (dBuV/m).

Modulation	VHT20	Test Freq. (MHz)	5300
Polarization	Vertical		

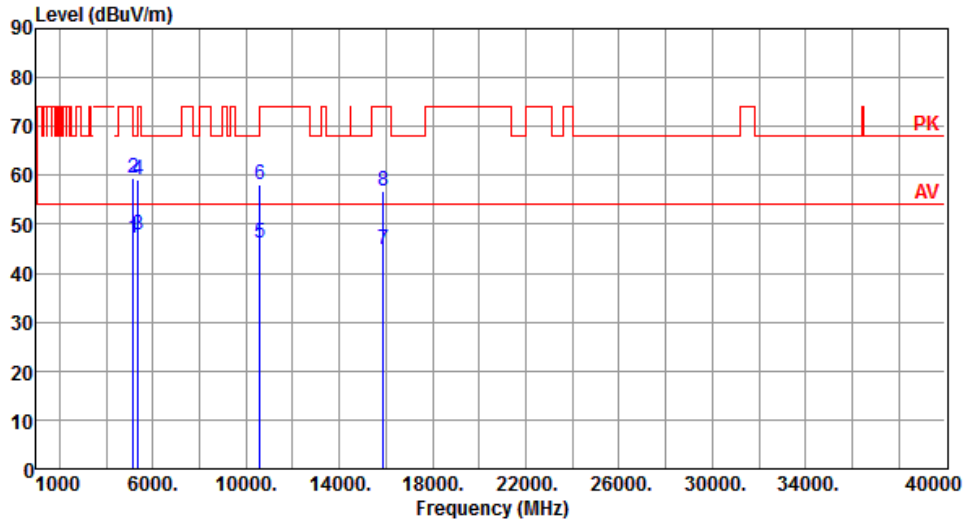

	Freq. MHz	Emission level dBuV/m	Limit dBuV/m	Margin dB	SA reading dBuV	Factor dB	Remark	ANT High cm	Turn Table deg
1	5150.00	47.30	54.00	-6.70	42.76	4.54	Average	352	3
2	5150.00	59.47	74.00	-14.53	54.93	4.54	Peak	352	3
3	5350.00	47.68	54.00	-6.32	43.55	4.13	Average	352	3
4	5350.00	59.08	74.00	-14.92	54.95	4.13	Peak	352	3
5	10600.00	46.20	54.00	-7.80	32.35	13.85	Average	111	184
6	10600.00	58.20	74.00	-15.80	44.35	13.85	Peak	111	184
7	15900.00	44.74	54.00	-9.26	30.92	13.82	Average	100	145
8	15900.00	56.81	74.00	-17.19	42.99	13.82	Peak	100	145

Note 1: Emission Level (dBuV/m) = SA Reading (dBuV/m) + Factor* (dB)

*Factor includes antenna factor , cable loss and amplifier gain

Note 2: Margin (dB) = Emission level (dBuV/m) – Limit (dBuV/m).

Modulation	VHT20	Test Freq. (MHz)	5320
Polarization	Horizontal		

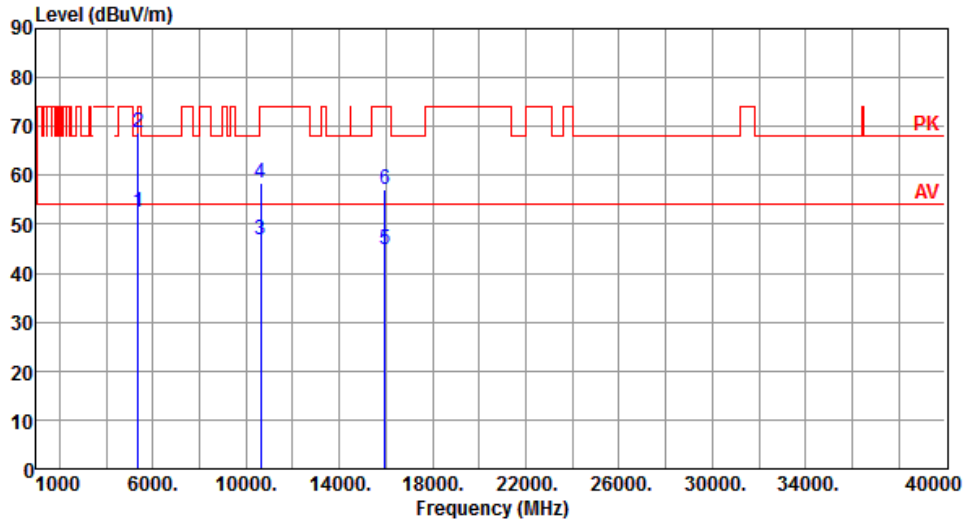

	Freq. MHz	Emission level dBuV/m	Limit dBuV/m	Margin dB	SA reading dBuV	Factor dB	Remark	ANT High cm	Turn Table deg
1	5350.00	52.47	54.00	-1.53	48.34	4.13	Average	100	56
2	5350.00	68.75	74.00	-5.25	64.62	4.13	Peak	100	56
3	10640.00	46.76	54.00	-7.24	32.91	13.85	Average	161	244
4	10640.00	58.46	74.00	-15.54	44.61	13.85	Peak	161	244
5	15960.00	44.71	54.00	-9.29	30.95	13.76	Average	100	58
6	15960.00	57.01	74.00	-16.99	43.25	13.76	Peak	100	58

Note 1: Emission Level (dBuV/m) = SA Reading (dBuV/m) + Factor* (dB)

*Factor includes antenna factor , cable loss and amplifier gain

Note 2: Margin (dB) = Emission level (dBuV/m) – Limit (dBuV/m).

Modulation	VHT20	Test Freq. (MHz)	5320
Polarization	Vertical		

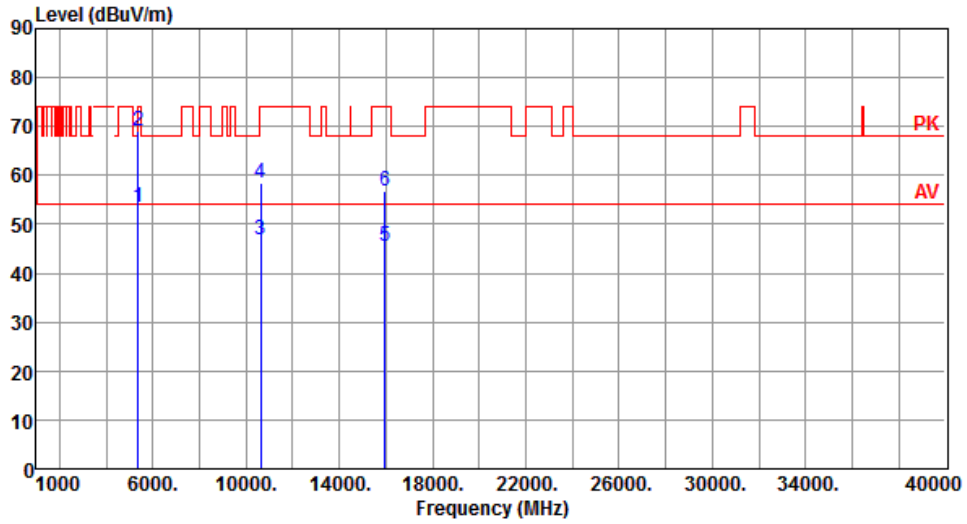

	Freq. MHz	Emission level dBuV/m	Limit dBuV/m	Margin dB	SA reading dBuV	Factor dB	Remark	ANT High cm	Turn Table deg
1	5350.00	53.37	54.00	-0.63	49.24	4.13	Average	352	359
2	5350.00	69.07	74.00	-4.93	64.94	4.13	Peak	352	359
3	10640.00	46.68	54.00	-7.32	32.83	13.85	Average	110	177
4	10640.00	58.46	74.00	-15.54	44.61	13.85	Peak	110	177
5	15960.00	45.60	54.00	-8.40	31.84	13.76	Average	100	156
6	15960.00	56.71	74.00	-17.29	42.95	13.76	Peak	100	156

Note 1: Emission Level (dBuV/m) = SA Reading (dBuV/m) + Factor* (dB)

*Factor includes antenna factor , cable loss and amplifier gain

Note 2: Margin (dB) = Emission level (dBuV/m) – Limit (dBuV/m).

Modulation	VHT20	Test Freq. (MHz)	5500
Polarization	Horizontal		

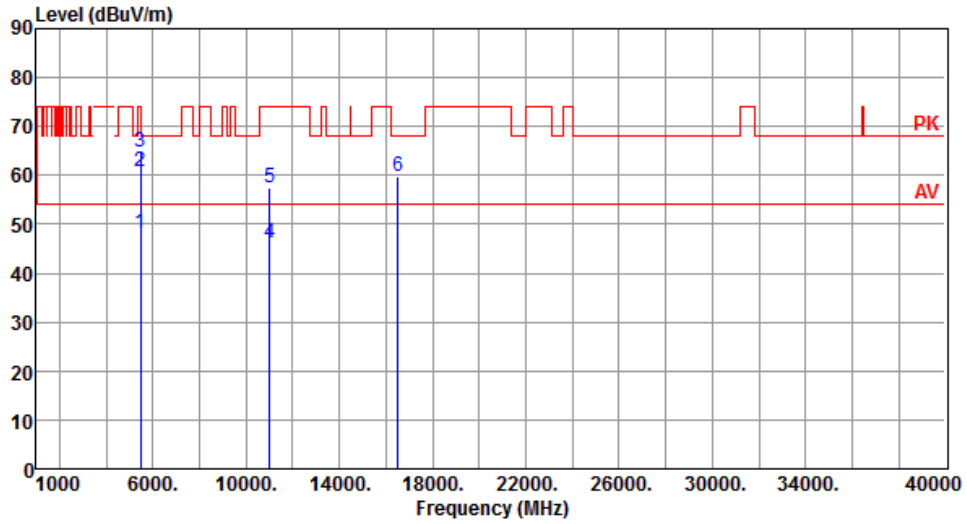

	Freq. MHz	Emission level dBuV/m	Limit dBuV/m	Margin dB	SA reading dBuV	Factor dB	Remark	ANT High cm	Turn Table deg
1	5460.00	48.21	54.00	-5.79	43.57	4.64	Average	100	39
2	5460.00	60.65	74.00	-13.35	56.01	4.64	Peak	100	39
3	5470.00	64.79	68.20	-3.41	60.14	4.65	Peak	100	39
4	11000.00	46.09	54.00	-7.91	31.84	14.25	Average	100	101
5	11000.00	57.50	74.00	-16.50	43.25	14.25	Peak	100	101
6	16500.00	59.83	68.20	-8.37	44.10	15.73	Peak	100	2

Note 1: Emission Level (dBuV/m) = SA Reading (dBuV/m) + Factor* (dB)

*Factor includes antenna factor , cable loss and amplifier gain

Note 2: Margin (dB) = Emission level (dBuV/m) – Limit (dBuV/m).

Modulation	VHT20	Test Freq. (MHz)	5500
Polarization	Vertical		

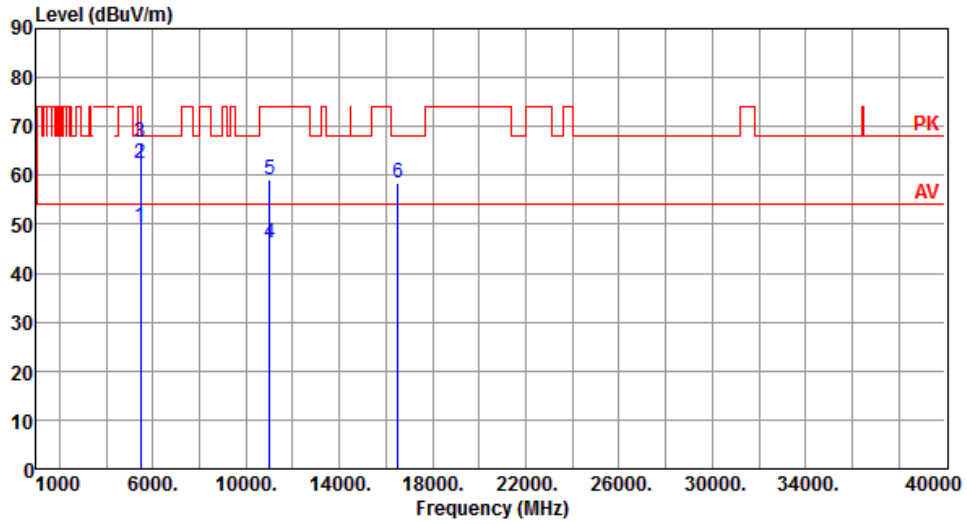

	Freq. MHz	Emission level dBuV/m	Limit dBuV/m	Margin dB	SA reading dBuV	Factor dB	Remark	ANT High cm	Turn Table deg
1	5460.00	49.64	54.00	-4.36	45.00	4.64	Average	329	17
2	5460.00	62.56	74.00	-11.44	57.92	4.64	Peak	329	17
3	5470.00	66.73	68.20	-1.47	62.08	4.65	Peak	329	17
4	11000.00	46.17	54.00	-7.83	31.92	14.25	Average	178	204
5	11000.00	59.14	74.00	-14.86	44.89	14.25	Peak	178	204
6	16500.00	58.53	68.20	-9.67	42.80	15.73	Peak	100	145

Note 1: Emission Level (dBuV/m) = SA Reading (dBuV/m) + Factor* (dB)

*Factor includes antenna factor , cable loss and amplifier gain

Note 2: Margin (dB) = Emission level (dBuV/m) – Limit (dBuV/m).

Modulation	VHT20	Test Freq. (MHz)	5580
Polarization	Horizontal		

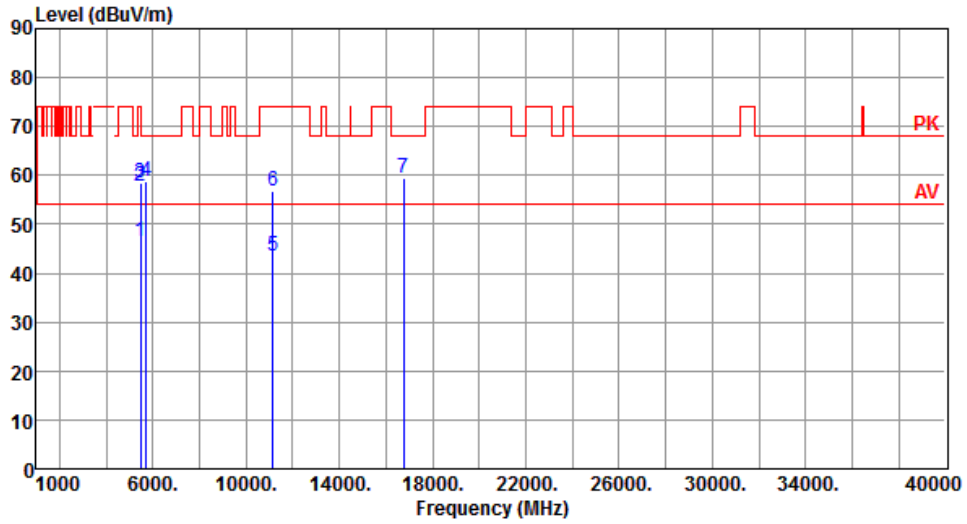

	Freq. MHz	Emission level dBuV/m	Limit dBuV/m	Margin dB	SA reading dBuV	Factor dB	Remark	ANT High cm	Turn Table deg
1	5460.00	46.48	54.00	-7.52	41.84	4.64	Average	100	48
2	5460.00	57.88	74.00	-16.12	53.24	4.64	Peak	100	48
3	5470.00	58.52	68.20	-9.68	53.87	4.65	Peak	100	48
4	5725.00	58.83	68.20	-9.37	53.58	5.25	Peak	100	48
5	11160.00	43.53	54.00	-10.47	29.64	13.89	Average	100	107
6	11160.00	56.73	74.00	-17.27	42.84	13.89	Peak	100	107
7	16740.00	59.44	68.20	-8.76	42.36	17.08	Peak	100	5

Note 1: Emission Level (dBuV/m) = SA Reading (dBuV/m) + Factor* (dB)

*Factor includes antenna factor , cable loss and amplifier gain

Note 2: Margin (dB) = Emission level (dBuV/m) – Limit (dBuV/m).

Modulation	VHT20	Test Freq. (MHz)	5580
Polarization	Vertical		

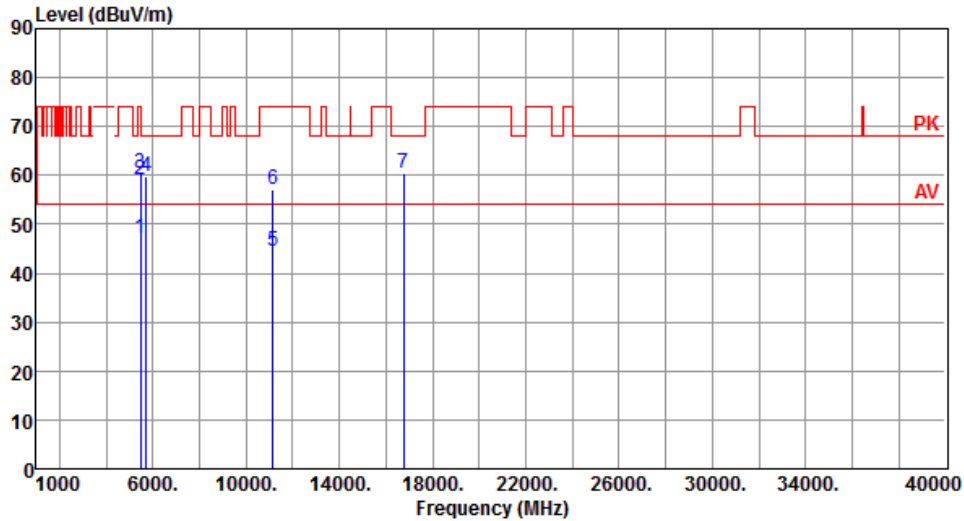

	Freq. MHz	Emission level dBuV/m	Limit dBuV/m	Margin dB	SA reading dBuV	Factor dB	Remark	ANT High cm	Turn Table deg
1	5460.00	47.05	54.00	-6.95	42.41	4.64	Average	349	359
2	5460.00	59.00	74.00	-15.00	54.36	4.64	Peak	349	359
3	5470.00	60.33	68.20	-7.87	55.68	4.65	Peak	349	359
4	5725.00	59.94	68.20	-8.26	54.69	5.25	Peak	349	359
5	11160.00	44.41	54.00	-9.59	30.52	13.89	Average	136	209
6	11160.00	57.17	74.00	-16.83	43.28	13.89	Peak	136	209
7	16740.00	60.36	68.20	-7.84	43.28	17.08	Peak	100	149

Note 1: Emission Level (dBuV/m) = SA Reading (dBuV/m) + Factor* (dB)

*Factor includes antenna factor , cable loss and amplifier gain

Note 2: Margin (dB) = Emission level (dBuV/m) – Limit (dBuV/m).

Modulation	VHT20	Test Freq. (MHz)	5700
Polarization	Horizontal		

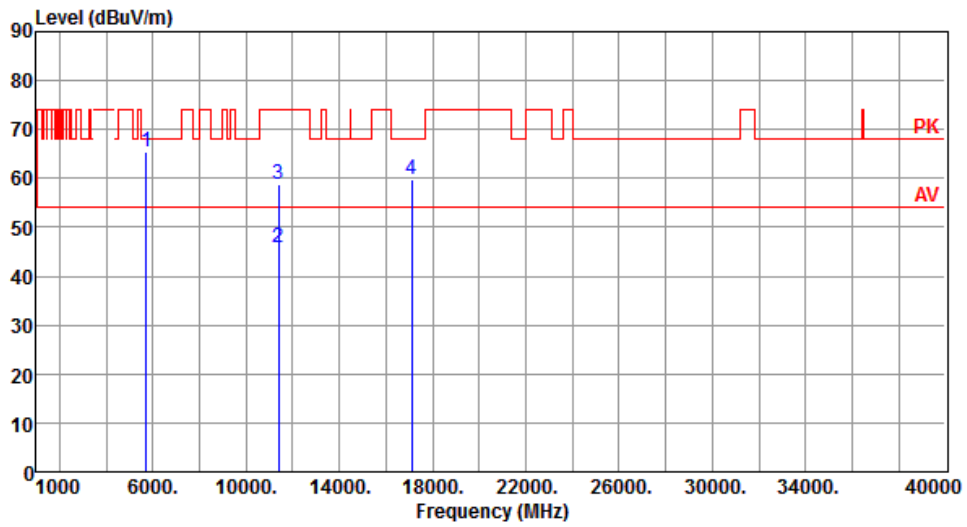

	Freq. MHz	Emission level dBuV/m	Limit dBuV/m	Margin dB	SA reading dBuV	Factor dB	Remark	ANT High cm	Turn Table deg
1	5725.00	65.46	68.20	-2.74	60.21	5.25	Peak	100	42
2	11400.00	46.00	54.00	-8.00	32.00	14.00	Average	100	99
3	11400.00	58.86	74.00	-15.14	44.86	14.00	Peak	100	99
4	17100.00	59.77	68.20	-8.43	42.84	16.93	Peak	100	5

Note 1: Emission Level (dBuV/m) = SA Reading (dBuV/m) + Factor* (dB)

*Factor includes antenna factor , cable loss and amplifier gain

Note 2: Margin (dB) = Emission level (dBuV/m) – Limit (dBuV/m).

Modulation	VHT20	Test Freq. (MHz)	5700
Polarization	Vertical		

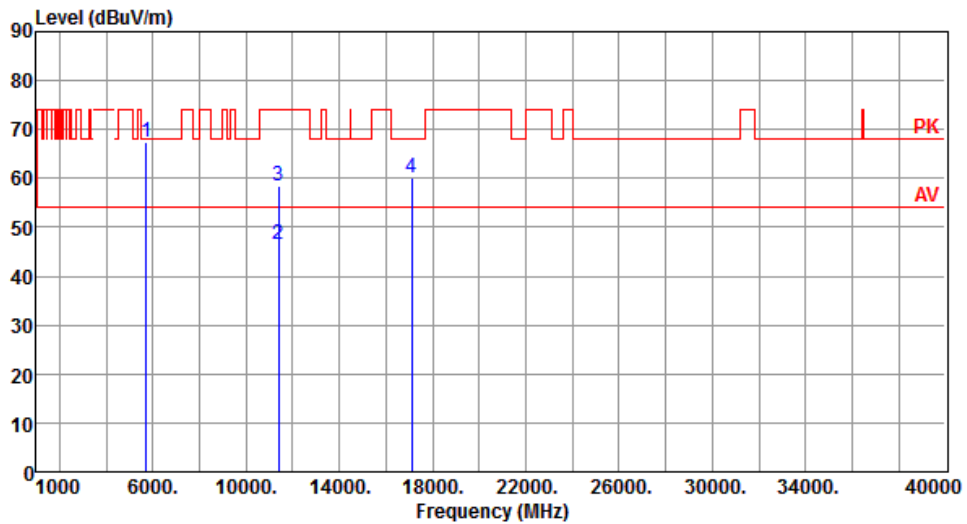

	Freq. MHz	Emission level dBuV/m	Limit dBuV/m	Margin dB	SA reading dBuV	Factor dB	Remark	ANT High cm	Turn Table deg
1	5725.00	67.48	68.20	-0.72	62.23	5.25	Peak	336	20
2	11400.00	46.54	54.00	-7.46	32.54	14.00	Average	234	198
3	11400.00	58.59	74.00	-15.41	44.59	14.00	Peak	234	198
4	17100.00	60.21	68.20	-7.99	43.28	16.93	Peak	100	150

Note 1: Emission Level (dBuV/m) = SA Reading (dBuV/m) + Factor* (dB)

*Factor includes antenna factor , cable loss and amplifier gain

Note 2: Margin (dB) = Emission level (dBuV/m) – Limit (dBuV/m).

Modulation	VHT20	Test Freq. (MHz)	5745
Polarization	Horizontal		

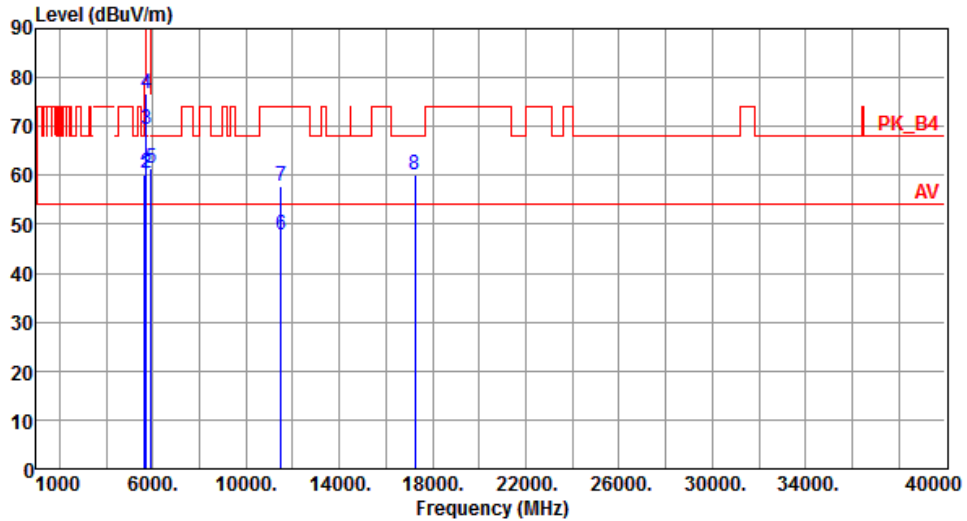

	Freq. MHz	Emission level dBuV/m	Limit dBuV/m	Margin dB	SA reading dBuV	Factor dB	Remark	ANT High cm	Turn Table deg
1	5650.00	60.11	68.20	-8.09	55.14	4.97	Peak	104	41
2	5700.00	60.57	105.20	-44.63	55.41	5.16	Peak	104	41
3	5720.00	69.48	110.80	-41.32	64.25	5.23	Peak	104	41
4	5725.00	76.80	122.20	-45.40	71.55	5.25	Peak	104	41
5	5925.00	61.51	68.20	-6.69	55.42	6.09	Peak	104	41
6	11490.00	47.67	54.00	-6.33	33.55	14.12	Average	325	144
7	11490.00	57.71	74.00	-16.29	43.59	14.12	Peak	325	144
8	17235.00	60.10	68.20	-8.10	42.87	17.23	Peak	100	57

Note 1: Emission Level (dBuV/m) = SA Reading (dBuV/m) + Factor* (dB)

*Factor includes antenna factor , cable loss and amplifier gain

Note 2: Margin (dB) = Emission level (dBuV/m) – Limit (dBuV/m).

Modulation	VHT20	Test Freq. (MHz)	5745
Polarization	Vertical		

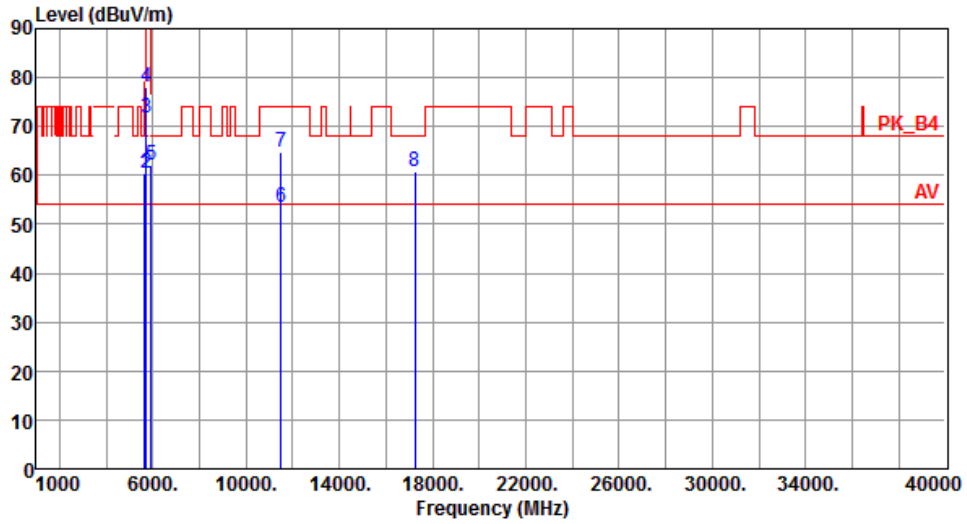

	Freq. MHz	Emission level dBuV/m	Limit dBuV/m	Margin dB	SA reading dBuV	Factor dB	Remark	ANT High cm	Turn Table deg
1	5650.00	60.61	68.20	-7.59	55.64	4.97	Peak	183	197
2	5700.00	60.57	105.20	-44.63	55.41	5.16	Peak	183	197
3	5720.00	71.81	110.80	-38.99	66.58	5.23	Peak	183	197
4	5725.00	77.89	122.20	-44.31	72.64	5.25	Peak	183	197
5	5925.00	62.03	68.20	-6.17	55.94	6.09	Peak	183	197
6	11490.00	53.58	54.00	-0.42	39.46	14.12	Average	183	197
7	11490.00	64.82	74.00	-9.18	50.70	14.12	Peak	183	197
8	17235.00	60.93	68.20	-7.27	43.70	17.23	Peak	100	203

Note 1: Emission Level (dBuV/m) = SA Reading (dBuV/m) + Factor* (dB)

*Factor includes antenna factor , cable loss and amplifier gain

Note 2: Margin (dB) = Emission level (dBuV/m) – Limit (dBuV/m).

Modulation	VHT20	Test Freq. (MHz)	5785
Polarization	Horizontal		

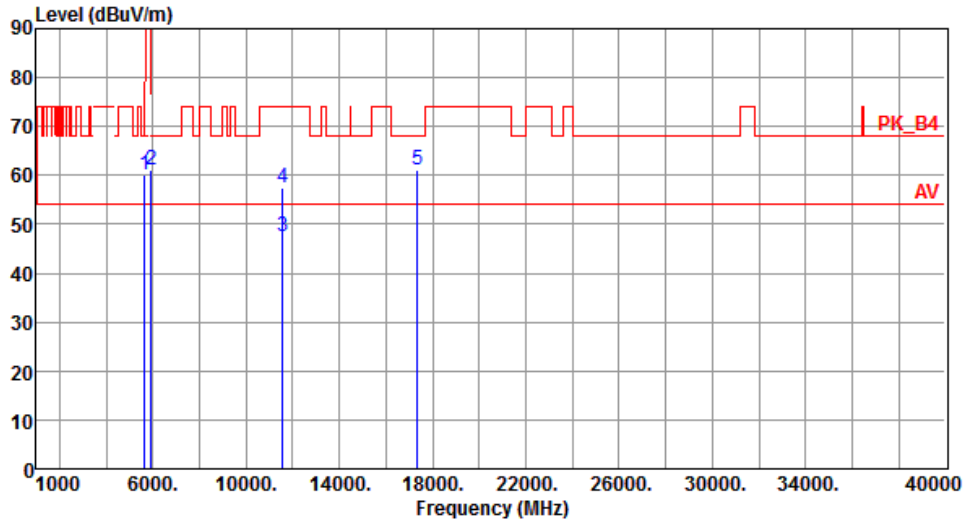

	Freq. MHz	Emission level dBuV/m	Limit dBuV/m	Margin dB	SA reading dBuV	Factor dB	Remark	ANT High cm	Turn Table deg
1	5650.00	60.14	68.20	-8.06	55.17	4.97	Peak	100	38
2	5925.00	61.21	68.20	-6.99	55.12	6.09	Peak	100	38
3	11570.00	47.37	54.00	-6.63	33.42	13.95	Average	335	135
4	11570.00	57.53	74.00	-16.47	43.58	13.95	Peak	335	135
5	17355.00	61.25	68.20	-6.95	43.63	17.62	Peak	100	53

Note 1: Emission Level (dBuV/m) = SA Reading (dBuV/m) + Factor* (dB)

*Factor includes antenna factor , cable loss and amplifier gain

Note 2: Margin (dB) = Emission level (dBuV/m) – Limit (dBuV/m).

Modulation	VHT20	Test Freq. (MHz)	5785
Polarization	Vertical		

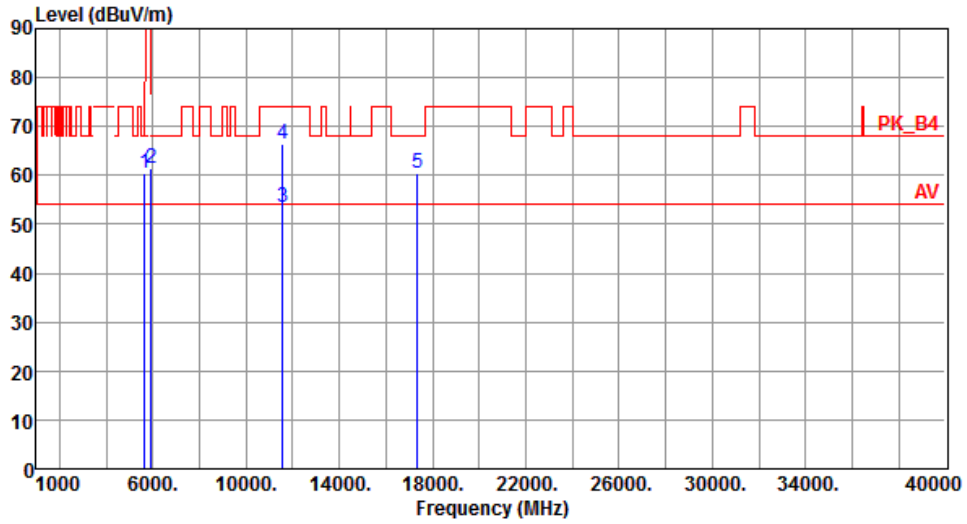

	Freq. MHz	Emission level dBuV/m	Limit dBuV/m	Margin dB	SA reading dBuV	Factor dB	Remark	ANT High cm	Turn Table deg
1	5650.00	60.51	68.20	-7.69	55.54	4.97	Peak	331	14
2	5925.00	61.44	68.20	-6.76	55.35	6.09	Peak	331	14
3	11570.00	53.59	54.00	-0.41	39.64	13.95	Average	194	201
4	11570.00	66.29	74.00	-7.71	52.34	13.95	Peak	194	201
5	17355.00	60.46	68.20	-7.74	42.84	17.62	Peak	100	25

Note 1: Emission Level (dBuV/m) = SA Reading (dBuV/m) + Factor* (dB)

*Factor includes antenna factor , cable loss and amplifier gain

Note 2: Margin (dB) = Emission level (dBuV/m) – Limit (dBuV/m).

Modulation	VHT20	Test Freq. (MHz)	5825
Polarization	Horizontal		

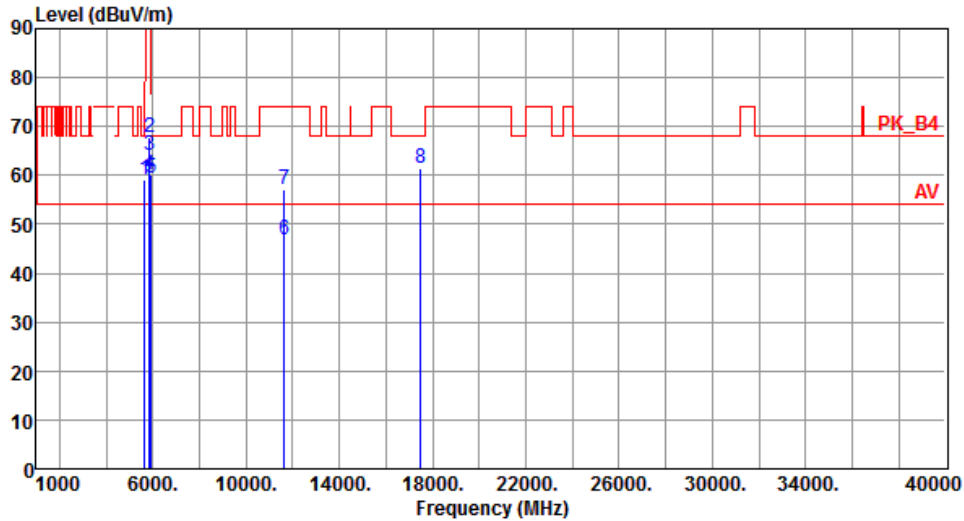

	Freq. MHz	Emission level dBuV/m	Limit dBuV/m	Margin dB	SA reading dBuV	Factor dB	Remark	ANT High cm	Turn Table deg
1	5650.00	59.25	68.20	-8.95	54.28	4.97	Peak	105	36
2	5850.00	67.70	122.20	-54.50	61.89	5.81	Peak	105	36
3	5855.00	64.07	110.80	-46.73	58.24	5.83	Peak	105	36
4	5875.00	60.19	105.20	-45.01	54.29	5.90	Peak	105	36
5	5925.00	59.34	68.20	-8.86	53.25	6.09	Peak	105	36
6	11650.00	46.88	54.00	-7.12	33.26	13.62	Average	326	138
7	11650.00	57.21	74.00	-16.79	43.59	13.62	Peak	326	138
8	17475.00	61.36	68.20	-6.84	43.46	17.90	Peak	100	58

Note 1: Emission Level (dBuV/m) = SA Reading (dBuV/m) + Factor* (dB)

*Factor includes antenna factor , cable loss and amplifier gain

Note 2: Margin (dB) = Emission level (dBuV/m) – Limit (dBuV/m).

Modulation	VHT20	Test Freq. (MHz)	5825
Polarization	Vertical		

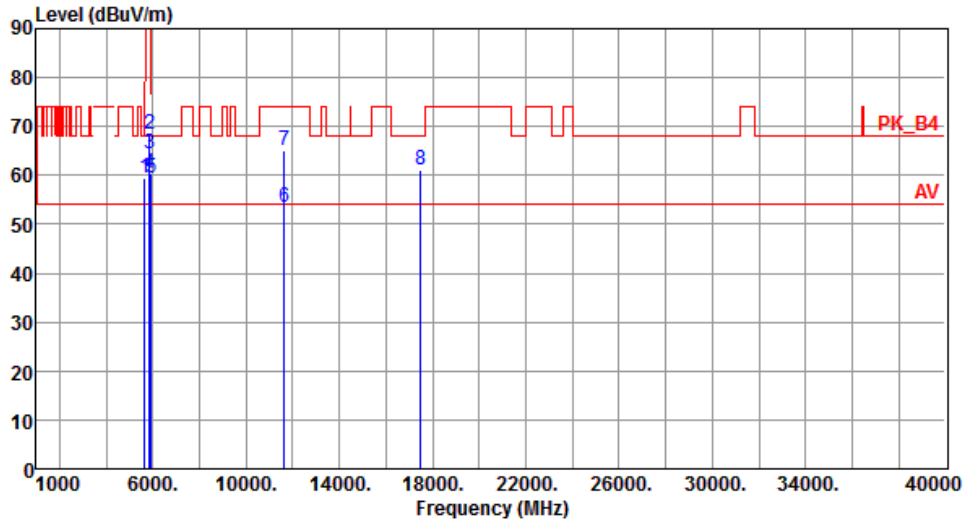

	Freq. MHz	Emission level dBuV/m	Limit dBuV/m	Margin dB	SA reading dBuV	Factor dB	Remark	ANT High cm	Turn Table deg
1	5650.00	59.46	68.20	-8.74	54.49	4.97	Peak	331	17
2	5850.00	68.57	122.20	-53.63	62.76	5.81	Peak	331	17
3	5855.00	64.55	110.80	-46.25	58.72	5.83	Peak	331	17
4	5875.00	60.56	105.20	-44.64	54.66	5.90	Peak	331	17
5	5925.00	59.52	68.20	-8.68	53.43	6.09	Peak	331	17
6	11650.00	53.48	54.00	-0.52	39.86	13.62	Average	183	193
7	11650.00	65.10	74.00	-8.90	51.48	13.62	Peak	183	193
8	17475.00	61.19	68.20	-7.01	43.29	17.90	Peak	100	203

Note 1: Emission Level (dBuV/m) = SA Reading (dBuV/m) + Factor* (dB)

*Factor includes antenna factor , cable loss and amplifier gain

Note 2: Margin (dB) = Emission level (dBuV/m) – Limit (dBuV/m).

3.5.7 Transmitter Radiated Unwanted Emissions (Above 1GHz) for VHT40

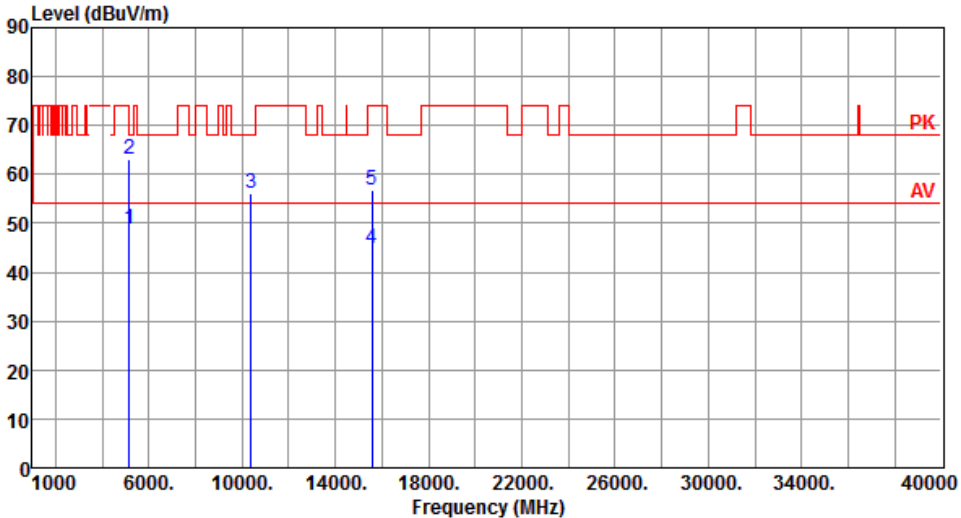
Modulation	VHT40	Test Freq. (MHz)	5190																																																																									
Polarization	Horizontal																																																																											
																																																																												
	<table border="1"> <thead> <tr> <th>Freq.</th> <th>Emission level</th> <th>Limit</th> <th>Margin</th> <th>SA reading</th> <th>Factor</th> <th>Remark</th> <th>ANT High</th> <th>Turn Table</th> </tr> <tr> <th>MHz</th> <th>dBuV/m</th> <th>dBuV/m</th> <th>dB</th> <th>dBuV</th> <th>dB</th> <th></th> <th>cm</th> <th>deg</th> </tr> </thead> <tbody> <tr> <td>1</td> <td>5150.00</td> <td>48.76</td> <td>54.00</td> <td>-5.24</td> <td>44.22</td> <td>4.54</td> <td>Average</td> <td>100</td> <td>51</td> </tr> <tr> <td>2</td> <td>5150.00</td> <td>63.06</td> <td>74.00</td> <td>-10.94</td> <td>58.52</td> <td>4.54</td> <td>Peak</td> <td>100</td> <td>51</td> </tr> <tr> <td>3</td> <td>10380.00</td> <td>56.20</td> <td>68.20</td> <td>-12.00</td> <td>42.36</td> <td>13.84</td> <td>Peak</td> <td>162</td> <td>243</td> </tr> <tr> <td>4</td> <td>15570.00</td> <td>44.71</td> <td>54.00</td> <td>-9.29</td> <td>30.52</td> <td>14.19</td> <td>Average</td> <td>100</td> <td>2</td> </tr> <tr> <td>5</td> <td>15570.00</td> <td>56.71</td> <td>74.00</td> <td>-17.29</td> <td>42.52</td> <td>14.19</td> <td>Peak</td> <td>100</td> <td>2</td> </tr> </tbody> </table>	Freq.	Emission level	Limit	Margin	SA reading	Factor	Remark	ANT High	Turn Table	MHz	dBuV/m	dBuV/m	dB	dBuV	dB		cm	deg	1	5150.00	48.76	54.00	-5.24	44.22	4.54	Average	100	51	2	5150.00	63.06	74.00	-10.94	58.52	4.54	Peak	100	51	3	10380.00	56.20	68.20	-12.00	42.36	13.84	Peak	162	243	4	15570.00	44.71	54.00	-9.29	30.52	14.19	Average	100	2	5	15570.00	56.71	74.00	-17.29	42.52	14.19	Peak	100	2							
Freq.	Emission level	Limit	Margin	SA reading	Factor	Remark	ANT High	Turn Table																																																																				
MHz	dBuV/m	dBuV/m	dB	dBuV	dB		cm	deg																																																																				
1	5150.00	48.76	54.00	-5.24	44.22	4.54	Average	100	51																																																																			
2	5150.00	63.06	74.00	-10.94	58.52	4.54	Peak	100	51																																																																			
3	10380.00	56.20	68.20	-12.00	42.36	13.84	Peak	162	243																																																																			
4	15570.00	44.71	54.00	-9.29	30.52	14.19	Average	100	2																																																																			
5	15570.00	56.71	74.00	-17.29	42.52	14.19	Peak	100	2																																																																			
<p>Note 1: Emission Level (dBuV/m) = SA Reading (dBuV/m) + Factor* (dB) *Factor includes antenna factor , cable loss and amplifier gain Note 2: Margin (dB) = Emission level (dBuV/m) – Limit (dBuV/m).</p>																																																																												

Modulation	VHT40	Test Freq. (MHz)	5190
Polarization	Vertical		

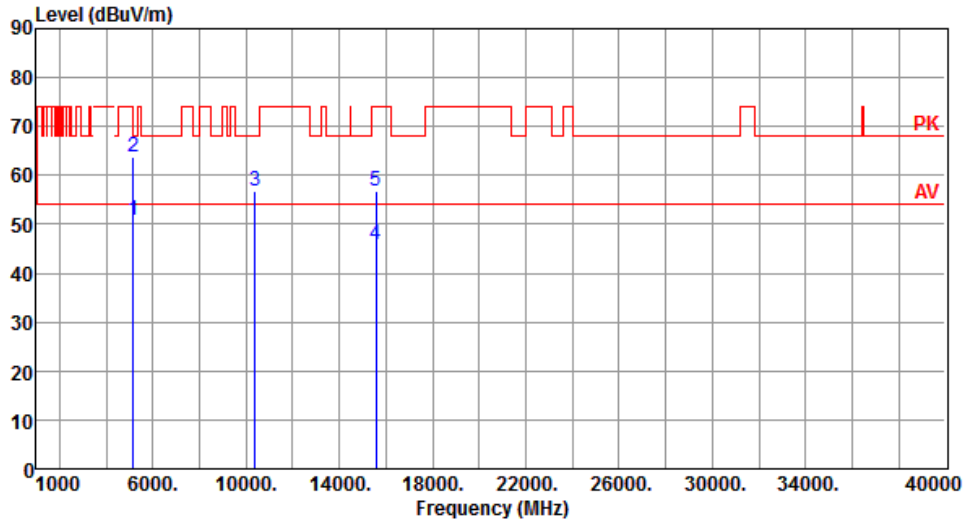

	Freq. MHz	Emission level dBuV/m	Limit dBuV/m	Margin dB	SA reading dBuV	Factor dB	Remark	ANT High cm	Turn Table deg
1	5150.00	50.76	54.00	-3.24	46.22	4.54	Average	332	7
2	5150.00	63.77	74.00	-10.23	59.23	4.54	Peak	332	7
3	10380.00	56.68	68.20	-11.52	42.84	13.84	Peak	100	185
4	15570.00	45.71	54.00	-8.29	31.52	14.19	Average	100	111
5	15570.00	56.93	74.00	-17.07	42.74	14.19	Peak	100	111

Note 1: Emission Level (dBuV/m) = SA Reading (dBuV/m) + Factor* (dB)

*Factor includes antenna factor , cable loss and amplifier gain

Note 2: Margin (dB) = Emission level (dBuV/m) – Limit (dBuV/m).

Modulation	VHT40	Test Freq. (MHz)	5230
Polarization	Horizontal		

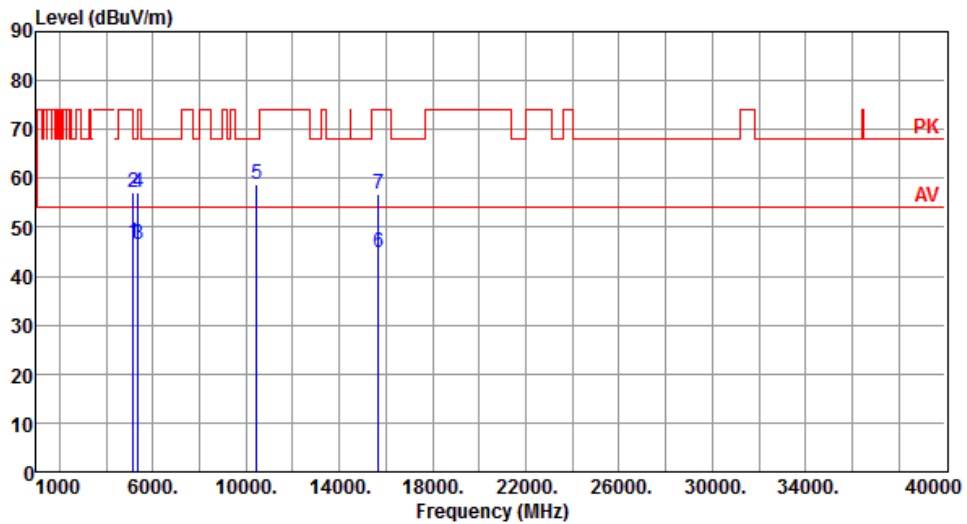

	Freq. MHz	Emission level dBuV/m	Limit dBuV/m	Margin dB	SA reading dBuV	Factor dB	Remark	ANT High cm	Turn Table deg
1	5150.00	46.80	54.00	-7.20	42.26	4.54	Average	162	241
2	5150.00	57.17	74.00	-16.83	52.63	4.54	Peak	162	241
3	5350.00	46.63	54.00	-7.37	42.50	4.13	Average	162	241
4	5350.00	56.96	74.00	-17.04	52.83	4.13	Peak	162	241
5	10460.00	58.77	68.20	-9.43	44.88	13.89	Peak	161	250
6	15690.00	44.78	54.00	-9.22	30.85	13.93	Average	100	2
7	15690.00	56.79	74.00	-17.21	42.86	13.93	Peak	100	2

Note 1: Emission Level (dBuV/m) = SA Reading (dBuV/m) + Factor* (dB)

*Factor includes antenna factor , cable loss and amplifier gain

Note 2: Margin (dB) = Emission level (dBuV/m) – Limit (dBuV/m).

Modulation	VHT40	Test Freq. (MHz)	5230
Polarization	Vertical		

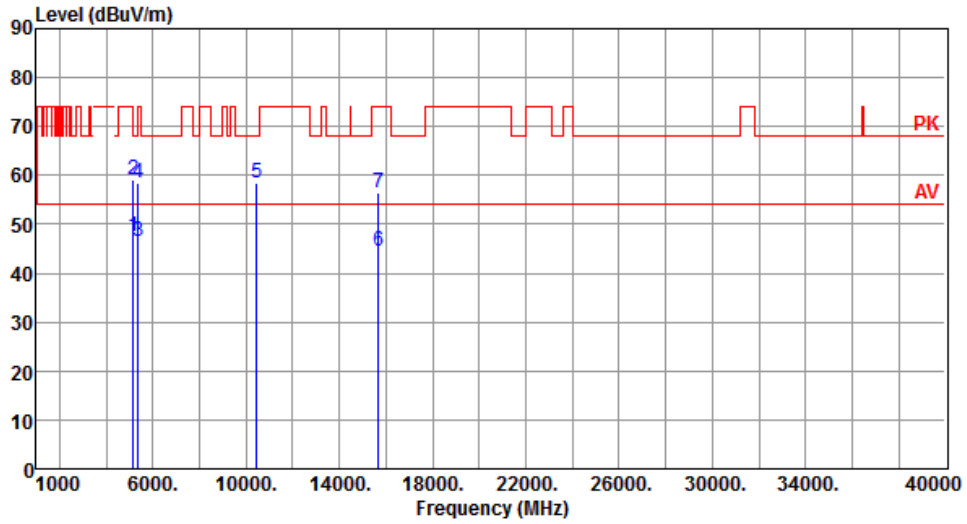

	Freq. MHz	Emission level dBuV/m	Limit dBuV/m	Margin dB	SA reading dBuV	Factor dB	Remark	ANT High cm	Turn Table deg
1	5150.00	47.39	54.00	-6.61	42.85	4.54	Average	346	3
2	5150.00	59.05	74.00	-14.95	54.51	4.54	Peak	346	3
3	5350.00	46.53	54.00	-7.47	42.40	4.13	Average	346	3
4	5350.00	58.33	74.00	-15.67	54.20	4.13	Peak	346	3
5	10460.00	58.39	68.20	-9.81	44.50	13.89	Peak	133	181
6	15690.00	44.43	54.00	-9.57	30.50	13.93	Average	100	178
7	15690.00	56.44	74.00	-17.56	42.51	13.93	Peak	100	178

Note 1: Emission Level (dBuV/m) = SA Reading (dBuV/m) + Factor* (dB)

*Factor includes antenna factor , cable loss and amplifier gain

Note 2: Margin (dB) = Emission level (dBuV/m) – Limit (dBuV/m).

Modulation	VHT40	Test Freq. (MHz)	5270
Polarization	Horizontal		

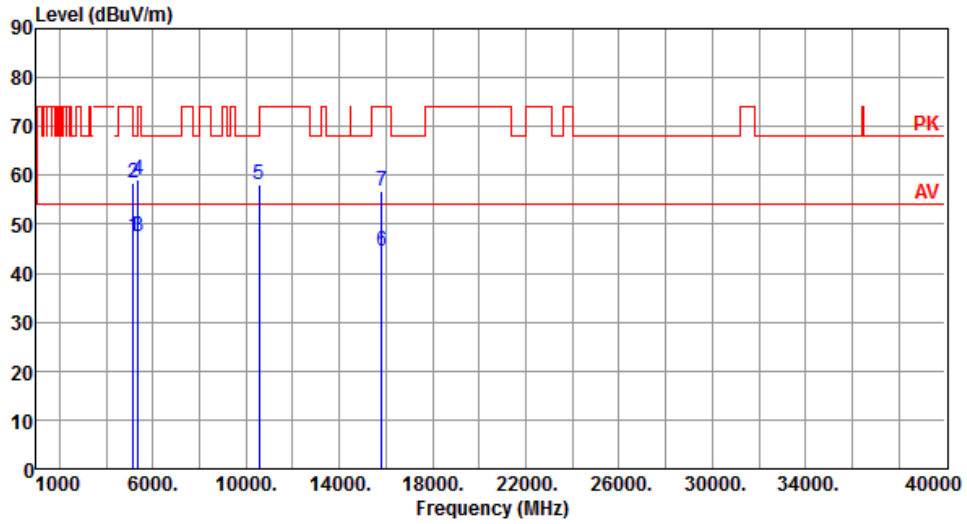

	Freq. MHz	Emission level dBuV/m	Limit dBuV/m	Margin dB	SA reading dBuV	Factor dB	Remark	ANT High cm	Turn Table deg
1	5150.00	47.47	54.00	-6.53	42.93	4.54	Average	100	54
2	5150.00	58.54	74.00	-15.46	54.00	4.54	Peak	100	54
3	5350.00	47.33	54.00	-6.67	43.20	4.13	Average	100	54
4	5350.00	59.05	74.00	-14.95	54.92	4.13	Peak	100	54
5	10540.00	58.12	68.20	-10.08	44.25	13.87	Peak	155	244
6	15810.00	44.43	54.00	-9.57	30.62	13.81	Average	100	62
7	15810.00	56.75	74.00	-17.25	42.94	13.81	Peak	100	62

Note 1: Emission Level (dBuV/m) = SA Reading (dBuV/m) + Factor* (dB)

*Factor includes antenna factor , cable loss and amplifier gain

Note 2: Margin (dB) = Emission level (dBuV/m) – Limit (dBuV/m).

Modulation	VHT40	Test Freq. (MHz)	5270
Polarization	Vertical		

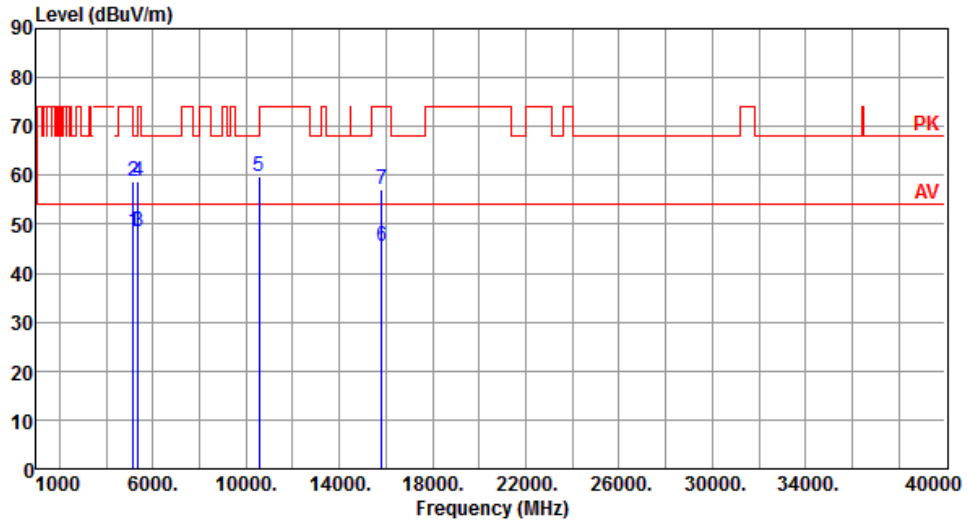

	Freq. MHz	Emission level dBuV/m	Limit dBuV/m	Margin dB	SA reading dBuV	Factor dB	Remark	ANT High cm	Turn Table deg
1	5150.00	48.40	54.00	-5.60	43.86	4.54	Average	339	3
2	5150.00	58.91	74.00	-15.09	54.37	4.54	Peak	339	3
3	5350.00	48.37	54.00	-5.63	44.24	4.13	Average	339	3
4	5350.00	58.70	74.00	-15.30	54.57	4.13	Peak	339	3
5	10540.00	59.79	68.20	-8.41	45.92	13.87	Peak	113	183
6	15810.00	45.39	54.00	-8.61	31.58	13.81	Average	100	152
7	15810.00	57.06	74.00	-16.94	43.25	13.81	Peak	100	152

Note 1: Emission Level (dBuV/m) = SA Reading (dBuV/m) + Factor* (dB)

*Factor includes antenna factor , cable loss and amplifier gain

Note 2: Margin (dB) = Emission level (dBuV/m) – Limit (dBuV/m).

Modulation	VHT40	Test Freq. (MHz)	5310
Polarization	Horizontal		

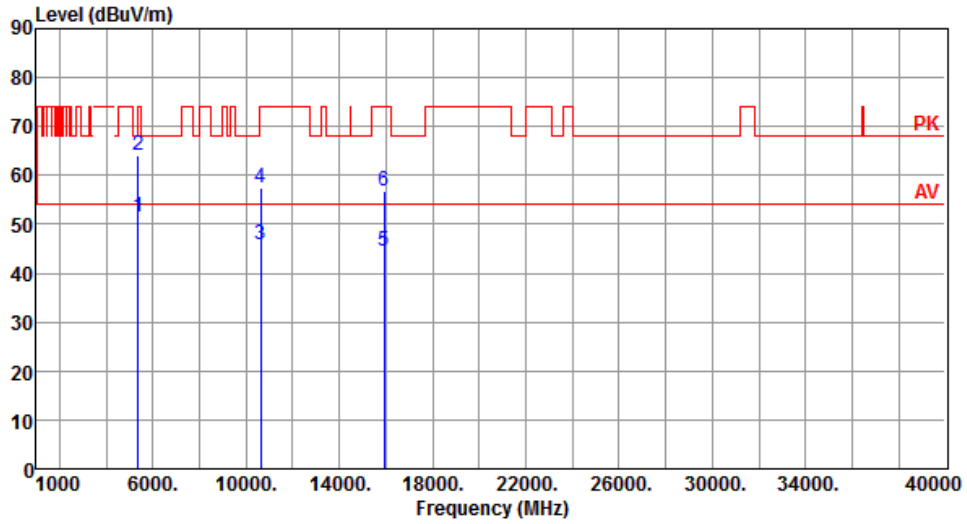

	Freq. MHz	Emission level dBuV/m	Limit dBuV/m	Margin dB	SA reading dBuV	Factor dB	Remark	ANT High cm	Turn Table deg
1	5350.00	51.63	54.00	-2.37	47.50	4.13	Average	100	53
2	5350.00	64.12	74.00	-9.88	59.99	4.13	Peak	100	53
3	10620.00	45.73	54.00	-8.27	31.88	13.85	Average	166	242
4	10620.00	57.42	74.00	-16.58	43.57	13.85	Peak	166	242
5	15930.00	44.36	54.00	-9.64	30.57	13.79	Average	100	53
6	15930.00	56.63	74.00	-17.37	42.84	13.79	Peak	100	53

Note 1: Emission Level (dBuV/m) = SA Reading (dBuV/m) + Factor* (dB)

*Factor includes antenna factor , cable loss and amplifier gain

Note 2: Margin (dB) = Emission level (dBuV/m) – Limit (dBuV/m).

Modulation	VHT40	Test Freq. (MHz)	5310
Polarization	Vertical		

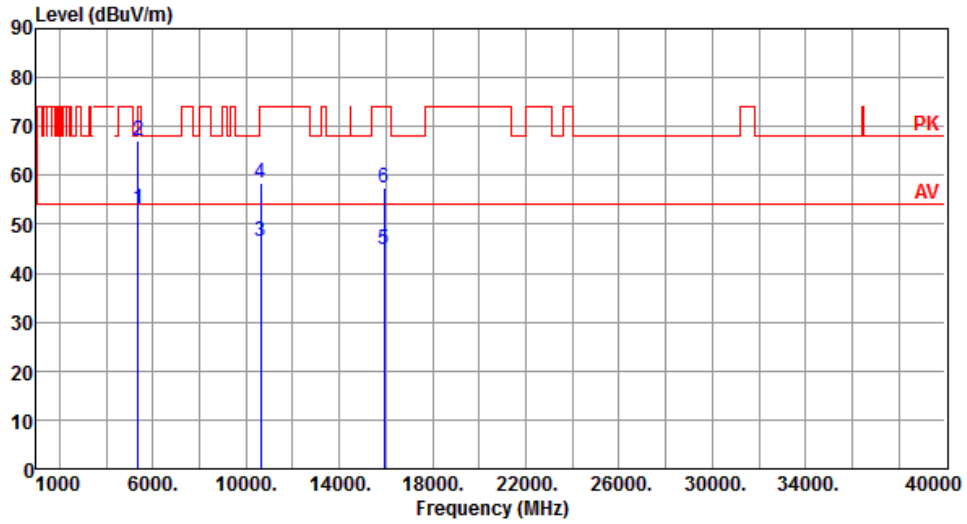

	Freq. MHz	Emission level dBuV/m	Limit dBuV/m	Margin dB	SA reading dBuV	Factor dB	Remark	ANT High cm	Turn Table deg
1	5350.00	53.13	54.00	-0.87	49.00	4.13	Average	361	359
2	5350.00	67.06	74.00	-6.94	62.93	4.13	Peak	361	359
3	10620.00	46.51	54.00	-7.49	32.66	13.85	Average	100	184
4	10620.00	58.49	74.00	-15.51	44.64	13.85	Peak	100	184
5	15930.00	44.89	54.00	-9.11	31.10	13.79	Average	100	142
6	15930.00	57.33	74.00	-16.67	43.54	13.79	Peak	100	142

Note 1: Emission Level (dBuV/m) = SA Reading (dBuV/m) + Factor* (dB)

*Factor includes antenna factor , cable loss and amplifier gain

Note 2: Margin (dB) = Emission level (dBuV/m) – Limit (dBuV/m).

Modulation	VHT40	Test Freq. (MHz)	5510
Polarization	Horizontal		

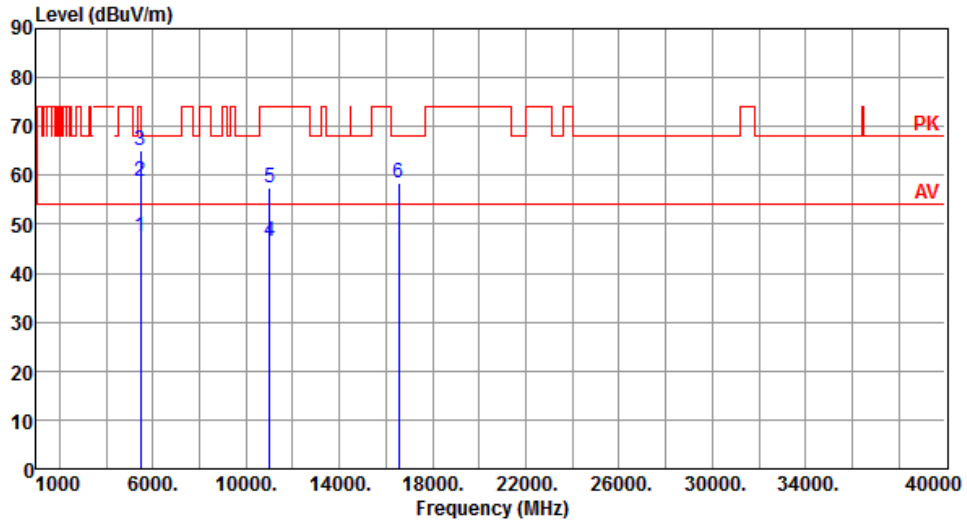

	Freq. MHz	Emission level dBuV/m	Limit dBuV/m	Margin dB	SA reading dBuV	Factor dB	Remark	ANT High cm	Turn Table deg
1	5460.00	47.51	54.00	-6.49	42.87	4.64	Average	100	45
2	5460.00	58.86	74.00	-15.14	54.22	4.64	Peak	100	45
3	5470.00	65.06	68.20	-3.14	60.41	4.65	Peak	100	45
4	11020.00	46.45	54.00	-7.55	32.25	14.20	Average	100	106
5	11020.00	57.40	74.00	-16.60	43.20	14.20	Peak	100	106
6	16530.00	58.35	68.20	-9.85	42.52	15.83	Peak	100	8

Note 1: Emission Level (dBuV/m) = SA Reading (dBuV/m) + Factor* (dB)

*Factor includes antenna factor , cable loss and amplifier gain

Note 2: Margin (dB) = Emission level (dBuV/m) – Limit (dBuV/m).

Modulation	VHT40	Test Freq. (MHz)	5510
Polarization	Vertical		

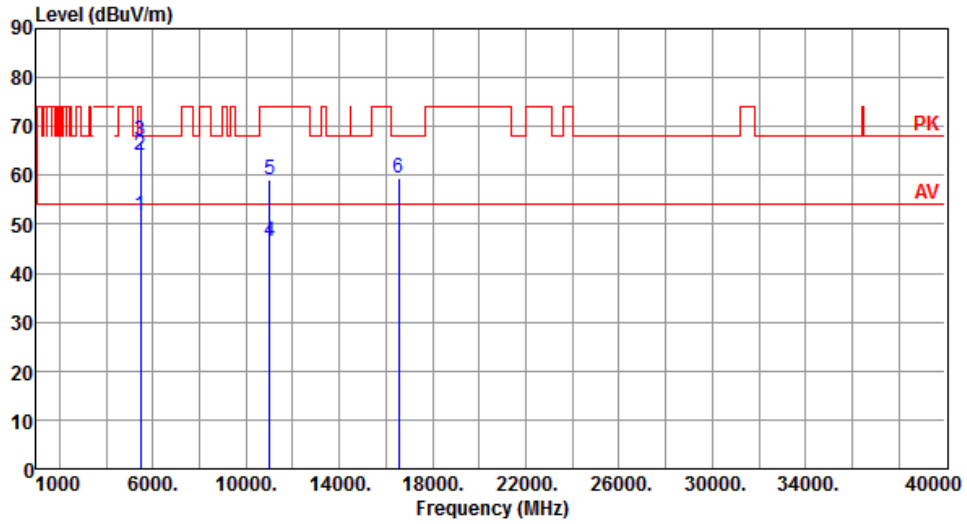

	Freq. MHz	Emission level dBuV/m	Limit dBuV/m	Margin dB	SA reading dBuV	Factor dB	Remark	ANT High cm	Turn Table deg
1	5460.00	51.95	54.00	-2.05	47.31	4.64	Average	363	18
2	5460.00	63.97	74.00	-10.03	59.33	4.64	Peak	363	18
3	5470.00	67.22	68.20	-0.98	62.57	4.65	Peak	363	18
4	11020.00	46.47	54.00	-7.53	32.27	14.20	Average	176	204
5	11020.00	59.06	74.00	-14.94	44.86	14.20	Peak	176	204
6	16530.00	59.29	68.20	-8.91	43.46	15.83	Peak	100	139

Note 1: Emission Level (dBuV/m) = SA Reading (dBuV/m) + Factor* (dB)

*Factor includes antenna factor , cable loss and amplifier gain

Note 2: Margin (dB) = Emission level (dBuV/m) – Limit (dBuV/m).

Modulation	VHT40	Test Freq. (MHz)	5550
Polarization	Horizontal		

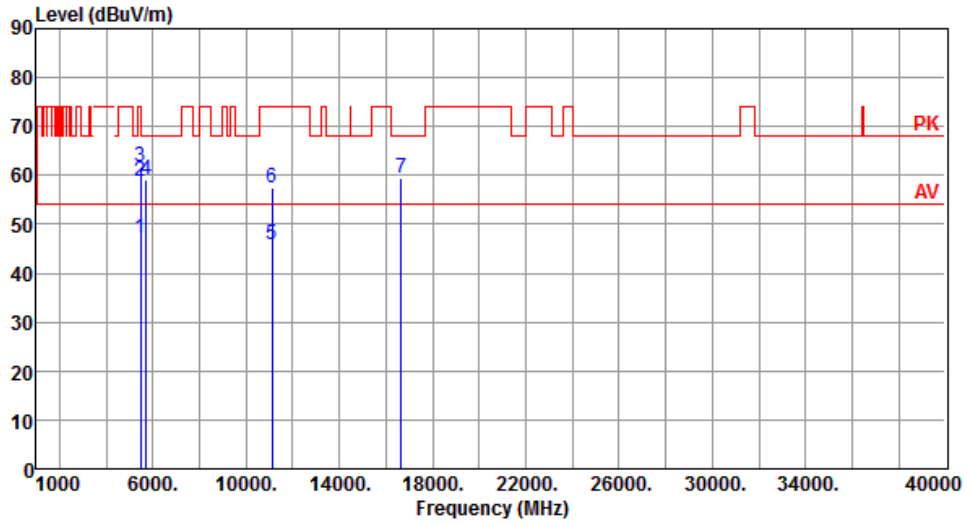

	Freq. MHz	Emission level dBuV/m	Limit dBuV/m	Margin dB	SA reading dBuV	Factor dB	Remark	ANT High cm	Turn Table deg
1	5460.00	47.15	54.00	-6.85	42.51	4.64	Average	100	47
2	5460.00	58.85	74.00	-15.15	54.21	4.64	Peak	100	47
3	5470.00	61.86	68.20	-6.34	57.21	4.65	Peak	100	47
4	5725.00	59.13	68.20	-9.07	53.88	5.25	Peak	100	47
5	11100.00	45.83	54.00	-8.17	31.84	13.99	Average	100	106
6	11100.00	57.58	74.00	-16.42	43.59	13.99	Peak	100	106
7	16650.00	59.38	68.20	-8.82	42.87	16.51	Peak	100	4

Note 1: Emission Level (dBuV/m) = SA Reading (dBuV/m) + Factor* (dB)

*Factor includes antenna factor , cable loss and amplifier gain

Note 2: Margin (dB) = Emission level (dBuV/m) – Limit (dBuV/m).

Modulation	VHT40	Test Freq. (MHz)	5550
Polarization	Vertical		

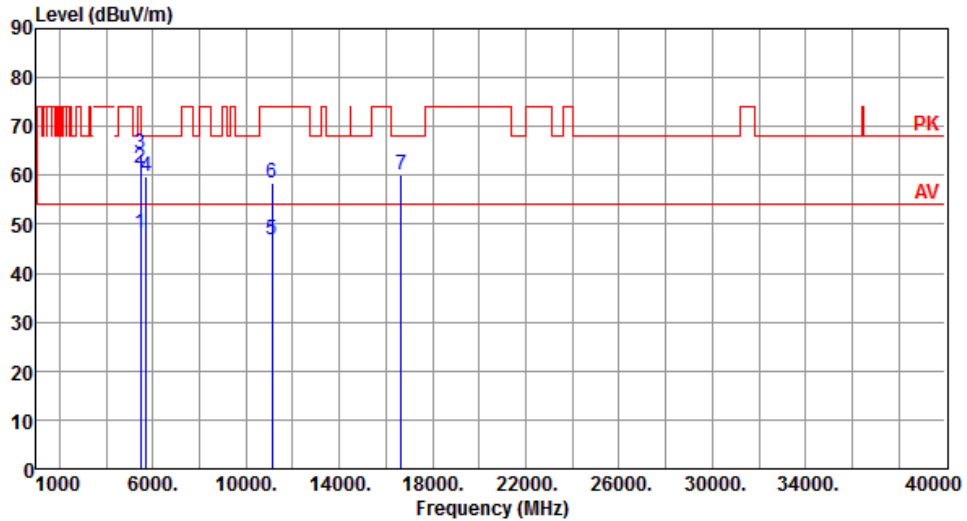

	Freq. MHz	Emission level dBuV/m	Limit dBuV/m	Margin dB	SA reading dBuV	Factor dB	Remark	ANT High cm	Turn Table deg
1	5460.00	48.01	54.00	-5.99	43.37	4.64	Average	349	17
2	5460.00	61.34	74.00	-12.66	56.70	4.64	Peak	349	17
3	5470.00	64.50	68.20	-3.70	59.85	4.65	Peak	349	17
4	5725.00	59.64	68.20	-8.56	54.39	5.25	Peak	349	17
5	11100.00	46.83	54.00	-7.17	32.84	13.99	Average	176	207
6	11100.00	58.41	74.00	-15.59	44.42	13.99	Peak	176	207
7	16650.00	60.09	68.20	-8.11	43.58	16.51	Peak	100	152

Note 1: Emission Level (dBuV/m) = SA Reading (dBuV/m) + Factor* (dB)

*Factor includes antenna factor , cable loss and amplifier gain

Note 2: Margin (dB) = Emission level (dBuV/m) – Limit (dBuV/m).

Modulation	VHT40	Test Freq. (MHz)	5670
Polarization	Horizontal		

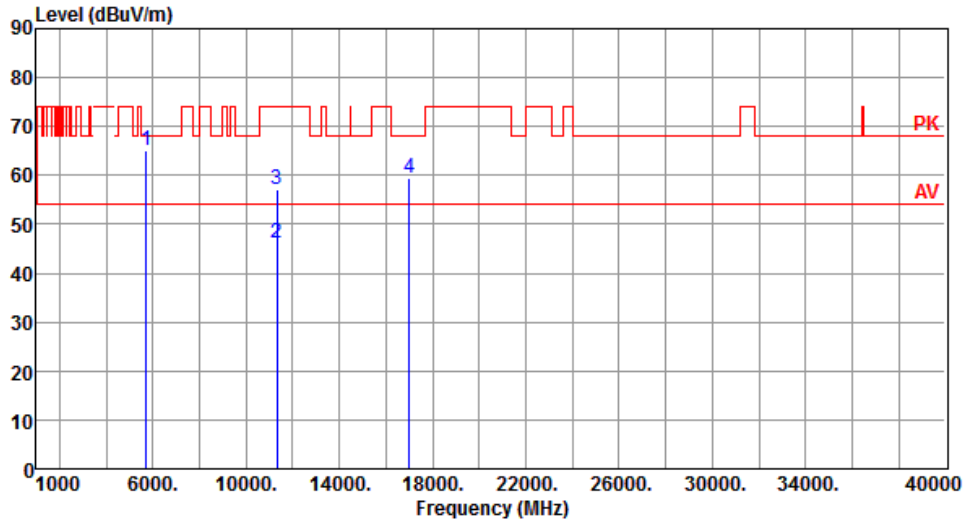

	Freq. MHz	Emission level dBuV/m	Limit dBuV/m	Margin dB	SA reading dBuV	Factor dB	Remark	ANT High cm	Turn Table deg
1	5725.00	65.23	68.20	-2.97	59.98	5.25	Peak	100	53
2	11340.00	46.07	54.00	-7.93	32.15	13.92	Average	100	95
3	11340.00	57.21	74.00	-16.79	43.29	13.92	Peak	100	95
4	17010.00	59.43	68.20	-8.77	42.17	17.26	Peak	100	2

Note 1: Emission Level (dBuV/m) = SA Reading (dBuV/m) + Factor* (dB)

*Factor includes antenna factor , cable loss and amplifier gain

Note 2: Margin (dB) = Emission level (dBuV/m) – Limit (dBuV/m).

Modulation	VHT40	Test Freq. (MHz)	5670
Polarization	Vertical		

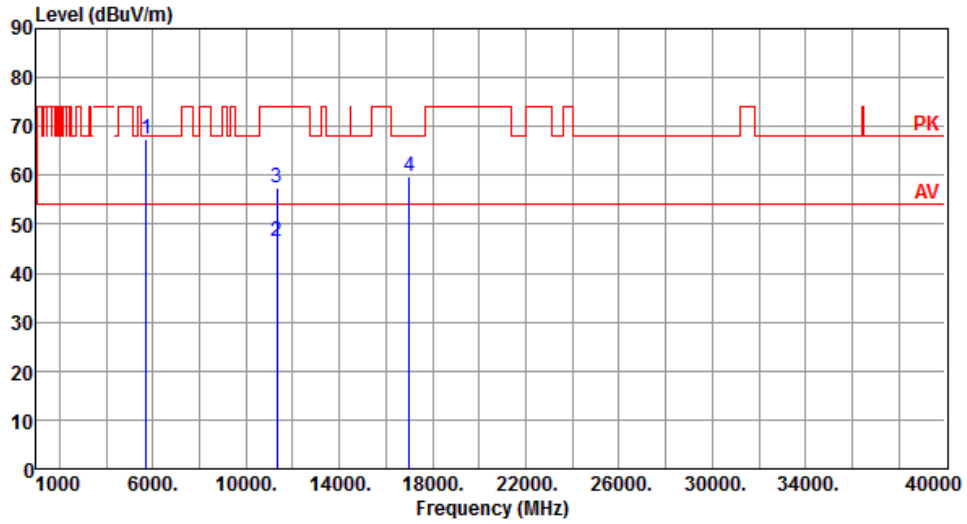

	Freq. MHz	Emission level dBuV/m	Limit dBuV/m	Margin dB	SA reading dBuV	Factor dB	Remark	ANT High cm	Turn Table deg
1	5725.00	67.39	68.20	-0.81	62.14	5.25	Peak	333	20
2	11340.00	46.56	54.00	-7.44	32.64	13.92	Average	270	196
3	11340.00	57.50	74.00	-16.50	43.58	13.92	Peak	270	196
4	17010.00	59.85	68.20	-8.35	42.59	17.26	Peak	100	149

Note 1: Emission Level (dBuV/m) = SA Reading (dBuV/m) + Factor* (dB)

*Factor includes antenna factor , cable loss and amplifier gain

Note 2: Margin (dB) = Emission level (dBuV/m) – Limit (dBuV/m).

Modulation	VHT40	Test Freq. (MHz)	5755
Polarization	Horizontal		

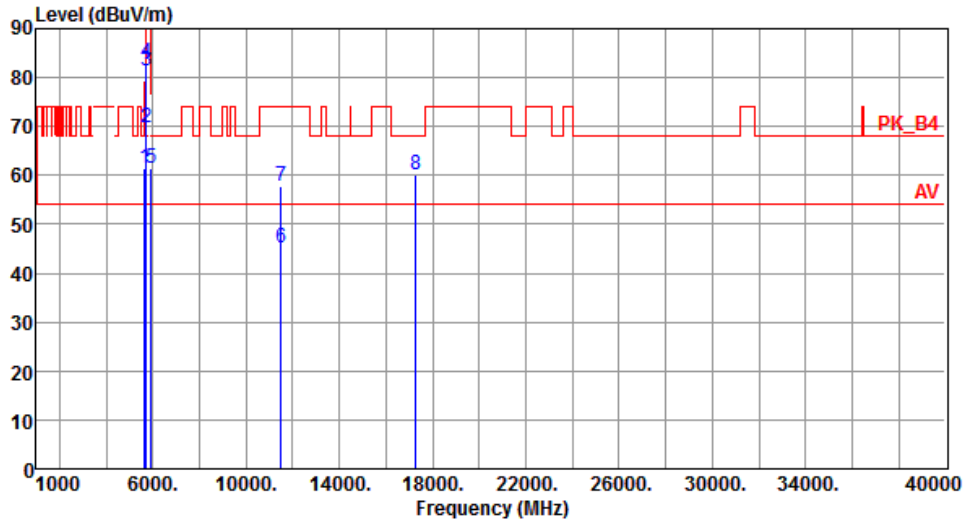

	Freq. MHz	Emission level dBuV/m	Limit dBuV/m	Margin dB	SA reading dBuV	Factor dB	Remark	ANT High cm	Turn Table deg
1	5650.00	61.51	68.20	-6.69	56.54	4.97	Peak	108	38
2	5700.00	69.67	105.20	-35.53	64.51	5.16	Peak	108	38
3	5720.00	81.30	110.80	-29.50	76.07	5.23	Peak	108	38
4	5725.00	82.90	122.20	-39.30	77.65	5.25	Peak	108	38
5	5925.00	61.54	68.20	-6.66	55.45	6.09	Peak	108	38
6	11510.00	45.00	54.00	-9.00	30.89	14.11	Average	100	146
7	11510.00	57.69	74.00	-16.31	43.58	14.11	Peak	100	146
8	17265.00	60.26	68.20	-7.94	42.95	17.31	Peak	100	49

Note 1: Emission Level (dBuV/m) = SA Reading (dBuV/m) + Factor* (dB)

*Factor includes antenna factor , cable loss and amplifier gain

Note 2: Margin (dB) = Emission level (dBuV/m) – Limit (dBuV/m).

Modulation	VHT40	Test Freq. (MHz)	5755
Polarization	Vertical		

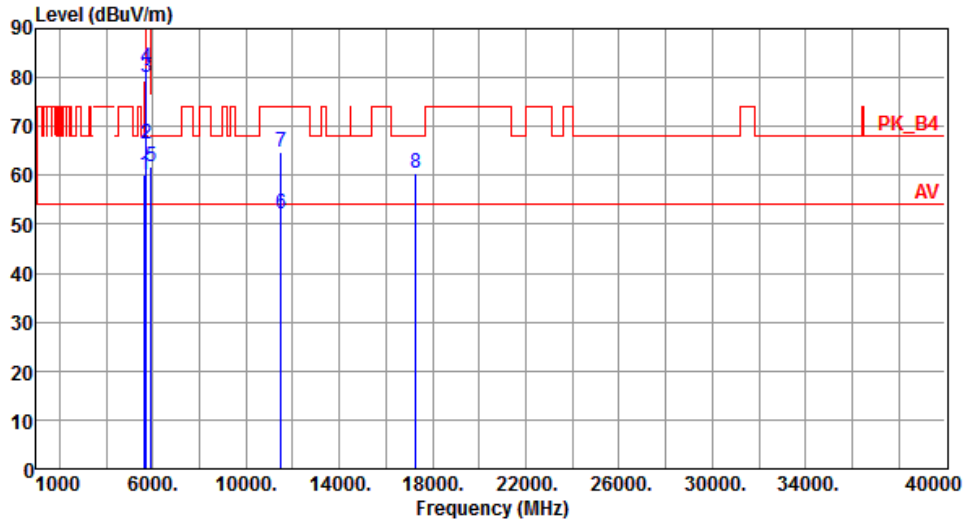

	Freq. MHz	Emission level dBuV/m	Limit dBuV/m	Margin dB	SA reading dBuV	Factor dB	Remark	ANT High cm	Turn Table deg
1	5650.00	60.12	68.20	-8.08	55.15	4.97	Peak	353	18
2	5700.00	66.51	105.20	-38.69	61.35	5.16	Peak	353	18
3	5720.00	79.90	110.80	-30.90	74.67	5.23	Peak	353	18
4	5725.00	82.15	122.20	-40.05	76.90	5.25	Peak	353	18
5	5925.00	61.63	68.20	-6.57	55.54	6.09	Peak	353	18
6	11510.00	51.98	54.00	-2.02	37.87	14.11	Average	230	188
7	11510.00	64.78	74.00	-9.22	50.67	14.11	Peak	230	188
8	17265.00	60.29	68.20	-7.91	42.98	17.31	Peak	100	209

Note 1: Emission Level (dBuV/m) = SA Reading (dBuV/m) + Factor* (dB)

*Factor includes antenna factor , cable loss and amplifier gain

Note 2: Margin (dB) = Emission level (dBuV/m) – Limit (dBuV/m).

Modulation	VHT40	Test Freq. (MHz)	5795
Polarization	Horizontal		

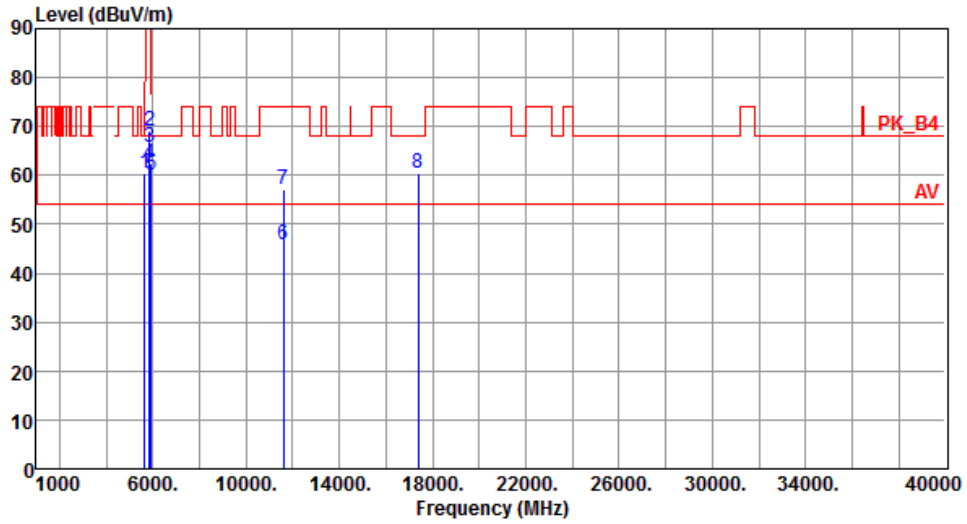

	Freq. MHz	Emission level dBuV/m	Limit dBuV/m	Margin dB	SA reading dBuV	Factor dB	Remark	ANT High cm	Turn Table deg
1	5650.00	60.37	68.20	-7.83	55.40	4.97	Peak	137	40
2	5850.00	69.02	122.20	-53.18	63.21	5.81	Peak	137	40
3	5855.00	65.78	110.80	-45.02	59.95	5.83	Peak	137	40
4	5875.00	62.56	105.20	-42.64	56.66	5.90	Peak	137	40
5	5925.00	60.16	68.20	-8.04	54.07	6.09	Peak	137	40
6	11590.00	45.70	54.00	-8.30	31.81	13.89	Average	100	142
7	11590.00	57.09	74.00	-16.91	43.20	13.89	Peak	100	142
8	17385.00	60.36	68.20	-7.84	42.61	17.75	Peak	100	52

Note 1: Emission Level (dBuV/m) = SA Reading (dBuV/m) + Factor* (dB)

*Factor includes antenna factor , cable loss and amplifier gain

Note 2: Margin (dB) = Emission level (dBuV/m) – Limit (dBuV/m).

Modulation	VHT40	Test Freq. (MHz)	5795
Polarization	Vertical		

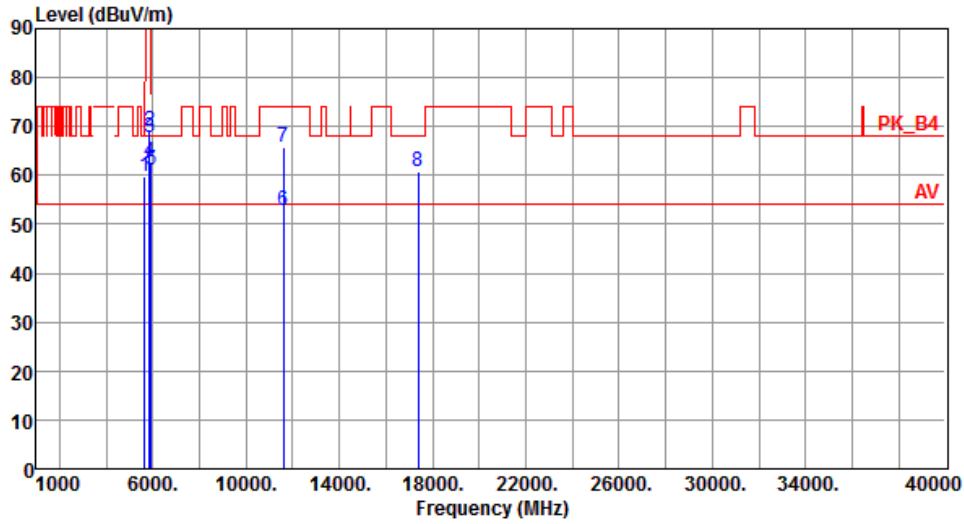

	Freq. MHz	Emission level dBuV/m	Limit dBuV/m	Margin dB	SA reading dBuV	Factor dB	Remark	ANT High cm	Turn Table deg
1	5650.00	59.72	68.20	-8.48	54.75	4.97	Peak	317	17
2	5850.00	69.08	122.20	-53.12	63.27	5.81	Peak	317	17
3	5855.00	67.69	110.80	-43.11	61.86	5.83	Peak	317	17
4	5875.00	62.61	105.20	-42.59	56.71	5.90	Peak	317	17
5	5925.00	61.01	68.20	-7.19	54.92	6.09	Peak	317	17
6	11590.00	52.79	54.00	-1.21	38.90	13.89	Average	224	198
7	11590.00	65.85	74.00	-8.15	51.96	13.89	Peak	224	198
8	17385.00	60.93	68.20	-7.27	43.18	17.75	Peak	100	202

Note 1: Emission Level (dBuV/m) = SA Reading (dBuV/m) + Factor* (dB)

*Factor includes antenna factor , cable loss and amplifier gain

Note 2: Margin (dB) = Emission level (dBuV/m) – Limit (dBuV/m).

3.5.8 Transmitter Radiated Unwanted Emissions (Above 1GHz) for VHT80

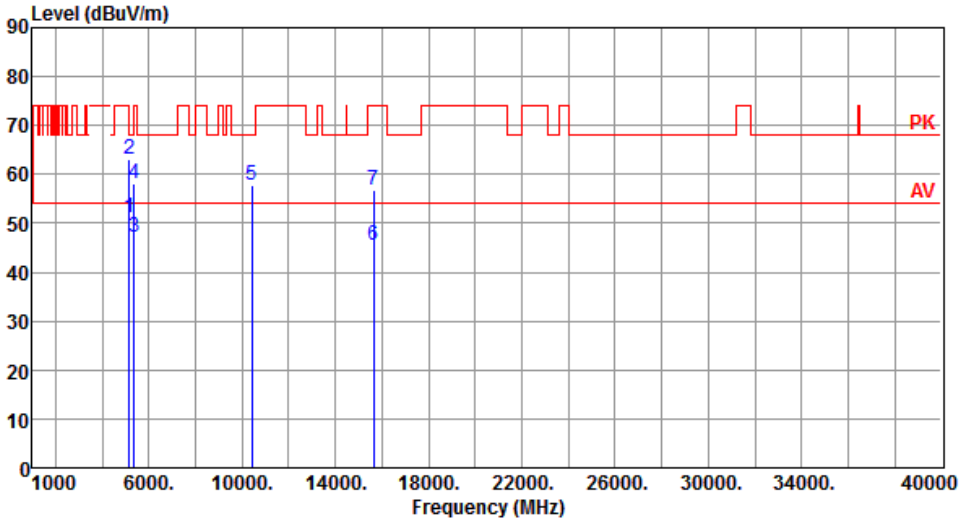
Modulation	VHT80	Test Freq. (MHz)	5210																																																																																	
Polarization	Horizontal																																																																																			
																																																																																				
	<table border="1"> <thead> <tr> <th>Freq.</th> <th>Emission level</th> <th>Limit</th> <th>Margin</th> <th>SA reading</th> <th>Factor</th> <th>Remark</th> <th>ANT High</th> <th>Turn Table</th> </tr> <tr> <th>MHz</th> <th>dBuV/m</th> <th>dBuV/m</th> <th>dB</th> <th>dBuV</th> <th>dB</th> <th></th> <th>cm</th> <th>deg</th> </tr> </thead> <tbody> <tr> <td>1</td> <td>5150.00</td> <td>51.13</td> <td>54.00</td> <td>-2.87</td> <td>46.59</td> <td>4.54</td> <td>Average</td> <td>100 52</td> </tr> <tr> <td>2</td> <td>5150.00</td> <td>63.24</td> <td>74.00</td> <td>-10.76</td> <td>58.70</td> <td>4.54</td> <td>Peak</td> <td>100 52</td> </tr> <tr> <td>3</td> <td>5350.00</td> <td>47.06</td> <td>54.00</td> <td>-6.94</td> <td>42.93</td> <td>4.13</td> <td>Average</td> <td>100 52</td> </tr> <tr> <td>4</td> <td>5350.00</td> <td>58.06</td> <td>74.00</td> <td>-15.94</td> <td>53.93</td> <td>4.13</td> <td>Peak</td> <td>100 52</td> </tr> <tr> <td>5</td> <td>10420.00</td> <td>57.78</td> <td>68.20</td> <td>-10.42</td> <td>43.89</td> <td>13.89</td> <td>Peak</td> <td>100 241</td> </tr> <tr> <td>6</td> <td>15630.00</td> <td>45.57</td> <td>54.00</td> <td>-8.43</td> <td>31.53</td> <td>14.04</td> <td>Average</td> <td>100 22</td> </tr> <tr> <td>7</td> <td>15630.00</td> <td>56.75</td> <td>74.00</td> <td>-17.25</td> <td>42.71</td> <td>14.04</td> <td>Peak</td> <td>100 22</td> </tr> </tbody> </table>	Freq.	Emission level	Limit	Margin	SA reading	Factor	Remark	ANT High	Turn Table	MHz	dBuV/m	dBuV/m	dB	dBuV	dB		cm	deg	1	5150.00	51.13	54.00	-2.87	46.59	4.54	Average	100 52	2	5150.00	63.24	74.00	-10.76	58.70	4.54	Peak	100 52	3	5350.00	47.06	54.00	-6.94	42.93	4.13	Average	100 52	4	5350.00	58.06	74.00	-15.94	53.93	4.13	Peak	100 52	5	10420.00	57.78	68.20	-10.42	43.89	13.89	Peak	100 241	6	15630.00	45.57	54.00	-8.43	31.53	14.04	Average	100 22	7	15630.00	56.75	74.00	-17.25	42.71	14.04	Peak	100 22		
Freq.	Emission level	Limit	Margin	SA reading	Factor	Remark	ANT High	Turn Table																																																																												
MHz	dBuV/m	dBuV/m	dB	dBuV	dB		cm	deg																																																																												
1	5150.00	51.13	54.00	-2.87	46.59	4.54	Average	100 52																																																																												
2	5150.00	63.24	74.00	-10.76	58.70	4.54	Peak	100 52																																																																												
3	5350.00	47.06	54.00	-6.94	42.93	4.13	Average	100 52																																																																												
4	5350.00	58.06	74.00	-15.94	53.93	4.13	Peak	100 52																																																																												
5	10420.00	57.78	68.20	-10.42	43.89	13.89	Peak	100 241																																																																												
6	15630.00	45.57	54.00	-8.43	31.53	14.04	Average	100 22																																																																												
7	15630.00	56.75	74.00	-17.25	42.71	14.04	Peak	100 22																																																																												
<p>Note 1: Emission Level (dBuV/m) = SA Reading (dBuV/m) + Factor* (dB) *Factor includes antenna factor , cable loss and amplifier gain Note 2: Margin (dB) = Emission level (dBuV/m) – Limit (dBuV/m).</p>																																																																																				

Modulation	VHT80	Test Freq. (MHz)	5210
Polarization	Vertical		

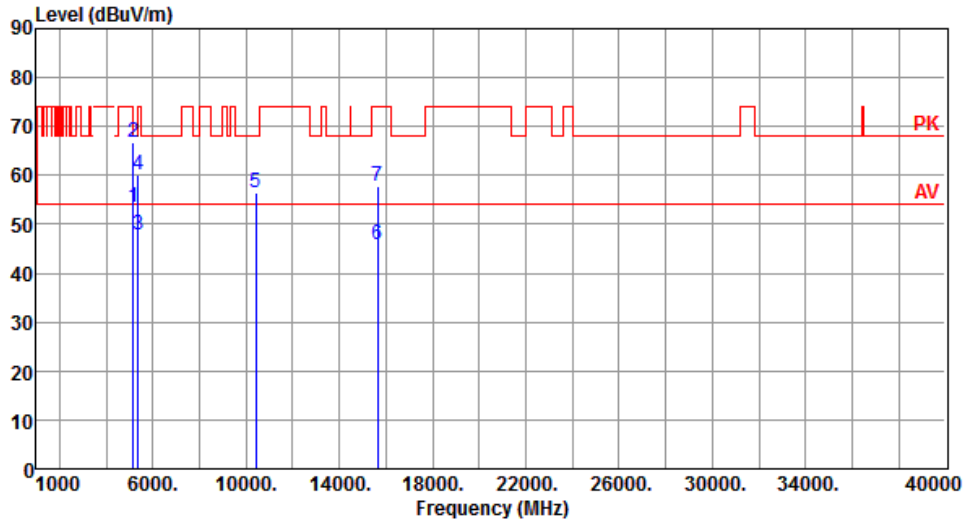

	Freq. MHz	Emission level dBuV/m	Limit dBuV/m	Margin dB	SA reading dBuV	Factor dB	Remark	ANT High cm	Turn Table deg
1	5150.00	53.35	54.00	-0.65	48.81	4.54	Average	337	353
2	5150.00	66.92	74.00	-7.08	62.38	4.54	Peak	337	353
3	5350.00	47.98	54.00	-6.02	43.85	4.13	Average	325	353
4	5350.00	59.96	74.00	-14.04	55.83	4.13	Peak	325	353
5	10420.00	56.53	68.20	-11.67	42.64	13.89	Peak	148	239
6	15630.00	45.90	54.00	-8.10	31.86	14.04	Average	100	348
7	15630.00	57.63	74.00	-16.37	43.59	14.04	Peak	100	348

Note 1: Emission Level (dBuV/m) = SA Reading (dBuV/m) + Factor* (dB)

*Factor includes antenna factor , cable loss and amplifier gain

Note 2: Margin (dB) = Emission level (dBuV/m) – Limit (dBuV/m).

Modulation	VHT80	Test Freq. (MHz)	5290
Polarization	Horizontal		

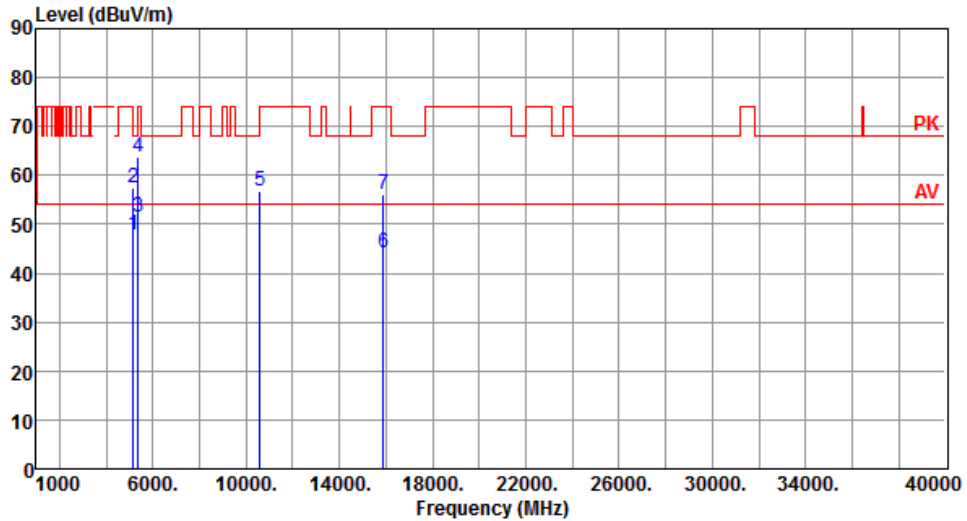

	Freq. MHz	Emission level dBuV/m	Limit dBuV/m	Margin dB	SA reading dBuV	Factor dB	Remark	ANT High cm	Turn Table deg
1	5150.00	47.83	54.00	-6.17	43.29	4.54	Average	100	56
2	5150.00	57.52	74.00	-16.48	52.98	4.54	Peak	100	56
3	5350.00	51.40	54.00	-2.60	47.27	4.13	Average	100	51
4	5350.00	63.67	74.00	-10.33	59.54	4.13	Peak	100	51
5	10580.00	56.81	68.20	-11.39	42.95	13.86	Peak	100	240
6	15870.00	44.06	54.00	-9.94	30.24	13.82	Average	100	51
7	15870.00	56.20	74.00	-17.80	42.38	13.82	Peak	100	51

Note 1: Emission Level (dBuV/m) = SA Reading (dBuV/m) + Factor* (dB)

*Factor includes antenna factor , cable loss and amplifier gain

Note 2: Margin (dB) = Emission level (dBuV/m) – Limit (dBuV/m).

Modulation	VHT80	Test Freq. (MHz)	5290
Polarization	Vertical		

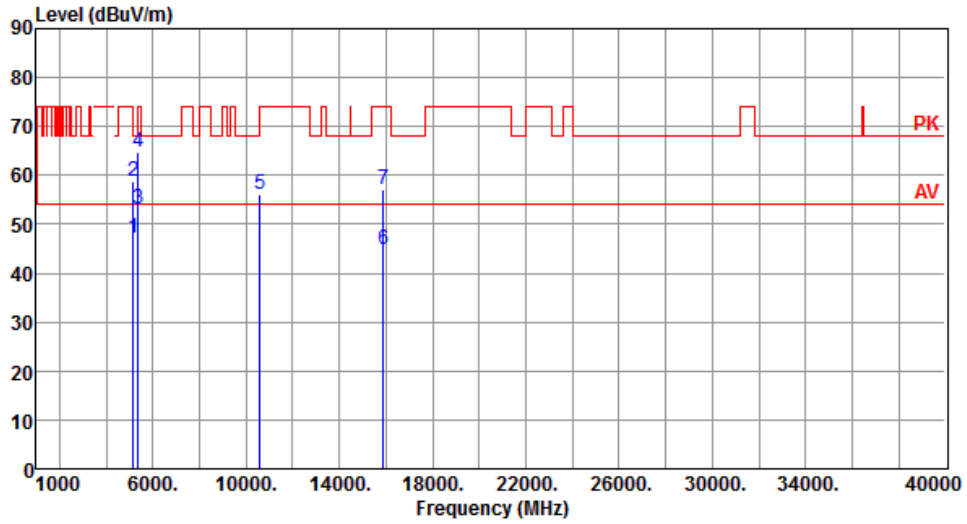

	Freq. MHz	Emission level dBuV/m	Limit dBuV/m	Margin dB	SA reading dBuV	Factor dB	Remark	ANT High cm	Turn Table deg
1	5150.00	47.11	54.00	-6.89	42.57	4.54	Average	349	358
2	5150.00	58.78	74.00	-15.22	54.24	4.54	Peak	349	358
3	5350.00	53.08	54.00	-0.92	48.95	4.13	Average	363	1
4	5350.00	64.75	74.00	-9.25	60.62	4.13	Peak	363	1
5	10580.00	56.16	68.20	-12.04	42.30	13.86	Peak	100	180
6	15870.00	44.81	54.00	-9.19	30.99	13.82	Average	100	149
7	15870.00	57.06	74.00	-16.94	43.24	13.82	Peak	100	149

Note 1: Emission Level (dBuV/m) = SA Reading (dBuV/m) + Factor* (dB)

*Factor includes antenna factor , cable loss and amplifier gain

Note 2: Margin (dB) = Emission level (dBuV/m) – Limit (dBuV/m).

Modulation	VHT80	Test Freq. (MHz)	5530
Polarization	Horizontal		

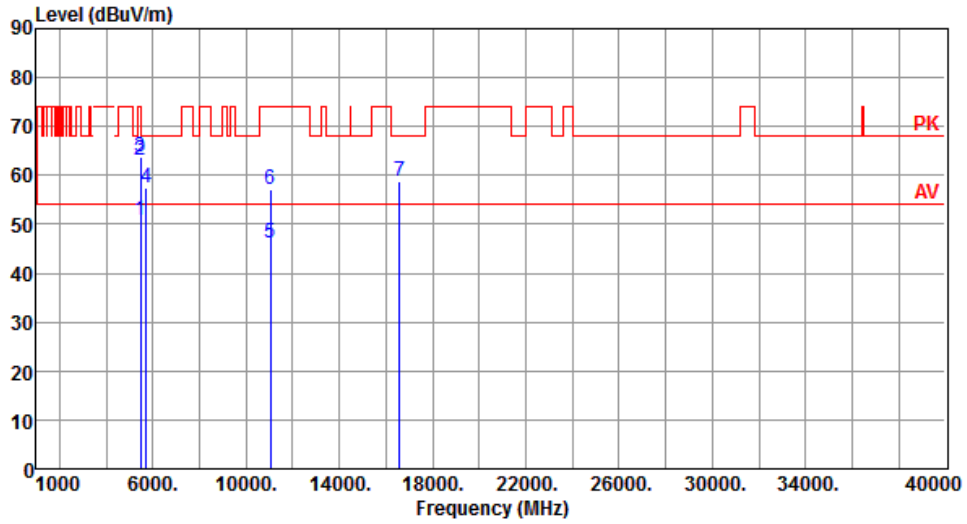

	Freq. MHz	Emission level dBuV/m	Limit dBuV/m	Margin dB	SA reading dBuV	Factor dB	Remark	ANT High cm	Turn Table deg
1	5460.00	50.88	54.00	-3.12	46.24	4.64	Average	100	45
2	5460.00	63.26	74.00	-10.74	58.62	4.64	Peak	100	45
3	5470.00	63.89	68.20	-4.31	59.24	4.65	Peak	100	45
4	5725.00	57.50	68.20	-10.70	52.25	5.25	Peak	100	45
5	11060.00	46.13	54.00	-7.87	32.04	14.09	Average	100	106
6	11060.00	57.01	74.00	-16.99	42.92	14.09	Peak	100	106
7	16590.00	58.85	68.20	-9.35	42.80	16.05	Peak	100	4

Note 1: Emission Level (dBuV/m) = SA Reading (dBuV/m) + Factor* (dB)

*Factor includes antenna factor , cable loss and amplifier gain

Note 2: Margin (dB) = Emission level (dBuV/m) – Limit (dBuV/m).

Modulation	VHT80	Test Freq. (MHz)	5530
Polarization	Vertical		

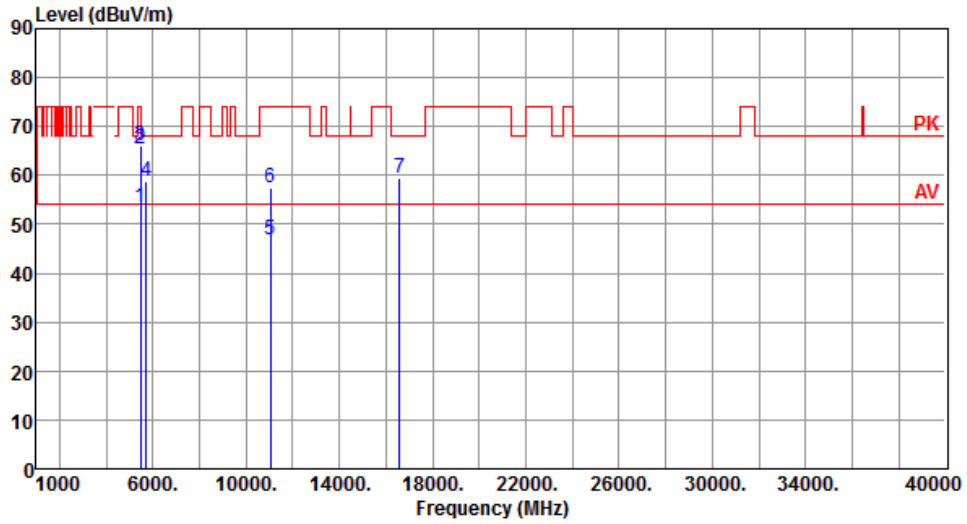

	Freq. MHz	Emission level dBuV/m	Limit dBuV/m	Margin dB	SA reading dBuV	Factor dB	Remark	ANT High cm	Turn Table deg
1	5460.00	53.36	54.00	-0.64	48.72	4.64	Average	363	7
2	5460.00	65.57	74.00	-8.43	60.93	4.64	Peak	363	7
3	5470.00	66.04	68.20	-2.16	61.39	4.65	Peak	363	7
4	5725.00	58.75	68.20	-9.45	53.50	5.25	Peak	363	7
5	11060.00	46.93	54.00	-7.07	32.84	14.09	Average	100	209
6	11060.00	57.59	74.00	-16.41	43.50	14.09	Peak	100	209
7	16590.00	59.34	68.20	-8.86	43.29	16.05	Peak	100	148

Note 1: Emission Level (dBuV/m) = SA Reading (dBuV/m) + Factor* (dB)

*Factor includes antenna factor , cable loss and amplifier gain

Note 2: Margin (dB) = Emission level (dBuV/m) – Limit (dBuV/m).

Modulation	VHT80	Test Freq. (MHz)	5775
Polarization	Horizontal		

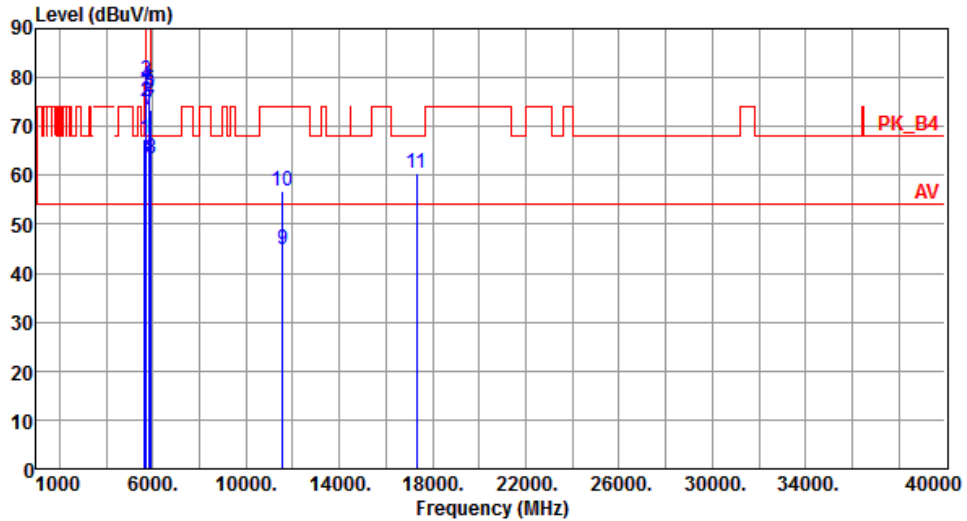

	Freq. MHz	Emission level dBuV/m	Limit dBuV/m	Margin dB	SA reading dBuV	Factor dB	Remark	ANT High cm	Turn Table deg
1	5650.00	67.53	68.20	-0.67	62.56	4.97	Peak	100	41
2	5700.00	75.05	105.20	-30.15	69.89	5.16	Peak	100	41
3	5720.00	79.25	110.80	-31.55	74.02	5.23	Peak	100	41
4	5725.00	78.35	122.20	-43.85	73.10	5.25	Peak	100	41
5	5850.00	77.44	122.20	-44.76	71.63	5.81	Peak	100	41
6	5855.00	76.82	110.80	-33.98	70.99	5.83	Peak	100	41
7	5875.00	73.35	105.20	-31.85	67.45	5.90	Peak	100	41
8	5925.00	63.57	68.20	-4.63	57.48	6.09	Peak	100	41
9	11550.00	44.75	54.00	-9.25	30.75	14.00	Average	100	143
10	11550.00	56.94	74.00	-17.06	42.94	14.00	Peak	100	143
11	17325.00	60.56	68.20	-7.64	43.07	17.49	Peak	100	143

Note 1: Emission Level (dBuV/m) = SA Reading (dBuV/m) + Factor* (dB)

*Factor includes antenna factor , cable loss and amplifier gain

Note 2: Margin (dB) = Emission level (dBuV/m) – Limit (dBuV/m).

Modulation	VHT80	Test Freq. (MHz)	5775
Polarization	Vertical		

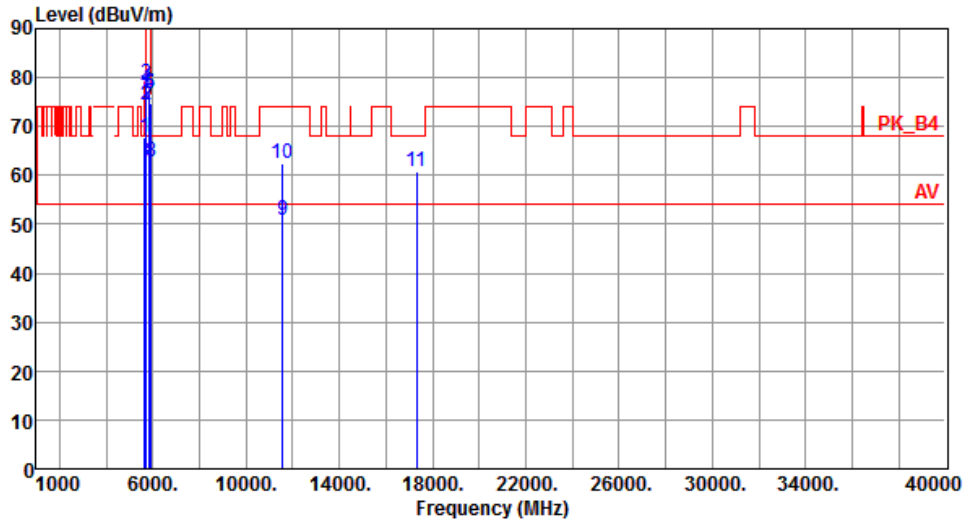

	Freq. MHz	Emission level dBuV/m	Limit dBuV/m	Margin dB	SA reading dBuV	Factor dB	Remark	ANT High cm	Turn Table deg
1	5650.00	67.65	68.20	-0.55	62.68	4.97	Peak	350	5
2	5700.00	74.56	105.20	-30.64	69.40	5.16	Peak	350	5
3	5720.00	78.58	110.80	-32.22	73.35	5.23	Peak	350	5
4	5725.00	77.86	122.20	-44.34	72.61	5.25	Peak	350	5
5	5850.00	76.61	122.20	-45.59	70.80	5.81	Peak	350	5
6	5855.00	76.62	110.80	-34.18	70.79	5.83	Peak	350	5
7	5875.00	74.66	105.20	-30.54	68.76	5.90	Peak	350	5
8	5925.00	62.93	68.20	-5.27	56.84	6.09	Peak	350	5
9	11550.00	50.73	54.00	-3.27	36.73	14.00	Average	195	200
10	11550.00	62.36	74.00	-11.64	48.36	14.00	Peak	195	200
11	17325.00	60.73	68.20	-7.47	43.24	17.49	Peak	100	209

Note 1: Emission Level (dBuV/m) = SA Reading (dBuV/m) + Factor* (dB)

*Factor includes antenna factor , cable loss and amplifier gain

Note 2: Margin (dB) = Emission level (dBuV/m) – Limit (dBuV/m).

3.6 Frequency Stability

3.6.1 Limit of Frequency Stability

Manufacturers of U-NII devices are responsible for ensuring frequency stability such that an emission is maintained within the band of operation under all conditions of normal operation as specified in the user's manual.

3.6.2 Test Procedures

1. The EUT is installed in an environment test chamber with external power source.
2. Set the chamber to operate at 20 centigrade and external power source to output at nominal voltage of EUT.
3. A sufficient stabilization period at each temperature is used prior to each frequency measurement.
4. When temperature is stabled, measure the frequency stability.
5. The test shall be performed under normal and extreme condition for temperature and voltage.

3.6.3 Test Setup

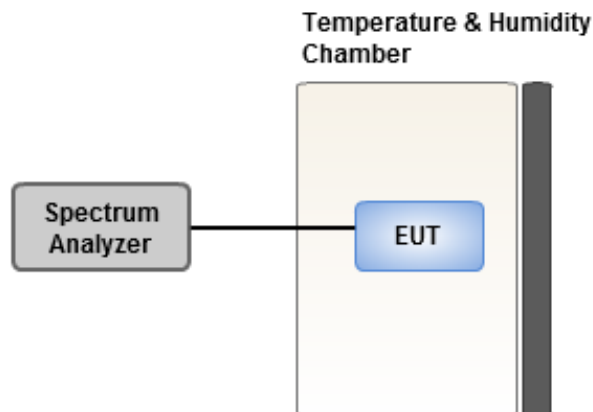

3.6.4 Test Result of Frequency Stability

Frequency: 5200 MHz	Frequency Drift (ppm)			
Temperature (°C)	0 minute	2 minutes	5 minutes	10 minutes
T20°CVmax	6.13	6.40	6.58	6.53
T20°CVmin	6.12	6.38	6.57	6.50
T60°CVnom	4.24	4.38	4.72	4.03
T50°CVnom	4.14	4.36	4.34	4.21
T40°CVnom	4.80	5.26	4.84	4.39
T30°CVnom	5.16	5.47	5.00	4.78
T20°CVnom	6.11	6.39	6.57	6.51
T10°CVnom	3.03	2.89	2.91	2.95
T0°CVnom	3.49	3.63	3.36	3.83
T-10°CVnom	3.33	3.59	3.88	3.81
T-20°CVnom	1.53	1.69	1.57	1.87
T-30°CVnom	1.03	0.90	1.45	1.61
Vnom [Vac]: 120		Vmax [Vac]: 138		Vmin [Vac]: 102
Tnom [°C]: 20		Tmax [°C]: 60		Tmin [°C]: -30

Frequency: 5785 MHz	Frequency Drift (ppm)			
Temperature (°C)	0 minute	2 minutes	5 minutes	10 minutes
T20°CVmax	5.86	5.84	6.41	6.53
T20°CVmin	5.29	5.28	5.47	5.63
T60°CVnom	4.09	4.34	3.68	4.26
T50°CVnom	3.82	4.19	3.98	3.74
T40°CVnom	4.68	4.89	5.19	4.98
T30°CVnom	4.47	4.37	4.63	4.54
T20°CVnom	5.74	5.36	5.92	5.49
T10°CVnom	3.05	3.32	3.26	3.68
T0°CVnom	3.21	3.07	3.11	3.47
T-10°CVnom	2.95	3.16	3.34	2.80
T-20°CVnom	1.22	1.69	1.32	1.70
T-30°CVnom	0.69	0.40	1.06	0.96
Vnom [Vac]: 120		Vmax [Vac]: 138		Vmin [Vac]: 102
Tnom [°C]: 20		Tmax [°C]: 60		Tmin [°C]: -30

4 Test laboratory information

Established in 2012, ICC provides foremost EMC & RF Testing and advisory consultation services by our skilled engineers and technicians. Our services employ a wide variety of advanced edge test equipment and one of the widest certification extents in the business.

International Certification Corp (EMC and Wireless Communication Laboratory), it is our definitive objective is to institute long term, trust-based associations with our clients. The expectation we set up with our clients is based on outstanding service, practical expertise and devotion to a certified value structure. Our passion is to grant our clients with best EMC / RF services by oriented knowledgeable and accommodating staff.

Our Test sites are located at Linkou District and Kwei Shan District. Location map can be found on our website <http://www.icertifi.com.tw>.

Linkou

Tel: 886-2-2601-1640

No. 30-2, Ding Fwu Tsuen, Lin
Kou District, New Taipei City,
Taiwan, R.O.C.

Kwei Shan

Tel: 886-3-271-8666

No. 3-1, Lane 6, Wen San 3rd St.,
Kwei Shan District, Tao Yuan City
333, Taiwan, R.O.C.

Kwei Shan Site II

Tel: 886-3-271-8640

No. 14-1, Lane 19, Wen San 3rd
St., Kwei Shan District, Tao Yuan
City 333, Taiwan, R.O.C.

If you have any suggestion, please feel free to contact us as below information.

Tel: 886-3-271-8666

Fax: 886-3-318-0155

Email: ICC_Service@icertifi.com.tw

==END==