

# FCC Test Report

**FCC ID** : NKR-SY30  
**Equipment** : WLAN/BT Module  
**Model No.** : DHSR-SY30  
**Brand Name** : Wistron NeWeb Corp.  
**Applicant** : Wistron NeWeb Corp.  
**Address** : 20 Park Avenue II, Hsinchu Science Park,  
Hsinchu 308, Taiwan, R.O.C.  
**Standard** : 47 CFR FCC Part 15.407  
**Received Date** : Dec. 07, 2015  
**Tested Date** : Dec. 15, 2015 ~ Jan. 15, 2016

We, International Certification Corp., would like to declare that the tested sample has been evaluated and in compliance with the requirement of the above standards. The test results contained in this report refer exclusively to the product. It may be duplicated completely for legal use with the approval of the applicant. It shall not be reproduced except in full without the written approval of our laboratory.

Approved & Reviewed by:

  
\_\_\_\_\_  
Gary Chang / Manager



---

## Table of Contents

<b>1</b>	<b>GENERAL DESCRIPTION .....</b>	<b>5</b>
1.1	Information.....	5
1.2	Local Support Equipment List .....	11
1.3	Test Setup Chart .....	11
1.4	The Equipment List .....	12
1.5	Testing Applied Standards .....	13
1.6	Measurement Uncertainty .....	13
<b>2</b>	<b>TEST CONFIGURATION .....</b>	<b>14</b>
2.1	Testing Condition .....	14
2.2	The Worst Test Modes and Channel Details .....	14
<b>3</b>	<b>TRANSMITTER TEST RESULTS.....</b>	<b>16</b>
3.1	Conducted Emissions.....	16
3.2	Emission Bandwidth .....	21
3.3	RF Output Power .....	24
3.4	Peak Power Spectral Density .....	26
3.5	Transmitter Radiated and Band Edge Emissions .....	30
3.6	Frequency Stability .....	77
<b>4</b>	<b>TEST LABORATORY INFORMATION .....</b>	<b>79</b>

---

## Release Record

Report No.	Version	Description	Issued Date
FR5D0701AN	Rev. 01	Initial issue	Jan. 29, 2016

## Summary of Test Results

FCC Rules	Test Items	Measured	Result
15.207	Conducted Emissions	[dBuV]: 20.814MHz 19.53 (Margin -30.47dB) - AV	Pass
15.407(b) 15.209	Radiated Emissions	[dBuV/m at 3m]: 5150.00MHz 52.05 (Margin -1.95dB) - AV	Pass
15.407(a)	Emission Bandwidth	Meet the requirement of limit	Pass
15.407(e)	6dB bandwidth	Meet the requirement of limit	Pass
15.407(a)	RF Output Power	Max Power [dBm]: 5150-5250MHz: 13.90 5725-5850MHz: 13.88	Pass
15.407(a)	Peak Power Spectral Density	Meet the requirement of limit	Pass
15.407(g)	Frequency Stability	Meet the requirement of limit	Pass
15.203	Antenna Requirement	Meet the requirement of limit	Pass

# 1 General Description

## 1.1 Information

### 1.1.1 Specification of the Equipment under Test (EUT)

RF General Information					
Frequency Range (MHz)	IEEE Std. 802.11	Ch. Freq. (MHz)	Channel Number	Transmit Chains (N <sub>TX</sub> )	Data Rate / MCS
5150-5250	a	5180-5240	36-48 [4]	1	6-54 Mbps
5150-5250	n (HT20)	5180-5240	36-48 [4]	1	MCS 0-7
5150-5250	n (HT40)	5190-5230	38-46 [2]	1	MCS 0-7
5150-5250	ac (VHT20)	5180-5240	36-48 [4]	1	MCS 0-8
5150-5250	ac (VHT40)	5190-5230	38-46 [2]	1	MCS 0-9
5150-5250	ac (VHT80)	5210	42 [1]	1	MCS 0-9

Note 1: RF output power specifies that Maximum Conducted Output Power.  
 Note 2: 802.11a/n/ac uses a combination of OFDM-BPSK, QPSK, 16QAM, 64QAM, 256QAM modulation.

RF General Information					
Frequency Range (MHz)	IEEE Std. 802.11	Ch. Freq. (MHz)	Channel Number	Transmit Chains (N <sub>TX</sub> )	Data Rate / MCS
5725-5850	a	5745-5825	149-165 [5]	1	6-54 Mbps
5725-5850	n (HT20)	5745-5825	149-165 [5]	1	MCS 0-7
5725-5850	n (HT40)	5755-5795	151-159 [2]	1	MCS 0-7
5725-5850	ac (VHT20)	5745-5825	149-165 [5]	1	MCS 0-8
5725-5850	ac (VHT40)	5755-5795	151-159 [2]	1	MCS 0-9
5725-5850	ac (VHT80)	5775	155 [1]	1	MCS 0-9

Note 1: RF output power specifies that Maximum Conducted Output Power.  
 Note 2: 802.11a/n/ac uses a combination of OFDM-BPSK, QPSK, 16QAM, 64QAM, 256QAM modulation.

## 1.1.2 Antenna Details

Ant. No.	Model	Type	Connector	Frequency band (MHz) / Antenna Gain (dBi)		
				2400~2483.5	5150~5250	5725~5850
1	Antenna 1 (Green PCB, Cable 1)	Dipole	UFL	0.21	-2.06	-0.95
2	Antenna 2 (Blue PCB, Cable 2)	Dipole	UFL	1.25	1.39	-0.3

Note: Antenna 2 with highest gain was chosen for final test.

The following antenna cables are used in this EUT. The only difference is cable length.

For Antenna 1 (Green PCB, Cable 1)

Cable No.	Model (Cable Color: Black)	Cable No.	Model (Cable Color: Gray)	Cable Length (mm)
1	8JJEKQ1990000001H1	22	8JJEKR1990000001H1	199
2	8JJEKQ2100000001H1	23	8JJEKR2100000001H1	210
3	8JJEKQ2200000001H1	24	8JJEKR2200000001H1	220
4	8JJEKQ2300000001H1	25	8JJEKR2300000001H1	230
5	8JJEKQ2400000001H1	26	8JJEKR2400000001H1	240
6	8JJEKQ2500000001H1	27	8JJEKR2500000001H1	250
7	8JJEKQ2600000001H1	28	8JJEKR2600000001H1	260
8	8JJEKQ2700000001H1	29	8JJEKR2700000001H1	270
9	8JJEKQ2800000001H1	30	8JJEKR2800000001H1	280
10	8JJEKQ2900000001H1	31	8JJEKR2900000001H1	290
11	8JJEKQ3000000001H1	32	8JJEKR3000000001H1	300
12	8JJEKQ3100000001H1	33	8JJEKR3100000001H1	310
13	8JJEKQ3200000001H1	34	8JJEKR3200000001H1	320
14	8JJEKQ3300000001H1	35	8JJEKR3300000001H1	330
15	8JJEKQ3400000001H1	36	8JJEKR3400000001H1	340
16	8JJEKQ3500000001H1	37	8JJEKR3500000001H1	350
17	8JJEKQ3600000001H1	38	8JJEKR3600000001H1	360
18	8JJEKQ3700000001H1	39	8JJEKR3700000001H1	370
19	8JJEKQ3800000001H1	40	8JJEKR3800000001H1	380
20	8JJEKQ3900000001H1	41	8JJEKR3900000001H1	390
21	8JJEKQ4000000001H1	42	8JJEKR4000000001H1	400

For Antenna 2 (Blue PCB, Cable 2)

Cable No.	Model (Cable Color: Black)	Cable No.	Model (Cable Color: Gray)	Cable No.	Model (Cable Color: White)	Cable Length (mm)
1	8JJEKQ400000001H1	52	8JJEKR400000001H1	103	8JJEKP400000001H1	400
2	8JJEKQ410000001H1	53	8JJEKR410000001H1	104	8JJEKP410000001H1	410
3	8JJEKQ420000001H1	54	8JJEKR420000001H1	105	8JJEKP420000001H1	420
4	8JJEKQ430000001H1	55	8JJEKR430000001H1	106	8JJEKP430000001H1	430
5	8JJEKQ440000001H1	56	8JJEKR440000001H1	107	8JJEKP440000001H1	440
6	8JJEKQ450000001H1	57	8JJEKR450000001H1	108	8JJEKP450000001H1	450
7	8JJEKQ460000001H1	58	8JJEKR460000001H1	109	8JJEKP460000001H1	460
8	8JJEKQ470000001H1	59	8JJEKR470000001H1	110	8JJEKP470000001H1	470
9	8JJEKQ480000001H1	60	8JJEKR480000001H1	111	8JJEKP480000001H1	480
10	8JJEKQ490000001H1	61	8JJEKR490000001H1	112	8JJEKP490000001H1	490
11	8JJEKQ500000001H1	62	8JJEKR500000001H1	113	8JJEKP500000001H1	500
12	8JJEKQ510000001H1	63	8JJEKR510000001H1	114	8JJEKP510000001H1	510
13	8JJEKQ520000001H1	64	8JJEKR520000001H1	115	8JJEKP520000001H1	520
14	8JJEKQ530000001H1	65	8JJEKR530000001H1	116	8JJEKP530000001H1	530
15	8JJEKQ540000001H1	66	8JJEKR540000001H1	117	8JJEKP540000001H1	540
16	8JJEKQ550000001H1	67	8JJEKR550000001H1	118	8JJEKP550000001H1	550
17	8JJEKQ560000001H1	68	8JJEKR560000001H1	119	8JJEKP560000001H1	560
18	8JJEKQ570000001H1	69	8JJEKR570000001H1	120	8JJEKP570000001H1	570
19	8JJEKQ580000001H1	70	8JJEKR580000001H1	121	8JJEKP580000001H1	580
20	8JJEKQ590000001H1	71	8JJEKR590000001H1	122	8JJEKP590000001H1	590
21	8JJEKQ600000001H1	72	8JJEKR600000001H1	123	8JJEKP600000001H1	600
22	8JJEKQ610000001H1	73	8JJEKR610000001H1	124	8JJEKP610000001H1	610
23	8JJEKQ620000001H1	74	8JJEKR620000001H1	125	8JJEKP620000001H1	620
24	8JJEKQ630000001H1	75	8JJEKR630000001H1	126	8JJEKP630000001H1	630
25	8JJEKQ640000001H1	76	8JJEKR640000001H1	127	8JJEKP640000001H1	640
26	8JJEKQ650000001H1	77	8JJEKR650000001H1	128	8JJEKP650000001H1	650
27	8JJEKQ660000001H1	78	8JJEKR660000001H1	129	8JJEKP660000001H1	660
28	8JJEKQ670000001H1	79	8JJEKR670000001H1	130	8JJEKP670000001H1	670
29	8JJEKQ680000001H1	80	8JJEKR680000001H1	131	8JJEKP680000001H1	680
30	8JJEKQ690000001H1	81	8JJEKR690000001H1	132	8JJEKP690000001H1	690
31	8JJEKQ700000001H1	82	8JJEKR700000001H1	133	8JJEKP700000001H1	700
32	8JJEKQ710000001H1	83	8JJEKR710000001H1	134	8JJEKP710000001H1	710
33	8JJEKQ720000001H1	84	8JJEKR720000001H1	135	8JJEKP720000001H1	720
34	8JJEKQ730000001H1	85	8JJEKR730000001H1	136	8JJEKP730000001H1	730
35	8JJEKQ740000001H1	86	8JJEKR740000001H1	137	8JJEKP740000001H1	740
36	8JJEKQ750000001H1	87	8JJEKR750000001H1	138	8JJEKP750000001H1	750
37	8JJEKQ760000001H1	88	8JJEKR760000001H1	139	8JJEKP760000001H1	760

38	8JJEKQ7700000001H1	89	8JJEKR7700000001H1	140	8JJEKP7700000001H1	770
39	8JJEKQ7800000001H1	90	8JJEKR7800000001H1	141	8JJEKP7800000001H1	780
40	8JJEKQ7900000001H1	91	8JJEKR7900000001H1	142	8JJEKP7900000001H1	790
41	8JJEKQ8000000001H1	92	8JJEKR8000000001H1	143	8JJEKP8000000001H1	800
42	8JJEKQ8100000001H1	93	8JJEKR8100000001H1	144	8JJEKP8100000001H1	810
43	8JJEKQ8200000001H1	94	8JJEKR8200000001H1	145	8JJEKP8200000001H1	820
44	8JJEKQ8300000001H1	95	8JJEKR8300000001H1	146	8JJEKP8300000001H1	830
45	8JJEKQ8400000001H1	96	8JJEKR8400000001H1	147	8JJEKP8400000001H1	840
46	8JJEKQ8500000001H1	97	8JJEKR8500000001H1	148	8JJEKP8500000001H1	850
47	8JJEKQ8600000001H1	98	8JJEKR8600000001H1	149	8JJEKP8600000001H1	860
48	8JJEKQ8700000001H1	99	8JJEKR8700000001H1	150	8JJEKP8700000001H1	870
49	8JJEKQ8800000001H1	100	8JJEKR8800000001H1	151	8JJEKP8800000001H1	880
50	8JJEKQ8900000001H1	101	8JJEKR8900000001H1	152	8JJEKP8900000001H1	890
51	8JJEKQ9000000001H1	102	8JJEKR9000000001H1	153	8JJEKP9000000001H1	900

### 1.1.3 Power Supply Type of Equipment under Test (EUT)

<b>Power Supply Type</b>	DC 4V/1A
--------------------------	----------

### 1.1.4 Accessories

N/A

### 1.1.5 Channel List

For Frequency band 5150-5250 MHz			
802.11 a / HT20 / VHT20		HT40 / VHT40	
Channel	Frequency(MHz)	Channel	Frequency(MHz)
36	5180	38	5190
40	5200	46	5230
44	5220	<b>VHT 80</b>	
48	5240	42	5210

For Frequency band 5725~5850 MHz			
802.11 a / HT20 / VHT20		HT40 / VHT40	
Channel	Frequency(MHz)	Channel	Frequency(MHz)
149	5745	151	5755
153	5765	159	5795
157	5785	<b>VHT80</b>	
161	5805	155	5775
165	5825	---	---



### 1.1.6 Test Tool and Duty Cycle

Test Tool	WCN Combo Tool, version: W1417		
Duty Cycle and Duty Factor	Mode	Duty cycle (%)	Duty factor (dB)
	11a	93.75%	0.28
	VHT20	94.18%	0.26
	VHT40	86.69%	0.62
	VHT80	77.58%	1.10

### 1.1.7 Power Setting

For Frequency band 5150-5250 MHz		
Modulation Mode	Test Frequency (MHz)	Power Set
11a	5180	15.5
11a	5200	15.5
11a	5240	15.5
HT20	5180	15.5
HT20	5200	15.5
HT20	5240	15.5
HT40	5190	15.5
HT40	5230	15.5
VHT20	5180	15.5
VHT20	5200	15.5
VHT20	5240	15.5
VHT40	5190	15.5
VHT40	5230	15.5
VHT80	5210	16

For Frequency band 5725~5850 MHz		
Modulation Mode	Test Frequency (MHz)	Power Set
11a	5745	15
11a	5785	15
11a	5825	15
HT20	5745	15
HT20	5785	15
HT20	5825	15
HT40	5755	15
HT40	5795	15
VHT20	5745	15
VHT20	5785	15
VHT20	5825	15
VHT40	5755	15
VHT40	5795	15
VHT80	5775	15.5

## 1.2 Local Support Equipment List

Support Equipment List						
No.	Equipment	Brand	Model	S/N	FCC ID	Signal cable / Length (m)
1	Notebook	DELL	Latitude E6440	2ZC4Z52	DoC	---
2	DC Power Supply	GW INSTEK	GPC-3060D	EM884797	---	---
3	Fixture	---	---	---	---	---

Note: Fixture was supplied by applicant.

## 1.3 Test Setup Chart

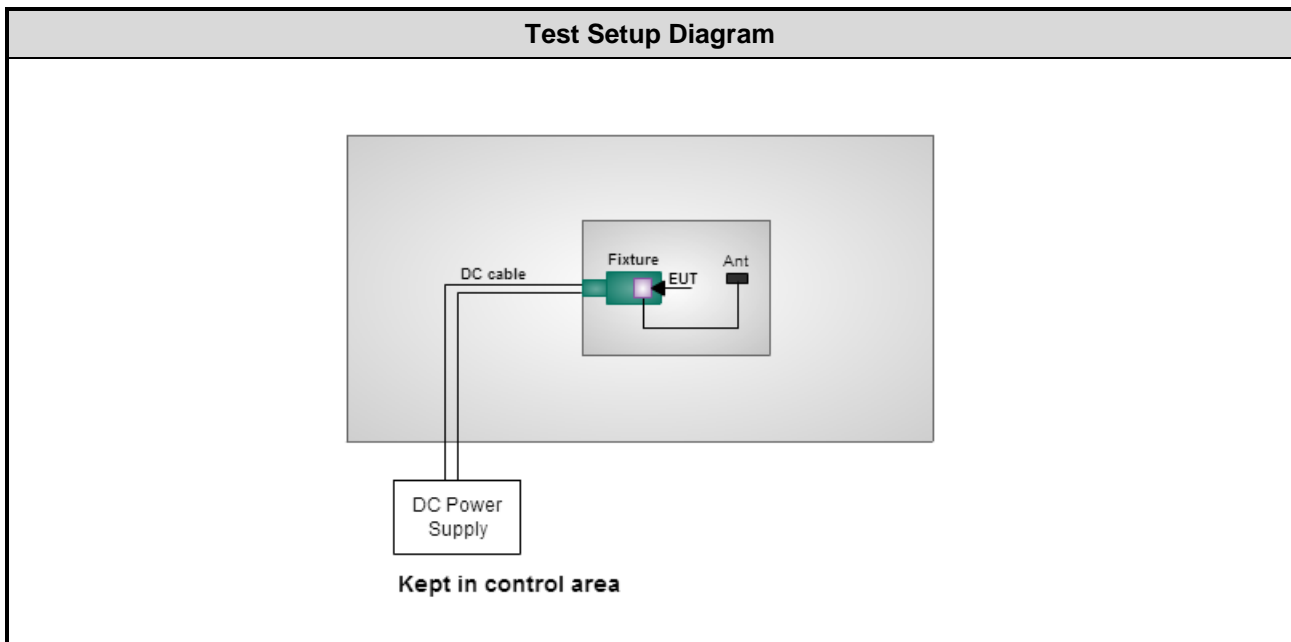

Note: The support notebook was disconnected from EUT and removed from test table when EUT is set to transmit continuously.

## 1.4 The Equipment List

<b>Test Item</b>	Conducted Emission				
<b>Test Site</b>	Conduction room 1 / (CO01-WS)				
<b>Tested Date</b>	Dec. 31, 2015				
<b>Instrument</b>	<b>Manufacturer</b>	<b>Model No.</b>	<b>Serial No.</b>	<b>Calibration Date</b>	<b>Calibration Until</b>
EMC Receiver	R&S	ESCS 30	100169	Oct. 21, 2015	Oct. 20, 2016
LISN	SCHWARZBECK	Schwarzbeck 8127	8127-667	Nov. 13, 2015	Nov. 12, 2016
RF Cable-CON	EMC	EMCCFD300-BM-B M-6000	50821	Dec. 21, 2015	Dec. 20, 2016
Measurement Software	AUDIX	e3	6.120210k	NA	NA
Note: Calibration Interval of instruments listed above is one year.					

<b>Test Item</b>	Radiated Emission				
<b>Test Site</b>	966 chamber1 / (03CH01-WS)				
<b>Tested Date</b>	Dec. 15, 2015 ~ Jan. 15, 2016				
<b>Instrument</b>	<b>Manufacturer</b>	<b>Model No.</b>	<b>Serial No.</b>	<b>Calibration Date</b>	<b>Calibration Until</b>
Spectrum Analyzer	R&S	FSV40	101063	Feb. 03, 2015	Feb. 02, 2016
Receiver	R&S	ESR3	101658	Nov. 04, 2015	Nov. 03, 2016
Bilog Antenna	SCHWARZBECK	VULB9168	VULB9168-522	Aug. 20, 2015	Aug. 19, 2016
Horn Antenna 1G-18G	SCHWARZBECK	BBHA 9120 D	BBHA 9120 D 1095	Oct. 07, 2015	Oct. 06, 2016
Horn Antenna 18G-40G	SCHWARZBECK	BBHA 9170	BBHA 9170517	Nov. 04, 2015	Nov. 03, 2016
Loop Antenna	R&S	HFH2-Z2	11900	Nov. 16, 2015	Nov. 15, 2016
Loop Antenna Cable	KOAX KABEL	101354-BW	101354-BW	Dec. 10, 2015	Dec. 09, 2016
Preamplifier	Burgeon	BPA-530	SN:100219	Sep. 10, 2015	Sep. 09, 2016
Preamplifier	Agilent	83017A	MY39501308	Oct. 02, 2015	Oct. 01, 2016
Preamplifier	EMC	EMC184045B	980192	Sep. 01, 2015	Aug. 31, 2016
RF Cable	HUBER+SUHNER	SUCOFLEX104	MY16014/4	Dec. 10, 2015	Dec. 09, 2016
RF Cable	HUBER+SUHNER	SUCOFLEX104	MY16019/4	Dec. 10, 2015	Dec. 09, 2016
RF Cable	HUBER+SUHNER	SUCOFLEX104	MY16139/4	Dec. 10, 2015	Dec. 09, 2016
LF cable 3M	Woken	CFD400NL-LW	CFD400NL-001	Dec. 10, 2015	Dec. 09, 2016
LF cable 10M	Woken	CFD400NL-LW	CFD400NL-002	Dec. 10, 2015	Dec. 09, 2016
Measurement Software	AUDIX	e3	6.120210g	NA	NA
Note: Calibration Interval of instruments listed above is one year.					

<b>Test Item</b>	RF Conducted				
<b>Test Site</b>	(TH01-WS)				
<b>Tested Date</b>	Jan. 11 ~ Jan. 15, 2016				
<b>Instrument</b>	<b>Manufacturer</b>	<b>Model No.</b>	<b>Serial No.</b>	<b>Calibration Date</b>	<b>Calibration Until</b>
Spectrum Analyzer	R&S	FSV40	101063	Feb. 03, 2015	Feb. 02, 2016
TEMP&HUMIDITY CHAMBER	GIANT FORCE	GCT-225-40-SP-SD	MAF1212-002	Nov. 27, 2015	Nov. 26, 2016
Power Meter	Anritsu	ML2495A	1241002	Sep. 21, 2015	Sep. 20, 2016
Power Sensor	Anritsu	MA2411B	1207366	Sep. 21, 2015	Sep. 20, 2016
DC POWER SOURCE	GW INSTRON	GPC-3060D	EM884797	Oct. 20, 2015	Oct. 19, 2016
Measurement Software	Sporton	Sporton_1	1.3.30	NA	NA
Note: Calibration Interval of instruments listed above is one year.					

## 1.5 Testing Applied Standards

According to the specification of EUT, the EUT must comply with following standards and KDB documents.

47 CFR FCC Part 15.407

ANSI C63.10-2013

FCC KDB 789033 D02 General UNII Test Procedures New Rules v01r01

FCC KDB 644545 D03 Guidance for IEEE 802 11ac New Rules v01

FCC KDB 412172 D01 Determining ERP and EIRP v01r01

## 1.6 Measurement Uncertainty

ISO/IEC 17025 requires that an estimate of the measurement uncertainties associated with the emissions test results be included in the report. The measurement uncertainties given below are based on a 95% confidence level (based on a coverage factor (k=2))

Measurement Uncertainty	
Parameters	Uncertainty
Bandwidth	±34.134 Hz
Conducted power	±0.808 dB
Frequency error	±34.134 Hz
Power density	±0.463 dB
Conducted emission	±2.670 dB
AC conducted emission	±2.92 dB
Radiated emission ≤ 1GHz	±3.66 dB
Radiated emission > 1GHz	±5.63 dB
Time	±0.1%
Temperature	±0.6 °C

## 2 Test Configuration

### 2.1 Testing Condition

Test Item	Test Site	Ambient Condition	Tested By
AC Conduction	CO01-WS	20°C / 59%	Peter Lin
Radiated Emissions	03CH01-WS	21-23°C / 61-65%	Anderson Hung
RF Conducted	TH01-WS	22°C / 61%	Alex Huang

➤ FCC site registration No.: 657002

➤ IC site registration No.: 10807A-1

### 2.2 The Worst Test Modes and Channel Details

For Frequency band 5150-5250 MHz			
Test item	Modulation Mode	Test Frequency (MHz)	Data Rate
Conducted Emissions	VHT80	5210	MCS 0
Radiated Emissions ≤1GHz	VHT80	5210	MCS 0
RF Output Power	11a	5180 / 5200 / 5240	6 Mbps
	HT20	5180 / 5200 / 5240	MCS 0
	HT40	5190 / 5230	MCS 0
	VHT20	5180 / 5200 / 5240	MCS 0
	VHT40	5190 / 5230	MCS 0
	VHT80	5210	MCS 0
Radiated Emissions >1GHz Emission Bandwidth Peak Power Spectral Density	11a	5180 / 5200 / 5240	6 Mbps
	VHT20	5180 / 5200 / 5240	MCS 0
	VHT40	5190 / 5230	MCS 0
Frequency Stability	Un-modulation	5200	---

**NOTE:**

- The EUT was pretested with 3 orientations placed on the table for the radiated emission measurement – X, Y, and Z-plane. The **Y-plane** result was found as the worst case and was shown in this report.
- See item 1.1.2 antenna sheet list, **cable length 400mm & 900mm** were selected for radiated emission below 1GHz test. **Cable length 400mm** was for radiated emission above 1GHz test.
- Test configurations are listed as below:
  - 1) Configuration 1: Antenna cable length: 400mm.
  - 2) Configuration 2: Antenna cable length: 900mm.

For Frequency band 5725-5850 MHz			
Test item	Modulation Mode	Test Frequency (MHz)	Data Rate
Conducted Emissions	VHT40	5755	MCS 0
Radiated Emissions ≤1GHz	VHT40	5755	MCS 0
RF Output Power	11a	5745 / 5785 / 5825	6 Mbps
	HT20	5745 / 5785 / 5825	MCS 0
	HT40	5755 / 5795	MCS 0
	VHT20	5745 / 5785 / 5825	MCS 0
	VHT40	5755 / 5795	MCS 0
	VHT80	5775	MCS 0
Radiated Emissions >1GHz Emission Bandwidth 6dB bandwidth Peak Power Spectral Density	11a	5745 / 5785 / 5825	6 Mbps
	VHT20	5745 / 5785 / 5825	MCS 0
	VHT40	5755 / 5795	MCS 0
	VHT80	5775	MCS 0
Frequency Stability	Un-modulation	5785	---
<b>NOTE:</b>			
<ol style="list-style-type: none"> <li>The EUT was pretested with 3 orientations placed on the table for the radiated emission measurement – X, Y, and Z-plane. The <b>Y-plane</b> result was found as the worst case and was shown in this report.</li> <li>See item 1.1.2 antenna sheet list, <b>cable length 400mm &amp; 900mm</b> were selected for radiated emission below 1GHz test. <b>Cable length 400mm</b> was for radiated emission above 1GHz test.</li> <li>Test configurations are listed as below: <ol style="list-style-type: none"> <li>Configuration 1: Antenna cable length: 400mm.</li> <li>Configuration 2: Antenna cable length: 900mm.</li> </ol> </li> </ol>			

## 3 Transmitter Test Results

### 3.1 Conducted Emissions

#### 3.1.1 Limit of Conducted Emissions

Conducted Emissions Limit		
Frequency Emission (MHz)	Quasi-Peak	Average
0.15-0.5	66 - 56 *	56 - 46 *
0.5-5	56	46
5-30	60	50

Note 1: \* Decreases with the logarithm of the frequency.

#### 3.1.2 Test Procedures

1. The device is placed on a test table, raised 80 cm above the reference ground plane. The vertical conducting plane is located 40 cm to the rear of the device.
2. The device is connected to line impedance stabilization network (LISN) and other accessories are connected to other LISN. Measured levels of AC power line conducted emission are across the 50  $\Omega$  LISN port.
3. AC conducted emission measurements is made over frequency range from 150 kHz to 30 MHz.
4. This measurement was performed with AC 120V / 60Hz.

#### 3.1.3 Test Setup

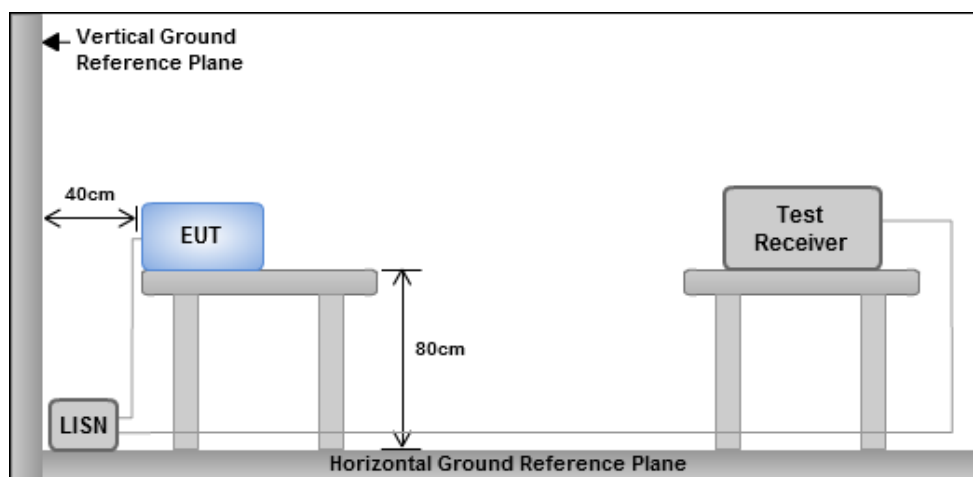

- Note: 1. Support units were connected to second LISN.  
 2. Both of LISNs (AMN) are 80 cm from EUT and at least 80 cm from other units and other metal planes



### 3.1.4 Test Result of Conducted Emissions

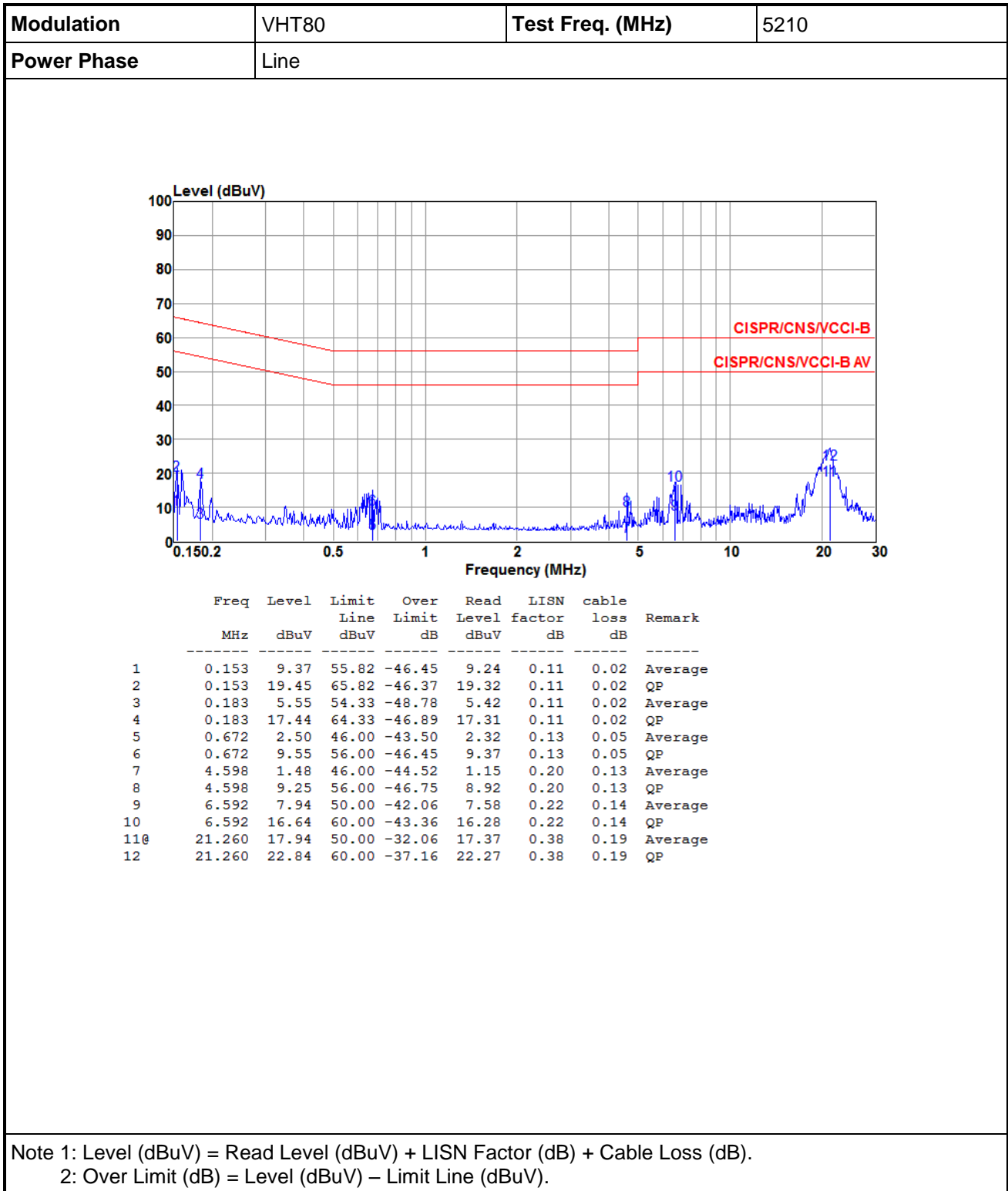

<b>Modulation</b>	VHT80	<b>Test Freq. (MHz)</b>	5210
<b>Power Phase</b>	Neutral		

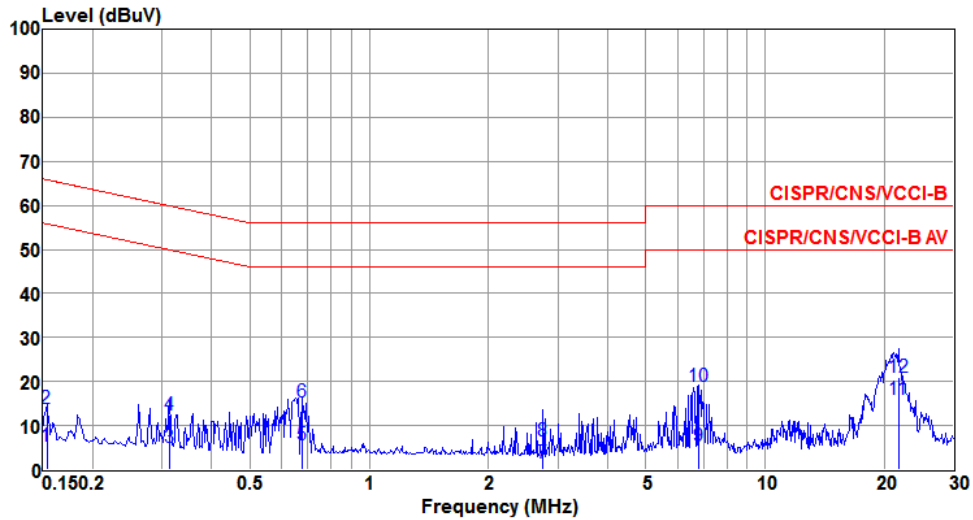

	Freq	Level	Limit	Over	Read	LISN	cable	Remark
	MHz	dBuV	Line	Limit	Level	factor	loss	
			dBuV	dB	dBuV	dB	dB	
1	0.153	5.24	55.82	-50.58	5.09	0.13	0.02	Average
2	0.153	13.74	65.82	-52.08	13.59	0.13	0.02	QP
3	0.313	5.06	49.88	-44.82	4.90	0.13	0.03	Average
4	0.313	12.38	59.88	-47.50	12.22	0.13	0.03	QP
5	0.675	5.64	46.00	-40.36	5.46	0.13	0.05	Average
6	0.675	15.28	56.00	-40.72	15.10	0.13	0.05	QP
7	2.750	1.42	46.00	-44.58	1.15	0.17	0.10	Average
8	2.750	6.46	56.00	-49.54	6.19	0.17	0.10	QP
9	6.805	5.27	50.00	-44.73	4.90	0.23	0.14	Average
10	6.805	18.90	60.00	-41.10	18.53	0.23	0.14	QP
11@	21.715	15.93	50.00	-34.07	15.31	0.42	0.20	Average
12	21.715	20.91	60.00	-39.09	20.29	0.42	0.20	QP

Note 1: Level (dBuV) = Read Level (dBuV) + LISN Factor (dB) + Cable Loss (dB).  
 2: Over Limit (dB) = Level (dBuV) – Limit Line (dBuV).

<b>Modulation</b>	VHT40	<b>Test Freq. (MHz)</b>	5755
<b>Power Phase</b>	Line		

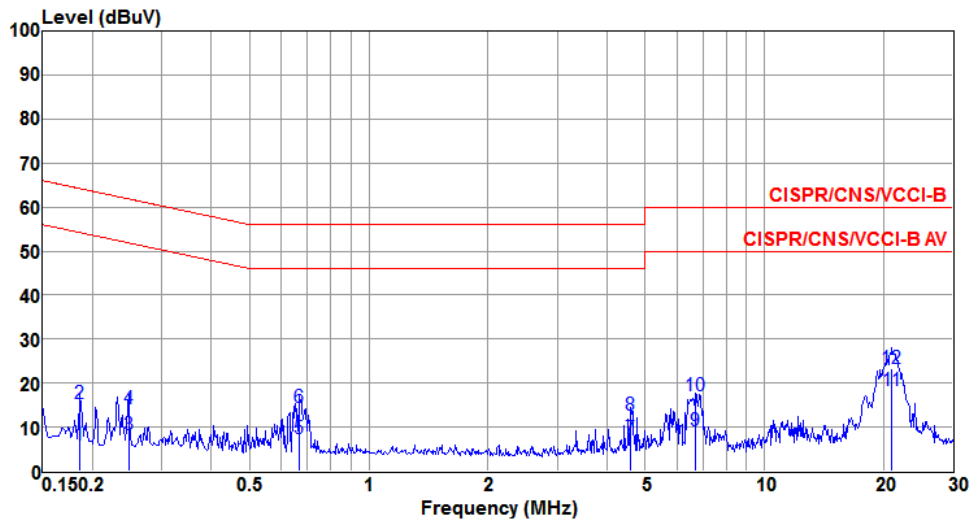

	Freq MHz	Level dBuV	Limit Line dBuV	Over Limit dB	Read Level dBuV	LISN factor dB	cable loss dB	Remark
1	0.186	5.82	54.20	-48.38	5.69	0.11	0.02	Average
2	0.186	15.24	64.20	-48.96	15.11	0.11	0.02	QP
3	0.247	8.35	51.86	-43.51	8.21	0.12	0.02	Average
4	0.247	14.05	61.86	-47.81	13.91	0.12	0.02	QP
5	0.668	7.50	46.00	-38.50	7.32	0.13	0.05	Average
6	0.668	14.37	56.00	-41.63	14.19	0.13	0.05	QP
7	4.598	7.47	46.00	-38.53	7.14	0.20	0.13	Average
8	4.598	12.72	56.00	-43.28	12.39	0.20	0.13	QP
9	6.698	9.21	50.00	-40.79	8.85	0.22	0.14	Average
10	6.698	17.01	60.00	-42.99	16.65	0.22	0.14	QP
11@	21.035	18.21	50.00	-31.79	17.64	0.38	0.19	Average
12	21.035	23.40	60.00	-36.60	22.83	0.38	0.19	QP

Note 1: Level (dBuV) = Read Level (dBuV) + LISN Factor (dB) + Cable Loss (dB).  
 2: Over Limit (dB) = Level (dBuV) – Limit Line (dBuV).

<b>Modulation</b>	VHT40	<b>Test Freq. (MHz)</b>	5755
<b>Power Phase</b>	Neutral		

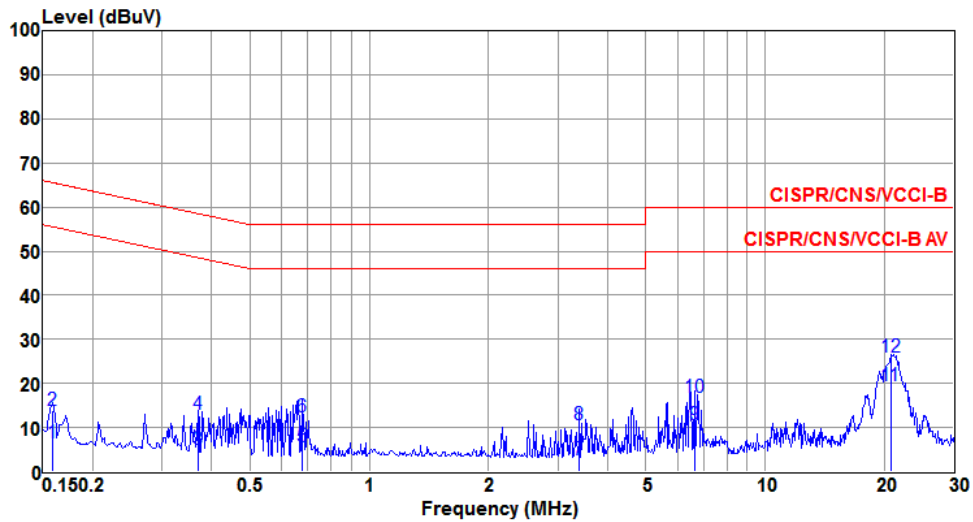

	Freq MHz	Level dBuV	Limit Line dBuV	Over Limit dB	Read Level dBuV	LISN factor dB	cable loss dB	Remark
1	0.159	6.58	55.52	-48.94	6.44	0.12	0.02	Average
2	0.159	13.96	65.52	-51.56	13.82	0.12	0.02	QP
3	0.369	5.08	48.52	-43.44	4.91	0.14	0.03	Average
4	0.369	12.87	58.52	-45.65	12.70	0.14	0.03	QP
5	0.675	5.51	46.00	-40.49	5.33	0.13	0.05	Average
6	0.675	12.51	56.00	-43.49	12.33	0.13	0.05	QP
7	3.399	2.73	46.00	-43.27	2.45	0.17	0.11	Average
8	3.399	10.62	56.00	-45.38	10.34	0.17	0.11	QP
9	6.627	10.53	50.00	-39.47	10.17	0.22	0.14	Average
10	6.627	16.74	60.00	-43.26	16.38	0.22	0.14	QP
11@	20.814	19.53	50.00	-30.47	18.94	0.41	0.18	Average
12	20.814	26.02	60.00	-33.98	25.43	0.41	0.18	QP

Note 1: Level (dBuV) = Read Level (dBuV) + LISN Factor (dB) + Cable Loss (dB).  
 2: Over Limit (dB) = Level (dBuV) – Limit Line (dBuV).

## 3.2 Emission Bandwidth

### 3.2.1 Limit of Emission bandwidth

Within the 5.725-5.85 GHz band, the minimum 6 dB bandwidth of U-NII devices shall be at least 500 kHz.

### 3.2.2 Test Procedures

#### 26dB Bandwidth

1. Set RBW = approximately 1% of the emission bandwidth.
2. Set the VBW > RBW, Detector = Peak.
3. Trace mode = max hold.
4. Measure the maximum width of the emission that is 26 dB down from the peak of the emission.

#### Occupied Bandwidth

1. Set RBW = 1 % to 5 % of the OBW
2. Set VBW  $\geq$  3 RBW
3. Sample detection and single sweep mode shall be used
4. Use the 99 % power bandwidth function of the instrument

#### 6dB Bandwidth

1. Set RBW = 100kHz, VBW = 300kHz
2. Detector = Peak, Trace mode = max hold.
3. Allow the trace to stabilize.
4. Measure the maximum width of the emission that is constrained by the frequencies associated with the two outermost amplitude points (upper and lower frequencies) that are attenuated by 6 dB relative to the maximum level measured in the fundamental emission

### 3.2.3 Test Setup

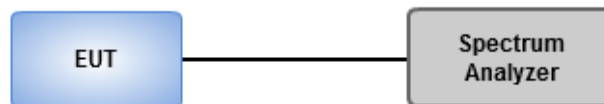

### 3.2.4 Test Result of Emission Bandwidth

For Frequency band 5150-5250 MHz										
Emission Bandwidth										
Mode	N <sub>TX</sub>	Freq. (MHz)	26dB Bandwidth (MHz)				99% Bandwidth (MHz)			
			Chain 0	Chain 1	Chain 2	Chain 3	Chain 0	Chain 1	Chain 2	Chain 3
11a	1	5180	20.35	---	---	---	16.68	---	---	---
11a	1	5200	20.35	---	---	---	16.74	---	---	---
11a	1	5240	20.41	---	---	---	16.75	---	---	---
VHT20	1	5180	20.23	---	---	---	17.57	---	---	---
VHT20	1	5200	20.41	---	---	---	17.58	---	---	---
VHT20	1	5240	20.29	---	---	---	17.57	---	---	---
VHT40	1	5190	41.62	---	---	---	36.14	---	---	---
VHT40	1	5230	41.51	---	---	---	36.18	---	---	---
VHT80	1	5210	81.39	---	---	---	75.32	---	---	---

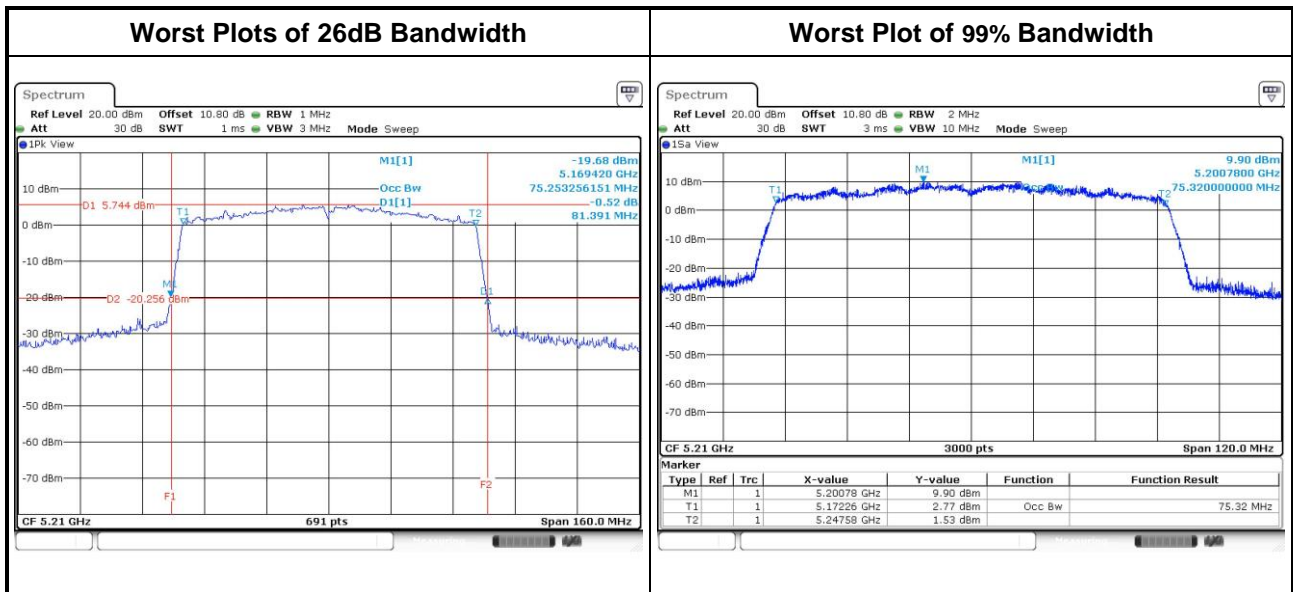

For Frequency band 5725-5850 MHz											
Emission Bandwidth											
Mode	N <sub>TX</sub>	Freq. (MHz)	OBW Bandwidth (MHz)				6dB Bandwidth (MHz)				6dB BW Limit (MHz)
			Chain 0	Chain 1	Chain 2	Chain 3	Chain 0	Chain 1	Chain 2	Chain 3	
11a	1	5745	16.76	---	---	---	15.07	---	---	---	0.5
11a	1	5785	16.76	---	---	---	13.86	---	---	---	0.5
11a	1	5825	16.80	---	---	---	15.13	---	---	---	0.5
VHT20	1	5745	17.58	---	---	---	15.13	---	---	---	0.5
VHT20	1	5785	17.58	---	---	---	15.07	---	---	---	0.5
VHT20	1	5825	17.58	---	---	---	15.13	---	---	---	0.5
VHT40	1	5755	36.14	---	---	---	35.13	---	---	---	0.5
VHT40	1	5795	36.18	---	---	---	35.13	---	---	---	0.5
VHT80	1	5775	75.20	---	---	---	75.13	---	---	---	0.5

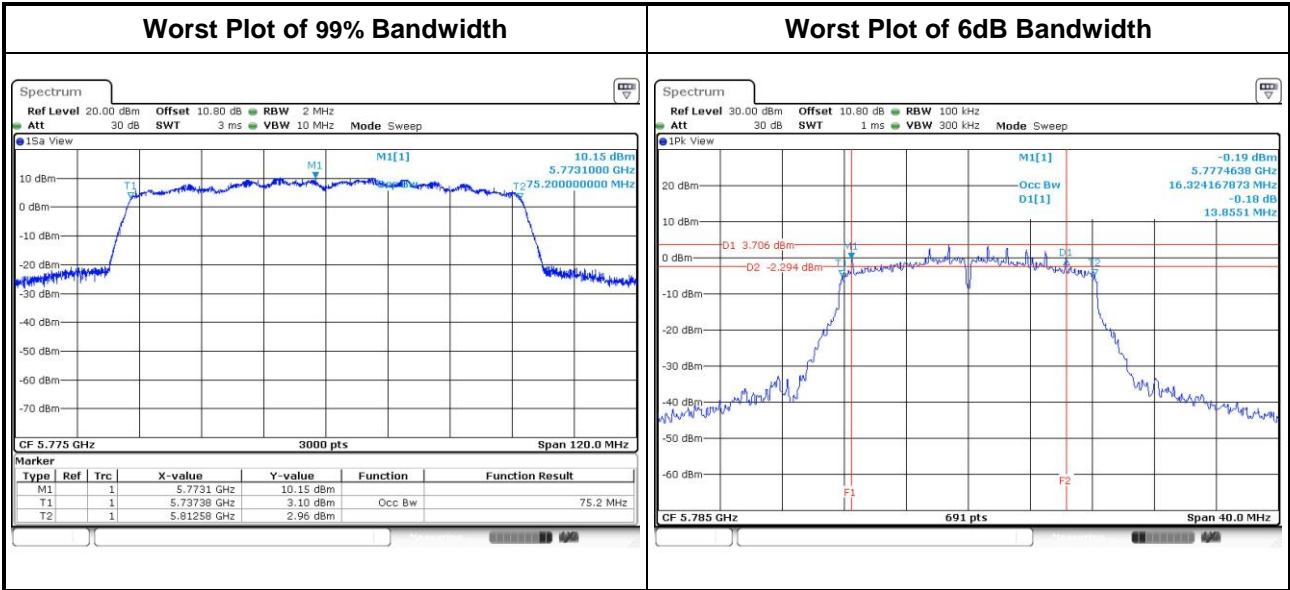

### 3.3 RF Output Power

#### 3.3.1 Limit of RF Output Power

Frequency band 5150-5250 MHz	
Operating Mode	Limit
<input type="checkbox"/> Outdoor access point	Conducted Power: 1 W The maximum e.i.r.p. at any elevation angle above 30 degrees as measured from the horizon must not exceed 125 mW (21 dBm)
<input type="checkbox"/> Indoor access point	Conducted Power: 1 W
<input type="checkbox"/> Fixed point-to-point access points	Conducted Power: 1 W
<input checked="" type="checkbox"/> Mobile and portable client devices	Conducted Power: 250 mW

Frequency Band (MHz)	Limit
<input type="checkbox"/> 5250 ~ 5350	250mW or 11dBm+10 log B
<input type="checkbox"/> 5470 ~ 5725	250mW or 11dBm+10 log B
<input checked="" type="checkbox"/> 5725 ~ 5850	1 W

Note: "B" is the 26dB emission bandwidth in MHz.

#### 3.3.2 Test Procedures

- Method PM-G ( Measurement using a gated RF average power meter )**
  - Measurements may is performed using a wideband gated RF power meter provided that the gate parameters are adjusted such that the power is measured only when the EUT is transmitting at its maximum power control level. Since the measurement is made only during the ON time of the transmitter, no duty cycle correction factor is required.

#### 3.3.3 Test Setup

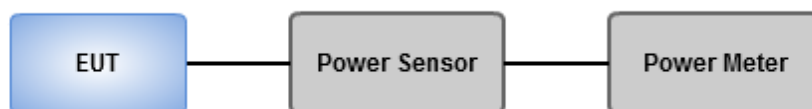



### 3.3.4 Test Result of Maximum Conducted Output Power

For Frequency band 5150-5250 MHz									
Mode	N <sub>TX</sub>	Freq. (MHz)	Conducted Power (dBm)				Total Power (mW)	Total Power (dBm)	Limit (dBm)
			Chain 0	Chain 1	Chain 2	Chain 3			
11a	1	5180	13.62	---	---	---	23.014	13.62	24.00
11a	1	5200	13.74	---	---	---	23.659	13.74	24.00
11a	1	5240	13.74	---	---	---	23.659	13.74	24.00
HT20	1	5180	13.54	---	---	---	22.594	13.54	24.00
HT20	1	5200	13.57	---	---	---	22.751	13.57	24.00
HT20	1	5240	13.52	---	---	---	22.491	13.52	24.00
HT40	1	5190	13.58	---	---	---	22.803	13.58	24.00
HT40	1	5230	13.64	---	---	---	23.121	13.64	24.00
VHT20	1	5180	13.58	---	---	---	22.803	13.58	24.00
VHT20	1	5200	13.61	---	---	---	22.961	13.61	24.00
VHT20	1	5240	13.58	---	---	---	22.803	13.58	24.00
VHT40	1	5190	13.64	---	---	---	23.121	13.64	24.00
VHT40	1	5230	13.72	---	---	---	23.550	13.72	24.00
VHT80	1	5210	13.9	---	---	---	24.547	<b>13.90</b>	24.00

For Frequency band 5725-5850 MHz									
Mode	N <sub>TX</sub>	Freq. (MHz)	Conducted Power (dBm)				Total Power (mW)	Total Power (dBm)	Limit (dBm)
			Chain 0	Chain 1	Chain 2	Chain 3			
11a	1	5745	13.82	---	---	---	24.099	13.82	30.00
11a	1	5785	13.63	---	---	---	23.067	13.63	30.00
11a	1	5825	13.78	---	---	---	23.878	13.78	30.00
HT20	1	5745	13.7	---	---	---	23.442	13.70	30.00
HT20	1	5785	13.74	---	---	---	23.659	13.74	30.00
HT20	1	5825	13.48	---	---	---	22.284	13.48	30.00
HT40	1	5755	13.82	---	---	---	24.099	13.82	30.00
HT40	1	5795	13.7	---	---	---	23.442	13.70	30.00
VHT20	1	5745	13.74	---	---	---	23.659	13.74	30.00
VHT20	1	5785	13.79	---	---	---	23.933	13.79	30.00
VHT20	1	5825	13.54	---	---	---	22.594	13.54	30.00
VHT40	1	5755	13.88	---	---	---	24.434	<b>13.88</b>	30.00
VHT40	1	5795	13.73	---	---	---	23.605	13.73	30.00
VHT80	1	5775	13.87	---	---	---	24.378	13.87	30.00

### 3.4 Peak Power Spectral Density

#### 3.4.1 Limit of Peak Power Spectral Density

Frequency band 5150-5250 MHz		
Operating Mode		Limit
<input type="checkbox"/>	Outdoor access point	17 dBm / MHz
<input type="checkbox"/>	Indoor access point	17 dBm / MHz
<input type="checkbox"/>	Fixed point-to-point access points	17 dBm / MHz
<input checked="" type="checkbox"/>	Mobile and portable client devices	11 dBm / MHz

Frequency Band (MHz)		Limit
<input type="checkbox"/>	5250 ~ 5350	11 dBm / MHz
<input type="checkbox"/>	5470 ~ 5725	11 dBm / MHz
<input checked="" type="checkbox"/>	5725 ~ 5850	30 dBm / 500 kHz

### 3.4.2 Test Procedures

#### For 5150 ~ 5250 MHz

Method SA-1

1. Set RBW = 1 MHz, VBW = 3 MHz, Sweep time = auto, Detector = RMS.
2. Trace average 100 traces.
3. Use the peak marker function to determine the maximum amplitude level.

Method SA-2 Alternative

1. Set RBW = 1 MHz, VBW = 3 MHz, Detector = RMS.
2. Set sweep time  $\geq 10 * (\text{number of points in sweep}) * (\text{total on/off period of the transmitted signal})$ .
3. Perform a single sweep.
4. Use the peak marker function to determine the maximum amplitude level.
5. Add  $10 \log(1/x)$ , where x is the duty cycle.

#### For 5725 ~ 5850 MHz

Method SA-1

1. Set RBW = 500 kHz, VBW = 2 MHz, Sweep time = auto, Detector = RMS.
2. Trace average 100 traces.
3. Use the peak marker function to determine the maximum amplitude level.

Method SA-2 Alternative

1. Set RBW = 500 kHz, VBW = 2 MHz, Detector = RMS.
2. Set sweep time  $\geq 10 * (\text{number of points in sweep}) * (\text{total on/off period of the transmitted signal})$ .
3. Perform a single sweep.
4. Use the peak marker function to determine the maximum amplitude level.
5. Add  $10 \log(1/x)$ , where x is the duty cycle.

### 3.4.3 Test Setup

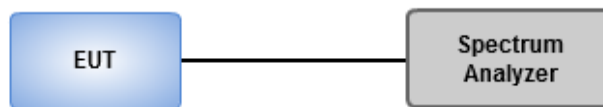

### 3.4.4 Test Result of Peak Power Spectral Density

For Frequency band 5150-5250 MHz						
Condition			Peak Power Spectral Density (dBm/MHz)			
Modulation Mode	N <sub>TX</sub>	Freq. (MHz)	PPSD w/o D.F (dBm/MHz)	Duty Factor (dB)	PPSD with D.F (dBm/MHz)	PPSD Limit (dBm/MHz)
11a	1	5180	1.75	0.28	2.03	11
11a	1	5200	1.61	0.28	1.89	11
11a	1	5240	1.83	0.28	2.11	11
VHT20	1	5180	1.51	0.26	1.77	11
VHT20	1	5200	1.47	0.26	1.73	11
VHT20	1	5240	1.44	0.26	1.70	11
VHT40	1	5190	-1.54	0.62	-0.92	11
VHT40	1	5230	-1.71	0.62	-1.09	11
VHT80	1	5210	-5.43	1.10	-4.33	11

Note: D.F is duty factor.

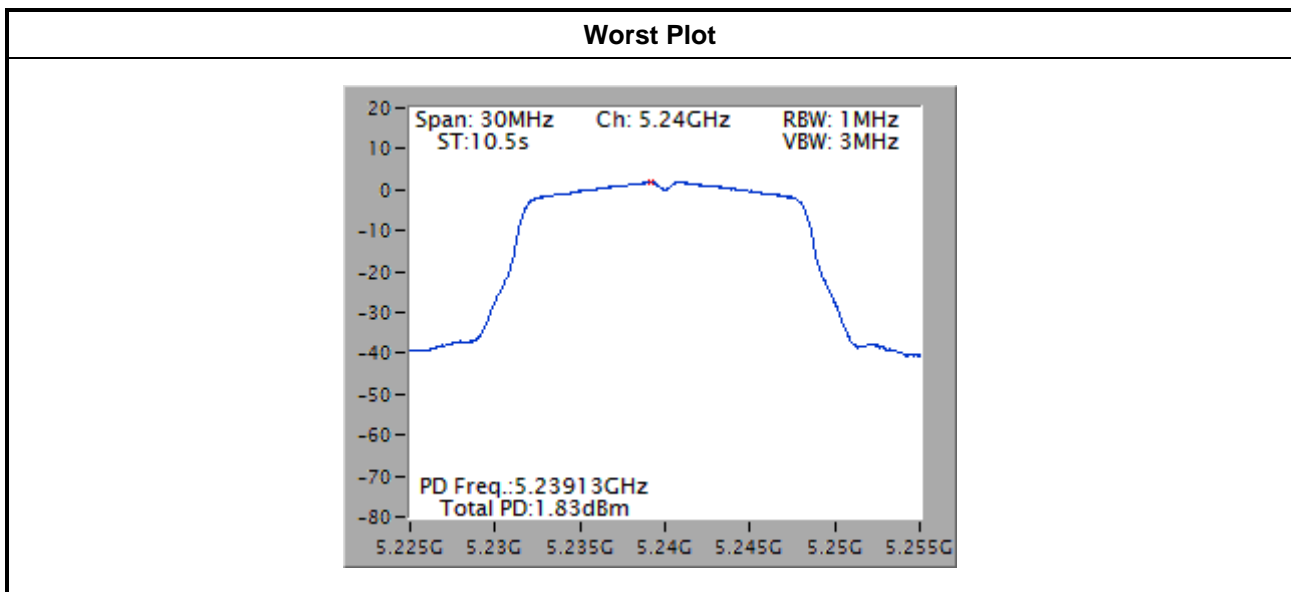

Note: The worst plot is without duty factor.

For Frequency band 5725-5850 MHz						
Condition			Peak Power Spectral Density (dBm/500kHz)			
Modulation Mode	N <sub>TX</sub>	Freq. (MHz)	PPSD w/o D.F (dBm/500kHz)	Duty Factor (dB)	PPSD with D.F (dBm/500kHz)	PPSD Limit (dBm/500kHz)
11a	1	5745	0.38	0.28	0.66	30
11a	1	5785	0.30	0.28	0.58	30
11a	1	5825	0.27	0.28	0.55	30
VHT20	1	5745	0.06	0.26	0.32	30
VHT20	1	5785	-0.02	0.26	0.24	30
VHT20	1	5825	-0.05	0.26	0.21	30
VHT40	1	5755	-3.05	0.62	-2.43	30
VHT40	1	5795	-3.14	0.62	-2.52	30
VHT80	1	5775	-6.93	1.10	-5.83	30

**Note:** D.F is duty factor.

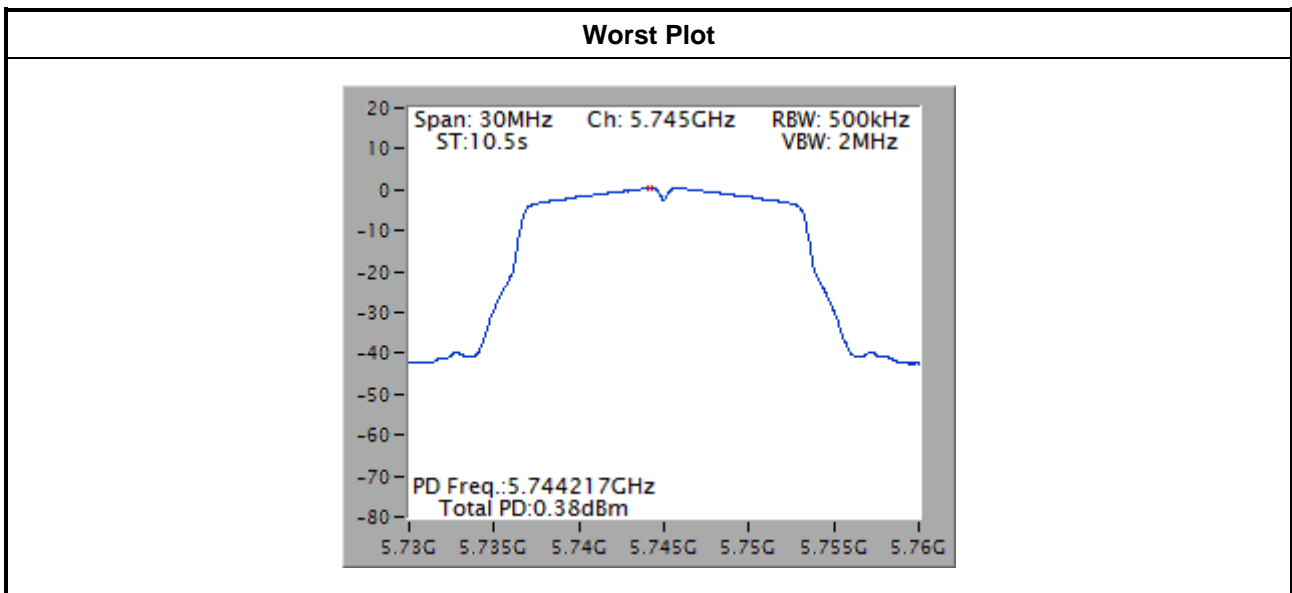

**Note:** The worst plot is without duty factor.

### 3.5 Transmitter Radiated and Band Edge Emissions

#### 3.5.1 Limit of Transmitter Radiated and Band Edge Emissions

Restricted Band Emissions Limit			
Frequency Range (MHz)	Field Strength (uV/m)	Field Strength (dBuV/m)	Measure Distance (m)
0.009~0.490	2400/F(kHz)	48.5 - 13.8	300
0.490~1.705	24000/F(kHz)	33.8 - 23	30
1.705~30.0	30	29	30
30~88	100	40	3
88~216	150	43.5	3
216~960	200	46	3
Above 960	500	54	3

**Note 1:**  
Qusai-Peak value is measured for frequency below 1GHz except for 9–90 kHz, 110–490 kHz frequency band. Peak and average value are measured for frequency above 1GHz. The limit on average radio frequency emission is as above table. The limit on peak radio frequency emissions is 20 dB above the maximum permitted average emission limit

**Note 2:**  
Measurements may be performed at a distance other than what is specified provided. When performing measurements at a distance other than that specified, the results shall be extrapolated to the specified distance using an extrapolation factor as below, Frequency at or above 30 MHz: 20 dB/decade Frequency below 30 MHz: 40 dB/decade.

Un-restricted band emissions above 1GHz Limit	
Operating Band	Limit
5.15 - 5.25 GHz	e.i.r.p. -27 dBm [68.2 dBuV/m@3m]
5.725 - 5.850 GHz	5.715 5.725 GHz: e.i.r.p. -17 dBm [78.2 dBuV/m@3m] 5.85 5.86 GHz: e.i.r.p. -17 dBm [78.2 dBuV/m@3m] Other un-restricted band: e.i.r.p. -27 dBm [68.2 dBuV/m@3m]

Note 1: Measurements may be performed at a distance other than the limit distance provided they are not performed in the near field and the emissions to be measured can be detected by the measurement equipment. When performing measurements at a distance other than that specified, the results shall be extrapolated to the specified distance using an extrapolation factor of 20 dB/decade (inverse of linear distance for field-strength measurements, inverse of linear distance-squared for power-density measurements).

### 3.5.2 Test Procedures

1. Measurement is made at a semi-anechoic chamber that incorporates a turntable allowing a EUT rotation of 360°. A continuously-rotating, remotely-controlled turntable is installed at the test site to support the EUT and facilitate determination of the direction of maximum radiation for each EUT emission frequency. The EUT is placed at test table. For emissions testing at or below 1 GHz, the table height is 80 cm above the reference ground plane. For emission measurements above 1 GHz, the table height is 1.5 m
2. Measurement is made with the antenna positioned in both the horizontal and vertical planes of polarization. The measurement antenna is varied in height (1m ~ 4m) above the reference ground plane to obtain the maximum signal strength. Distance between EUT and antenna is 3 m.
3. This investigation is performed with the EUT rotated 360°, the antenna height scanned between 1 m and 4 m, and the antenna rotated to repeat the measurements for both the horizontal and vertical antenna polarizations.

Note:

1. 120kHz measurement bandwidth of test receiver and Quasi-peak detector is for radiated emission below 1GHz.
2. RBW=1MHz, VBW=3MHz and Peak detector is for peak measured value of radiated emission above 1GHz.
3. RBW=1MHz, VBW=1/T and Peak detector is for average measured value of radiated emission above 1GHz.

### 3.5.3 Test Setup

#### Radiated Emissions below 1 GHz

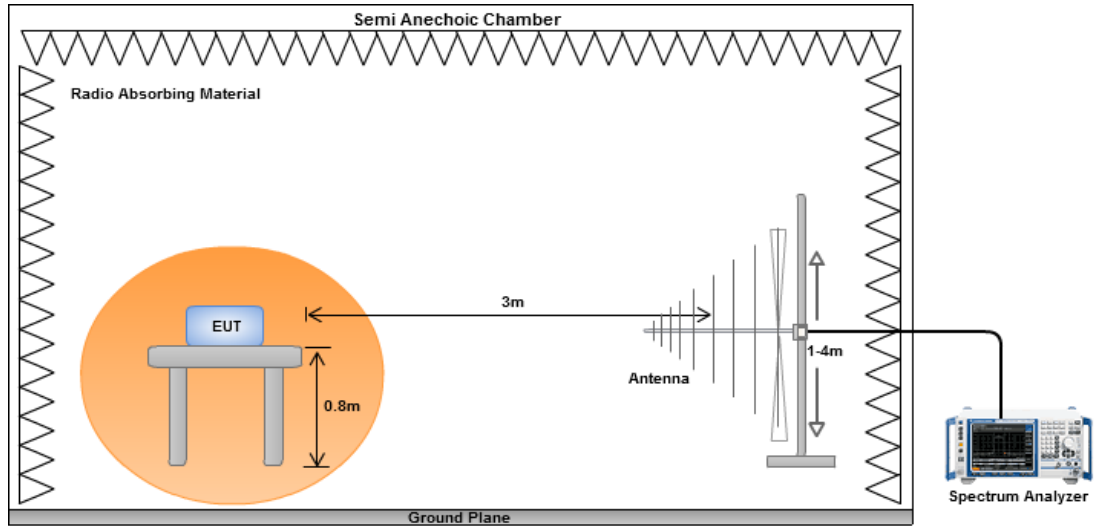

#### Radiated Emissions above 1 GHz

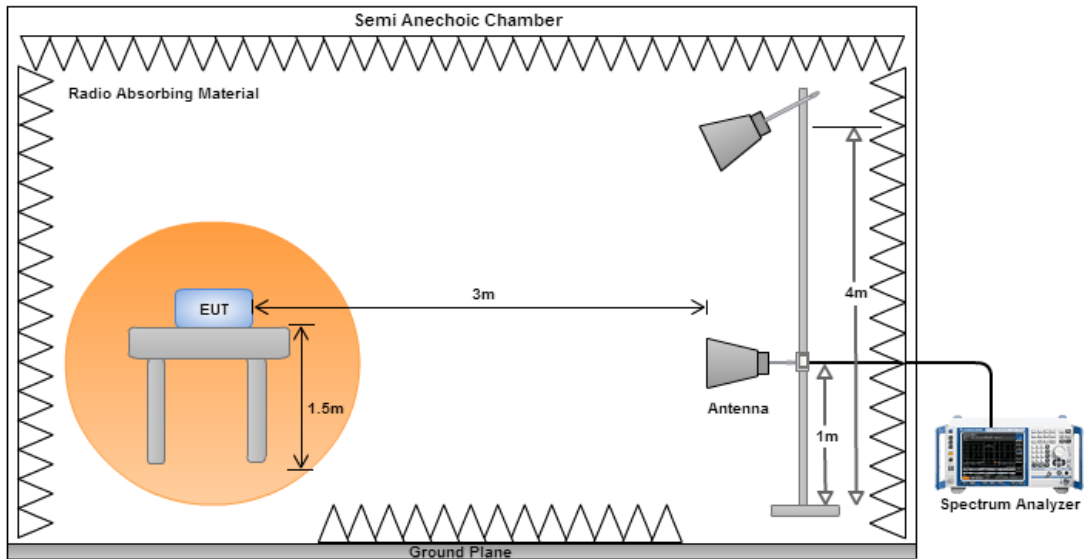



### 3.5.4 Transmitter Radiated Unwanted Emissions (Below 1GHz)

Configuration 1: Antenna cable length: 400mm

Modulation	VHT80	Test Freq. (MHz)	5210
Polarization	Horizontal		

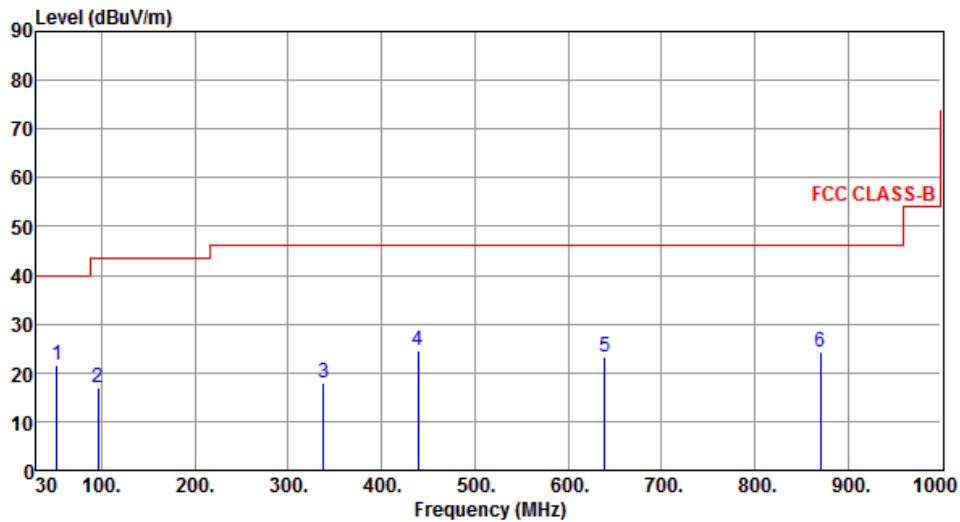

	Freq. MHz	Emission level dBuV/m	Limit dBuV/m	Margin dB	SA reading dBuV	Factor dB	Remark	ANT High cm	Turn Table deg
1	52.31	21.48	40.00	-18.52	38.11	-16.63	Peak	---	---
2	95.96	17.09	43.50	-26.41	39.08	-21.99	Peak	---	---
3	337.49	18.07	46.00	-27.93	33.12	-15.05	Peak	---	---
4	439.34	24.73	46.00	-21.27	37.16	-12.43	Peak	---	---
5	639.16	23.21	46.00	-22.79	32.06	-8.85	Peak	---	---
6	870.99	24.41	46.00	-21.59	30.01	-5.60	Peak	---	---

Note 1: Emission Level (dBuV/m) = SA Reading (dBuV/m) + Factor\* (dB)

\*Factor includes antenna factor, cable loss and amplifier gain

Note 2: Margin (dB) = Emission level (dBuV/m) – Limit (dBuV/m).

Note 3: All spurious emissions below 30MHz are more than 20 dB below the limit.

<b>Modulation</b>	VHT80	<b>Test Freq. (MHz)</b>	5210
<b>Polarization</b>	Vertical		

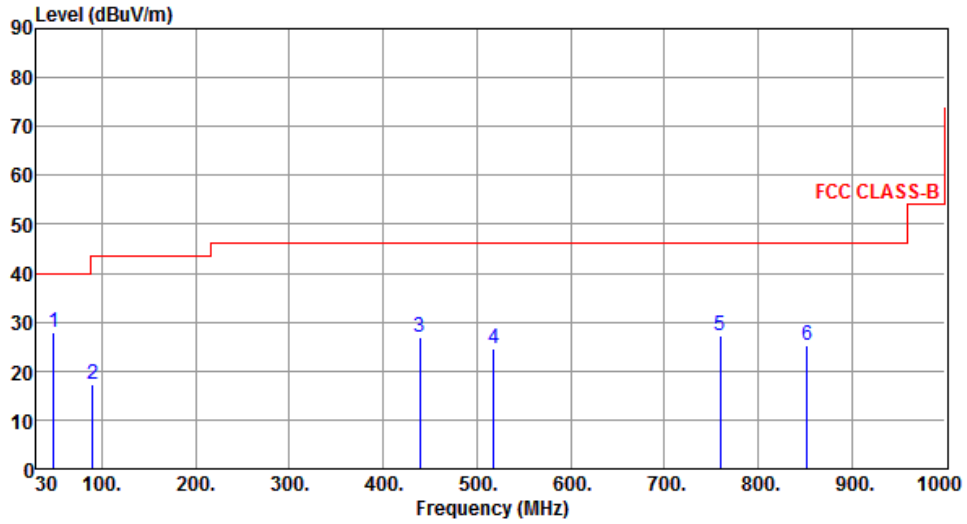

	Freq. MHz	Emission level dBuV/m	Limit dBuV/m	Margin dB	SA reading dBuV	Factor dB	Remark	ANT High cm	Turn Table deg
1	48.43	27.90	40.00	-12.10	44.24	-16.34	Peak	---	---
2	90.14	17.21	43.50	-26.29	40.18	-22.97	Peak	---	---
3	439.34	26.89	46.00	-19.11	39.32	-12.43	Peak	---	---
4	517.91	24.67	46.00	-21.33	35.57	-10.90	Peak	---	---
5	759.44	27.11	46.00	-18.89	33.96	-6.85	Peak	---	---
6	852.56	25.39	46.00	-20.61	31.24	-5.85	Peak	---	---

Note 1: Emission Level (dBuV/m) = SA Reading (dBuV/m) + Factor\* (dB)

\*Factor includes antenna factor , cable loss and amplifier gain

Note 2: Margin (dB) = Emission level (dBuV/m) – Limit (dBuV/m).

Note 3: All spurious emissions below 30MHz are more than 20 dB below the limit.

<b>Modulation</b>	VHT40	<b>Test Freq. (MHz)</b>	5755
<b>Polarization</b>	Horizontal		

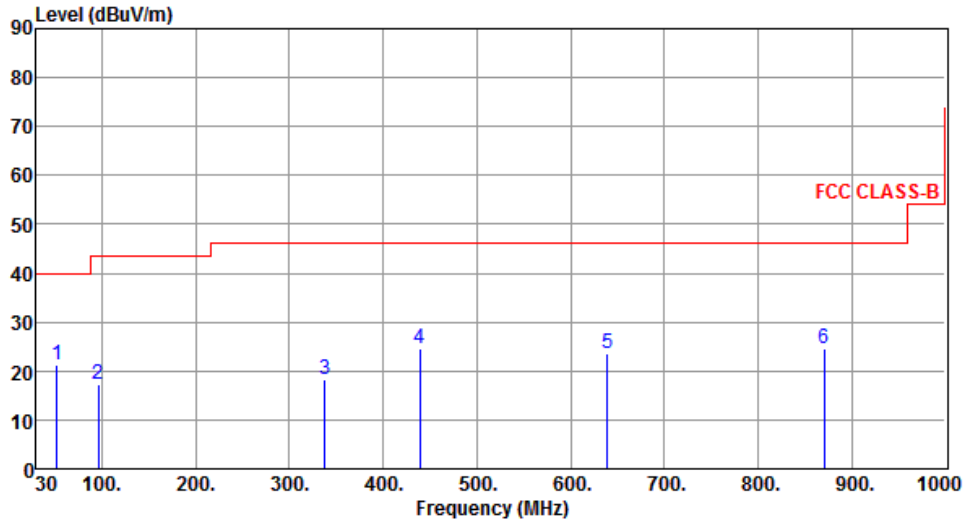

	Freq. MHz	Emission level dBuV/m	Limit dBuV/m	Margin dB	SA reading dBuV	Factor dB	Remark	ANT High cm	Turn Table deg
1	52.31	21.39	40.00	-18.61	38.02	-16.63	Peak	---	---
2	95.96	17.16	43.50	-26.34	39.15	-21.99	Peak	---	---
3	337.49	18.21	46.00	-27.79	33.26	-15.05	Peak	---	---
4	439.34	24.59	46.00	-21.41	37.02	-12.43	Peak	---	---
5	639.16	23.42	46.00	-22.58	32.27	-8.85	Peak	---	---
6	870.99	24.59	46.00	-21.41	30.19	-5.60	Peak	---	---

Note 1: Emission Level (dBuV/m) = SA Reading (dBuV/m) + Factor\* (dB)

\*Factor includes antenna factor , cable loss and amplifier gain

Note 2: Margin (dB) = Emission level (dBuV/m) – Limit (dBuV/m).

Note 3: All spurious emissions below 30MHz are more than 20 dB below the limit.

<b>Modulation</b>	VHT40	<b>Test Freq. (MHz)</b>	5755
<b>Polarization</b>	Vertical		

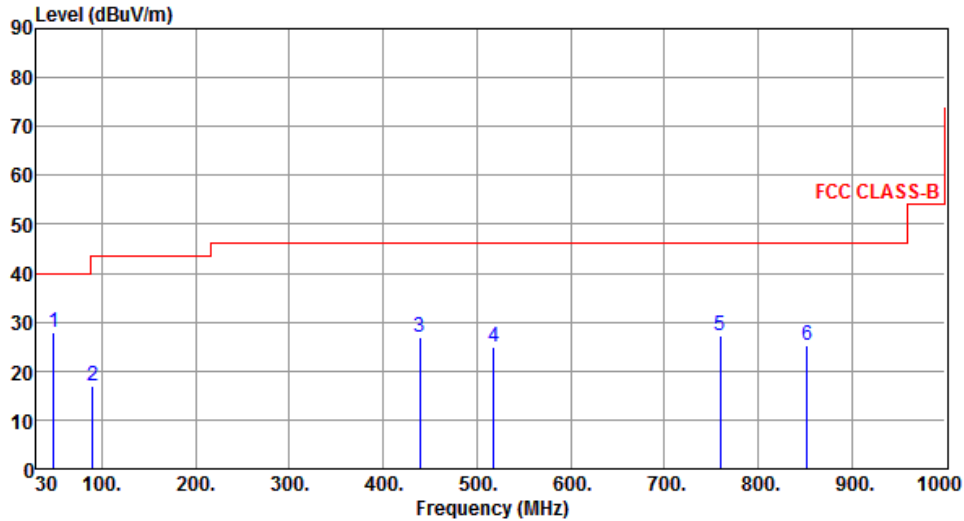

	Freq. MHz	Emission level dBuV/m	Limit dBuV/m	Margin dB	SA reading dBuV	Factor dB	Remark	ANT High cm	Turn Table deg
1	48.43	27.81	40.00	-12.19	44.15	-16.34	Peak	---	---
2	90.14	17.05	43.50	-26.45	40.02	-22.97	Peak	---	---
3	439.34	26.74	46.00	-19.26	39.17	-12.43	Peak	---	---
4	517.91	24.86	46.00	-21.14	35.76	-10.90	Peak	---	---
5	759.44	27.39	46.00	-18.61	34.24	-6.85	Peak	---	---
6	852.56	25.11	46.00	-20.89	30.96	-5.85	Peak	---	---

Note 1: Emission Level (dBuV/m) = SA Reading (dBuV/m) + Factor\* (dB)

\*Factor includes antenna factor , cable loss and amplifier gain

Note 2: Margin (dB) = Emission level (dBuV/m) – Limit (dBuV/m).

Note 3: All spurious emissions below 30MHz are more than 20 dB below the limit.

**Configuration 2: Antenna cable length: 900mm**

<b>Modulation</b>	VHT80	<b>Test Freq. (MHz)</b>	5210
<b>Polarization</b>	Horizontal		

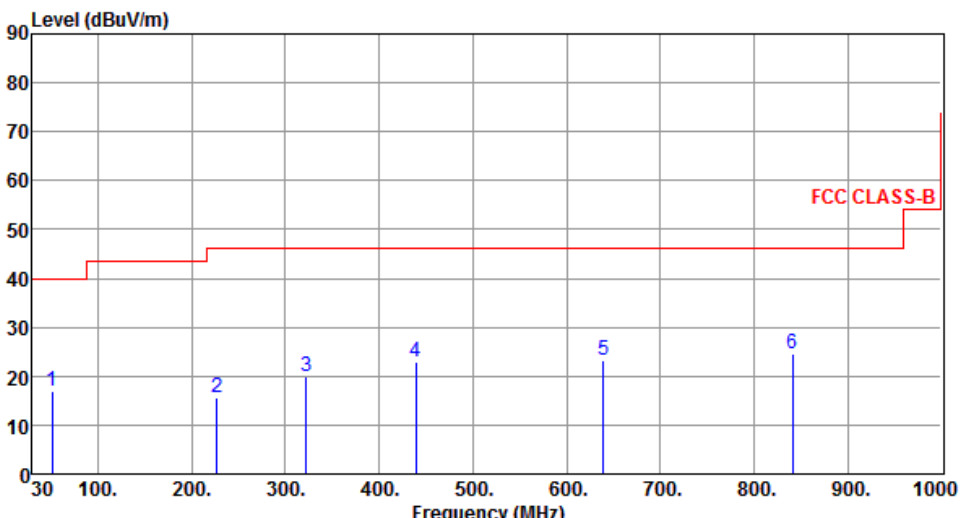

The graph plots Level (dBuV/m) on the y-axis (0 to 90) against Frequency (MHz) on the x-axis (30 to 1000). A red step function represents the FCC CLASS-B limit, starting at 40 dBuV/m from 30 MHz to 100 MHz, rising to 45 dBuV/m from 100 MHz to 200 MHz, and then to 55 dBuV/m from 200 MHz to 1000 MHz. Six blue vertical lines indicate peak emissions at 51.34 MHz (1), 226.91 MHz (2), 321.97 MHz (3), 439.34 MHz (4), 639.16 MHz (5), and 840.92 MHz (6). All peaks are well below the 55 dBuV/m limit.

	Freq. MHz	Emission level dBuV/m	Limit dBuV/m	Margin dB	SA reading dBuV	Factor dB	Remark	ANT High cm	Turn Table deg
1	51.34	16.94	46.00	-23.06	33.46	-16.52	Peak	---	---
2	226.91	15.45	46.00	-30.55	34.16	-18.71	Peak	---	---
3	321.97	19.95	46.00	-26.05	35.29	-15.34	Peak	---	---
4	439.34	22.81	46.00	-23.19	35.24	-12.43	Peak	---	---
5	639.16	23.16	46.00	-22.84	32.01	-8.85	Peak	---	---
6	840.92	24.47	46.00	-21.53	30.47	-6.00	Peak	---	---

Note 1: Emission Level (dBuV/m) = SA Reading (dBuV/m) + Factor\* (dB)  
\*Factor includes antenna factor , cable loss and amplifier gain  
Note 2: Margin (dB) = Emission level (dBuV/m) – Limit (dBuV/m).  
Note 3: All spurious emissions below 30MHz are more than 20 dB below the limit.

<b>Modulation</b>	VHT80	<b>Test Freq. (MHz)</b>	5210
<b>Polarization</b>	Vertical		

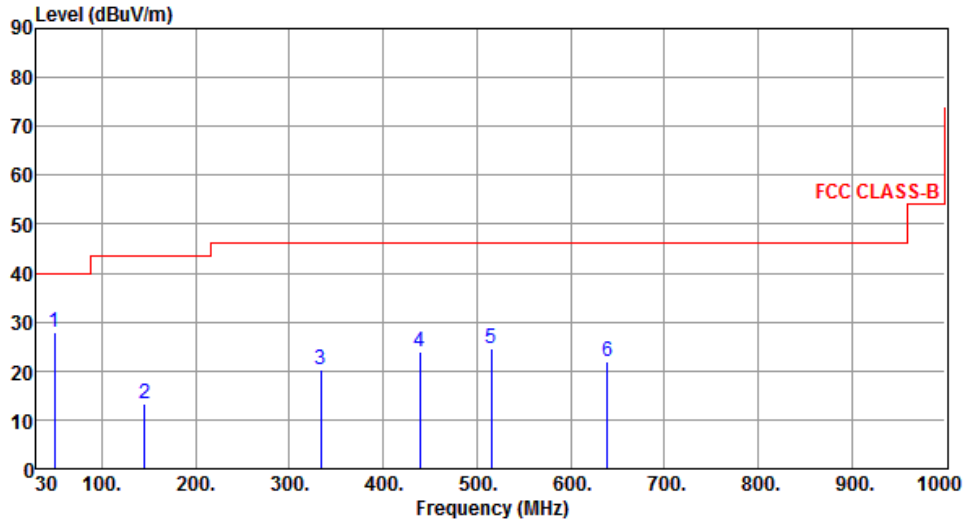

	Freq. MHz	Emission level dBuV/m	Limit dBuV/m	Margin dB	SA reading dBuV	Factor dB	Remark	ANT High cm	Turn Table deg
1	49.40	27.86	40.00	-12.14	44.21	-16.35	Peak	---	---
2	145.43	13.28	43.50	-30.22	30.12	-16.84	Peak	---	---
3	333.61	20.40	46.00	-25.60	35.53	-15.13	Peak	---	---
4	439.34	23.91	46.00	-22.09	36.34	-12.43	Peak	---	---
5	515.00	24.60	46.00	-21.40	35.52	-10.92	Peak	---	---
6	639.16	22.06	46.00	-23.94	30.91	-8.85	Peak	---	---

Note 1: Emission Level (dBuV/m) = SA Reading (dBuV/m) + Factor\* (dB)

\*Factor includes antenna factor, cable loss and amplifier gain

Note 2: Margin (dB) = Emission level (dBuV/m) – Limit (dBuV/m).

Note 3: All spurious emissions below 30MHz are more than 20 dB below the limit.

<b>Modulation</b>	VHT40	<b>Test Freq. (MHz)</b>	5755
<b>Polarization</b>	Horizontal		

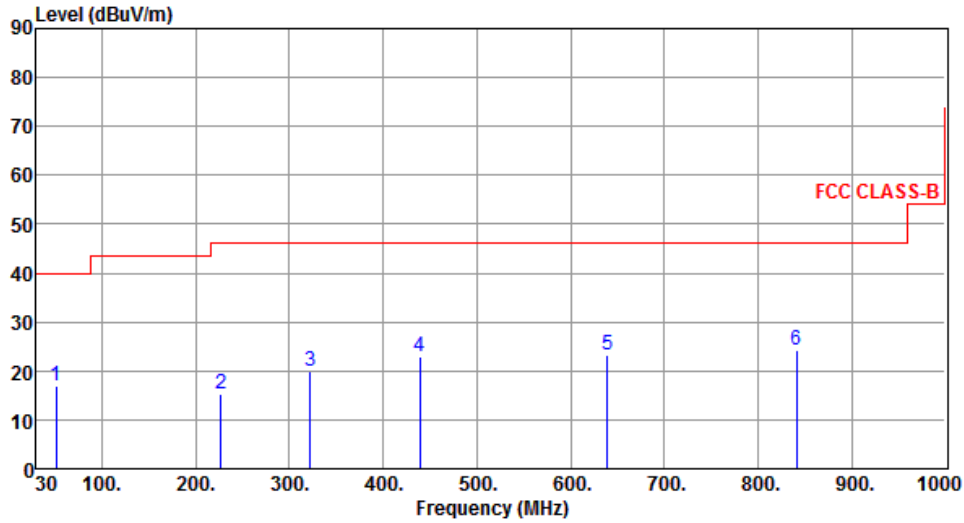

	Freq. MHz	Emission level dBuV/m	Limit dBuV/m	Margin dB	SA reading dBuV	Factor dB	Remark	ANT High cm	Turn Table deg
1	51.34	16.87	40.00	-23.13	33.39	-16.52	Peak	---	---
2	226.91	15.20	46.00	-30.80	33.91	-18.71	Peak	---	---
3	321.97	19.86	46.00	-26.14	35.20	-15.34	Peak	---	---
4	439.34	22.91	46.00	-23.09	35.34	-12.43	Peak	---	---
5	639.16	23.32	46.00	-22.68	32.17	-8.85	Peak	---	---
6	840.92	24.33	46.00	-21.67	30.33	-6.00	Peak	---	---

Note 1: Emission Level (dBuV/m) = SA Reading (dBuV/m) + Factor\* (dB)

\*Factor includes antenna factor , cable loss and amplifier gain

Note 2: Margin (dB) = Emission level (dBuV/m) – Limit (dBuV/m).

Note 3: All spurious emissions below 30MHz are more than 20 dB below the limit.

<b>Modulation</b>	VHT40	<b>Test Freq. (MHz)</b>	5755
<b>Polarization</b>	Vertical		

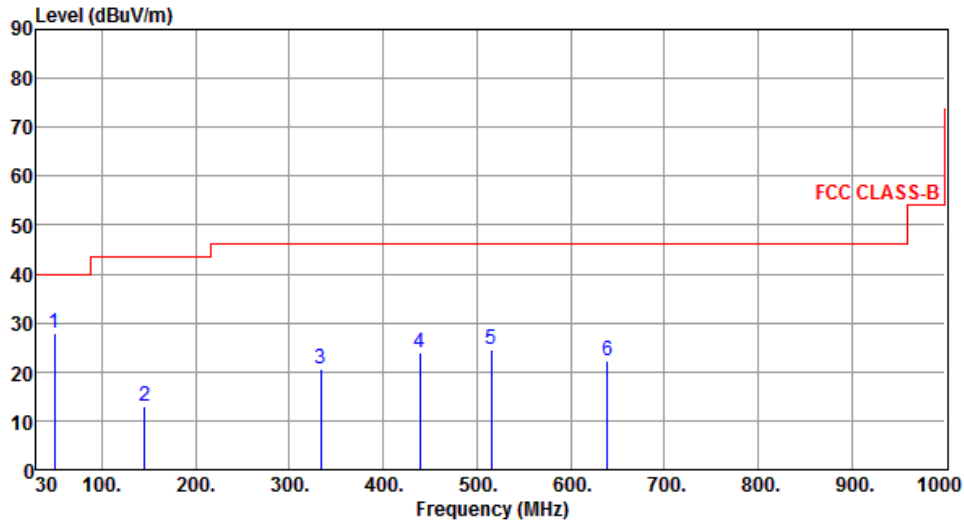

	Freq. MHz	Emission level dBuV/m	Limit dBuV/m	Margin dB	SA reading dBuV	Factor dB	Remark	ANT High cm	Turn Table deg
1	49.40	27.78	40.00	-12.22	44.13	-16.35	Peak	---	---
2	145.43	13.11	43.50	-30.39	29.95	-16.84	Peak	---	---
3	333.61	20.48	46.00	-25.52	35.61	-15.13	Peak	---	---
4	439.34	23.80	46.00	-22.20	36.23	-12.43	Peak	---	---
5	515.00	24.44	46.00	-21.56	35.36	-10.92	Peak	---	---
6	639.16	22.21	46.00	-23.79	31.06	-8.85	Peak	---	---

Note 1: Emission Level (dBuV/m) = SA Reading (dBuV/m) + Factor\* (dB)

\*Factor includes antenna factor , cable loss and amplifier gain

Note 2: Margin (dB) = Emission level (dBuV/m) – Limit (dBuV/m).

Note 3: All spurious emissions below 30MHz are more than 20 dB below the limit.

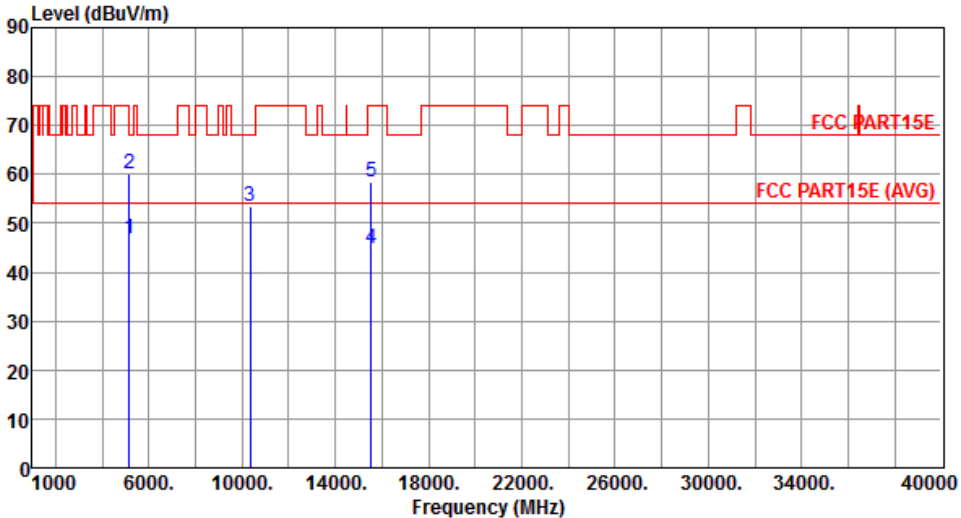

### 3.5.5 Transmitter Radiated Unwanted Emissions (Above 1GHz) for 11a

Modulation	11a	Test Freq. (MHz)	5180						
Polarization	Horizontal								
									
	Freq. MHz	Emission level dBuV/m	Limit dBuV/m	Margin dB	SA reading dBuV	Factor dB	Remark	ANT High cm	Turn Table deg
1	5150.00	46.69	54.00	-7.31	40.60	6.09	Average	100	207
2	5150.00	60.26	74.00	-13.74	54.17	6.09	Peak	100	207
3	10360.00	53.32	68.20	-14.88	40.26	13.06	Peak	106	228
4	15540.00	44.91	54.00	-9.09	30.06	14.85	Average	100	168
5	15540.00	58.38	74.00	-15.62	43.53	14.85	Peak	100	168
<p>Note 1: Emission Level (dBuV/m) = SA Reading (dBuV/m) + Factor* (dB)            *Factor includes antenna factor , cable loss and amplifier gain            Note 2: Margin (dB) = Emission level (dBuV/m) – Limit (dBuV/m).</p>									

<b>Modulation</b>	11a	<b>Test Freq. (MHz)</b>	5180
<b>Polarization</b>	Vertical		

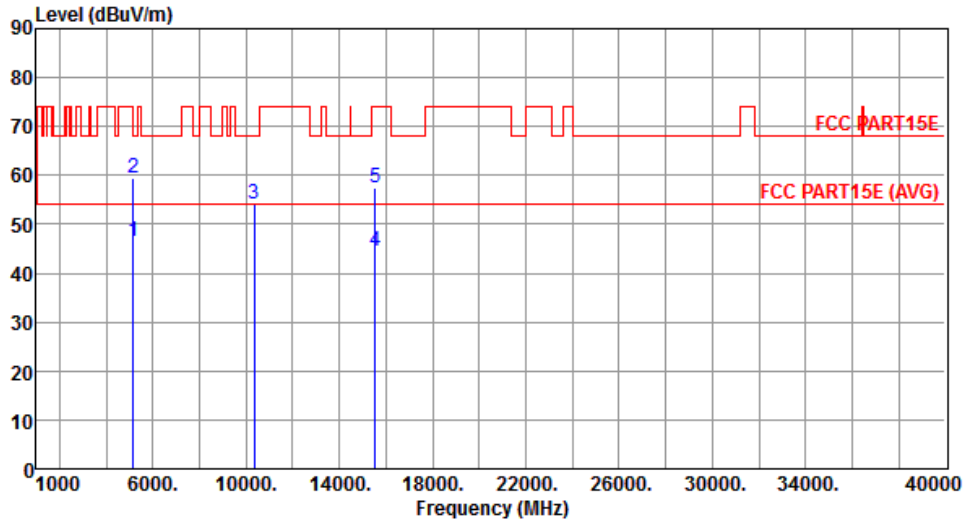

	Freq. MHz	Emission level dBuV/m	Limit dBuV/m	Margin dB	SA reading dBuV	Factor dB	Remark	ANT High cm	Turn Table deg
1	5150.00	46.35	54.00	-7.65	40.26	6.09	Average	384	131
2	5150.00	59.60	74.00	-14.40	53.51	6.09	Peak	384	131
3	10360.00	54.05	68.20	-14.15	40.99	13.06	Peak	100	315
4	15540.00	44.53	54.00	-9.47	29.68	14.85	Average	112	198
5	15540.00	57.30	74.00	-16.70	42.45	14.85	Peak	112	198

Note 1: Emission Level (dBuV/m) = SA Reading (dBuV/m) + Factor\* (dB)

\*Factor includes antenna factor , cable loss and amplifier gain

Note 2: Margin (dB) = Emission level (dBuV/m) – Limit (dBuV/m).

<b>Modulation</b>	11a	<b>Test Freq. (MHz)</b>	5200
<b>Polarization</b>	Horizontal		

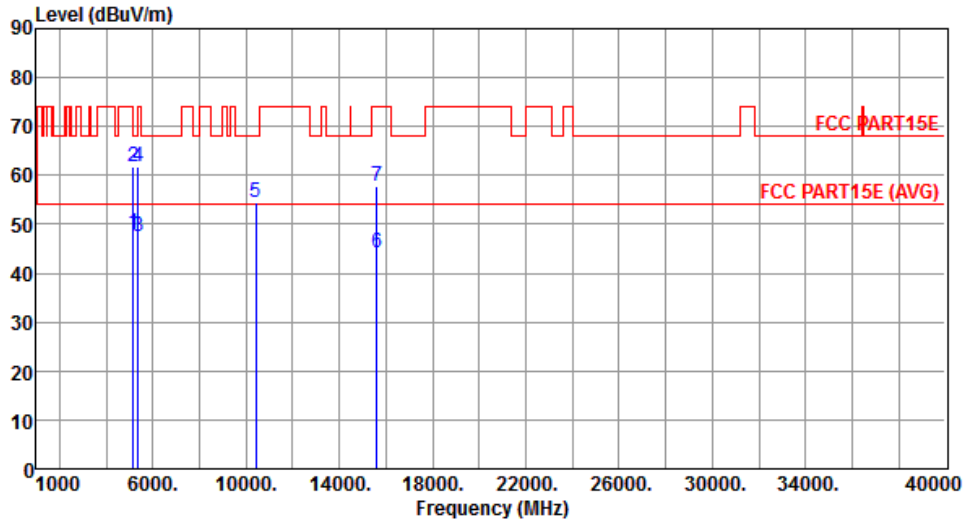

	Freq. MHz	Emission level dBuV/m	Limit dBuV/m	Margin dB	SA reading dBuV	Factor dB	Remark	ANT High cm	Turn Table deg
1	5150.00	48.20	54.00	-5.80	42.11	6.09	Average	100	192
2	5150.00	61.62	74.00	-12.38	55.53	6.09	Peak	100	192
3	5350.00	47.41	54.00	-6.59	40.96	6.45	Average	100	192
4	5350.00	61.93	74.00	-12.07	55.48	6.45	Peak	100	192
5	10400.00	54.36	68.20	-13.84	41.26	13.10	Peak	100	263
6	15600.00	44.19	54.00	-9.81	29.37	14.82	Average	100	193
7	15600.00	57.88	74.00	-16.12	43.06	14.82	Peak	100	193

Note 1: Emission Level (dBuV/m) = SA Reading (dBuV/m) + Factor\* (dB)

\*Factor includes antenna factor , cable loss and amplifier gain

Note 2: Margin (dB) = Emission level (dBuV/m) – Limit (dBuV/m).

<b>Modulation</b>	11a	<b>Test Freq. (MHz)</b>	5200
<b>Polarization</b>	Vertical		

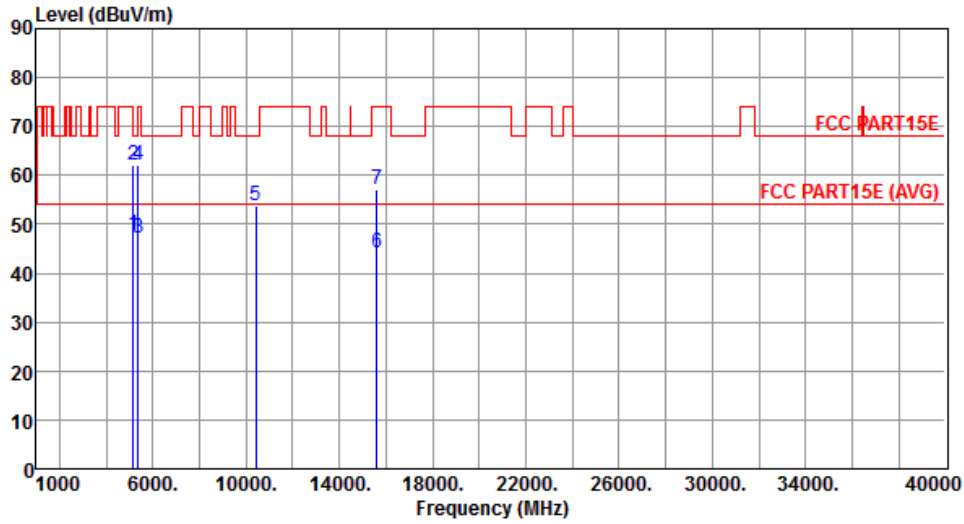

	Freq. MHz	Emission level dBuV/m	Limit dBuV/m	Margin dB	SA reading dBuV	Factor dB	Remark	ANT High cm	Turn Table deg
1	5150.00	47.94	54.00	-6.06	41.85	6.09	Average	105	248
2	5150.00	62.19	74.00	-11.81	56.10	6.09	Peak	105	248
3	5350.00	47.19	54.00	-6.81	40.74	6.45	Average	105	248
4	5350.00	61.99	74.00	-12.01	55.54	6.45	Peak	105	248
5	10400.00	53.92	68.20	-14.28	40.82	13.10	Peak	100	129
6	15600.00	44.21	54.00	-9.79	29.39	14.82	Average	105	165
7	15600.00	57.01	74.00	-16.99	42.19	14.82	Peak	105	165

Note 1: Emission Level (dBuV/m) = SA Reading (dBuV/m) + Factor\* (dB)

\*Factor includes antenna factor , cable loss and amplifier gain

Note 2: Margin (dB) = Emission level (dBuV/m) – Limit (dBuV/m).

<b>Modulation</b>	11a	<b>Test Freq. (MHz)</b>	5240
<b>Polarization</b>	Horizontal		

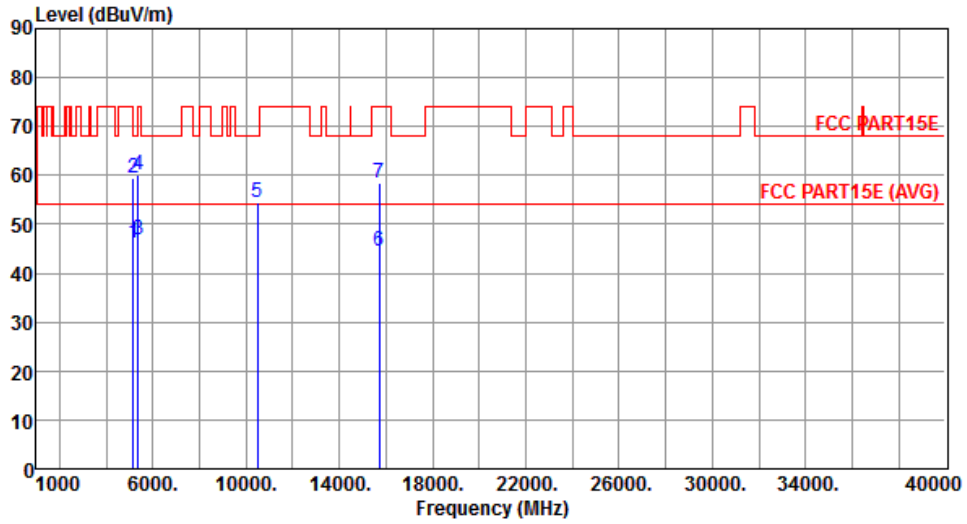

	Freq. MHz	Emission level dBuV/m	Limit dBuV/m	Margin dB	SA reading dBuV	Factor dB	Remark	ANT High cm	Turn Table deg
1	5150.00	46.09	54.00	-7.91	40.00	6.09	Average	100	10
2	5150.00	59.30	74.00	-14.70	53.21	6.09	Peak	100	10
3	5350.00	46.81	54.00	-7.19	40.36	6.45	Average	100	6
4	5350.00	60.23	74.00	-13.77	53.78	6.45	Peak	100	6
5	10480.00	54.38	68.20	-13.82	41.23	13.15	Peak	116	135
6	15720.00	44.45	54.00	-9.55	29.66	14.79	Average	100	305
7	15720.00	58.30	74.00	-15.70	43.51	14.79	Peak	100	305

Note 1: Emission Level (dBuV/m) = SA Reading (dBuV/m) + Factor\* (dB)

\*Factor includes antenna factor , cable loss and amplifier gain

Note 2: Margin (dB) = Emission level (dBuV/m) – Limit (dBuV/m).

<b>Modulation</b>	11a	<b>Test Freq. (MHz)</b>	5240
<b>Polarization</b>	Vertical		

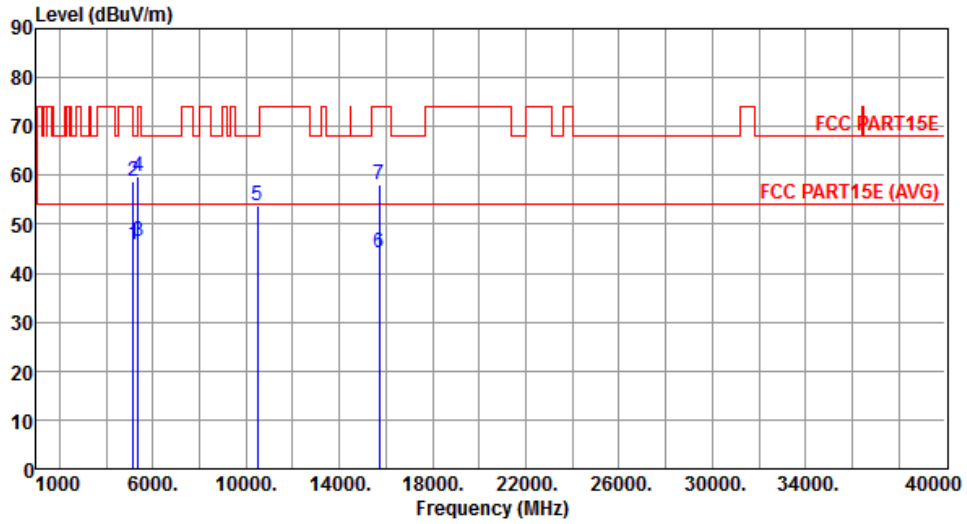

	Freq. MHz	Emission level dBuV/m	Limit dBuV/m	Margin dB	SA reading dBuV	Factor dB	Remark	ANT High cm	Turn Table deg
1	5150.00	45.85	54.00	-8.15	39.76	6.09	Average	334	105
2	5150.00	58.76	74.00	-15.24	52.67	6.09	Peak	334	105
3	5350.00	46.61	54.00	-7.39	40.16	6.45	Average	334	105
4	5350.00	59.68	74.00	-14.32	53.23	6.45	Peak	334	105
5	10480.00	53.76	68.20	-14.44	40.61	13.15	Peak	100	336
6	15720.00	44.14	54.00	-9.86	29.35	14.79	Average	116	207
7	15720.00	58.06	74.00	-15.94	43.27	14.79	Peak	116	207

Note 1: Emission Level (dBuV/m) = SA Reading (dBuV/m) + Factor\* (dB)

\*Factor includes antenna factor , cable loss and amplifier gain

Note 2: Margin (dB) = Emission level (dBuV/m) – Limit (dBuV/m).

<b>Modulation</b>	11a	<b>Test Freq. (MHz)</b>	5745
<b>Polarization</b>	Horizontal		

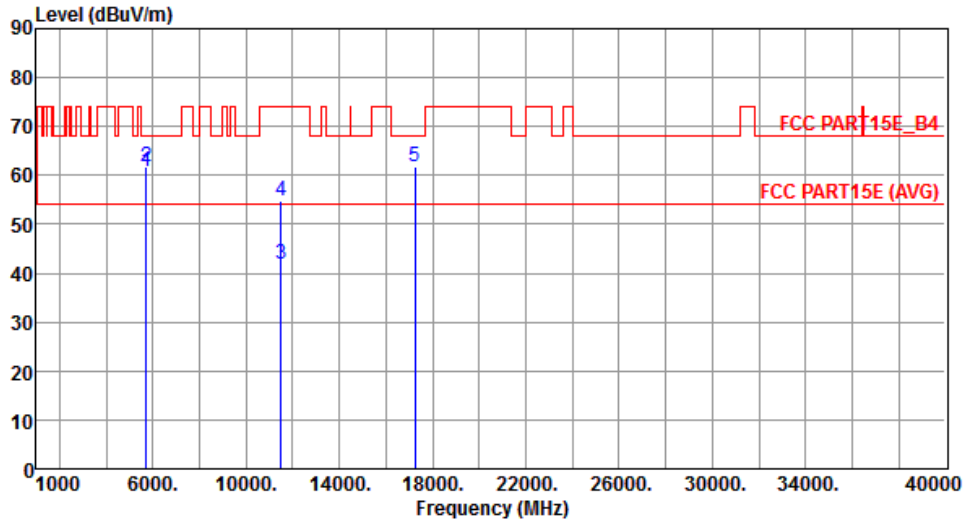

	Freq. MHz	Emission level dBuV/m	Limit dBuV/m	Margin dB	SA reading dBuV	Factor dB	Remark	ANT High cm	Turn Table deg
1	5715.00	60.63	68.20	-7.57	53.21	7.42	Peak	290	22
2	5725.00	61.73	78.20	-16.47	54.29	7.44	Peak	290	22
3	11490.00	41.95	54.00	-12.05	27.93	14.02	Average	100	285
4	11490.00	54.70	74.00	-19.30	40.68	14.02	Peak	100	285
5	17235.00	61.90	68.20	-6.30	43.37	18.53	Peak	100	282

Note 1: Emission Level (dBuV/m) = SA Reading (dBuV/m) + Factor\* (dB)

\*Factor includes antenna factor , cable loss and amplifier gain

Note 2: Margin (dB) = Emission level (dBuV/m) – Limit (dBuV/m).

<b>Modulation</b>	11a	<b>Test Freq. (MHz)</b>	5745
<b>Polarization</b>	Vertical		

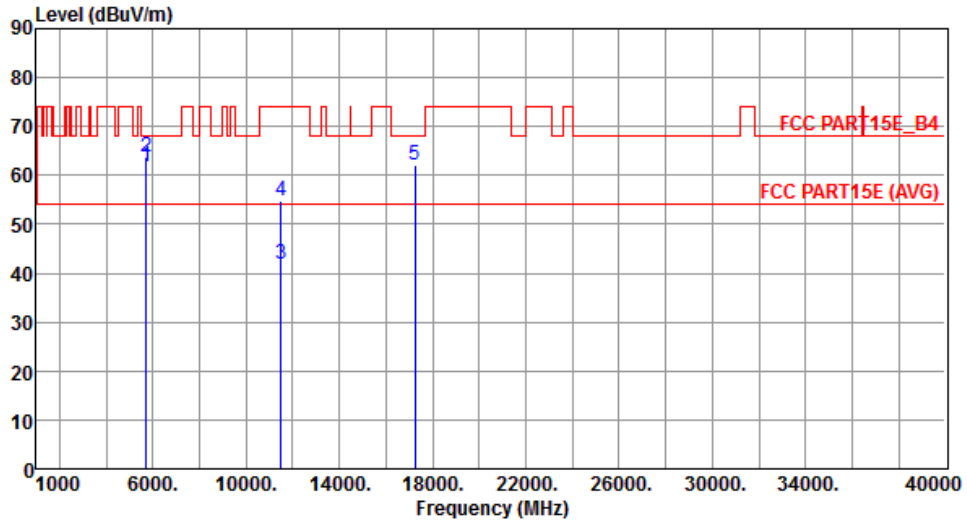

	Freq. MHz	Emission level dBuV/m	Limit dBuV/m	Margin dB	SA reading dBuV	Factor dB	Remark	ANT High cm	Turn Table deg
1	5715.00	61.62	68.20	-6.58	54.20	7.42	Peak	287	270
2	5725.00	63.91	78.20	-14.29	56.47	7.44	Peak	287	270
3	11490.00	41.98	54.00	-12.02	27.96	14.02	Average	112	216
4	11490.00	54.81	74.00	-19.19	40.79	14.02	Peak	112	216
5	17235.00	62.18	68.20	-6.02	43.65	18.53	Peak	100	108

Note 1: Emission Level (dBuV/m) = SA Reading (dBuV/m) + Factor\* (dB)

\*Factor includes antenna factor , cable loss and amplifier gain

Note 2: Margin (dB) = Emission level (dBuV/m) – Limit (dBuV/m).



<b>Modulation</b>	11a	<b>Test Freq. (MHz)</b>	5785
<b>Polarization</b>	Horizontal		

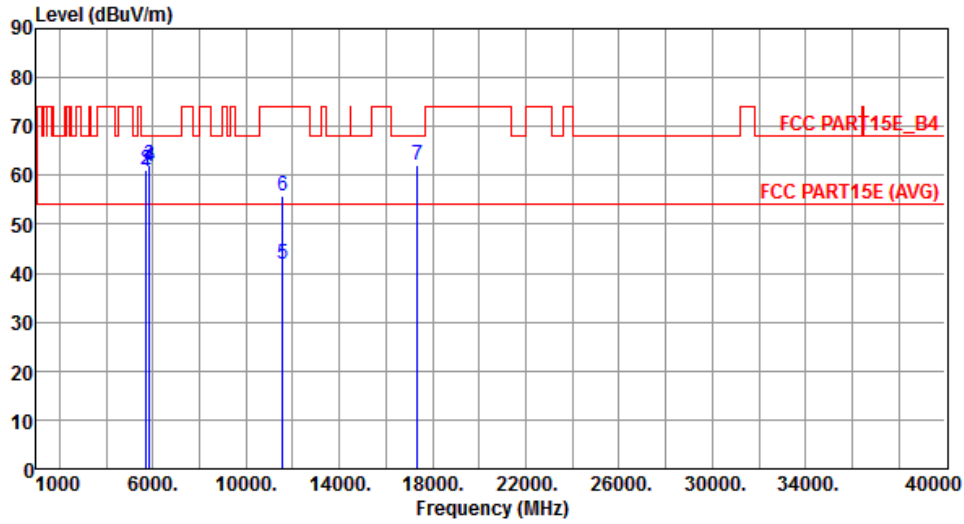

	Freq. MHz	Emission level dBuV/m	Limit dBuV/m	Margin dB	SA reading dBuV	Factor dB	Remark	ANT High cm	Turn Table deg
1	5715.00	60.77	68.20	-7.43	53.35	7.42	Peak	271	20
2	5725.00	60.96	78.20	-17.24	53.52	7.44	Peak	271	20
3	5850.00	62.18	78.20	-16.02	54.32	7.86	Peak	271	20
4	5860.00	61.75	68.20	-6.45	53.86	7.89	Peak	271	20
5	11570.00	41.82	54.00	-12.18	27.84	13.98	Average	118	342
6	11570.00	55.85	74.00	-18.15	41.87	13.98	Peak	118	342
7	17355.00	62.03	68.20	-6.17	43.23	18.80	Peak	100	116

Note 1: Emission Level (dBuV/m) = SA Reading (dBuV/m) + Factor\* (dB)

\*Factor includes antenna factor , cable loss and amplifier gain

Note 2: Margin (dB) = Emission level (dBuV/m) – Limit (dBuV/m).

<b>Modulation</b>	11a	<b>Test Freq. (MHz)</b>	5785
<b>Polarization</b>	Vertical		

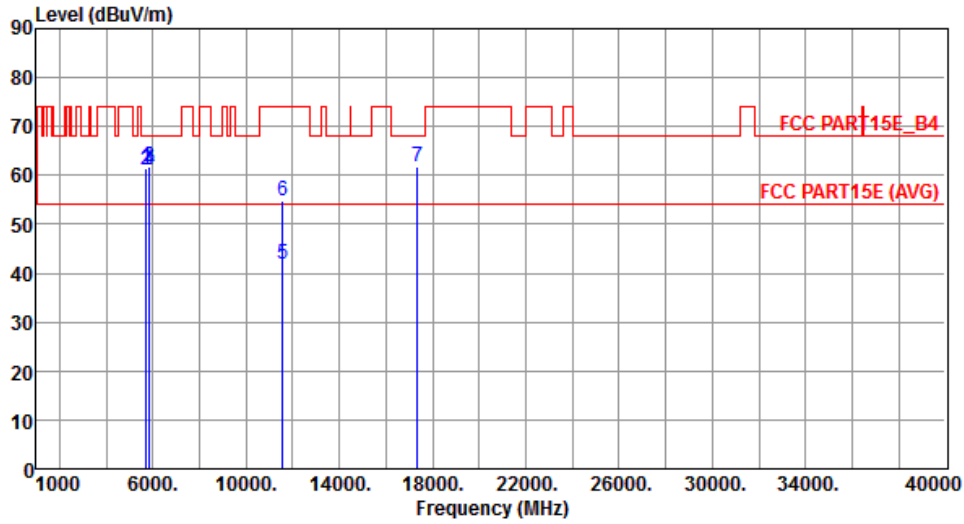

	Freq. MHz	Emission level dBuV/m	Limit dBuV/m	Margin dB	SA reading dBuV	Factor dB	Remark	ANT High cm	Turn Table deg
1	5715.00	61.48	68.20	-6.72	54.06	7.42	Peak	342	259
2	5725.00	60.94	78.20	-17.26	53.50	7.44	Peak	342	259
3	5850.00	61.73	78.20	-16.47	53.87	7.86	Peak	342	259
4	5860.00	61.22	68.20	-6.98	53.33	7.89	Peak	342	259
5	11570.00	41.88	54.00	-12.12	27.90	13.98	Average	100	315
6	11570.00	54.94	74.00	-19.06	40.96	13.98	Peak	100	315
7	17355.00	61.63	68.20	-6.57	42.83	18.80	Peak	100	215

Note 1: Emission Level (dBuV/m) = SA Reading (dBuV/m) + Factor\* (dB)

\*Factor includes antenna factor , cable loss and amplifier gain

Note 2: Margin (dB) = Emission level (dBuV/m) – Limit (dBuV/m).

<b>Modulation</b>	11a	<b>Test Freq. (MHz)</b>	5825
<b>Polarization</b>	Horizontal		

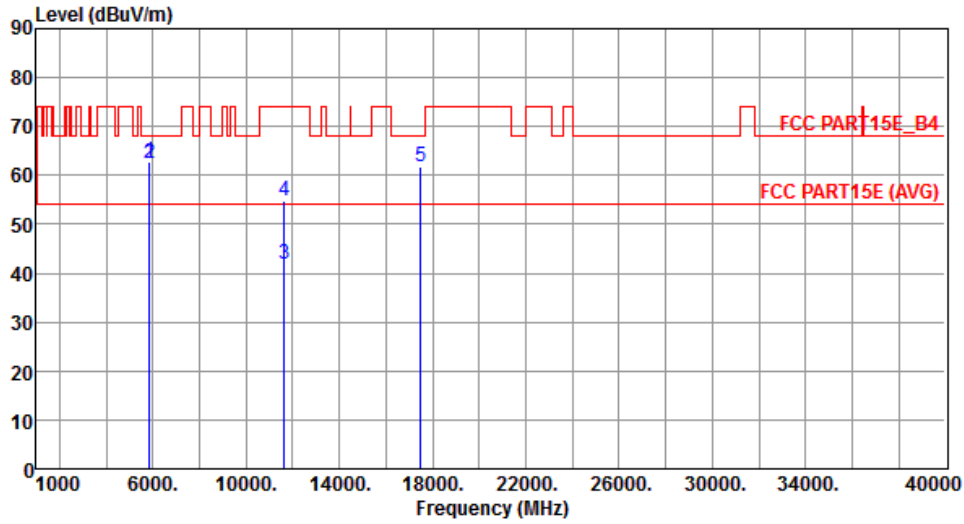

	Freq. MHz	Emission level dBuV/m	Limit dBuV/m	Margin dB	SA reading dBuV	Factor dB	Remark	ANT High cm	Turn Table deg
1	5850.00	62.71	78.20	-15.49	54.85	7.86	Peak	266	21
2	5860.00	62.56	68.20	-5.64	54.67	7.89	Peak	266	21
3	11650.00	41.94	54.00	-12.06	28.02	13.92	Average	118	233
4	11650.00	54.71	74.00	-19.29	40.79	13.92	Peak	118	233
5	17475.00	61.85	68.20	-6.35	42.79	19.06	Peak	100	268

Note 1: Emission Level (dBuV/m) = SA Reading (dBuV/m) + Factor\* (dB)

\*Factor includes antenna factor , cable loss and amplifier gain

Note 2: Margin (dB) = Emission level (dBuV/m) – Limit (dBuV/m).

<b>Modulation</b>	11a	<b>Test Freq. (MHz)</b>	5825
<b>Polarization</b>	Vertical		

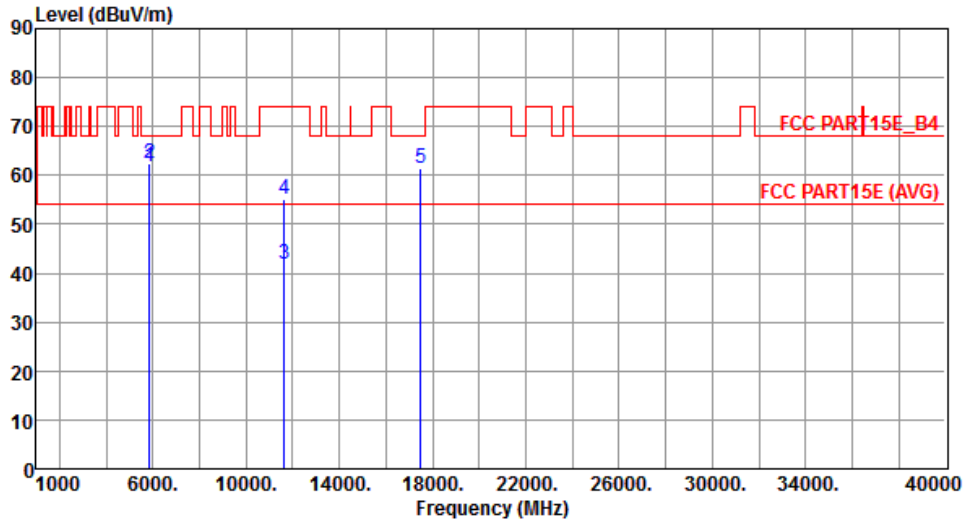

	Freq. MHz	Emission level dBuV/m	Limit dBuV/m	Margin dB	SA reading dBuV	Factor dB	Remark	ANT High cm	Turn Table deg
1	5850.00	61.78	78.20	-16.42	53.92	7.86	Peak	339	256
2	5860.00	62.39	68.20	-5.81	54.50	7.89	Peak	339	256
3	11650.00	41.80	54.00	-12.20	27.88	13.92	Average	100	65
4	11650.00	55.29	74.00	-18.71	41.37	13.92	Peak	100	65
5	17475.00	61.48	68.20	-6.72	42.42	19.06	Peak	100	39

Note 1: Emission Level (dBuV/m) = SA Reading (dBuV/m) + Factor\* (dB)

\*Factor includes antenna factor , cable loss and amplifier gain

Note 2: Margin (dB) = Emission level (dBuV/m) – Limit (dBuV/m).

### 3.5.6 Transmitter Radiated Unwanted Emissions (Above 1GHz) for VHT20

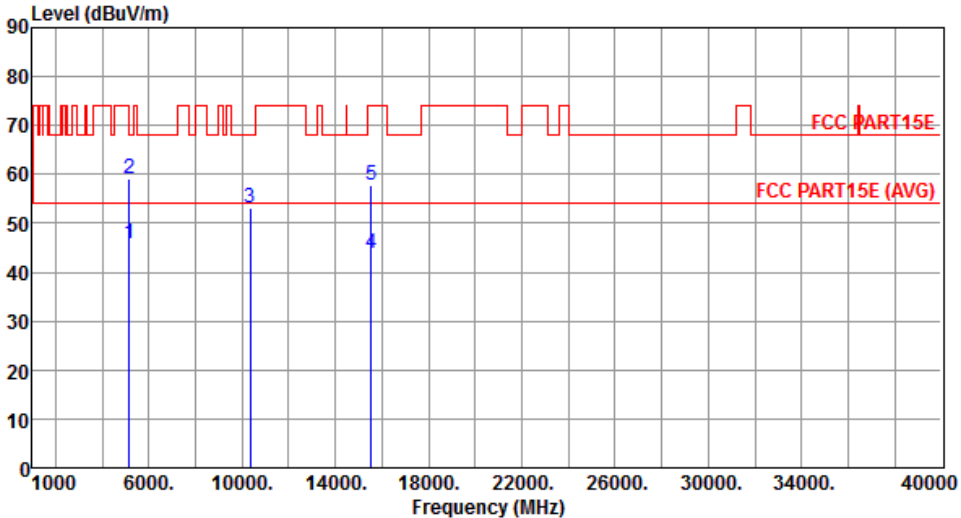
Modulation	VHT20	Test Freq. (MHz)	5180																																																																					
Polarization	Horizontal																																																																							
																																																																								
	<table border="1"> <thead> <tr> <th>Freq.</th> <th>Emission level</th> <th>Limit</th> <th>Margin</th> <th>SA reading</th> <th>Factor</th> <th>Remark</th> <th>ANT High</th> <th>Turn Table</th> </tr> <tr> <th>MHz</th> <th>dBuV/m</th> <th>dBuV/m</th> <th>dB</th> <th>dBuV</th> <th>dB</th> <th></th> <th>cm</th> <th>deg</th> </tr> </thead> <tbody> <tr> <td>1</td> <td>5150.00</td> <td>45.76</td> <td>54.00</td> <td>-8.24</td> <td>39.67</td> <td>6.09</td> <td>Average</td> <td>100</td> <td>195</td> </tr> <tr> <td>2</td> <td>5150.00</td> <td>58.97</td> <td>74.00</td> <td>-15.03</td> <td>52.88</td> <td>6.09</td> <td>Peak</td> <td>100</td> <td>195</td> </tr> <tr> <td>3</td> <td>10360.00</td> <td>53.30</td> <td>68.20</td> <td>-14.90</td> <td>40.24</td> <td>13.06</td> <td>Peak</td> <td>100</td> <td>197</td> </tr> <tr> <td>4</td> <td>15540.00</td> <td>43.74</td> <td>54.00</td> <td>-10.26</td> <td>28.89</td> <td>14.85</td> <td>Average</td> <td>100</td> <td>89</td> </tr> <tr> <td>5</td> <td>15540.00</td> <td>57.67</td> <td>74.00</td> <td>-16.33</td> <td>42.82</td> <td>14.85</td> <td>Peak</td> <td>100</td> <td>89</td> </tr> </tbody> </table>	Freq.	Emission level	Limit	Margin	SA reading	Factor	Remark	ANT High	Turn Table	MHz	dBuV/m	dBuV/m	dB	dBuV	dB		cm	deg	1	5150.00	45.76	54.00	-8.24	39.67	6.09	Average	100	195	2	5150.00	58.97	74.00	-15.03	52.88	6.09	Peak	100	195	3	10360.00	53.30	68.20	-14.90	40.24	13.06	Peak	100	197	4	15540.00	43.74	54.00	-10.26	28.89	14.85	Average	100	89	5	15540.00	57.67	74.00	-16.33	42.82	14.85	Peak	100	89			
Freq.	Emission level	Limit	Margin	SA reading	Factor	Remark	ANT High	Turn Table																																																																
MHz	dBuV/m	dBuV/m	dB	dBuV	dB		cm	deg																																																																
1	5150.00	45.76	54.00	-8.24	39.67	6.09	Average	100	195																																																															
2	5150.00	58.97	74.00	-15.03	52.88	6.09	Peak	100	195																																																															
3	10360.00	53.30	68.20	-14.90	40.24	13.06	Peak	100	197																																																															
4	15540.00	43.74	54.00	-10.26	28.89	14.85	Average	100	89																																																															
5	15540.00	57.67	74.00	-16.33	42.82	14.85	Peak	100	89																																																															
<p>Note 1: Emission Level (dBuV/m) = SA Reading (dBuV/m) + Factor* (dB)            *Factor includes antenna factor , cable loss and amplifier gain            Note 2: Margin (dB) = Emission level (dBuV/m) – Limit (dBuV/m).</p>																																																																								

<b>Modulation</b>	VHT20	<b>Test Freq. (MHz)</b>	5180
<b>Polarization</b>	Vertical		

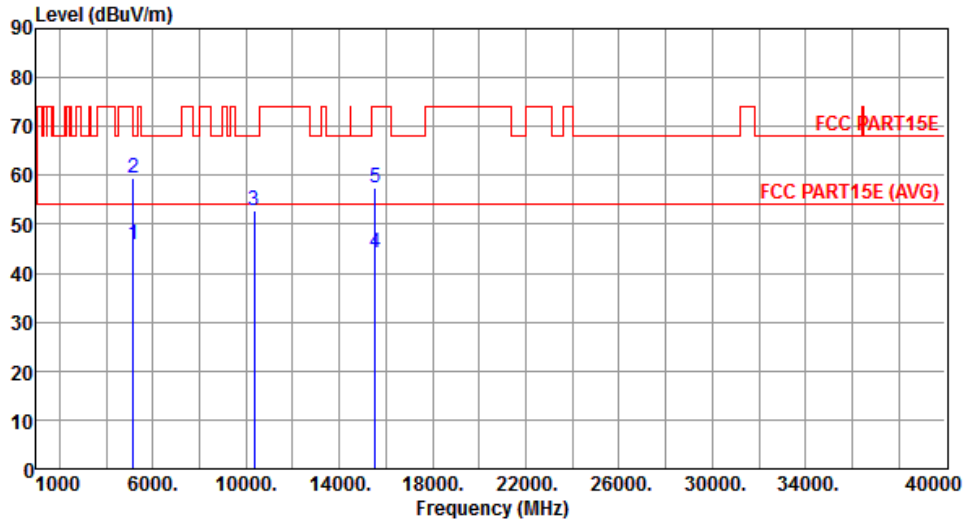

	Freq. MHz	Emission level dBuV/m	Limit dBuV/m	Margin dB	SA reading dBuV	Factor dB	Remark	ANT High cm	Turn Table deg
1	5150.00	45.71	54.00	-8.29	39.62	6.09	Average	265	265
2	5150.00	59.30	74.00	-14.70	53.21	6.09	Peak	265	265
3	10360.00	52.88	68.20	-15.32	39.82	13.06	Peak	100	158
4	15540.00	44.03	54.00	-9.97	29.18	14.85	Average	100	248
5	15540.00	57.59	74.00	-16.41	42.74	14.85	Peak	100	248

Note 1: Emission Level (dBuV/m) = SA Reading (dBuV/m) + Factor\* (dB)

\*Factor includes antenna factor , cable loss and amplifier gain

Note 2: Margin (dB) = Emission level (dBuV/m) – Limit (dBuV/m).

<b>Modulation</b>	VHT20	<b>Test Freq. (MHz)</b>	5200
<b>Polarization</b>	Horizontal		

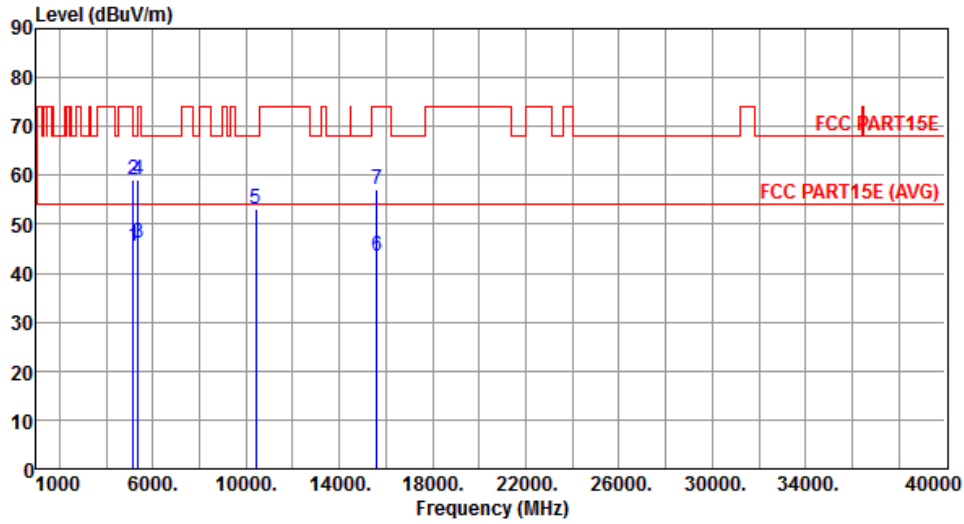

	Freq. MHz	Emission level dBuV/m	Limit dBuV/m	Margin dB	SA reading dBuV	Factor dB	Remark	ANT High cm	Turn Table deg
1	5150.00	45.52	54.00	-8.48	39.43	6.09	Average	306	197
2	5150.00	59.13	74.00	-14.87	53.04	6.09	Peak	306	197
3	5350.00	46.03	54.00	-7.97	39.58	6.45	Average	306	197
4	5350.00	59.26	74.00	-14.74	52.81	6.45	Peak	306	197
5	10400.00	53.25	68.20	-14.95	40.15	13.10	Peak	100	262
6	15600.00	43.56	54.00	-10.44	28.74	14.82	Average	100	312
7	15600.00	57.05	74.00	-16.95	42.23	14.82	Peak	100	312

Note 1: Emission Level (dBuV/m) = SA Reading (dBuV/m) + Factor\* (dB)

\*Factor includes antenna factor , cable loss and amplifier gain

Note 2: Margin (dB) = Emission level (dBuV/m) – Limit (dBuV/m).

<b>Modulation</b>	VHT20	<b>Test Freq. (MHz)</b>	5200
<b>Polarization</b>	Vertical		

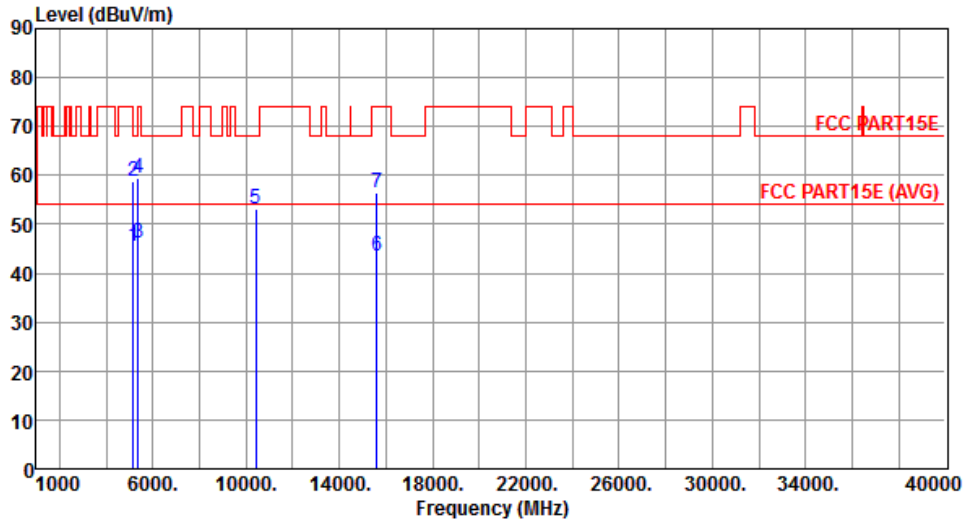

	Freq. MHz	Emission level dBuV/m	Limit dBuV/m	Margin dB	SA reading dBuV	Factor dB	Remark	ANT High cm	Turn Table deg
1	5150.00	45.53	54.00	-8.47	39.44	6.09	Average	265	265
2	5150.00	58.93	74.00	-15.07	52.84	6.09	Peak	265	265
3	5350.00	46.20	54.00	-7.80	39.75	6.45	Average	265	265
4	5350.00	59.50	74.00	-14.50	53.05	6.45	Peak	265	265
5	10400.00	53.14	68.20	-15.06	40.04	13.10	Peak	100	118
6	15600.00	43.48	54.00	-10.52	28.66	14.82	Average	100	158
7	15600.00	56.42	74.00	-17.58	41.60	14.82	Peak	100	158

Note 1: Emission Level (dBuV/m) = SA Reading (dBuV/m) + Factor\* (dB)

\*Factor includes antenna factor , cable loss and amplifier gain

Note 2: Margin (dB) = Emission level (dBuV/m) – Limit (dBuV/m).



<b>Modulation</b>	VHT20	<b>Test Freq. (MHz)</b>	5240
<b>Polarization</b>	Horizontal		

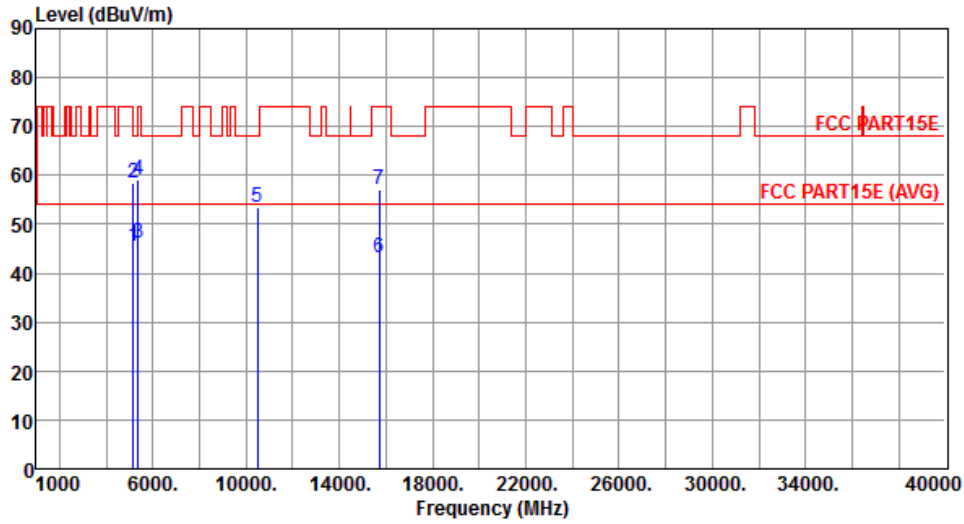

	Freq. MHz	Emission level dBuV/m	Limit dBuV/m	Margin dB	SA reading dBuV	Factor dB	Remark	ANT High cm	Turn Table deg
1	5150.00	45.48	54.00	-8.52	39.39	6.09	Average	100	7
2	5150.00	58.48	74.00	-15.52	52.39	6.09	Peak	100	7
3	5350.00	46.25	54.00	-7.75	39.80	6.45	Average	100	7
4	5350.00	59.13	74.00	-14.87	52.68	6.45	Peak	100	7
5	10480.00	53.39	68.20	-14.81	40.24	13.15	Peak	100	134
6	15720.00	43.33	54.00	-10.67	28.54	14.79	Average	100	252
7	15720.00	57.05	74.00	-16.95	42.26	14.79	Peak	100	252

Note 1: Emission Level (dBuV/m) = SA Reading (dBuV/m) + Factor\* (dB)

\*Factor includes antenna factor , cable loss and amplifier gain

Note 2: Margin (dB) = Emission level (dBuV/m) – Limit (dBuV/m).

<b>Modulation</b>	VHT20	<b>Test Freq. (MHz)</b>	5240
<b>Polarization</b>	Vertical		

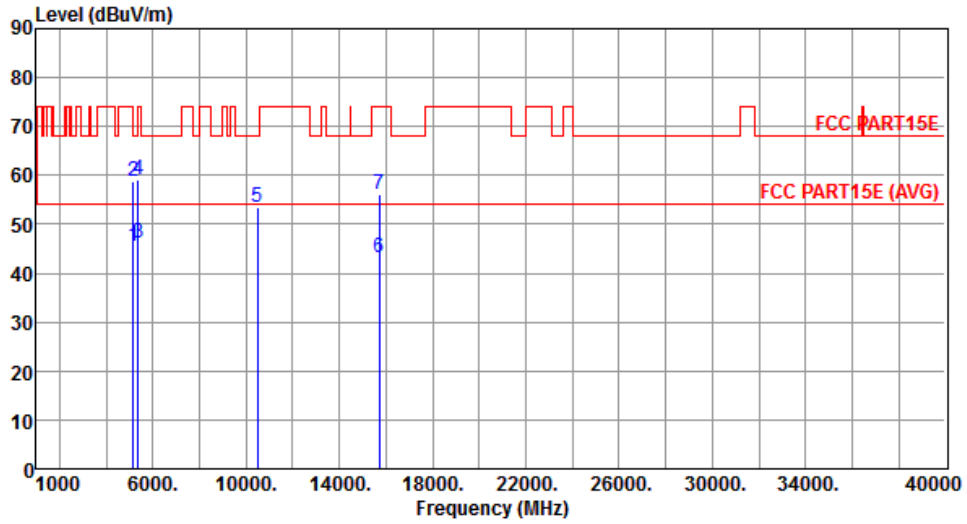

	Freq. MHz	Emission level dBuV/m	Limit dBuV/m	Margin dB	SA reading dBuV	Factor dB	Remark	ANT High cm	Turn Table deg
1	5150.00	45.54	54.00	-8.46	39.45	6.09	Average	263	267
2	5150.00	58.73	74.00	-15.27	52.64	6.09	Peak	263	267
3	5350.00	46.08	54.00	-7.92	39.63	6.45	Average	263	267
4	5350.00	59.15	74.00	-14.85	52.70	6.45	Peak	263	267
5	10480.00	53.52	68.20	-14.68	40.37	13.15	Peak	100	118
6	15720.00	43.31	54.00	-10.69	28.52	14.79	Average	100	207
7	15720.00	56.20	74.00	-17.80	41.41	14.79	Peak	100	207

Note 1: Emission Level (dBuV/m) = SA Reading (dBuV/m) + Factor\* (dB)

\*Factor includes antenna factor , cable loss and amplifier gain

Note 2: Margin (dB) = Emission level (dBuV/m) – Limit (dBuV/m).

<b>Modulation</b>	VHT20	<b>Test Freq. (MHz)</b>	5745
<b>Polarization</b>	Horizontal		

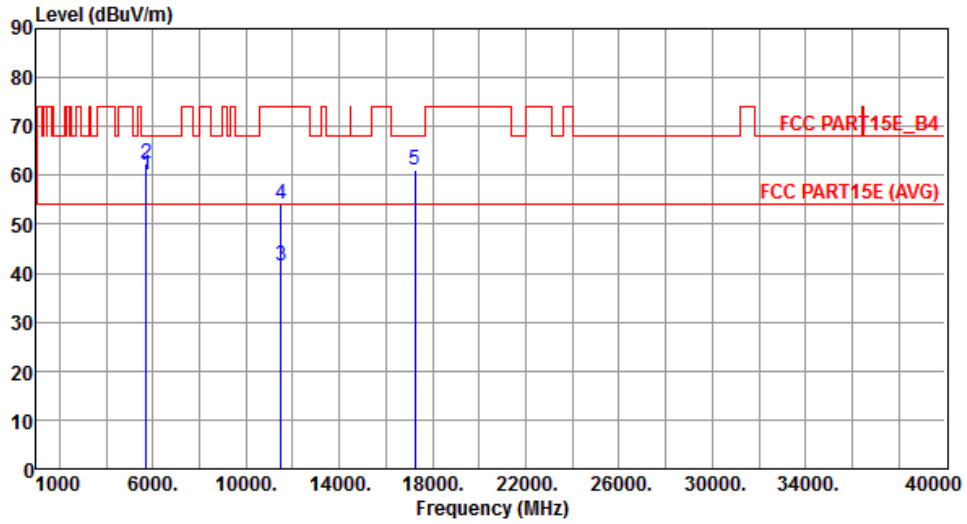

	Freq. MHz	Emission level dBuV/m	Limit dBuV/m	Margin dB	SA reading dBuV	Factor dB	Remark	ANT High cm	Turn Table deg
1	5715.00	60.12	68.20	-8.08	52.70	7.42	Peak	282	20
2	5725.00	62.31	78.20	-15.89	54.87	7.44	Peak	282	20
3	11490.00	41.49	54.00	-12.51	27.47	14.02	Average	100	151
4	11490.00	54.22	74.00	-19.78	40.20	14.02	Peak	100	151
5	17235.00	61.12	68.20	-7.08	42.59	18.53	Peak	100	82

Note 1: Emission Level (dBuV/m) = SA Reading (dBuV/m) + Factor\* (dB)

\*Factor includes antenna factor , cable loss and amplifier gain

Note 2: Margin (dB) = Emission level (dBuV/m) – Limit (dBuV/m).

<b>Modulation</b>	VHT20	<b>Test Freq. (MHz)</b>	5745
<b>Polarization</b>	Vertical		

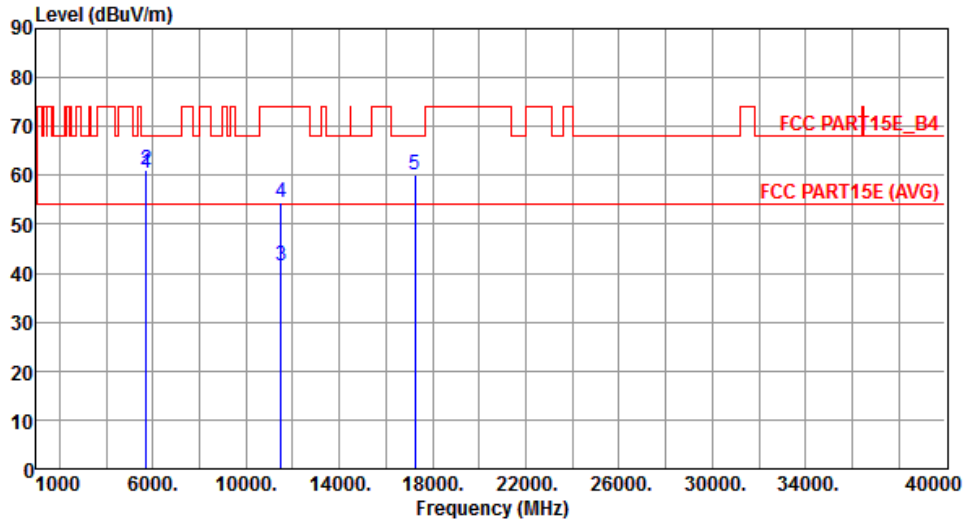

	Freq. MHz	Emission level dBuV/m	Limit dBuV/m	Margin dB	SA reading dBuV	Factor dB	Remark	ANT High cm	Turn Table deg
1	5715.00	60.56	68.20	-7.64	53.14	7.42	Peak	100	121
2	5725.00	60.99	78.20	-17.21	53.55	7.44	Peak	100	121
3	11490.00	41.36	54.00	-12.64	27.34	14.02	Average	100	213
4	11490.00	54.50	74.00	-19.50	40.48	14.02	Peak	100	213
5	17235.00	60.24	68.20	-7.96	41.71	18.53	Peak	100	245

Note 1: Emission Level (dBuV/m) = SA Reading (dBuV/m) + Factor\* (dB)

\*Factor includes antenna factor , cable loss and amplifier gain

Note 2: Margin (dB) = Emission level (dBuV/m) – Limit (dBuV/m).

<b>Modulation</b>	VHT20	<b>Test Freq. (MHz)</b>	5785
<b>Polarization</b>	Horizontal		

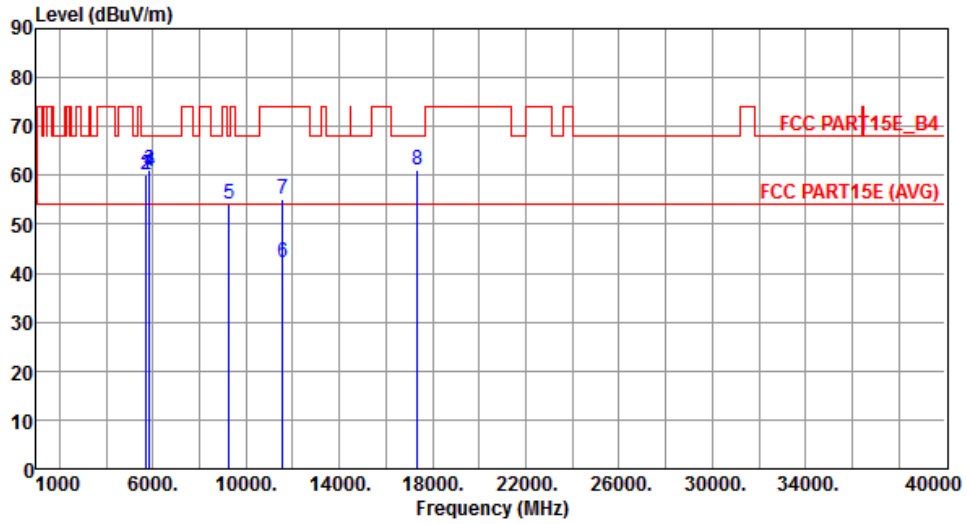

	Freq. MHz	Emission level dBuV/m	Limit dBuV/m	Margin dB	SA reading dBuV	Factor dB	Remark	ANT High cm	Turn Table deg
1	5715.00	60.09	68.20	-8.11	52.67	7.42	Peak	271	18
2	5725.00	60.08	78.20	-18.12	52.64	7.44	Peak	271	18
3	5850.00	60.96	78.20	-17.24	53.10	7.86	Peak	271	18
4	5860.00	60.62	68.20	-7.58	52.73	7.89	Peak	271	18
5	9256.00	54.16	68.20	-14.04	42.37	11.79	Peak	179	20
6	11570.00	42.04	54.00	-11.96	28.06	13.98	Average	100	136
7	11570.00	55.14	74.00	-18.86	41.16	13.98	Peak	100	136
8	17355.00	60.94	68.20	-7.26	42.14	18.80	Peak	100	225

Note 1: Emission Level (dBuV/m) = SA Reading (dBuV/m) + Factor\* (dB)

\*Factor includes antenna factor , cable loss and amplifier gain

Note 2: Margin (dB) = Emission level (dBuV/m) – Limit (dBuV/m).

<b>Modulation</b>	VHT20	<b>Test Freq. (MHz)</b>	5785
<b>Polarization</b>	Vertical		

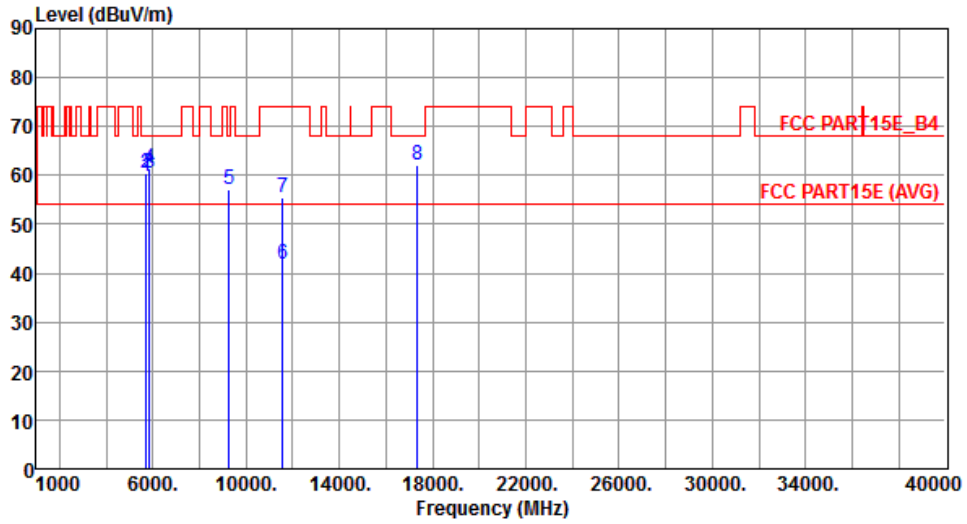

	Freq. MHz	Emission level dBuV/m	Limit dBuV/m	Margin dB	SA reading dBuV	Factor dB	Remark	ANT High cm	Turn Table deg
1	5715.00	59.89	68.20	-8.31	52.47	7.42	Peak	252	267
2	5725.00	60.59	78.20	-17.61	53.15	7.44	Peak	252	267
3	5850.00	60.60	78.20	-17.60	52.74	7.86	Peak	252	267
4	5860.00	61.60	68.20	-6.60	53.71	7.89	Peak	252	267
5	9256.00	57.00	68.20	-11.20	45.21	11.79	Peak	130	330
6	11570.00	41.85	54.00	-12.15	27.87	13.98	Average	100	96
7	11570.00	55.49	74.00	-18.51	41.51	13.98	Peak	100	96
8	17355.00	61.95	68.20	-6.25	43.15	18.80	Peak	100	128

Note 1: Emission Level (dBuV/m) = SA Reading (dBuV/m) + Factor\* (dB)

\*Factor includes antenna factor , cable loss and amplifier gain

Note 2: Margin (dB) = Emission level (dBuV/m) – Limit (dBuV/m).

<b>Modulation</b>	VHT20	<b>Test Freq. (MHz)</b>	5825
<b>Polarization</b>	Horizontal		

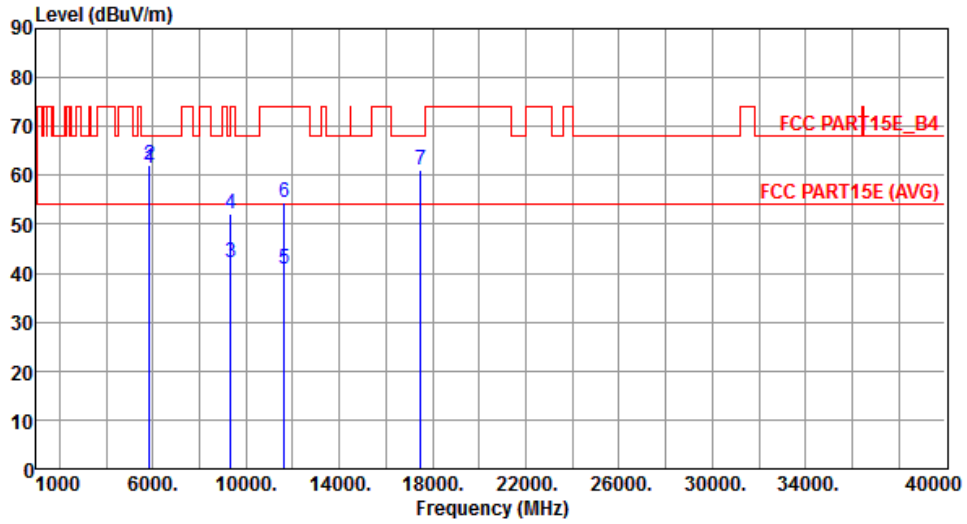

	Freq. MHz	Emission level dBuV/m	Limit dBuV/m	Margin dB	SA reading dBuV	Factor dB	Remark	ANT High cm	Turn Table deg
1	5850.00	61.51	78.20	-16.69	53.65	7.86	Peak	185	25
2	5860.00	62.18	68.20	-6.02	54.29	7.89	Peak	185	25
3	9320.00	42.05	54.00	-11.95	30.18	11.87	Average	165	11
4	9320.00	52.23	74.00	-21.77	40.36	11.87	Peak	165	11
5	11650.00	40.97	54.00	-13.03	27.05	13.92	Average	100	136
6	11650.00	54.55	74.00	-19.45	40.63	13.92	Peak	100	136
7	17475.00	61.21	68.20	-6.99	42.15	19.06	Peak	112	210

Note 1: Emission Level (dBuV/m) = SA Reading (dBuV/m) + Factor\* (dB)

\*Factor includes antenna factor , cable loss and amplifier gain

Note 2: Margin (dB) = Emission level (dBuV/m) – Limit (dBuV/m).

<b>Modulation</b>	VHT20	<b>Test Freq. (MHz)</b>	5825
<b>Polarization</b>	Vertical		

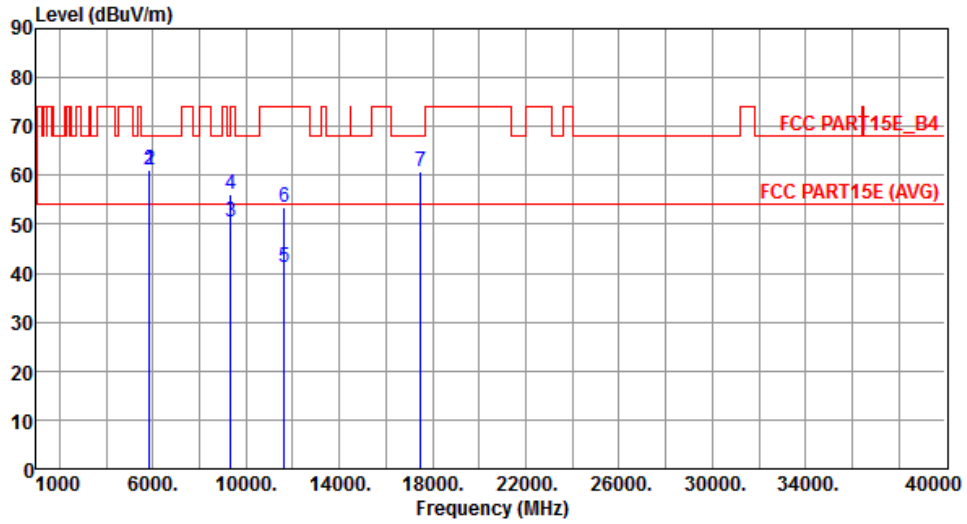

	Freq. MHz	Emission level dBuV/m	Limit dBuV/m	Margin dB	SA reading dBuV	Factor dB	Remark	ANT High cm	Turn Table deg
1	5850.00	61.11	78.20	-17.09	53.25	7.86	Peak	351	262
2	5860.00	61.27	68.20	-6.93	53.38	7.89	Peak	351	262
3	9320.00	50.62	54.00	-3.38	38.75	11.87	Average	351	262
4	9320.00	55.99	74.00	-18.01	44.12	11.87	Peak	351	262
5	11650.00	41.07	54.00	-12.93	27.15	13.92	Average	100	89
6	11650.00	53.57	74.00	-20.43	39.65	13.92	Peak	100	89
7	17475.00	60.64	68.20	-7.56	41.58	19.06	Peak	112	136

Note 1: Emission Level (dBuV/m) = SA Reading (dBuV/m) + Factor\* (dB)

\*Factor includes antenna factor , cable loss and amplifier gain

Note 2: Margin (dB) = Emission level (dBuV/m) – Limit (dBuV/m).

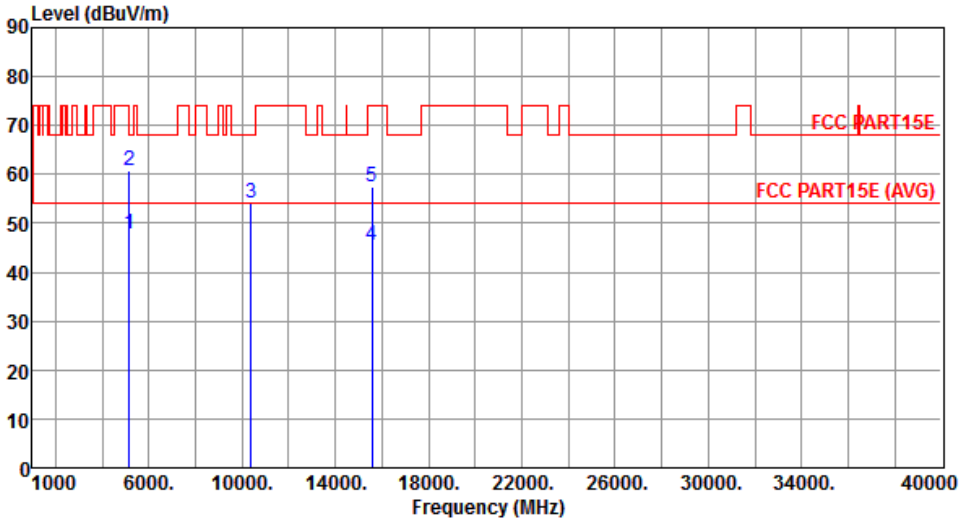

### 3.5.7 Transmitter Radiated Unwanted Emissions (Above 1GHz) for VHT40

Modulation	VHT40	Test Freq. (MHz)	5190						
Polarization	Horizontal								
									
	Freq.	Emission level	Limit	Margin	SA reading	Factor	Remark	ANT High	Turn Table
	MHz	dBuV/m	dBuV/m	dB	dBuV	dB		cm	deg
1	5150.00	47.72	54.00	-6.28	41.63	6.09	Average	277	18
2	5150.00	60.86	74.00	-13.14	54.77	6.09	Peak	277	18
3	10380.00	54.07	68.20	-14.13	40.98	13.09	Peak	312	241
4	15570.00	45.47	54.00	-8.53	30.64	14.83	Average	245	169
5	15570.00	57.39	74.00	-16.61	42.56	14.83	Peak	245	169
<p>Note 1: Emission Level (dBuV/m) = SA Reading (dBuV/m) + Factor* (dB)            *Factor includes antenna factor , cable loss and amplifier gain            Note 2: Margin (dB) = Emission level (dBuV/m) – Limit (dBuV/m).</p>									

<b>Modulation</b>	VHT40	<b>Test Freq. (MHz)</b>	5190
<b>Polarization</b>	Vertical		

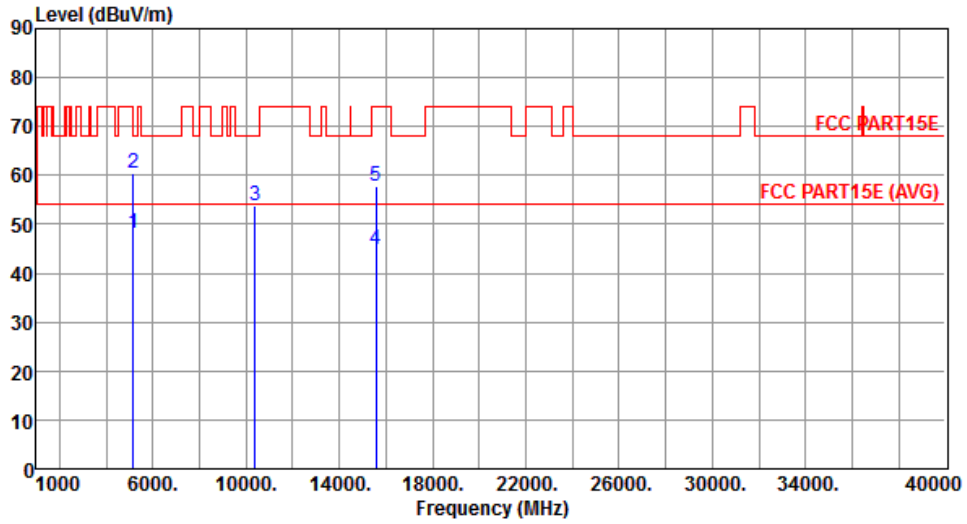

	Freq. MHz	Emission level dBuV/m	Limit dBuV/m	Margin dB	SA reading dBuV	Factor dB	Remark	ANT High cm	Turn Table deg
1	5150.00	48.08	54.00	-5.92	41.99	6.09	Average	245	271
2	5150.00	60.28	74.00	-13.72	54.19	6.09	Peak	245	271
3	10380.00	53.95	68.20	-14.25	40.86	13.09	Peak	138	270
4	15570.00	44.92	54.00	-9.08	30.09	14.83	Average	158	241
5	15570.00	57.63	74.00	-16.37	42.80	14.83	Peak	158	241

Note 1: Emission Level (dBuV/m) = SA Reading (dBuV/m) + Factor\* (dB)

\*Factor includes antenna factor , cable loss and amplifier gain

Note 2: Margin (dB) = Emission level (dBuV/m) – Limit (dBuV/m).

<b>Modulation</b>	VHT40	<b>Test Freq. (MHz)</b>	5230
<b>Polarization</b>	Horizontal		

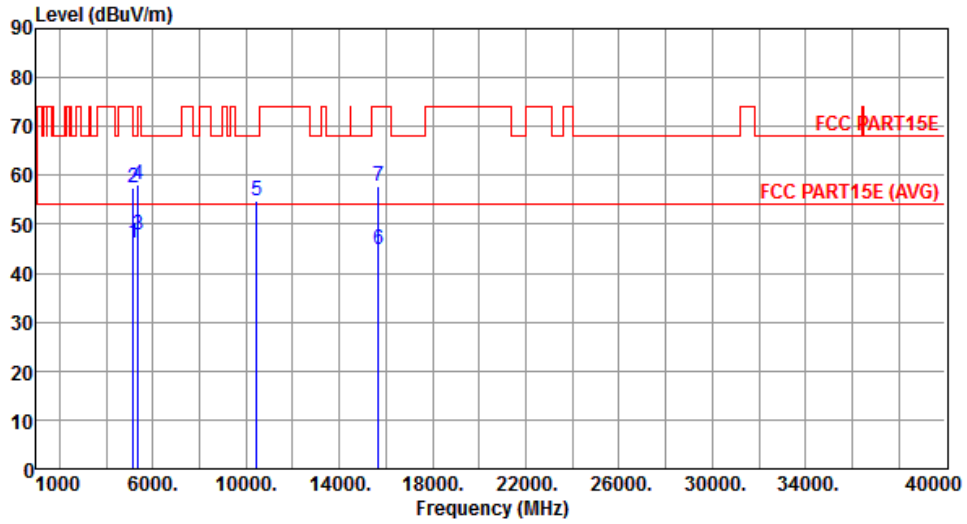

	Freq. MHz	Emission level dBuV/m	Limit dBuV/m	Margin dB	SA reading dBuV	Factor dB	Remark	ANT High cm	Turn Table deg
1	5150.00	46.29	54.00	-7.71	40.20	6.09	Average	266	177
2	5150.00	57.53	74.00	-16.47	51.44	6.09	Peak	266	177
3	5350.00	47.76	54.00	-6.24	41.31	6.45	Average	266	177
4	5350.00	58.28	74.00	-15.72	51.83	6.45	Peak	266	177
5	10460.00	54.77	68.20	-13.43	41.63	13.14	Peak	105	38
6	15690.00	44.78	54.00	-9.22	29.98	14.80	Average	196	177
7	15690.00	57.90	74.00	-16.10	43.10	14.80	Peak	196	177

Note 1: Emission Level (dBuV/m) = SA Reading (dBuV/m) + Factor\* (dB)

\*Factor includes antenna factor , cable loss and amplifier gain

Note 2: Margin (dB) = Emission level (dBuV/m) – Limit (dBuV/m).

<b>Modulation</b>	VHT40	<b>Test Freq. (MHz)</b>	5230
<b>Polarization</b>	Vertical		

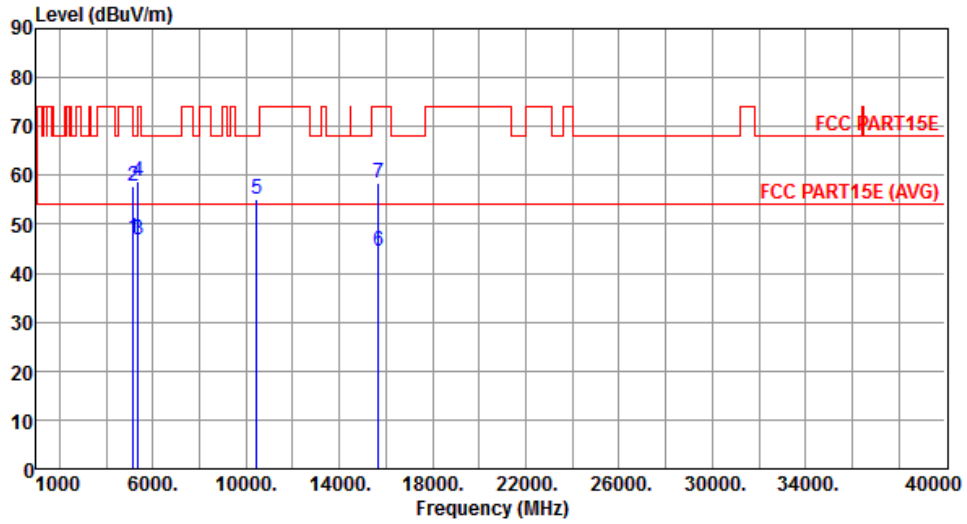

	Freq. MHz	Emission level dBuV/m	Limit dBuV/m	Margin dB	SA reading dBuV	Factor dB	Remark	ANT High cm	Turn Table deg
1	5150.00	47.11	54.00	-6.89	41.02	6.09	Average	243	270
2	5150.00	57.82	74.00	-16.18	51.73	6.09	Peak	243	270
3	5350.00	46.77	54.00	-7.23	40.32	6.45	Average	243	270
4	5350.00	58.81	74.00	-15.19	52.36	6.45	Peak	243	270
5	10460.00	55.20	68.20	-13.00	42.06	13.14	Peak	371	330
6	15690.00	44.59	54.00	-9.41	29.79	14.80	Average	320	291
7	15690.00	58.29	74.00	-15.71	43.49	14.80	Peak	320	291

Note 1: Emission Level (dBuV/m) = SA Reading (dBuV/m) + Factor\* (dB)

\*Factor includes antenna factor , cable loss and amplifier gain

Note 2: Margin (dB) = Emission level (dBuV/m) – Limit (dBuV/m).

<b>Modulation</b>	VHT40	<b>Test Freq. (MHz)</b>	5755
<b>Polarization</b>	Horizontal		

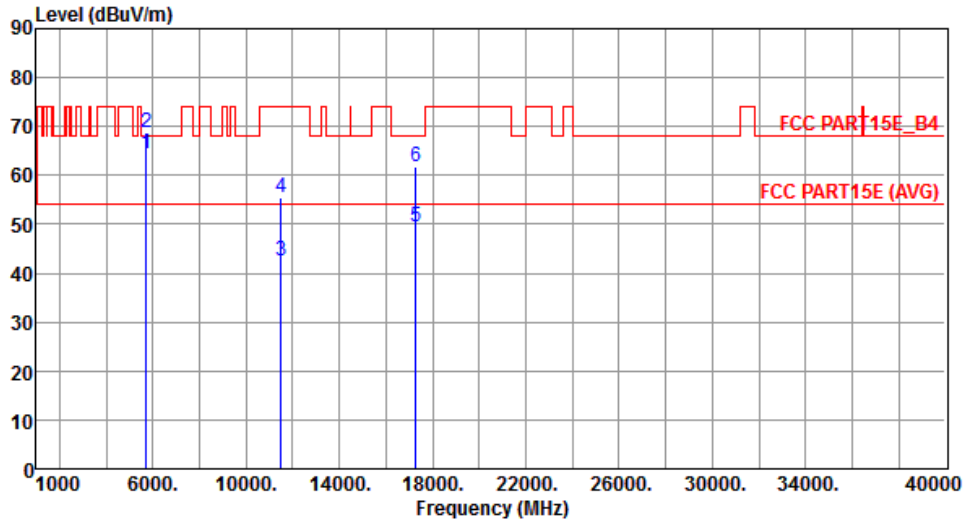

	Freq. MHz	Emission level dBuV/m	Limit dBuV/m	Margin dB	SA reading dBuV	Factor dB	Remark	ANT High cm	Turn Table deg
1	5715.00	64.32	68.20	-3.88	56.90	7.42	Peak	289	5
2	5725.00	68.70	78.20	-9.50	61.26	7.44	Peak	289	5
3	11510.00	42.63	54.00	-11.37	28.60	14.03	Average	183	21
4	11510.00	55.61	74.00	-18.39	41.58	14.03	Peak	183	21
5	17265.00	49.52	54.00	-4.48	30.91	18.61	Average	308	193
6	17265.00	61.90	68.20	-6.30	43.29	18.61	Peak	308	193

Note 1: Emission Level (dBuV/m) = SA Reading (dBuV/m) + Factor\* (dB)

\*Factor includes antenna factor , cable loss and amplifier gain

Note 2: Margin (dB) = Emission level (dBuV/m) – Limit (dBuV/m).

<b>Modulation</b>	VHT40	<b>Test Freq. (MHz)</b>	5755
<b>Polarization</b>	Vertical		

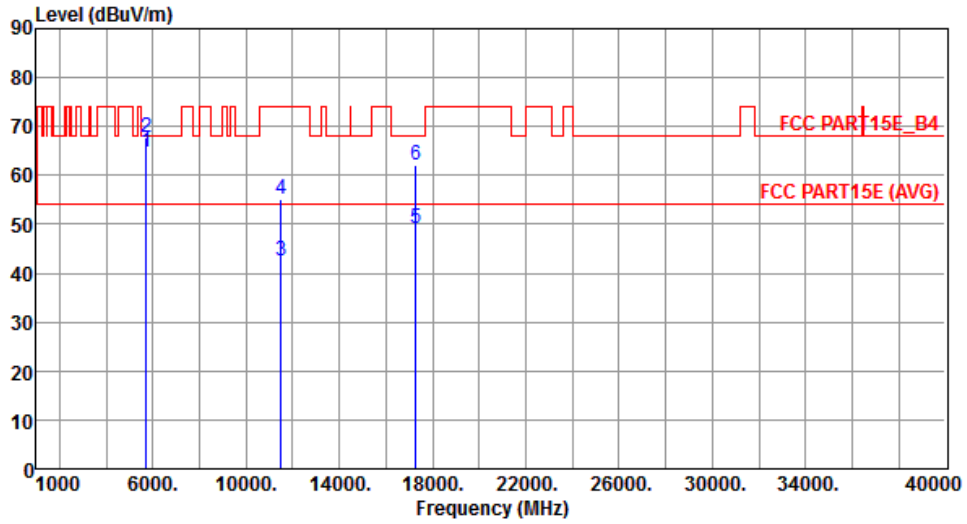

	Freq. MHz	Emission level dBuV/m	Limit dBuV/m	Margin dB	SA reading dBuV	Factor dB	Remark	ANT High cm	Turn Table deg
1	5715.00	64.91	68.20	-3.29	57.49	7.42	Peak	297	271
2	5725.00	67.62	78.20	-10.58	60.18	7.44	Peak	297	271
3	11510.00	42.38	54.00	-11.62	28.35	14.03	Average	241	83
4	11510.00	55.09	74.00	-18.91	41.06	14.03	Peak	241	83
5	17265.00	49.28	54.00	-4.72	30.67	18.61	Average	103	269
6	17265.00	62.05	68.20	-6.15	43.44	18.61	Peak	103	269

Note 1: Emission Level (dBuV/m) = SA Reading (dBuV/m) + Factor\* (dB)

\*Factor includes antenna factor , cable loss and amplifier gain

Note 2: Margin (dB) = Emission level (dBuV/m) – Limit (dBuV/m).

<b>Modulation</b>	VHT40	<b>Test Freq. (MHz)</b>	5795
<b>Polarization</b>	Horizontal		

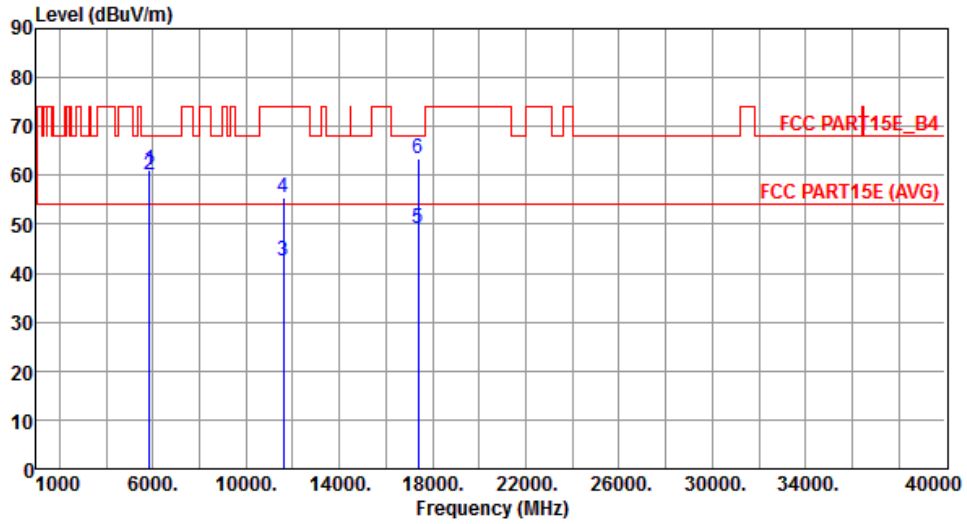

	Freq. MHz	Emission level dBuV/m	Limit dBuV/m	Margin dB	SA reading dBuV	Factor dB	Remark	ANT High cm	Turn Table deg
1	5850.00	61.09	78.20	-17.11	53.23	7.86	Peak	180	153
2	5860.00	60.15	68.20	-8.05	52.26	7.89	Peak	180	153
3	11590.00	42.56	54.00	-11.44	28.59	13.97	Average	241	63
4	11590.00	55.34	74.00	-18.66	41.37	13.97	Peak	241	63
5	17385.00	49.16	54.00	-4.84	30.30	18.86	Average	231	165
6	17385.00	63.33	68.20	-4.87	44.47	18.86	Peak	231	165

Note 1: Emission Level (dBuV/m) = SA Reading (dBuV/m) + Factor\* (dB)

\*Factor includes antenna factor , cable loss and amplifier gain

Note 2: Margin (dB) = Emission level (dBuV/m) – Limit (dBuV/m).

<b>Modulation</b>	VHT40	<b>Test Freq. (MHz)</b>	5795
<b>Polarization</b>	Vertical		

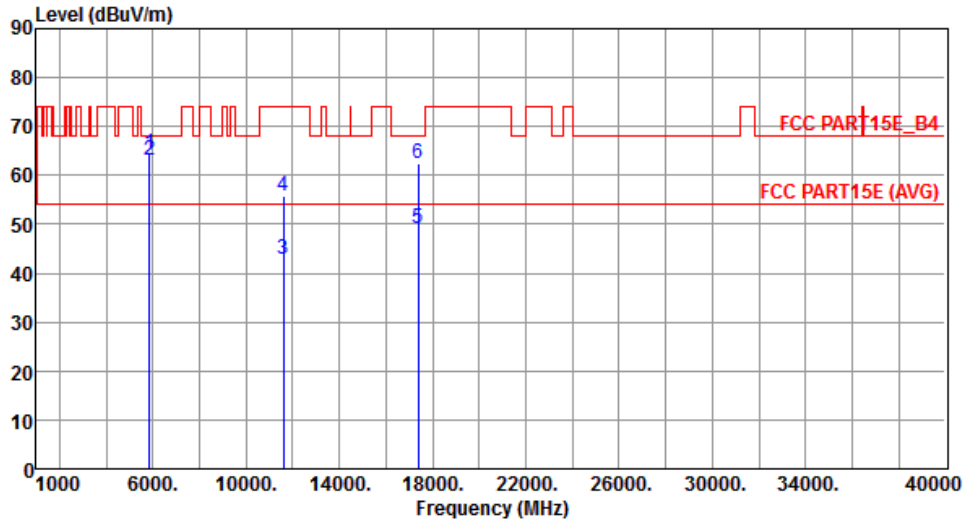

	Freq. MHz	Emission level dBuV/m	Limit dBuV/m	Margin dB	SA reading dBuV	Factor dB	Remark	ANT High cm	Turn Table deg
1	5850.00	64.46	78.20	-13.74	56.60	7.86	Peak	296	270
2	5860.00	63.15	68.20	-5.05	55.26	7.89	Peak	296	270
3	11590.00	42.70	54.00	-11.30	28.73	13.97	Average	206	308
4	11590.00	55.63	74.00	-18.37	41.66	13.97	Peak	206	308
5	17385.00	49.13	54.00	-4.87	30.27	18.86	Average	331	169
6	17385.00	62.46	68.20	-5.74	43.60	18.86	Peak	331	169

Note 1: Emission Level (dBuV/m) = SA Reading (dBuV/m) + Factor\* (dB)

\*Factor includes antenna factor , cable loss and amplifier gain

Note 2: Margin (dB) = Emission level (dBuV/m) – Limit (dBuV/m).

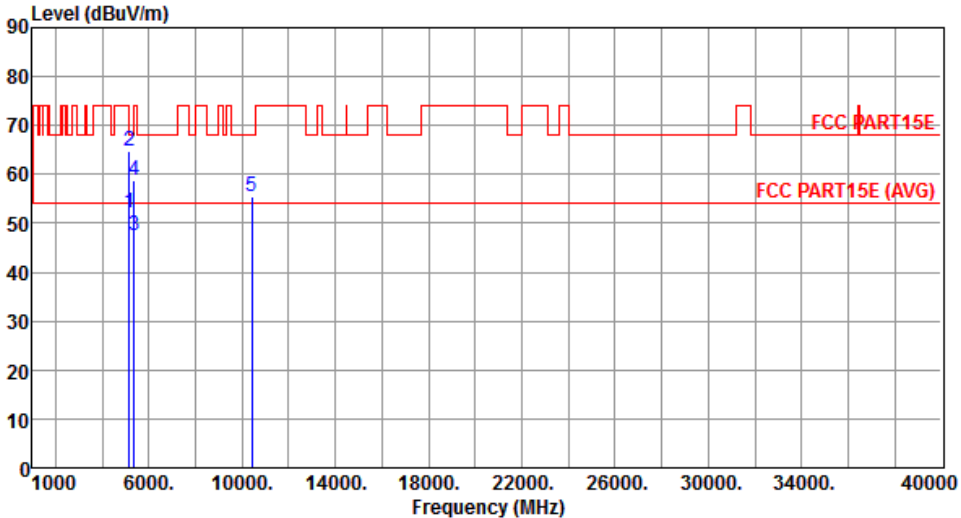

### 3.5.8 Transmitter Radiated Unwanted Emissions (Above 1GHz) for VHT80

Modulation	VHT80	Test Freq. (MHz)	5210																																																																		
Polarization	Horizontal																																																																				
																																																																					
	<table border="1"> <thead> <tr> <th>Freq.</th> <th>Emission level</th> <th>Limit</th> <th>Margin</th> <th>SA reading</th> <th>Factor</th> <th>Remark</th> <th>ANT High</th> <th>Turn Table</th> </tr> <tr> <th>MHz</th> <th>dBuV/m</th> <th>dBuV/m</th> <th>dB</th> <th>dBuV</th> <th>dB</th> <th></th> <th>cm</th> <th>deg</th> </tr> </thead> <tbody> <tr> <td>1</td> <td>5150.00</td> <td>52.01</td> <td>54.00</td> <td>-1.99</td> <td>45.92</td> <td>6.09</td> <td>Average</td> <td>318</td> <td>164</td> </tr> <tr> <td>2</td> <td>5150.00</td> <td>64.91</td> <td>74.00</td> <td>-9.09</td> <td>58.82</td> <td>6.09</td> <td>Peak</td> <td>318</td> <td>164</td> </tr> <tr> <td>3</td> <td>5350.00</td> <td>47.63</td> <td>54.00</td> <td>-6.37</td> <td>41.18</td> <td>6.45</td> <td>Average</td> <td>298</td> <td>163</td> </tr> <tr> <td>4</td> <td>5350.00</td> <td>58.79</td> <td>74.00</td> <td>-15.21</td> <td>52.34</td> <td>6.45</td> <td>Peak</td> <td>298</td> <td>163</td> </tr> <tr> <td>5</td> <td>10420.00</td> <td>55.45</td> <td>68.20</td> <td>-12.75</td> <td>42.33</td> <td>13.12</td> <td>Peak</td> <td>196</td> <td>226</td> </tr> </tbody> </table>	Freq.	Emission level	Limit	Margin	SA reading	Factor	Remark	ANT High	Turn Table	MHz	dBuV/m	dBuV/m	dB	dBuV	dB		cm	deg	1	5150.00	52.01	54.00	-1.99	45.92	6.09	Average	318	164	2	5150.00	64.91	74.00	-9.09	58.82	6.09	Peak	318	164	3	5350.00	47.63	54.00	-6.37	41.18	6.45	Average	298	163	4	5350.00	58.79	74.00	-15.21	52.34	6.45	Peak	298	163	5	10420.00	55.45	68.20	-12.75	42.33	13.12	Peak	196	226
Freq.	Emission level	Limit	Margin	SA reading	Factor	Remark	ANT High	Turn Table																																																													
MHz	dBuV/m	dBuV/m	dB	dBuV	dB		cm	deg																																																													
1	5150.00	52.01	54.00	-1.99	45.92	6.09	Average	318	164																																																												
2	5150.00	64.91	74.00	-9.09	58.82	6.09	Peak	318	164																																																												
3	5350.00	47.63	54.00	-6.37	41.18	6.45	Average	298	163																																																												
4	5350.00	58.79	74.00	-15.21	52.34	6.45	Peak	298	163																																																												
5	10420.00	55.45	68.20	-12.75	42.33	13.12	Peak	196	226																																																												
<p>Note 1: Emission Level (dBuV/m) = SA Reading (dBuV/m) + Factor* (dB)            *Factor includes antenna factor , cable loss and amplifier gain            Note 2: Margin (dB) = Emission level (dBuV/m) – Limit (dBuV/m).</p>																																																																					

<b>Modulation</b>	VHT80	<b>Test Freq. (MHz)</b>	5210
<b>Polarization</b>	Vertical		

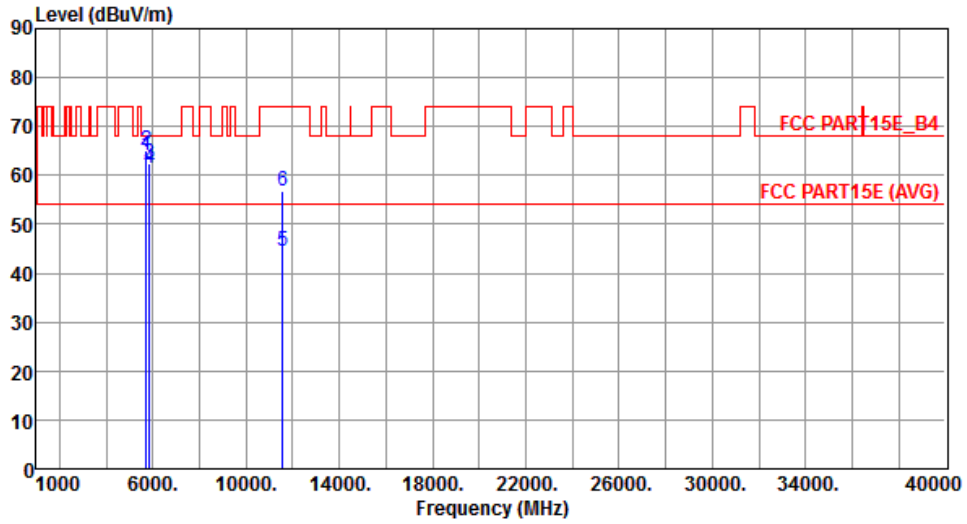

	Freq. MHz	Emission level dBuV/m	Limit dBuV/m	Margin dB	SA reading dBuV	Factor dB	Remark	ANT High cm	Turn Table deg
1	5715.00	64.08	68.20	-4.12	56.66	7.42	Peak	307	7
2	5725.00	65.20	78.20	-13.00	57.76	7.44	Peak	307	7
3	5850.00	62.52	78.20	-15.68	54.66	7.86	Peak	282	20
4	5860.00	61.37	68.20	-6.83	53.48	7.89	Peak	282	20
5	11550.00	44.41	54.00	-9.59	30.40	14.01	Average	261	339
6	11550.00	56.91	74.00	-17.09	42.90	14.01	Peak	261	339

Note 1: Emission Level (dBuV/m) = SA Reading (dBuV/m) + Factor\* (dB)

\*Factor includes antenna factor , cable loss and amplifier gain

Note 2: Margin (dB) = Emission level (dBuV/m) – Limit (dBuV/m).

<b>Modulation</b>	VHT80	<b>Test Freq. (MHz)</b>	5775
<b>Polarization</b>	Horizontal		

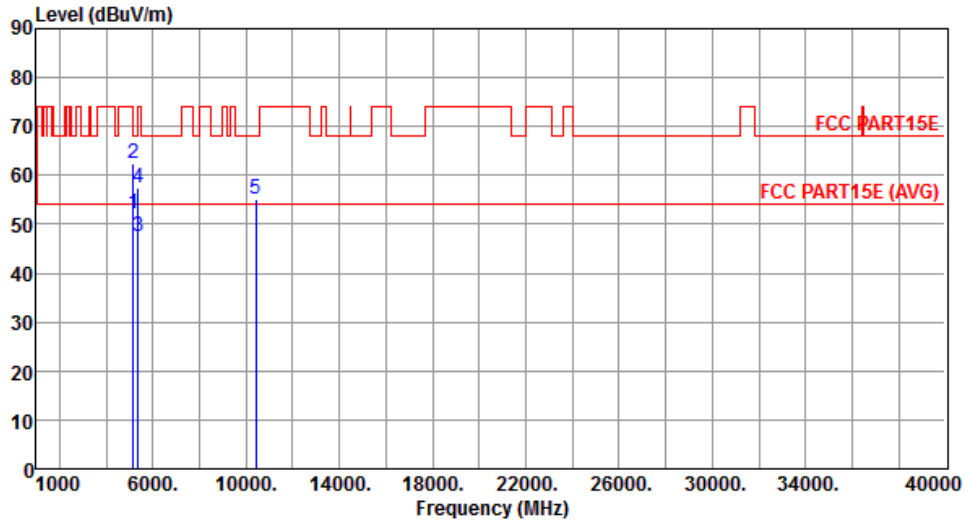

	Freq. MHz	Emission level dBuV/m	Limit dBuV/m	Margin dB	SA reading dBuV	Factor dB	Remark	ANT High cm	Turn Table deg
1	5150.00	52.05	54.00	-1.95	45.96	6.09	Average	313	268
2	5150.00	62.56	74.00	-11.44	56.47	6.09	Peak	313	268
3	5350.00	47.46	54.00	-6.54	41.01	6.45	Average	243	270
4	5350.00	57.54	74.00	-16.46	51.09	6.45	Peak	243	270
5	10420.00	55.08	68.20	-13.12	41.96	13.12	Peak	177	269

Note 1: Emission Level (dBuV/m) = SA Reading (dBuV/m) + Factor\* (dB)

\*Factor includes antenna factor , cable loss and amplifier gain

Note 2: Margin (dB) = Emission level (dBuV/m) – Limit (dBuV/m).

<b>Modulation</b>	VHT80	<b>Test Freq. (MHz)</b>	5775
<b>Polarization</b>	Vertical		

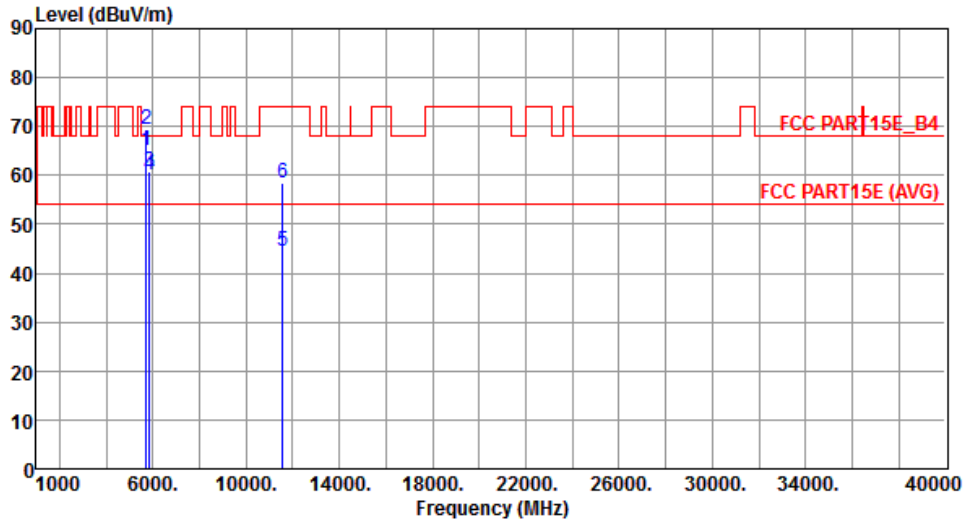

	Freq. MHz	Emission level dBuV/m	Limit dBuV/m	Margin dB	SA reading dBuV	Factor dB	Remark	ANT High cm	Turn Table deg
1	5715.00	65.08	68.20	-3.12	57.66	7.42	Peak	302	266
2	5725.00	69.45	78.20	-8.75	62.01	7.44	Peak	302	266
3	5850.00	60.90	78.20	-17.30	53.04	7.86	Peak	222	247
4	5860.00	60.19	68.20	-8.01	52.30	7.89	Peak	222	247
5	11550.00	44.60	54.00	-9.40	30.59	14.01	Average	271	62
6	11550.00	58.37	74.00	-15.63	44.36	14.01	Peak	271	62

Note 1: Emission Level (dBuV/m) = SA Reading (dBuV/m) + Factor\* (dB)

\*Factor includes antenna factor , cable loss and amplifier gain

Note 2: Margin (dB) = Emission level (dBuV/m) – Limit (dBuV/m).

## 3.6 Frequency Stability

### 3.6.1 Limit of Frequency Stability

Manufacturers of U-NII devices are responsible for ensuring frequency stability such that an emission is maintained within the band of operation under all conditions of normal operation as specified in the user's manual.

### 3.6.2 Test Procedures

1. The EUT is installed in an environment test chamber with external power source.
2. Set the chamber to operate at 20 centigrade and external power source to output at nominal voltage of EUT.
3. A sufficient stabilization period at each temperature is used prior to each frequency measurement.
4. When temperature is stabled, measure the frequency stability.
5. The test shall be performed under normal and extreme conditions.

### 3.6.3 Test Setup

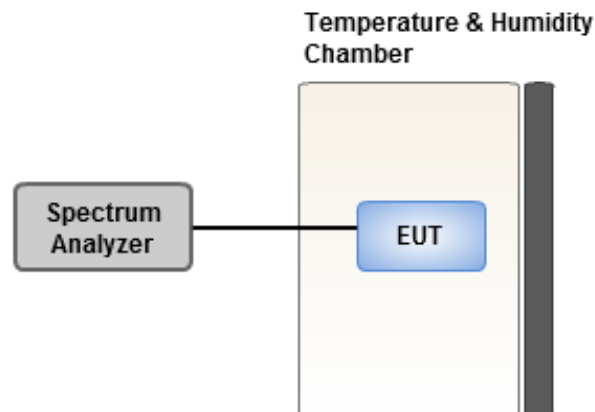

### 3.6.4 Test Result of Frequency Stability

Frequency: 5200 MHz	Frequency Drift (ppm)			
Temperature (°C)	0 minute	2 minutes	5 minutes	10 minutes
T20°CVmax	0.99	1.10	0.96	1.01
T20°CVmin	1.26	1.24	1.26	1.29
T65°CVnom	0.77	0.86	0.74	0.79
T60°CVnom	0.88	0.79	0.86	0.83
T50°CVnom	1.03	1.06	1.05	0.96
T40°CVnom	1.27	1.28	1.27	1.31
T30°CVnom	0.84	0.70	0.83	0.70
T20°CVnom	0.78	0.87	0.83	0.88
T10°CVnom	0.85	0.79	0.86	0.84
T0°CVnom	1.40	1.33	1.32	1.37
T-10°CVnom	1.36	1.27	1.39	1.34
T-20°CVnom	1.15	1.12	1.21	1.20
T-30°CVnom	1.53	1.50	1.56	1.55
Vnom [Vdc]: 4	Vmax [Vdc]: 4.6		Vmin [Vdc]: 3.4	
Tnom [°C]: 20	Tmax [°C]: 65		Tmin [°C]: -30	

Frequency: 5785 MHz	Frequency Drift (ppm)			
Temperature (°C)	0 minute	2 minutes	5 minutes	10 minutes
T20°CVmax	0.89	0.94	0.89	0.91
T20°CVmin	1.11	1.07	1.12	1.16
T65°CVnom	0.64	0.76	0.73	0.75
T60°CVnom	0.85	0.77	0.73	0.71
T50°CVnom	0.84	0.95	0.92	0.94
T40°CVnom	1.07	1.11	1.18	1.13
T30°CVnom	0.70	0.76	0.76	0.64
T20°CVnom	0.77	0.79	0.75	0.76
T10°CVnom	0.78	0.71	0.82	0.79
T0°CVnom	1.12	1.22	1.23	1.22
T-10°CVnom	1.12	1.12	1.16	1.14
T-20°CVnom	1.11	1.03	1.09	1.04
T-30°CVnom	1.40	1.36	1.34	1.37
Vnom [Vdc]: 4	Vmax [Vdc]: 4.6		Vmin [Vdc]: 3.4	
Tnom [°C]: 20	Tmax [°C]: 65		Tmin [°C]: -30	

## 4 Test laboratory information

Established in 2012, ICC provides foremost EMC & RF Testing and advisory consultation services by our skilled engineers and technicians. Our services employ a wide variety of advanced edge test equipment and one of the widest certification extents in the business.

International Certification Corp, it is our definitive objective is to institute long term, trust-based associations with our clients. The expectation we set up with our clients is based on outstanding service, practical expertise and devotion to a certified value structure. Our passion is to grant our clients with best EMC / RF services by oriented knowledgeable and accommodating staff.

Our Test sites are located at Linkou District and Kwei Shan Hsiang. Location map can be found on our website <http://www.icertifi.com.tw>.

### **Linkou**

Tel: 886-2-2601-1640

No. 30-2, Ding Fwu Tsuen, Lin Kou  
District, New Taipei City, Taiwan,  
R.O.C.

### **Kwei Shan**

Tel: 886-3-271-8666

No. 3-1, Lane 6, Wen San 3rd  
St., Kwei Shan Hsiang, Tao Yuan  
Hsien 333, Taiwan, R.O.C.

### **Kwei Shan Site II**

Tel: 886-3-271-8640

No. 14-1, Lane 19, Wen San 3rd  
St., Kwei Shan Hsiang, Tao Yuan  
Hsien 333, Taiwan, R.O.C.

If you have any suggestion, please feel free to contact us as below information

Tel: 886-3-271-8666

Fax: 886-3-318-0155

Email: ICC\_Service@icertifi.com.tw

==END==