



# RADIO TEST REPORT

**Test Report No. : 11014760S-D**

**Applicant** : Sony Corporation.  
**Type of Equipment** : Wireless Transceiver Module  
**Model No.** : BNSY25  
**FCC ID** : AK8BNSY25  
**Test regulation** : FCC Part 15 Subpart E: 2015  
Section 15.407(DFS test only)  
**Test Result** : Complied

1. This test report shall not be reproduced in full or partial, without the written approval of UL Japan, Inc.
2. The results in this report apply only to the sample tested.
3. This sample tested is in compliance with the limits of the above regulation.
4. The test results in this test report are traceable to the national or international standards.
5. This test report must not be used by the customer to claim product certification, approval, or endorsement by any agency of the Federal Government.
6. The opinions and the interpretations to the result of the description in this report are outside scopes where UL Japan has been accredited.
7. This test report covers Radio technical requirements.

It does not cover administrative issues such as Manual or non-Radio test related Requirements. (if applicable)

**Date of test** : December 1, 2015

**Representative test engineer:**   
Kenichi Adachi  
Engineer  
Consumer Technology Division

**Approved by :**   
Toyokazu Imamura  
Leader  
Consumer Technology Division



- The testing in which "Non-accreditation" is displayed is outside the accreditation scopes in UL Japan.  
 There is no testing item of "Non-accreditation".

**UL Japan, Inc.**  
**Shonan EMC Lab.**

1-22-3 Megumigaoka, Hiratsuka-shi, Kanagawa-ken, 259-1220 JAPAN  
Telephone: +81 463 50 6400  
Facsimile: +81 463 50 6401

## REVISION HISTORY

**Original Test Report No.: 11014760S-D**

Revision	Test report No.	Date	Page revised	Contents
- (Original)	11014760S-D	December 24, 2015	-	-
1	11014760S-D	January 13, 2016	p.1-p.2  p.10	Revised report.  Correction of error of power level.

<b>CONTENTS</b>	<b>PAGE</b>
<b>SECTION 1: Customer information.....</b>	<b>4</b>
<b>SECTION 2: Equipment under test (E.U.T.).....</b>	<b>4</b>
<b>SECTION 3: Scope of Report.....</b>	<b>5</b>
<b>SECTION 4: Test specification, procedures &amp; results.....</b>	<b>5</b>
<b>SECTION 5: Operation of E.U.T. during testing.....</b>	<b>10</b>
<b>SECTION 6: In-service monitoring for channel move time, channel closing transmission time.....</b>	<b>15</b>
<b>SECTION 7: In-Service Monitoring for Non-Occupancy Period.....</b>	<b>18</b>
<b>APPENDIX 1: Data of DFS test.....</b>	<b>20</b>
<b>APPENDIX 2: Test instruments.....</b>	<b>21</b>
<b>APPENDIX 3: Photographs of test setup.....</b>	<b>22</b>

---

**UL Japan, Inc.**

**Shonan EMC Lab.**

1-22-3 Megumigaoka, Hiratsuka-shi, Kanagawa-ken, 259-1220 JAPAN

Telephone: +81 463 50 6400

Facsimile: +81 463 50 6401

## **SECTION 1: Customer information**

Company Name : Sony EMCS Corporation  
Address : 8-4 Shiomi Kisarazu-shi, Chiba, 292-0834 Japan  
Telephone Number : +81-438-37-3982  
Contact Person : Kazuhiko Nagano

## **SECTION 2: Equipment under test (E.U.T.)**

### **2.1 Identification of E.U.T.**

Type of Equipment : Wireless Transceiver Module  
Model No. : BNSY25  
Serial No. : Refer to Section 4, Clause 4.2  
Rating : DC 3.3 V, DC 2.8 V, DC 1.8 V  
Receipt Date of Sample : October 7, 2015  
Country of Mass-production : China, Taiwan  
Condition of EUT : Production prototype  
(Not for Sale: This sample is equivalent to mass-produced items.)  
Modification of EUT : No Modification by the test lab

### **2.2 Product description**

Model: BNSY25 (referred to as the EUT in this report) is a Wireless Transceiver Module.  
\* BNSY25 is Controller IC (MT8591, etc.) and RF front-end part (DHSR-SY25).

### **General Specification**

Clock frequency(ies) in the system : 26 MHz

### **Radio Specification**

Radio Type : Transceiver  
Frequency of Operation : Wireless LAN part:  
2412-2462 MHz,  
5180-5320 MHz, 5500-5700 MHz, 5745-5825 MHz  
Bluetooth part:  
2402-2480 MHz  
Modulation : Wireless LAN part:  
2.4 GHz bands: DBPSK, DQPSK, CCK, OFDM  
5 GHz bands: OFDM  
Bluetooth part:  
BDR (Basic Data Rate): GFSK  
EDR (Enhanced Data Rate):  $\pi/4$ -DQPSK, 8DPSK  
LE (Low Energy mode): GFSK  
Antenna type : Dipole  
Antenna connector : MHF4  
Antenna Gain : 2400 - 2483.5 MHz: +0.21 dBi max (include antenna cable 199 mm)  
5150 - 5250 MHz: -2.06 dBi max (include antenna cable 199 mm)  
5250 - 5350 MHz: -0.99 dBi max (include antenna cable 199 mm)  
5470 - 5725 MHz: -0.01 dBi max (include antenna cable 199 mm)  
5725 - 5850 MHz: -0.95 dBi max (include antenna cable 199 mm)

Remarks: This Wireless Module consists of 1 chip each of 5 GHz band and 2.4 GHz band.

\*1) Refer to the test reports: 11014760S-A and -B for FCC 15.247.

\*2) Refer to the test reports: 11014760S-C for FCC 15.407 except DFS test.

---

## **UL Japan, Inc.**

### **Shonan EMC Lab.**

1-22-3 Megumigaoka, Hiratsuka-shi, Kanagawa-ken, 259-1220 JAPAN

Telephone: +81 463 50 6400

Facsimile: +81 463 50 6401

### **SECTION 3: Scope of Report**

The EUT has the channels from 5180 MHz to 5320MHz and 5500 MHz to 5700MHz.  
This report only covers DFS requirement subject to 5250 MHz to 5350 MHz and 5500 MHz to 5700 MHz bands,  
as specified by the following referenced procedures.

### **SECTION 4: Test specification, procedures & results**

#### **4.1 Test Specification**

Test Specification : FCC Part 15 Subpart E: 2015, final revised on November 23, 2015

Title : FCC 47CFR Part15 Radio Frequency Device Subpart E  
Unlicensed National Information Infrastructure Devices  
Section 15.407 General technical requirements

\*Some parts are effective on and after December 17, 2015 or December 23, 2015.  
The revision does not affect the test specification applied to the EUT.

Test Specification FCC KDB 905462 D02 v01r02

Title COMPLIANCE MEASUREMENT PROCEDURES FOR UNLICENSED  
NATIONAL INFORMATION INFRASTRUCTURE DEVICES  
OPERATING IN THE 5250 - 5350 MHz AND 5470 - 5725 MHz BANDS  
INCORPORATING DYNAMIC FREQUENCY SELECTION

## 4.2 Procedures and results

**Table 1: Applicability of DFS Requirements**

Requirement	Operating Mode	Test Procedures & Limits	Deviation	Results
	Client without Radar Detection			
U-NII Detection Bandwidth	Not required	FCC, KDB 905462 D02 Section 7.8.1	N/A	N/A
Initial Channel Availability Check Time	Not required	FCC15.407 (h)(2)	N/A	N/A
		FCC, KDB 905462 D02 Section 7.8.2.1		
		RSS-247 6.3		
Radar Burst at the Beginning of the Channel Availability Check Time	Not required	FCC15.407 (h)(2)	N/A	N/A
		FCC, KDB 905462 D02 Section 7.8.2.2		
		RSS-247 6.3		
Radar Burst at the End of the Channel Availability Check Time	Not required	FCC15.407 (h)(2)	N/A	N/A
		FCC, KDB 905462 D02 Section 7.8.2.3		
		RSS-247 6.3		
In-Service Monitoring for Channel Move Time, Channel Closing Transmission Time	Yes	FCC15.407 (h)(2)	N/A	Complied
		FCC, KDB 905462 D02 Section 7.8.3		
		RSS-247 6.3		
In-Service Monitoring for Non-Occupancy period	Yes *	FCC15.407 (h)(2)	N/A	Complied
		FCC, KDB 905462 D02 Section 7.8.3		
		RSS-247 6.3		
Statistical Performance Check	Not required	FCC15.407 (h)(2)	N/A	N/A
		FCC, KDB 905462 D02 Section 7.8.4		

\*Although this test was not required in FCC, KDB 905462 D02, it was performed as additional test.

**Table 2: DFS Detection Thresholds for Master Devices and Client Devices With Radar**

Maximum Transmit Power	Value (See Notes 1, 2 and 3)
E.I.R.P. $\geq$ 200 milliwatt	-64 dBm
E.I.R.P. < 200 milliwatt and power spectral density < 10dBm/MHz	-62 dBm
E.I.R.P. < 200 milliwatt that do not meet the power spectral density requirement	-64 dBm
<p>Note 1: This is the level at the input of the receiver assuming a 0 dBi receive antenna.</p> <p>Note 2: Throughout these test procedures an additional 1 dB has been added to the amplitude of the test transmission waveforms to account for variations in measurement equipment. This will ensure that the test signal is at or above the detection threshold level to trigger a DFS response.</p> <p>Note 3: E.I.R.P. is based on the highest antenna gain. For MIMO devices refer to KDB Publication 662911 D01.</p>	

## UL Japan, Inc. Shonan EMC Lab.

1-22-3 Megumigaoka, Hiratsuka-shi, Kanagawa-ken, 259-1220 JAPAN  
Telephone: +81 463 50 6400  
Facsimile: +81 463 50 6401

**Table 3: DFS Response Requirement Values**

Parameter	Value
Non-occupancy period	Minimum 30 minutes
Channel Availability Check Time	60 seconds
Channel Move Time	10 seconds See Note 1
Channel Closing Transmission Time	200 milliseconds + an aggregate of 60 milliseconds over remaining 10 second period. See Notes 1 and 2
U-NII Detection Bandwidth	Minimum 100 % of the U-NII 99 % transmission power bandwidth See Note 3
<p><b>Note 1:</b> The Channel Move Time and the Channel Closing Transmission Time should be performed with Radar Type 0. The measurement timing begins at the end of the Radar Type 0 burst.</p> <p><b>Note 2:</b> The Channel Closing Transmission Time is comprised of 200 milliseconds starting at the beginning of the Channel Move Time plus any additional intermittent control signals required to facilitate a Channel move (an aggregate of 60 milliseconds) during the remainder of the 10 second period. The aggregate duration of control signal will not count quiet periods in between transmissions.</p> <p><b>Note 3:</b> During the U-NII Detection Bandwidth detection test, radar type 0 should be used. For each frequency step the minimum percentage of detection is 90 percent. Measurements are performed with no data traffic.</p>	

**Table 4 Short Pulse Radar Test Waveform**

Radar Type	Pulse Width [μs]	PRI [μs]	Number of Pulses	Minimum Percentage of Successful Detection	Minimum Number of Trials
0	1	1428	18	See Note 1	See Note 1
1	1	Test A: 15 unique PRI values randomly selected from the list of 23 PRI values in Table 5a  Test B: 15 unique PRI values randomly selected within the range of 518 - 3066 micro sec., with a minimum increment of 1 micro sec., excluding PRI values selected in Test A	$\text{Roundup} \left( \frac{1}{360} \times (19 \times 10^6) / \text{PRI} [\text{micro sec.}] \right)$	60 %	30
2	1 - 5	150 - 230	23 - 29	60 %	30
3	6 - 10	200 - 500	16 - 18	60 %	30
4	11 - 20	200 - 500	12 - 16	60 %	30
Aggregate (Rader Types 1-4)				80 %	120
Note 1: Short Pulse Radar Type 0 should be used for the detection bandwidth test, channel move time, and channel closing time tests.					

**UL Japan, Inc.**  
**Shonan EMC Lab.**

1-22-3 Megumigaoka, Hiratsuka-shi, Kanagawa-ken, 259-1220 JAPAN  
Telephone: +81 463 50 6400  
Facsimile: +81 463 50 6401

**Table 4a Pulse Repetition Interval Values for Test A**

Pulse Repetition Frequency Number	Pulse Repetition Frequency (Pulses Per Second)	Pulse Repetition Interval (Micro seconds)
1	1930.5	518
2	1858.7	538
3	1792.1	558
4	1730.1	578
5	1672.2	598
6	1618.1	618
7	1567.4	638
8	1519.8	658
9	1474.9	678
10	1432.7	698
11	1392.8	718
12	1355	738
13	1319.3	758
14	1285.3	778
15	1253.1	798
16	1222.5	818
17	1193.3	838
18	1165.6	858
19	1139	878
20	1113.6	898
21	1089.3	918
22	1066.1	938
23	326.2	3066

**Table 5 Long Pulse Radar Test Waveform**

Radar Type	Pulse Width [μs]	Chip Width [MHz]	PRI [μs]	Number of Pulses per <i>Burst</i>	Number of <i>Burst</i>	Minimum Percentage of Successful Detection	Minimum Number of Trials
5	50 - 100	5 - 20	1000 - 2000	1 - 3	8 - 20	80 %	30

**Table 6 Frequency Hopping Radar Test Waveform**

Radar Type	Pulse Width [μs]	PRI [μs]	Pulse per Hop [kHz]	Hopping Rate [kHz]	Hopping Sequence Length [ms]	Minimum Percentage of Successful Detection	Minimum Number of Trials
6	1	333	9	0.333	300	70 %	30



### 4.3 Test Location

UL Japan, Inc. Shonan EMC Lab.

1-22-3, Megumigaoka, Hiratsuka-shi, Kanagawa-ken 259-1220 JAPAN

Telephone number : +81 463 50 6400

Facsimile number : +81 463 50 6401

JAB Accreditation No. : RTL02610

	IC Registration No.	Width x Depth x Height (m)	Size of reference ground plane (m) / horizontal conducting plane	Maximum measurement distance
<input type="checkbox"/> No.1 Semi-anechoic chamber	2973D-1	20.6 x 11.3 x 7.65	20.6 x 11.3	10 m
<input type="checkbox"/> No.2 Semi-anechoic chamber	2973D-2	20.6 x 11.3 x 7.65	20.6 x 11.3	10 m
<input type="checkbox"/> No.3 Semi-anechoic chamber	2973D-3	12.7 x 7.7 x 5.35	12.7 x 7.7	5 m
<input type="checkbox"/> No.4 Semi-anechoic chamber	-	8.1 x 5.1 x 3.55	8.1 x 5.1	-
<input type="checkbox"/> No.1 Shielded room	-	6.8 x 4.1 x 2.7	6.8 x 4.1	-
<input type="checkbox"/> No.2 Shielded room	-	6.8 x 4.1 x 2.7	6.8 x 4.1	-
<input type="checkbox"/> No.3 Shielded room	-	6.3 x 4.7 x 2.7	6.3 x 4.7	-
<input type="checkbox"/> No.4 Shielded room	-	4.4 x 4.7 x 2.7	4.4 x 4.7	-
<input checked="" type="checkbox"/> No.5 Shielded room	-	7.8 x 6.4 x 2.7	7.8 x 6.4	-
<input type="checkbox"/> No.6 Shielded room	-	7.8 x 6.4 x 2.7	7.8 x 6.4	-
<input type="checkbox"/> No.8 shielded room	-	3.45 x 5.5 x 2.4	3.45 x 5.5	-
<input type="checkbox"/> No.1 Measurement room	-	2.55 x 4.1 x 2.5	-	-

### 4.4 Uncertainty

The following uncertainties have been calculated to provide a confidence level of 95 % using a coverage factor  $k = 2$ .

Time Measurement uncertainty for this test was: ( $\pm$ ) 0.012 %

### 4.5 Test set up, Data of DFS test, and Test instruments of DFS

Refer to APPENDIX.

**UL Japan, Inc.**  
**Shonan EMC Lab.**

1-22-3 Megumigaoka, Hiratsuka-shi, Kanagawa-ken, 259-1220 JAPAN

Telephone: +81 463 50 6400

Facsimile: +81 463 50 6401

## **SECTION 5: Operation of E.U.T. during testing**

### **5.1 Operating Modes**

The EUT, which is a Client Device without Radar detection capability, operates over the 5260 MHz - 5320 MHz and 5500 MHz - 5700 MHz.

[W53 Band]

The highest power level is 12.25 dBm EIRP in the 5250 MHz - 5350 MHz band.  
The lowest power level is 11.56 dBm EIRP in the 5250 MHz - 5350 MHz band.

[W56 Band]

The highest power level is 13.15 dBm EIRP in the 5500 MHz - 5700 MHz band.  
The lowest power level is 12.54 dBm EIRP in the 5500 MHz - 5700 MHz band.

Power level of the EUT [dBm]

Antenna	Band	Antenna Gain [dBi] [dBi]	Output Power (Min)	Output Power(Max)
	W53	-0.99	12.55	13.24
	W56	-0.01	12.55	13.16

\*1) Refer to 11014760S-C: FCC Part 15E (FCC 15.407) report for other parts than DFS.

The EUT uses one transmitter connected to a 50 ohm coaxial antenna ports. The antenna port is connected to the test system.

Wireless LAN traffic was generated by the software to transmission data from the Master to the Client.  
That software has random intervals packet data. (Channel loading was over 17 %)  
Software name & version: MT6625 AP Test version 0.2 (for EUT) and Iperf for Windows version 0.5 (for AP).

The EUT utilizes the 802.11a and 802.11n architecture, with a nominal channel bandwidth.  
The EUT had used IEEE 802.11n (HT40) (widest mode).

The FCC ID for the Master Device used with EUT for DFS testing is LDK102087.

The rated output power of the Master unit is > 200 mW (23 dBm). Therefore the required interference threshold level is -64 dBm. After correction for antenna gain and procedural adjustments, the required conducted threshold at the antenna port is  $-64 + 1 + 4 = -59$  dBm (threshold level + additional 1 dB + antenna gain).

## 5.2 Configuration and peripherals

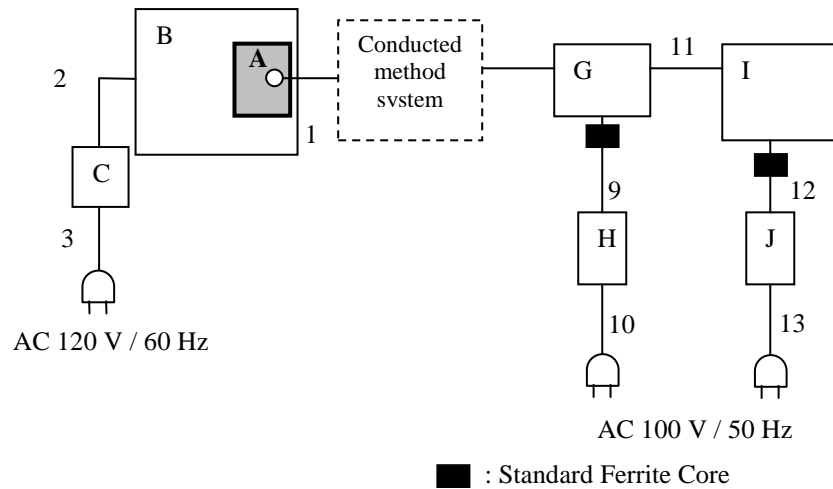

### Description of EUT and Support equipment

No.	Item	Model number	Serial number	Manufacturer	Remarks
A	Wireless Transceiver Module	BNSY25	0F081530001703	Front-end: Wistron NeWeb Corporation Control IC: MediaTeK	EUT
B	Jig board	-	-	Sony	-
C	AC Adaptor	AC-M1208WW	M1521540404	Sony	-
G	Wireless LAN access point (Master Device)	AIR-CAP3702E-A-K9	FTX18227609	Cisco Systems	FCC ID: LDK102087
H	AC Adapter	EADP-18MB	DAB1528MANP	Cisco Systems	-
I	Notebook Computer	DELL Vostro V1510	29090510205	Dell	-
J	ACAdapter	LA65NS1-00	71615-93B-385D	Dell	-

### List of cables used

No.	Cable Name	Length (m)	Shield	
			Cable	Connector
1	Antenna cable	0.199	Shielded	Shielded
2	Output cord (AC Adaptor)	1.0	Unshielded	Unshielded
3	Power Supply Cord	0.7	Unshielded	Unshielded
9	Access Point DC Power	1.8	Unshielded	Unshielded
10	Access Point AC Power	2.0	Unshielded	Unshielded
11	LAN	3.0	Unshielded	Unshielded
12	DELL PC DC Power	1.8	Unshielded	Unshielded
13	DELL PC AC Power	0.7	Unshielded	Unshielded

## UL Japan, Inc. Shonan EMC Lab.

1-22-3 Megumigaoka, Hiratsuka-shi, Kanagawa-ken, 259-1220 JAPAN  
Telephone: +81 463 50 6400  
Facsimile: +81 463 50 6401

### 5.3 Test and Measurement System

#### SYSTEM OVERVIEW

The measurement system is based on a conducted test method.

The software selects waveform parameters from within the bounds of the signal type on a random basis using uniform distribution. The short pulse types 2, 3, and 4, the long pulse type 5, and the frequency hopping type 6 parameters are randomized at run-time.

The signal monitoring equipment consists of a spectrum analyzer with the capacity to display 30001 bins on the horizontal axis. A time-domain resolution of 0.53 ms/bin is achievable with a 16 seconds sweep time, meeting the 10 seconds short pulse reporting criteria. The aggregate ON time is calculated by multiplying the number of bins above a threshold during a particular observation period by the dwell time per bin, with the analyzer set to peak detection. A time-domain resolution of 0.8 ms/bin is achievable with a 24 seconds sweep time, meeting the 22 seconds long pulse reporting criteria and allowing a minimum of 10 seconds after the end of the long pulse waveform.

#### FREQUENCY HOPPING RADAR WAVEFORM GENERATING SUBSYSTEM

The first 100 frequencies are selected out of the hopping sequence of the randomized 475 hop frequencies. Only a *Burst* that has the frequency falling within the receiver bandwidth of the tested U-NII device is selected among those frequencies. (Frequency-domain simulation). The radar waveform generated at the start time of the selected *Burst* (Time-domain simulation) is download to the Signal Generator. If all of the randomly selected 100 frequencies do not fall within the receiver bandwidth of the U-NII device, the radar waveform is not used for the test.

#### CONDUCTED METHODS SYSTEM BLOCK DIAGRAM

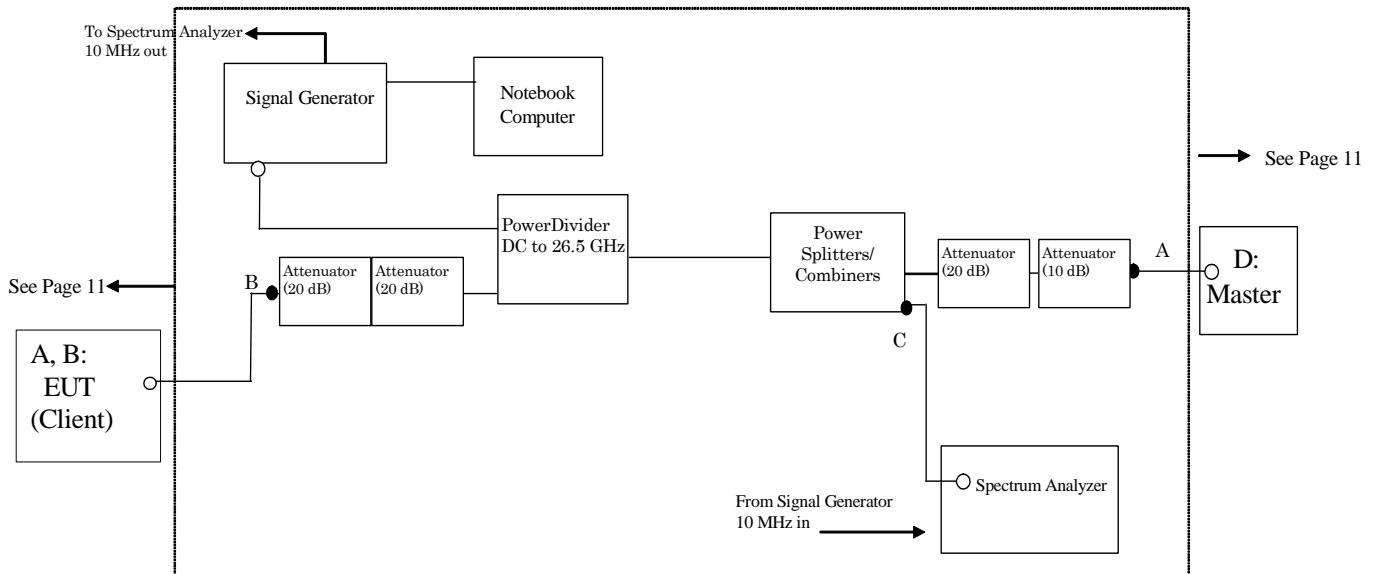

#### MEASUREMENT SYSTEM FREQUENCY REFERENCE

Lock the signal generator and the spectrum analyzer to the same reference sources as follows: Connect the 10 MHz OUT on the signal generator to the 10 MHz IN on the spectrum analyzer and set the spectrum analyzer 10 MHz In to On.

### UL Japan, Inc. Shonan EMC Lab.

1-22-3 Megumigaoka, Hiratsuka-shi, Kanagawa-ken, 259-1220 JAPAN  
Telephone: +81 463 50 6400  
Facsimile: +81 463 50 6401

## SYSTEM CALIBRATION

**Step 1:** Set the system as shown in Figure 3 of KDB 905462 D02, 7.2.2.

**Step 2:** Adjust each attenuator to fulfill the following three conditions:

- WLAN can be communicated, and
- Rader detection threshold level is bigger than Client Device traffic level on the spectrum analyzer, and
- Master Device traffic level is not displayed on the spectrum analyzer.

**Step 3:** Terminate 50 ohm at B and C points, and connect the spectrum analyzer to the point A.

(See the figure on page 12)

At the point A, adjust the signal generator and spectrum analyzer to the center frequency of the channel to be measured. Download the applicable radar waveforms to the signal generator. Select the radar waveform, trigger a burst manually and measure the amplitude on the spectrum analyzer. Readjust the amplitude of the signal generator as required so that the peak level of the waveform is at a displayed level equal to the required or desired interference detection threshold. Separate signal generator amplitude settings are determined as required for each radar type.

**Step 4:** Without changing any of the instrument settings, restore the system setting to Step 2 and adjust the Reference Level Offset of the spectrum analyzer to the level at Step 3.

By taking the above steps 1 to 4, the spectrum analyzer displays the level of the signal generator as received at the antenna ports of the Master Device.

See Clause 5.4 for Plots of Noise, Rader Waveforms, and WLAN signals.

## 5.4 Plots of Noise, Rader Waveforms, and WLAN signals

### Plots of System Noise Floor

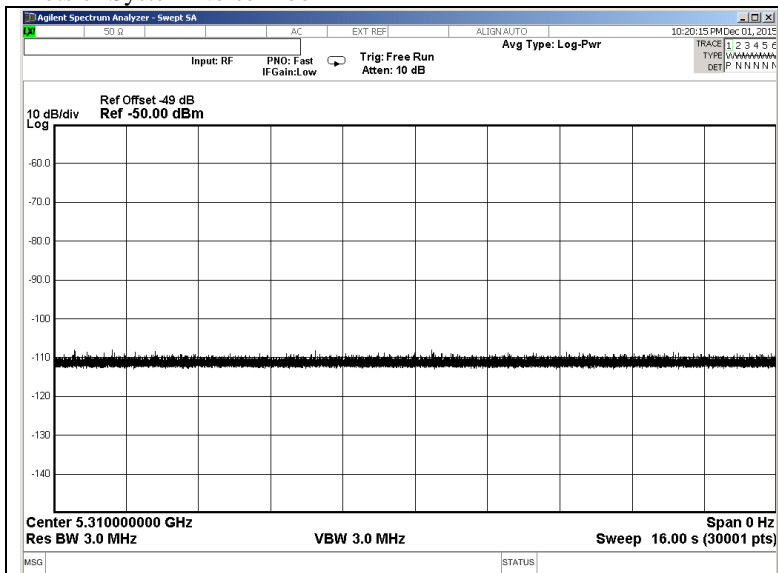

It was confirmed that the EUT did not transmit before having received appropriate control signals from a Master Device.

## UL Japan, Inc. Shonan EMC Lab.

1-22-3 Megumigaoka, Hiratsuka-shi, Kanagawa-ken, 259-1220 JAPAN  
Telephone: +81 463 50 6400  
Facsimile: +81 463 50 6401

Plots of Radar Waveforms

Rader Type 0

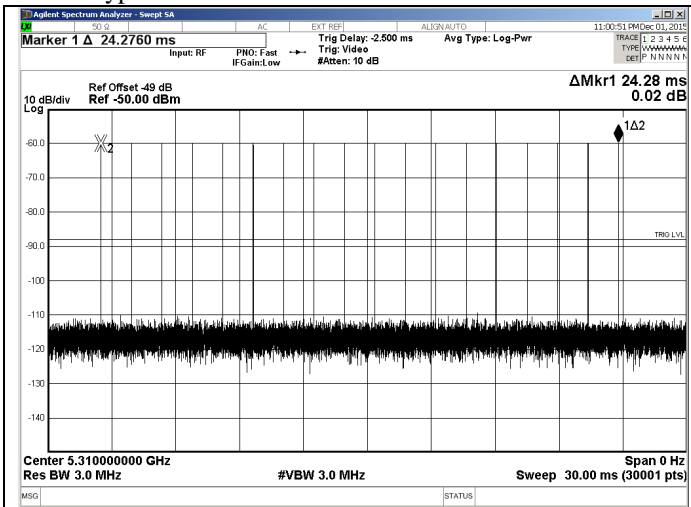

Rader Type 5

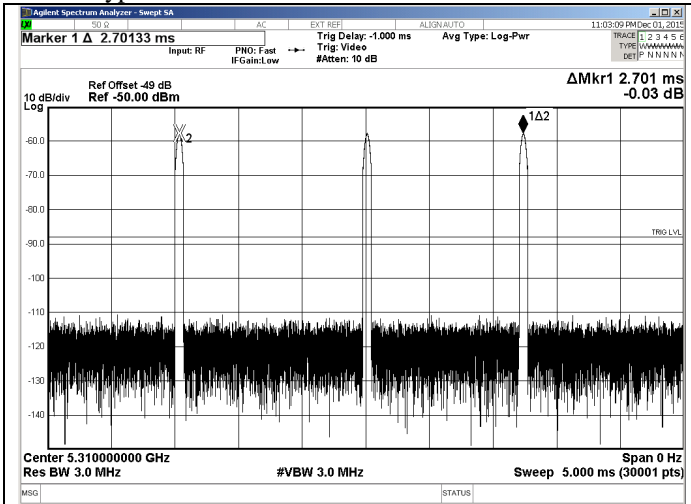

Plots of WLAN Traffic (traffic was about 17 % over)

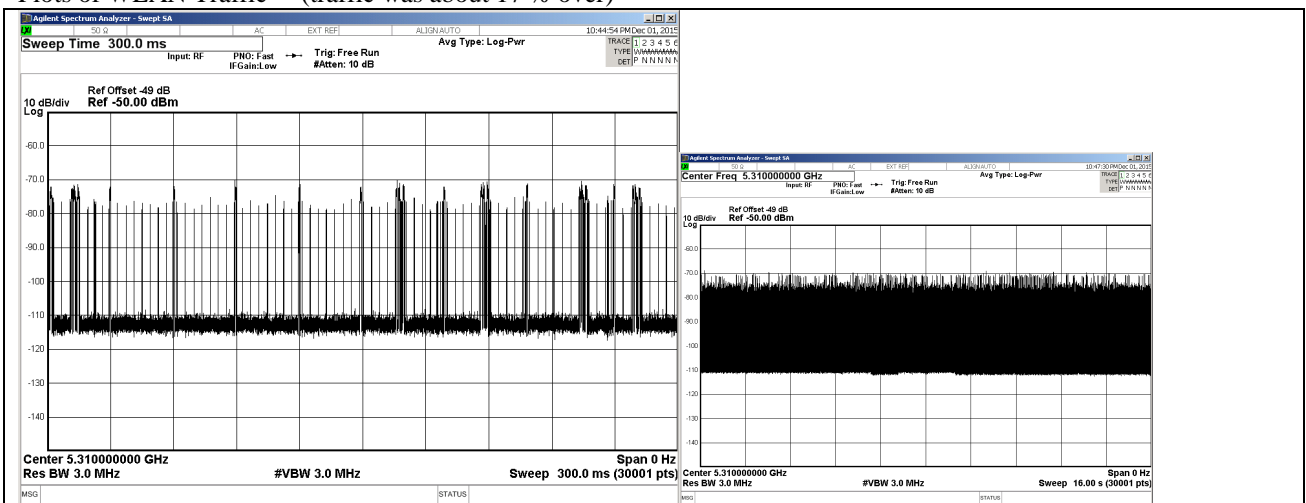

**UL Japan, Inc.**  
**Shonan EMC Lab.**

1-22-3 Megumigaoka, Hiratsuka-shi, Kanagawa-ken, 259-1220 JAPAN

Telephone: +81 463 50 6400

Facsimile: +81 463 50 6401

## **SECTION 6: In-service monitoring for channel move time, channel closing transmission time**

### **6.1 Operating environment**

Test place : No.5 Shielded room  
Temperature : 26 deg.C  
Humidity : 29 %RH

### **6.2 Test Procedure**

Transfer files from the Master Device to the Client Device on the tested channel during the entire period of the test. The Radar Waveform generator sends a Burst of pulses for one of the Short Pulse Radar Types 0 - 4 at levels defined , on the Operating Channel. An additional 1 dB is added to the radar test signal to ensure it is at or above the DFS Detection Threshold, accounting for equipment variations/errors.

Observe the transmissions of the EUT at the end of the radar Burst on the Operating Channel for duration greater than 10 seconds.

### **6.3 Test data**

Test Item	Unit	Measurement Time	Limit	Results
Channel Move Time *1)	[s]	0.065	10.000	Pass
Channel Closing Transmission Time *2)	[ms]	0	60	Pass

\*1) Channel Move Time is calculated as follows:

$$(\text{Channel Move Time}) = (\text{End of Transmission}) - (\text{End of Burst}) = 1.388 - 1.323$$

\*2) Channel Closing Transmission Time is calculated from (End of Burst + 200 ms) to (End of Burst + 10 s)

$$(\text{Channel Closing Transmission Time}) = (\text{Number of analyzer bins showing transmission}) \times (\text{dwell time per bin}) \\ = 0 \times 2 \text{ [ms]}$$

Radar Type 0

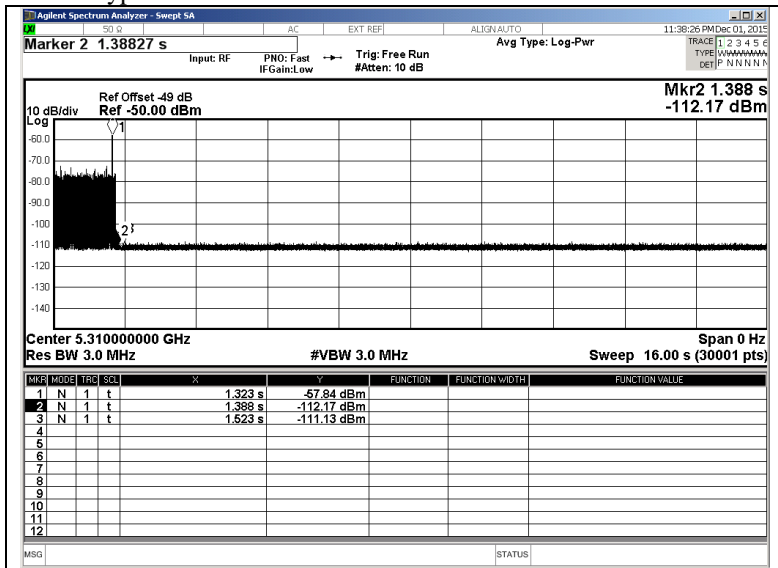

Marker 1: - End of Burst : 1.323 ms  
 Marker 2: - End of Transmission : 1.388 ms

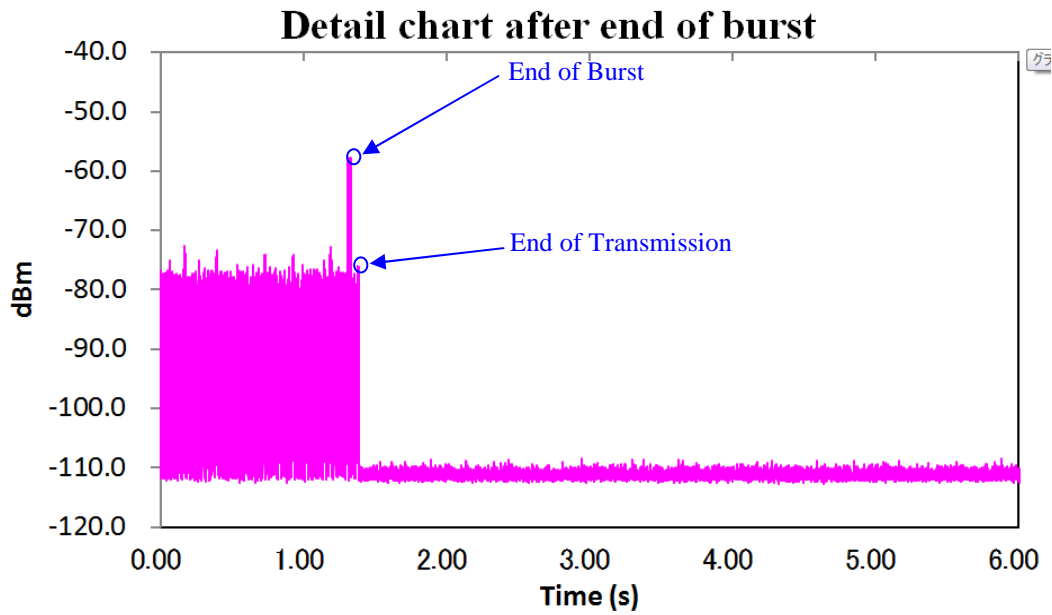

**UL Japan, Inc.**  
**Shonan EMC Lab.**

1-22-3 Megumigaoka, Hiratsuka-shi, Kanagawa-ken, 259-1220 JAPAN  
 Telephone: +81 463 50 6400  
 Facsimile: +81 463 50 6401



Radar Type 5

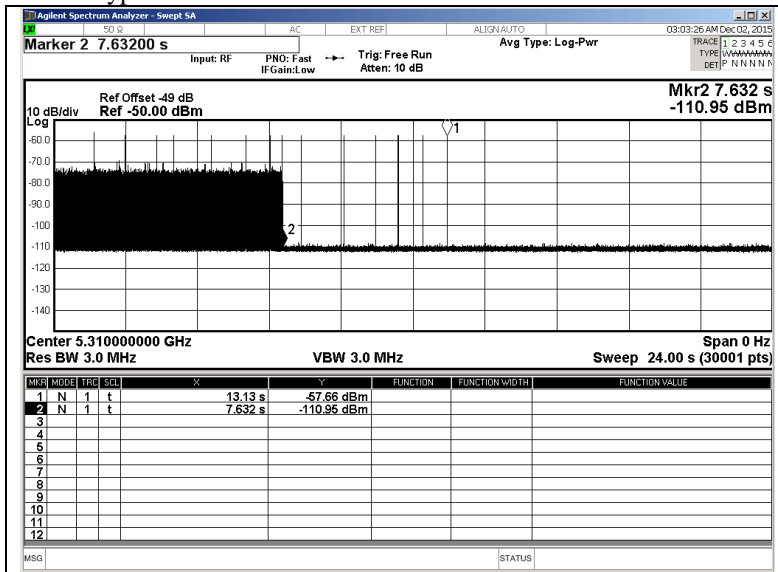

Marker 1 : End of Burst : 13130 ms  
Marker 2 : End of Transmission : 7632 ms

6.4 Test result

Test result: Pass

Date: December 1, 2015 Test engineer: Kenichi Adachi

## SECTION 7: In-Service Monitoring for Non-Occupancy Period

### 7.1 Operating environment

Test place : No.5 Shielded room  
Temperature : 26 deg.C  
Humidity : 29 %RH

### 7.2 Test Procedure

The following two tests are performed:

1). Transfer files from the Master Device to the Client Device on the tested channel during the entire period of the test. The Radar Waveform generator sends a Burst of pulses for one of the Radar Types 0 - 6 at levels defined on the Operating Channel. An additional 1 dB is added to the radar test signal to ensure it is at or above the DFS Detection Threshold, accounting for equipment variations/errors. Observe the transmissions of the EUT after the Channel Move Time on the Operating Channel for duration greater than 30 minutes.

2). Transfer files from the Master Device to the Client Device on the tested channel during the entire period of the test. Observe the transmissions of the EUT on the Operating Channel for duration greater than 30 minutes after the Master Device is shut off.

### 7.3 Test data

#### 1).Radar Type 0

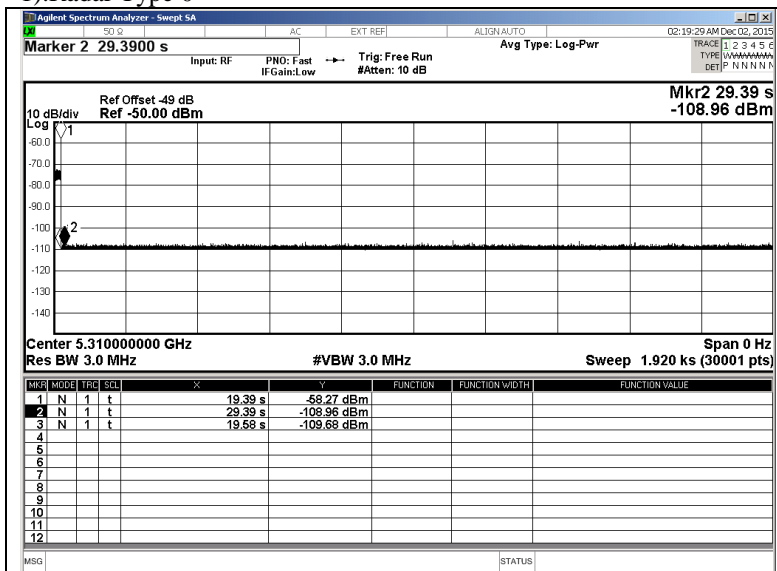

Marker 1 : End of Burst : 19.39 s  
Marker 2 : End of Burst + 10 s : 29.39 s  
Marker 3 : End of transmission : 19.58 s

\* Measurement non-occupancy period: 31.67 minutes or more (1920 [s] – 29.39 [s] = 1900.42[s] = 31.67 [minutes])

2).Master is shut off

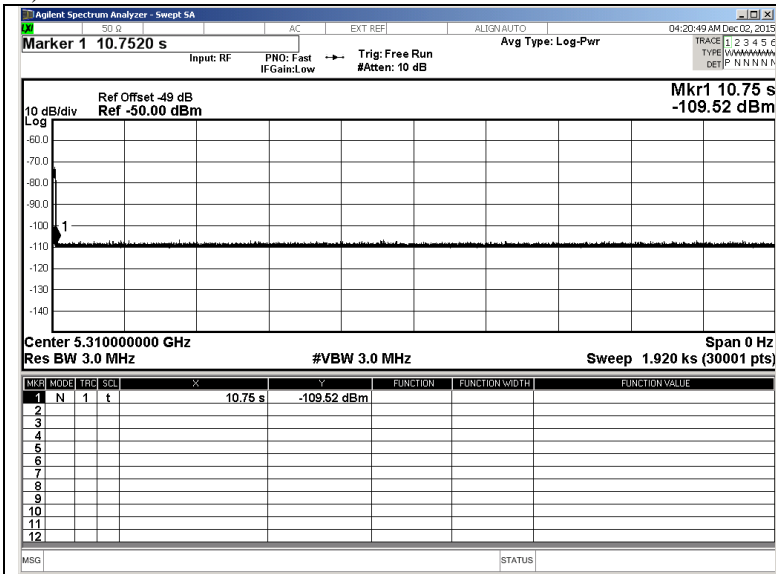

Marker 1 : End of transmission : 10.75 s

\* Measurement non-occupancy period: 31.82 minutes or more (1920 [s]- 10.75 [s] = 1909.25 [s] = 31.82 [minutes])

7.4 Test result

Test result: Pass

Date: December 1, 2015 Test engineer: Kenichi Adachi

**APPENDIX 1: Data of DFS test**

**Parameter Data for Radar Type 5**

Trial Number	Burst	Number of Pulses	Pulse Width [us]	Chirp Width [MHz]	Pulse 1-to-2 Spacing [us]	Pulse 2-to-3 Spacing [us]	Starting Location Within Interval [us]
1	1	1	51	14			87
1	2	3	60	12	1147	1339	186577
1	3	1	85	10			374161
1	4	2	74	16	1729		84688
1	5	1	88	17			500646
1	6	2	90	14	1192		786490
1	7	1	78	9			742621
1	8	3	68	6	1475	1227	288642
1	9	2	55	7	1118		70398
1	10	2	57	9	1594		638006
1	11	1	57	18			839320
1	12	3	92	6	1694	1630	728995
1	13	1	74	14			696522
1	14	1	59	8			652033

## **APPENDIX 2: Test instruments**

### **EMI Test Equipment**

<b>Control No.</b>	<b>Instrument</b>	<b>Manufacturer</b>	<b>Model No</b>	<b>Serial No</b>	<b>Test Item</b>	<b>Calibration Date * Interval(month)</b>
SSA-01	Spectrum Analyzer	Agilent	N9010A-526	MY48031482	DFS	2015/04/10 * 12
SCC-G12	Coaxial Cable	Suhner	SUCOFLEX 102	30790/2	DFS	2015/03/11 * 12
SPSC-08	Power Splitters/Combiners	Mini-Circuits	ZFSC-2-10G+	-	DFS	2015/07/31 * 12
SPSC-07	Power Splitters/Combiners	Mini-Circuits	ZFSC-2-10G+	-	DFS	2015/07/31 * 12
SCC-G31	Coaxial Cable	Junkosha	MWX241-01000KMSKMS	OCT-08-13-046	DFS	2015/04/09 * 12
SSG-02	Signal Generator	Agilent	E8257D-540	MY48051404	DFS	2015/03/02 * 12
SAT20-06	Attenuator	Weinschel Corp.	54A-20	31506	DFS	2015/04/09 * 12
SAT20-07	Attenuator	Weinschel Corp.	54A-20	31484	DFS	2015/04/09 * 12
SCC-G32	Coaxial Cable	Junkosha	MWX241-02000KMSKMS	OCT-09-13-005	DFS	2015/10/08 * 12
SPSC-04	Power Splitters/Combiners	Mini-Circuits	ZN4PD1-63-S+	-	DFS	2015/07/31 * 12
SCC-G24	Coaxial Cable	Suhner	141PE	-	DFS	2015/07/14 * 12
SCC-G25	Coaxial Cable	Suhner	141PE	-	DFS	2015/07/14 * 12
SCC-G26	Coaxial Cable	Suhner	141PE	-	DFS	2015/07/14 * 12
STM-G3	Terminator	Weinschel	M1459A	U6569	DFS	2015/07/14 * 12
SRE-157	Wireless LAN access point	Cisco Systems	AIR-CAP3702E-A-K9	FTX18227609	DFS	-
SAT20-05	Attenuator	Weinschel Corp.	54A-20	Y5649	DFS	2015/11/04 * 12
SCC-G11	Coaxial Cable	Suhner	SUCOFLEX 102	31595/2	DFS	2015/03/11 * 12
COTS-SDFS-01	Signal Studio Software for DFS	Agilent	N7620A-101	5010-7739	DFS	-
COTS-SDFS-02	Radar Generating Software for DFS	Agilent	-	-	DFS	-
SOS-09	Humidity Indicator	A&D	AD-5681	4061484	DFS	2014/12/24 * 12

**The expiration date of the calibration is the end of the expired month.**

**As for some calibrations performed after the tested dates, those test equipment have been controlled by means of an unbroken chains of calibrations.**

**All equipment is calibrated with valid calibrations. Each measurement data is traceable to the national or international standards.**

**Test Item:**

**DFS: Dynamic Frequency Selection**

**UL Japan, Inc.**  
**Shonan EMC Lab.**

1-22-3 Megumigaoka, Hiratsuka-shi, Kanagawa-ken, 259-1220 JAPAN

Telephone: +81 463 50 6400

Facsimile: +81 463 50 6401