

TEST REPORT – EXHIBIT F

1. TRANSMITTER PERFORMANCE TESTS – EXHIBIT I

This section documents the test procedures used, and records the results of tests to demonstrate compliance with the applicable requirements of parts 2 and 87 of the FC Rules and Regulations.

1.1 RF POWER OUTPUT

1.1.1 REQUIREMENTS

FCC Sec. 2.1046

Measurements required: RF power output.

(a) For transmitters other than single sideband, independent sideband and controlled carrier radiotelephone, power output shall be measured at the RF output terminals when the transmitter is adjusted in accordance with the tune-up procedure to give the values of current and voltage on the circuit elements specified in Sec. 2.1033(c)(8). The electrical characteristics of the radio frequency load attached to the output terminals when this test is made shall be stated.

FCC 87.131

Power must be determined by direct measurement. The following lists authorized emissions and maximum power.

Class of Station	Frequency Band	Emissions	Power
Aircraft (Communications)	VHF	A3E, A9W	55 w

The power is measured at the transmitter output terminals and the type of power is determined according to the emission designator as follows:

Mean power (pY) for amplitude modulated emissions and transmitting both sidebands using unmodulated full carrier.

Power is restricted to the minimum necessary to achieve the required service.

1.1.2 TEST PROCEDURE

The VHF-4000E was adjusted in accordance with the tune-up instructions. Primary power supply was set to 27.5 VDC. Unmodulated carrier power was measured at carrier frequency intervals beginning at 118.000 MHz. The RF load for these measurements was a 30 dB attenuator with an HP435B Power Meter. The characteristics of the attenuator and Power Meter were measured with an HP8753C network analyzer and 856046A S-Parameter test set. A table of VSWR values taken vs. frequency from 118 to 137 MHz follows the power data, and shows that the load is essentially 50 ohms resistive over this frequency range.

1.1.3 TEST RESULTS

The first data sheet that follows is the VHF-4000E in AM mode and shows power measurements across the band covered by this transmitter. The power level is the same for 25 kHz channels as it is for 8.33 kHz channels. Part 87 of the FCC Rules does not define a maximum authorized power. The measured power output is typical of that provided in VHF transceivers for commercial aircraft.

The second data sheet which follows is the VHF-4000E in digital data VDL Mode 2 and shows power measurements across the band covered by this transmitter. The measured power output is typical of that provided in VHF transceivers for commercial aircraft for VDL Mode 2 operations.

1.1.4 POWER OUTPUT DATA SHEET

Type Number:	VHF-4000E	Serial Number:	FBLF
Date Tested:	09/14/01	Tested by:	Jerry Chetwynd
Frequency	TX Power Output		
118.000 MHz	20	Watts	
122.000 MHz	18	Watts	
125.000 MHz	18	Watts	
129.000 MHz	18	Watts	
131.000 MHz	18	Watts	
133.000 MHz	17.5	Watts	
136.975 MHz	17.5	Watts	

Type Number:	VHF-4000E VDL MODE 2	Serial Number:	FBLF
Date Tested:	9/25/01	Tested by:	Bob Lombardi
Frequency (MHz)	TX Power Output		
118.000	20.32	Watts	
122.000	20.18	Watts	
125.000	21.09	Watts	
129.000	20.70	Watts	
131.000	22.70	Watts	
133.000	22.34	Watts	
136.975	24.77	Watts	

1.1.5 RF LOAD CHARACTERISTICS

Frequency (MHz)	RF Load VSWR
118.000	1.03:1
122.000	1.03:1
125.000	1.03:1
129.000	1.03:1
131.000	1.03:1
133.000	1.03:1
137.000	1.03:1

1.2 MODULATION CHARACTERISTICS

1.2.1 REQUIREMENTS

FCC Sec. 2.1047

Measurements required: Modulation characteristics.

(a) Voice modulated communication equipment. A curve or equivalent data showing the frequency response of the audio modulating circuit over a range of 100 to 5000 Hz shall be submitted. For equipment required to have an audio low-pass filter, a curve showing the frequency response of the filter, or of all circuitry installed between the modulation limiter and the modulated stage shall be submitted.

(b) Equipment which employs modulation limiting. A curve or family of curves showing the percentage of modulation versus the modulation input voltage shall be supplied. The information submitted shall be sufficient to show modulation limiting capability throughout the range of modulating frequencies and input modulating signal levels employed.

FCC Sec. 87.141

Modulation requirements.

(a) When A3E emission is used, the modulation percentage must not exceed 100 percent. This requirement does not apply to emergency locator transmitters or survival craft transmitters.

(b) A double sideband full carrier amplitude modulated radiotelephone transmitter with rated carrier power output exceeding 10 watts must be capable of automatically preventing modulation in excess of 100 percent.

1.2.2 TEST PROCEDURE

Frequency Response Data

The audio generator is set to 1000 Hz, and its level adjusted to 0.25 Vrms. The transmitter modulation was adjusted to produce 90% modulation on the 25 kHz channels and on the 8.33 kHz channels. While maintaining this input level, the modulation depth is recorded over the frequency range of 100 Hz to 5000 Hz.

Compression Characteristic Data

Next, with audio generator set to 1000 Hz, the modulation depth was recorded for audio generator output levels over the range of 10 mVrms to 1.0 Vrms. This procedure was repeated at modulating frequencies of 100 Hz, 350 Hz, 2500 Hz, and 5000 Hz.

1.2.3 TEST RESULTS

The data following represents the results of these measurements of modulation frequency response and compressor limiting characteristics on the VHF-4000E.

Type Number:	VHF-4000E	Serial Number:	FBLF	
Date Tested:		Tested by:	Jerry Chetwynd	
Frequency Response Data				
	<u>25 kHz Channel, 126.500 MHz</u>		<u>8.33 kHz Channel, 126.500 MHz</u>	
Frequency (Hz)	Modulation Depth (%)	Relative Response (dB)	Modulation Depth (%)	Relative Response (dB)
100	10.2	-18.91	10.7	-19.3
350	74.0	-1.70	73	-1.7
600	88.0	-0.20	82.2	-0.6
1000	90.0	0.00	90.0	0
1500	90.2	0.02	85	-0.3
2000	88.5	-0.15	84	-0.5
2500	82.0	-0.81	77.5	-1.2
3000	63.0	-3.10	7.0	-22
4000	21.2	-12.56	.5	-52
5000	7.3	-21.82	.5	-52

Compression Characteristic Data

Frequency: 100 Hz		
	25 kHz Channel, 126.500 MHz	8.33 kHz Channel, 126.500 MHz
Input Level (mVrms)	Modulation Depth (%)	Modulation Depth (%)
10	1.0	1.0
20	1.1	1.2
30	1.2	1.6
40	1.3	2.0
60	1.5	2.7
80	1.7	3.5
100	2.1	4.3
150	2.7	6.7
300	4.9	10.6
600	9.0	10.6
1000	10.0	10.6

Frequency: 350 Hz		
	25 kHz Channel, 126.500 MHz	8.33 kHz Channel, 126.500 MHz
Input Level (mVrms)	Modulation Depth (%)	Modulation Depth (%)
10	4.5	6.1
20	8.5	11.7
30	11.8	17.5
40	16.0	23.0
60	24.0	34.6
100	39.1	56.5
150	57.9	72.8
300	74.2	72.9
600	74.2	73.2
1000	74.2	73.4

Frequency: 600 Hz

	25 kHz Channel, 126.500 MHz	8.33 kHz Channel, 126.500 MHz
Input Level (mVrms)	Modulation Depth (%)	Modulation Depth (%)
10	4.6	6.3
20	9.8	12.5
30	14.5	18.2
40	18.5	23.9
60	28.0	35.9
80	37.0	47.2
100	47.0	58.7
150	68.3	81.0
300	88.1	82.3
600	89.0	83.0
1000	88.0	83.0

Frequency: 1000 Hz

	25 kHz Channel, 126.500 MHz	8.33 kHz Channel, 126.500 MHz
Input Level (mVrms)	Modulation Depth (%)	Modulation Depth (%)
10	7.3	8.4
20	14.7	15.6
30	20.7	23.5
40	28.0	30.0
60	39.4	46.5
80	52.5	63.0
100	64.6	79.0
150	90.5	88.6
300	90.4	88.8
600	90.2	89.0
1000	90.4	89.0

Frequency: 2000 Hz		
	25 kHz Channel, 126.500 MHz	8.33 kHz Channel, 126.500 MHz
Input Level (mVrms)	Modulation Depth (%)	Modulation Depth (%)
10	14.4	8.6
20	27.0	16.0
30	40.7	24.1
40	51.4	32.1
60	76.3	48.0
80	88.2	64.0
100	88.4	80.0
150	88.4	83.7
300	88.7	83.8
600	88.1	83.8
1000	88.3	83.8

Frequency: 3000 Hz		
	25 kHz Channel, 126.500 MHz	8.33 kHz Channel, 126.500 MHz
Input Level (mVrms)	Modulation Depth (%)	Modulation Depth (%)
10	5.7	1.2
20	10.0	1.7
30	14.0	2.3
40	18.7	2.8
60	27.2	4.0
80	35.3	5.0
100	43.9	6.2
150	62.8	7.0
300	63.0	7.0
600	63.0	6.9
1000	63.0	6.9

Frequency: 4000 Hz		
	<u>25 kHz Channel, 126.500 MHz</u>	<u>8.33 kHz Channel, 126.500 MHz</u>
Input Level (mVrms)	Modulation Depth (%)	Modulation Depth (%)
10	2.5	0.7
20	4.0	0.9
30	5.8	0.9
40	7.0	0.7
60	10.0	0.7
80	13.0	0.7
100	16.0	0.7
150	21.4	0.7
300	22.2	0.4
600	22.2	0.4
1000	21.7	0.4

Frequency: 5000 Hz		
	<u>25 kHz Channel, 126.500 MHz</u>	<u>8.33 kHz Channel, 126.500 MHz</u>
Input Level (mVrms)	Modulation Depth (%)	Modulation Depth (%)
10	1.8	0.7
20	2.4	0.7
30	3.0	0.7
40	3.8	0.7
60	5.2	0.7
80	6.5	0.7
100	7.4	0.7
150	9.3	0.4
300	8.2	0.4
600	8.0	0.4
1000	7.8	0.4

1.3 OCCUPIED BANDWIDTH

1.3.1 REQUIREMENTS

FCC Sec. 2.1049

Measurements required: Occupied bandwidth.

The occupied bandwidth, that is the frequency bandwidth such that, below its lower and above its upper frequency limits, the mean powers radiated are each equal to 0.5 percent of the total mean power radiated by a given emission shall be measured under the following conditions as applicable:

(c) Radiotelephone transmitters equipped with a device to limit modulation or peak envelope power shall be modulated as follows. For single sideband and independent sideband transmitters, the input level of the modulating signal shall be 10 dB greater than that necessary to produce rated peak envelope power.

(1) Other than single sideband or independent sideband transmitters--when modulated by a 2500 Hz tone at an input level 16 dB greater than that necessary to produce 50 percent modulation. The input level shall be established at the frequency of maximum response of the audio modulating circuit.

FCC Sec. 87.135

Bandwidth of emission.

(a) Occupied bandwidth is the width of a frequency band such that, below the lower and above the upper frequency limits, the mean powers emitted are each equal to 0.5 percent of the total mean power of a given emission.

(b) The authorized bandwidth is the maximum occupied bandwidth authorized to be used by a station.

(c) The necessary bandwidth for a given class of emission is the width of the frequency band which is just sufficient to ensure the transmission of information at the rate and with the quality required under specified conditions.

FCC 87.137

In the band, 117.975-136 MHz, the authorized bandwidth is 25 kHz for all transmitter type accepted after 1 January 1974.

1.3.2 TESTS FOR TYPE 5K00A3E EMISSIONS

The VHF-4000E is capable of 5K00A3E emissions on 25 kHz and 8.33 kHz spaced channels. The following tests demonstrate the occupied bandwidth for 25 kHz and 8.33 kHz channels is less than 25 kHz. The following test demonstrates the occupied bandwidth for 8.33 kHz channel operation is less than 8.33 kHz. It also demonstrates that operation on 8.33 kHz channels will have an occupied bandwidth of less than or equal to 5.0 kHz.

1.3.2.1 TEST PROCEDURE

With the radio tuned to 126.5 MHz (25 kHz channel) and at the frequency of maximum response, the audio input level required to produce 50% modulation was determined by temporarily substituting a modulation analyzer for the spectrum analyzer (see test set-up below). The modulating frequency was then set to 2500 Hz, and the input level was 16 dB above that level determined above.

The transmitted spectrum was then displayed with resolution sufficient to resolve adjacent sidebands. The spectral data were recorded and converted to relative power levels. These data were then analyzed to determine the occupied bandwidth such that no more than 0.5 percent of the total radiated power occupied the spectrum above or below this band.

The test was repeated on 126.505 (8.33 kHz channel on 126.500 MHz) using modulating tones of 2500 Hz.

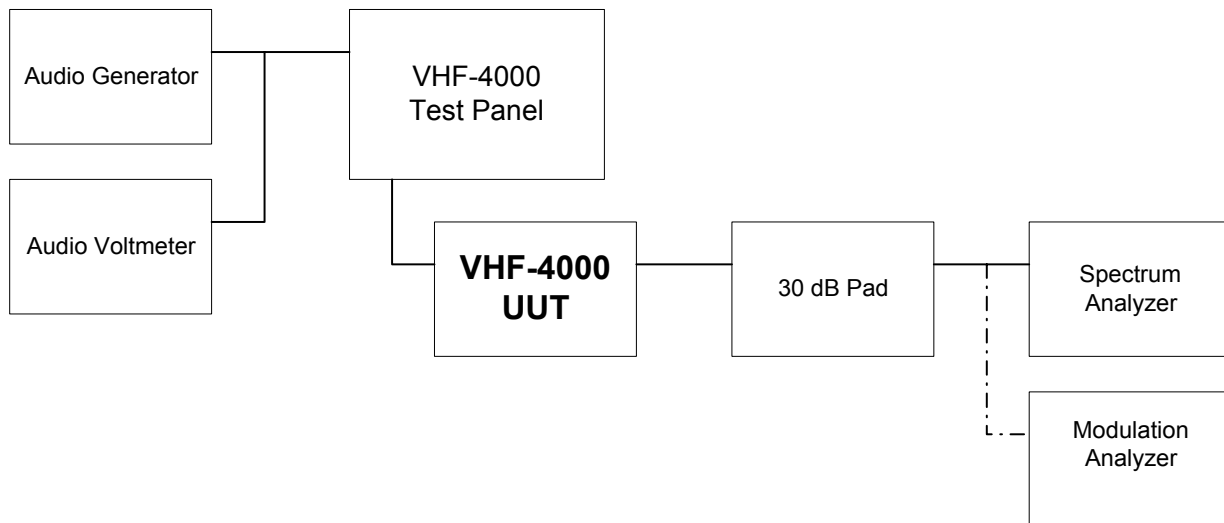

1.3.2.2 TEST RESULTS

The occupied bandwidth is 5 kHz. The plots shown below show the radiated spectrum. The data that follows also shows the measurements and calculations.

25 kHz channel & 2.5 kHz Mod tone

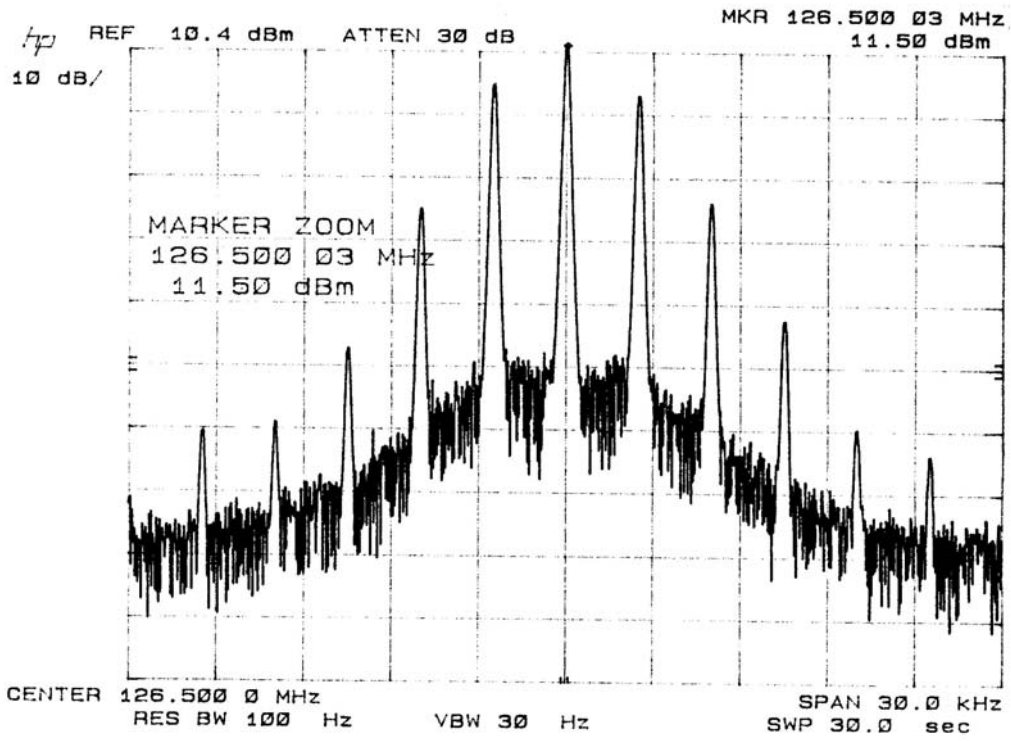

8.33 KHz channel & 2.5 KHz Mod tone

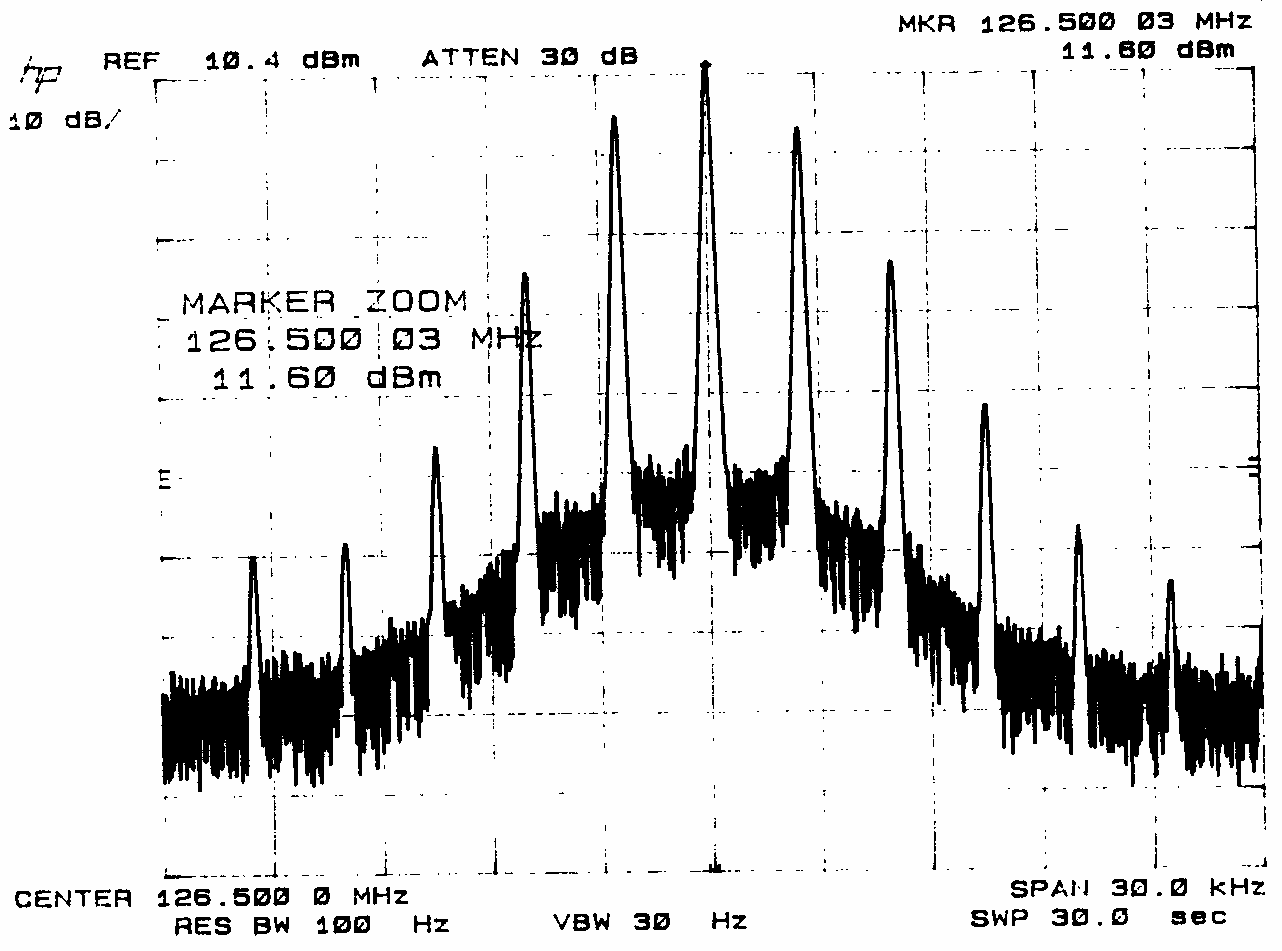

Occupied Bandwidth Data Sheet			
Type Number: VHF-4000E		Serial Number: FBLF	
Date tested: 09/17/01		Tested by: Jerry Chetwynd	
25 kHz channel & 2.5 kHz Mod tone			
Carrier Power = 18 watts		Frequency 126.500 MHz	
Frequency (MHz)	Relative Level (dBc)	Absolute Power (Watts)	% Power
126.5125	-64.7	6.0256E-06	2.41254E-05
126.5100	-60.0	1.7783E-05	7.11991E-05
126.5075	-43.5	0.00079433	0.003180349
126.5050	-26.7	0.03801894	0.15222107
126.5025	-6.99	3.55631319	14.23884526
126.5000	0	17.7827941	71.19914369
126.4975	-6.97	3.57272838	14.30456879
126.4950	-28.5	0.02511886	0.100571464
126.4925	-47.4	0.00032359	0.001295611
126.4900	-62.9	9.1201E-06	3.65153E-05
126.4875	-62.3	1.0471E-05	4.19252E-05
Total Power = 24.976 watts		0.5% of total power = 0.1249 watts	
Power over +/- 2.5 kHz = 24.912 watts			
Percent of total power over +/- 2.5 kHz = 99.744%			
Percent of total power outside +/- 2.5 kHz = 0.256 %			

Occupied Bandwidth Data Sheet			
Type Number: VHF-4000E		Serial Number: FBLF	
Date tested: 09/17/01		Tested by: Jerry Chetwynd	
8.33 kHz channel & 2.5 kHz Mod tone			
Carrier Power = 18 watts		Frequency 126.500 MHz	
Frequency (MHz)	Relative Level (dBc)	Absolute Power (Watts)	% Power outside ±2.5KHz
126.5125	-63.3	8.3176E-06	3.33023E-05
126.5100	-56.4	4.0738E-05	0.000163108
126.5075	-43.4	0.00081283	0.003254429
126.5050	-26.7	0.03801894	0.15222107
126.5025	-7.0	3.54813389	14.20609683
126.5000	0	17.7827941	71.19914369
126.4975	-6.95	3.58921935	14.37059568
126.4950	-28.7	0.02398833	0.096045002
126.4925	-46.2	0.00042658	0.001707948
126.4900	-59.6	1.9498E-05	7.80683E-05
126.4875	-61.5	1.2589E-05	5.04051E-05
Total Power = 24.983 watts		0.5% of total power = 0.1249 watts	
Power over +/- 2.5 kHz = 24.920 watts			
Percent of total power over +/- 2.5 kHz = 99.747%			
Percent of total power outside +/- 2.5 kHz = 0.252%			

1.3.3 TESTS FOR TYPE 14K0G1DE EMISSIONS

1.3.3.1 TEST PROCEDURE

The transceiver was configured to generate an RTCA-formatted message with random characters. The message length was set to the maximum-length message that Mode 2 allows, and the transmitter set to re-send it after one second of pause. The spectrum analyzer was set to "maximum hold", and the transmitted spectrum was displayed. The spectral data were recorded and converted to occupied channel bandwidth by software within the Hewlett Packard Model 8591E spectrum analyzer. This instrument determines the occupied bandwidth such that 0.5 percent of the total radiated power occupies the spectrum above and 0.5 percent below this band.

1.3.3.2 TEST RESULTS

The photo below shows the radiated spectrum. The measured occupied bandwidth is 12.62 kHz which is less than the declared 14 kHz bandwidth associated with the emission designator 14K0G1DE. The emission designator bandwidth was selected by VDL Mode 2 Industry committees at 14 kHz to allow for variances in bandwidth due to hardware and software implementations.

Type Number:	VHF-4000E	Serial Number: FBLF
Date Tested:	09/18/01	Tested by: JERRY CHETWYND
Occupied BW	12.62 kHz for 99.5%	

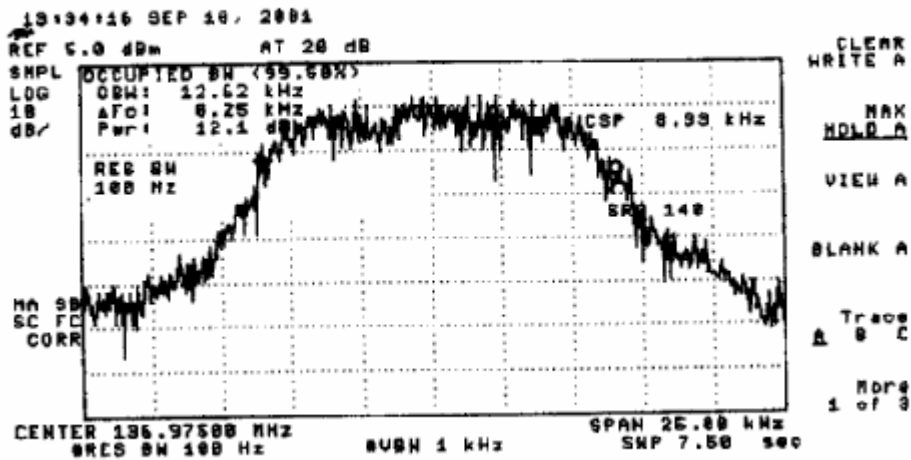

1.3.4 TESTS FOR TYPE 10K0A3D EMISSIONS

1.3.4.1 TEST PROCEDURE

A test generator simulating a standard Aviation Data MODEM (Collins Type DLM-700) was connected to the microphone input of the unit. This MODEM provides 2400 bits per second MSK data at a nominal 1 V RMS which is the specified nominal level for data audio into the VHF-4000. With continuous random data being transmitted from the ACARS MODEM, the transmitted spectrum was displayed using Rohde and Schwarz FSEM 30 Spectrum Analyzer. The complete setup is shown in Figure 2. The Occupied Bandwidth marker function was used with the percentage of power set to 99.5%. The resultant plot is displayed in Figure 1.

Type Number:	VHF-4000E	Serial Number:	FBLF
Date Tested:	10/01/02	Tested by:	STEVE LEBLANC
Occupied BW	5.93 kHz		

1.3.4.2 TEST RESULTS

The occupied bandwidth is 5.93 kHz.

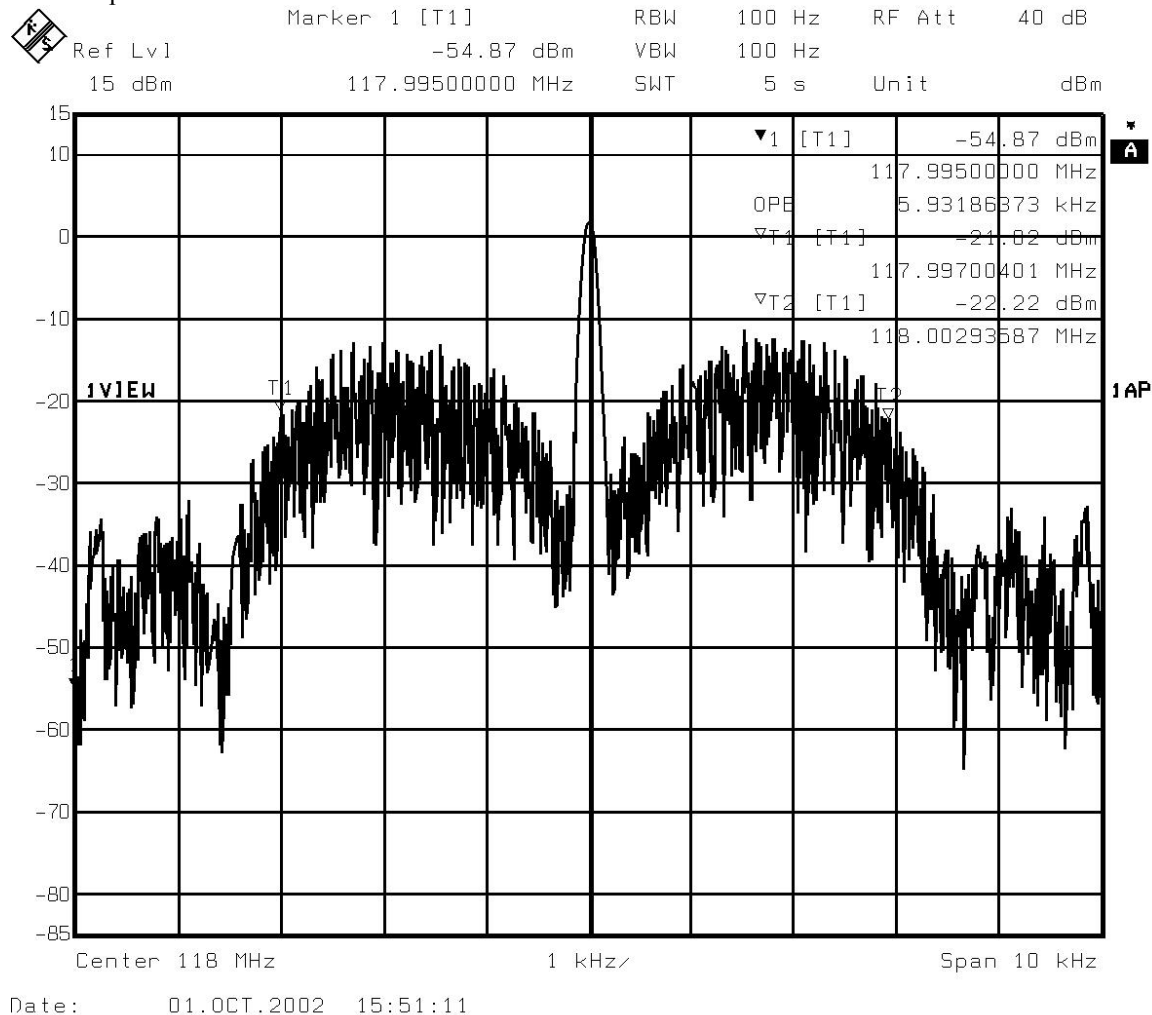

Figure 1

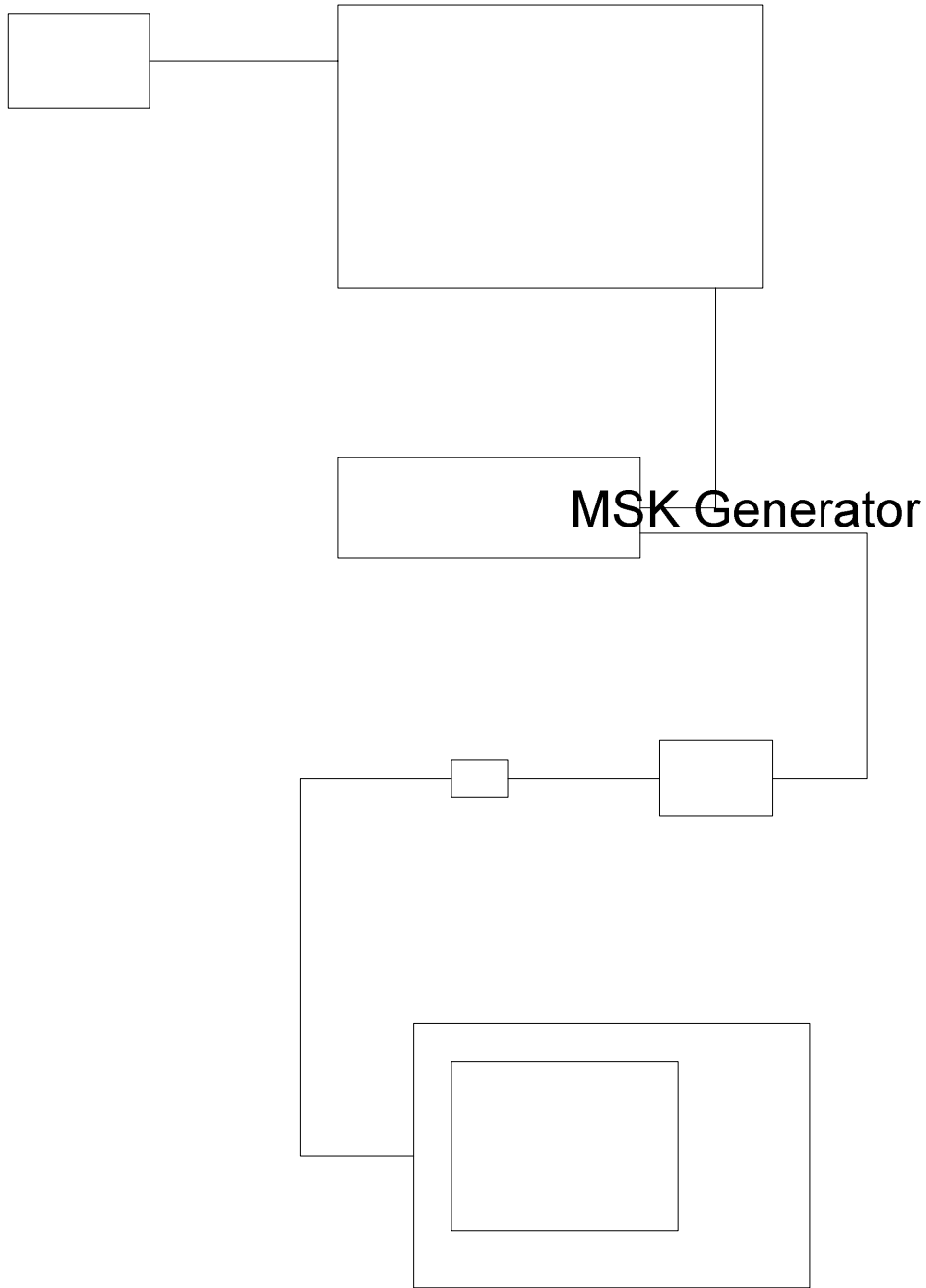

Figure 2

1.4 SPURIOUS EMISSIONS AT ANTENNA TERMINAL

1.4.1 REQUIREMENTS

FCC Sec. 2.1051

Measurements required: Spurious emissions at antenna terminals.

The radio frequency voltage or powers generated within the equipment and appearing on a spurious frequency shall be checked at the equipment output terminals when properly loaded with a suitable artificial antenna. Curves or equivalent data shall show the magnitude of each harmonic and other spurious emission that can be detected when

the equipment is operated under the conditions specified in Sec. 2.1049 as appropriate. The magnitude of spurious emissions which are attenuated more than 20 dB below the permissible value need not be specified.

FCC Sec. 2.1057

Frequency spectrum to be investigated.

(a) In all of the measurements set forth in Secs. 2.1051 and 2.1053, the spectrum shall be investigated from the lowest radio frequency signal generated in the equipment, without going below 9 kHz, up to at least the frequency shown below:

(1) If the equipment operates below 10 GHz: to the tenth harmonic of the highest fundamental frequency or to 40 GHz, whichever is lower.

(b) Particular attention should be paid to harmonics and subharmonics of the carrier frequency as well as to those frequencies removed from the carrier by multiples of the oscillator frequency. Radiation at the frequencies of multiplier stages should also be checked.

(c) The amplitude of spurious emissions which are attenuated more than 20 dB below the permissible value need not be reported.

FCC 87.139 (a)

The mean power of any emissions shall be attenuated below the mean output power of the transmitter (pY) as follows:

- (1) When the frequency is removed from the assigned frequency by more than 50 percent up to and including 100 percent of the authorized bandwidth the attenuation shall be at least 25 dB.
- (2) When the frequency is removed from the assigned frequency by more than 100 percent up to and including 250 percent of the authorized bandwidth the attenuation shall be at least 35 dB.
- (3) On any frequency removed from the assigned frequency by more than 250 percent of the authorized bandwidth the attenuation for aircraft station transmitters shall be at least 40 dB; and the attenuation of aeronautical station transmitters must be at least $43 + 10 * \log_{10}(pY)$ dB.

1.4.2 TEST PROCEDURE

At the frequency of maximum response, the audio input level required to produce 50% modulation was determined by temporarily substituting a modulation analyzer for the spectrum analyzer (see test set-up for modulation characteristics measurements). The modulating frequency was then set to 2500 Hz, and the input level was set 16 dB above that level determined above. The transmitted spectrum was then examined with resolution sufficient to verify that no spurious output exceeded the allowable level. The spectrum was examined to beyond the tenth harmonic.

1.4.3 TEST RESULTS

No spurious output exceeded the allowable level. The following data sheets show the results of the measurements.

Spurious Emissions Data Sheet		
Type Number: VHF-4000E		Serial Number: FBLF
Date tested: 09/19/01		Tested by: Jerry Chetwynd
Measurement at 118.000 MHz		Carrier Power = 20 watts
Maximum allowable power for any spurious emission: -60 dBc		
Spurious Emission Frequency	Relation to Carrier	DB Below Carrier
236.0 MHz	2 nd harmonic	117.8
354.0 MHz	3 rd harmonic	119.4
472.0 MHz	4 th harmonic	>120.0
590.0 MHz	5 th harmonic	114.4
708.0 MHz	6 th harmonic	>120.0
826.0 MHz	7 th harmonic	>120.0
944.0 MHz	8 th harmonic	>120.0
1062.0 MHz	9 th harmonic	>120.0
1180.0 MHz	10 th harmonic	>120.0
1298.0 MHz	11 th harmonic	>120.0
1416.0 MHz	12 th harmonic	>120.0
1534.0 MHz	13 th harmonic	>120.0
1652.0 MHz	14 th harmonic	>120.0
No further harmonics measured		
115.5 MHz	Non-harmonic spurious	95
138.6 MHz	Non-harmonic spurious	115
No other non – harmonic spurious emissions were noted		

Spurious Emissions Data Sheet		
Type Number: VHF-4000E		Serial Number: FBLF
Date tested: 09/19/01		Tested by: Jerry Chetwynd
Measurement at 127.000 MHz		Carrier Power = 18 watts
Maximum allowable power for any spurious emission: -60 dBc		
Spurious Emission Frequency	Relation to Carrier	DB Below Carrier
254.0 MHz	2 nd harmonic	117.6
381.0 MHz	3 rd harmonic	99.0
508.0 MHz	4 th harmonic	>120.0
635.0 MHz	5 th harmonic	113.9
762.0 MHz	6 th harmonic	>120.0
889.0 MHz	7 th harmonic	>120.0
1016.0 MHz	8 th harmonic	>120.0
1143.0 MHz	9 th harmonic	>120.0
1270.0 MHz	10 th harmonic	>120.0
1397.0 MHz	11 th harmonic	>120.0
1524.0 MHz	12 th harmonic	>120.0
1651.0 MHz	13 th harmonic	>120.0
No further harmonics measured		
115.5 MHz	Non-harmonic spurious	105
138.6 MHz	Non-harmonic spurious	110
No non-harmonic spurious emission were noted.		

Spurious Emissions Data Sheet		
Type Number: VHF-4000E		Serial Number: FBLF
Date tested: 09/19/01		Tested by: Jerry Chetwynd
Measurement at 136.975 MHz		Carrier Power = 18 watts
Maximum allowable power for any spurious emission: -60 dBc		
Spurious Emission Frequency	Relation to Carrier	DB Below Carrier
273.95 MHz	2 nd harmonic	117.4
410.925 MHz	3 rd harmonic	95.5
547.9 MHz	4 th harmonic	>120.0
684.875 MHz	5 th harmonic	113.7
821.85 MHz	6 th harmonic	>120.0
958.825 MHz	7 th harmonic	>120.0
1095.8 MHz	8 th harmonic	>120.0
1232.775 MHz	9 th harmonic	>120.0
1369.750 MHz	10 th harmonic	>120.0
1506.725 MHz	11 th harmonic	>120.0
1643.700 MHz	12 th harmonic	>120.0
1780.675 MHz	13 th harmonic	>120.0
No further harmonics measured		
138.6 MHz	Non-harmonic spurious	105
No non-harmonic spurious emission were noted.		

1.5 FIELD STRENGTH OF SPURIOUS RADIATION

1.5.1 REQUIREMENTS

FCC Sec. 2.1053

Measurements required: Field strength of spurious radiation.

(a) Measurements shall be made to detect spurious emissions that may be radiated directly from the cabinet, control circuits, power leads, or intermediate circuit elements under normal conditions of installation and operation. Curves or equivalent data shall be supplied showing the magnitude of each harmonic and other spurious emission. For equipment operating on frequencies below 890 MHz, an open field test is normally required, with the measuring instrument antenna located in the far-field at all test frequencies. Information submitted shall include the relative radiated power of each spurious emission with reference to the rated power output of the transmitter, assuming all emissions are radiated from half-wave dipole antennas.

(b) The measurements specified in paragraph (a) of this section shall be made for the following equipment:

- (1) Those in which the spurious emissions are required to be 60 dB or more below the mean power of the transmitter.
- (2) (2) All equipment operating on frequencies higher than 25 MHz.

FCC Sec. 2.1057

Frequency spectrum to be investigated.

(a) In all of the measurements set forth in Secs. 2.1051 and 2.1053, the spectrum shall be investigated from the lowest radio frequency signal generated in the equipment, without going below 9 kHz, up to at least the frequency shown below:

(1) If the equipment operates below 10 GHz: to the tenth harmonic of the highest fundamental frequency or to 40 GHz, whichever is lower.

(b) Particular attention should be paid to harmonics and subharmonics of the carrier frequency as well as to those frequencies removed from the carrier by multiples of the oscillator frequency. Radiation at the frequencies of multiplier stages should also be checked.

(c) The amplitude of spurious emissions which are attenuated more than 20 dB below the permissible value need not be reported.

FCC 87.139 (a)

The mean power of any emissions shall be attenuated below the mean output power of the transmitter (pY) as follows:

- (1) When the frequency is removed from the assigned frequency by more than 50 percent up to and including 100 percent of the authorized bandwidth the attenuation shall be at least 25 dB.
- (2) When the frequency is removed from the assigned frequency by more than 100 percent up to and including 250 percent of the authorized bandwidth the attenuation shall be at least 35 dB.
- (3) On any frequency removed from the assigned frequency by more than 250 percent of the authorized bandwidth the attenuation for aircraft station transmitters shall be at least 40 dB; and the attenuation for aeronautical station transmitters must be at least $43 + 10 * \log_{10}(pY)$ dB.

1.5.2 TEST PROCEDURE

This test was performed on an open-field range meeting the requirements of ANSI Standard c63.4-1992. Testing was performed in Rubicom Systems, Inc., 284 West Drive, Melbourne FL. Rockwell Collins supplied the VHF-4000E unit to be tested, mounting tray, cables, interface unit and power supply. Rubicom supplied radiated measuring equipment (calibrated antennae and spectrum analyzer) and measurement platform.

1.5.3 TEST RESULTS

The test report indicates the requirements were met. The test report from Rubicom Systems, Inc. is in Exhibit K.

1.6 FREQUENCY STABILITY

1.6.1 REQUIREMENTS

FCC Sec. 2.1055 (a)

Measurements required: Frequency stability.

(a) The frequency stability shall be measured with variation of ambient temperature as follows:

(2) From -20 deg. to +50 deg. centigrade for equipment to be licensed for use in the Maritime Services under part 80 of this chapter, except for Class A, B, and S Emergency Position Indicating Radiobeacons (EPIRBS), and equipment to be licensed for use above 952 MHz at operational fixed stations in all services, stations in the Local Television Transmission Service and Point-to-Point Microwave Radio Service under part 21 of this chapter, and equipment licensed for use aboard aircraft in the Aviation Services under part 87 of this chapter.

FCC 2.1055 (b)

Frequency measurements shall be made at the extremes of the specified temperature range and at intervals of not more than 10 deg. centigrade through the range. A period of time sufficient to stabilize all of the components of the oscillator circuit at each temperature level shall be allowed prior to frequency measurement. The short term transient effects on the frequency of the transmitter due to keying (except for broadcast transmitters) and any heating element cycling normally occurring at each ambient temperature level also shall be shown. Only the portion or portions of the transmitter containing the frequency determining and stabilizing circuitry need be subjected to the temperature variation test.

FCC 2.1055 (d)

The frequency stability shall be measured with variation of primary supply voltage as follows:

(1) Vary primary supply voltage from 85 to 115 percent of the nominal value for other than hand carried battery equipment.

(2) The supply voltage shall be measured at the input to the cable normally provided with the equipment, or at the power supply terminals if cables are not normally provided. Effects on frequency of transmitter keying at the nominal supply voltage and at each extreme also shall be shown.

FCC 87.133 (a)

The carrier frequency of each station in the Aviation Services shall be maintained with the following percentage of the assigned frequency:

Band – 100 to 137 MHz

Aircraft stations – 30 ppm (+/- 4109 Hz at test frequency of 136.975 MHz)

1.6.2 TEST PROCEDURE

Frequency Stability with Temperature

The transceiver was tuned to 136.975 MHz. Due to the nature of the frequency synthesizer design, any frequency error will be the highest at this operating frequency. Chamber air temperature was adjusted to -20 degrees C, and maintained for at least thirty minutes to allow circuit element stabilization before data were taken. The transmitter was then keyed, and the steady state frequency was recorded.

To observe the keying transient, the transmitter output signal was mixed with the output of a signal generator. The signal generator frequency was adjusted to produce a low audio-frequency beat note against the transmitter steady-state frequency. The beat frequency was observed on an oscilloscope, triggered when the transmitter was keyed. This procedure was repeated at 10 degrees C intervals to $+50$ degrees c. Steady state frequency measurements were taken every 10 degrees C. Keying transient measurements were taken at the temperature extremes and at 25 degrees C.

Frequency Stability with Supply Voltage

This transceiver is intended for operation in 27.5 VDC electrical systems. Steady-state and transient frequency measurements were made at nominal supply voltage, and at 85% and 115% of nominal voltage. The transceiver was tuned to a frequency of 136.975 MHz. These measurements were made at nominal room temperature.

1.6.3 TEST RESULTS

The requirements were met. The data sheets show steady-state frequency at each temperature and line voltage. The oscilloscope photographs show the beat frequency as a function of time, after keying the transmitter, between the transmit frequency and a stable reference oscillator offset 1 kHz from 136.975000 MHz. No keying transients were observable.

Frequency Stability Data Sheet			
Type Number:	VHF-4000E	Serial Number:	FBLF
Data Tested	09/17/01	Tested by:	Jerry Chetwynd
Frequency Stability with Temperature			
Temperature	Measured Frequency (MHz)	Frequency Error	
-20 ° C	136.975040	40HZ	
-10 ° C	136.975030	30HZ	
-0 ° C	136.975080	80HZ	
+10 ° C	136.975100	100HZ	
+20 ° C	136.975050	50HZ	
+30 ° C	136.975040	40HZ	
+40 ° C	136.975040	40HZ	
+50 ° C	136.975120	120HZ	
Maximum Allowable Frequency Error = 4109 Hz			

Frequency Stability with Supply Voltage		
Supply Voltage	Measured Frequency	Frequency Error (Hz)
23.38 VDC (85%)	136.975050	50HZ
27.50 VDU	136.975050	50HZ
31.63 VDC (115%)	136.975050	50HZ
Maximum Allowable Frequency Error – 4109 Hz		

Keying Transients with Temperature

Keying Transients – Temperature -20°C

CH2 200mV BWL50 A 1ms 0.0 V CH1

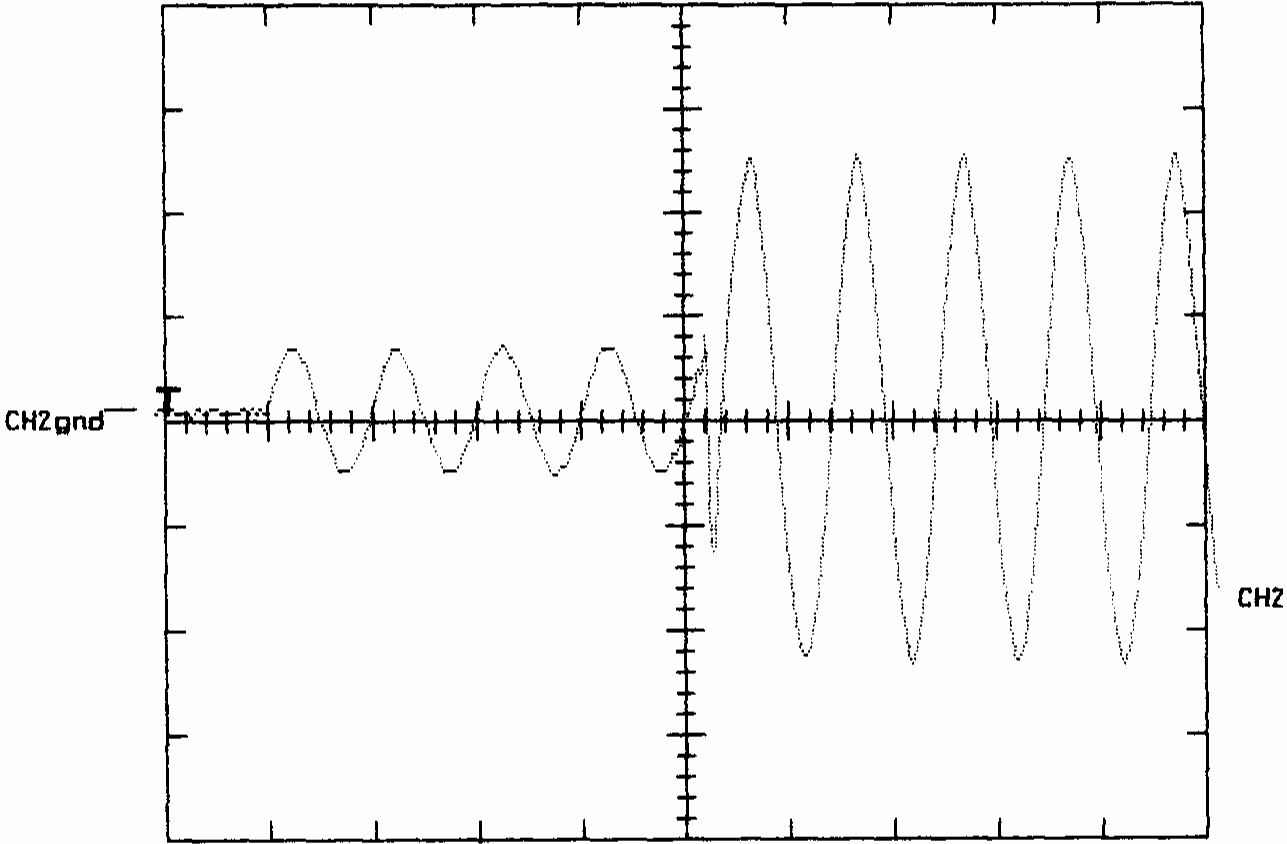

Keying Transients – Temperature 25 ° C

CH2 200mV BWL50 A 1ms 0.0 V CH1
917.43 Hz

