



MC8780 Test Report

for

FCC Certification

FCC ID: N7NMC8780

Prepared by
SIERRA WIRELESS INC.
13811 WIRELESS WAY
RICHMOND, BC V6V 3A4
CANADA

© 2007 Sierra Wireless, Inc.

This document contains information which is proprietary and confidential to Sierra Wireless, Inc. Disclosure to persons other than the officers, employees, agents, or subcontractors of the Company or licensee of this document without the prior written permission of Sierra Wireless, Inc. is strictly prohibited.

SIERRA WIRELESS, INC.

FCC Part 22 & 24 Test Report	MC8780	Apr 18, 2007	Page 2 of 67
------------------------------	--------	--------------	--------------

Table of Contents

1	Introduction and Purpose.....	3
2	Test Summary	3
3	Description of Equipment Under Test	4
4	RF Power Output	4
4.1	<i>Test Procedure</i>	4
4.2	<i>Test Equipment</i>	5
4.3	<i>Test Results GSM/EDGE</i>	5
4.4	<i>Test Results UMTS</i>	5
4.5	<i>Test Settings for UMTS Mode on the CMU200</i>	6
5	Occupied Bandwidth.....	7
5.1	<i>Test Procedure</i>	7
5.2	<i>Test Results</i>	8
5.3	<i>Test Plots</i>	9
6	Out of Band Emissions at Antenna Terminals	18
6.1	<i>Test Procedure</i>	18
6.2	<i>Test Equipment</i>	18
6.3	<i>Test Results</i>	19
6.4	<i>Test Plots</i>	20
7	Block Edge Compliance.....	56
7.1	<i>Test Procedure</i>	56
7.2	<i>Test Equipment</i>	56
7.3	<i>Test Results</i>	56
7.4	<i>Test Plots</i>	57
8	Frequency Stability Versus Temperature.....	63
8.1	<i>Summary of Results</i>	63
8.2	<i>Test Procedure</i>	63
8.3	<i>Test Equipment</i>	63
8.4	<i>Test Results</i>	64
9	Frequency Stability Versus Voltage	66
9.1	<i>Summary of Results</i>	66
9.2	<i>Test Procedure</i>	66
9.3	<i>Test Equipment</i>	66
9.4	<i>Test Results</i>	67

SIERRA WIRELESS, INC.

FCC Part 22 & 24 Test Report	MC8780	Apr 18, 2007	Page 3 of 67
------------------------------	--------	--------------	--------------

1 Introduction and Purpose

This document provides the MC8780 wireless modem test data for the FCC certification. The tests included in this report are limited to all conducted tests required. The radiated tests were performed at an external test facility.

2 Test Summary

FCC RULE	DESCRIPTION OF TEST	RESULT	PAGE
2.1046	RF Power Output	Complies	5
2.1049	Occupied Bandwidth	Complies	8
2.1051, 22.901(d) 22.917, 24.238(a)	Out of Band Emissions at Antenna Terminals	Complies	19
FCC part 22H/24E	Block Edge Requirements	Complies	56
2.1053	Field Strength of Spurious Radiation	Complies	See CCS Report
2.1055	Frequency Stability versus Temperature	Complies	63
2.1055	Frequency Stability versus Voltage	Complies	66

The tests described in this report were performed by Mr. Philip Wright at:

Sierra Wireless, Inc.
13811 Wireless Way
Richmond, B.C. V6V 3A4
Canada

© 2007 Sierra Wireless, Inc.

The contents of this page are subject to the confidentiality information on page one.

SIERRA WIRELESS, INC.

3 Description of Equipment Under Test

The Sierra Wireless Inc. model MC8780 is a multi-band wireless modem operating on the GSM/GPRS/EDGE/UMTS network. In the US and Canada, only cellular and PCS bands are used for GSM/GPRS/UMTS operation, so this test report only contains data for these two bands (850MHz and 1900MHz).

4 RF Power Output

FCC 2.1046

4.1 Test Procedure

The transmitter output was connected to a Rohde & Schwarz CMU200 Test Set and configured to operate at maximum power in a call. The power was measured using the spectrum analyzer at three equally spaced operating frequencies for each band. The RBW was set to 300 KHz for the GSM and EDGE measurements, and 5MHz for the WCDMA measurements. The spectrum analyzer was set to measure the RF output power with the cable and coupler losses accounted for.

Test Setup

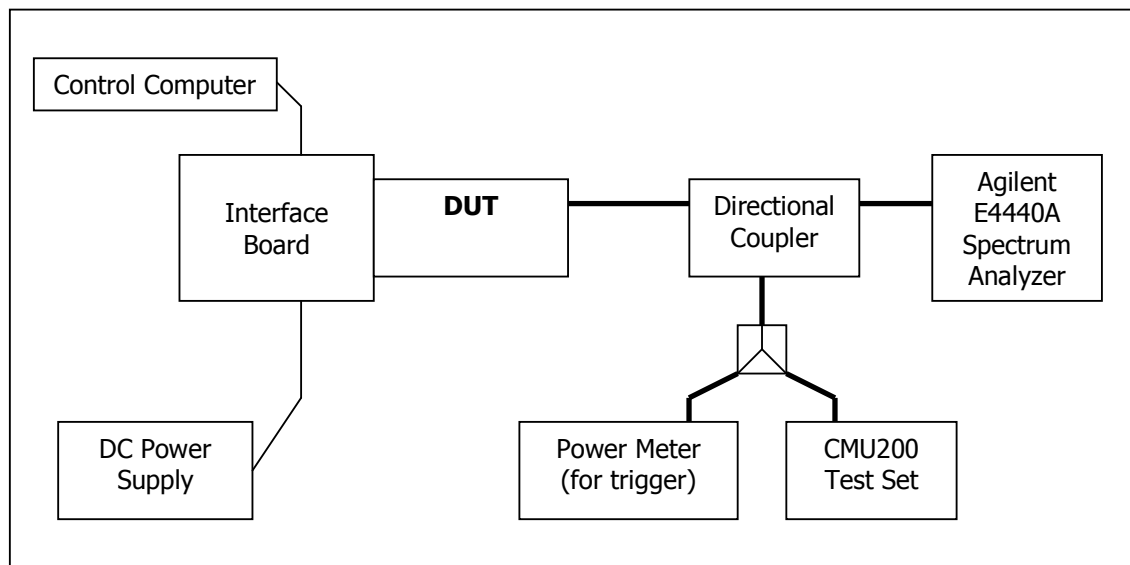

SIERRA WIRELESS, INC.

FCC Part 22 & 24 Test Report	MC8780	Apr 18, 2007	Page 5 of 67
------------------------------	--------	--------------	--------------

4.2 Test Equipment

Instrument List

EQUIPMENT	MANUFACTURER	MODEL NO.	SERIAL NO.	CAL. DATE
Control Computer	TC	Generic PC	100488	N/A
Wireless Test Set	Rohde & Schwarz	CMU200	836766/030	N/A
Spectrum Analyzer	Agilent	PSA E4440A	US41421268	Mar. 1, 2007
DC Power Supply	HP	6632A	3530A	N/A
Interface Board	Shop built	Minnow	N/A	N/A
Directional Coupler	Mini-Circuits	ZA3PD-2	N/A	N/A

4.3 Test Results GSM/EDGE

Frequency (MHz)	Channel	Power (dBm)	
		GMSK Mode	8-PSK Mode
824.2	128	31.8	27.0
836.6	190	31.8	27.0
848.8	251	31.9	27.1
1850.2	512	28.7	25.9
1880.0	661	28.7	25.9
1909.8	810	28.8	25.9

4.4 Test Results UMTS

Frequency (MHz)	Channel	RMS Power (dBm)	
		WCDMA Mode	HSDPA Mode
826.4	4132	22.5	22.6
836.4	4182	22.6	22.5
846.6	4233	22.7	22.6
1852.4	9262	22.4	22.7
1880.0	9400	22.4	22.6
1907.6	9538	22.4	22.6
Frequency (MHz)	Channel	Peak Power (dBm)	
		WCDMA Mode	HSDPA Mode
826.4	4132	25.9	25.8
836.4	4182	25.8	26.1
846.6	4233	25.8	26.1
1852.4	9262	25.9	25.7
1880.0	9400	25.9	25.9
1907.6	9538	25.9	25.9

© 2007 Sierra Wireless, Inc.

The contents of this page are subject to the confidentiality information on page one.

SIERRA WIRELESS, INC.

FCC Part 22 & 24 Test Report	MC8780	Apr 18, 2007	Page 6 of 67
------------------------------	--------	--------------	--------------

4.5 Test Settings for UMTS Mode on the CMU200

UE Power Control Settings

Maximum allowable UE-Power = 24.0 dBm

UL Target Power = 24.0 dBm

Node B Settings

Primary Scrambling Code = 9

Output Channel Power = -51.7 dBm

OCNS = Off

Total Output Power (Ior+Ioc) = -51.7 dBm

RMC Settings

Reference Channel Type: 12.2 kbps Downlink/Uplink DL DTCH Transport Format: 12.2 kbps DL Resources in Use: 100 % UL CRC (Sym. Loop Mode 2): Off Test Mode: Loop Mode 2 Channel Data Source DTCH: PRBS9

Voice Settings

Voice Source: Echo

Loopback Type: Off

Adaptive Multirate Settings

Active Code Set: Selection A

Codec Mode: 12.2 kbps

Signaling RAB Settings

SRB Cell DCH: 3.4 kbps

BS Down Link Physical Channels Settings

Ior = -51.7 dBm

P-CPICH = -3.3 dB

P-SCH = -8.3 dB

S-SCH = -8.3 dB

P-CCPCH = -5.3 dB

S-CCPCH = -5.3 dB

S-CCPCH Channel Code = 2

PICH = -8.3 dB

PICH Channel Code = 3

AICH = -8.3 dB

AICH Channel Code = 6

DPDCH = -10.3 dB

DPDCH Channel Code = 96

Power Offset (DPCCH/DPDCH) = 0.0 dB

DL DPCH Timing Offset = 0

© 2007 Sierra Wireless, Inc.

The contents of this page are subject to the confidentiality information on page one.

SIERRA WIRELESS, INC.

FCC Part 22 & 24 Test Report	MC8780	Apr 18, 2007	Page 7 of 67
------------------------------	--------	--------------	--------------

Secondary Scrambling Code = 0
Secondary Scrambling Code (HSDPA) = 0
HSDPA Channels = Off

TPC Settings

Algorithm = 2
TPC Step Size = 1dB
TPC Pattern Setup = Set 1 (All 1, after linked to get maximum power)

HSDPA Mode Settings:

Network Settings

Packet Switched Domain = ON

HSDPA Test Mode Settings

Radiobearer Setup = RMC 12.2 kbps + HSPDA
RMC Test Loop = Loop Mode 1 RLC TM

HSDPA HS-DSCH Settings

Data Pattern = PRBS9
Force NACK = Off
CQI Feedback Cycle = 4 ms
UE Category = 12
Channel Configuration Type = Fixed Reference Channel

Fixed Reference Channel Settings

H-Set Selection = H-Set 5 QPSK
RV Coding Sequence = {0,2,5,6}

The EUT is calibrated to the same power level for both UMTS and HSDPA modes, and in both modes the EUT uses the same modulation for transmitting, so only one mode was tested. In this report, all WCDMA test data were collected in the UMTS mode.

5 Occupied Bandwidth

FCC 2.1049

5.1 Test Procedure

The transmitter output was connected to a calibrated coaxial cable and coupler, the other end of which was connected to a spectrum analyzer. The occupied bandwidth (defined as the 99% Power Bandwidth) was measured with the spectrum analyzer at the 3 frequencies in each band. The -26dB bandwidth was also measured and recorded.

© 2007 Sierra Wireless, Inc.

The contents of this page are subject to the confidentiality information on page one.

SIERRA WIRELESS, INC.

Test Setup

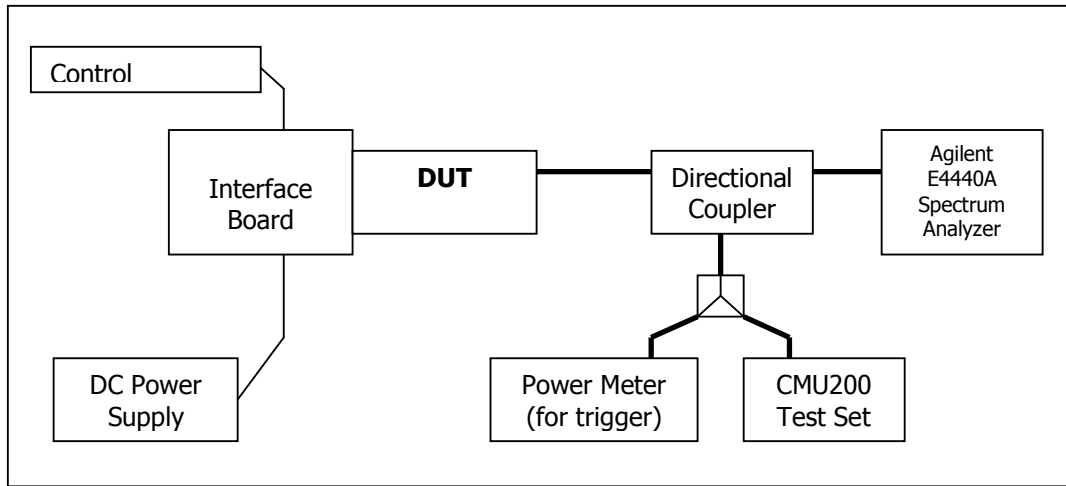

5.2 Test Results

The performance of the GSM 850 MHz cellular band is shown in plots 5.3.1 to 5.3.6.

Performance of the GSM 1900 MHz PCS band is shown in plots 5.3.7 to 5.3.12.

Performance of the UMTS 850 cellular band is shown in plots 5.3.13 to 5.3.15

Performance of the UMTS 1900 PCS band is shown in plots 5.3.16 to 5.3.18

Frequency (MHz)	Channel	99% Occupied Bandwidth (kHz)		-26dBc Occupied Bandwidth (kHz)	
		GMSK Mode	8-PSK Mode	GMSK Mode	8-PSK Mode
824.2	128	244.31	245.57	311.19	310.68
836.6	190	244.92	242.74	314.82	304.7
848.8	251	242.56	247.27	314	301.02
1850.2	512	244.12	246.45	323.57	308.68
1880.0	661	241.84	241.23	313.9	305.2
1909.8	810	241.62	245.83	315.7	304.17
Frequency (MHz)	Channel	99% Occupied Bandwidth (MHz)		-26dBc Occupied Bandwidth (MHz)	
826.4	4132	4.1642		4.626	
836.4	4182	4.1680		4.621	
846.6	4233	4.1697		4.629	
1852.4	9262	4.1590		4.618	
1880.0	9400	4.1762		4.626	
1907.6	9538	4.1720		4.630	

SIERRA WIRELESS, INC.

5.3 Test Plots

5.3.1) GMSK Occupied Bandwidth, Low channel 128, 824.2 MHz, 99% bandwidth

Agilent 14:23:36 20 Mar 2007

L

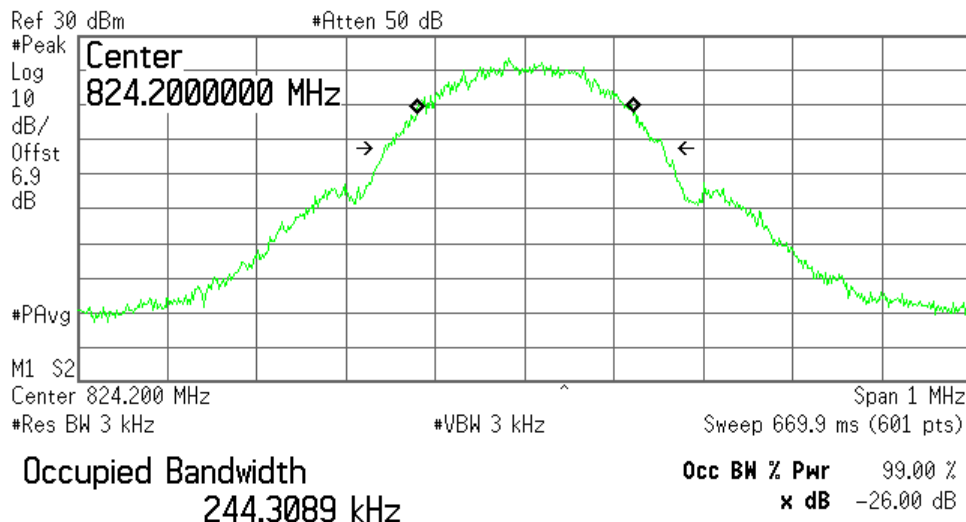

Transmit Freq Error 323.825 Hz
Occupied Bandwidth 311.192 kHz

5.3.2) GMSK Occupied Bandwidth, Mid channel 190, 836.6 MHz, 99% bandwidth

Agilent 14:24:49 20 Mar 2007

L

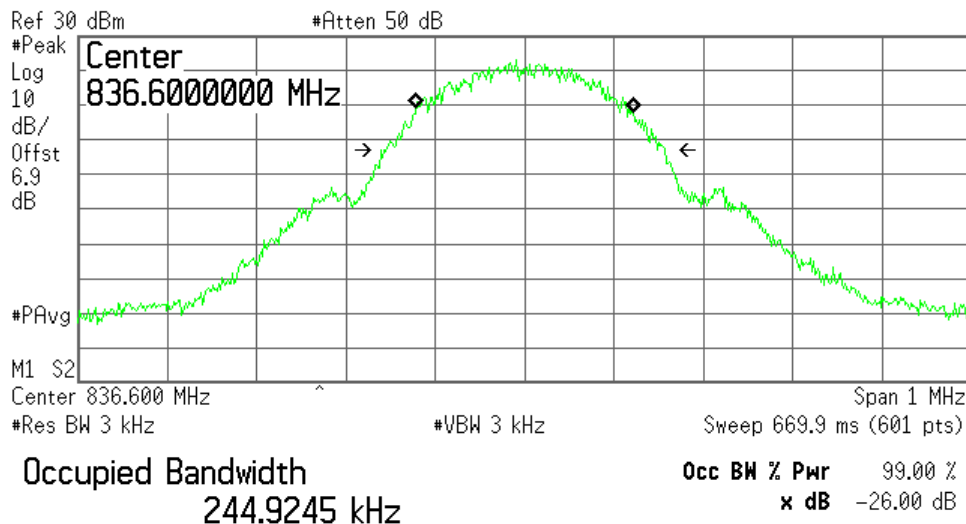

Transmit Freq Error 142.188 Hz
Occupied Bandwidth 314.828 kHz

© 2007 Sierra Wireless, Inc.

The contents of this page are subject to the confidentiality information on page one.

SIERRA WIRELESS, INC.

5.3.3) GMSK Occupied Bandwidth, High channel 251, 848.8 MHz, 99% bandwidth

* Agilent 14:25:54 20 Mar 2007

R

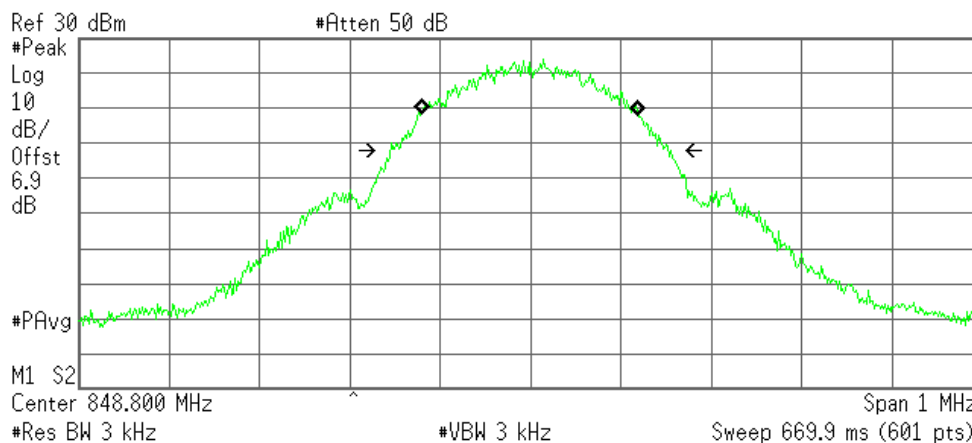

Occupied Bandwidth
242.5539 kHz

Occ BW % Pwr 99.00 %
x dB -26.00 dB

Transmit Freq Error -468.721 Hz
Occupied Bandwidth 313.993 kHz

5.3.4) 8-PSK Occupied Bandwidth, Low channel 128, 824.2 MHz, 99% bandwidth

* Agilent 13:56:45 20 Mar 2007

L

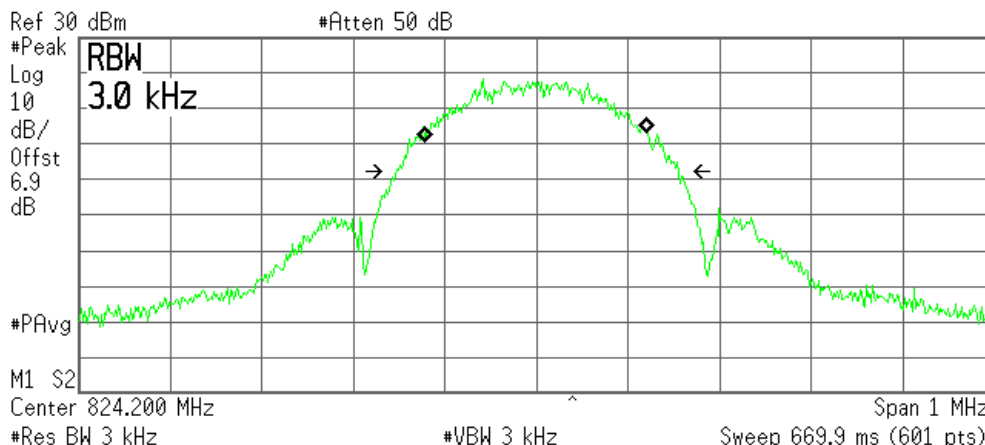

Occupied Bandwidth
245.5652 kHz

Occ BW % Pwr 99.00 %
x dB -26.00 dB

Transmit Freq Error -1.024 kHz
Occupied Bandwidth 310.679 kHz

© 2007 Sierra Wireless, Inc.

The contents of this page are subject to the confidentiality information on page one.

SIERRA WIRELESS, INC.

5.3.5) 8-PSK Occupied Bandwidth, Mid channel 190, 836.6 MHz, 99% bandwidth

Agilent 14:17:15 20 Mar 2007

L

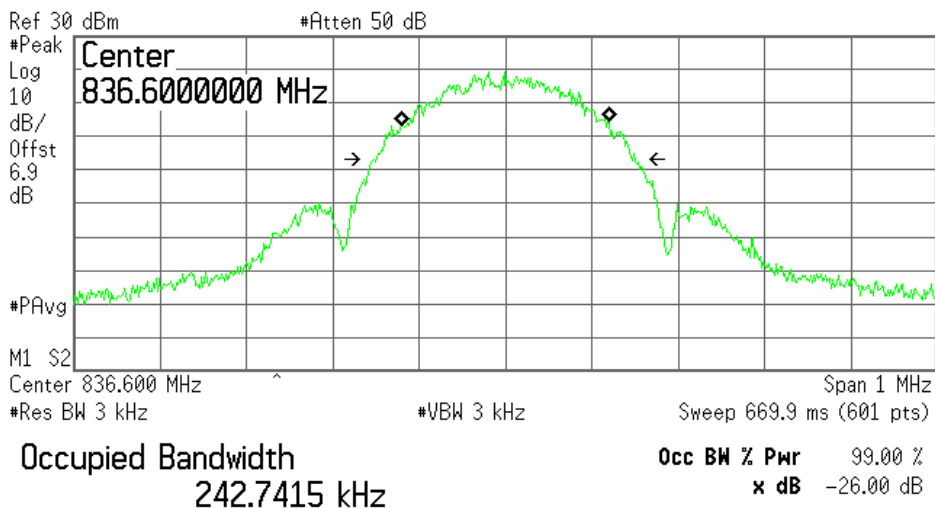

Transmit Freq Error -743.875 Hz
Occupied Bandwidth 304.696 kHz

5.3.6) 8-PSK Occupied Bandwidth, High channel 251, 848.8 MHz, 99% bandwidth

Agilent 14:19:32 20 Mar 2007

L

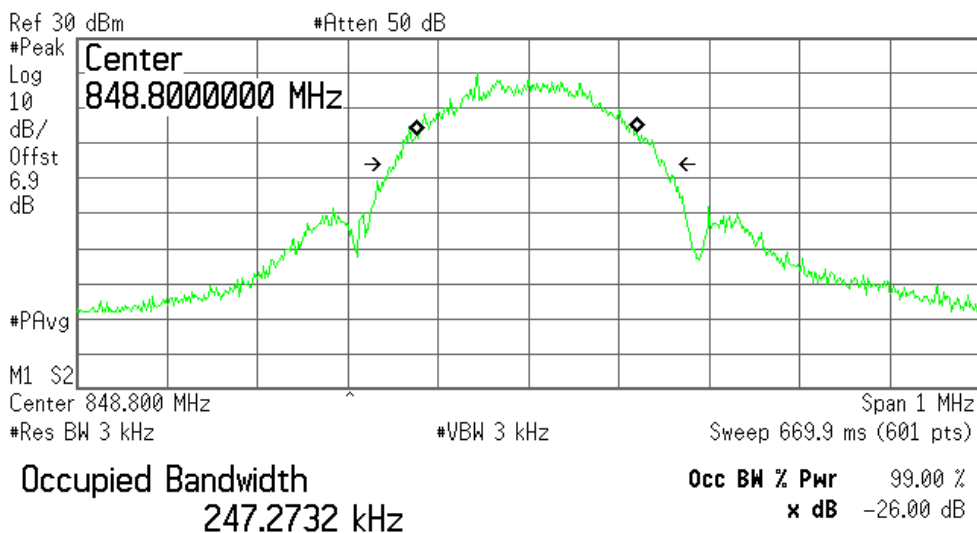

Transmit Freq Error -1.935 kHz
x dB Bandwidth 301.019 kHz

SIERRA WIRELESS, INC.

5.3.7) GMSK Occupied Bandwidth, PCS Low channel 512, 1850.2 MHz, 99% bandwidth

Agilent 14:32:11 20 Mar 2007

L

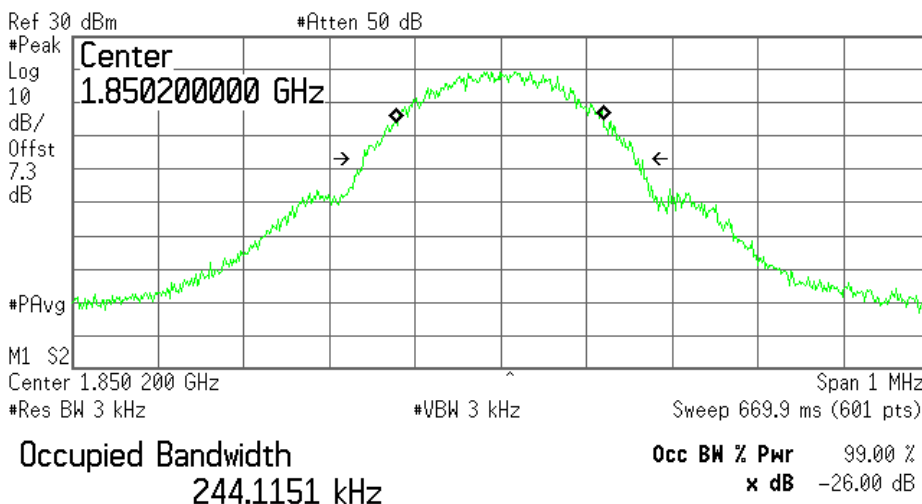

Transmit Freq Error -1.221 kHz
x dB Bandwidth 323.568 kHz

5.3.8) GMSK Occupied Bandwidth, PCS Middle channel 661, 1880.0 MHz, 99% bandwidth

Agilent 14:34:53 20 Mar 2007

L

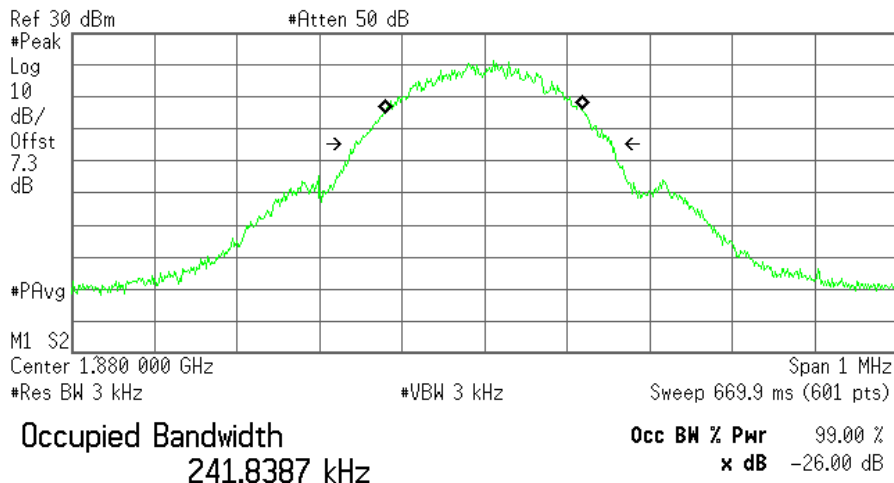

Transmit Freq Error -1.178 kHz
x dB Bandwidth 313.900 kHz

SIERRA WIRELESS, INC.

5.3.9) GMSK Occupied Bandwidth, PCS High channel 810, 1909.8 MHz, 99% bandwidth

* Agilent 14:36:46 20 Mar 2007

L

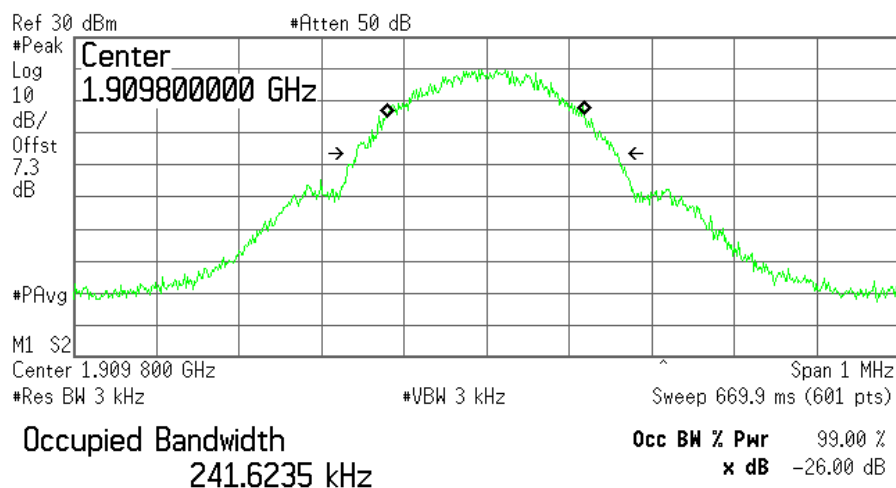

Transmit Freq Error -1.417 kHz
Occupied Bandwidth 315.689 kHz

5.3.10) 8-PSK Occupied Bandwidth, PCS Low channel 512, 1850.2 MHz, 99% bandwidth

* Agilent 15:06:12 20 Mar 2007

L

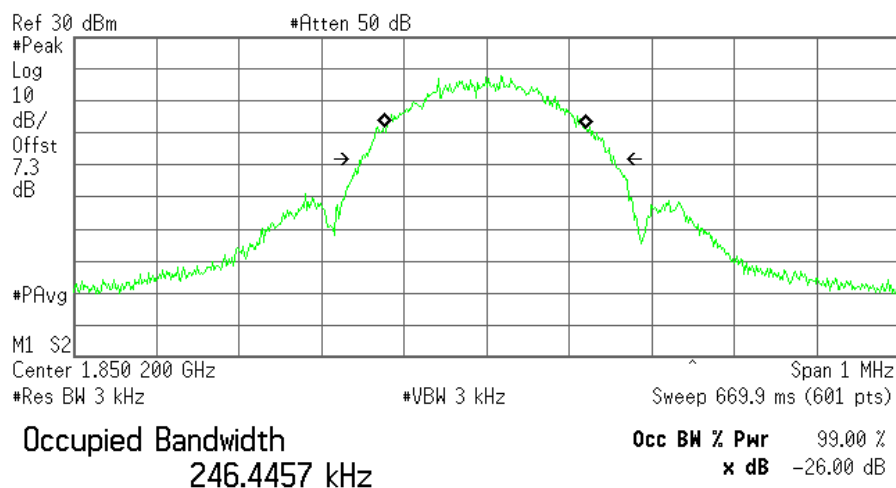

Occupied Bandwidth -982.882 Hz
x dB Bandwidth 308.675 kHz

SIERRA WIRELESS, INC.

5.3.11) 8-PSK Occupied Bandwidth, PCS Middle channel 661, 1880.0 MHz, 99% bandwidth

* Agilent 15:07:28 20 Mar 2007

L

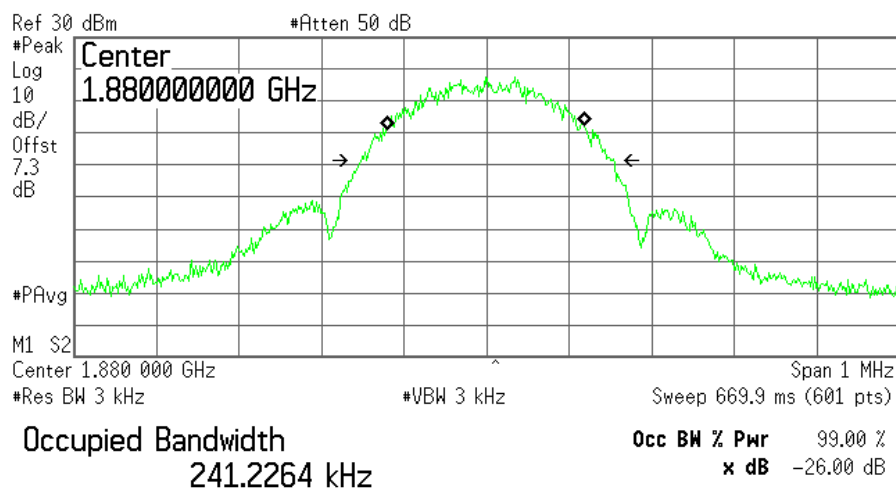

Transmit Freq Error -1.042 kHz
Occupied Bandwidth 305.195 kHz

5.3.12) 8-PSK Occupied Bandwidth, PCS High channel 810, 1909.8 MHz, 99% bandwidth

* Agilent 15:08:30 20 Mar 2007

L

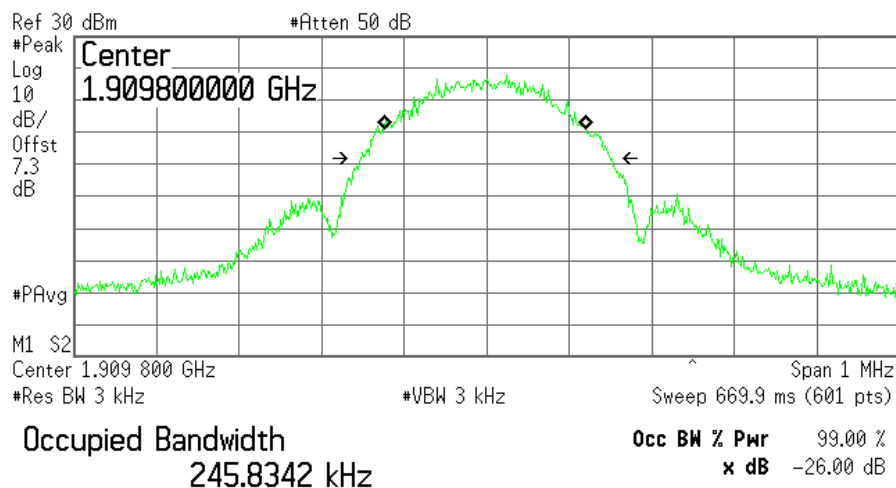

Transmit Freq Error -1.829 kHz
Occupied Bandwidth 304.170 kHz

SIERRA WIRELESS, INC.

5.3.13) WCDMA Occupied Bandwidth, Cellular Low channel 4132, 826.4 MHz, 99% bandwidth

Agilent 15:36:19 20 Mar 2007

L

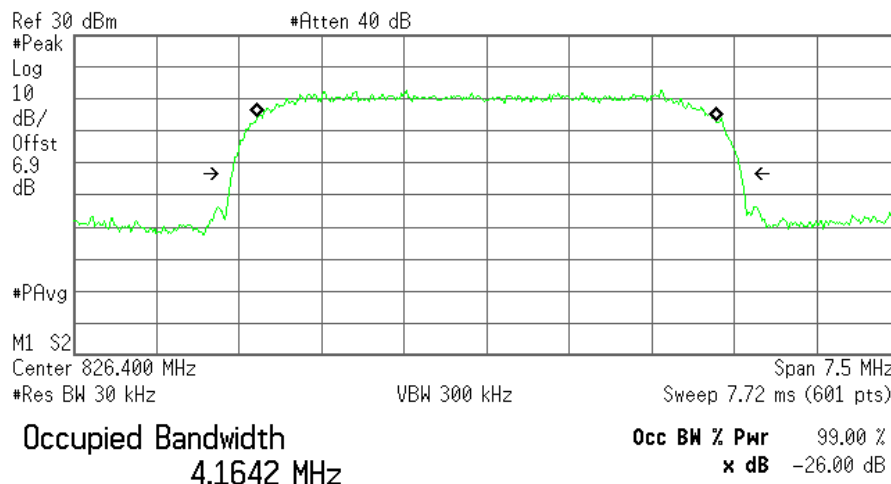

Transmit Freq Error -35.371 Hz
x dB Bandwidth 4.626 MHz

5.3.14) WCDMA Occupied Bandwidth, Cellular Middle channel 4182, 836.4 MHz, 99% bandwidth

Agilent 15:39:16 20 Mar 2007

L

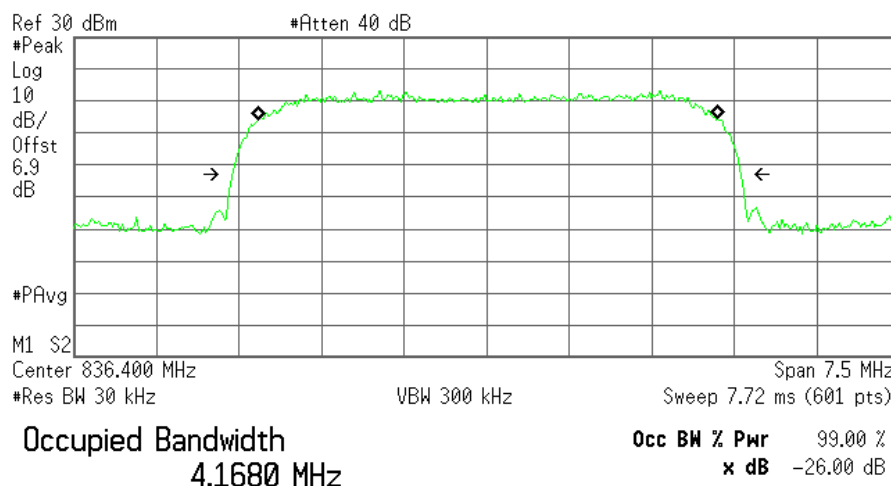

Transmit Freq Error 12.155 kHz
x dB Bandwidth 4.621 MHz

SIERRA WIRELESS, INC.

5.3.15) WCDMA Occupied Bandwidth, Cellular High channel 4233, 846.6 MHz, 99% bandwidth

* Agilent 15:41:22 20 Mar 2007

L

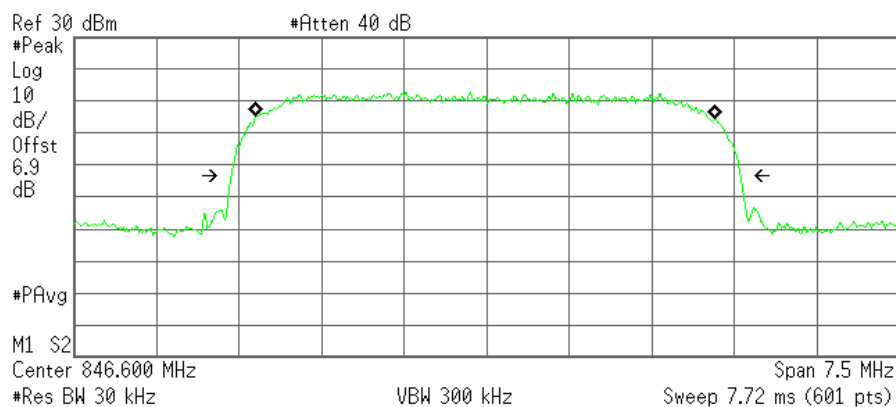

Occupied Bandwidth
4.1697 MHz

Occ BW % Pwr 99.00 %
x dB -26.00 dB

Transmit Freq Error -11.378 kHz
x dB Bandwidth 4.629 MHz

5.3.16) WCDMA Occupied Bandwidth, PCS Low channel 9262, 1852.4 MHz, 99% bandwidth

* Agilent 15:49:22 20 Mar 2007

L

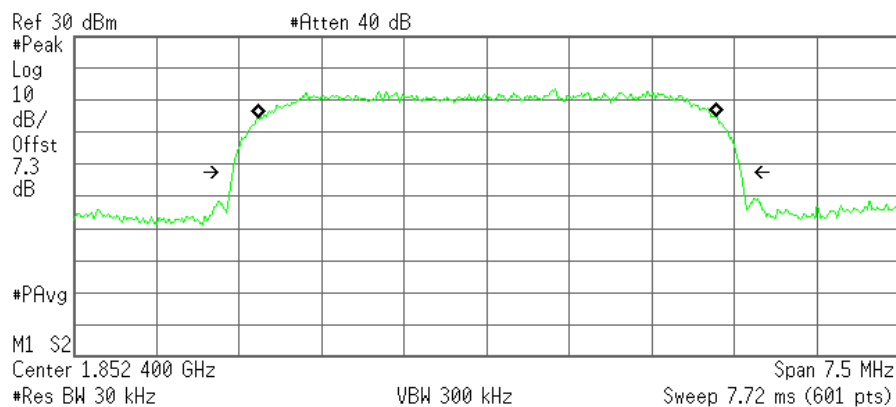

Occupied Bandwidth
4.1590 MHz

Occ BW % Pwr 99.00 %
x dB -26.00 dB

Transmit Freq Error 6.567 kHz
x dB Bandwidth 4.618 MHz

SIERRA WIRELESS, INC.

5.3.17) WCDMA Occupied Bandwidth, PCS Middle channel 9400, 1880 MHz, 99% bandwidth

* Agilent 15:50:41 20 Mar 2007

L

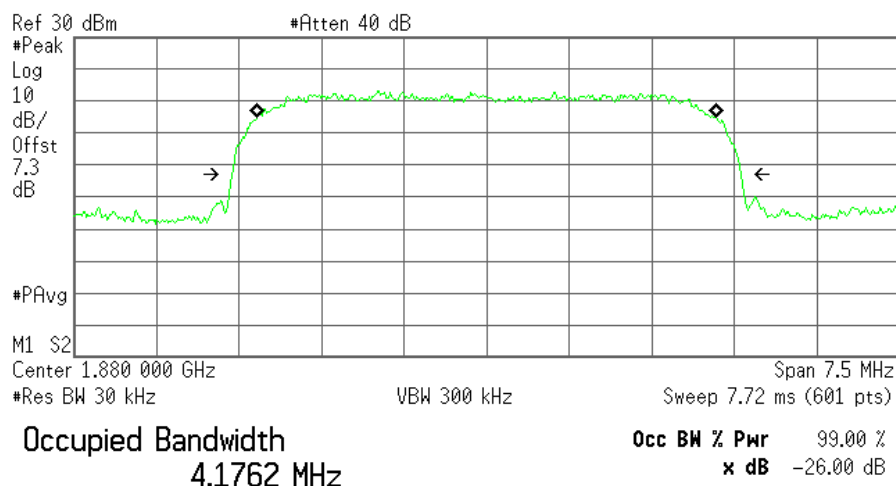

Transmit Freq Error -199.600 Hz
x dB Bandwidth 4.626 MHz

5.3.18) WCDMA Occupied Bandwidth, PCS High channel 9538, 1907.6 MHz, 99% bandwidth

* Agilent 15:51:59 20 Mar 2007

L

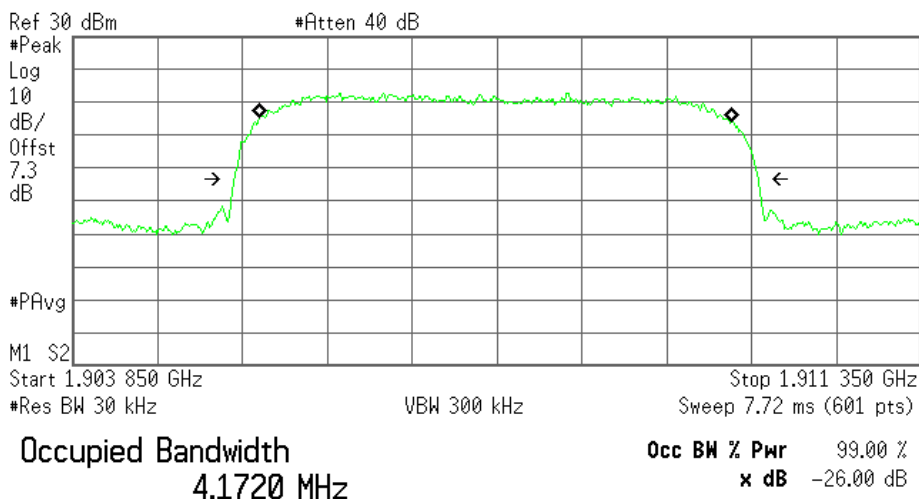

Transmit Freq Error -15.214 kHz
x dB Bandwidth 4.630 MHz

SIERRA WIRELESS, INC.

FCC Part 22 & 24 Test Report	MC8780	Apr 18, 2007	Page 18 of 67
------------------------------	--------	--------------	---------------

6 Out of Band Emissions at Antenna Terminals

FCC 22.901(d), 22.917, 24.238(a)

Out of Band Emissions:

The mean power of emissions must be attenuated below the mean power of the unmodulated carrier (P) on any frequency outside the frequency band by at least $(43 + 10 \log P)$ dB, in this case, -13dBm.

6.1 Test Procedure

The RF output of the transmitter was connected to a spectrum analyzer through a calibrated coaxial cable. Sufficient scans were taken to show the out-of-band Emissions, if any, up to 10th harmonic. The EUT was scanned for spurious emissions from 1MHz to 20GHz with sufficient bandwidth and video resolution. Data plots are included. The measurement cable path loss at 20GHz (including an attenuator) was 10dB (7dB at lower frequencies). The larger path loss of 10dB was used for all measurements to be conservative. Multiple sweeps were recorded in maximum hold mode using a peak detector to ensure that the worst-case emissions were caught.

Test Setup

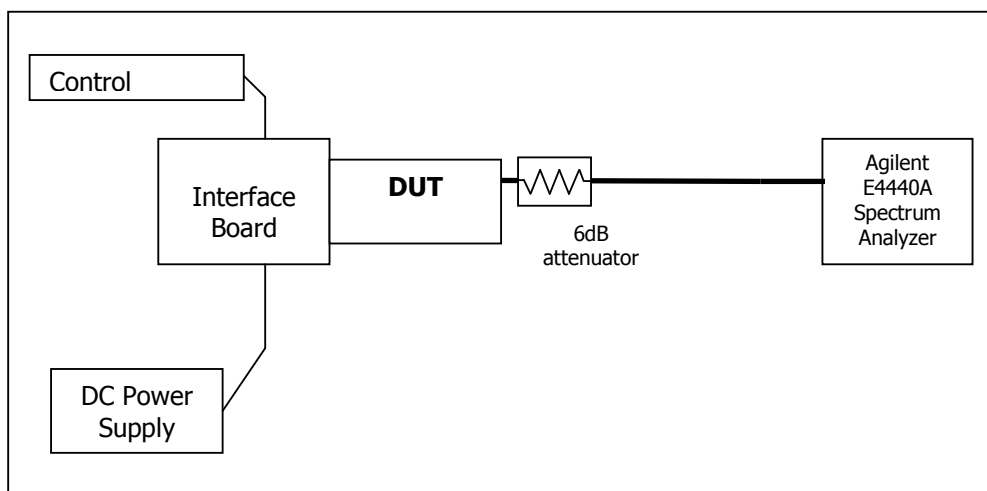

6.2 Test Equipment

EQUIPMENT	MANUFACTURER	MODEL NO.	SERIAL NO.	CAL. DATE
Control Computer	TC	Generic PC	100488	N/A
Wireless Test Set	Rohde & Schwarz	CMU200	836766/030	N/A
Spectrum Analyzer	Agilent	PSA E4440A	US41421268	Mar. 1, 2007
DC Power Supply	HP	6632A	3530A	N/A
Interface Board	Shop built	Minnow	N/A	N/A
Directional Coupler	Mini-Circuits	ZA3PD-2	N/A	N/A

© 2007 Sierra Wireless, Inc.

The contents of this page are subject to the confidentiality information on page one.

SIERRA WIRELESS, INC.

FCC Part 22 & 24 Test Report	MC8780	Apr 18, 2007	Page 19 of 67
------------------------------	--------	--------------	---------------

6.3 Test Results

Refer to the following plots.

- **Cellular Band**

Plot Number	Description
6.4.1 – 6.4.3	GMSK Mode, Low channel, 824.20 MHz
6.4.4 – 6.4.6	GMSK Mode, Middle Channel, 836.6 MHz
6.4.7 – 6.4.9	GMSK Mode, High Channel, 848.8 MHz
6.4.10 – 6.4.12	8-PSK Mode, Low channel, 824.20 MHz
6.4.13 – 6.4.15	8-PSK Mode, Middle Channel, 836.6 MHz
6.4.16 – 6.4.18	8-PSK Mode, High Channel, 848.8 MHz

- **PCS Band**

Plot Number	Description
6.4.19 – 6.4.21	GMSK Mode, Low Channel, 1850.2 MHz
6.4.22 – 6.4.24	GMSK Mode, Middle Channel, 1880.0 MHz
6.4.25 – 6.4.27	GMSK Mode, High Channel, 1909.8 MHz
6.4.28 – 6.4.30	8-PSK, Mode, Low Channel, 1850.2 MHz
6.4.31 – 6.4.33	8-PSK Mode, Middle Channel, 1880.0 MHz
6.4.34 – 6.4.36	8-PSK Mode, High Channel, 1909.8 MHz

- **UMTS Cellular Band**

Plot Number	Description
6.4.37 – 6.4.39	WCDMA Mode, Low Channel, 826.4 MHz
6.4.40 – 6.4.42	WCDMA Mode, Middle Channel, 836.4 MHz
6.4.43 – 6.4.45	WCDMA Mode, High Channel, 846.6 MHz

- **UMTS PCS Band**

Plot Number	Description
6.4.46 – 6.4.48	WCDMA Mode, Low Channel, 1852.4 MHz
6.4.49 – 6.4.51	WCDMA Mode, Middle Channel, 1880.0 MHz
6.4.52 – 6.4.54	WCDMA Mode, High Channel, 1907.6 MHz

SIERRA WIRELESS, INC.

These plots show that the conducted emission limits requirements are met.

6.4 Test Plots

Plot 6.4.1) Out of Band Emissions at Antenna Terminals

GMSK, Low channel 128, 824.200 MHz, 1 MHz to 1 GHz

Agilent 17:04:28 20 Mar 2007

L

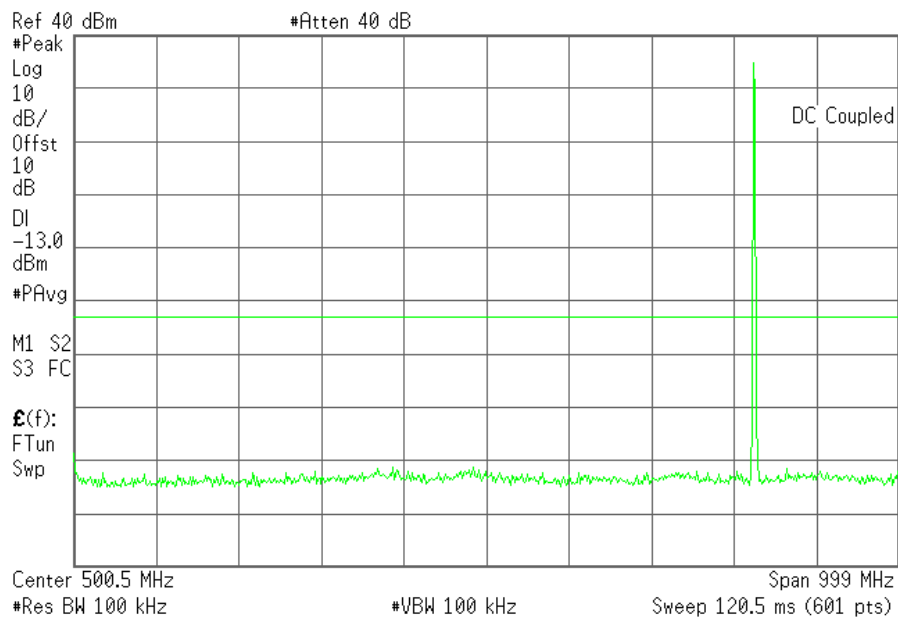

Plot 6.4.2) Out of Band Emissions at Antenna Terminals

GMSK, Low channel, 824.200 MHz, TX signal +/- 20 MHz

Agilent 10:00:23 21 Mar 2007

L

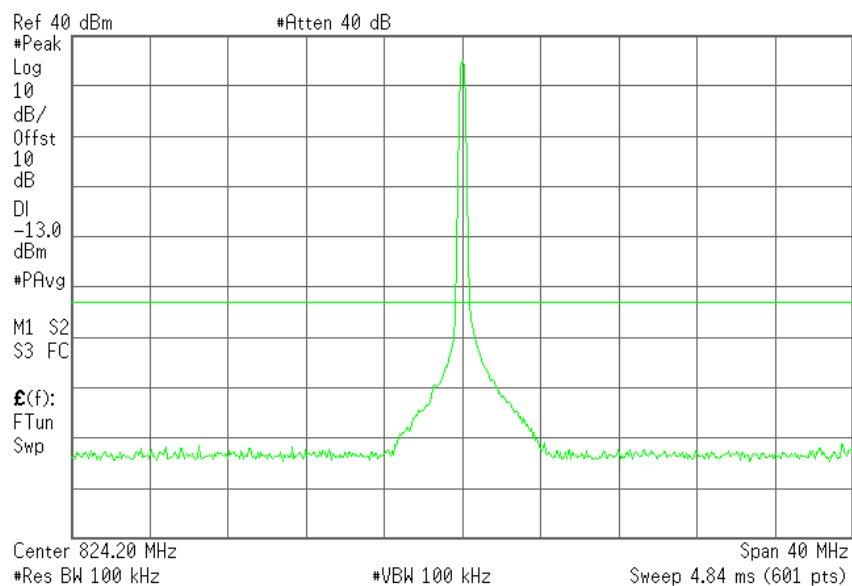

The strong emission shown in each case is the carrier signal.

© 2007 Sierra Wireless, Inc.

The contents of this page are subject to the confidentiality information on page one.

SIERRA WIRELESS, INC.

Plot 6.4.3) Out of Band Emissions at Antenna Terminals

GMSK, Low channel 128, 824.200 MHz, 1 GHz to 20 GHz

Agilent 13:39:55 3 Apr 2007

L

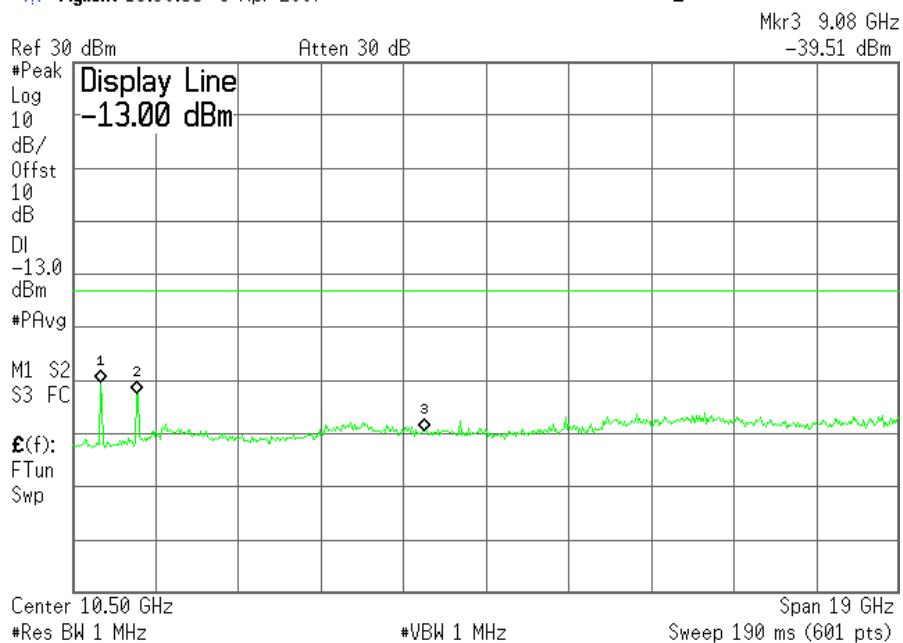

Cellular Harmonics for Ch. 128 (824.2 MHz)	Level (dBm)
Second	-31 dBm
Third	-33 dBm
All others	< -30dBm up to 20GHz

SIERRA WIRELESS, INC.

Plot 6.4.4) Out of Band Emissions at Antenna Terminals

GMSK, Mid Channel 190, 836.6 MHz, 1 MHz to 1 GHz

* Agilent 17:05:30 20 Mar 2007

L

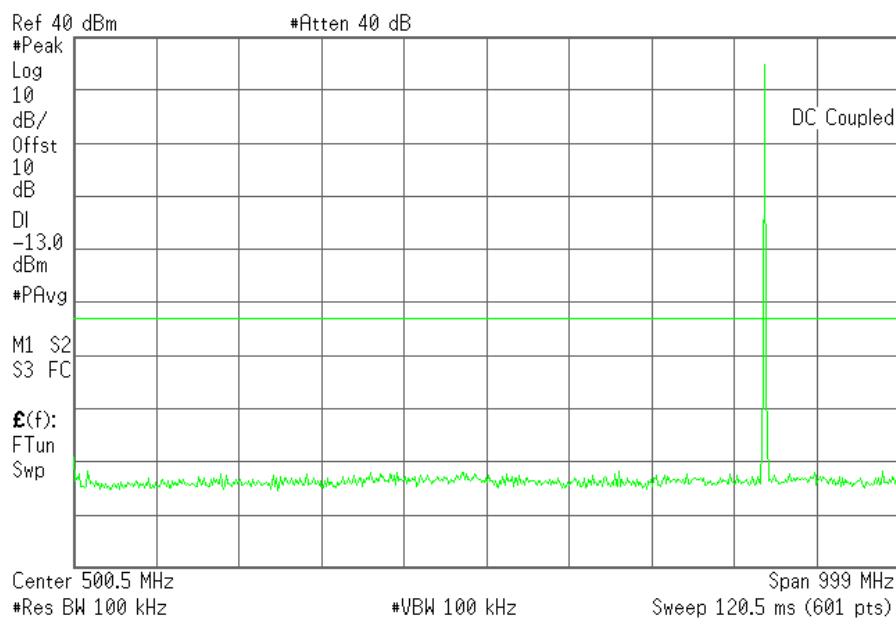

Plot 6.4.5) Out of Band Emissions at Antenna Terminals

GMSK, Mid Channel 190, 836.6 MHz, TX signal +/- 20 MHz

* Agilent 10:02:34 21 Mar 2007

L

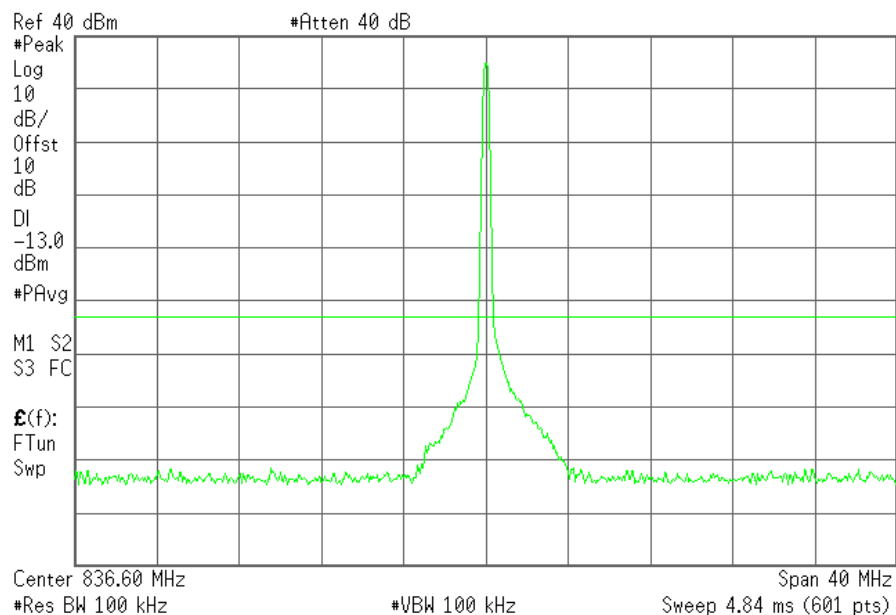

The strong emission shown in each case is the carrier signal.

SIERRA WIRELESS, INC.

Plot 6.4.6) Out of Band Emissions at Antenna Terminals

GMSK, Mid Channel 190, 836.6 MHz, 1 GHz to 20 GHz

* Agilent 13:47:26 3 Apr 2007

L

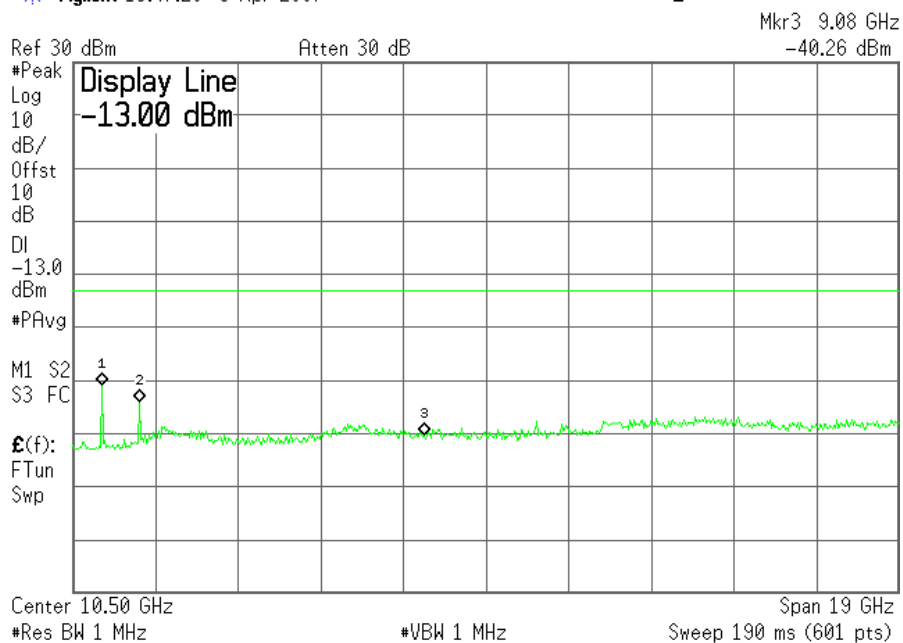

Cellular Harmonics for Ch. 190 (836.6 MHz)	Level (dBm)
Second	-31 dBm
Third	-34 dBm
All others	< -30dBm up to 20GHz

SIERRA WIRELESS, INC.

Plot 6.4.7) Out of Band Emissions at Antenna Terminals

GMSK, High Channel 251, 848.8 MHz, 1 MHz to 1 GHz

* Agilent 17:06:27 20 Mar 2007

L

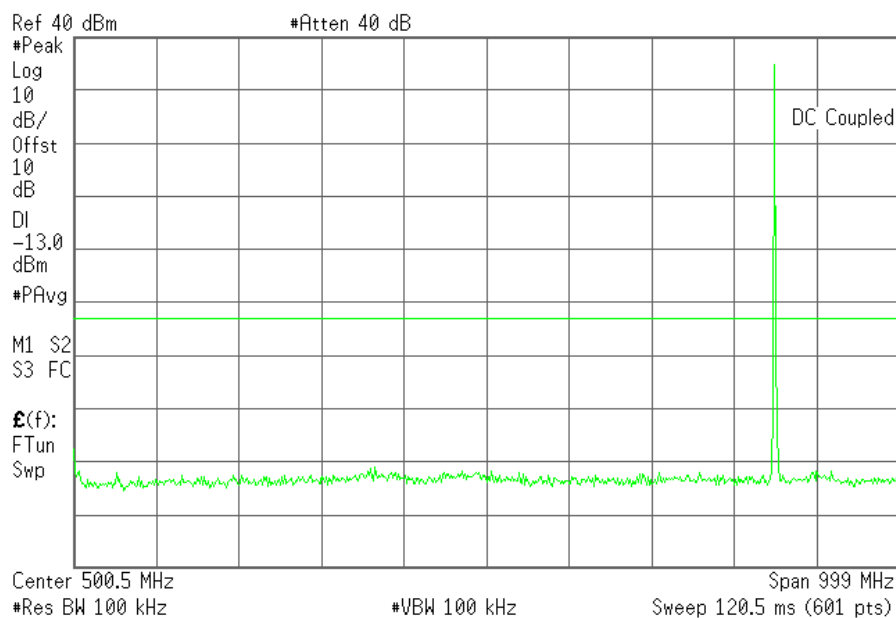

Plot 6.4.8) Out of Band Emissions at Antenna Terminals

GMSK, High Channel 251, 848.8 MHz, TX signal +/- 20 MHz

* Agilent 10:03:44 21 Mar 2007

L

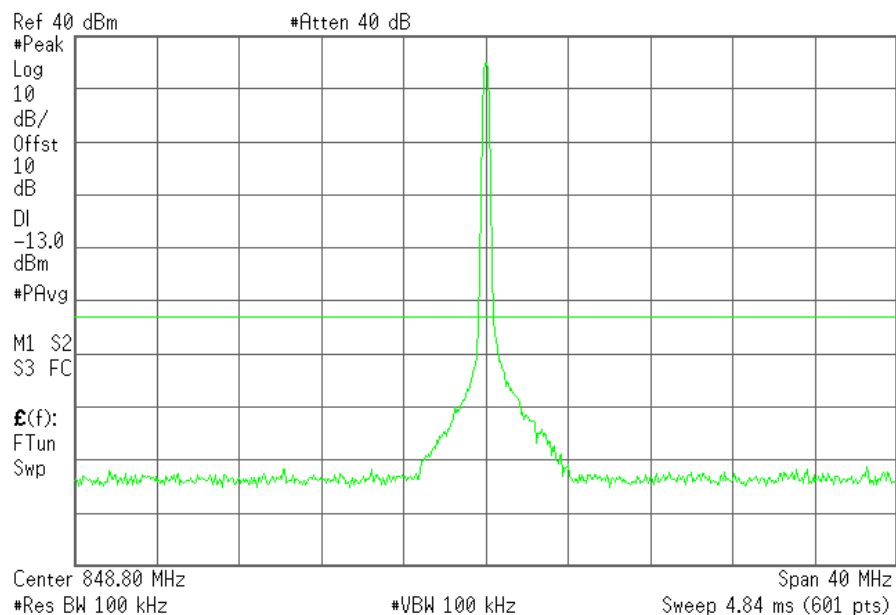

The strong emission shown in each case is the carrier signal.

© 2007 Sierra Wireless, Inc.

The contents of this page are subject to the confidentiality information on page one.

SIERRA WIRELESS, INC.

Plot 6.4.9) Out of Band Emissions at Antenna Terminals

GMSK, High Channel 251, 848.8 MHz, 1 GHz to 20 GHz

* Agilent 13:48:38 3 Apr 2007

L

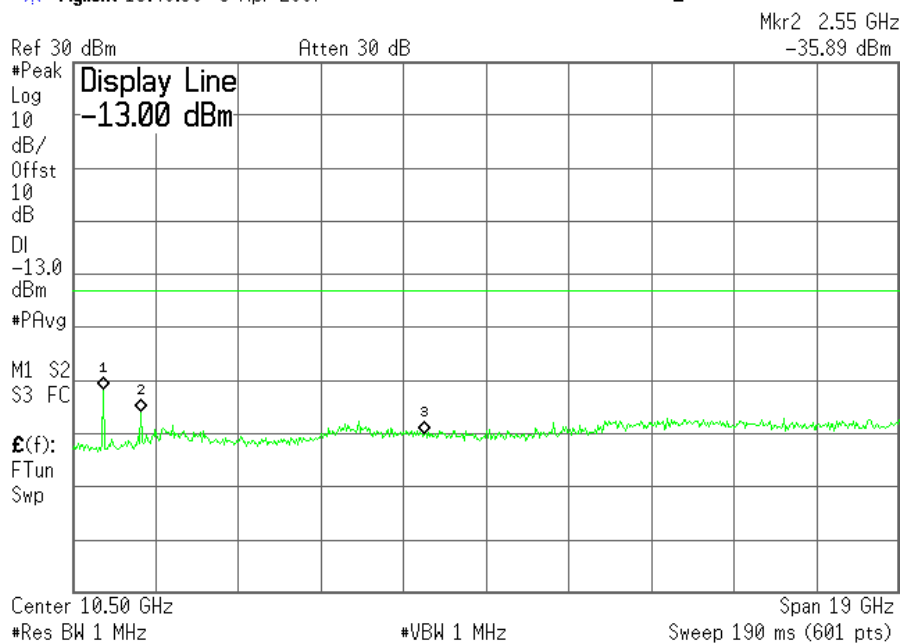

Cellular Harmonics for Ch. 251 (848.8 MHz)	Level (dBm)
Second	-32 dBm
Third	-35 dBm
All others	< -30dBm up to 20GHz

SIERRA WIRELESS, INC.

Plot 6.4.10) Out of Band Emissions at Antenna Terminals

8-PSK, Low channel, 824.200 MHz, 1 MHz to 1 GHz

* Agilent 16:58:26 20 Mar 2007 L

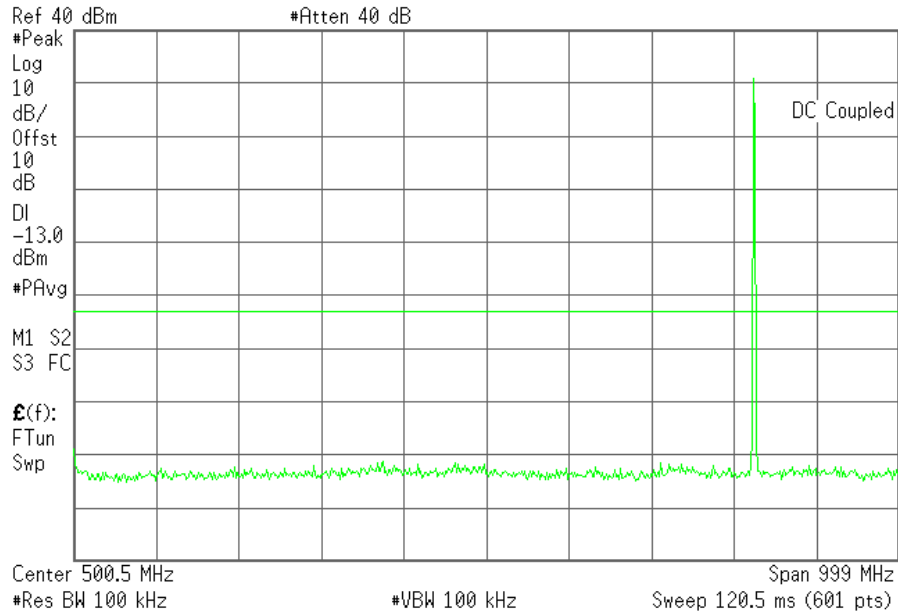

Plot 6.4.11) Out of Band Emissions at Antenna Terminals

8-PSK, Low channel 128, 824.200 MHz, TX signal +/- 20 MHz

* Agilent 10:06:18 21 Mar 2007 L

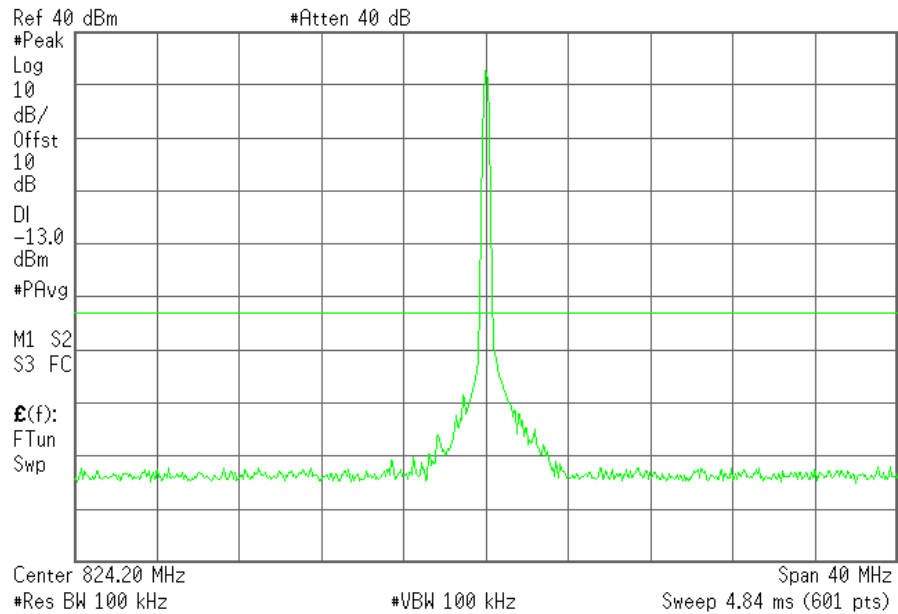

The strong emission shown in each case is the carrier signal.

SIERRA WIRELESS, INC.

Plot 6.4.12) Out of Band Emissions at Antenna Terminals

8-PSK, Low channel 128, 824.200 MHz, 1 GHz to 20 GHz

* Agilent 13:54:48 3 Apr 2007

L

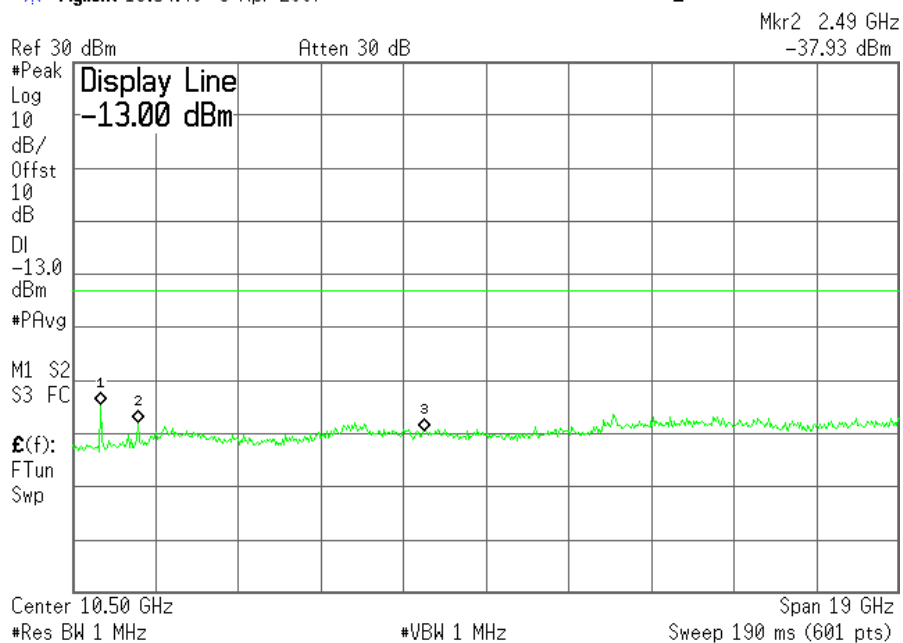

Cellular Harmonics for Ch. 128 (824.2 MHz)	Level (dBm)
Second	-34dBm
Third	-38dBm
All others	< -30dBm up to 20GHz

SIERRA WIRELESS, INC.

Plot 6.4.13) Out of Band Emissions at Antenna Terminals

8-PSK, Mid Channel 190, 836.6 MHz, 1 MHz to 1 GHz

Agilent 17:01:04 20 Mar 2007

L

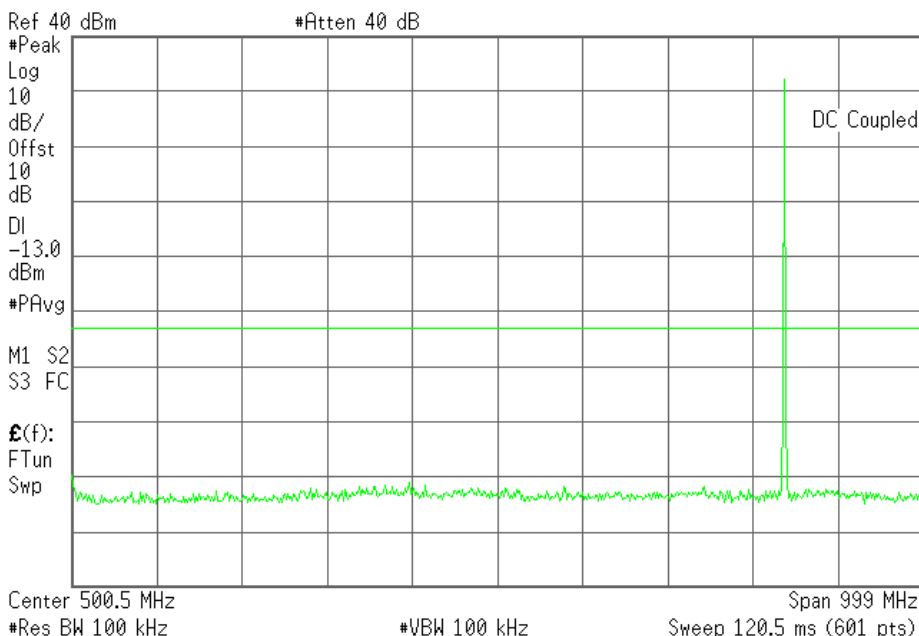

Plot 6.4.14) Out of Band Emissions at Antenna Terminals

8-PSK, Mid Channel 190, 836.6 MHz, TX signal +/- 20 MHz

Agilent 10:07:15 21 Mar 2007

L

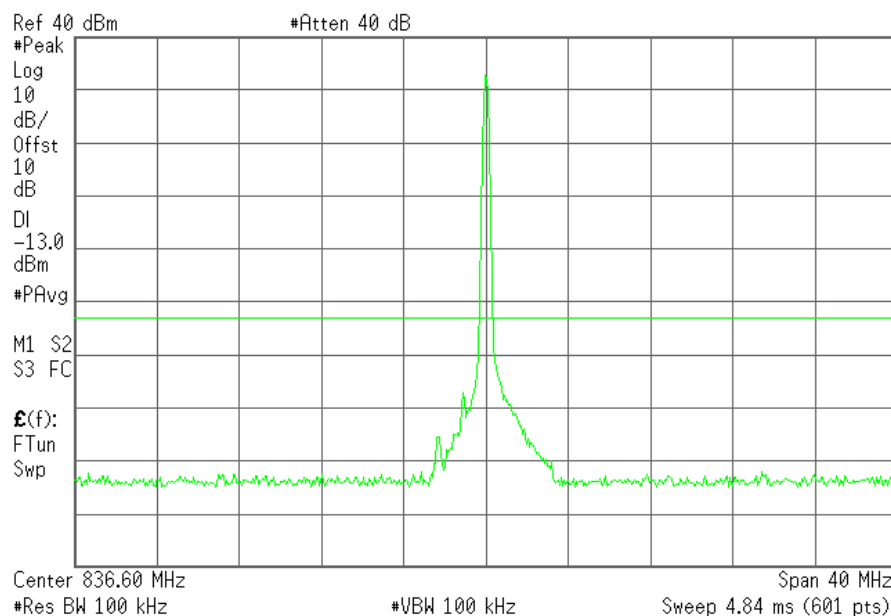

The strong emission shown in each case is the carrier signal.

SIERRA WIRELESS, INC.

Plot 6.4.15) Out of Band Emissions at Antenna Terminals

8-PSK, Mid Channel 190, 836.6 MHz, 1 GHz to 20 GHz

* Agilent 13:53:37 3 Apr 2007

L

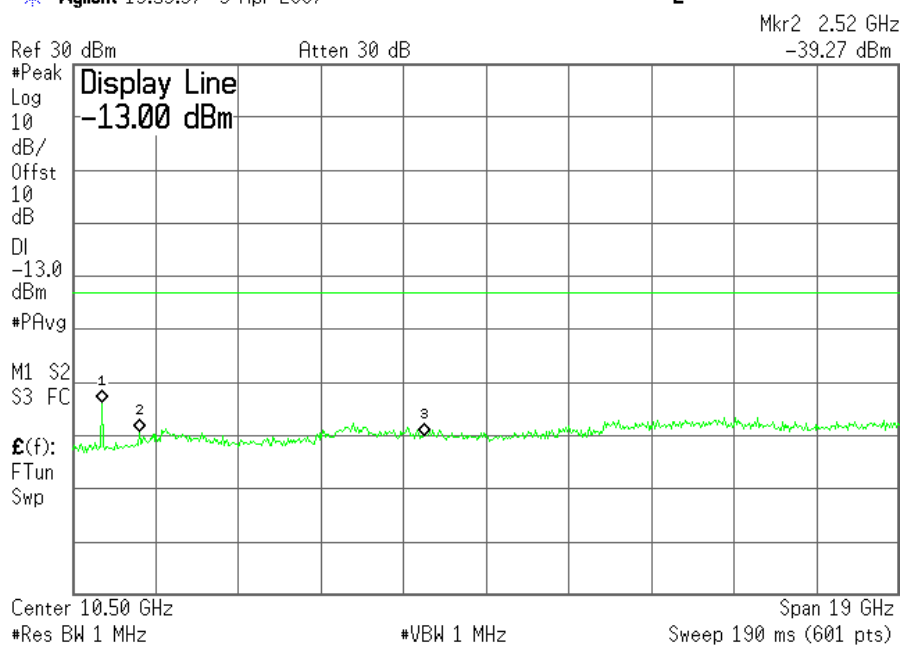

Cellular Harmonics for Ch. 190 (836.6 MHz)	Level (dBm)
Second	-34dBm
Third	-38dBm
All others	< -30dBm up to 20GHz

SIERRA WIRELESS, INC.

Plot 6.4.16) Out of Band Emissions at Antenna Terminals

8-PSK, High Channel 251, 848.8 MHz, 1 MHz to 1 GHz

* Agilent 17:02:38 20 Mar 2007

L

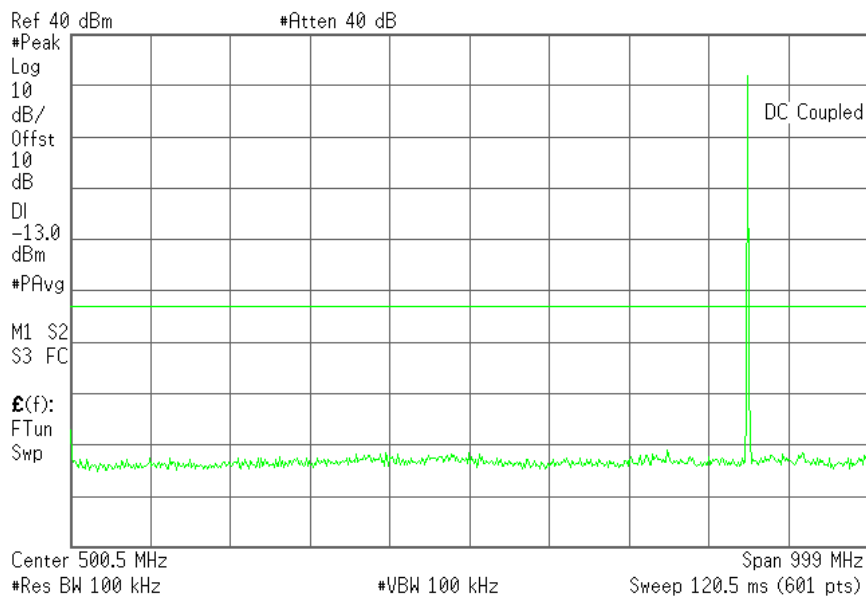

Plot 6.4.17) Out of Band Emissions at Antenna Terminals

8-PSK, High Channel, 848.8 MHz, TX signal +/- 20 MHz

* Agilent 10:09:07 21 Mar 2007

L

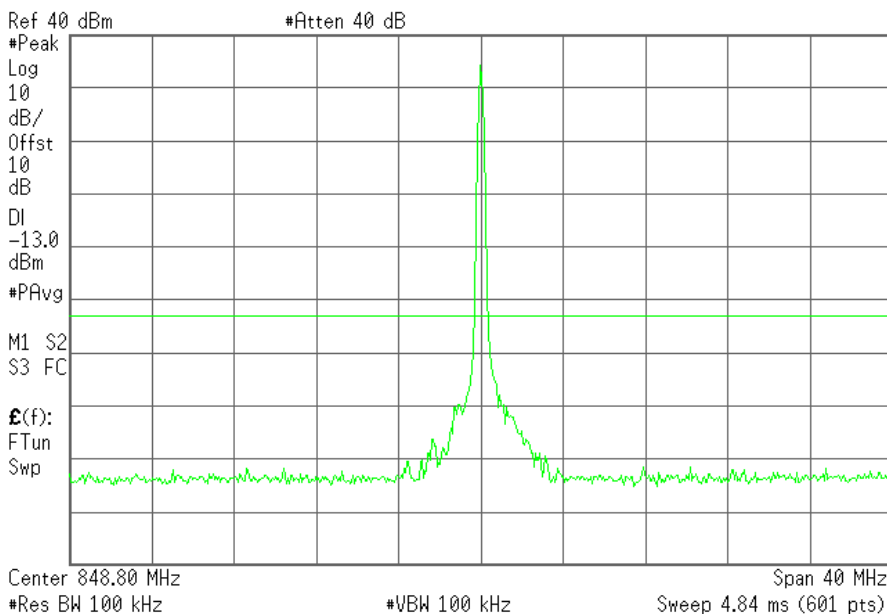

The strong emission shown in each case is the carrier signal.

SIERRA WIRELESS, INC.

Plot 6.4.18) Out of Band Emissions at Antenna Terminals

8-PSK, High Channel 251, 848.8 MHz, 1 GHz to 20 GHz

* Agilent 13:52:08 3 Apr 2007

L

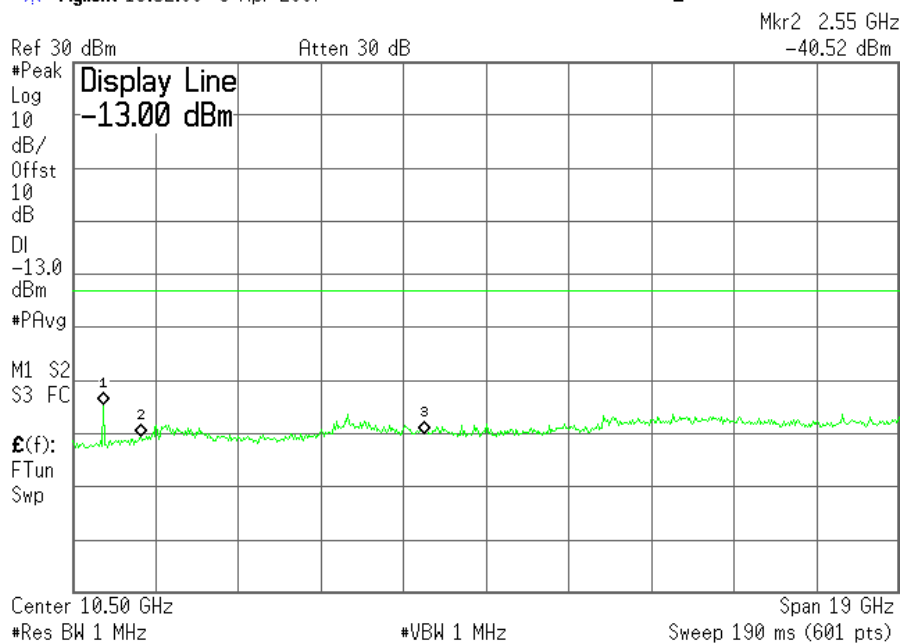

Cellular Harmonics for Ch. 251 (848.8 MHz)	Level (dBm)
Second	-34dBm
Third	-39dBm
All others	< -30dBm up to 20GHz

SIERRA WIRELESS, INC.

Plot 6.4.19) Out of Band Emissions at Antenna Terminals

GMSK, Low channel 512, 1850.2 MHz, 1 MHz to 1 GHz

Agilent 09:14:47 21 Mar 2007

L

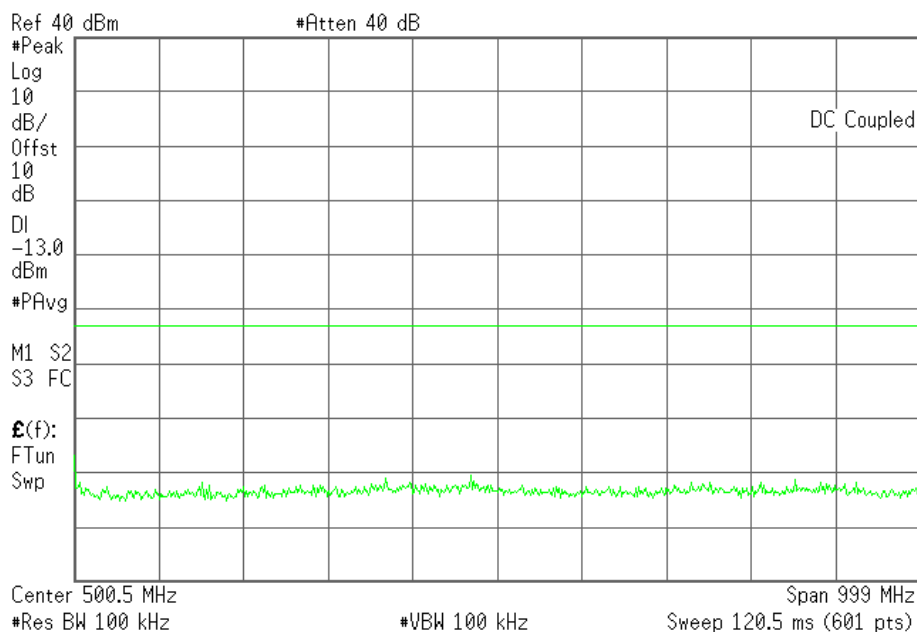

Plot 6.4.20) Out of Band Emissions at Antenna Terminals

GMSK, Low channel 512, 1850.2 MHz, TX signal +/- 20 MHz

Agilent 10:13:25 21 Mar 2007

L

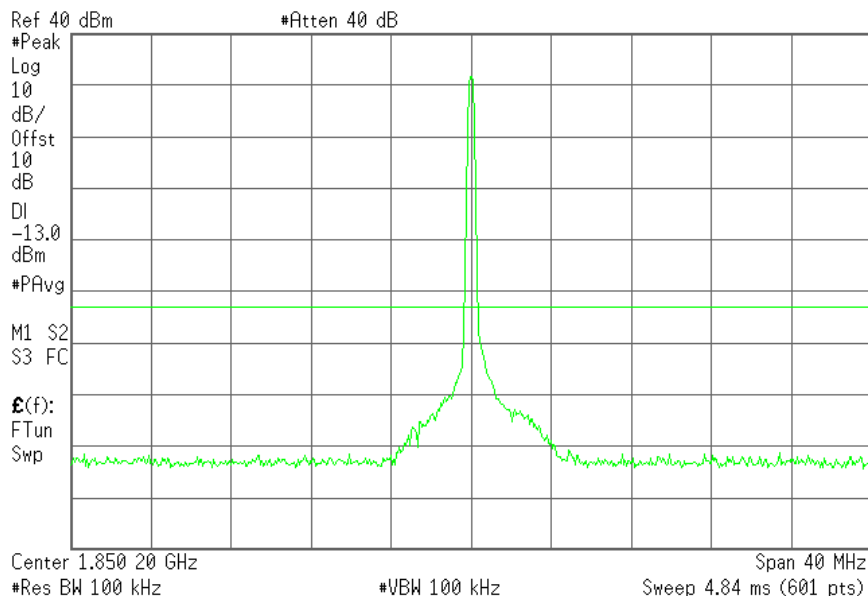

© 2007 Sierra Wireless, Inc.

The contents of this page are subject to the confidentiality information on page one.

SIERRA WIRELESS, INC.

Plot 6.4.21) Out of Band Emissions at Antenna Terminals

GMSK, Low channel 512, 1850.2 MHz, 1 GHz to 20 GHz

* Agilent 13:57:24 3 Apr 2007

L

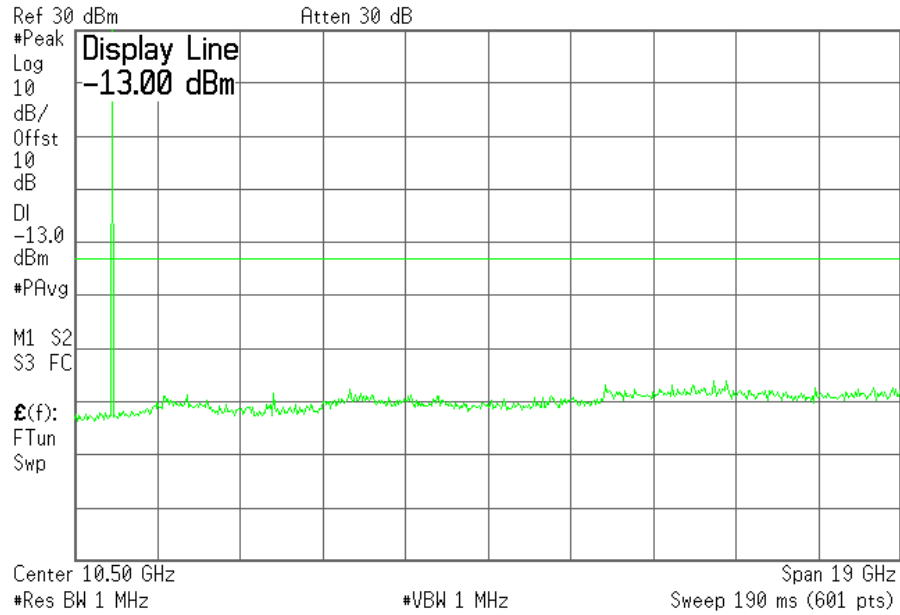

The strong emission shown is the carrier signal.

SIERRA WIRELESS, INC.

Plot 6.4.22) Out of Band Emissions at Antenna Terminals

GMSK, Middle channel 661, 1880.0 MHz, 1 MHz to 1 GHz

* Agilent 09:22:44 21 Mar 2007 L

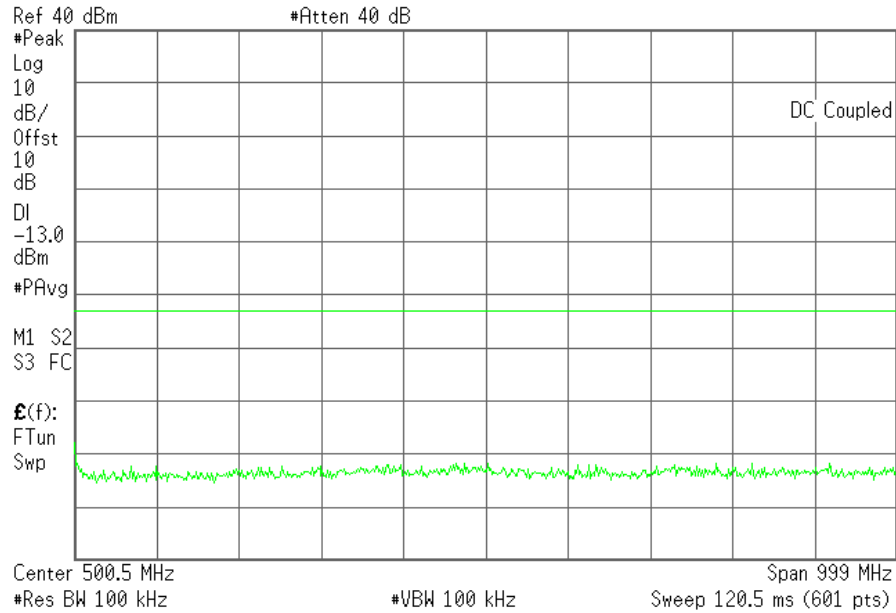

Plot 6.4.23) Out of Band Emissions at Antenna Terminals

GMSK, Middle channel 661, 1880.0 MHz, TX signal +/- 20 MHz

* Agilent 10:14:54 21 Mar 2007 L

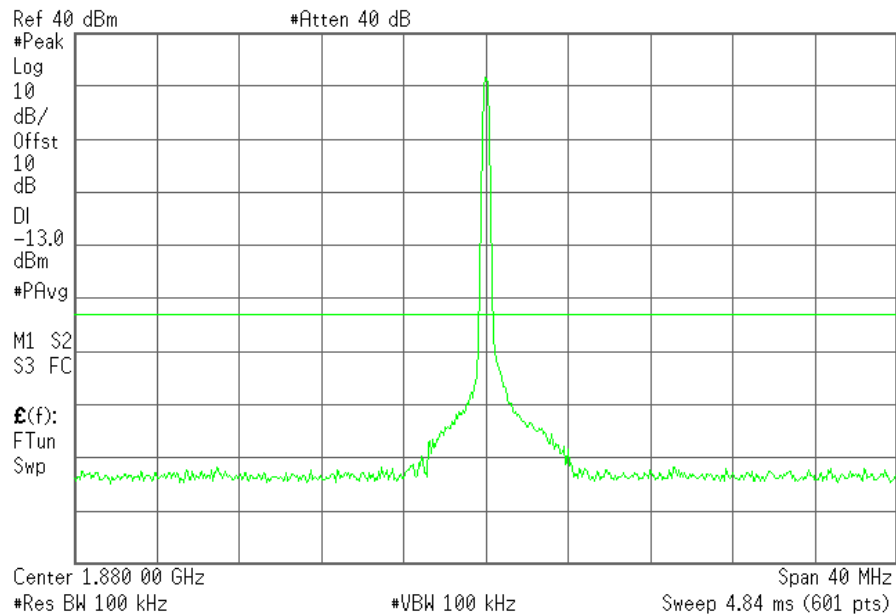

SIERRA WIRELESS, INC.

Plot 6.4.24) Out of Band Emissions at Antenna Terminals

GMSK, Middle channel 661, 1880.0 MHz, 1 GHz to 20 GHz

* Agilent 13:58:33 3 Apr 2007

L

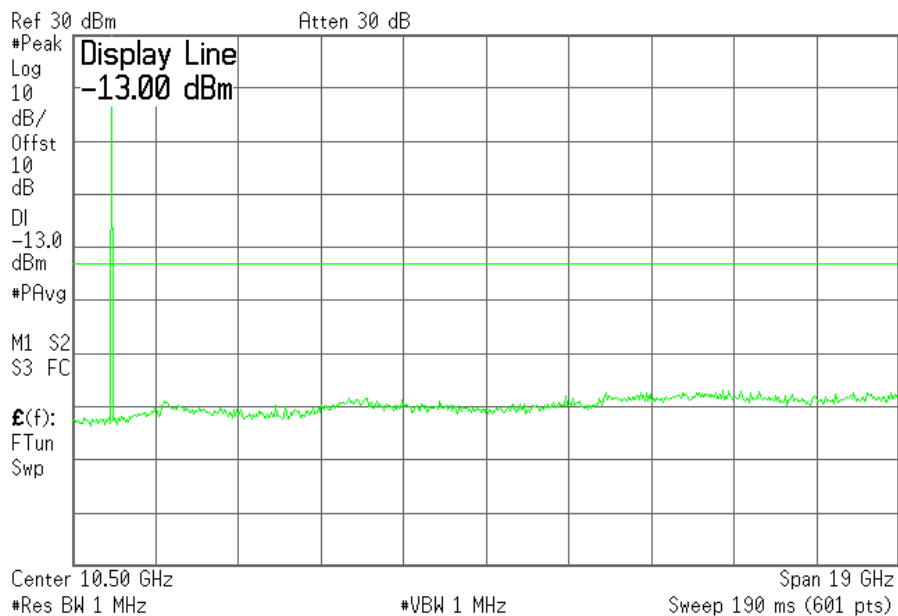

The strong emission shown is the carrier signal.

SIERRA WIRELESS, INC.

Plot 6.4.25) Out of Band Emissions at Antenna Terminals

GMSK, High channel 810, 1909.8 MHz, 1 MHz to 1 GHz

* Agilent 09:23:57 21 Mar 2007 L

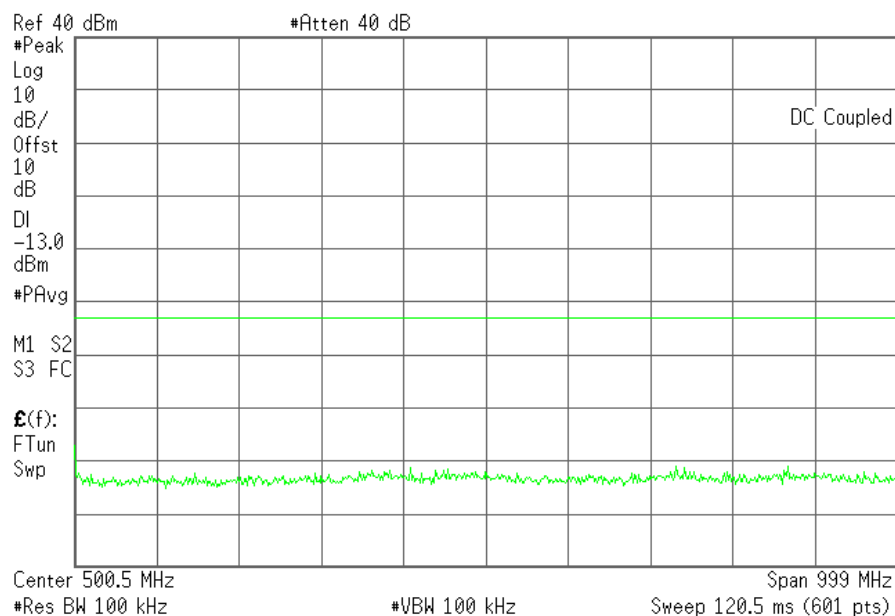

Plot 6.4.26) Out of Band Emissions at Antenna Terminals

GMSK, High channel 810, 1909.8 MHz, TX signal +/- 20 MHz

* Agilent 10:17:48 21 Mar 2007 L

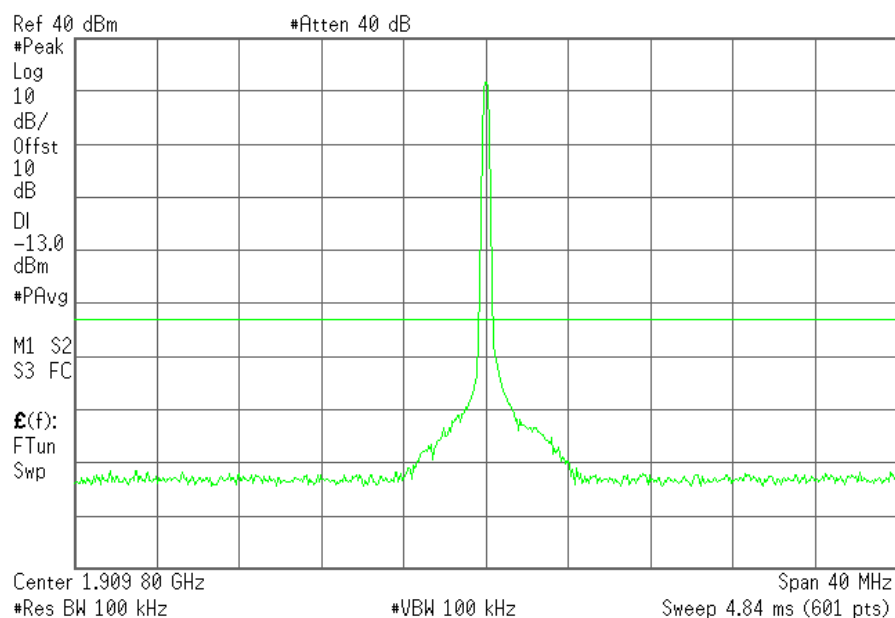

SIERRA WIRELESS, INC.

Plot 6.4.27) Out of Band Emissions at Antenna Terminals

GMSK, High channel 810, 1909.8 MHz, 1 GHz to 20 GHz

* Agilent 13:59:21 3 Apr 2007

L

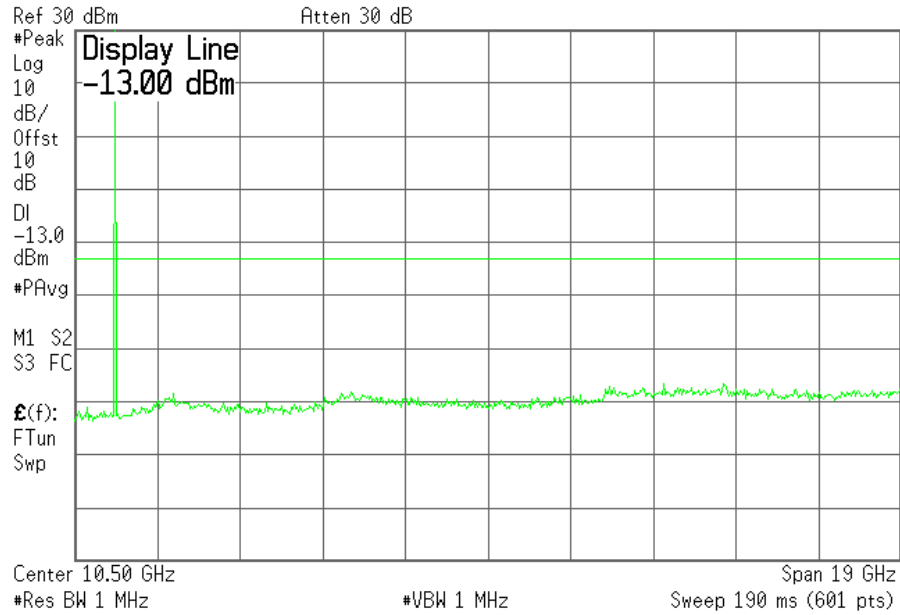

The strong emission shown is the carrier signal.

SIERRA WIRELESS, INC.

Plot 6.4.28) Out of Band Emissions at Antenna Terminals

8-PSK, Low channel 512, 1850.2 MHz, 1 MHz to 1 GHz

* Agilent 09:25:14 21 Mar 2007 L

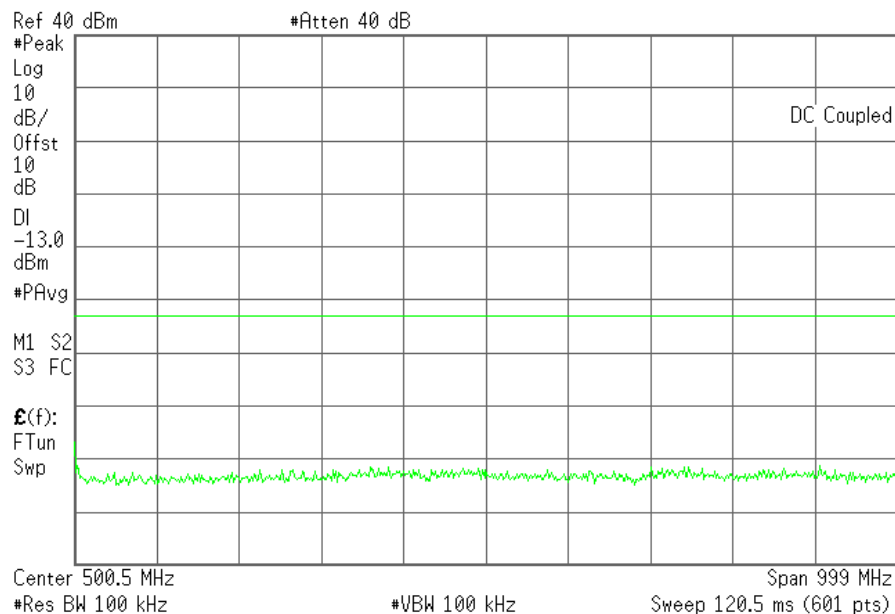

Plot 6.4.29) Out of Band Emissions at Antenna Terminals

8-PSK, Low channel 512, 1850.2 MHz, TX signal +/- 20 MHz

* Agilent 10:19:12 21 Mar 2007 L

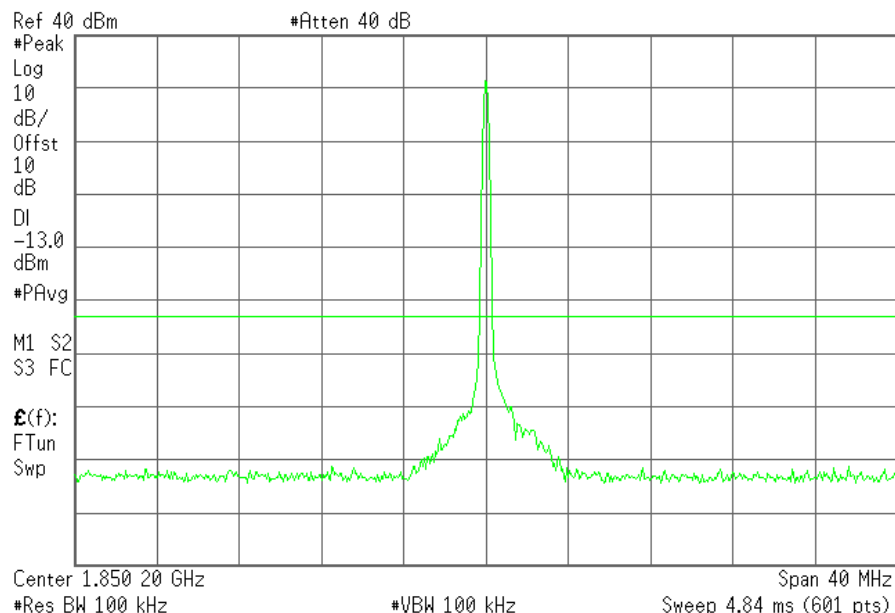

SIERRA WIRELESS, INC.

Plot 6.4.30) Out of Band Emissions at Antenna Terminals

8-PSK, Low channel 512, 1850.2 MHz, 1 GHz to 20 GHz

* Agilent 14:00:23 3 Apr 2007

L

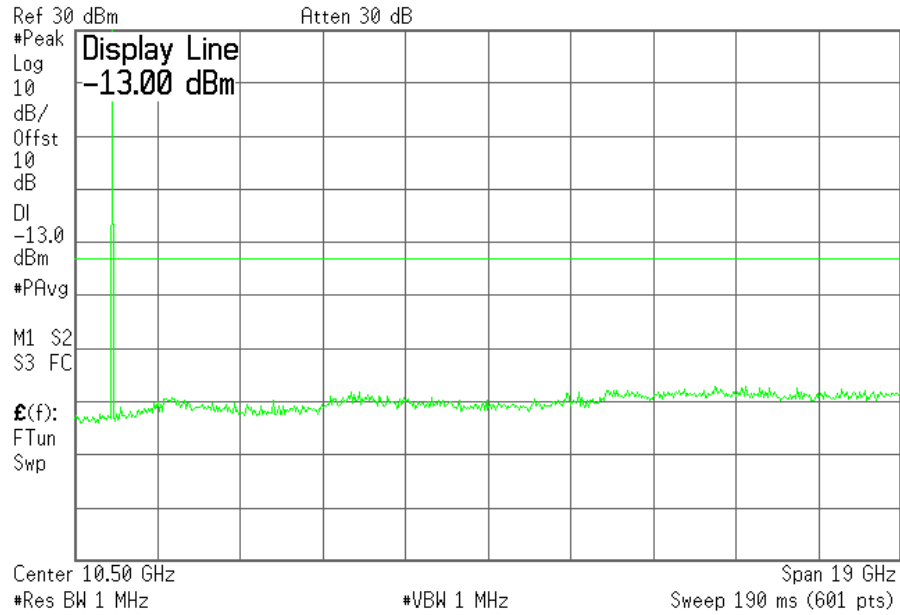

The strong emission shown is the carrier signal.

SIERRA WIRELESS, INC.

Plot 6.4.31) Out of Band Emissions at Antenna Terminals

8-PSK, Middle channel 661, 1880.0 MHz, 1 MHz to 1 GHz

* Agilent 09:26:22 21 Mar 2007 L

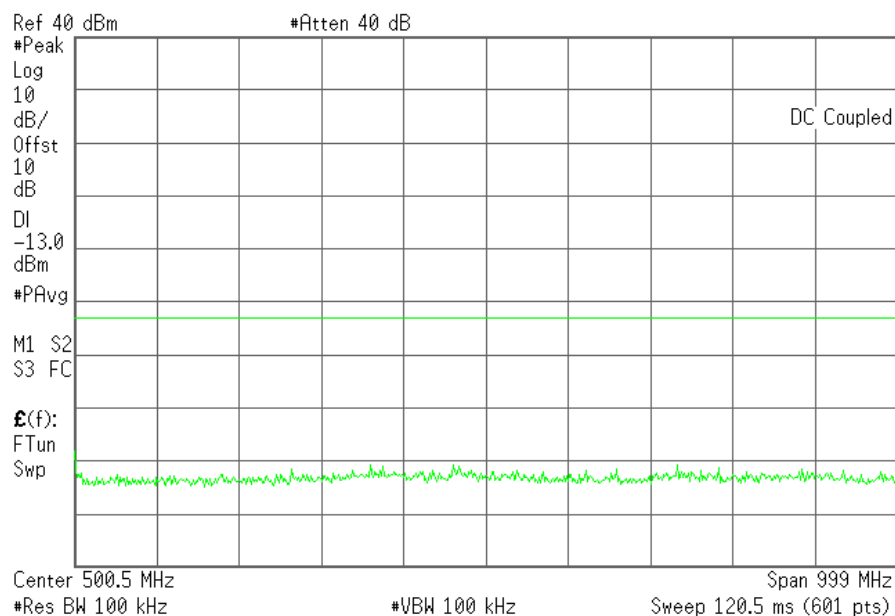

Plot 6.4.32) Out of Band Emissions at Antenna Terminals

8-PSK, Middle channel 661, 1880.0 MHz, TX signal +/- 20 MHz

* Agilent 10:21:10 21 Mar 2007 L

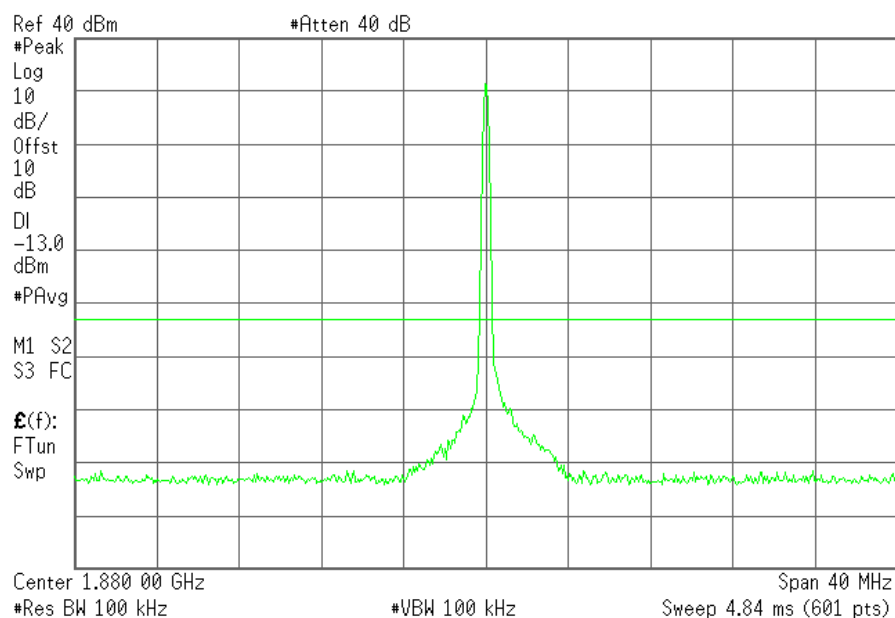

SIERRA WIRELESS, INC.

Plot 6.4.33) Out of Band Emissions at Antenna Terminals

8-PSK, Middle channel 661, 1880.0 MHz, 1 GHz to 20 GHz

* Agilent 14:01:11 3 Apr 2007

L

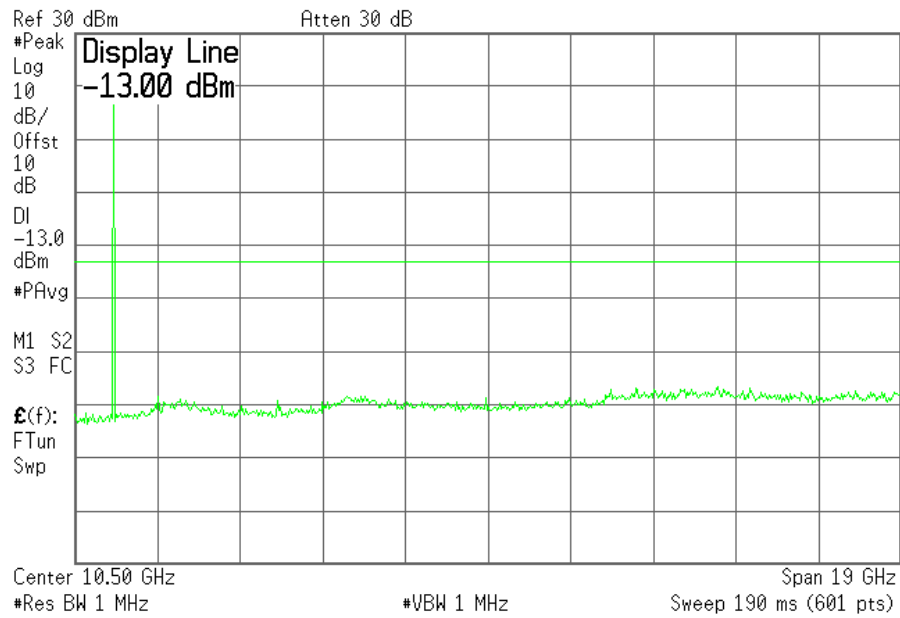

The strong emission shown is the carrier signal.

SIERRA WIRELESS, INC.

Plot 6.4.34) Out of Band Emissions at Antenna Terminals

8-PSK, High channel 810, 1909.8 MHz, 1 MHz to 1 GHz

* Agilent 09:27:23 21 Mar 2007 L

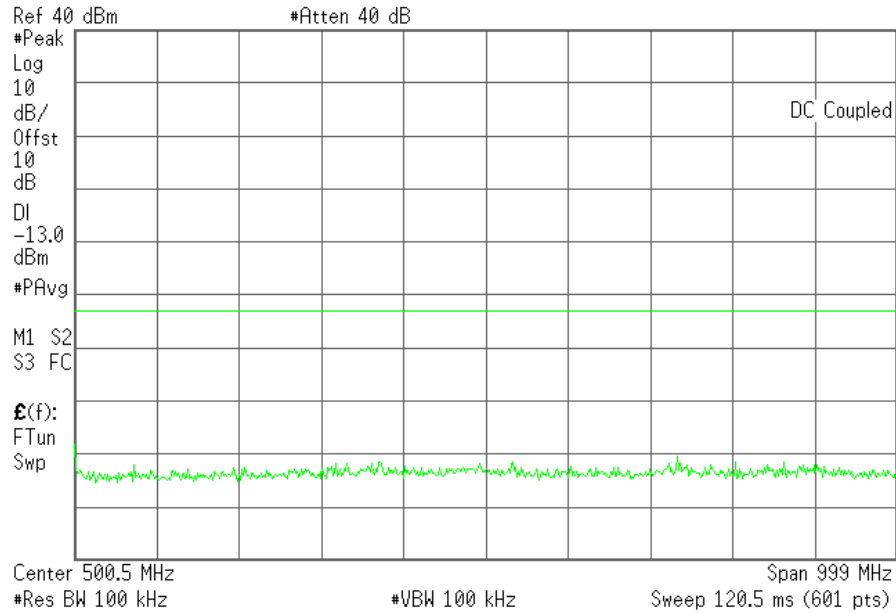

Plot 6.4.35) Out of Band Emissions at Antenna Terminals

8-PSK, High channel 810, 1909.8 MHz, TX signal +/- 20 MHz

* Agilent 10:22:15 21 Mar 2007 L

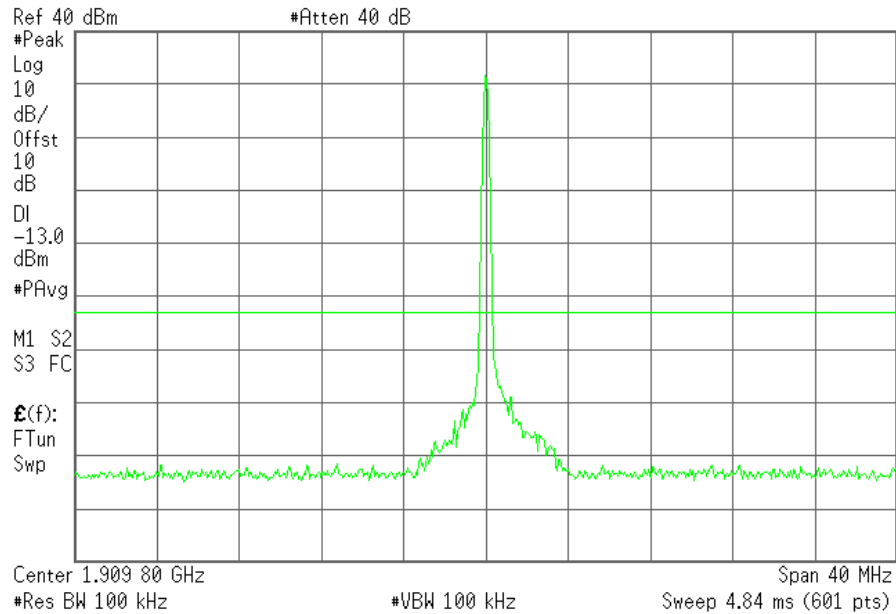

SIERRA WIRELESS, INC.

Plot 6.4.37) Out of Band Emissions at Antenna Terminals

WCDMA, Low channel 4132, 826.4 MHz, 1 MHz to 1 GHz

* Agilent 09:49:49 21 Mar 2007 L

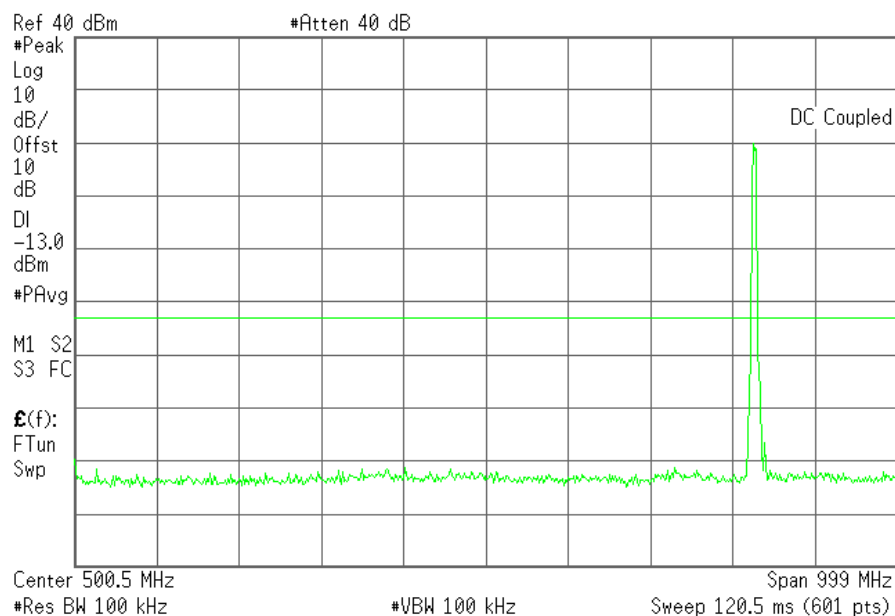

Plot 6.4.38) Out of Band Emissions at Antenna Terminals

WCDMA, Low channel 4132, 826.4 MHz, TX signal +/- 20 MHz

* Agilent 10:25:25 21 Mar 2007 L

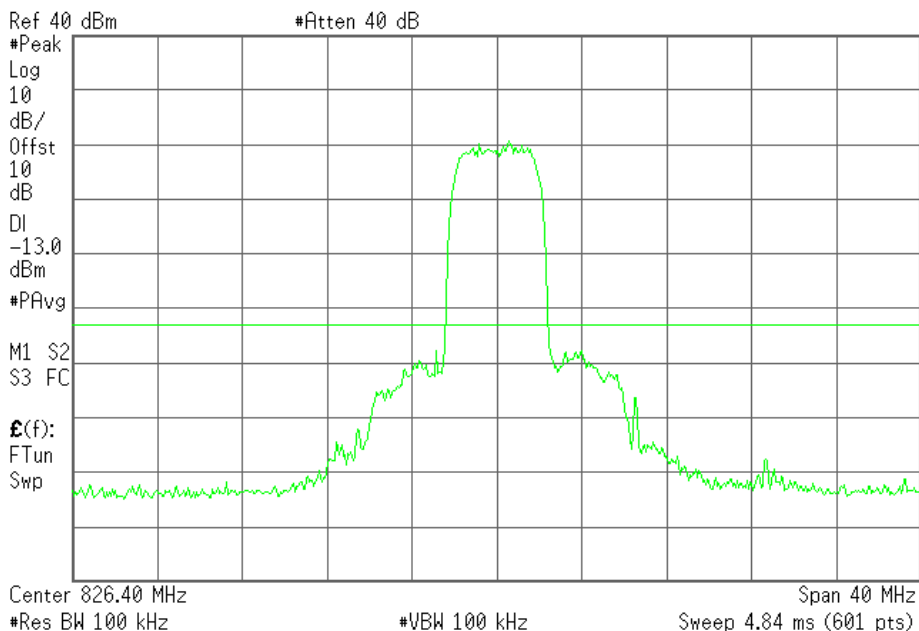

The strong emission shown in each case is the carrier signal.

SIERRA WIRELESS, INC.

Plot 6.4.39) Out of Band Emissions at Antenna Terminals

WCDMA, Low channel 4132, 826.4 MHz, 1 GHz to 20 GHz

* Agilent 14:05:58 3 Apr 2007

L

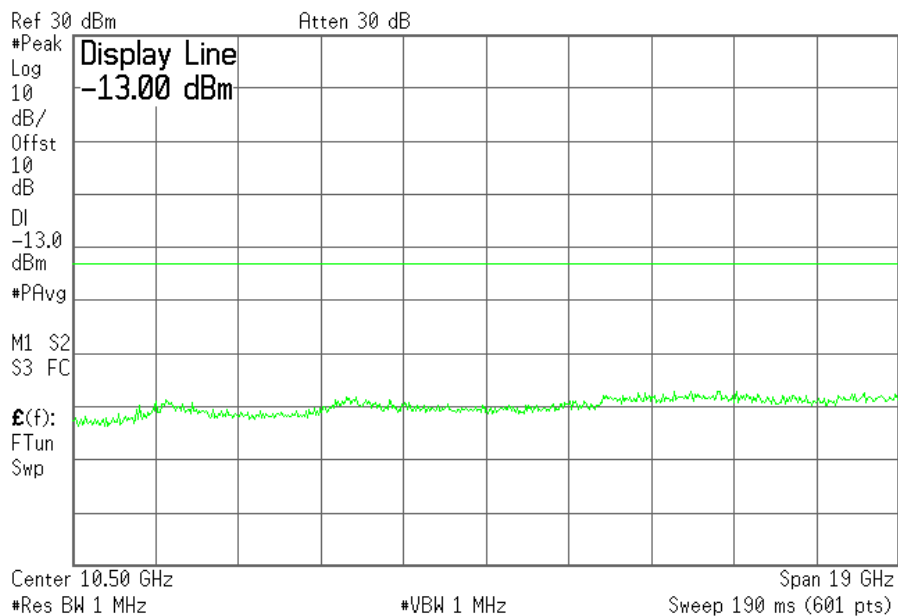

Cellular Harmonics for Ch. 128 (824.2 MHz)	Level (dBm)
Second	--
Third	--
All others	< -30dBm up to 20GHz

SIERRA WIRELESS, INC.

Plot 6.4.40) Out of Band Emissions at Antenna Terminals

WCDMA, Middle channel 4182, 836.4 MHz, 1 MHz to 1 GHz

* Agilent 09:50:43 21 Mar 2007 R

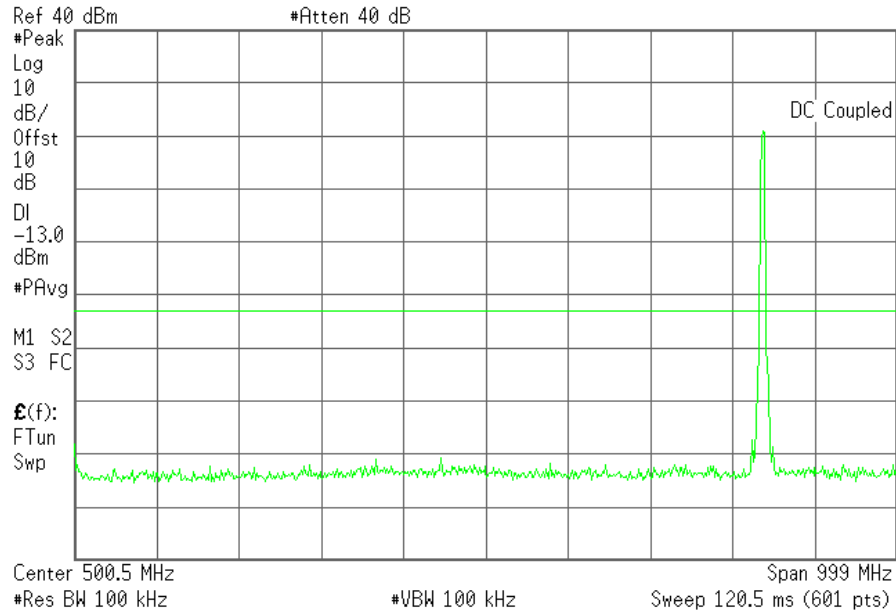

Plot 6.4.41) Out of Band Emissions at Antenna Terminals

WCDMA, Middle channel 4182, 836.4 MHz, TX signal +/- 20 MHz

* Agilent 10:28:07 21 Mar 2007 L

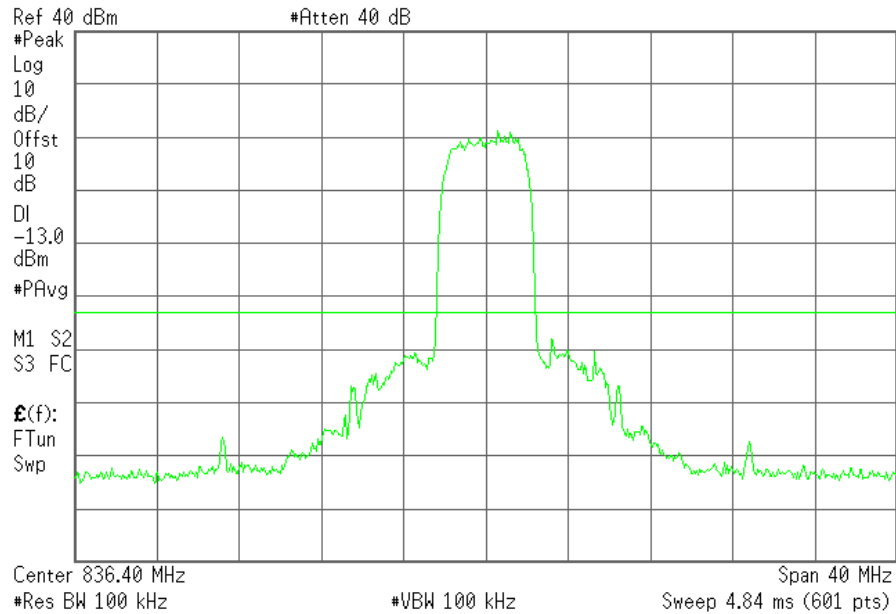

The strong emission shown in each case is the carrier signal.

SIERRA WIRELESS, INC.

Plot 6.4.42) Out of Band Emissions at Antenna Terminals

WCDMA, Middle channel 4182, 836.4 MHz, 1 GHz to 20 GHz

* Agilent 14:06:52 3 Apr 2007

L

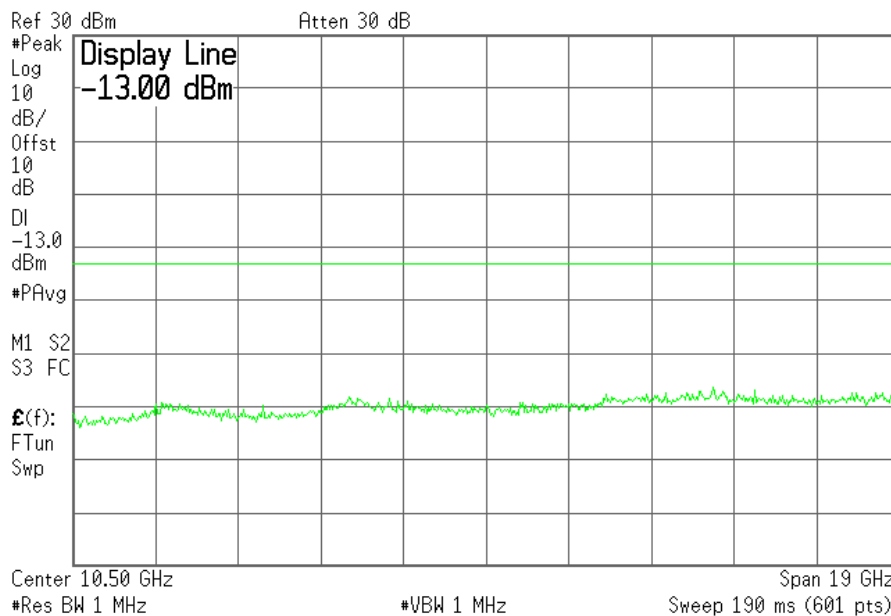

Cellular Harmonics for Ch. 190 (836.6 MHz)	Level (dBm)
Second	--
Third	--
All others	< -30dBm up to 20GHz

SIERRA WIRELESS, INC.

Plot 6.4.43) Out of Band Emissions at Antenna Terminals

WCDMA, High Channel 4233, 846.6 MHz, 1 MHz to 1 GHz

* Agilent 09:51:38 21 Mar 2007 L

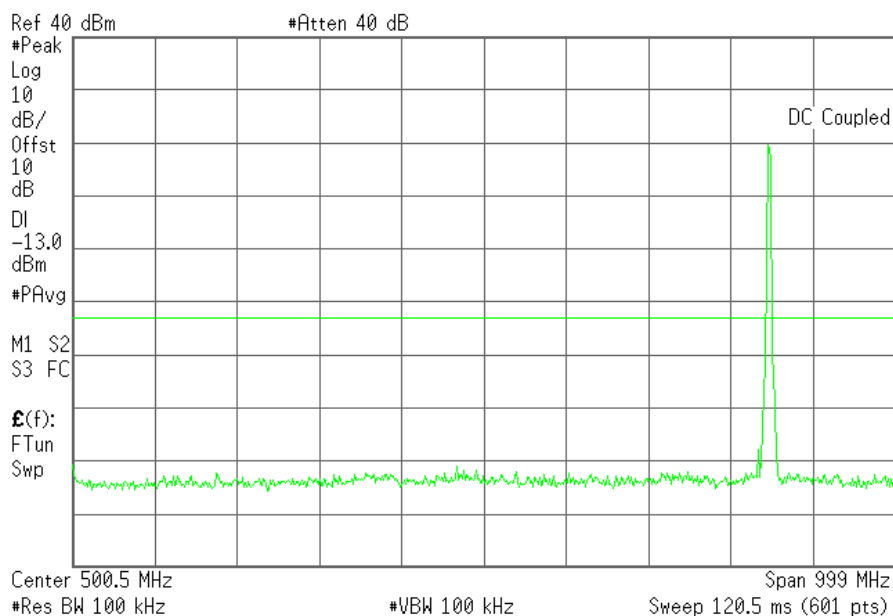

Plot 6.4.44) Out of Band Emissions at Antenna Terminals

WCDMA, High Channel 4233, 846.6 MHz, TX signal +/- 20 MHz

* Agilent 09:52:06 12 Apr 2007 L

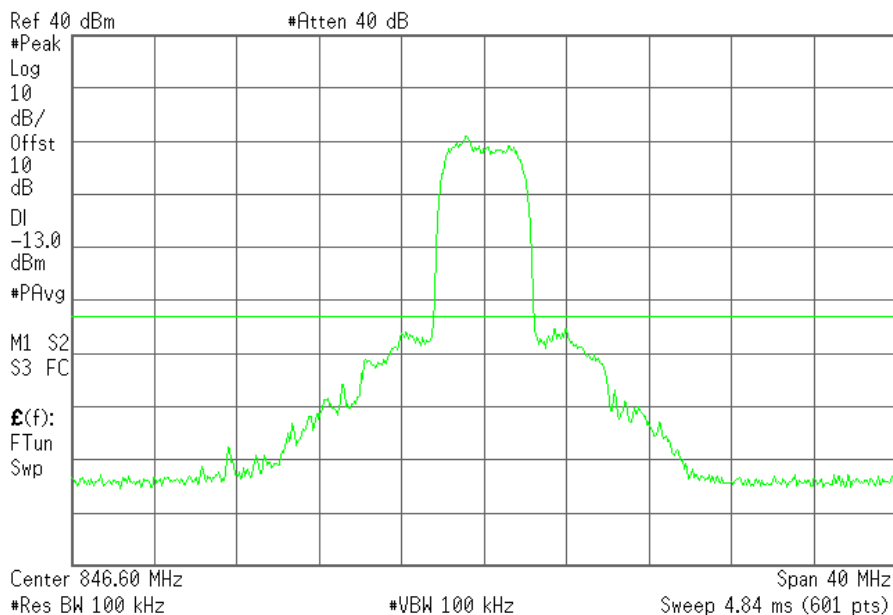

The strong emission shown in each case is the carrier signal.

SIERRA WIRELESS, INC.

Plot 6.4.45) Out of Band Emissions at Antenna Terminals

WCDMA, High Channel 4233, 846.6 MHz, 1 GHz to 20 GHz

* Agilent 14:07:39 3 Apr 2007

L

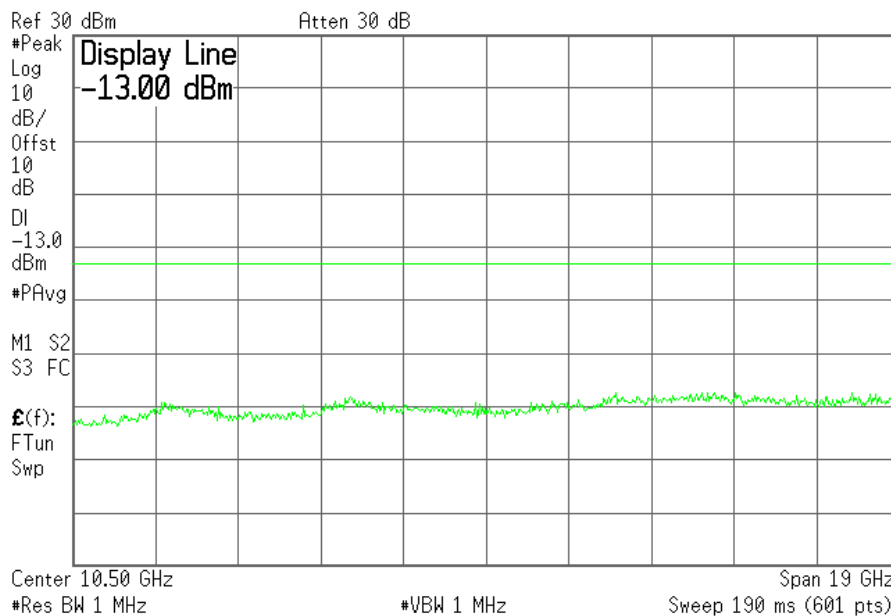

Cellular Harmonics for Ch. 251 (848.8 MHz)	Level (dBm)
Second	--
Third	--
All others	< -30dBm up to 20GHz

SIERRA WIRELESS, INC.

Plot 6.4.46) Out of Band Emissions at Antenna Terminals

WCDMA, Low channel 9262, 1852.4 MHz, 1 MHz to 1 GHz

✱ Agilent 09:55:01 21 Mar 2007 L

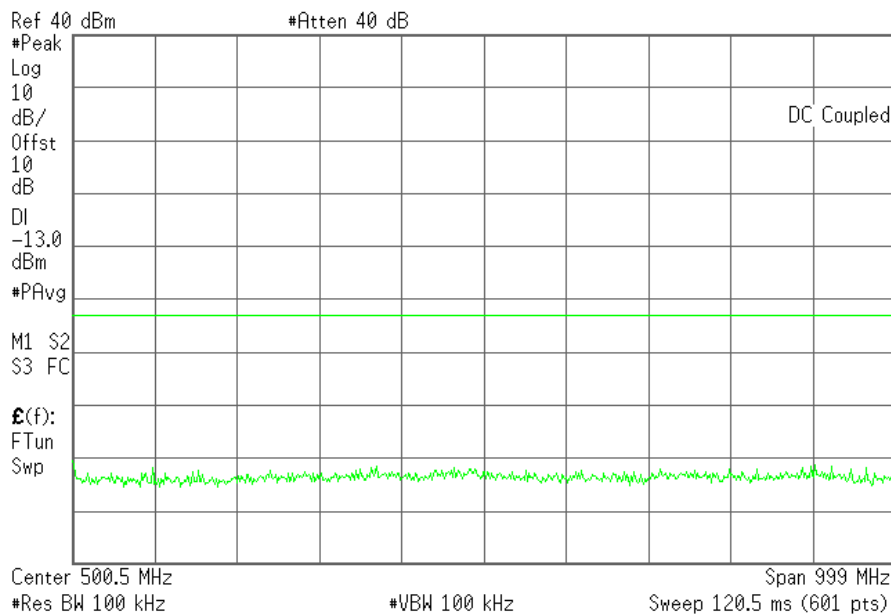

Plot 6.4.47) Out of Band Emissions at Antenna Terminals

WCDMA, Low channel 9262, 1852.4 MHz, TX signal +/- 20 MHz

✱ Agilent 10:48:24 21 Mar 2007 L

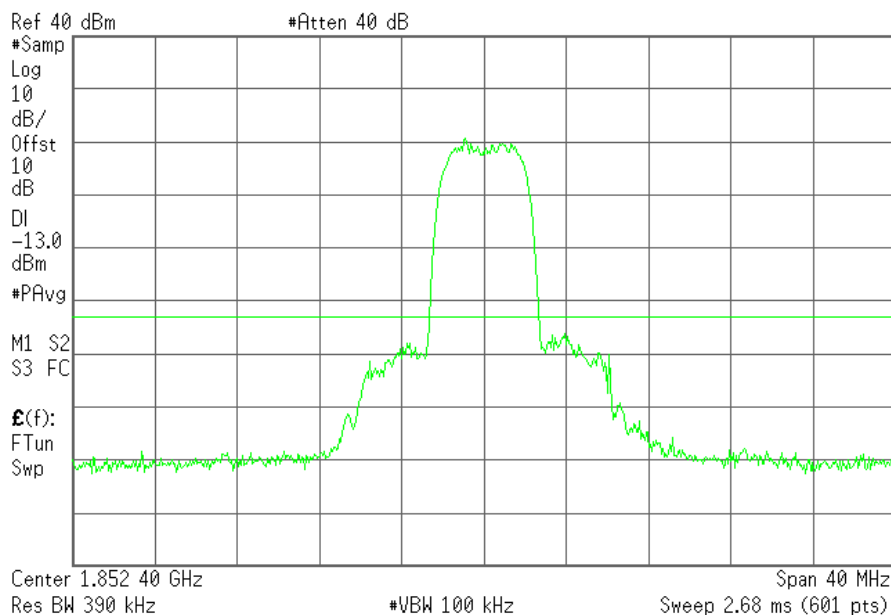

© 2007 Sierra Wireless, Inc.

The contents of this page are subject to the confidentiality information on page one.

SIERRA WIRELESS, INC.

Plot 6.4.48) Out of Band Emissions at Antenna Terminals

WCDMA, Low channel 9262, 1852.4 MHz, 1 GHz to 20 GHz

* Agilent 14:48:54 11 Apr 2007

L

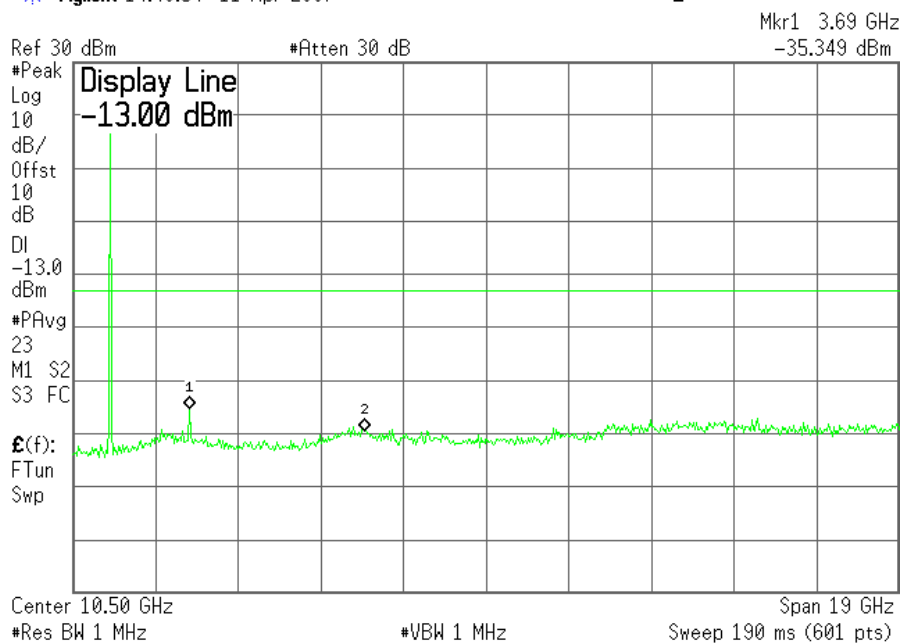

The strong emission shown is the carrier signal.

SIERRA WIRELESS, INC.

Plot 6.4.49) Out of Band Emissions at Antenna Terminals

WCDMA, Middle channel 9400, 1880 MHz, 1 MHz to 1 GHz

* Agilent 09:55:54 21 Mar 2007 L

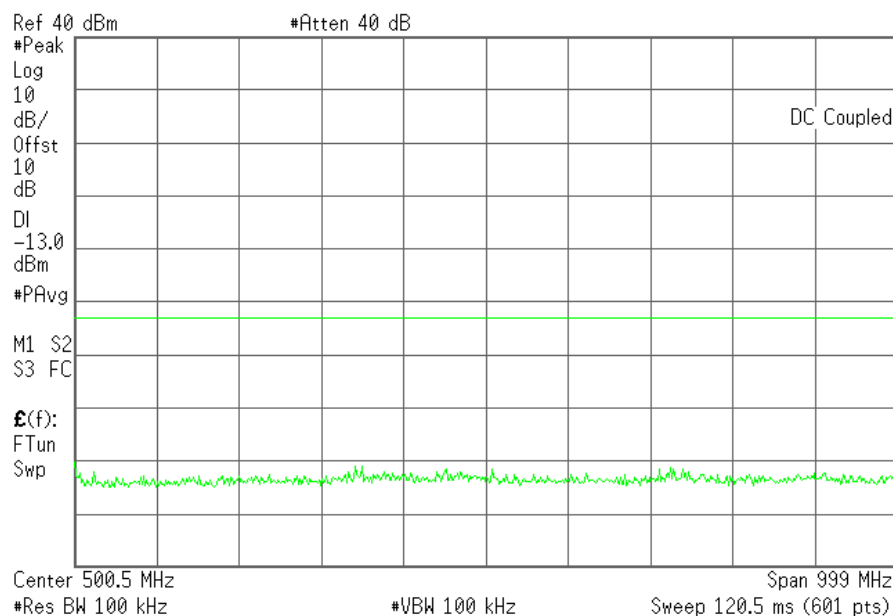

Plot 6.4.50) Out of Band Emissions at Antenna Terminals

WCDMA, Middle channel 9400, 1880 MHz, TX signal +/- 20 MHz

* Agilent 10:50:20 21 Mar 2007 L

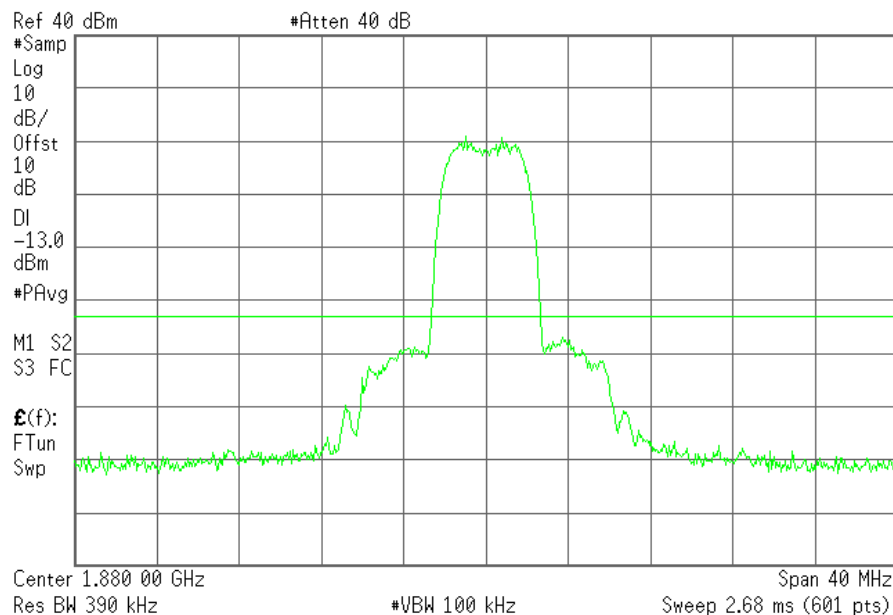

SIERRA WIRELESS, INC.

Plot 6.4.51) Out of Band Emissions at Antenna Terminals

WCDMA, Middle channel 9400, 1880 MHz, 1 GHz to 20 GHz

* Agilent 14:49:26 11 Apr 2007

L

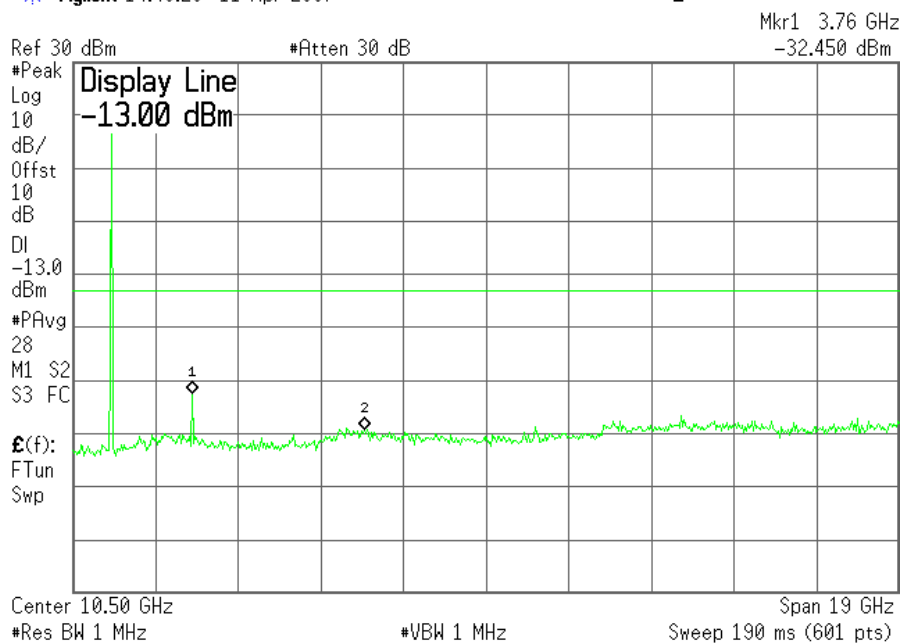

The strong emission shown is the carrier signal.

SIERRA WIRELESS, INC.

Plot 6.4.52) Out of Band Emissions at Antenna Terminals

WCDMA, High channel 9538, 1907.6 MHz, 1 MHz to 1 GHz

* Agilent 09:56:52 21 Mar 2007 L

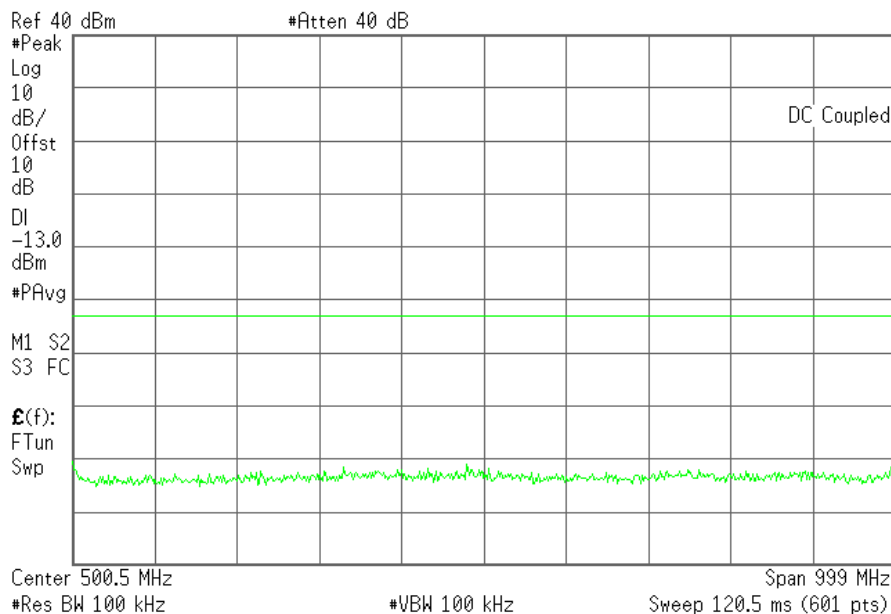

Plot 6.4.53) Out of Band Emissions at Antenna Terminals

WCDMA, High channel 9538, 1907.6 MHz, TX signal +/- 20 MHz

* Agilent 10:51:38 21 Mar 2007 L

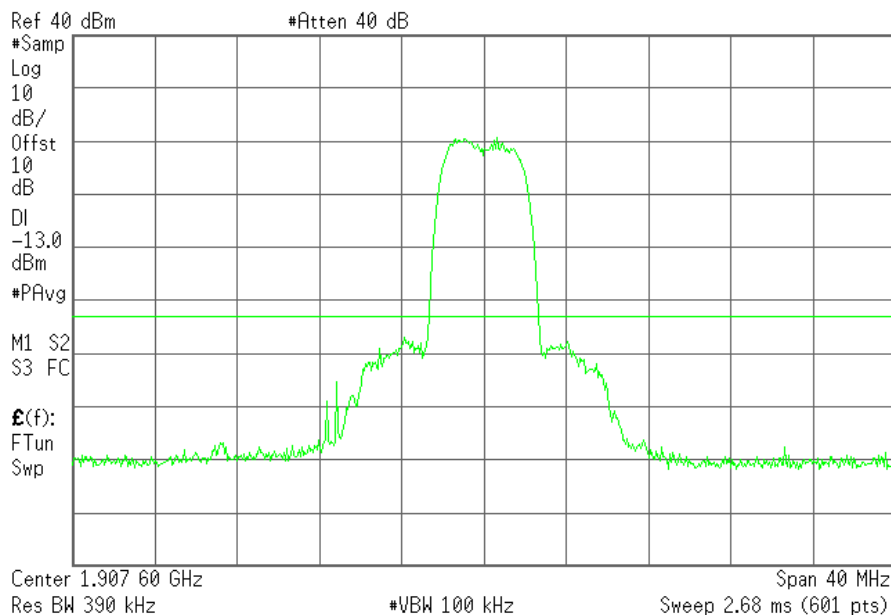

© 2007 Sierra Wireless, Inc.

The contents of this page are subject to the confidentiality information on page one.

SIERRA WIRELESS, INC.

Plot 6.4.54) Out of Band Emissions at Antenna Terminals

WCDMA, High channel 9538, 1907.6 MHz, 1 GHz to 20 GHz

* Agilent 14:50:15 11 Apr 2007

L

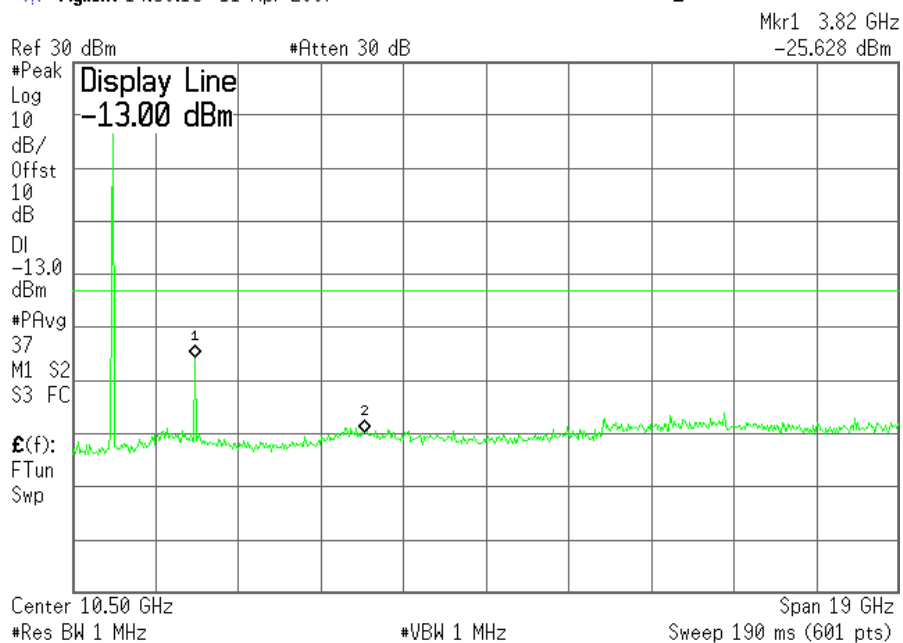

The strong emission shown is the carrier signal.

SIERRA WIRELESS, INC.

7 Block Edge Compliance

FCC part 22H/24E

7.1 Test Procedure

The transmitter output was connected to a Rohde & Schwarz CMU200 Test Set and configured to operate at maximum power. The block edge emissions were measured at the required operating frequencies in each band on the Spectrum Analyzer.

Test Setup

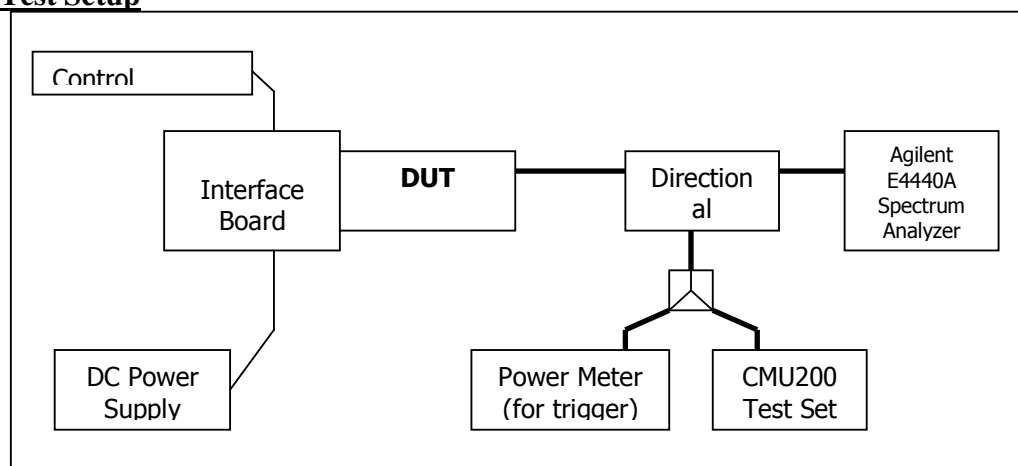

7.2 Test Equipment

Instrument List

EQUIPMENT	MANUFACTURER	MODEL NO.	SERIAL NO.	CAL. DATE
Control Computer	TC	Generic PC	100488	N/A
Wireless Test Set	Rohde & Schwarz	CMU200	836766/030	N/A
Spectrum Analyzer	Agilent	PSA E4440A	US41421268	Mar. 1, 2007
DC Power Supply	HP	6632A	3530A	N/A
Interface Board	Shop built	Minnow	N/A	N/A
Directional Coupler	Mini-Circuits	ZA3PD-2	N/A	N/A

7.3 Test Results

Block Test	Frequency Boundaries (MHz)	Channels Tested	Corresponding Plots	Result
1	GMSK: Below 824 MHz, above 849 MHz	128, 251	7.4.1, 7.4.2	Complies
2	8PSK: Below 824 MHz, above 849 MHz	128, 251	7.4.3, 7.4.4	Complies
3	GMSK: Below 1850MHz, above 1910MHz	512, 810	7.4.5, 7.4.6	Complies
4	8PSK: Below 1850MHz, above 1910MHz	512, 810	7.4.7, 7.4.8	Complies
Block Test	Frequency Boundaries (MHz)	Channels Tested	Corresponding Plots	Result
1	WCDMA: Below 824MHz, above 849MHz	4132, 4233	7.4.9, 7.4.10	Complies
2	WCDMA: Below 1850MHz, above 1910MHz	9262, 9538	7.4.11, 7.4.12	Complies

© 2007 Sierra Wireless, Inc.

The contents of this page are subject to the confidentiality information on page one.

SIERRA WIRELESS, INC.

7.4 Test Plots

Plot 7.4.1) GSMK; Cellular low channel 128, below 824 MHz

Agilent 15:15:20 11 Apr 2007

L

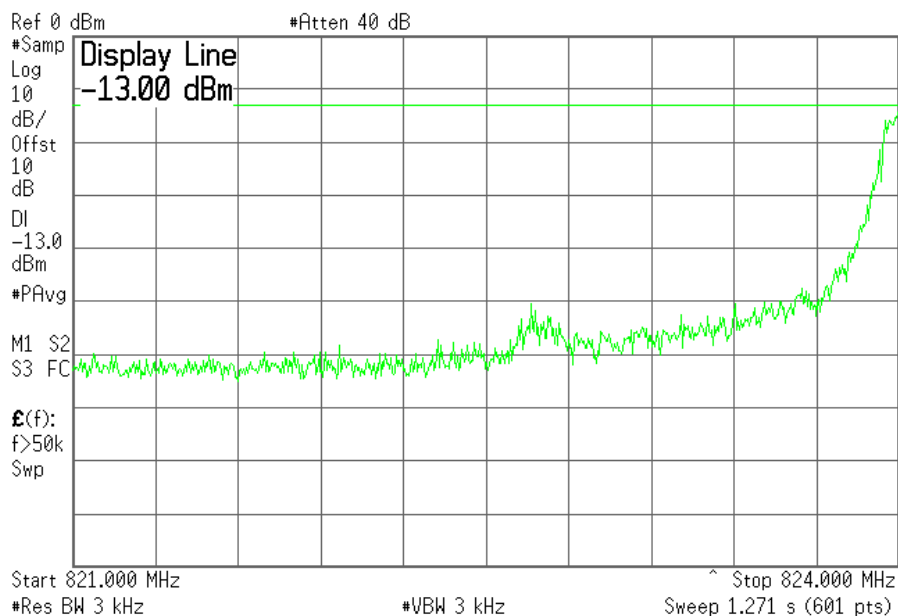

Plot 7.4.2) GMSK; Cellular high channel 251, above 849 MHz

Agilent 15:27:46 11 Apr 2007

L

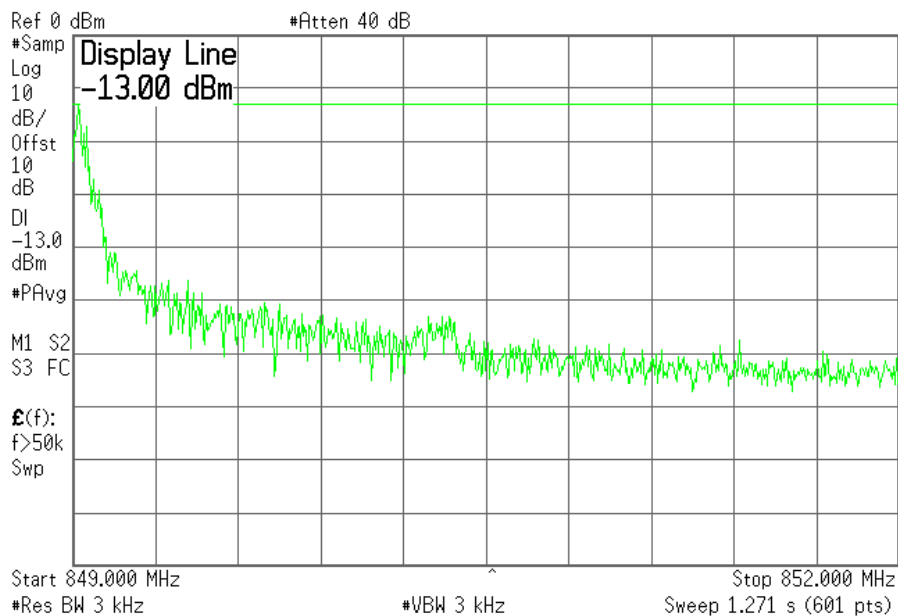

© 2007 Sierra Wireless, Inc.

The contents of this page are subject to the confidentiality information on page one.

SIERRA WIRELESS, INC.

Plot 7.4.3) 8-PSK; Cellular low channel 128, below 824 MHz

Agilent 15:22:06 11 Apr 2007 L

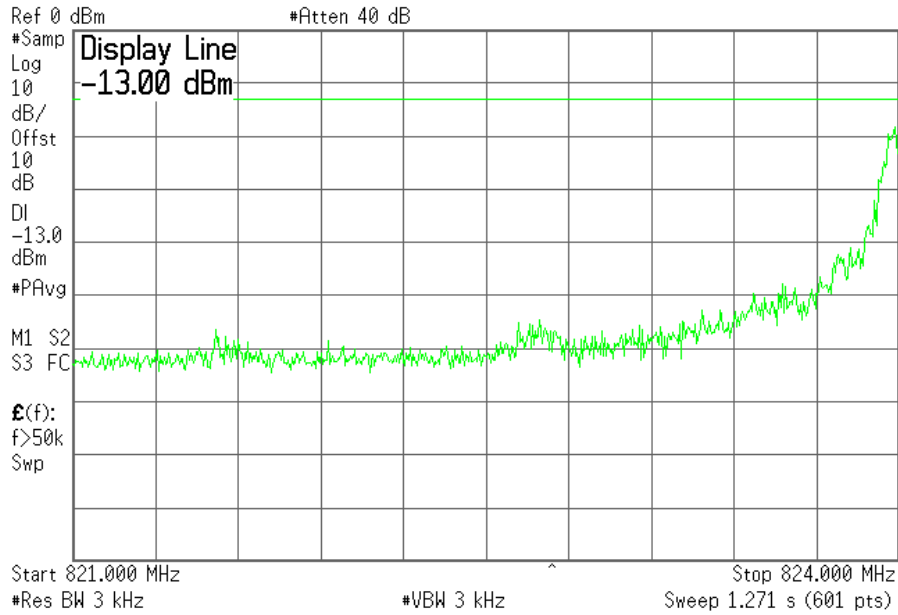

Plot 7.4.4) 8-PSK; Cellular high channel 251, above 849 MHz

Agilent 15:25:11 11 Apr 2007 L

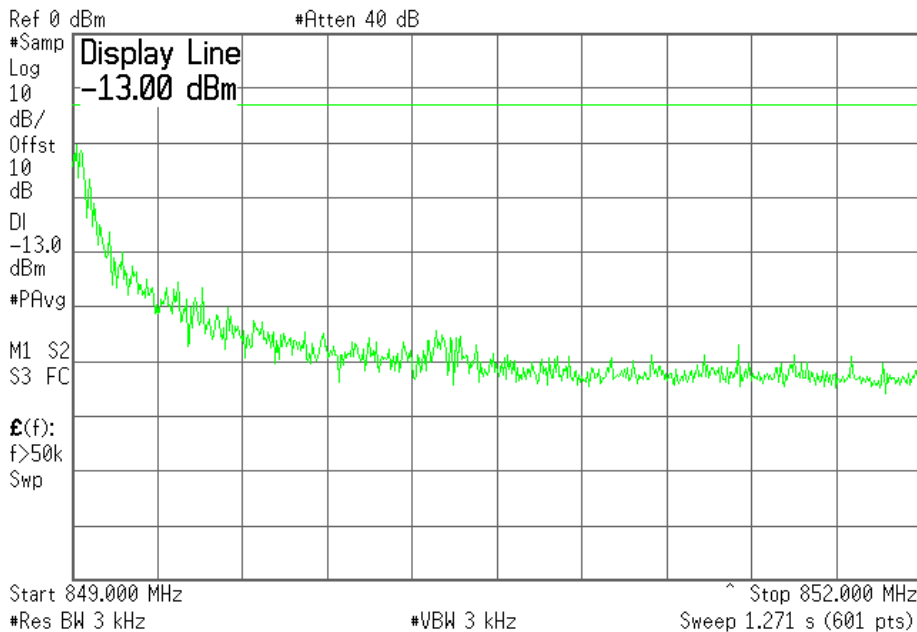

SIERRA WIRELESS, INC.

Plot 7.4.5) GMSK; PCS low channel 512, below 1850 MHz

* Agilent 15:43:25 11 Apr 2007 L

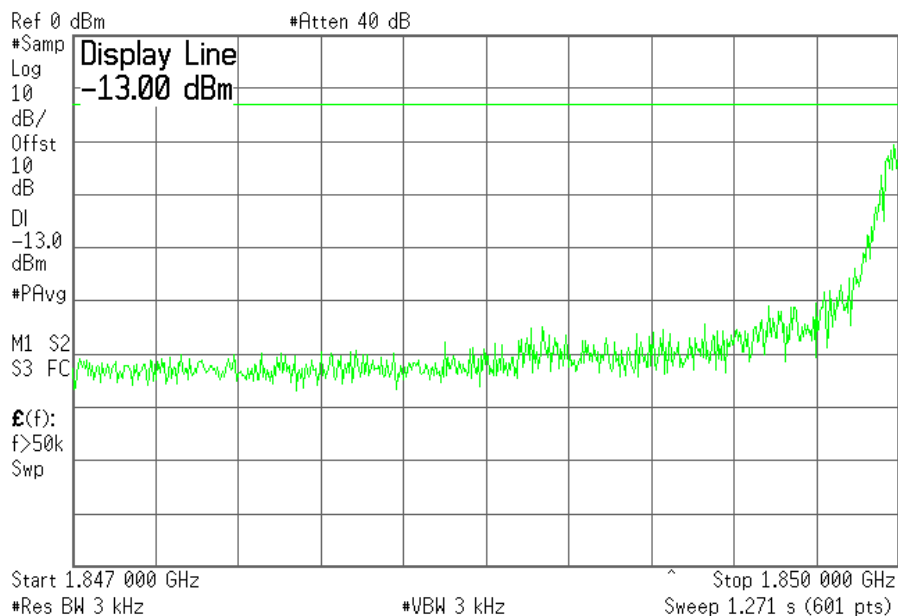

Plot 7.4.6) GMSK; PCS high channel 810, above 1910 MHz

* Agilent 15:51:52 11 Apr 2007 L

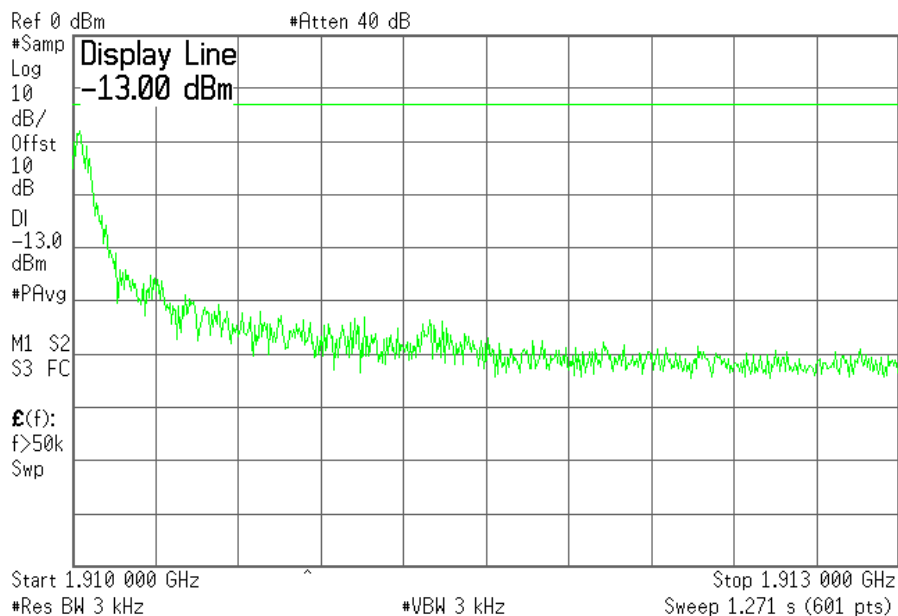

© 2007 Sierra Wireless, Inc.

The contents of this page are subject to the confidentiality information on page one.

SIERRA WIRELESS, INC.

Plot 7.4.7) 8-PSK; PCS low channel, below 1850 MHz

* Agilent 15:46:16 11 Apr 2007

L

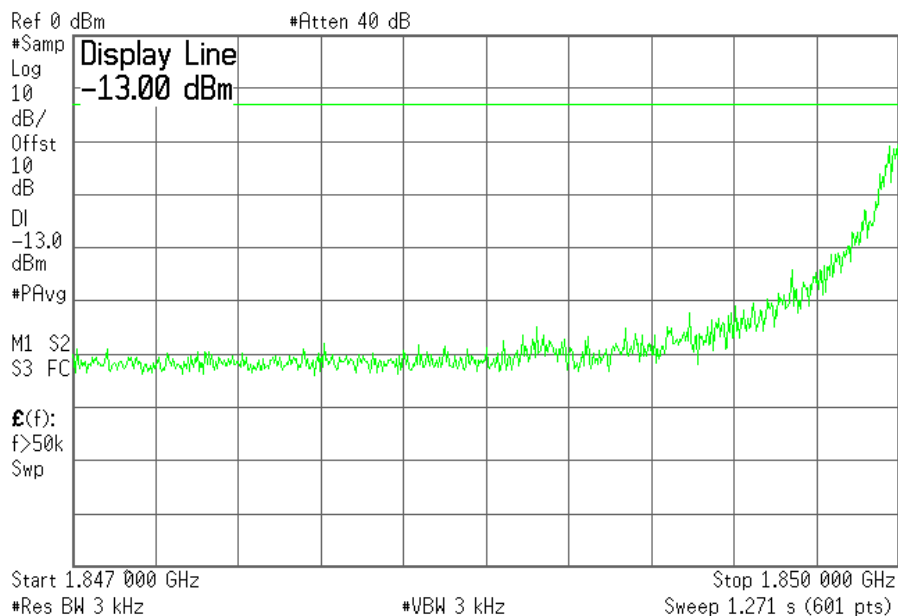

Plot 7.4.8) 8-PSK; PCS high channel 810, above 1910 MHz

* Agilent 15:53:35 11 Apr 2007

L

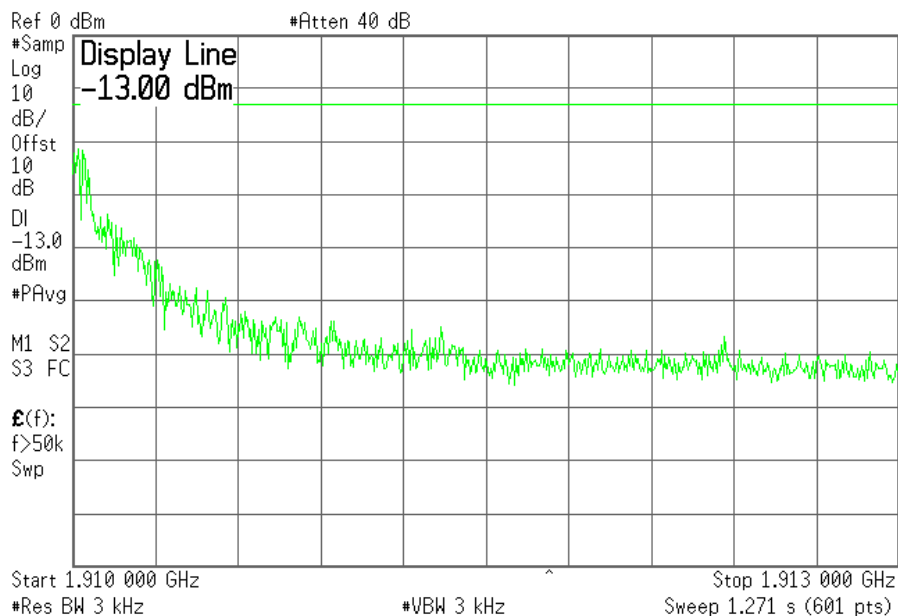

SIERRA WIRELESS, INC.

Plot 7.4.9) WCDMA; Cellular low channel, below 824 MHz

* Agilent 16:36:27 11 Apr 2007

L

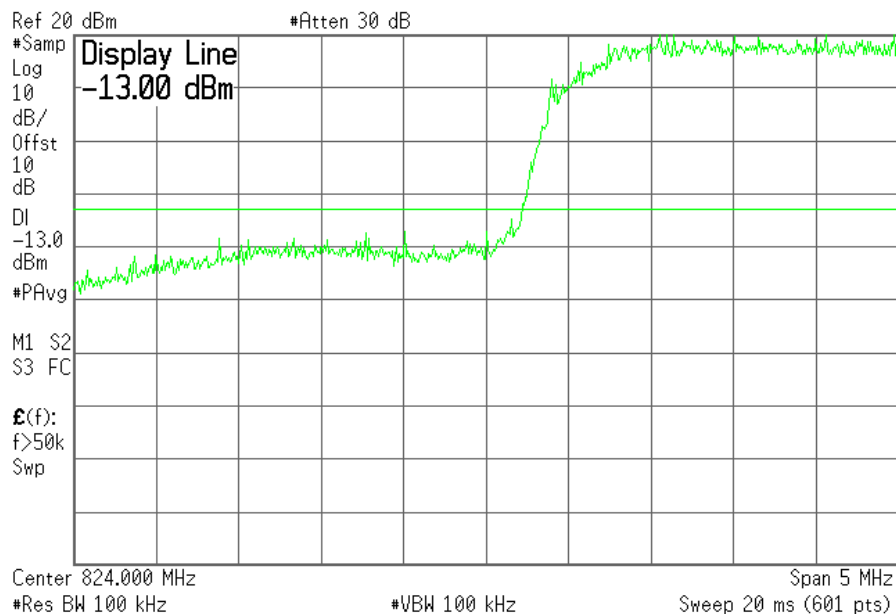

Plot 7.4.10) WCDMA; Cellular high channel, above 849 MHz

* Agilent 17:13:06 11 Apr 2007

L

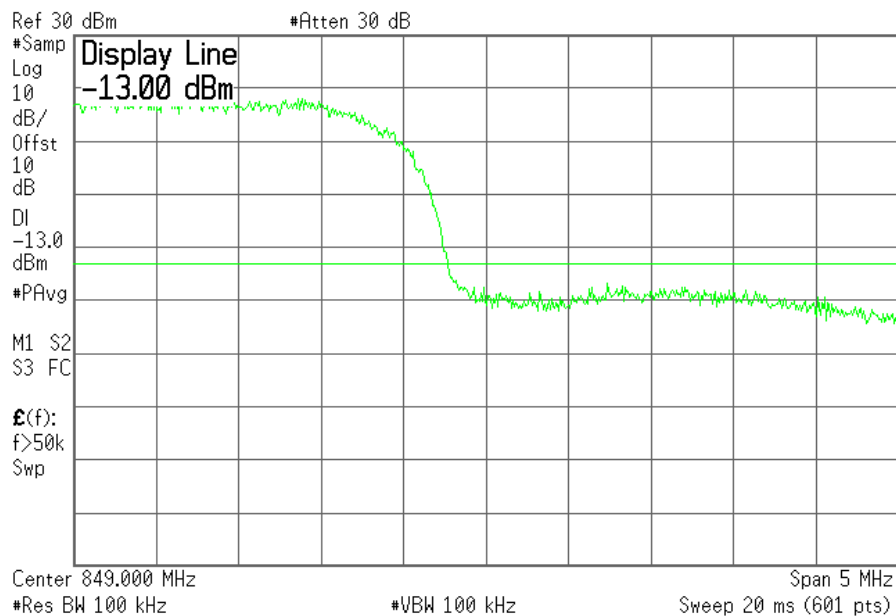

© 2007 Sierra Wireless, Inc.

The contents of this page are subject to the confidentiality information on page one.

SIERRA WIRELESS, INC.

Plot 7.4.11) WCDMA; PCS low channel, below 1850 MHz

* Agilent 17:16:20 11 Apr 2007 L

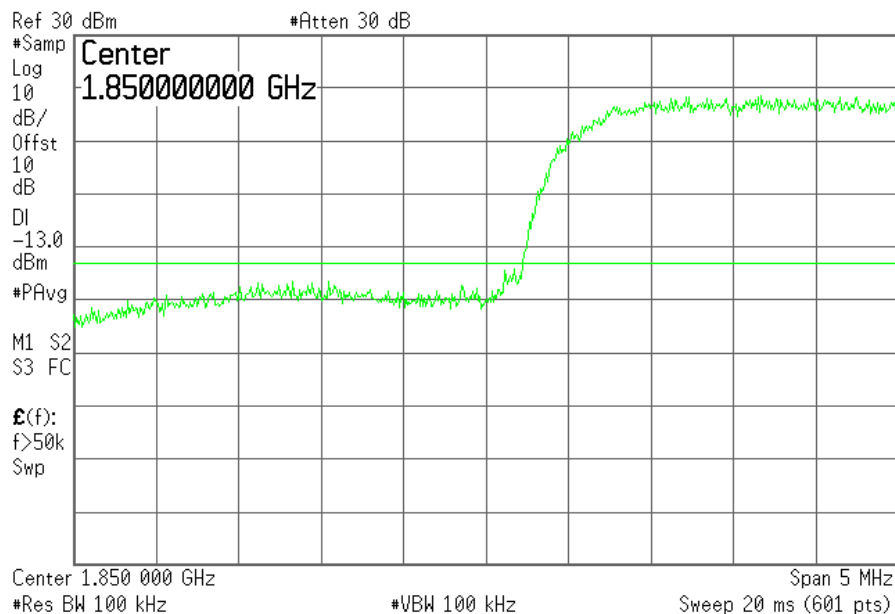

Plot 7.4.12) WCDMA; PCS high channel, above 1910 MHz

* Agilent 17:17:18 11 Apr 2007 L

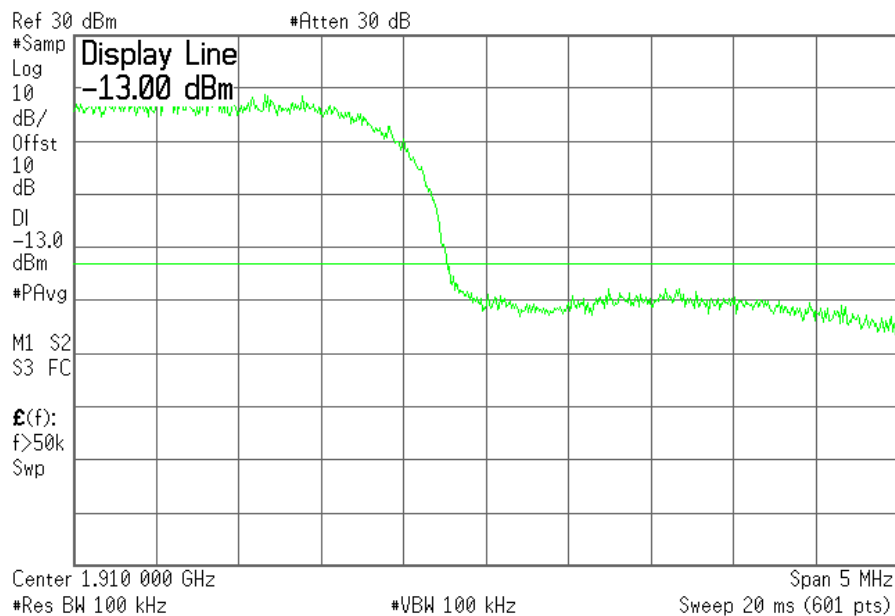

SIERRA WIRELESS, INC.

FCC Part 22 & 24 Test Report	MC8780	Apr 18, 2007	Page 63 of 67
------------------------------	--------	--------------	---------------

8 Frequency Stability Versus Temperature

FCC 2.1055

8.1 Summary of Results

The MC8780 Frequency Stability versus temperature meets the requirement of being within ± 0.1 ppm of the received base station frequency.

8.2 Test Procedure

The MC8780 was placed inside the temperature chamber. The transmitting frequency error is measured at 25 degrees C, and then the temperature is set to +60 degrees C and allowed to stabilize. After sufficient soak time, the transmitting frequency error is measured. The temperature is decreased by 10 degrees, allowed to stabilize and soak, then the measurement is repeated. This is repeated until -20 degrees C is completed. The process is then repeated back up to +60 degrees C. Frequency metering included internal averaging of the CMU200 to stabilize the reading. Reference power supply voltage for these tests is 3.3 volts.

Test Setup

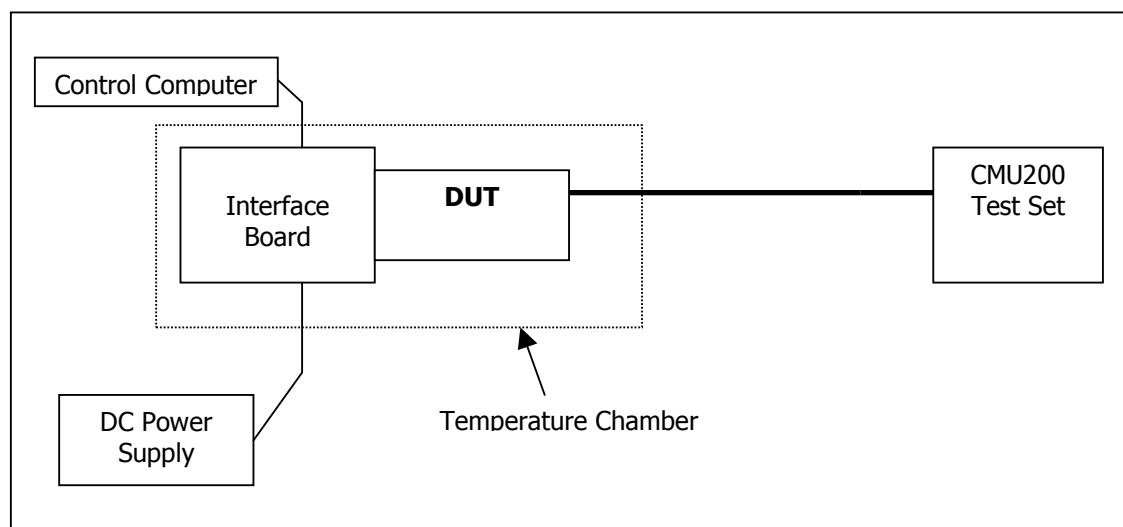

8.3 Test Equipment

EQUIPMENT	MANUFACTURER	MODEL NO.	SERIAL NO.	CAL. DATE
Control Computer	TC	Generic PC	100488	N/A
Wireless Test Set	Rohde & Schwarz	CMU200	836766/030	N/A
Spectrum Analyzer	Agilent	PSA E4440A	US41421268	Mar. 1, 2007
DC Power Supply	HP	6632A	3530A	N/A
Interface Board	Shop built	Minnow	N/A	N/A
Directional Coupler	Mini-Circuits	ZA3PD-2	N/A	N/A

© 2007 Sierra Wireless, Inc.

The contents of this page are subject to the confidentiality information on page one.

SIERRA WIRELESS, INC.

8.4 Test Results

Low to High Temperature Frequency Error

Temp.(C)	Cellular Mode: 824MHz to 848MHz				PCS Mode: 1850MHz to 1909MHz			
	GMSK Mode		8-PSK Mode		GMSK Mode		8-PSK Mode	
	Offset (Hz)	Offset (ppm)	Offset (Hz)	Offset (ppm)	Offset (Hz)	Offset (ppm)	Offset (Hz)	Offset (ppm)
-20	-24	0.0287	-23	0.0275	-33	0.0176	-41	0.0218
-10	-23	0.0275	-25	0.0299	-39	0.0207	-47	0.0250
0	-27	0.0323	-30	0.0359	-36	0.0191	-48	0.0255
10	-24	0.0287	-32	0.0383	-29	0.0154	-49	0.0261
20	-22	0.0263	-29	0.0347	-35	0.0186	-42	0.0223
30	-26	0.0311	-31	0.0371	-33	0.0176	-46	0.0245
40	24	0.0287	26	0.0311	-36	0.0191	-44	0.0234
50	-27	0.0323	-29	0.0347	-38	0.0202	-45	0.0239
60	23	0.0275	25	0.0299	-42	0.0223	-43	0.0229

Temp.(C)	UMTS Mode: 826MHz to 846MHz		UMTS Mode: 1850MHz to 1909MHz	
	Offset (Hz)	Offset (Hz)	Offset (Hz)	Offset (ppm)
-20	-4	0.0048	8	0.0043
-10	8	0.0096	-7	0.0037
0	7	0.0084	-5	0.0027
10	5	0.0060	6	0.0032
20	7	0.0084	-5	0.0027
30	-4	0.0048	-6	0.0032
40	7	0.0084	6	0.0032
50	6	0.0072	-5	0.0027
60	9	0.0108	4	0.0021

SIERRA WIRELESS, INC.

High to Low Temperature Frequency Error

Temp.(C)	Cellular Mode: 824MHz to 848MHz				PCS Mode: 1850MHz to 1909MHz			
	GMSK Mode		8-PSK Mode		GMSK Mode		8-PSK Mode	
	Offset (Hz)	Offset (ppm)	Offset (Hz)	Offset (ppm)	Offset (Hz)	Offset (ppm)	Offset (Hz)	Offset (ppm)
60	-19	0.0227	-27	0.0323	-36	0.0191	-42	0.0223
50	-21	0.0251	-26	0.0311	-35	0.0186	-48	0.0255
40	24	0.0287	23	0.0275	-34	0.0181	-46	0.0245
30	-25	0.0299	-28	0.0335	-28	0.0149	-41	0.0218
20	-21	0.0251	-26	0.0311	-32	0.0170	-39	0.0207
10	-25	0.0299	-27	0.0323	-35	0.0186	-55	0.0293
0	-21	0.0251	-25	0.0299	-36	0.0191	-56	0.0298
-10	22	0.0263	25	0.0299	-35	0.0186	-43	0.0229
-20	-24	0.0287	-23	0.0275	-33	0.0176	-41	0.0218

Temp.(C)	UMTS Mode: 826MHz to 846MHz		UMTS Mode: 1850MHz to 1909MHz	
	Offset (Hz)	Offset (Hz)	Offset (ppm)	Offset (ppm)
60	8	0.0096	-6	0.0032
50	7	0.0084	-5	0.0027
40	7	0.0084	6	0.0032
30	6	0.0072	-6	0.0032
20	-6	0.0072	-4	0.0021
10	5	0.0060	-6	0.0032
0	5	0.0060	-7	0.0037
-10	-7	0.0084	3	0.0016
-20	8	0.0096	-4	0.0021

SIERRA WIRELESS, INC.

FCC Part 22 & 24 Test Report	MC8780	Apr 18, 2007	Page 66 of 67
------------------------------	--------	--------------	---------------

9 Frequency Stability Versus Voltage

FCC 2.1055

9.1 Summary of Results

The unit meets the limit of less than 0.1ppm of frequency offset from center for 85% and 115% of the supply voltage for 3.3 volts.

9.2 Test Procedure

The MC8780 was connected to a DC Power Supply and a UMTS test set (CMU 200) with frequency error measurement capability. The power supply output is adjusted to the test voltage as measured at the input terminals to the module while transmitting. A voltmeter was used to confirm the terminal voltage. The peak frequency error is recorded (worst case).

The test voltages are 2.8 volts to 3.8 volts.

Test Setup

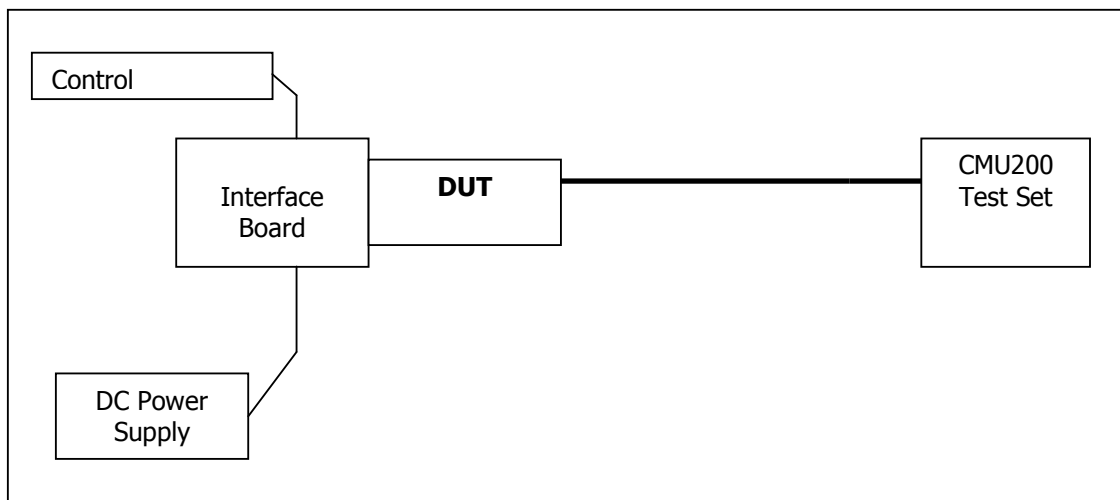

9.3 Test Equipment

EQUIPMENT	MANUFACTURER	MODEL NO.	SERIAL NO.	CAL. DATE
Control Computer	TC	Generic PC	100488	N/A
Wireless Test Set	Rohde & Schwarz	CMU200	836766/030	N/A
Spectrum Analyzer	Agilent	PSA E4440A	US41421268	Mar. 1, 2007
DC Power Supply	HP	6632A	3530A	N/A
Interface Board	Shop built	Minnow	N/A	N/A
Directional Coupler	Mini-Circuits	ZA3PD-2	N/A	N/A

© 2007 Sierra Wireless, Inc.

The contents of this page are subject to the confidentiality information on page one.

SIERRA WIRELESS, INC.

9.4 Test Results

GSM 85% to 115% of 5.0 Volts Frequency Error

Supply (V)	Cellular Mode: 824MHz to 848MHz				PCS Mode: 1850MHz to 1909MHz			
	GMSK Mode		8-PSK Mode		GMSK Mode		8-PSK Mode	
	Offset (Hz)	Offset (ppm)	Offset (Hz)	Offset (ppm)	Offset (Hz)	Offset (ppm)	Offset (Hz)	Offset (ppm)
4.2	-27	0.0323	-26	0.0311	-29	0.0154	-46	0.0245
4.3	-26	0.0311	-28	0.0335	-31	0.0165	-47	0.0250
4.4	-26	0.0311	-25	0.0299	-32	0.0170	-46	0.0245
4.5	-25	0.0299	-23	0.0275	-35	0.0186	-44	0.0234
4.6	-25	0.0299	-27	0.0323	-32	0.0170	-48	0.0255
4.7	-21	0.0251	-25	0.0299	-30	0.0160	-41	0.0218
4.8	-22	0.0263	-27	0.0323	-31	0.0165	-44	0.0234
4.9	-21	0.0251	-24	0.0287	-35	0.0186	-42	0.0223
5.0	-20	0.0239	-23	0.0275	-30	0.0160	-40	0.0213
5.1	-20	0.0239	-28	0.0335	-32	0.0170	-46	0.0245
5.2	-22	0.0263	-29	0.0347	-34	0.0181	-53	0.0282
5.3	-24	0.0287	-23	0.0275	-31	0.0165	-45	0.0239
5.4	-21	0.0251	-29	0.0347	-31	0.0165	-46	0.0245
5.5	-23	0.0275	-26	0.0311	-32	0.0170	-53	0.0282
5.6	-22	0.0263	-28	0.0335	-29	0.0154	-55	0.0293
5.7	-25	0.0299	-27	0.0323	-33	0.0176	-51	0.0271
5.8	-26	0.0311	-29	0.0347	-30	0.0160	-49	0.0261

Supply (V)	UMTS Mode			
	850MHz		1900MHz	
	Offset (Hz)	Offset (ppm)	Offset (Hz)	Offset (ppm)
4.2	5	0.0060	4	0.0021
4.3	5	0.0060	6	0.0032
4.4	6	0.0072	3	0.0016
4.5	5	0.0060	2	0.0011
4.6	4	0.0048	1	0.0005
4.7	5	0.0060	4	0.0021
4.8	4	0.0048	3	0.0016
4.9	3	0.0036	-1	0.0005
5.0	4	0.0048	-4	0.0021
5.1	6	0.0072	-3	0.0016
5.2	4	0.0048	2	0.0011
5.3	3	0.0036	3	0.0016
5.4	3	0.0036	3	0.0016
5.5	4	0.0048	-1	0.0005
5.6	4	0.0048	2	0.0011
5.7	2	0.0024	-1	0.0005