



RADIO TEST REPORT

Test Report No. : 13063556M-B-R2

Applicant : PIONEER CORPORATION
Type of Equipment : RDS AV RECEIVER
Model No. : DMH-WC6600NEX
FCC ID : AJDK112
Test regulation : FCC Part 15 Subpart C: 2019
*Wireless LAN & Bluetooth Low Energy part
Test items : Radiated emission tests
Test Result : Complied (Refer to SECTION 3.2)

1. This test report shall not be reproduced in full or partial, without the written approval of UL Japan, Inc.
2. The results in this report apply only to the sample tested.
3. This sample tested is in compliance with the limits of the above regulation.
4. The test results in this test report are traceable to the national or international standards.
5. This test report must not be used by the customer to claim product certification, approval, or endorsement by any agency of the Federal Government.
6. This test report covers Radio technical requirements.
It does not cover administrative issues such as Manual or non-Radio test related Requirements. (if applicable)
7. The all test items in this test report are conducted by UL Japan, Inc. Kashima EMC Lab.
8. The opinions and the interpretations to the result of the description in this report are outside scopes where UL Japan has been accredited.
9. The information provided from the customer for this report is identified in SECTION 1.
10. This report is a revised version of 13063556M-B-R1. 13063556M-B-R1 is replaced with this report.

Date of test: September 27 to October 29, 2019

Representative test engineer: 
Hiromitsu Tanabe
Engineer
Consumer Technology Division

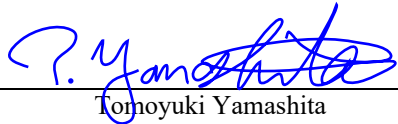
Approved by: 
Tomoyuki Yamashita
Leader
Consumer Technology Division



CERTIFICATE 1266.01

- The testing in which "Non-accreditation" is displayed is outside the accreditation scopes in UL Japan.
 There is no testing item of "Non-accreditation".

UL Japan, Inc.

Kashima EMC Lab.

1614, Mushihata, Katori-shi, Chiba-ken, 289-0341 Japan

Telephone : +81 478 88 6500

Facsimile : +81 478 82 3373

REVISION HISTORY

Original Test Report No.: 13063556M-B

Revision	Test report No.	Date	Page revised	Contents
- (Original)	13063556M-B	January 16, 2020	-	-
1	13063556M-B-R1	February 4, 2020	P.5	Remove from Clock frequency (ies) in the system: "Bluetooth Wi-Fi module: 32.768 kHz"
1	13063556M-B-R1	February 4, 2020	P.6	Modify the Frequency of Operation for WLAN (IEEE802.11.a/n/ac) from 5725 MHz-5825 MHz to 5745 MHz (IEEE 802.11a/n-20) 5755 MHz (IEEE 802.11n-40/ac-40) 5775 MHz (IEEE 802.11ac-80)
1	13063556M-B-R1	February 4, 2020	P.6	Modify the Type of Modulation for WLAN (IEEE802.11.b/g/n) from external to DSSS
1	13063556M-B-R1	February 4, 2020	P.6	Delete the Frequency Band and Transmit Power or Power Range from the Radio Specification
1	13063556M-B-R1	February 4, 2020	P.7	Modify the reference test report number from 13063555S-A to 13063555S-A-R1
2	13063556M-B-R2	February 14, 2020	P.6	Modify the Antenna Gain for Bluetooth from -9.4 dBi to -14.5 dBi
2	13063556M-B-R2	February 14, 2020	P.6	Modify the Antenna Gain for WLAN (IEEE802.11.b/g/n) from -11.9 dBi to -11.2 dBi
2	13063556M-B-R2	February 14, 2020	P.6	Modify the Antenna Gain for WLAN (IEEE802.11.a/n/ac) from -11.1 dBi to -13.2 dBi
2	13063556M-B-R2	February 14, 2020	P.6	Modify the Emission Designation (ITU Code) for WLAN (IEEE802.11.b) from D1D to G1D
2	13063556M-B-R2	February 14, 2020	P.7	Modify the reference test report number from 13063555S-A-R1 to 13063555S-A-R2
2	13063556M-B-R2	February 14, 2020	P.12	Modify the Shielded condition for GPS Antenna from Unshielded to Shielded

UL Japan, Inc.

Kashima EMC Lab.

1614, Mushihata, Katori-shi, Chiba-ken, 289-0341 Japan

Telephone : +81 478 88 6500

Facsimile : +81 478 82 3373

Reference: Abbreviations (Including words undescribed in this report)

A2LA	The American Association for Laboratory Accreditation	MCS	Modulation and Coding Scheme
AC	Alternating Current	MRA	Mutual Recognition Arrangement
AFH	Adaptive Frequency Hopping	N/A	Not Applicable
AM	Amplitude Modulation	NIST	National Institute of Standards and Technology
Amp, AMP	Amplifier	NS	No signal detect.
ANSI	American National Standards Institute	NSA	Normalized Site Attenuation
Ant, ANT	Antenna	NVLAP	National Voluntary Laboratory Accreditation Program
AP	Access Point	OBW	Occupied Band Width
ASK	Amplitude Shift Keying	OFDM	Orthogonal Frequency Division Multiplexing
Atten., ATT	Attenuator	P/M	Power meter
AV	Average	PCB	Printed Circuit Board
BPSK	Binary Phase-Shift Keying	PER	Packet Error Rate
BR	Bluetooth Basic Rate	PHY	Physical Layer
BT	Bluetooth	PK	Peak
BT LE	Bluetooth Low Energy	PN	Pseudo random Noise
BW	BandWidth	PRBS	Pseudo-Random Bit Sequence
Cal Int	Calibration Interval	PSD	Power Spectral Density
CCK	Complementary Code Keying	QAM	Quadrature Amplitude Modulation
Ch., CH	Channel	QP	Quasi-Peak
CISPR	Comite International Special des Perturbations Radioelectriques	QPSK	Quadri-Phase Shift Keying
CW	Continuous Wave	RBW	Resolution Band Width
DBPSK	Differential BPSK	RDS	Radio Data System
DC	Direct Current	RE	Radio Equipment
D-factor	Distance factor	RF	Radio Frequency
DFS	Dynamic Frequency Selection	RMS	Root Mean Square
DQPSK	Differential QPSK	RSS	Radio Standards Specifications
DSSS	Direct Sequence Spread Spectrum	Rx	Receiving
EDR	Enhanced Data Rate	SA, S/A	Spectrum Analyzer
EIRP, e.i.r.p.	Equivalent Isotropically Radiated Power	SG	Signal Generator
EMC	ElectroMagnetic Compatibility	SVSWR	Site-Voltage Standing Wave Ratio
EMI	ElectroMagnetic Interference	TR	Test Receiver
EN	European Norm	Tx	Transmitting
ERP, e.r.p.	Effective Radiated Power	VBW	Video BandWidth
EU	European Union	Vert.	Vertical
EUT	Equipment Under Test	WLAN	Wireless LAN
Fac.	Factor		
FCC	Federal Communications Commission		
FHSS	Frequency Hopping Spread Spectrum		
FM	Frequency Modulation		
Freq.	Frequency		
FSK	Frequency Shift Keying		
GFSK	Gaussian Frequency-Shift Keying		
GNSS	Global Navigation Satellite System		
GPS	Global Positioning System		
Hori.	Horizontal		
ICES	Interference-Causing Equipment Standard		
IEC	International Electrotechnical Commission		
IEEE	Institute of Electrical and Electronics Engineers		
IF	Intermediate Frequency		
ILAC	International Laboratory Accreditation Conference		
ISED	Innovation, Science and Economic Development Canada		
ISO	International Organization for Standardization		
JAB	Japan Accreditation Board		
LAN	Local Area Network		
LIMS	Laboratory Information Management System		

UL Japan, Inc.

Kashima EMC Lab.

1614, Mushiata, Katori-shi, Chiba-ken, 289-0341 Japan

Telephone : +81 478 88 6500

Facsimile : +81 478 82 3373

CONTENTS	PAGE
SECTION 1: Customer information.....	5
SECTION 2: Equipment under test (E.U.T.).....	5
SECTION 3: Test specification, procedures & results.....	7
SECTION 4: Operation of E.U.T. during testing.....	10
SECTION 5: Radiated Spurious Emission	13
APPENDIX 1: Test data	15
Radiated Spurious Emission	16
APPENDIX 2: Test instruments	37
APPENDIX 3: Photographs of test setup	38
Radiated Spurious Emission	38
Worst Case Position	42

SECTION 1: Customer information

Company Name : PIONEER CORPORATION
Address : 25-1, Yamada, Kawagoe-shi, Saitama, 350-8555, Japan
Telephone Number : +81-49-228-7681
Facsimile Number : +81-49-228-6172
Contact Person : Shigeru Yoshida

The information provided from the customer is as follows;

- Applicant, Type of Equipment, Model No., FCC ID on the cover and other relevant pages
- Operating/Test Mode(s) (Mode(s)) on all the relevant pages
- SECTION 1: Customer information
- SECTION 2: Equipment under test (E.U.T.)
- SECTION 4: Operation of E.U.T. during testing

* The laboratory is exempted from liability of any test results affected from the above information in SECTION 2 and 4.

SECTION 2: Equipment under test (E.U.T.)

2.1 Identification of E.U.T.

Type of Equipment : RDS AV RECEIVER
Model No. : DMH-WC6600NEX
Serial No. : Refer to SECTION 4.2
Rating : DC 14.4 V (DC 10.8 V to 15.1 V)
Receipt Date of Sample : September 27, 2019
(Information from test lab.)
Country of Mass-production : Thailand
Condition of EUT : Production prototype
(Not for Sale: This sample is equivalent to mass-produced items.)
Modification of EUT : No Modification by the test lab.

2.2 Product Description

Model: DMH-WC6600NEX (referred to as the EUT in this report) is an RDS AV RECEIVER.

The clock frequencies used in the EUT

DC-DC CONVERTER : 1008 kHz/ 700.5 kHz, 365.8 kHz/ 413.9 kHz
FM/AM TUNER : 55.467 MHz (VCO: 5.9904 GHz/ 6.2208 GHz)
MAIN PROCESSER : 24 MHz
SYSTEM MICRO COMPUTER : 12.5 MHz
LCD BACK LIGHT : 515.7 kHz/ 476.6 kHz
LINE AMPLIFIER : 515.7 kHz/ 476.6 kHz
CHIPS : 26 MHz, 32.768 kHz, 10 MHz
HDMI RECEIVER : 27 MHz
VIDEO RECORDER : 32 MHz
WWR UNIT : 55.467 MHz

UL Japan, Inc.

Kashima EMC Lab.

1614, Mushihata, Katori-shi, Chiba-ken, 289-0341 Japan

Telephone : +81 478 88 6500

Facsimile : +81 478 82 3373

Radio Specification

Equipment Radio Type : RF Receiver& RF Transmitter
Antenna Type : Monopole Type PCB Antenna
Operating Temperature Range : -10 degree C to +60 degree C

Items	Bluetooth (Version 4.2)	WLAN (IEEE802.11.b/g/n)	WLAN (IEEE802.11.a/n/ac)	GNSS
Frequency of Operation	2402 MHz-2480 MHz	2412 MHz-2462 MHz	5745 MHz (IEEE 802.11a/n-20) 5755 MHz (IEEE 802.11n-40/ac-40) 5775 MHz (IEEE 802.11ac-80)	GPS:1575.42 MHz GLONASS:1598.025 MHz-1605.375 MHz Galileo:1575.42 MHz
Antenna Gain	-14.5 dBi	-11.2 dBi	-13.2 dBi	2.0 dBi (Elevation Angle:90°) -6.0 dBi (Elevation Angle:10°)
Type of Modulation	GFSK, $\pi/4$ - DQPSK, 8DPSK	DSSS	(a, n): OFDM / BPSK, QPSK,16QAM, 64QAM (ac): OFDM / BPSK, QPSK, 16QAM, 64QAM, 256QAM	CDMA/FDMA/CDMA
Emission Designation (ITU Code)	(BDR): F1D, (EDR): G1D, (LE): F1D,	(IEEE802.11.b): G1D (IEEE802.11.g/n): D1D	D1D	-
Bandwidth	1 MHz	20 MHz	(a, n):20 MHz, (n):20 MHz,40 MHz, (ac):40 MHz,80 MHz	GPS:+-1.023 MHz GLONASS:+-0.511 MHz Galileo:+-12.276 MHz
Channel Spacing	BDR, EDR: 1 MHz, LE:2 MHz	5 MHz	20 MHz	GPS:- GLONASS:0.5625 MHz Galileo:-

SECTION 3: Test specification, procedures & results

3.1 Test Specification

Test Specification : FCC Part 15 Subpart C
FCC Part 15 final revised on July 19, 2019 and effective August 19, 2019 except 15.258

Title : FCC 47 CFR Part 15 Radio Frequency Device Subpart C Intentional Radiators
Section 15.207 Conducted limits
Section 15.247 Operation within the bands 902-928 MHz, 2400-2483.5 MHz,
and 5725-5850 MHz

*The customer has declared that the EUT has complies with FCC Part 15 Subpart B as SDoC.

3.2 Procedures and results

Item	Test Procedure	Specification	Worst margin	Results	Remarks
Conducted Emission	FCC: ANSI C63.10-2013 6. Standard test methods ISED: RSS-Gen 8.8	FCC: Section 15.207 ISED: RSS-Gen 8.8	-	N/A	- *1)
6dB Bandwidth	FCC: KDB 558074 D01 15.247 Meas Guidance v05r02 ISED: -	FCC: Section 15.247(a)(2) ISED: RSS-247 5.2(a)	-	N/A	Conducted *2)
Maximum Peak Output Power	FCC: KDB 558074 D01 15.247 Meas Guidance v05r02 ISED: RSS-Gen 6.12	FCC: Section 15.247(b)(3) ISED: RSS-247 5.4(d)	-	N/A	Conducted *2)
Power Density	FCC: KDB 558074 D01 15.247 Meas Guidance v05r02 ISED: -	FCC: Section 15.247(e) ISED: RSS-247 5.2(b)	-	N/A	Conducted *2)
Spurious Emission Restricted Band Edges	FCC: KDB 558074 D01 15.247 Meas Guidance v05r02 ISED: RSS-Gen 6.13	FCC: Section 15.247(d) ISED: RSS-247 5.5 RSS-Gen 8.9 RSS-Gen 8.10	2.2 dB 2390.000 MHz, AV, Hori.	Complied# a)	Conducted (below 30 MHz) *2) Radiated (above 30 MHz) *3)

Note: UL Japan, Inc.'s EMI Work Procedures No. 13-EM-W0420 and 13-EM-W0422.

*1) The test is not applicable since the EUT does not have AC power ports.

*2) For other than the Radiated spurious emission test, refer to test report No.13063555S-A-R2.

*3) Radiated test was selected over 30 MHz based on section 15.247(d) and KDB 558074 D01 15.247 Meas Guidance v05r02 8.5 and 8.6.

a) Refer to APPENDIX 1 (data of Radiated Spurious Emission)

Symbols:

Complied The data of this test item has enough margin, more than the measurement uncertainty.

Complied# The data of this test item meets the limits unless the measurement uncertainty is taken into consideration.

* In case any questions arise about test procedure, ANSI C63.10: 2013 is also referred.

FCC Part 15.31 (e)

The EUT provides stable voltage constantly to the wireless transmitter regardless of input voltage.

Instead of a new battery, DC power supply was used for the test. That does not affect the test result, therefore the EUT complies with the requirement.

FCC Part 15.203 Antenna requirement

It is impossible for end users to replace the antenna, because the antenna is mounted inside of the EUT. Therefore, the equipment complies with the antenna requirement of Section 15.203.

UL Japan, Inc.

Kashima EMC Lab.

1614, Mushiata, Katori-shi, Chiba-ken, 289-0341 Japan

Telephone : +81 478 88 6500

Facsimile : +81 478 82 3373

3.3 Addition to standard

No addition, exclusion nor deviation has been made from the standard.

3.4 Uncertainty

There is no applicable rule of uncertainty in this applied standard. Therefore, the results are derived depending on whether or not laboratory uncertainty is applied.

The following uncertainties have been calculated to provide a confidence level of 95 % using a coverage factor $k=2$.

Conducted emission

Frequency range	Required Uncertainty (+/-)	Uncertainty (+/-)
0.15 MHz to 30 MHz	3.4 dB	3.3 dB

Radiated emission

Measurement distance	Frequency range	Required Uncertainty (+/-)	Uncertainty (+/-)
3 m	9 kHz to 30 MHz	Not Defined	2.9 dB
	30 MHz to 200 MHz	6.3 dB	6.1 dB
	200 MHz to 1000 MHz		6.2 dB
	1 GHz to 6 GHz	5.2 dB	5.0 dB
	6 GHz to 18 GHz	5.5 dB	5.4 dB
	18 GHz to 40 GHz	Not Defined	5.5 dB
1 m	1 GHz to 18 GHz	Not Defined	5.4 dB
	18 GHz to 40 GHz		5.6 dB

Antenna Terminal test

Test Item	Required Uncertainty (+/-)	Uncertainty (+/-)
6 dB Bandwidth / 99 % Occupied Bandwidth	Not Defined	1.6 %
Maximum Output Power	0.75 dB	0.73 dB
Burst Rate	Not Defined	0.256 %
Power Density	4 dB	2.2 dB
Conducted Spurious Emission (9 kHz to 30 MHz)	4 dB	2.2 dB

3.5 Test Location

UL Japan, Inc. Kashima EMC Lab.
1614 Mushihata, Katori-shi, Chiba-ken, 289-0341 JAPAN
Telephone: +81 478 88 6500, Facsimile: +81 478 82 3373

JAB Accreditation No.:RTL02610 / FCC Test Firm Registration Number: 910230 / ISED Lab Company Number: 4659A

Test site	Width x Depth x Height (m)	Size of reference ground plane (m) / horizontal conducting plane	Maximum measurement distance
No.1 Open site	6.0 x 5.5 x 2.5	20 x 40	10 m
No.5 Open site	8.6 x 7.1 x 2.4	18 x 23	10 m
No.1 Shielded room	5.4 x 4.5 x 2.3	-	-
No.5 Shielded Room	4.2 x 3.1 x 2.5	-	-
No.6 Semi-anechoic Chamber	8.5 x 5.5 x 5.2	-	3 m
No.10 Semi-anechoic Chamber	18.4 x 9.9 x 7.7	-	10 m
No.11 Semi-anechoic Chamber	9.0 x 6.5 x 5.2	-	3 m
No.1 Measurement room	5.0 x 3.7 x 2.6	-	-
No.2 Measurement room	4.3 x 4.4 x 2.7	-	-
No.3 Measurement room	4.5 x 5.3 x 2.7	-	-

3.6 Test data, Test instruments, and Test set up

Refer to APPENDIX.

SECTION 4: Operation of E.U.T. during testing

4.1 Operating Mode(s)

Test operating mode was determined as follows according to “Section 1 of 6 802.11 a/b/g/n testing - Managing Complex Regulatory Approvals - ” of TCB Council Workshop October 2009.

Mode	Remarks*
IEEE 802.11b (11b)	11 Mbps, PN9
IEEE 802.11g (11g)	48 Mbps, PN9
IEEE 802.11n 20 MHz BW (11n-20)	MCS 5 (SGI OFF), PN9
Tx (Transmitting), Bluetooth Low Energy (BT LE)	Maximum Packet Size, PRBS9
*The worst condition was determined based on the test result of Maximum Peak Output Power (Mid Channel)	
*Power of the EUT was set by the software as follows; Power settings : 11b: 14 dBm 11g: 12 dBm 11n-20: 11 dBm BT LE: Fixed Software : SoC: 0.0601400 SYS: 7.13 *This setting of software is the worst case. Any conditions under the normal use do not exceed the condition of setting. In addition, end users cannot change the settings of the output power of the product.	

*The details of Operating mode(s)

Test Item	Operating Mode	Tested frequency
Radiated Spurious Emission	Tx 11b	2412 MHz
	Tx 11g	2437 MHz
	Tx 11n-20	2462 MHz
	Tx BT LE	2402 MHz
		2440 MHz
		2480 MHz

UL Japan, Inc.

Kashima EMC Lab.

1614, Mushihata, Katori-shi, Chiba-ken, 289-0341 Japan

Telephone : +81 478 88 6500

Facsimile : +81 478 82 3373

4.2 Configuration and peripherals

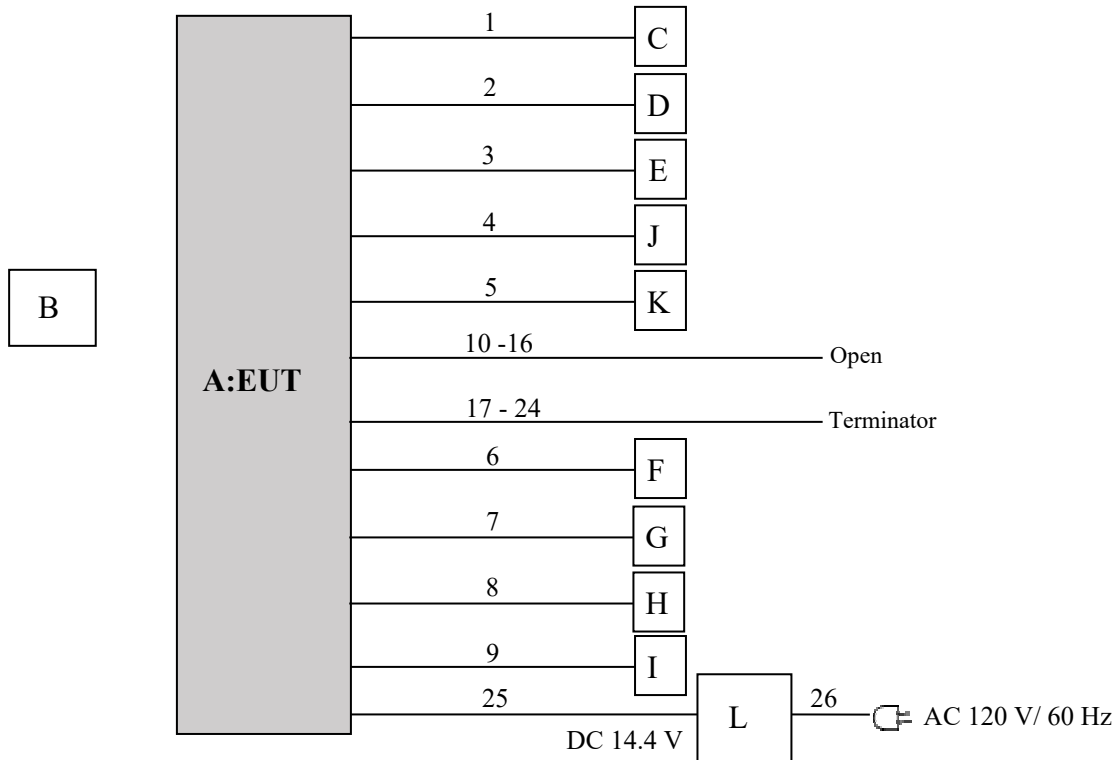

* Cabling and setup(s) were taken into consideration and test data was taken under worse case conditions.

Description of EUT and Support equipment

No.	Item	Model number	Serial number	Manufacturer	Remark
A	RDS AV RECEIVER	DMH-WC6600NEX	SGTM000008UC	PIONEER CORPORATION	EUT
B	REMOTE CONTROLLER	CXE5116	-	PIONEER CORPORATION	-
C	GPS Antenna	GPA-MG248	-	mitsumi	-
D	USB Memory	-	-	TOSHIBA	-
E	Mic	-	-	-	-
F	Speaker	KFC-RS101	-	KENWOOD	-
G	Speaker	KFC-RS101	-	KENWOOD	-
H	Speaker	KFC-RS101	-	KENWOOD	-
I	Speaker	KFC-RS101	-	KENWOOD	-
J	Smart phone	SO-01C	-	Sony Ericsson	-
K	Vehicle Tuner	SXV200	45V80ACL	SiriusXM	-
L	DC Power Supply	GSV3000	1708192899	DIAMOND ANTENNA	-

UL Japan, Inc.

Kashima EMC Lab.

1614, Mushihata, Katori-shi, Chiba-ken, 289-0341 Japan

Telephone : +81 478 88 6500

Facsimile : +81 478 82 3373

List of cables used

No.	Name	Length (m)	Shield		Remarks
			Cable	Connector	
1	GPS Antenna	3.5	Shielded	Shielded	-
2	USB	1.5	Shielded	Shielded	Type C
3	Mic	3.0	Unshielded	Unshielded	-
4	HDMI	0.7 + 2.0	Shielded	Shielded	-
5	Vehicle Tuner	0.65	Shielded	Shielded	-
6	Speaker	0.1 + 0.8	Unshielded	Unshielded	-
7	Speaker	0.1 + 0.8	Unshielded	Unshielded	-
8	Speaker	0.1 + 0.8	Unshielded	Unshielded	-
9	Speaker	0.1 + 0.8	Unshielded	Unshielded	-
10	MUTE	0.15 + 1.15	Unshielded	Unshielded	-
11	Steering Wheel Control	1.0	Unshielded	Unshielded	-
12	REVERSE-GERA SIGNAL INPUT	0.1 + 1.0	Unshielded	Unshielded	-
13	SYSTEM REMOTE CONTROL	0.15 + 1.0	Unshielded	Unshielded	-
14	PARKING BRAKE	2.0	Unshielded	Unshielded	-
15	CARSPEED SIGNAL INPUT	0.1 + 1.0	Unshielded	Unshielded	-
16	iDATA	1.6	Unshielded	Unshielded	-
17	FM Antenna	0.2	Unshielded	Unshielded	-
18	AUX IN	0.15 + 2.0	Unshielded	Unshielded	-
19	Front OUTPUT	0.1 + 1.0	Unshielded	Unshielded	-
20	Rear OUTPUT	0.1 + 1.0	Unshielded	Unshielded	-
21	SUBWOOFER OUTPUT	0.2 + 1.5	Unshielded	Unshielded	-
22	REAR MONITOR OUTPUT	0.2 + 1.5	Unshielded	Unshielded	-
23	SECOND CAMERA INPUT	0.2 + 1.5	Unshielded	Unshielded	-
24	REAR VIEW CAMERA IN	0.2 + 1.5	Unshielded	Unshielded	-
25	DC	0.4 + 1.6	Unshielded	Unshielded	-
26	AC	1.7	Unshielded	Unshielded	-

UL Japan, Inc.

Kashima EMC Lab.

1614, Mushihata, Katori-shi, Chiba-ken, 289-0341 Japan

Telephone : +81 478 88 6500

Facsimile : +81 478 82 3373

SECTION 5: Radiated Spurious Emission

Test Procedure

It was measured based on "8.5 and 8.6 of KDB 558074 D01 15.247 Meas Guidance v05r02".

[For below 1 GHz]

EUT was placed on a urethane platform of nominal size, 1.0 m by 1.5 m, raised 0.8 m above the conducting ground plane. The Radiated Electric Field Strength has been measured in a Semi Anechoic Chamber with a ground plane.

[For above 1 GHz]

EUT was placed on a urethane platform of nominal size, 0.5 m by 0.5 m, raised 1.5 m above the conducting ground plane.

The Radiated Electric Field Strength has been measured in a Semi Anechoic Chamber with absorbent materials lined on a ground plane.

The height of the measuring antenna varied between 1 m and 4 m and EUT was rotated a full revolution in order to obtain the maximum value of the electric field strength.

Test antenna was aimed at the EUT for receiving the maximum signal and always kept within the illumination area of the 3 dB beamwidth of the antenna.

The measurements were performed for both vertical and horizontal antenna polarization with the Test Receiver, or the Spectrum Analyzer.

The measurements were made with the following detector function of the test receiver and the Spectrum analyzer (in linear mode).

The test was made with the detector (RBW/VBW) in the following table.

When using Spectrum analyzer, the test was made with adjusting span to zero by using peak hold.

Test Antennas are used as below;

Frequency	Below 1 GHz	Above 1 GHz
Antenna Type	Hybrid	Horn

In any 100 kHz bandwidth outside the restricted band in which the spread spectrum intentional radiator is operating, the radio frequency power that is produced by the intentional radiator confirmed 20 dB below that in the 100 kHz bandwidth within the band that contains the highest level of the desired power, based on a radiated measurement.

20 dBc was applied to the frequency over the limit of FCC 15.209 / Table 4 of RSS-Gen 8.9(ISED) and outside the restricted band of FCC15.205 / Table 6 of RSS-Gen 8.10 (ISED).

Frequency	Below 1 GHz	Above 1 GHz		20 dBc
Instrument used	Test Receiver	Spectrum Analyzer		Spectrum Analyzer
Detector	QP	PK	AV *1)	PK
IF Bandwidth	BW 120 kHz	RBW: 1 MHz VBW: 3 MHz	11.12.2.5.1 RBW: 1 MHz VBW: 3 MHz Detector: Power Averaging (RMS) Trace: 100 traces 11.12.2.5.2 The duty cycle was less than 98% for detected noise, a duty factor was added to the 11.12.2.5.1 results.	RBW: 100 kHz VBW: 300 kHz

*1) Average Power Measurement was performed based on ANSI C63.10-2013.

UL Japan, Inc.

Kashima EMC Lab.

1614, Mushihata, Katori-shi, Chiba-ken, 289-0341 Japan

Telephone : +81 478 88 6500

Facsimile : +81 478 82 3373

Figure 2: Test Setup

Below 1 GHz

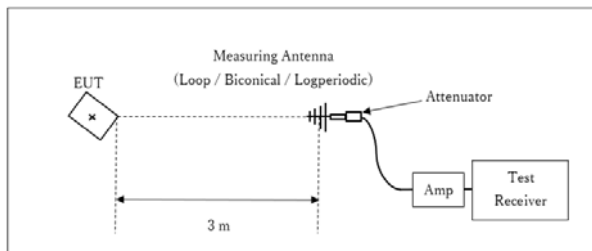

× : Center of turn table

Test Distance: 3 m

1 GHz - 10 GHz

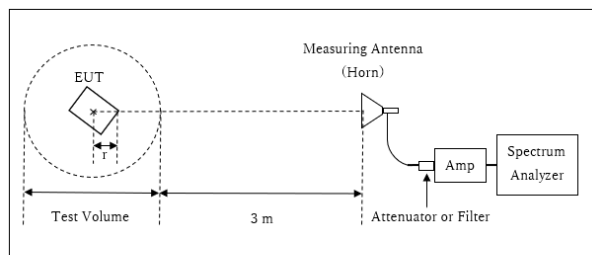

r : Radius of an outer periphery of EUT
× : Center of turn table

No.10 Semi-Anechoic Chamber

Distance Factor: $20 \times \log(4.4 \text{ m} / 3.0 \text{ m}) = 3.33 \text{ dB}$

* Test Distance: $(3 + \text{Test Volume} / 2) - r = 4.4 \text{ m}$

Test Volume : 3.0 m

(Test Volume has been calibrated based on CISPR 16-1-4.)

r = 0.1 m

No.11 Semi-Anechoic Chamber

Distance Factor: $20 \times \log(3.9 \text{ m} / 3.0 \text{ m}) = 2.28 \text{ dB}$

* Test Distance: $(3 + \text{Test Volume} / 2) - r = 3.9 \text{ m}$

Test Volume : 2.0 m

(Test Volume has been calibrated based on CISPR 16-1-4.)

r = 0.1 m

10 GHz - 26.5 GHz

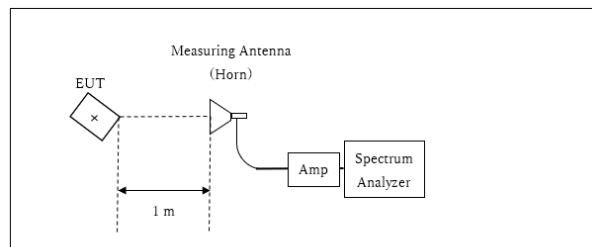

× : Center of turn table

Distance Factor: $20 \times \log(1.0 \text{ m} / 3.0 \text{ m}) = -9.54 \text{ dB}$

*Test Distance: 1 m

- The carrier level and noise levels were confirmed at angle of 0 deg. to 30 deg. based on the product specification to see the position of maximum noise, and the test was made at the position that has the maximum noise. The test results and limit are rounded off to one decimal place, so some differences might be observed.

The test results and limit are rounded off to one decimal place, so some differences might be observed.

Measurement range : 30 MHz - 26.5 GHz
Test data : APPENDIX
Test result : Pass

UL Japan, Inc.

Kashima EMC Lab.

1614, Mushihata, Katori-shi, Chiba-ken, 289-0341 Japan

Telephone : +81 478 88 6500

Facsimile : +81 478 82 3373

APPENDIX 1: Test data

Burst rate confirmation

Report No.	13063556M-B-R2	
Test place	Shonan EMC Lab.	
	No.5 Shielded Room	No.1 Measurement Room
Date	September 27, 2019	October 16, 2019
Temperature / Humidity	26 deg. C / 45 % RH	25 deg. C / 47 % RH
Engineer	Makoto Hosaka	Hiromasa Sato
Mode	Tx	

Worst Rate

11b 11 Mbps

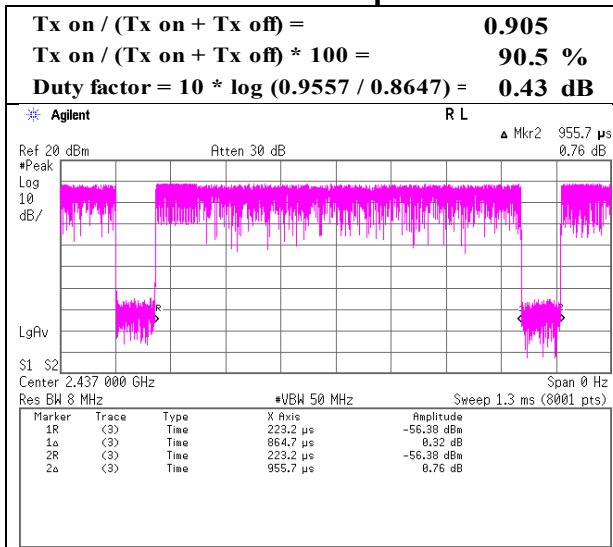

11g 48 Mbps

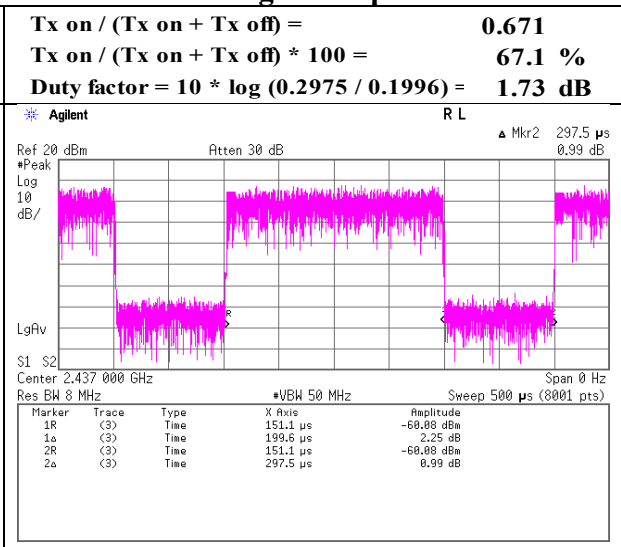

11n-20 MCS 5 (SGI:OFF)

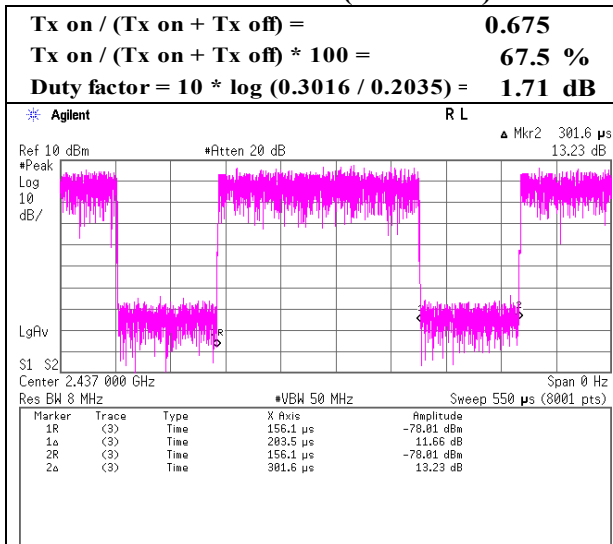

BT LE

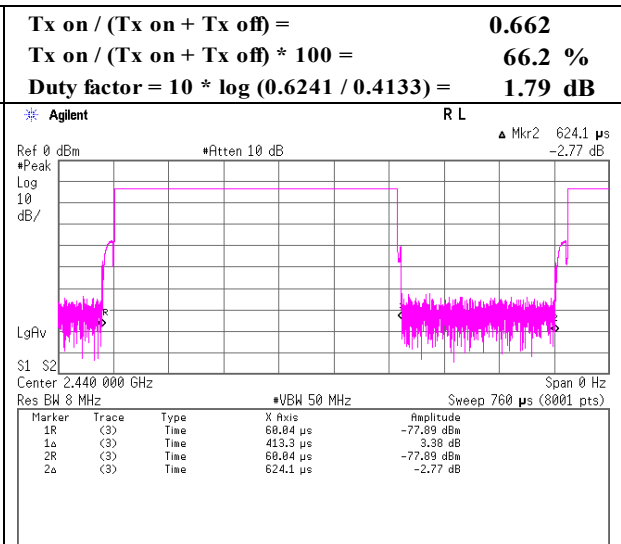

* Since the burst rate is not different between the channels, the data has been obtained on the representative channel.

Radiated Spurious Emission

Report No.	13063556M-B-R2			
Test place	Kashima EMC Lab.			
Semi Anechoic Chamber	No.11	No.10	No.11	No.11
Date	October 21, 2019	October 23, 2019	October 19, 2019	October 18, 2019
Temperature / Humidity	22 deg. C / 55 % RH	20 deg. C / 53 % RH	20 deg. C / 58 % RH	22 deg. C / 52 % RH
Engineer	Hiromitsu Tanabe	Hiromitsu Tanabe	Hiromitsu Tanabe	Hiromitsu Tanabe
	(1 GHz - 2.8 GHz)	(2.8 GHz - 10 GHz)	(10 GHz - 18 GHz)	(18 GHz - 26.5 GHz)
Mode	Tx 11b 2412 MHz			

(* PK: Peak, AV: Average, QP: Quasi-Peak)

Polarity	Frequency [MHz]	Detector	Reading [dBuV]	Ant.Fac. [dB/m]	Loss [dB]	Gain [dB]	Distance Factor [dB]	Result [dBuV/m]	Limit [dBuV/m]	Margin [dB]	Height [cm]	Angle [deg]	Remark
Hori.	2390.000	PK	56.20	27.60	13.65	43.90	2.28	55.83	73.90	18.0	153	148	
Hori.	2798.990	PK	50.00	28.81	13.95	43.82	2.28	51.22	73.90	22.6	203	179	
Hori.	4824.000	PK	51.00	32.67	5.72	45.22	3.33	47.50	73.90	26.4	125	140	
Hori.	7236.000	PK	49.10	37.27	7.02	44.01	3.33	52.71	73.90	21.1	100	0	Floor noise
Hori.	9648.000	PK	48.00	38.14	7.82	41.86	3.33	55.43	73.90	18.4	100	0	Floor noise
Hori.	2798.990	AV	42.20	28.81	13.95	43.82	2.28	43.42	53.90	10.4	203	179	
Vert.	2390.000	PK	53.00	27.60	13.65	43.90	2.28	52.63	73.90	21.2	144	211	
Vert.	2798.990	PK	51.70	28.81	13.95	43.82	2.28	52.92	73.90	20.9	151	187	
Vert.	4824.000	PK	52.30	32.67	5.72	45.22	3.33	48.80	73.90	25.1	165	155	
Vert.	7236.000	PK	48.70	37.27	7.02	44.01	3.33	52.31	73.90	21.5	100	0	Floor noise
Vert.	9648.000	PK	48.10	38.14	7.82	41.86	3.33	55.53	73.90	18.3	100	0	Floor noise
Vert.	2798.990	AV	45.80	28.81	13.95	43.82	2.28	47.02	53.90	6.8	151	187	

Result = Reading + Ant.Fac. + Loss (Cable+(Attenuator or Filter)(below 18 GHz)) - Gain(Amplifier) + Distance factor
Distance factor : 1 GHz - 10 GHz : 20log(3.9 m / 3.0 m) = 2.28 dB or 20log(4.4 m / 3.0 m) = 3.33 dB
10 GHz - 40 GHz : 20log(1.0 m / 3.0 m) = -9.54 dB

Average measurement value with duty factor

Polarity	Frequency [MHz]	Detector	Reading [dBuV]	Ant.Fac. [dB/m]	Loss [dB]	Gain [dB]	Duty Factor [dB]	Distance Factor [dB]	Result [dBuV/m]	Limit [dBuV/m]	Margin [dB]	Remark
Hori.	2390.000	AV	50.10	27.60	13.65	43.90	0.43	2.28	50.16	53.90	3.7	*1)
Hori.	4824.000	AV	41.90	32.67	5.72	45.22	0.43	3.33	38.83	53.90	15.0	
Hori.	7236.000	AV	39.70	37.27	7.02	44.01	0.43	3.33	43.74	53.90	10.1	Floor noise
Hori.	9648.000	AV	38.60	38.14	7.82	41.86	0.43	3.33	46.46	53.90	7.4	Floor noise
Vert.	2390.000	AV	46.00	27.60	13.65	43.90	0.43	2.28	46.06	53.90	7.8	*1)
Vert.	4824.000	AV	42.10	32.67	5.72	45.22	0.43	3.33	39.03	53.90	14.8	
Vert.	7236.000	AV	39.70	37.27	7.02	44.01	0.43	3.33	43.74	53.90	10.1	Floor noise
Vert.	9648.000	AV	38.60	38.14	7.82	41.86	0.43	3.33	46.46	53.90	7.4	Floor noise

Result = Reading + Ant.Fac. + Loss (Cable+(Attenuator or Filter)(below 18 GHz)) - Gain(Amplifier) + Duty factor + Distance factor
Distance factor : 1 GHz - 10 GHz : 20log(3.9 m / 3.0 m) = 2.28 dB or 20log(4.4 m / 3.0 m) = 3.33 dB
10 GHz - 40 GHz : 20log(1.0 m / 3.0 m) = -9.54 dB

Duty factor refer to "Duty factor Calculation chart" sheet.

*1) Not out of band emission (Leakage Power)

20 dBc Data Sheet (RBW 100 kHz, VBW 300 kHz)

Polarity	Frequency [MHz]	Detector	Reading [dBuV]	Ant.Fac. [dB/m]	Loss [dB]	Gain [dB]	Distance Factor [dB]	Result [dBuV/m]	Limit [dBuV/m]	Margin [dB]	Remark
Hori.	2412.000	PK	103.70	27.66	13.67	43.89	2.28	103.42	-	-	Carrier
Hori.	2400.000	PK	59.90	27.61	13.66	43.89	2.28	59.56	83.42	23.8	
Vert.	2412.000	PK	97.20	27.66	13.67	43.89	2.28	96.92	-	-	Carrier
Vert.	2400.000	PK	52.20	27.61	13.66	43.89	2.28	51.86	76.92	25.0	

Result = Reading + Ant.Fac. + Loss (Cable+(Attenuator or Filter)(below 18 GHz)) - Gain(Amplifier) + Distance factor
Distance factor : 1 GHz - 10 GHz : 20log(3.9 m / 3.0 m) = 2.28 dB
10 GHz - 40 GHz : 20log(1.0 m / 3.0 m) = -9.54 dB

UL Japan, Inc.

Kashima EMC Lab.

1614, Mushihata, Katori-shi, Chiba-ken, 289-0341 Japan

Telephone : +81 478 88 6500

Facsimile : +81 478 82 3373

Radiated Spurious Emission (Reference Plot for band-edge)

Report No.	13063556M-B-R2
Test place	Kashima EMC Lab.
Semi Anechoic Chamber	No.11
Date	October 21, 2019
Temperature / Humidity	22 deg. C / 55 % RH
Engineer	Hiromitsu Tanabe (1 GHz - 2.8 GHz)
Mode	Tx 11b 2412 MHz

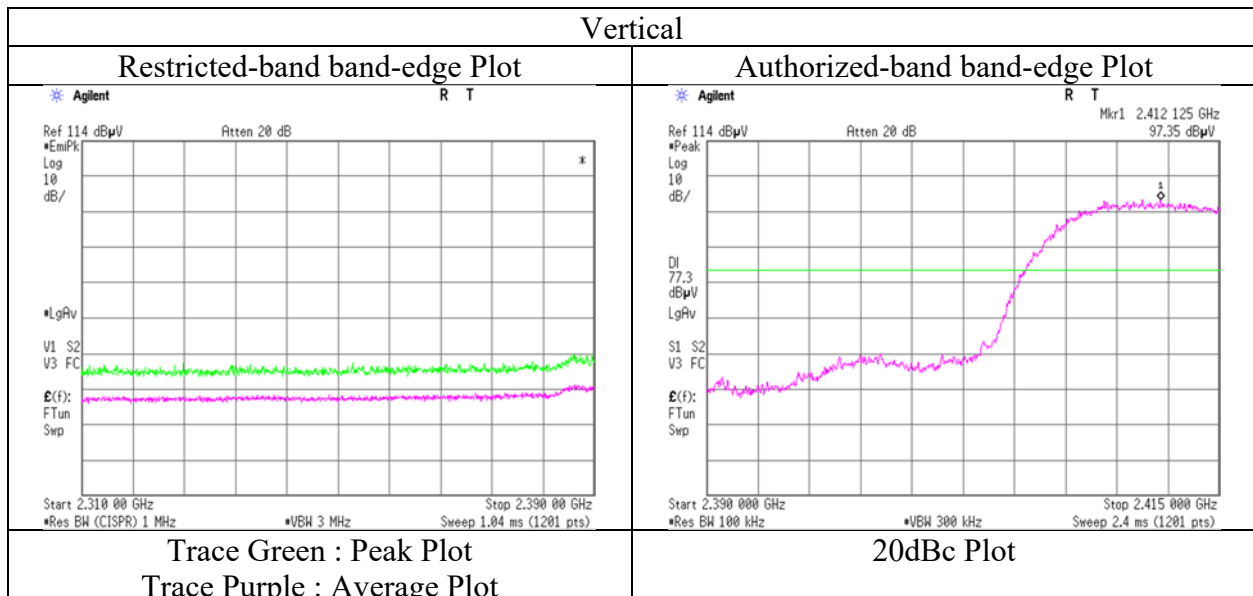
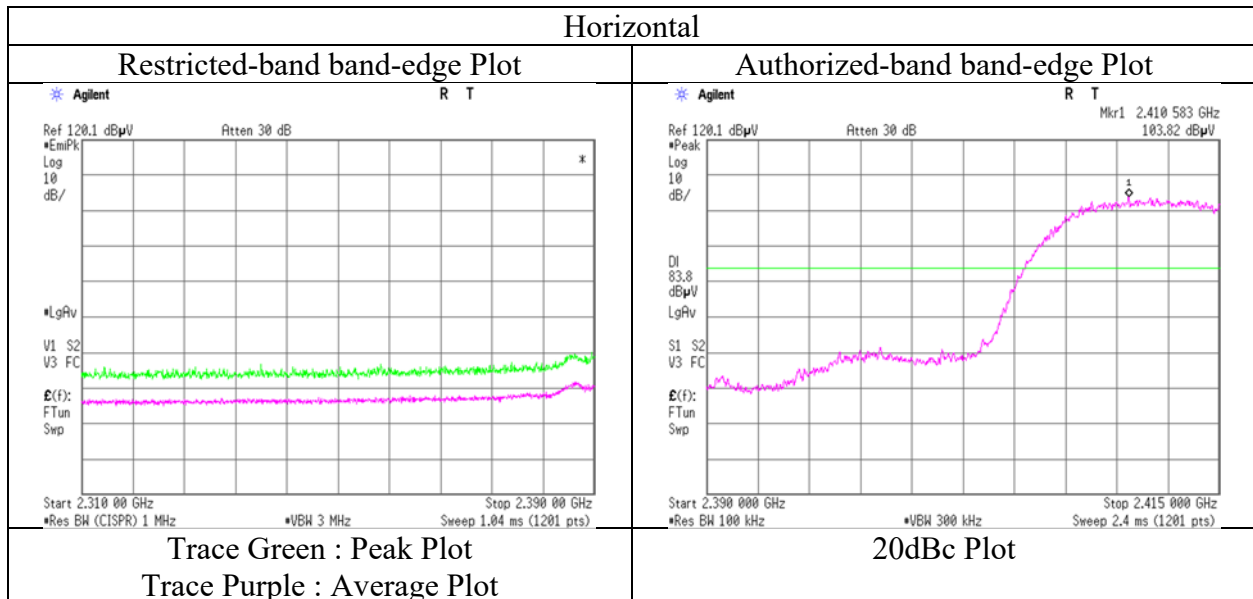

* The measurement was conducted for a sufficiently long enough time to detect any possible spurious emissions.

Final result of restricted band edge was shown in tabular data.

Radiated Spurious Emission

Report No.	13063556M-B-R2			
Test place	Kashima EMC Lab.			
Semi Anechoic Chamber	No.10	No.11	No.11	
Date	October 21, 2019	October 23, 2019	October 19, 2019	October 18, 2019
Temperature / Humidity	22 deg. C / 55 % RH	20 deg. C / 53 % RH	20 deg. C / 58 % RH	22 deg. C / 52 % RH
Engineer	Hiromitsu Tanabe	Hiromitsu Tanabe	Hiromitsu Tanabe	Hiromitsu Tanabe
	(1 GHz - 2.8 GHz)	(2.8 GHz - 10 GHz)	(10 GHz - 18 GHz)	(18 GHz - 26.5 GHz)
Mode	Tx 11b 2437 MHz			

(* PK: Peak, AV: Average, QP: Quasi-Peak)

Polarity	Frequency [MHz]	Detector	Reading [dBuV]	Ant.Fac. [dB/m]	Loss [dB]	Gain [dB]	Distance Factor [dB]	Result [dBuV/m]	Limit [dBuV/m]	Margin [dB]	Height [cm]	Angle [deg]	Remark
Hori.	2789.990	PK	50.30	28.81	13.94	43.82	2.28	51.51	73.90	22.3	283	179	
Hori.	4874.000	PK	50.90	32.68	5.75	45.24	3.33	47.42	73.90	26.4	135	145	
Hori.	7311.000	PK	48.80	37.39	7.05	43.84	3.33	52.73	73.90	21.1	100	0	Floor noise
Hori.	9748.000	PK	47.20	38.14	7.86	41.78	3.33	54.75	73.90	19.1	100	0	Floor noise
Hori.	2789.990	AV	42.60	28.81	13.94	43.82	2.28	43.81	53.90	10.0	283	179	
Vert.	2789.990	PK	52.90	28.81	13.94	43.82	2.28	54.11	73.90	19.7	143	187	
Vert.	4874.000	PK	50.60	32.68	5.75	45.24	3.33	47.12	73.90	26.7	170	190	
Vert.	7311.000	PK	49.10	37.39	7.05	43.84	3.33	53.03	73.90	20.8	100	0	Floor noise
Vert.	9748.000	PK	47.80	38.14	7.86	41.78	3.33	55.35	73.90	18.5	100	0	Floor noise
Vert.	2789.990	AV	46.00	28.81	13.94	43.82	2.28	47.21	53.90	6.6	143	187	

Result = Reading + Ant.Fac. + Loss (Cable+(Attenuator or Filter)(below 18 GHz)) - Gain(Amplifier) + Distance factor

Distance factor : 1 GHz - 10 GHz : $20\log(3.9\text{ m} / 3.0\text{ m}) = 2.28\text{ dB}$ or $20\log(4.4\text{ m} / 3.0\text{ m}) = 3.33\text{ dB}$

10 GHz - 40 GHz : $20\log(1.0\text{ m} / 3.0\text{ m}) = -9.54\text{ dB}$

Average measurement value with duty factor

Polarity	Frequency [MHz]	Detector	Reading [dBuV]	Ant.Fac. [dB/m]	Loss [dB]	Gain [dB]	Duty Factor [dB]	Distance Factor [dB]	Result [dBuV/m]	Limit [dBuV/m]	Margin [dB]	Remark
Hori.	4874.000	AV	41.50	32.68	5.75	45.24	0.43	3.33	38.45	53.90	15.4	
Hori.	7311.000	AV	39.90	37.39	7.05	43.84	0.43	3.33	44.26	53.90	9.6	Floor noise
Hori.	9748.000	AV	37.90	38.14	7.86	41.78	0.43	3.33	45.88	53.90	8.0	Floor noise
Vert.	4874.000	AV	41.10	32.68	5.75	45.24	0.43	3.33	38.05	53.90	15.8	
Vert.	7311.000	AV	39.80	37.39	7.05	43.84	0.43	3.33	44.16	53.90	9.7	Floor noise
Vert.	9748.000	AV	38.40	38.14	7.86	41.78	0.43	3.33	46.38	53.90	7.5	Floor noise

Result = Reading + Ant.Fac. + Loss (Cable+(Attenuator or Filter)(below 18 GHz)) - Gain(Amplifier) + Duty factor + Distance factor

Distance factor : 1 GHz - 10 GHz : $20\log(3.9\text{ m} / 3.0\text{ m}) = 2.28\text{ dB}$ or $20\log(4.4\text{ m} / 3.0\text{ m}) = 3.33\text{ dB}$

10 GHz - 40 GHz : $20\log(1.0\text{ m} / 3.0\text{ m}) = -9.54\text{ dB}$

Duty factor refer to "Duty factor Calculation chart" sheet.

UL Japan, Inc.

Kashima EMC Lab.

1614, Mushihata, Katori-shi, Chiba-ken, 289-0341 Japan

Telephone : +81 478 88 6500

Facsimile : +81 478 82 3373

Radiated Spurious Emission

Report No.	13063556M-B-R2			
Test place	Kashima EMC Lab.			
Semi Anechoic Chamber	No.11	No.10	No.11	No.11
Date	October 21, 2019	October 23, 2019	October 19, 2019	October 18, 2019
Temperature / Humidity	22 deg. C / 55 % RH	20 deg. C / 53 % RH	20 deg. C / 58 % RH	22 deg. C / 52 % RH
Engineer	Hiromitsu Tanabe	Hiromitsu Tanabe	Hiromitsu Tanabe	Hiromitsu Tanabe
	(1 GHz - 2.8 GHz)	(2.8 GHz - 10 GHz)	(10 GHz - 18 GHz)	(18 GHz - 26.5 GHz)
Mode	Tx 11b 2462 MHz			

(* PK: Peak, AV: Average, QP: Quasi-Peak)

Polarity	Frequency [MHz]	Detector	Reading [dBuV]	Ant.Fac. [dB/m]	Loss [dB]	Gain [dB]	Distance Factor [dB]	Result [dBuV/m]	Limit [dBuV/m]	Margin [dB]	Height [cm]	Angle [deg]	Remark
Hori.	2483.500	PK	53.80	27.93	13.71	43.87	2.28	53.85	73.90	20.0	128	146	
Hori.	2798.990	PK	50.70	28.81	13.95	43.82	2.28	51.92	73.90	21.9	167	127	
Hori.	4924.000	PK	50.20	32.67	5.78	45.29	3.33	46.69	73.90	27.2	135	145	
Hori.	7386.000	PK	48.40	37.44	7.06	43.65	3.33	52.58	73.90	21.3	100	0	Floor noise
Hori.	9848.000	PK	47.20	38.20	7.89	41.76	3.33	54.86	73.90	19.0	100	0	Floor noise
Hori.	2798.990	AV	42.90	28.81	13.95	43.82	2.28	44.12	53.90	9.7	167	127	
Vert.	2483.500	PK	50.70	27.93	13.71	43.87	2.28	50.75	73.90	23.1	145	197	
Vert.	2798.990	PK	52.40	28.81	13.95	43.82	2.28	53.62	73.90	20.2	145	187	
Vert.	4924.000	PK	50.90	32.67	5.78	45.29	3.33	47.39	73.90	26.5	165	210	
Vert.	7386.000	PK	48.00	37.44	7.06	43.65	3.33	52.18	73.90	21.7	100	0	Floor noise
Vert.	9848.000	PK	47.40	38.20	7.89	41.76	3.33	55.06	73.90	18.8	100	0	Floor noise
Vert.	2798.990	AV	46.40	28.81	13.95	43.82	2.28	47.62	53.90	6.2	145	187	

Result = Reading + Ant.Fac. + Loss (Cable+(Attenuator or Filter)(below 18 GHz)) - Gain(Amplifier) + Distance factor
Distance factor : 1 GHz - 10 GHz : 20log(3.9 m / 3.0 m) = 2.28 dB or 20log(4.4 m / 3.0 m) = 3.33 dB
10 GHz - 40 GHz : 20log(1.0 m / 3.0 m) = -9.54 dB

Average measurement value with duty factor

Polarity	Frequency [MHz]	Detector	Reading [dBuV]	Ant.Fac. [dB/m]	Loss [dB]	Gain [dB]	Duty Factor [dB]	Distance Factor [dB]	Result [dBuV/m]	Limit [dBuV/m]	Margin [dB]	Remark
Hori.	2483.500	AV	47.63	27.93	13.71	43.87	0.43	2.28	48.11	53.90	5.7	*1)
Hori.	4924.000	AV	41.60	32.67	5.78	45.29	0.43	3.33	38.52	53.90	15.3	
Hori.	7386.000	AV	39.50	37.44	7.06	43.65	0.43	3.33	44.11	53.90	9.7	Floor noise
Hori.	9848.000	AV	37.90	38.20	7.89	41.76	0.43	3.33	45.99	53.90	7.9	Floor noise
Vert.	2483.500	AV	42.80	27.93	13.71	43.87	0.43	2.28	43.28	53.90	10.6	*1)
Vert.	4924.000	AV	41.50	32.67	5.78	45.29	0.43	3.33	38.42	53.90	15.4	
Vert.	7386.000	AV	39.50	37.44	7.06	43.65	0.43	3.33	44.11	53.90	9.7	Floor noise
Vert.	9848.000	AV	37.80	38.20	7.89	41.76	0.43	3.33	45.89	53.90	8.0	Floor noise

Result = Reading + Ant.Fac. + Loss (Cable+(Attenuator or Filter)(below 18 GHz)) - Gain(Amplifier) + Duty factor + Distance factor
Distance factor : 1 GHz - 10 GHz : 20log(3.9 m / 3.0 m) = 2.28 dB or 20log(4.4 m / 3.0 m) = 3.33 dB
10 GHz - 40 GHz : 20log(1.0 m / 3.0 m) = -9.54 dB

Duty factor refer to "Duty factor Calculation chart" sheet.

*1) Not out of band emission (Leakage Power)

UL Japan, Inc.

Kashima EMC Lab.

1614, Mushihata, Katori-shi, Chiba-ken, 289-0341 Japan

Telephone : +81 478 88 6500

Facsimile : +81 478 82 3373

Radiated Spurious Emission
(Reference Plot for band-edge)

Report No.	13063556M-B-R2
Test place	Kashima EMC Lab.
Semi Anechoic Chamber	No.11
Date	October 21, 2019
Temperature / Humidity	22 deg. C / 55 % RH
Engineer	Hiromitsu Tanabe (1 GHz - 2.8 GHz)
Mode	Tx 11b 2462 MHz

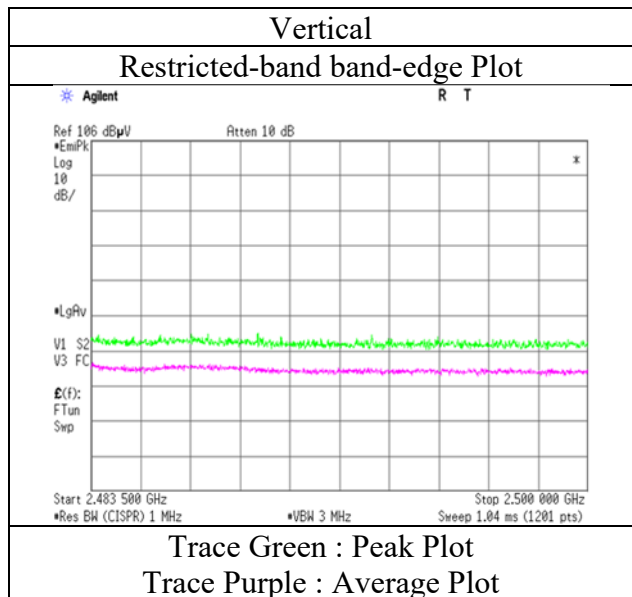
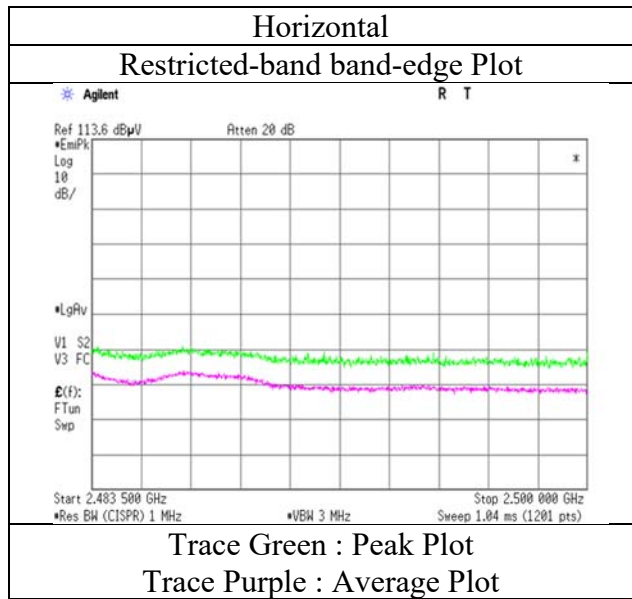

* The measurement was conducted for a sufficiently long enough time to detect any possible spurious emissions.
 Final result of restricted band edge was shown in tabular data.

Radiated Spurious Emission

Report No. 13063556M-B-R2
Test place Kashima EMC Lab.
Semi Anechoic Chamber No.11 No.10 No.10 No.11 No.11
Date October 21, 2019 October 29, 2019 October 23, 2019 October 19, 2019 October 18, 2019
Temperature / Humidity 22 deg. C / 55 % RH 23 deg. C / 52 % RH 20 deg. C / 53 % RH 20 deg. C / 58 % RH 22 deg. C / 52 % RH
Engineer Hiromitsu Tanabe Hiromitsu Tanabe Hiromitsu Tanabe Hiromitsu Tanabe Hiromitsu Tanabe
(1 GHz - 2.8 GHz) (1 GHz - 2.8 GHz) (2.8 GHz - 10 GHz) (10 GHz - 18 GHz) (18 GHz - 26.5 GHz)
Mode Tx 11g 2412 MHz

(* PK: Peak, AV: Average, QP: Quasi-Peak)

Polarity	Frequency [MHz]	Detector	Reading [dBuV]	Ant.Fac. [dB/m]	Loss [dB]	Gain [dB]	Distance Factor [dB]	Result [dBuV/m]	Limit [dBuV/m]	Margin [dB]	Height [cm]	Angle [deg]	Remark
Hori.	2390.000	PK	60.80	27.60	13.65	43.90	3.33	61.48	73.90	12.4	206	211	
Hori.	2798.990	PK	48.70	28.81	13.95	43.82	3.33	50.97	73.90	22.9	137	167	
Hori.	4824.000	PK	51.10	32.67	5.72	45.22	3.33	47.60	73.90	26.3	130	165	
Hori.	7236.000	PK	48.50	37.27	7.02	44.01	3.33	52.11	73.90	21.7	100	0	Floor noise
Hori.	9648.000	PK	47.50	38.14	7.82	41.86	3.33	54.93	73.90	18.9	100	0	Floor noise
Hori.	2798.990	AV	41.30	28.81	13.95	43.82	3.33	43.57	53.90	10.3	137	167	
Vert.	2390.000	PK	55.70	27.60	13.65	43.90	3.33	56.38	73.90	17.5	123	198	
Vert.	2798.990	PK	50.50	28.81	13.95	43.82	3.33	52.77	73.90	21.1	123	185	
Vert.	4824.000	PK	50.90	32.67	5.72	45.22	3.33	47.40	73.90	26.5	165	145	
Vert.	7236.000	PK	49.00	37.27	7.02	44.01	3.33	52.61	73.90	21.2	100	0	Floor noise
Vert.	9648.000	PK	47.30	38.14	7.82	41.86	3.33	54.73	73.90	19.1	100	0	Floor noise
Vert.	2798.990	AV	44.40	28.81	13.95	43.82	3.33	46.67	53.90	7.2	123	185	

Result = Reading + Ant.Fac. + Loss (Cable+(Attenuator or Filter)(below 18 GHz)) - Gain(Amplifier) + Distance factor

Distance factor : 1 GHz - 10 GHz : 20log(4.4 m / 3.0 m) = 3.33 dB

10 GHz - 40 GHz : 20log(1.0 m / 3.0 m) = -9.54 dB

Average measurement value with duty factor

Polarity	Frequency [MHz]	Detector	Reading [dBuV]	Ant.Fac. [dB/m]	Loss [dB]	Gain [dB]	Duty Factor [dB]	Distance Factor [dB]	Result [dBuV/m]	Limit [dBuV/m]	Margin [dB]	Remark
Hori.	2390.000	AV	49.20	27.60	13.65	43.90	1.73	3.33	51.61	53.90	2.2	*1)
Hori.	4824.000	AV	41.70	32.67	5.72	45.22	1.73	3.33	39.93	53.90	13.9	
Hori.	7236.000	AV	39.60	37.27	7.02	44.01	1.73	3.33	44.94	53.90	8.9	Floor noise
Hori.	9648.000	AV	38.60	38.14	7.82	41.86	1.73	3.33	47.76	53.90	6.1	Floor noise
Vert.	2390.000	AV	45.30	27.60	13.65	43.90	1.73	3.33	47.71	53.90	6.1	*1)
Vert.	4824.000	AV	41.80	32.67	5.72	45.22	1.73	3.33	40.03	53.90	13.8	
Vert.	7236.000	AV	39.60	37.27	7.02	44.01	1.73	3.33	44.94	53.90	8.9	Floor noise
Vert.	9648.000	AV	38.50	38.14	7.82	41.86	1.73	3.33	47.66	53.90	6.2	Floor noise

Result = Reading + Ant.Fac. + Loss (Cable+(Attenuator or Filter)(below 18 GHz)) - Gain(Amplifier) + Duty factor + Distance factor

Distance factor : 1 GHz - 10 GHz : 20log(4.4 m / 3.0 m) = 3.33 dB

10 GHz - 40 GHz : 20log(1.0 m / 3.0 m) = -9.54 dB

Duty factor refer to "Duty factor Calculation chart" sheet.

*1) Not out of band emission (Leakage Power)

20 dBc Data Sheet (RBW 100 kHz, VBW 300 kHz)

Polarity	Frequency [MHz]	Detector	Reading [dBuV]	Ant.Fac. [dB/m]	Loss [dB]	Gain [dB]	Distance Factor [dB]	Result [dBuV/m]	Limit [dBuV/m]	Margin [dB]	Remark
Hori.	2412.000	PK	98.70	27.66	13.67	43.89	2.28	98.42	-	-	Carrier
Hori.	2400.000	PK	71.30	27.61	13.66	43.89	2.28	70.96	78.42	7.4	
Vert.	2412.000	PK	92.22	27.66	13.67	43.89	2.28	91.94	-	-	Carrier
Vert.	2400.000	PK	51.30	27.61	13.66	43.89	2.28	50.96	71.94	20.9	

Result = Reading + Ant.Fac. + Loss (Cable+(Attenuator or Filter)(below 18 GHz)) - Gain(Amplifier) + Distance factor

Distance factor : 1 GHz - 10 GHz : 20log(3.9 m / 3.0 m) = 2.28 dB

10 GHz - 40 GHz : 20log(1.0 m / 3.0 m) = -9.54 dB

UL Japan, Inc.

Kashima EMC Lab.

1614, Mushihata, Katori-shi, Chiba-ken, 289-0341 Japan

Telephone : +81 478 88 6500

Facsimile : +81 478 82 3373

Radiated Spurious Emission
(Reference Plot for band-edge)

Report No. 13063556M-B-R2
Test place Kashima EMC Lab.
Semi Anechoic Chamber No.11
Date October 21, 2019
Temperature / Humidity 22 deg. C / 55 % RH
Engineer Hiromitsu Tanabe
(1 GHz - 2.8 GHz)
Mode Tx 11g 2412 MHz

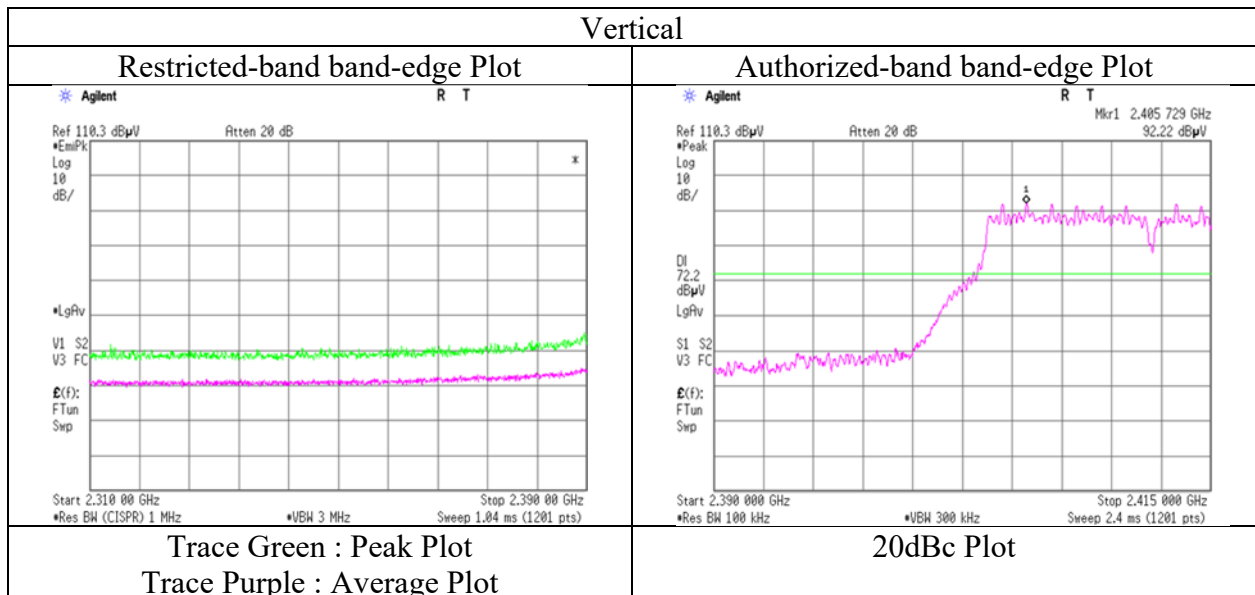
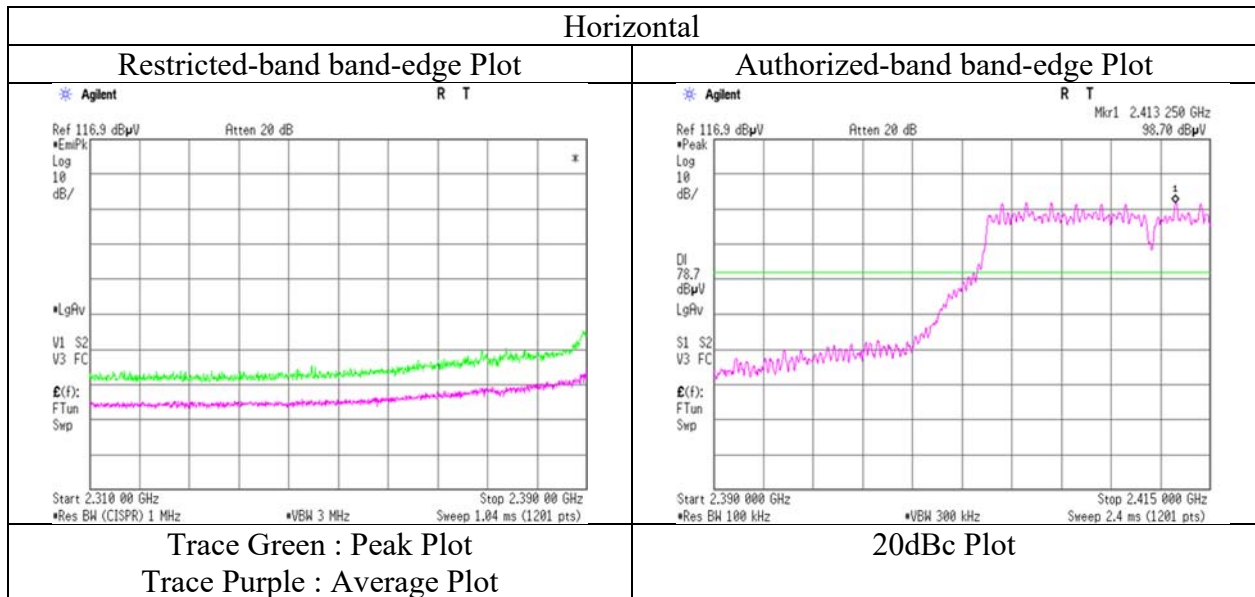

* The measurement was conducted for a sufficiently long enough time to detect any possible spurious emissions.

Final result of restricted band edge was shown in tabular data.

Radiated Spurious Emission

Report No.	13063556M-B-R2				
Test place	Kashima EMC Lab.				
Semi Anechoic Chamber	No.10	No.11	No.10	No.11	No.11
Date	October 17, 2019	October 21, 2019	October 23, 2019	October 19, 2019	October 18, 2019
Temperature / Humidity	23 deg. C / 55 % RH	22 deg. C / 55 % RH	20 deg. C / 53 % RH	20 deg. C / 58 % RH	22 deg. C / 52 % RH
Engineer	Hiromitsu Tanabe	Hiromitsu Tanabe	Hiromitsu Tanabe	Hiromitsu Tanabe	Hiromitsu Tanabe
	(30 MHz - 1000 MHz)	(1 GHz - 2.8 GHz)	(2.8 GHz - 10 GHz)	(10 GHz - 18 GHz)	(18 GHz - 26.5 GHz)
Mode	Tx 11g 2437 MHz				

(* PK: Peak, AV: Average, QP: Quasi-Peak)

Polarity	Frequency [MHz]	Detector	Reading [dBuV]	Ant.Fac. [dB/m]	Loss [dB]	Gain [dB]	Distance Factor [dB]	Result [dBuV/m]	Limit [dBuV/m]	Margin [dB]	Height [cm]	Angle [deg]	Remark
Hori.	229.204	QP	55.98	9.99	8.10	31.51	0.00	42.56	46.02	3.4	148	51	
Hori.	344.061	QP	45.30	14.24	9.03	31.48	0.00	37.09	46.02	8.9	100	211	
Hori.	417.789	QP	47.97	15.99	9.59	31.43	0.00	42.12	46.02	3.9	100	141	
Hori.	430.078	QP	44.13	16.52	9.68	31.43	0.00	38.90	46.02	7.1	100	28	
Hori.	2798.990	PK	51.30	28.81	13.95	43.82	2.28	52.52	73.90	21.3	229	129	
Hori.	4874.000	PK	50.90	32.68	5.75	45.24	3.33	47.42	73.90	26.4	140	150	
Hori.	7311.000	PK	49.00	37.39	7.05	43.84	3.33	52.93	73.90	20.9	100	0	Floor noise
Hori.	9748.000	PK	47.30	38.14	7.86	41.78	3.33	54.85	73.90	19.0	100	0	Floor noise
Hori.	2798.990	AV	43.30	28.81	13.95	43.82	2.28	44.52	53.90	9.3	229	129	
Vert.	52.907	QP	41.12	13.75	6.26	31.78	0.00	29.35	40.00	10.6	100	77	
Vert.	180.000	QP	44.78	11.97	7.67	31.56	0.00	32.86	43.52	10.6	100	114	
Vert.	229.285	QP	46.13	10.00	8.10	31.51	0.00	32.72	46.02	13.3	178	331	
Vert.	417.792	QP	42.53	15.99	9.59	31.43	0.00	36.68	46.02	9.3	149	171	
Vert.	2798.990	PK	52.10	28.81	13.95	43.82	2.28	53.32	73.90	20.5	217	189	
Vert.	4874.000	PK	50.70	32.68	5.75	45.24	3.33	47.22	73.90	26.6	175	160	
Vert.	7311.000	PK	48.90	37.39	7.05	43.84	3.33	52.83	73.90	21.0	100	0	Floor noise
Vert.	9748.000	PK	47.30	38.14	7.86	41.78	3.33	54.85	73.90	19.0	100	0	Floor noise
Vert.	2798.990	AV	46.30	28.81	13.95	43.82	2.28	47.52	53.90	6.3	217	189	

Result = Reading + Ant.Fac. + Loss (Cable+(Attenuator or Filter)(below 18 GHz)) - Gain(Amplifier) + Distance factor
Distance factor : 1 GHz - 10 GHz : 20log(3.9 m / 3.0 m) = 2.28 dB or 20log(4.4 m / 3.0 m) = 3.33 dB
10 GHz - 40 GHz : 20log(1.0 m / 3.0 m) = -9.54 dB

Average measurement value with duty factor

Polarity	Frequency [MHz]	Detector	Reading [dBuV]	Ant.Fac. [dB/m]	Loss [dB]	Gain [dB]	Duty Factor [dB]	Distance Factor [dB]	Result [dBuV/m]	Limit [dBuV/m]	Margin [dB]	Remark
Hori.	4874.000	AV	41.40	32.68	5.75	45.24	1.73	3.33	39.65	53.90	14.2	
Hori.	7311.000	AV	39.70	37.39	7.05	43.84	1.73	3.33	45.36	53.90	8.5	Floor noise
Hori.	9748.000	AV	37.90	38.14	7.86	41.78	1.73	3.33	47.18	53.90	6.7	Floor noise
Vert.	4874.000	AV	41.50	32.68	5.75	45.24	1.73	3.33	39.75	53.90	14.1	
Vert.	7311.000	AV	39.80	37.39	7.05	43.84	1.73	3.33	45.46	53.90	8.4	Floor noise
Vert.	9748.000	AV	38.10	38.14	7.86	41.78	1.73	3.33	47.38	53.90	6.5	Floor noise

Result = Reading + Ant.Fac. + Loss (Cable+(Attenuator or Filter)(below 18 GHz)) - Gain(Amplifier) + Duty factor + Distance factor
Distance factor : 1 GHz - 10 GHz : 20log(4.4 m / 3.0 m) = 3.33 dB
10 GHz - 40 GHz : 20log(1.0 m / 3.0 m) = -9.54 dB
Duty factor refer to "Duty factor Calculation chart" sheet.

Radiated Spurious Emission

Report No.	13063556M-B-R2			
Test place	Kashima EMC Lab.			
Semi Anechoic Chamber	No.10	No.11	No.11	
Date	October 21, 2019	October 23, 2019	October 19, 2019	October 18, 2019
Temperature / Humidity	22 deg. C / 55 % RH	20 deg. C / 53 % RH	20 deg. C / 58 % RH	22 deg. C / 52 % RH
Engineer	Hiromitsu Tanabe	Hiromitsu Tanabe	Hiromitsu Tanabe	Hiromitsu Tanabe
	(1 GHz - 2.8 GHz)	(2.8 GHz - 10 GHz)	(10 GHz - 18 GHz)	(18 GHz - 26.5 GHz)
Mode	Tx 11g 2462 MHz			

(* PK: Peak, AV: Average, QP: Quasi-Peak)

Polarity	Frequency [MHz]	Detector	Reading [dBuV]	Ant.Fac. [dB/m]	Loss [dB]	Gain [dB]	Distance Factor [dB]	Result [dBuV/m]	Limit [dBuV/m]	Margin [dB]	Height [cm]	Angle [deg]	Remark
Hori.	2483.500	PK	58.90	27.93	13.71	43.87	2.28	58.95	73.90	14.9	128	149	
Hori.	2798.990	PK	50.70	28.81	13.95	43.82	2.28	51.92	73.90	21.9	171	124	
Hori.	4924.000	PK	50.60	32.67	5.78	45.29	3.33	47.09	73.90	26.8	130	155	
Hori.	7386.000	PK	48.50	37.44	7.06	43.65	3.33	52.68	73.90	21.2	100	0	Floor noise
Hori.	9848.000	PK	47.50	38.20	7.89	41.76	3.33	55.16	73.90	18.7	100	0	Floor noise
Hori.	2798.990	AV	42.70	28.81	13.95	43.82	2.28	43.92	53.90	9.9	171	124	
Vert.	2483.500	PK	52.50	27.93	13.71	43.87	2.28	52.55	73.90	21.3	135	200	
Vert.	2798.990	PK	52.00	28.81	13.95	43.82	2.28	53.22	73.90	20.6	135	188	
Vert.	4924.000	PK	50.70	32.67	5.78	45.29	3.33	47.19	73.90	26.7	170	185	
Vert.	7386.000	PK	48.30	37.44	7.06	43.65	3.33	52.48	73.90	21.4	100	0	Floor noise
Vert.	9848.000	PK	47.70	38.20	7.89	41.76	3.33	55.36	73.90	18.5	100	0	Floor noise
Vert.	2798.990	AV	46.00	28.81	13.95	43.82	2.28	47.22	53.90	6.6	135	188	

Result = Reading + Ant.Fac. + Loss (Cable+(Attenuator or Filter)(below 18 GHz)) - Gain(Amplifier) + Distance factor
Distance factor : 1 GHz - 10 GHz : 20log(3.9 m / 3.0 m) = 2.28 dB or 20log(4.4 m / 3.0 m) = 3.33 dB
10 GHz - 40 GHz : 20log(1.0 m / 3.0 m) = -9.54 dB

Average measurement value with duty factor

Polarity	Frequency [MHz]	Detector	Reading [dBuV]	Ant.Fac. [dB/m]	Loss [dB]	Gain [dB]	Duty Factor [dB]	Distance Factor [dB]	Result [dBuV/m]	Limit [dBuV/m]	Margin [dB]	Remark
Hori.	2483.500	AV	47.30	27.93	13.71	43.87	1.73	2.28	49.08	53.90	4.8	*1)
Hori.	4924.000	AV	41.50	32.67	5.78	45.29	1.73	3.33	39.72	53.90	14.1	
Hori.	7386.000	AV	39.60	37.44	7.06	43.65	1.73	3.33	45.51	53.90	8.3	Floor noise
Hori.	9848.000	AV	38.10	38.20	7.89	41.76	1.73	3.33	47.49	53.90	6.4	Floor noise
Vert.	2483.500	AV	42.50	27.93	13.71	43.87	1.73	2.28	44.28	53.90	9.6	*1)
Vert.	4924.000	AV	41.70	32.67	5.78	45.29	1.73	3.33	39.92	53.90	13.9	
Vert.	7386.000	AV	39.60	37.44	7.06	43.65	1.73	3.33	45.51	53.90	8.3	Floor noise
Vert.	9848.000	AV	37.80	38.20	7.89	41.76	1.73	3.33	47.19	53.90	6.7	Floor noise

Result = Reading + Ant.Fac. + Loss (Cable+(Attenuator or Filter)(below 18 GHz)) - Gain(Amplifier) + Duty factor + Distance factor
Distance factor : 1 GHz - 10 GHz : 20log(3.9 m / 3.0 m) = 2.28 dB or 20log(4.4 m / 3.0 m) = 3.33 dB
10 GHz - 40 GHz : 20log(1.0 m / 3.0 m) = -9.54 dB

Duty factor refer to "Duty factor Calculation chart" sheet.

*1) Not out of band emission (Leakage Power)

UL Japan, Inc.

Kashima EMC Lab.

1614, Mushihata, Katori-shi, Chiba-ken, 289-0341 Japan

Telephone : +81 478 88 6500

Facsimile : +81 478 82 3373

Radiated Spurious Emission
(Reference Plot for band-edge)

Report No. 13063556M-B-R2
Test place Kashima EMC Lab.
Semi Anechoic Chamber No.11
Date October 21, 2019
Temperature / Humidity 22 deg. C / 55 % RH
Engineer Hiromitsu Tanabe
(1 GHz - 2.8 GHz)
Mode Tx 11g 2462 MHz

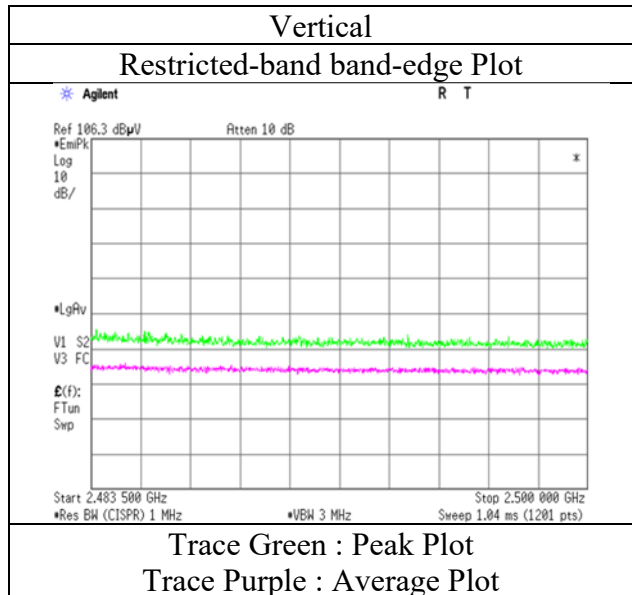
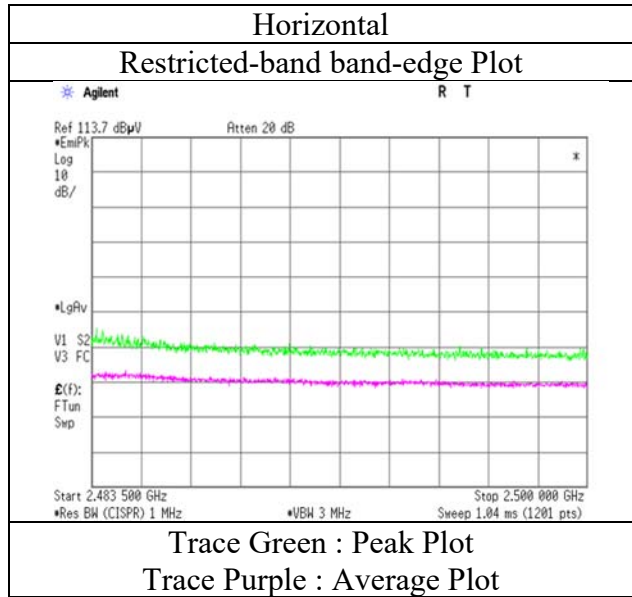

* The measurement was conducted for a sufficiently long enough time to detect any possible spurious emissions.
Final result of restricted band edge was shown in tabular data.

Radiated Spurious Emission

Report No.	13063556M-B-R2				
Test place	Kashima EMC Lab.				
Semi Anechoic Chamber	No.11	No.10	No.10	No.11	No.11
Date	October 21, 2019	October 29, 2019	October 23, 2019	October 19, 2019	October 18, 2019
Temperature / Humidity	22 deg. C / 55 % RH	23 deg. C / 52 % RH	20 deg. C / 53 % RH	20 deg. C / 58 % RH	22 deg. C / 52 % RH
Engineer	Hiromitsu Tanabe	Hiromitsu Tanabe	Hiromitsu Tanabe	Hiromitsu Tanabe	Hiromitsu Tanabe
	(1 GHz - 2.8 GHz)	(1 GHz - 2.8 GHz)	(2.8 GHz - 10 GHz)	(10 GHz - 18 GHz)	(18 GHz - 26.5 GHz)
Mode	Tx 11n-20 2412 MHz				

(* PK: Peak, AV: Average, QP: Quasi-Peak)

Polarity	Frequency [MHz]	Detector	Reading [dBuV]	Ant.Fac. [dB/m]	Loss [dB]	Gain [dB]	Distance Factor [dB]	Result [dBuV/m]	Limit [dBuV/m]	Margin [dB]	Height [cm]	Angle [deg]	Remark
Hori.	2390.000	PK	61.10	27.60	13.65	43.90	3.33	61.78	73.90	12.1	205	209	
Hori.	2798.990	PK	49.40	28.81	13.95	43.82	3.33	51.67	73.90	22.2	126	178	
Hori.	4824.000	PK	50.70	32.67	5.72	45.22	3.33	47.20	73.90	26.7	140	165	
Hori.	7236.000	PK	48.90	37.27	7.02	44.01	3.33	52.51	73.90	21.3	100	0	Floor noise
Hori.	9648.000	PK	47.80	38.14	7.82	41.86	3.33	55.23	73.90	18.6	100	0	Floor noise
Hori.	2798.990	AV	41.50	28.81	13.95	43.82	3.33	43.77	53.90	10.1	126	178	
Vert.	2390.000	PK	56.00	27.60	13.65	43.90	3.33	56.68	73.90	17.2	224	213	
Vert.	2798.990	PK	52.30	28.81	13.95	43.82	3.33	54.57	73.90	19.3	233	190	
Vert.	4824.000	PK	50.40	32.67	5.72	45.22	3.33	46.90	73.90	27.0	155	160	
Vert.	7236.000	PK	48.40	37.27	7.02	44.01	3.33	52.01	73.90	21.8	100	0	Floor noise
Vert.	9648.000	PK	47.80	38.14	7.82	41.86	3.33	55.23	73.90	18.6	100	0	Floor noise
Vert.	2798.990	AV	45.40	28.81	13.95	43.82	3.33	47.67	53.90	6.2	233	190	

Result = Reading + Ant.Fac. + Loss (Cable+(Attenuator or Filter)(below 18 GHz)) - Gain(Amplifier) + Distance factor

Distance factor : 1 GHz - 10 GHz : 20log(4.4 m / 3.0 m) = 3.33 dB

10 GHz - 40 GHz : 20log(1.0 m / 3.0 m) = -9.54 dB

Average measurement value with duty factor

Polarity	Frequency [MHz]	Detector	Reading [dBuV]	Ant.Fac. [dB/m]	Loss [dB]	Gain [dB]	Duty Factor [dB]	Distance Factor [dB]	Result [dBuV/m]	Limit [dBuV/m]	Margin [dB]	Remark
Hori.	2390.000	AV	48.10	27.60	13.65	43.90	1.71	3.33	50.49	53.90	3.4	*1)
Hori.	4824.000	AV	41.80	32.67	5.72	45.22	1.71	3.33	40.01	53.90	13.8	
Hori.	7236.000	AV	39.50	37.27	7.02	44.01	1.71	3.33	44.82	53.90	9.0	Floor noise
Hori.	9648.000	AV	38.80	38.14	7.82	41.86	1.71	3.33	47.94	53.90	5.9	Floor noise
Vert.	2390.000	AV	44.70	27.60	13.65	43.90	1.71	3.33	47.09	53.90	6.8	*1)
Vert.	4824.000	AV	41.80	32.67	5.72	45.22	1.71	3.33	40.01	53.90	13.8	
Vert.	7236.000	AV	39.80	37.27	7.02	44.01	1.71	3.33	45.12	53.90	8.7	Floor noise
Vert.	9648.000	AV	38.70	38.14	7.82	41.86	1.71	3.33	47.84	53.90	6.0	Floor noise

Result = Reading + Ant.Fac. + Loss (Cable+(Attenuator or Filter)(below 18 GHz)) - Gain(Amplifier) + Duty factor + Distance factor

Distance factor : 1 GHz - 10 GHz : 20log(4.4 m / 3.0 m) = 3.33 dB

10 GHz - 40 GHz : 20log(1.0 m / 3.0 m) = -9.54 dB

Duty factor refer to "Duty factor Calculation chart" sheet.

*1) Not out of band emission (Leakage Power)

20 dBc Data Sheet (RBW 100 kHz, VBW 300 kHz)

Polarity	Frequency [MHz]	Detector	Reading [dBuV]	Ant.Fac. [dB/m]	Loss [dB]	Gain [dB]	Distance Factor [dB]	Result [dBuV/m]	Limit [dBuV/m]	Margin [dB]	Remark
Hori.	2412.000	PK	97.62	27.66	13.67	43.89	2.28	97.34	-	-	Carrier
Hori.	2400.000	PK	69.60	27.61	13.66	43.89	2.28	69.26	77.34	8.0	
Vert.	2412.000	PK	91.30	27.66	13.67	43.89	2.28	91.02	-	-	Carrier
Vert.	2400.000	PK	51.80	27.61	13.66	43.89	2.28	51.46	71.02	19.5	

Result = Reading + Ant.Fac. + Loss (Cable+(Attenuator or Filter)(below 18 GHz)) - Gain(Amplifier) + Distance factor

Distance factor : 1 GHz - 10 GHz : 20log(3.9 m / 3.0 m) = 2.28 dB

10 GHz - 40 GHz : 20log(1.0 m / 3.0 m) = -9.54 dB

UL Japan, Inc.

Kashima EMC Lab.

1614, Mushihata, Katori-shi, Chiba-ken, 289-0341 Japan

Telephone : +81 478 88 6500

Facsimile : +81 478 82 3373

Radiated Spurious Emission
(Reference Plot for band-edge)

Report No. 13063556M-B-R2
Test place Kashima EMC Lab.
Semi Anechoic Chamber No.11
Date October 21, 2019
Temperature / Humidity 22 deg. C / 55 % RH
Engineer Hiromitsu Tanabe
(1 GHz - 2.8 GHz)
Mode Tx 11n-20 2412 MHz

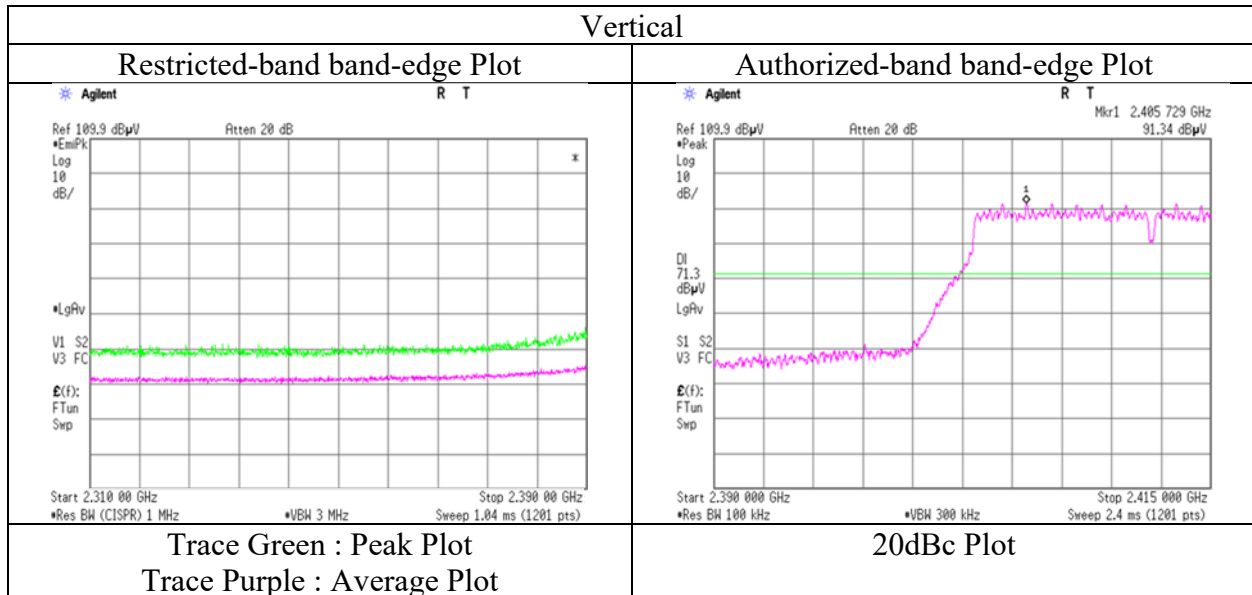
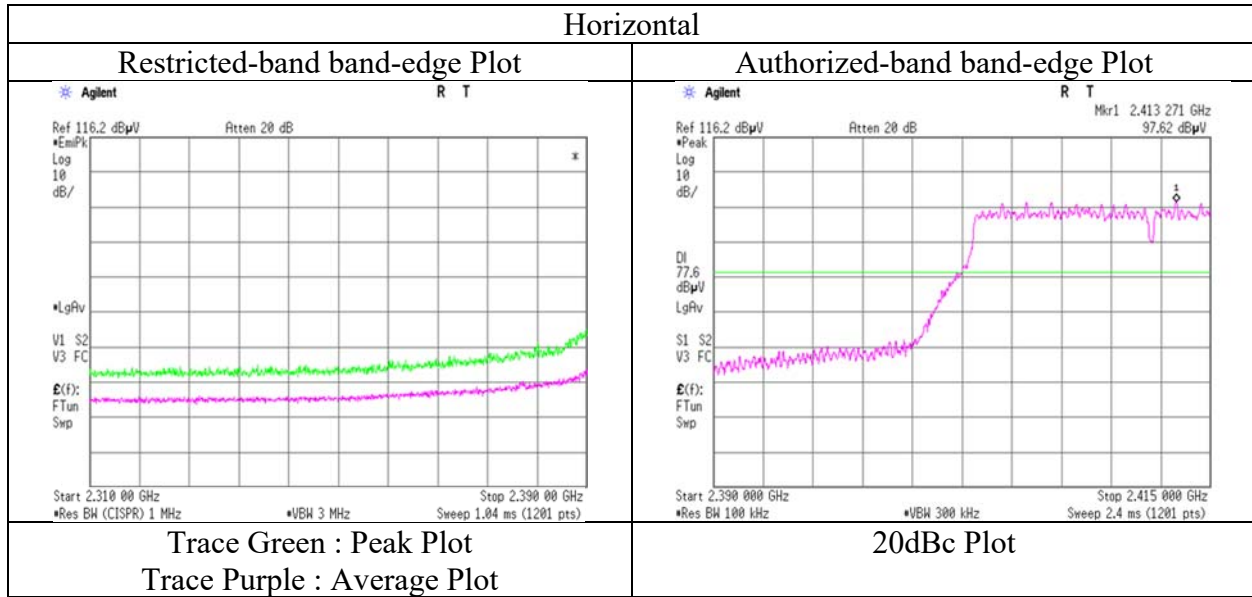

* The measurement was conducted for a sufficiently long enough time to detect any possible spurious emissions.

Final result of restricted band edge was shown in tabular data.

Radiated Spurious Emission

Report No.	13063556M-B-R2			
Test place	Kashima EMC Lab.			
Semi Anechoic Chamber	No.11	No.10	No.11	No.11
Date	October 21, 2019	October 23, 2019	October 19, 2019	October 18, 2019
Temperature / Humidity	22 deg. C / 55 % RH	20 deg. C / 53 % RH	20 deg. C / 58 % RH	22 deg. C / 52 % RH
Engineer	Hiromitsu Tanabe	Hiromitsu Tanabe	Hiromitsu Tanabe	Hiromitsu Tanabe
	(1 GHz - 2.8 GHz)	(2.8 GHz - 10 GHz)	(10 GHz - 18 GHz)	(18 GHz - 26.5 GHz)
Mode	Tx 11n-20 2437 MHz			

(* PK: Peak, AV: Average, QP: Quasi-Peak)

Polarity	Frequency [MHz]	Detector	Reading [dBuV]	Ant.Fac. [dB/m]	Loss [dB]	Gain [dB]	Distance Factor [dB]	Result [dBuV/m]	Limit [dBuV/m]	Margin [dB]	Height [cm]	Angle [deg]	Remark
Hori.	2798.990	PK	52.30	28.81	13.95	43.82	2.28	53.52	73.90	20.3	226	128	
Hori.	4874.000	PK	50.50	32.68	5.75	45.24	3.33	47.02	73.90	26.8	140	150	
Hori.	7311.000	PK	48.40	37.39	7.05	43.84	3.33	52.33	73.90	21.5	100	0	Floor noise
Hori.	9748.000	PK	47.30	38.14	7.86	41.78	3.33	54.85	73.90	19.0	100	0	Floor noise
Hori.	2798.990	AV	43.10	28.81	13.95	43.82	2.28	44.32	53.90	9.5	226	128	
Vert.	2798.990	PK	53.90	28.81	13.95	43.82	2.28	55.12	73.90	18.7	213	197	
Vert.	4874.000	PK	50.70	32.68	5.75	45.24	3.33	47.22	73.90	26.6	170	165	
Vert.	7311.000	PK	48.60	37.39	7.05	43.84	3.33	52.53	73.90	21.3	100	0	Floor noise
Vert.	9748.000	PK	47.20	38.14	7.86	41.78	3.33	54.75	73.90	19.1	100	0	Floor noise
Vert.	2798.990	AV	45.90	28.81	13.95	43.82	2.28	47.12	53.90	6.7	213	197	

Result = Reading + Ant.Fac. + Loss (Cable+(Attenuator or Filter)(below 18 GHz)) - Gain(Amplifier) + Distance factor

Distance factor : 1 GHz - 10 GHz : $20\log(3.9\text{ m} / 3.0\text{ m}) = 2.28\text{ dB}$ or $20\log(4.4\text{ m} / 3.0\text{ m}) = 3.33\text{ dB}$

10 GHz - 40 GHz : $20\log(1.0\text{ m} / 3.0\text{ m}) = -9.54\text{ dB}$

Average measurement value with duty factor

Polarity	Frequency [MHz]	Detector	Reading [dBuV]	Ant.Fac. [dB/m]	Loss [dB]	Gain [dB]	Duty Factor [dB]	Distance Factor [dB]	Result [dBuV/m]	Limit [dBuV/m]	Margin [dB]	Remark
Hori.	4874.000	AV	41.70	32.68	5.75	45.24	1.71	3.33	39.93	53.90	13.9	
Hori.	7311.000	AV	39.90	37.39	7.05	43.84	1.71	3.33	45.54	53.90	8.3	Floor noise
Hori.	9748.000	AV	38.10	38.14	7.86	41.78	1.71	3.33	47.36	53.90	6.5	Floor noise
Vert.	4874.000	AV	41.50	32.68	5.75	45.24	1.71	3.33	39.73	53.90	14.1	
Vert.	7311.000	AV	40.00	37.39	7.05	43.84	1.71	3.33	45.64	53.90	8.2	Floor noise
Vert.	9748.000	AV	38.10	38.14	7.86	41.78	1.71	3.33	47.36	53.90	6.5	Floor noise

Result = Reading + Ant.Fac. + Loss (Cable+(Attenuator or Filter)(below 18 GHz)) - Gain(Amplifier) + Duty factor + Distance factor

Distance factor : 1 GHz - 10 GHz : $20\log(4.4\text{ m} / 3.0\text{ m}) = 3.33\text{ dB}$

10 GHz - 40 GHz : $20\log(1.0\text{ m} / 3.0\text{ m}) = -9.54\text{ dB}$

Duty factor refer to "Duty factor Calculation chart" sheet.

UL Japan, Inc.

Kashima EMC Lab.

1614, Mushihata, Katori-shi, Chiba-ken, 289-0341 Japan

Telephone : +81 478 88 6500

Facsimile : +81 478 82 3373

Radiated Spurious Emission

Report No.	13063556M-B-R2			
Test place	Kashima EMC Lab.			
Semi Anechoic Chamber	No.11	No.10	No.11	No.11
Date	October 21, 2019	October 23, 2019	October 19, 2019	October 18, 2019
Temperature / Humidity	22 deg. C / 55 % RH	20 deg. C / 53 % RH	20 deg. C / 58 % RH	22 deg. C / 52 % RH
Engineer	Hiromitsu Tanabe	Hiromitsu Tanabe	Hiromitsu Tanabe	Hiromitsu Tanabe
	(1 GHz - 2.8 GHz)	(2.8 GHz - 10 GHz)	(10 GHz - 18 GHz)	(18 GHz - 26.5 GHz)
Mode	Tx 11n-20 2462 MHz			

(* PK: Peak, AV: Average, QP: Quasi-Peak)

Polarity	Frequency [MHz]	Detector	Reading [dBuV]	Ant.Fac. [dB/m]	Loss [dB]	Gain [dB]	Distance Factor [dB]	Result [dBuV/m]	Limit [dBuV/m]	Margin [dB]	Height [cm]	Angle [deg]	Remark
Hori.	2483.500	PK	59.20	27.93	13.71	43.87	2.28	59.25	73.90	14.6	160	152	
Hori.	2798.990	PK	50.50	28.81	13.95	43.82	2.28	51.72	73.90	22.1	178	129	
Hori.	4924.000	PK	50.40	32.67	5.78	45.29	3.33	46.89	73.90	27.0	140	155	
Hori.	7386.000	PK	47.80	37.44	7.06	43.65	3.33	51.98	73.90	21.9	100	0	Floor noise
Hori.	9848.000	PK	46.90	38.20	7.89	41.76	3.33	54.56	73.90	19.3	100	0	Floor noise
Hori.	2798.990	AV	42.70	28.81	13.95	43.82	2.28	43.92	53.90	9.9	178	129	
Vert.	2483.500	PK	50.40	27.93	13.71	43.87	2.28	50.45	73.90	23.4	145	206	
Vert.	2798.990	PK	52.60	28.81	13.95	43.82	2.28	53.82	73.90	20.0	165	183	
Vert.	4924.000	PK	50.20	32.67	5.78	45.29	3.33	46.69	73.90	27.2	170	190	
Vert.	7386.000	PK	48.30	37.44	7.06	43.65	3.33	52.48	73.90	21.4	100	0	Floor noise
Vert.	9848.000	PK	46.60	38.20	7.89	41.76	3.33	54.26	73.90	19.6	100	0	Floor noise
Vert.	2798.990	AV	45.50	28.81	13.95	43.82	2.28	46.72	53.90	7.1	165	183	

Result = Reading + Ant.Fac. + Loss (Cable+(Attenuator or Filter)(below 18 GHz)) - Gain(Amplifier) + Distance factor
Distance factor : 1 GHz - 10 GHz : 20log(3.9 m / 3.0 m) = 2.28 dB or 20log(4.4 m / 3.0 m) = 3.33 dB
10 GHz - 40 GHz : 20log(1.0 m / 3.0 m) = -9.54 dB

Average measurement value with duty factor

Polarity	Frequency [MHz]	Detector	Reading [dBuV]	Ant.Fac. [dB/m]	Loss [dB]	Gain [dB]	Duty Factor [dB]	Distance Factor [dB]	Result [dBuV/m]	Limit [dBuV/m]	Margin [dB]	Remark
Hori.	2483.500	AV	45.40	27.93	13.71	43.87	1.71	2.28	47.16	53.90	6.7	*1)
Hori.	4924.000	AV	41.70	32.67	5.78	45.29	1.71	3.33	39.90	53.90	14.0	
Hori.	7386.000	AV	39.50	37.44	7.06	43.65	1.71	3.33	45.39	53.90	8.5	Floor noise
Hori.	9848.000	AV	37.90	38.20	7.89	41.76	1.71	3.33	47.27	53.90	6.6	Floor noise
Vert.	2483.500	AV	41.60	27.93	13.71	43.87	1.71	2.28	43.36	53.90	10.5	*1)
Vert.	4924.000	AV	41.60	32.67	5.78	45.29	1.71	3.33	39.80	53.90	14.1	
Vert.	7386.000	AV	39.80	37.44	7.06	43.65	1.71	3.33	45.69	53.90	8.2	Floor noise
Vert.	9848.000	AV	37.70	38.20	7.89	41.76	1.71	3.33	47.07	53.90	6.8	Floor noise

Result = Reading + Ant.Fac. + Loss (Cable+(Attenuator or Filter)(below 18 GHz)) - Gain(Amplifier) + Duty factor + Distance factor
Distance factor : 1 GHz - 10 GHz : 20log(3.9 m / 3.0 m) = 2.28 dB or 20log(4.4 m / 3.0 m) = 3.33 dB
10 GHz - 40 GHz : 20log(1.0 m / 3.0 m) = -9.54 dB

Duty factor refer to "Duty factor Calculation chart" sheet.

*1) Not out of band emission (Leakage Power)

UL Japan, Inc.

Kashima EMC Lab.

1614, Mushihata, Katori-shi, Chiba-ken, 289-0341 Japan

Telephone : +81 478 88 6500

Facsimile : +81 478 82 3373

Radiated Spurious Emission
(Reference Plot for band-edge)

Report No. 13063556M-B-R2
Test place Kashima EMC Lab.
Semi Anechoic Chamber No.11
Date October 21, 2019
Temperature / Humidity 22 deg. C / 55 % RH
Engineer Hiromitsu Tanabe
(1 GHz - 2.8 GHz)
Mode Tx 11n-20 2462 MHz

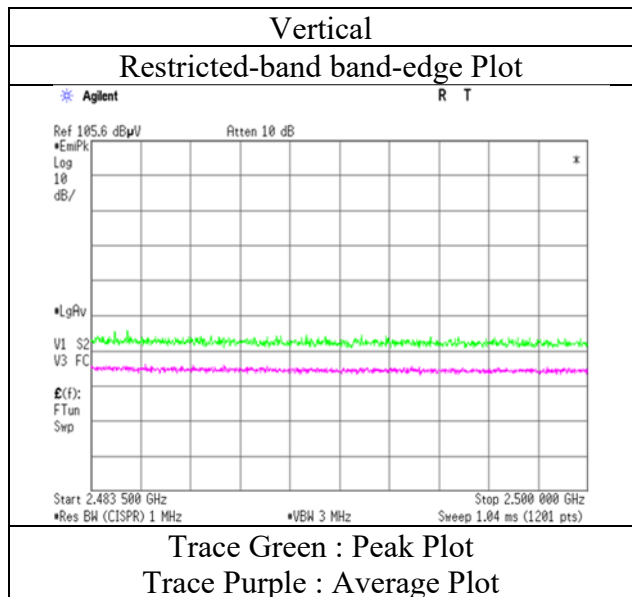
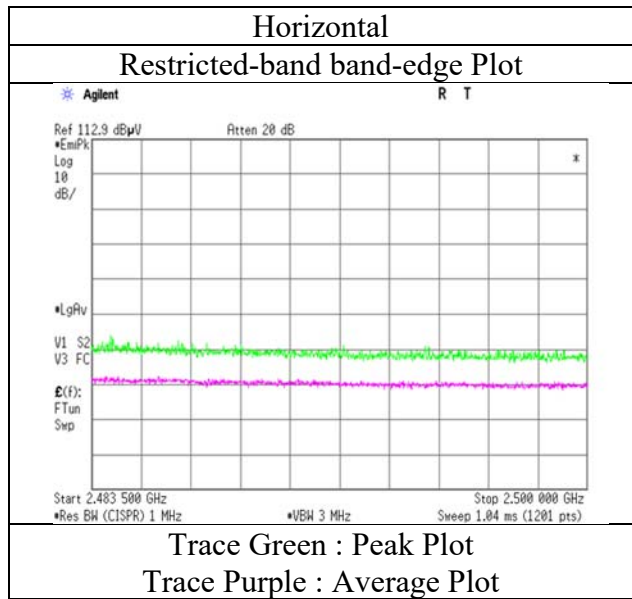

* The measurement was conducted for a sufficiently long enough time to detect any possible spurious emissions.
Final result of restricted band edge was shown in tabular data.

Radiated Spurious Emission

Report No. 13063556M-B-R2
Test place Kashima EMC Lab.
Semi Anechoic Chamber No.10 No.11 No.10 No.11 No.11
Date October 16, 2019 October 21, 2019 October 23, 2019 October 19, 2019 October 19, 2019
Temperature / Humidity 23 deg. C / 54 % RH 22deg. C / 55 % RH 20 deg. C / 53 % RH 22 deg. C / 52 % RH 22 deg. C / 52 % RH
Engineer Hiromitsu Tanabe Hiromitsu Tanabe Hiromitsu Tanabe Hiromitsu Tanabe Hiromitsu Tanabe
(30 MHz - 1000 MHz) (1 GHz - 2.8 GHz) (2.8 GHz - 10 GHz) (10 GHz - 18 GHz) (18 GHz - 26.5 GHz)

Mode Tx BT LE 2402 MHz
(* PK: Peak, AV: Average, QP: Quasi-Peak)

Polarity	Frequency [MHz]	Detector	Reading [dBuV]	Ant.Fac. [dB/m]	Loss [dB]	Gain [dB]	Distance Factor [dB]	Result [dBuV/m]	Limit [dBuV/m]	Margin [dB]	Height [cm]	Angle [deg]	Remark
Hori.	229.503	QP	55.40	10.02	8.10	31.51	0.00	42.01	46.02	4.0	151	232	
Hori.	350.000	QP	47.00	14.29	9.08	31.48	0.00	38.89	46.02	7.1	100	221	
Hori.	417.788	QP	43.16	15.99	9.59	31.43	0.00	37.31	46.02	8.7	100	28	
Hori.	430.077	QP	43.05	16.52	9.68	31.43	0.00	37.82	46.02	8.2	100	30	
Hori.	454.653	QP	41.41	17.10	9.85	31.42	0.00	36.94	46.02	9.0	100	200	
Hori.	2390.000	PK	49.70	27.60	13.65	43.90	2.28	49.33	73.90	24.5	103	199	
Hori.	2798.990	PK	50.40	28.81	13.95	43.82	2.28	51.62	73.90	22.2	105	182	
Hori.	4804.000	PK	50.60	32.65	5.71	45.21	3.33	47.08	73.90	26.8	140	165	
Hori.	7206.000	PK	49.00	37.21	7.01	44.08	3.33	52.47	73.90	21.4	100	0	Floor noise
Hori.	9608.000	PK	48.10	38.11	7.80	41.88	3.33	55.46	73.90	18.4	100	0	Floor noise
Hori.	2798.990	AV	42.60	28.81	13.95	43.82	2.28	43.82	53.90	10.0	105	182	
Vert.	52.974	QP	39.87	13.75	6.26	31.78	0.00	28.10	40.00	11.9	100	71	
Vert.	196.606	QP	48.93	10.02	7.82	31.54	0.00	35.23	43.52	8.2	100	120	
Vert.	229.570	QP	48.96	10.02	8.10	31.51	0.00	35.57	46.02	10.4	100	167	
Vert.	368.637	QP	45.24	14.85	9.23	31.47	0.00	37.85	46.02	8.1	100	316	
Vert.	2390.000	PK	49.90	27.60	13.65	43.90	2.28	49.53	73.90	24.3	182	186	
Vert.	2798.990	PK	52.66	28.81	13.95	43.82	2.28	53.88	73.90	20.0	122	203	
Vert.	4804.000	PK	51.30	32.65	5.71	45.21	3.33	47.78	73.90	26.1	160	150	
Vert.	7206.000	PK	49.00	37.21	7.01	44.08	3.33	52.47	73.90	21.4	100	0	Floor noise
Vert.	9608.000	PK	48.20	38.11	7.80	41.88	3.33	55.56	73.90	18.3	100	0	Floor noise
Vert.	2798.990	AV	46.20	28.81	13.95	43.82	2.28	47.42	53.90	6.4	122	203	

Result = Reading + Ant.Fac. + Loss (Cable+(Attenuator or Filter)(below 18 GHz)) - Gain(Amplifier) + Distance factor
Distance factor : 1 GHz - 10 GHz : 20log(3.9 m / 3.0 m) = 2.28 dB or 20log(4.4 m / 3.0 m) = 3.33 dB
10 GHz - 40 GHz : 20log(1.0 m / 3.0 m) = -9.54 dB

Average measurement value with duty factor

Polarity	Frequency [MHz]	Detector	Reading [dBuV]	Ant.Fac. [dB/m]	Loss [dB]	Gain [dB]	Duty Factor [dB]	Distance Factor [dB]	Result [dBuV/m]	Limit [dBuV/m]	Margin [dB]	Remark
Hori.	2390.000	AV	41.40	27.60	13.65	43.90	1.79	2.28	42.82	53.90	11.0	*1)
Hori.	4804.000	AV	41.60	32.65	5.71	45.21	1.79	3.33	39.87	53.90	14.0	
Hori.	7206.000	AV	39.90	37.21	7.01	44.08	1.79	3.33	45.16	53.90	8.7	Floor noise
Hori.	9608.000	AV	38.50	38.11	7.80	41.88	1.79	3.33	47.65	53.90	6.2	Floor noise
Vert.	2390.000	AV	41.20	27.60	13.65	43.90	1.79	2.28	42.62	53.90	11.2	*1)
Vert.	4804.000	AV	41.80	32.65	5.71	45.21	1.79	3.33	40.07	53.90	13.8	
Vert.	7206.000	AV	40.00	37.21	7.01	44.08	1.79	3.33	45.26	53.90	8.6	Floor noise
Vert.	9608.000	AV	38.50	38.11	7.80	41.88	1.79	3.33	47.65	53.90	6.2	Floor noise

Result = Reading + Ant.Fac. + Loss (Cable+(Attenuator or Filter)(below 18 GHz)) - Gain(Amplifier) + Duty factor + Distance factor
Distance factor : 1 GHz - 10 GHz : 20log(3.9 m / 3.0 m) = 2.28 dB or 20log(4.4 m / 3.0 m) = 3.33 dB
10 GHz - 40 GHz : 20log(1.0 m / 3.0 m) = -9.54 dB

Duty factor refer to "Duty factor Calculation chart" sheet.

*1) Not out of band emission (Leakage Power)

20 dBc Data Sheet (RBW 100 kHz, VBW 300 kHz)

Polarity	Frequency [MHz]	Detector	Reading [dBuV]	Ant.Fac. [dB/m]	Loss [dB]	Gain [dB]	Distance Factor [dB]	Result [dBuV/m]	Limit [dBuV/m]	Margin [dB]	Remark
Hori.	2402.000	PK	82.36	27.62	13.66	43.89	2.28	82.03	-	-	Carrier
Hori.	2400.000	PK	40.20	27.61	13.66	43.89	2.28	39.86	62.03	22.1	
Vert.	2402.000	PK	89.79	27.62	13.66	43.89	2.28	89.46	-	-	Carrier
Vert.	2400.000	PK	41.10	27.61	13.66	43.89	2.28	40.76	69.46	28.7	

Result = Reading + Ant.Fac. + Loss (Cable+(Attenuator or Filter)(below 18 GHz)) - Gain(Amplifier) + Distance factor
Distance factor : 1 GHz - 10 GHz : 20log(3.9 m / 3.0 m) = 2.28 dB
10 GHz - 40 GHz : 20log(1.0 m / 3.0 m) = -9.54 dB

UL Japan, Inc.

Kashima EMC Lab.

1614, Mushihata, Katori-shi, Chiba-ken, 289-0341 Japan

Telephone : +81 478 88 6500

Facsimile : +81 478 82 3373

Radiated Spurious Emission
(Reference Plot for band-edge)

Report No. 13063556M-B-R2
Test place Kashima EMC Lab.
Semi Anechoic Chamber No.11
Date October 21, 2019
Temperature / Humidity 22deg. C / 55 % RH
Engineer Hiromitsu Tanabe
(1 GHz - 2.8 GHz)
Mode Tx BT LE 2402 MHz

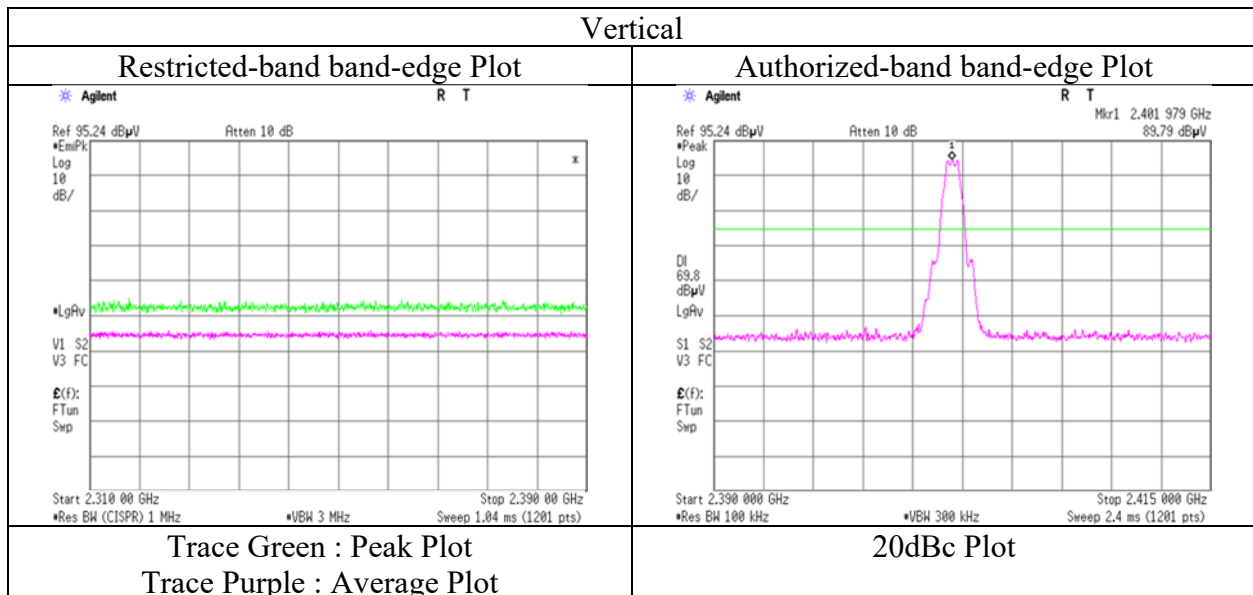
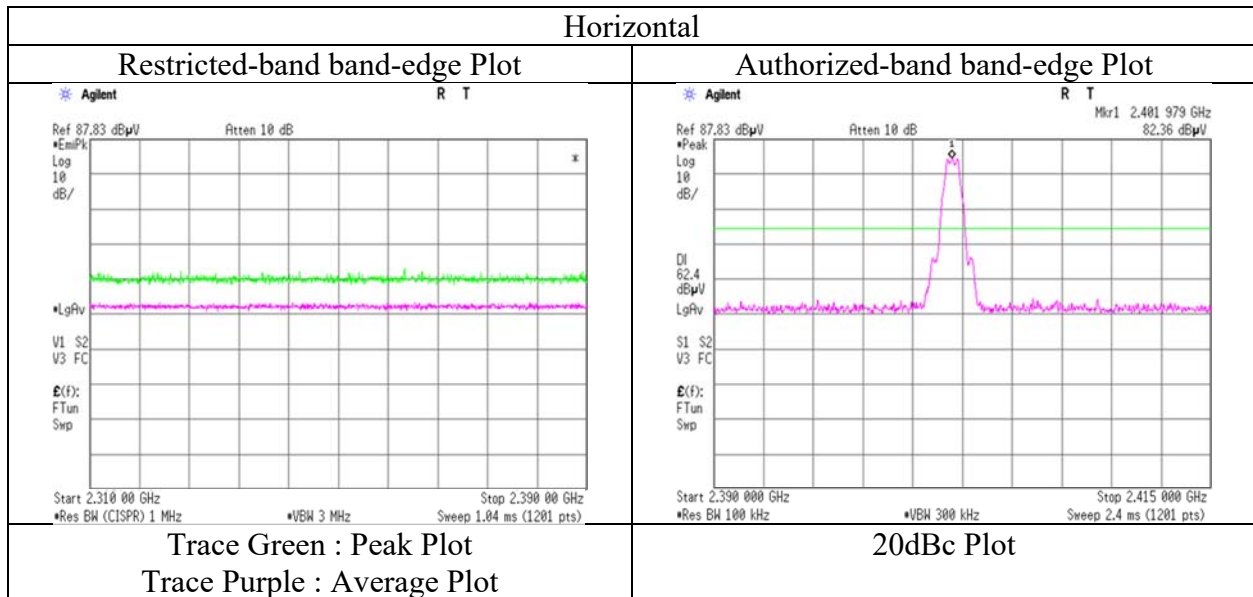

* The measurement was conducted for a sufficiently long enough time to detect any possible spurious emissions.
Final result of restricted band edge was shown in tabular data.

Radiated Spurious Emission

Report No. 13063556M-B-R2
Test place Kashima EMC Lab.
Semi Anechoic Chamber No.10 No.11 No.10 No.11 No.11
Date October 16, 2019 October 21, 2019 October 23, 2019 October 19, 2019 October 19, 2019
Temperature / Humidity 23 deg. C / 54 % RH 22deg. C / 55 % RH 20 deg. C / 53 % RH 22 deg. C / 52 % RH 22 deg. C / 52 % RH
Engineer Hiromitsu Tanabe Hiromitsu Tanabe Hiromitsu Tanabe Hiromitsu Tanabe Hiromitsu Tanabe
(30 MHz - 1000 MHz) (1 GHz - 2.8 GHz) (2.8 GHz - 10 GHz) (10 GHz - 18 GHz) (18 GHz - 26.5 GHz)
Mode Tx BT LE 2440 MHz

(* PK: Peak, AV: Average, QP: Quasi-Peak)

Polarity	Frequency [MHz]	Detector	Reading [dBuV]	Ant.Fac. [dB/m]	Loss [dB]	Gain [dB]	Distance Factor [dB]	Result [dBuV/m]	Limit [dBuV/m]	Margin [dB]	Height [cm]	Angle [deg]	Remark
Hori.	229.577	QP	55.41	10.03	8.10	31.51	0.00	42.03	46.02	3.9	136	232	
Hori.	350.000	QP	46.68	14.29	9.08	31.48	0.00	38.57	46.02	7.4	100	222	
Hori.	417.789	QP	43.06	15.99	9.59	31.43	0.00	37.21	46.02	8.8	100	27	
Hori.	430.077	QP	43.09	16.52	9.68	31.43	0.00	37.86	46.02	8.1	100	28	
Hori.	454.654	QP	41.56	17.10	9.85	31.42	0.00	37.09	46.02	8.9	100	202	
Hori.	2798.990	PK	50.70	28.81	13.95	43.82	2.28	51.92	73.90	21.9	150	131	
Hori.	4880.000	PK	50.50	32.67	5.75	45.25	3.33	47.00	73.90	26.9	140	155	
Hori.	7320.000	PK	48.60	37.41	7.05	43.82	3.33	52.57	73.90	21.3	100	0	Floor noise
Hori.	9760.000	PK	47.10	38.14	7.86	41.77	3.33	54.66	73.90	19.2	100	0	Floor noise
Hori.	2798.990	AV	42.90	28.81	13.95	43.82	2.28	44.12	53.90	9.7	150	131	
Vert.	52.985	QP	39.81	13.75	6.26	31.78	0.00	28.04	40.00	11.9	100	84	
Vert.	196.606	QP	49.08	10.02	7.82	31.54	0.00	35.38	43.52	8.1	100	125	
Vert.	229.563	QP	48.83	10.02	8.10	31.51	0.00	35.44	46.02	10.5	100	166	
Vert.	368.637	QP	45.33	14.85	9.23	31.47	0.00	37.94	46.02	8.0	100	319	
Vert.	2798.990	PK	52.20	28.81	13.95	43.82	2.28	53.42	73.90	20.4	111	195	
Vert.	4880.000	PK	50.50	32.67	5.75	45.25	3.33	47.00	73.90	26.9	175	150	
Vert.	7320.000	PK	48.20	37.41	7.05	43.82	3.33	52.17	73.90	21.7	100	0	Floor noise
Vert.	9760.000	PK	47.20	38.14	7.86	41.77	3.33	54.76	73.90	19.1	100	0	Floor noise
Vert.	2798.990	AV	46.20	28.81	13.95	43.82	2.28	47.42	53.90	6.4	111	195	

Result = Reading + Ant.Fac. + Loss (Cable+(Attenuator or Filter)(below 18 GHz)) - Gain(Amplifier) + Distance factor

Distance factor : 1 GHz - 10 GHz : $20\log(3.9\text{ m} / 3.0\text{ m}) = 2.28\text{ dB}$ or $20\log(4.4\text{ m} / 3.0\text{ m}) = 3.33\text{ dB}$

10 GHz - 40 GHz : $20\log(1.0\text{ m} / 3.0\text{ m}) = -9.54\text{ dB}$

Average measurement value with duty factor

Polarity	Frequency [MHz]	Detector	Reading [dBuV]	Ant.Fac. [dB/m]	Loss [dB]	Gain [dB]	Duty Factor [dB]	Distance Factor [dB]	Result [dBuV/m]	Limit [dBuV/m]	Margin [dB]	Remark
Hori.	4880.000	AV	41.60	32.67	5.75	45.25	1.79	3.33	39.89	53.90	14.0	
Hori.	7320.000	AV	39.50	37.41	7.05	43.82	1.79	3.33	45.26	53.90	8.6	Floor noise
Hori.	9760.000	AV	38.40	38.14	7.86	41.77	1.79	3.33	47.75	53.90	6.1	Floor noise
Vert.	4880.000	AV	41.70	32.67	5.75	45.25	1.79	3.33	39.99	53.90	13.9	
Vert.	7320.000	AV	39.70	37.41	7.05	43.82	1.79	3.33	45.46	53.90	8.4	Floor noise
Vert.	9760.000	AV	38.30	38.14	7.86	41.77	1.79	3.33	47.65	53.90	6.2	Floor noise

Result = Reading + Ant.Fac. + Loss (Cable+(Attenuator or Filter)(below 18 GHz)) - Gain(Amplifier) + Duty factor + Distance factor

Distance factor : 1 GHz - 10 GHz : $20\log(4.4\text{ m} / 3.0\text{ m}) = 3.33\text{ dB}$

10 GHz - 40 GHz : $20\log(1.0\text{ m} / 3.0\text{ m}) = -9.54\text{ dB}$

Duty factor refer to "Duty factor Calculation chart" sheet.

*1) Not out of band emission (Leakage Power)

UL Japan, Inc.

Kashima EMC Lab.

1614, Mushiata, Katori-shi, Chiba-ken, 289-0341 Japan

Telephone : +81 478 88 6500

Facsimile : +81 478 82 3373

Radiated Spurious Emission

Report No. 13063556M-B-R2
Test place Kashima EMC Lab.
Semi Anechoic Chamber No.10 No.11 No.10 No.11 No.11
Date October 16, 2019 October 21, 2019 October 23, 2019 October 19, 2019 October 19, 2019
Temperature / Humidity 23 deg. C / 54 % RH 22deg. C / 55 % RH 20 deg. C / 53 % RH 22 deg. C / 52 % RH 22 deg. C / 52 % RH
Engineer Hiromitsu Tanabe Hiromitsu Tanabe Hiromitsu Tanabe Hiromitsu Tanabe Hiromitsu Tanabe
(30 MHz - 1000 MHz) (1 GHz - 2.8 GHz) (2.8 GHz - 10 GHz) (10 GHz - 18 GHz) (18 GHz - 26.5 GHz)
Mode Tx BT LE 2480 MHz

(* PK: Peak, AV: Average, QP: Quasi-Peak)

Polarity	Frequency [MHz]	Detector	Reading [dBuV]	Ant.Fac. [dB/m]	Loss [dB]	Gain [dB]	Distance Factor [dB]	Result [dBuV/m]	Limit [dBuV/m]	Margin [dB]	Height [cm]	Angle [deg]	Remark
Hori.	229.562	QP	55.93	10.02	8.10	31.51	0.00	42.54	46.02	3.4	149	52	
Hori.	331.774	QP	46.37	14.21	8.94	31.49	0.00	38.03	46.02	7.9	100	218	
Hori.	417.789	QP	46.33	15.99	9.59	31.43	0.00	40.48	46.02	5.5	100	31	
Hori.	430.078	QP	45.34	16.52	9.68	31.43	0.00	40.11	46.02	5.9	100	27	
Hori.	454.652	QP	43.89	17.10	9.85	31.42	0.00	39.42	46.02	6.6	100	94	
Hori.	2483.500	PK	49.90	27.93	13.71	43.87	2.28	49.95	73.90	23.9	153	202	
Hori.	2798.990	PK	49.80	28.81	13.95	43.82	2.28	51.02	73.90	22.8	155	132	
Hori.	4960.000	PK	50.20	32.70	5.82	45.32	3.33	46.73	73.90	27.1	135	160	
Hori.	7440.000	PK	49.10	37.47	7.07	43.49	3.33	53.48	73.90	20.4	100	0	Floor noise
Hori.	9920.000	PK	47.00	38.29	7.92	41.76	3.33	54.78	73.90	19.1	100	0	Floor noise
Hori.	2798.990	AV	42.60	28.81	13.95	43.82	2.28	43.82	53.90	10.0	155	132	
Vert.	52.967	QP	40.57	13.75	6.26	31.78	0.00	28.80	40.00	11.2	100	89	
Vert.	196.606	QP	45.00	10.02	7.82	31.54	0.00	31.30	43.52	12.2	100	93	
Vert.	229.577	QP	49.66	10.03	8.10	31.51	0.00	36.28	46.02	9.7	100	162	
Vert.	417.789	QP	44.20	15.99	9.59	31.43	0.00	38.35	46.02	7.6	147	170	
Vert.	2483.500	PK	50.40	27.93	13.71	43.87	2.28	50.45	73.90	23.4	242	183	
Vert.	2798.990	PK	52.80	28.81	13.95	43.82	2.28	54.02	73.90	19.8	115	203	
Vert.	4960.000	PK	50.90	32.70	5.82	45.32	3.33	47.43	73.90	26.4	170	160	
Vert.	7440.000	PK	48.80	37.47	7.07	43.49	3.33	53.18	73.90	20.7	100	0	Floor noise
Vert.	9920.000	PK	46.90	38.29	7.92	41.76	3.33	54.68	73.90	19.2	100	0	Floor noise
Vert.	2798.990	AV	46.00	28.81	13.95	43.82	2.28	47.22	53.90	6.6	115	203	

Result = Reading + Ant.Fac. + Loss (Cable+(Attenuator or Filter)(below 18 GHz)) - Gain(Amplifier) + Distance factor

Distance factor : 1 GHz - 10 GHz : 20log(3.9 m / 3.0 m) = 2.28 dB or 20log(4.4 m / 3.0 m) = 3.33 dB

10 GHz - 40 GHz : 20log(1.0 m / 3.0 m) = -9.54 dB

Average measurement value with duty factor

Polarity	Frequency [MHz]	Detector	Reading [dBuV]	Ant.Fac. [dB/m]	Loss [dB]	Gain [dB]	Duty Factor [dB]	Distance Factor [dB]	Result [dBuV/m]	Limit [dBuV/m]	Margin [dB]	Remark
Hori.	2483.500	AV	41.30	27.93	13.71	43.87	1.79	2.28	43.14	53.90	10.7	*1)
Hori.	4960.000	AV	41.80	32.70	5.82	45.32	1.79	3.33	40.12	53.90	13.7	
Hori.	7440.000	AV	40.10	37.47	7.07	43.49	1.79	3.33	46.27	53.90	7.6	Floor noise
Hori.	9920.000	AV	37.80	38.29	7.92	41.76	1.79	3.33	47.37	53.90	6.5	Floor noise
Vert.	2483.500	AV	41.40	27.93	13.71	43.87	1.79	2.28	43.24	53.90	10.6	*1)
Vert.	4960.000	AV	41.80	32.70	5.82	45.32	1.79	3.33	40.12	53.90	13.7	
Vert.	7440.000	AV	40.20	37.47	7.07	43.49	1.79	3.33	46.37	53.90	7.5	Floor noise
Vert.	9920.000	AV	37.80	38.29	7.92	41.76	1.79	3.33	47.37	53.90	6.5	Floor noise

Result = Reading + Ant.Fac. + Loss (Cable+(Attenuator or Filter)(below 18 GHz)) - Gain(Amplifier) + Duty factor + Distance factor

Distance factor : 1 GHz - 10 GHz : 20log(3.9 m / 3.0 m) = 2.28 dB or 20log(4.4 m / 3.0 m) = 3.33 dB

10 GHz - 40 GHz : 20log(1.0 m / 3.0 m) = -9.54 dB

Duty factor refer to "Duty factor Calculation chart" sheet.

*1) Not out of band emission (Leakage Power)

UL Japan, Inc.

Kashima EMC Lab.

1614, Mushihata, Katori-shi, Chiba-ken, 289-0341 Japan

Telephone : +81 478 88 6500

Facsimile : +81 478 82 3373

Radiated Spurious Emission
(Reference Plot for band-edge)

Report No. 13063556M-B-R2
Test place Kashima EMC Lab.
Semi Anechoic Chamber No.11
Date October 21, 2019
Temperature / Humidity 22deg. C / 55 % RH
Engineer Hiromitsu Tanabe
(1 GHz - 2.8 GHz)
Mode Tx BT LE 2480 MHz

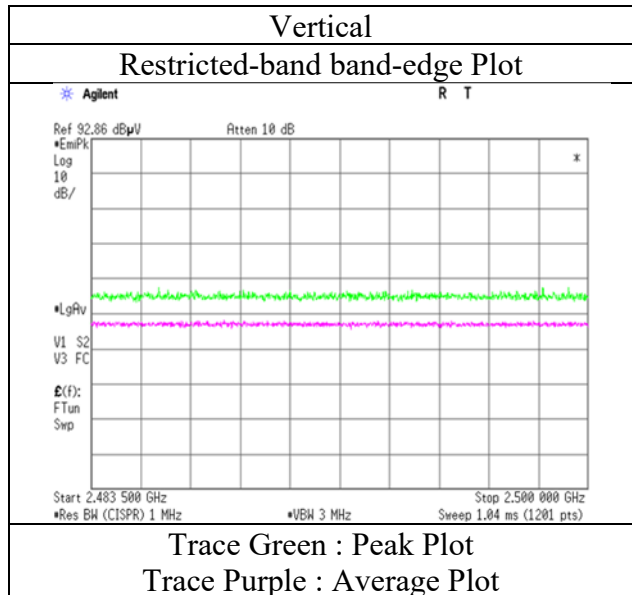
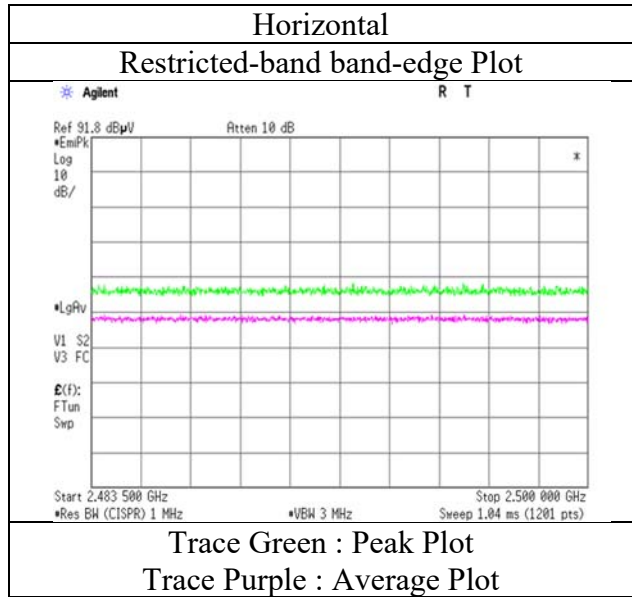

* The measurement was conducted for a sufficiently long enough time to detect any possible spurious emissions.
Final result of restricted band edge was shown in tabular data.

Radiated Spurious Emission
(Plot data, Worst case)

Report No.	13063556M-B-R2				
Test place	Kashima EMC Lab.				
Semi Anechoic Chamber	No.11	No.10	No.10	No.11	No.11
Date	October 21, 2019	October 29, 2019	October 23, 2019	October 19, 2019	October 18, 2019
Temperature / Humidity	22 deg. C / 55 % RH	23 deg. C / 52 % RH	20 deg. C / 53 % RH	20 deg. C / 58 % RH	22 deg. C / 52 % RH
Engineer	Hiromitsu Tanabe	Hiromitsu Tanabe	Hiromitsu Tanabe	Hiromitsu Tanabe	Hiromitsu Tanabe
	(1 GHz - 2.8 GHz)	(1 GHz - 2.8 GHz)	(2.8 GHz - 10 GHz)	(10 GHz - 18 GHz)	(18 GHz - 26.5 GHz)
Mode	Tx 11g 2412 MHz				

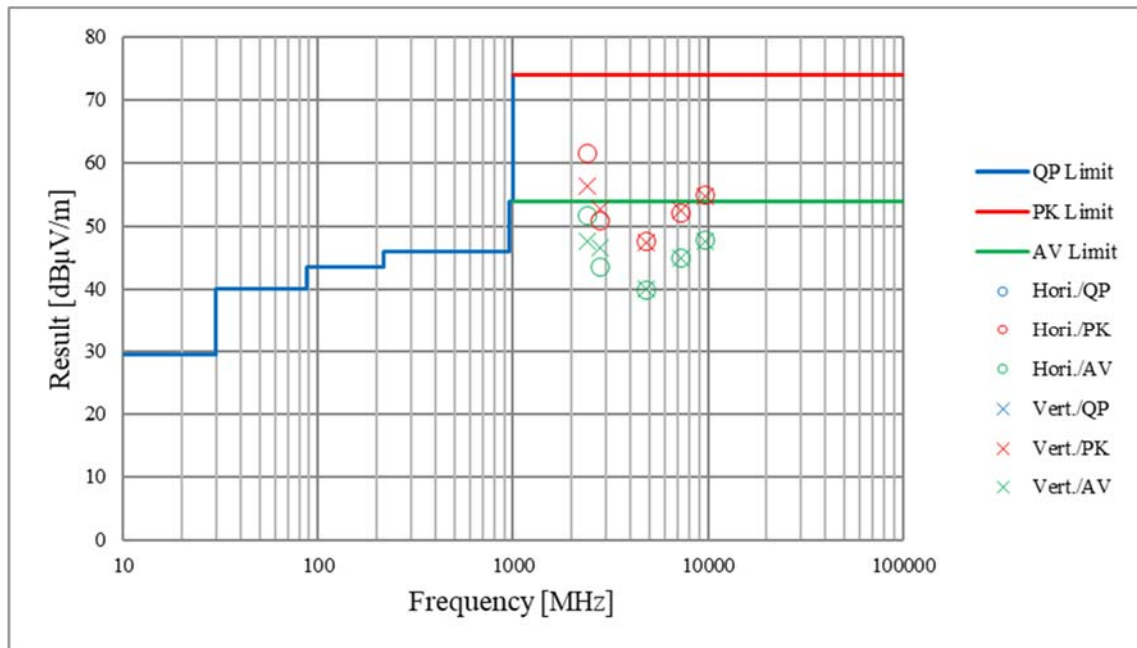

*These plots data contains sufficient number to show the trend of characteristic features for EUT.

APPENDIX 2: Test instruments

Test Item	LIMS ID	Description	Manufacturer	Model	Serial	Last Calibration Date	Calibration Due Date	Cal Int
RE	143107	Coaxial Cable	Fujikura,Suhner,Suhner,Agilent Suhner,-,Suhner	15DSFA,SF106,SF104,8496B+8494B,SF1	MY41110308,2550A11724(Step Att)	2018/12/19	2019/12/31	12
RE	178807	5dB Fixed Atten.	PASTERNAK	PE7047-5	none	2019/04/03	2020/04/30	12
RE	142929	Pre-Amplifier	SONOMA INSTRUMENT	310N	240505	2018/11/21	2019/11/30	12
RE	144193	Test Receiver	Rohde & Schwarz	ESU40	100426	2019/04/19	2020/04/30	12
RE	143121	LOGBICON	Schwarzbeck	VULB 9168	343	2019/04/03	2020/04/30	12
RE	178806	5dB Fixed Atten.	PASTERNAK	PE7047-5	none	2019/04/03	2020/04/30	12
RE	143165	10 Site RE 3m System	UL Japan Inc.	none	none	2019/08/04	2020/08/31	12
RE	183880	Pre-Amplifier	UL Japan Inc.	ZKL-2	1	2019/04/08	2020/04/30	12
RE	144199	Test Receiver	AGILENT	N9038A	MY53290016	2019/07/17	2020/07/31	12
RE	143122	LOGBICON	Schwarzbeck	VULB 9168	508	2019/04/03	2020/04/30	12
RE(GHz)	143455	Double Ridged Wave Guide	ETS-Lindgren	3115	00204569	2019/02/04	2020/02/29	12
RE(GHz)	143456	Double Ridged Wave Guide	ETS-Lindgren	3115	00204573	2019/02/04	2020/02/29	12
RE(GHz)	143140	Micro Wave Cable	Junkosha	MWX221	1407S222	2018/11/15	2019/11/30	12
RE(GHz)	143111	Micro Wave Cable	Junkosha	MWX221	MRA-12-14-148	2019/05/23	2020/05/31	12
RE(GHz)	142940	Pre-Amplifier	Micro Wave Factory	MPR-1G26.5-35	161399	2019/06/09	2020/06/30	12
RE(GHz)	143023	10dB Fixed Atten.	Weinschel- API Technologies Corp	54A-10	56251	2019/05/23	2020/05/31	12
RE(GHz)	143442	HPF	MICRO-TRONICS	HPM50111-02	009	2019/05/23	2020/05/31	12
RE(GHz)	143643	Spectrum Analyzer	AGILENT	E4448A	MY52490024	2019/06/01	2020/06/30	12
RE(GHz)	143438	Double Ridged Horn	ETS-Lindgren	3160-09	00166043	2019/06/08	2020/06/30	12
RE(GHz)	142937	Pre-Amplifier	TOYO	HAP18-26W	00000035	2019/06/12	2020/06/30	12
RE(GHz)	143113	Micro Wave Cable	Suhner	SUCOFLEX104	MY588/4	2019/07/12	2020/07/31	12
EMI	178804	EMI Software	TSJ	TEPTO-DV3 (RE,CE,ME,PE)	-	-	-	-
EMI	143654	Ruler	TAJIMA	L19-55	-	-	-	-
EMI	143542	Temperature & Humidity Indicator	HIOKI	3641/9680-50	090999895/090905406	2019/06/21	2020/06/30	12
EMI	143133	Barometer	Sunoh	SBR-151	001439	2018/11/25	2021/11/30	36
EMI	144216	Digital Multimeter	Fluke Corporation	115	994460954	2019/10/27	2020/10/31	12

The expiration date of the calibration is the end of the expired month.

All equipment is calibrated with valid calibrations. Each measurement data is traceable to the national or international standards.

As for some calibrations performed after the tested dates, those test equipment have been controlled by means of an unbroken chains of calibrations.

Test item: RE: Radiated Emission test

UL Japan, Inc.

Kashima EMC Lab.

1614, Mushiata, Katori-shi, Chiba-ken, 289-0341 Japan

Telephone : +81 478 88 6500

Facsimile : +81 478 82 3373