



RADIO TEST REPORT

Test Report No. : 11307145S-A-R2

Applicant : PIONEER CORPORATION
Type of Equipment : Main Unit
Model No. : D171
FCC ID : AJDK098
Test regulation : FCC Part 15 Subpart C: 2016
Test Result : Complied

1. This test report shall not be reproduced in full or partial, without the written approval of UL Japan, Inc.
2. The results in this report apply only to the sample tested.
3. This sample tested is in compliance with the above regulation.
4. The test results in this report are traceable to the national or international standards.
5. The opinions and the interpretations to the result of the description in this report are outside scopes where UL Japan has been accredited.
6. This test report covers Radio technical requirements. It does not cover administrative issues such as Manual or non-Radio test related Requirements. (if applicable)
7. This report is a revised version of 11307145S-A. 11307145S-A is replaced with this report.

Date of test: April 13 to June 8, 2016

Representative test engineer:

M. Hosaka

Makoto Hosaka

Engineer

Consumer Technology Division

Approved by:

A. Hayashi

Akio Hayashi

Leader

Consumer Technology Division



JAB
Testing
RTL02610

- The testing in which "Non-accreditation" is displayed is outside the accreditation scopes in UL Japan.
 There is no testing item of "Non-accreditation".

UL Japan, Inc.

Shonan EMC Lab.

1-22-3 Megumigaoka, Hiratsuka-shi, Kanagawa-ken, 259-1220 JAPAN

Telephone : +81 463 50 6400

Facsimile : +81 463 50 6401

13-EM-F0429

REVISION HISTORY

Original Test Report No.: 11307145S-A

| Revision | Test report No. | Date | Page revised | Contents |
|-----------------|-----------------|---------------|----------------|--|
| - (Original) | 11307145S-A | June 20, 2016 | - | - |
| 1 | 11307145S-A-R1 | July 1, 2016 | 1, 5 4 9 | Update of test specification Change of rating Addition of note |
| 2 | 11307145S-A-R2 | July 5, 2016 | 4 | Addition of clock frequency |
| | | | | |
| | | | | |
| | | | | |
| | | | | |
| | | | | |
| | | | | |
| | | | | |
| | | | | |
| | | | | |
| | | | | |
| | | | | |
| | | | | |
| | | | | |
| | | | | |
| | | | | |
| | | | | |
| | | | | |
| | | | | |
| | | | | |
| | | | | |
| | | | | |
| | | | | |
| | | | | |
| | | | | |
| | | | | |
| | | | | |
| | | | | |
| | | | | |
| | | | | |
| | | | | |
| | | | | |
| | | | | |
| | | | | |
| | | | | |

| CONTENTS | PAGE |
|---|-------------|
| SECTION 1: Customer information..... | 4 |
| SECTION 2: Equipment under test (E.U.T.)..... | 4 |
| SECTION 3: Test specification, procedures & results..... | 5 |
| SECTION 4: Operation of E.U.T. during testing..... | 8 |
| SECTION 5: Radiated Spurious Emission | 11 |
| SECTION 6: Antenna Terminal Conducted Tests..... | 12 |
| APPENDIX 1: Test data | 13 |
| 20dB Bandwidth and Carrier Frequency Separation..... | 13 |
| Number of Hopping Frequency | 16 |
| Dwell time..... | 18 |
| Maximum Peak Output Power | 21 |
| Average Output Power | 22 |
| Radiated Spurious Emission | 24 |
| Conducted Spurious Emission | 35 |
| Conducted Emission Band Edge compliance | 41 |
| 99%Occupied Bandwidth | 43 |
| APPENDIX 2: Test instruments | 45 |
| APPENDIX 3: Photographs of test setup | 46 |
| Radiated Spurious Emission | 46 |

SECTION 1: Customer information

Company Name : PIONEER CORPORATION
Address : 25-1, Yamada, Kawagoe-shi, Saitama-ken 350-8555, JAPAN
Telephone Number : +81-49-228-7787
Facsimile Number : +81-49-228-6493
Contact Person : Tomoyuki Tanaka

SECTION 2: Equipment under test (E.U.T.)

2.1 Identification of E.U.T.

Type of Equipment : Main Unit
Model No. : D171
Serial No. : Refer to Section 4, Clause 4.2
Rating : DC 12.0 V
Receipt Date of Sample : April 6, 2016
Country of Mass-production : Japan
Condition of EUT : Production prototype
(Not for Sale: This sample is equivalent to mass-produced items.)
Modification of EUT : No Modification by the test lab

2.2 Product Description

Model: D171 (referred to as the EUT in this report) is a Main Unit.

General Specification

Clock frequency(ies) in the system : Oscillator (Module) 32.768 kHz,
(System u-Com) 8 MHz
Internal Communication (Module) 195 MHz

Radio Specification

Radio Type : Transceiver
Frequency of Operation : 2402 MHz - 2480 MHz
Modulation : GFSK, π /4DQPSK, 8DPSK
Power Supply (radio part input) : DC 3.3 V / 1.8 V
Antenna type : Pattern inverted F type
Antenna Gain : 2.29 dBi (max)

SECTION 3: Test specification, procedures & results

3.1 Test Specification

Test Specification : FCC Part 15 Subpart C
FCC part 15 final revised on April 6, 2016.

Title : FCC 47CFR Part15 Radio Frequency Device Subpart C Intentional Radiators
Section 15.207 Conducted limits
Section 15.247 Operation within the bands 902-928MHz,
2400-2483.5MHz, and 5725-5850MHz

3.2 Procedures and results

| Item | Test Procedure | Specification | Worst Margin | Results | Remarks |
|--|---|--|--------------|---|-----------|
| Conducted Emission | FCC: ANSI C63.10-2013 6. Standard test methods ----- IC: RSS-Gen 8.8 | FCC: Section 15.207 ----- IC: RSS-Gen 8.8 | N/A | N/A | - |
| Carrier Frequency Separation | FCC: FCC Public Notice DA 00-705 ----- IC: - | FCC: Section15.247(a)(1) ----- IC: RSS-247 5.1 (2) | See data. | Complied | Conducted |
| 20dB Bandwidth | FCC: FCC Public Notice DA 00-705 ----- IC: - | FCC: Section15.247(a)(1) ----- IC: RSS-247 5.1 (1) | | - | Conducted |
| Number of Hopping Frequency | FCC: FCC Public Notice DA 00-705 ----- IC: - | FCC: Section15.247(a)(1)(iii) ----- IC: RSS-247 5.1 (4) | | Complied | Conducted |
| Dwell time | FCC: FCC Public Notice DA 00-705 ----- IC: - | FCC: Section15.247(a)(1)(iii) ----- IC: RSS-247 5.1 (4) | | Complied | Conducted |
| Maximum Peak Output Power | FCC: FCC Public Notice DA 00-705 ----- IC: RSS-Gen 6.12 | FCC: Section15.247(a)(b)(1) ----- IC: RSS-247 5.4 (2) | | Complied | Conducted |
| Spurious Emission & Band Edge Compliance | FCC: FCC Public Notice DA 00-705 ----- IC: RSS-Gen 6.13 | FCC: Section15.247(d) ----- IC: RSS-247 5.5 RSS-Gen 8.9 RSS-Gen 8.10 | | 9.2 dB 9608.000 MHz, AV, Vert. Tx, Hopping Off, DH5 2402 MHz | Complied |

Note: UL Japan, Inc.'s EMI Work Procedures No. 13-EM-W0420 and 13-EM-W0422.
*1) Radiated test was selected over 30 MHz based on section 15.247(d).

* In case any questions arise about test procedure, ANSI C63.10: 2013 is also referred.

FCC Part 15.31 (e)

The equipment provides the wireless transmitter with stable power supply (DC 3.3 V / 1.8 V). Instead of a new battery, DC power supply was used for the test. That does not affect the test result, therefore the EUT complies with the requirement.

FCC Part 15.203 Antenna requirement

It is impossible for end users to replace the antenna, because the antenna is mounted inside of the EUT. Therefore, the equipment complies with the antenna requirement of Section 15.203.

3.3 Addition to standard

| Item | Test Procedure | Specification | Worst margin | Results | Remarks |
|------------------------|-----------------|---------------|--------------|---------|-----------|
| 99% Occupied Bandwidth | IC: RSS-Gen 6.6 | IC: - | N/A | - | Conducted |

Other than above, no addition, exclusion nor deviation has been made from the standard.

3.4 Uncertainty

EMI

The following uncertainties have been calculated to provide a confidence level of 95 % using a coverage factor $k = 2$.
Shonan EMC Lab.

| Item | Frequency range | Uncertainty (+/-) | | | |
|--|-----------------|-------------------|----------------|----------------|----------------|
| | | No. 1 SAC / SR | No. 2 SAC / SR | No. 3 SAC / SR | No. 4 SAC / SR |
| Conducted emission (AC Mains) LISN | 150 kHz-30 MHz | 2.1 dB | 2.1 dB | 2.6 dB | 2.2 dB |
| Radiated emission (Measurement distance: 3 m) | 9 kHz-30 MHz | 2.7 dB | 2.7 dB | 3.1 dB | - |
| | 30 MHz-300 MHz | 4.4 dB | 4.4 dB | 4.6 dB | - |
| | 300 MHz-1 GHz | 5.6 dB | 5.5 dB | 5.3 dB | - |
| | 1 GHz-13 GHz | 5.2 dB | 5.2 dB | 5.2 dB | - |
| Radiated emission (Measurement distance: 1 m) | 13 GHz-18 GHz | 4.9 dB | 4.9 dB | 4.9 dB | - |
| | 18 GHz-40 GHz | 4.9 dB | 4.9 dB | 4.9 dB | - |

SAC=Semi-Anechoic Chamber

SR= Shielded Room is applied besides radiated emission

| Antenna terminal test | Uncertainty (+/-) |
|---|-------------------|
| Power Measurement above 1 GHz (Average Detector)_SPM-06 | 0.76 dB |
| Power Measurement above 1 GHz (Peak Detector)_SPM-06 | 0.79 dB |
| Power Measurement above 1 GHz (Average Detector)_SPM-07 | 0.74 dB |
| Power Measurement above 1 GHz (Peak Detector)_SPM-07 | 1.08 dB |
| Spurious emission (Conducted) below 1GHz | 1.5 dB |
| Spurious emission (Conducted) 1 GHz-3 GHz | 1.7 dB |
| Spurious emission (Conducted) 3 GHz-18 GHz | 2.4 dB |
| Spurious emission (Conducted) 18 GHz-26.5 GHz | 2.5 dB |
| Spurious emission (Conducted) 26.5 GHz-40 GHz | 2.5 dB |
| Bandwidth Measurement | 0.66 % |
| Duty cycle and Time Measurement | 0.012 % |

Radiated emission test

The data listed in this test report has enough margin, more than the site margin.

3.5 Test Location

UL Japan, Inc. Shonan EMC Lab.
1-22-3, Megumigaoka, Hiratsuka-shi, Kanagawa-ken 259-1220 JAPAN
Telephone: +81 463 50 6400, Facsimile: +81 463 50 6401
JAB Accreditation No. RTL02610

| Test site | IC Registration Number | Width x Depth x Height (m) | Size of reference ground plane (m) / horizontal conducting plane | Maximum measurement distance |
|----------------------------|------------------------|----------------------------|--|------------------------------|
| No.1 Semi-anechoic chamber | 2973D-1 | 20.6 x 11.3 x 7.65 | 20.6 x 11.3 | 10m |
| No.2 Semi-anechoic chamber | 2973D-2 | 20.6 x 11.3 x 7.65 | 20.6 x 11.3 | 10m |
| No.3 Semi-anechoic chamber | 2973D-3 | 12.7 x 7.7 x 5.35 | 12.7 x 7.7 | 5m |
| No.4 Semi-anechoic chamber | - | 8.1 x 5.1 x 3.55 | 8.1 x 5.1 | - |
| No.1 Shielded room | - | 6.8 x 4.1 x 2.7 | 6.8 x 4.1 | - |
| No.2 Shielded room | - | 6.8 x 4.1 x 2.7 | 6.8 x 4.1 | - |
| No.3 Shielded room | - | 6.3 x 4.7 x 2.7 | 6.3 x 4.7 | - |
| No.4 Shielded room | - | 4.4 x 4.7 x 2.7 | 4.4 x 4.7 | - |
| No.5 Shielded room | - | 7.8 x 6.4 x 2.7 | 7.8 x 6.4 | - |
| No.6 Shielded room | - | 7.8 x 6.4 x 2.7 | 7.8 x 6.4 | - |
| No.8 shielded room | - | 3.45 x 5.5 x 2.4 | 3.45 x 5.5 | - |
| No.1 Measurement room | - | 2.55 x 4.1 x 2.5 | - | - |

3.6 Test data, Test instruments, and Test set up

Refer to APPENDIX.

SECTION 4: Operation of E.U.T. during testing

4.1 Operating Mode(s)

Bluetooth (BT): Transmitting (Tx), Payload: PRBS9

Details of Operating Mode(s)

| Test Item | Mode | Tested frequency |
|---|---|----------------------------------|
| Conducted Emission, Spurious Emission (Conducted/Radiated) | Tx (Hopping Off) DH5, 3DH5 | 2402 MHz 2441 MHz 2480 MHz |
| Carrier Frequency Separation | Tx (Hopping On) DH5, 3DH5 | 2402 MHz 2441 MHz 2480 MHz |
| 20dB Bandwidth | Tx (Hopping Off) DH5, 3DH5 | 2402 MHz 2441 MHz 2480 MHz |
| Number of Hopping Frequency | Tx (Hopping On) DH5, 3DH5 | - |
| Dwell time | Tx (Hopping On), -DH1, DH3, DH5 -3DH1, 3DH3, 3DH5 | - |
| Maximum Peak Output Power | Tx (Hopping Off) DH5, 2DH5, 3DH5 | 2402 MHz 2441 MHz 2480 MHz |
| Band Edge Compliance (Conducted) | Tx DH5, 3DH5 -Hopping On -Hopping Off | 2402 MHz 2480 MHz |
| 99% Occupied Bandwidth | Tx DH5, 3DH5 -Hopping On -Hopping Off | 2402 MHz 2441 MHz 2480 MHz |
| <p>*As a result of preliminary test, the formal test was performed with the above modes, which had the maximum payload length (except Dwell time test)</p> <p>*2DH mode (2 Mb/s EDR: pi/4DQPSK) was excluded for other tests than power measurement by using 3DH mode (3 Mb/s EDR: 8DPSK) as a representative.</p> <p>* It is considered that the non-tested packet type (e.g. inquiry) can be omitted as it is complied with above all test items based on Bluetooth Core specification.</p> <p>*EUT has the power settings by the software as follows; Power settings: Table Index (Fixed) Software: BT: B080</p> <p>*This setting of software is the worst case. Any conditions under the normal use do not exceed the condition of setting. In addition, end users cannot change the settings of the output power of the product.</p> | | |

4.2 Configuration and peripherals

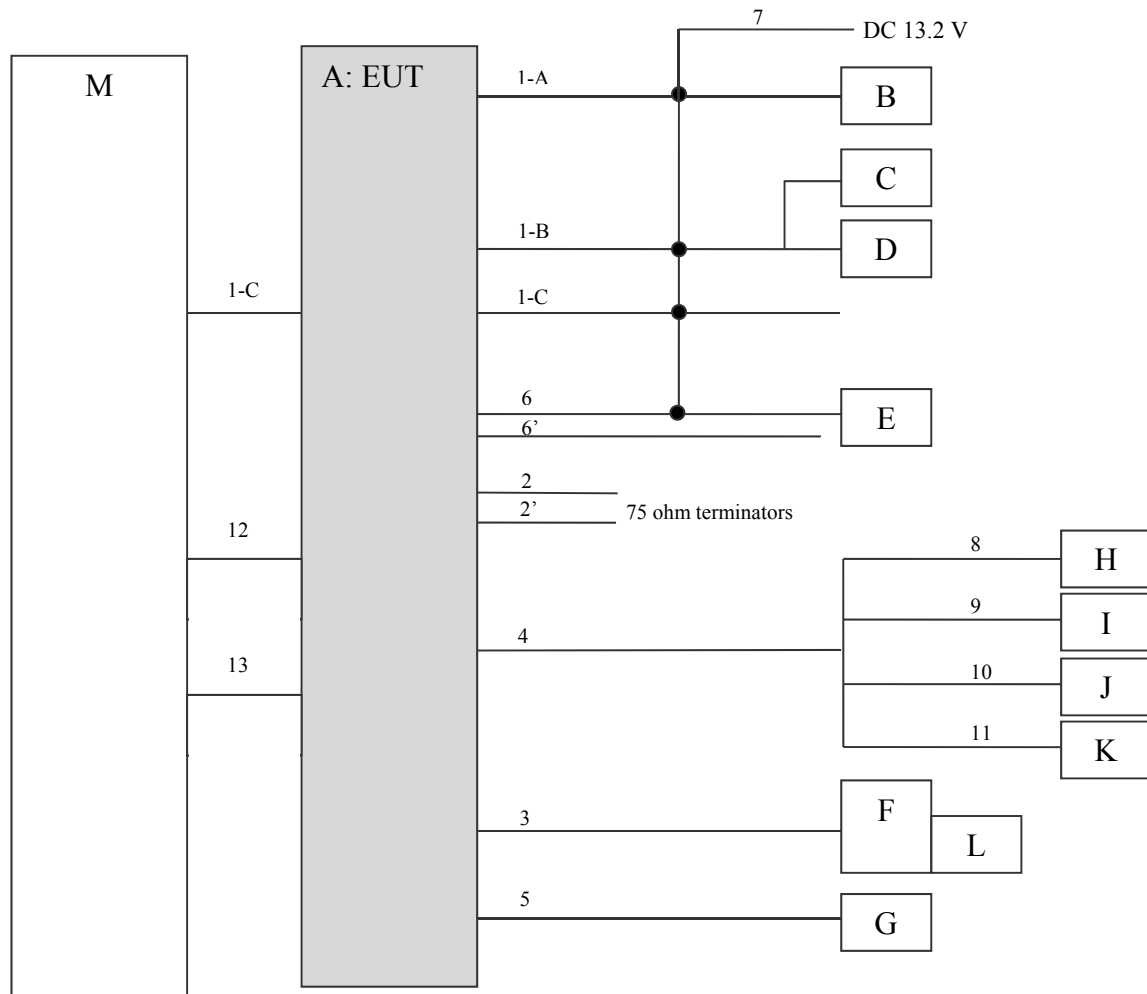

* Cabling and setup(s) were taken into consideration and test data was taken under worse case conditions.

* The testing was performed with DC 13.2 V only.

The voltage which the car battery mounted in the car outputs was selected as a test voltage according to the customer's request.

As the stable voltage (DC 3.3 V/ 1.8 V) is provided to RF module via the internal regulator, it does not influence on the test result.

Description of EUT and Support equipment

| No. | Item | Model number | Serial number | Manufacturer | Remarks |
|-----|-------------|--------------|--------------------------------------|--------------|---------|
| A | MAIN UNIT | D171 | PBPKTP0028CS *1) PBPKTP0053CS *2) | PIONEER | EUT |
| B | Steering SW | 75E921LH/RH | - | - | - |
| C | Mic | - | - | - | - |
| D | Rear Camera | - | - | - | - |
| E | Air-con ECU | - | - | DENSO | - |
| F | USB | - | - | - | - |
| G | GPS Antenna | 86860-71011 | - | AISIN | - |
| H | Speaker | LV-002 | S11014200775 | L&V | - |
| I | Speaker | LV-002 | S11014200775 | L&V | - |
| J | Speaker | LV-002 | S11014200773 | L&V | - |
| K | Speaker | LV-002 | S11014200773 | L&V | - |
| L | USB Memory | - | - | - | - |
| M | Display | - | - | PIONEER | - |

*1) Used for Antenna Terminal conducted test

*2) Used for Conducted Emission test and Radiated Emission test

List of cables used

| No. | Name | Length (m) | Shield | | Remarks |
|----------|----------------------------|------------|------------|------------|---------|
| | | | Cable | Connector | |
| 1-A | Wire Harness Set | 1.1 | Unshielded | Unshielded | - |
| 1-B | Wire Harness | 1.1 | Unshielded | Unshielded | - |
| 1-C | Wire Harness | 1.1 | Unshielded | Unshielded | - |
| 2, 2' | Radio antenna | 3.0 | Shielded | Shielded | - |
| 3 | USB connector | 1.1 | Shielded | Shielded | - |
| 4 | Speaker | 1.1 | Unshielded | Unshielded | - |
| 5 | GPS antenna connector | 1.5 | Shielded | Shielded | - |
| 6, 6' | Wire Harness (Air-con ECU) | 1.9 | Unshielded | Unshielded | - |
| 7 | DC | 3.0 | Shielded | Unshielded | - |
| 8 | Speaker | 1.9 | Unshielded | Unshielded | - |
| 9 | Speaker | 1.9 | Unshielded | Unshielded | - |
| 10 | Speaker | 1.9 | Unshielded | Unshielded | - |
| 11 | Speaker | 1.9 | Unshielded | Unshielded | - |
| 12 | Flat cable | 0.5 | Unshielded | Unshielded | - |
| 13 | Flat cable | 0.5 | Unshielded | Unshielded | - |

SECTION 5: Radiated Spurious Emission

Test Procedure

[For below 1 GHz]

EUT was placed on a urethane platform of nominal size, 1.0 m by 2.0 m, raised 0.8 m above the conducting ground plane. The Radiated Electric Field Strength has been measured in a Semi Anechoic Chamber with a ground plane.

[For above 1 GHz]

EUT was placed on a urethane platform of nominal size, 0.5 m by 0.5 m, raised 1.5 m above the conducting ground plane. The Radiated Electric Field Strength has been measured in a Semi Anechoic Chamber with absorbent materials lined on a ground plane.

The height of the measuring antenna varied between 1 and 4 m and EUT was rotated a full revolution in order to obtain the maximum value of the electric field strength.

The measurements were performed for both vertical and horizontal antenna polarization with the Test Receiver, or the Spectrum Analyzer.

The measurements were made with the following detector function of the test receiver and the Spectrum analyzer (in linear mode).

The test was made with the detector (RBW/VBW) in the following table.

When using Spectrum analyzer, the test was made with adjusting span to zero by using peak hold.

Test Antennas are used as below;

| | | | |
|--------------|-------------------|------------------|-------------|
| Frequency | 30 MHz to 300 MHz | 300 MHz to 1 GHz | Above 1 GHz |
| Antenna Type | Biconical | Logperiodic | Horn |

In any 100 kHz bandwidth outside the restricted band in which the spread spectrum intentional radiator is operating, the radio frequency power that is produced by the intentional radiator confirmed 20 dB below that in the 100 kHz bandwidth within the band that contains the highest level of the desired power, based on a radiated measurement.

20 dBc was applied to the frequency over the limit of FCC 15.209 / Table 4 of RSS-Gen 8.9 (IC) and outside the restricted band of FCC15.205 / Table 6 of RSS-Gen 8.10 (IC).

| | | | | |
|-----------------|---------------|---|------------------------------|---|
| Frequency | Below 1 GHz | Above 1 GHz | | 20 dBc |
| Instrument used | Test Receiver | Spectrum Analyzer | | Spectrum Analyzer |
| Detector | QP | PK | AV | PK |
| IF Bandwidth | BW 120 kHz | RBW: 1 MHz VBW: 3 MHz | RBW: 1 MHz VBW: 10 Hz *1) | RBW: 100 kHz VBW: 300 kHz |
| Test Distance | 3 m | 3 m*2) (1 GHz – 13 GHz), 1 m*3) (13 GHz – 26.5 GHz), | | 3 m*2) (1 GHz – 13 GHz), 1 m*3) (13 GHz – 26.5 GHz), |

*1) Although DA 00-705 accepts VBW = 10 Hz for AV measurements, it was confirmed that superfluous smoothing was not performed.

*2) Distance Factor: $20 \times \log(4.3 \text{ m}/3.0 \text{ m}) = 3.13 \text{ dB}$

*3) Distance Factor: $20 \times \log(1.0 \text{ m}/3.0 \text{ m}) = -9.5 \text{ dB}$

The carrier level and noise levels were confirmed at angle of 0 deg. to 30 deg. based on the product specification to see the position of maximum noise, and the test was made at the position (0 deg.) that has the maximum noise.

The test results and limit are rounded off to one decimal place, so some differences might be observed.

Measurement range : 30 MHz - 26.5 GHz
Test data : APPENDIX
Test result : Pass

UL Japan, Inc.
Shonan EMC Lab.

1-22-3 Megumigaoka, Hiratsuka-shi, Kanagawa-ken, 259-1220 JAPAN
Telephone : +81 463 50 6400
Facsimile : +81 463 50 6401

13-EM-F0429

SECTION 6: Antenna Terminal Conducted Tests

Test Procedure

The tests were made with below setting connected to the antenna port.

| Test | Span | RBW | VBW | Sweep time | Detector | Trace | Instrument used |
|--|---|-----------------|--------------------|--|------------------|--------------|---------------------------------|
| 20dB Bandwidth | 3 MHz | 30 kHz | 100 kHz | Auto | Peak | Max Hold | Spectrum Analyzer |
| 99% Occupied Bandwidth *1) | Enough width to display emission skirts | 1 to 5 % of OBW | Three times of RBW | Auto | Peak | Max Hold | Spectrum Analyzer |
| Maximum Peak Output Power | - | - | - | Auto | Peak Average *3) | - | Power Meter (Sensor: 50 MHz BW) |
| Carrier Frequency Separation | 3 MHz | 100 kHz | 300 kHz | Auto | Peak | Max Hold | Spectrum Analyzer |
| Number of Hopping Frequency | 30 MHz | 300 kHz | 1 MHz | Auto | Peak | Max Hold | Spectrum Analyzer |
| Dwell Time | Zero Span | 100 kHz, 1 MHz | 300 kHz, 3 MHz | As necessary capture the entire dwell time per hopping channel | Peak | Clear Write | Spectrum Analyzer |
| Conducted Spurious Emission *2) | 9 kHz to 150 kHz | 200 Hz | 620 Hz | Auto | Peak | Max Hold | Spectrum Analyzer |
| | 150 kHz to 30 MHz | 9.1 kHz | 27 kHz | | | | |
| | 30 MHz to 25 GHz | 100 kHz | 300 kHz | | | | |
| Conducted Spurious Emission Band Edge compliance | 10 MHz | 100 kHz | 300 kHz | Auto | Peak | Max Hold | Spectrum Analyzer |
| *1) Peak hold was applied as Worst-case measurement. *2) In the frequency range below 30 MHz, RBW was narrowed to separate the noise contents. Then, wide-band noise near the limit was checked separately, however the noise was not detected as shown in the chart. *3) Reference data | | | | | | | |

The test results and limit are rounded off to two decimals place, so some differences might be observed.

Test data : APPENDIX
Test result : Pass

APPENDIX 1: Test data

20dB Bandwidth and Carrier Frequency Separation

Test place Shonan EMC Lab. No.5 Shielded Room
Report No. 11307145S-A-R2
Date May 31, 2016
Temperature / Humidity 27 deg. C / 37 % RH
Engineer Wataru Kojima
Mode Tx, Hopping Off, DH5

| Mode | Freq. [MHz] | 20dB Bandwidth [MHz] | Carrier Frequency Separation [MHz] | Limit for Carrier Frequency separation [MHz] |
|------|----------------|-------------------------|--|--|
| DH5 | 2402.0 | 0.991 | 1.000 | >= 0.660 |
| DH5 | 2441.0 | 1.004 | 1.000 | >= 0.669 |
| DH5 | 2480.0 | 1.011 | 1.000 | >= 0.674 |
| 3DH5 | 2402.0 | 1.315 | 1.000 | >= 0.877 |
| 3DH5 | 2441.0 | 1.322 | 1.000 | >= 0.882 |
| 3DH5 | 2480.0 | 1.314 | 1.000 | >= 0.876 |

Limit: Two-thirds of 20dB Bandwidth or 25kHz (whichever is greater).

No limit applies to 20dB Bandwidth.

20dB Bandwidth and Carrier Frequency Separation

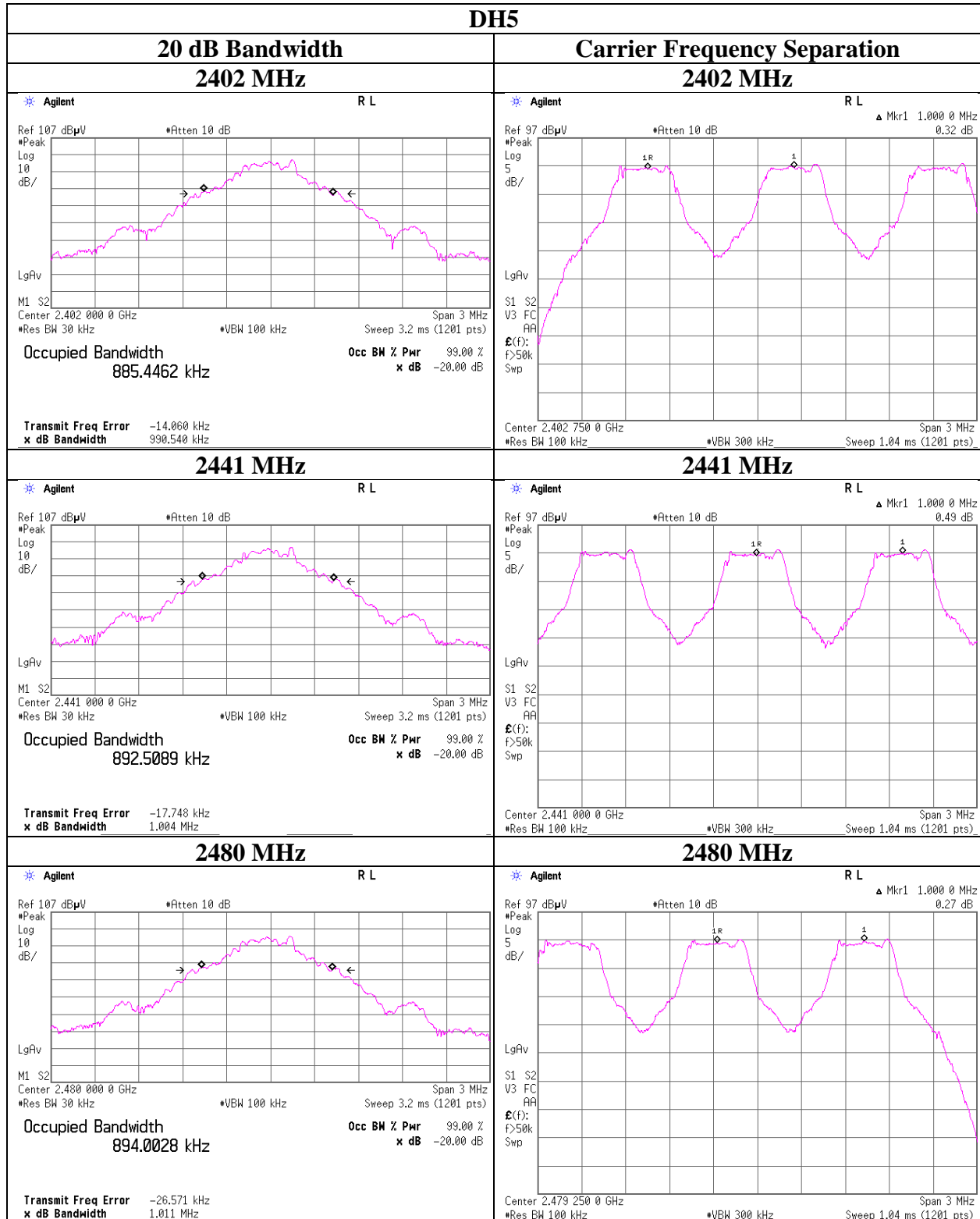

UL Japan, Inc.
Shonan EMC Lab.

1-22-3 Megumigaoka, Hiratsuka-shi, Kanagawa-ken, 259-1220 JAPAN
 Telephone : +81 463 50 6400
 Facsimile : +81 463 50 6401

20dB Bandwidth and Carrier Frequency Separation

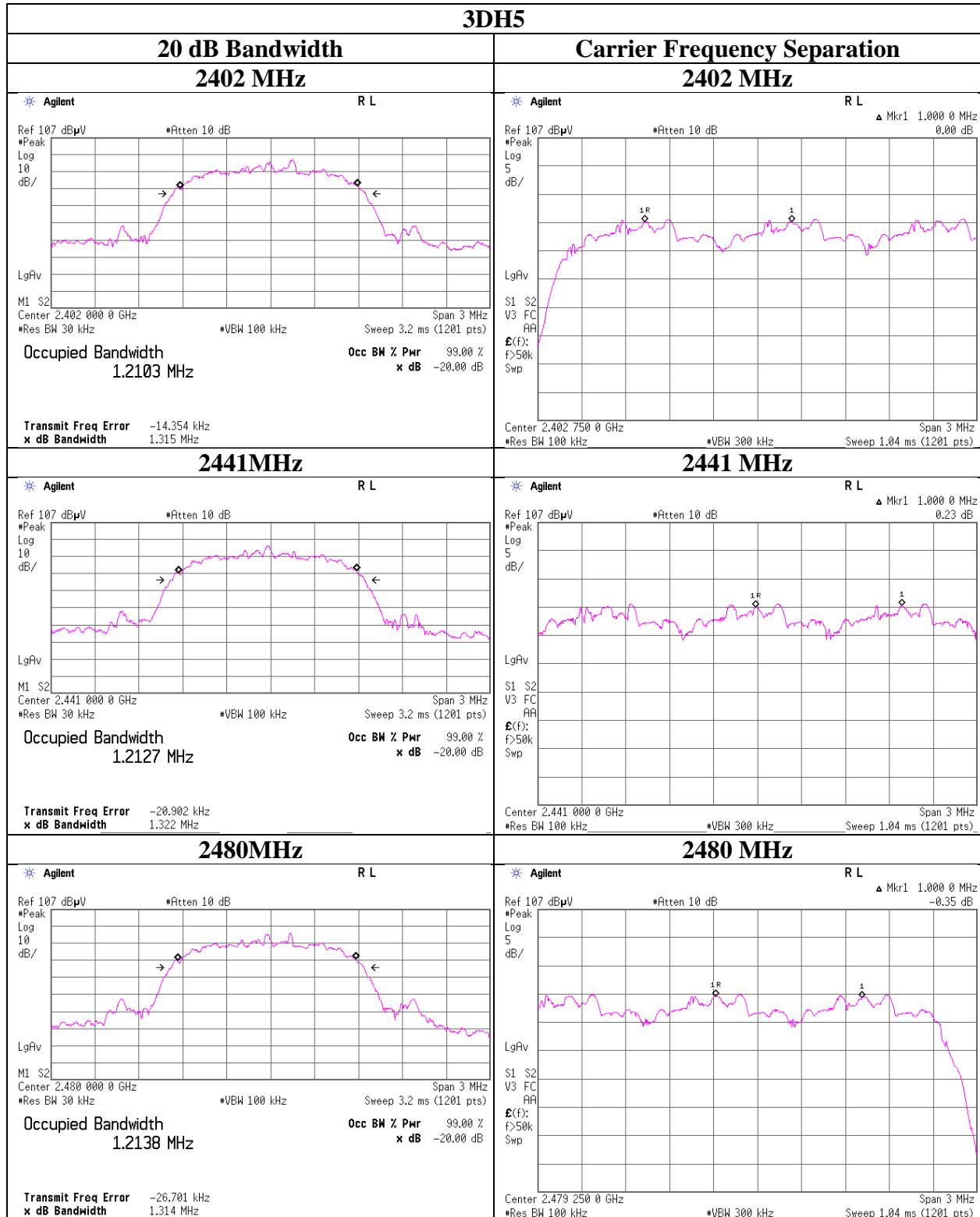

Number of Hopping Frequency

Test place Shonan EMC Lab. No.5 Shielded Room
Report No. 11307145S-A-R2
Date May 31, 2016
Temperature / Humidity 27 deg. C / 37 % RH
Engineer Wataru Kojima
Mode Tx, Hopping On

| Mode | Number of channel [channels] | Limit [channels] |
|------|---------------------------------|---------------------|
| DH5 | 79 | ≥ 15 |
| 3DH5 | 79 | ≥ 15 |

Test was not performed at AFH mode whose number of hopping channel is 20 channels because this Bluetooth radio is in compliance of Bluetooth Specification.

Number of Hopping Frequency

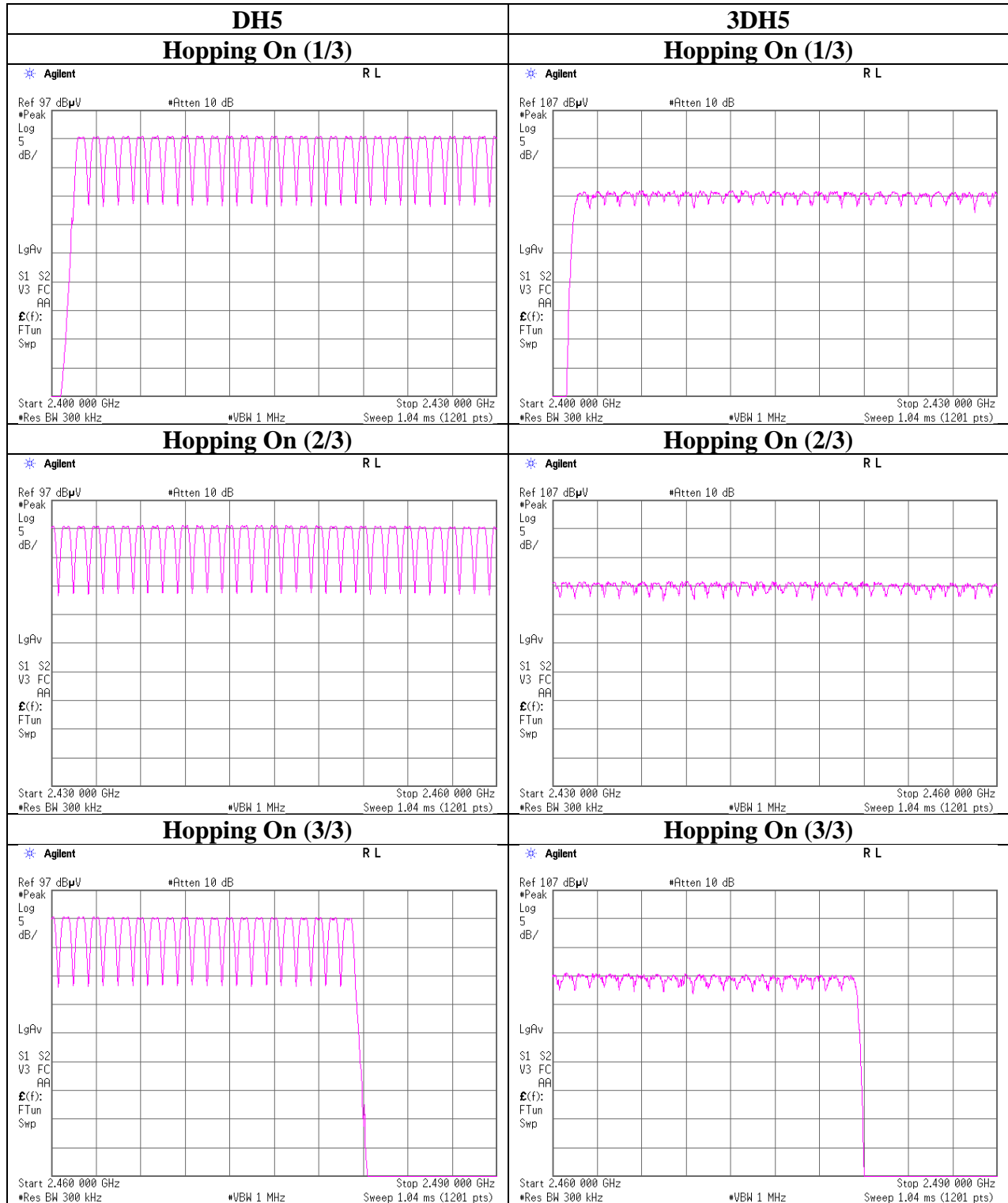

Dwell time

Test place Shonan EMC Lab. No.5 Shielded Room
Report No. 11307145S-A-R2
Date May 31, 2016
Temperature / Humidity 27 deg. C / 37 % RH
Engineer Wataru Kojima
Mode Tx, Hopping On

| Mode | Number of transmission in a 31.6(79 Hopping x 0.4) / 12.8 (32 Hopping x 0.4) second period | Length of transmission [msec] | Result [msec] | Limit [msec] |
|------|--|-------------------------------------|------------------|-----------------|
| DH1 | 49.0 times / 5 sec. x 31.6 sec. = 310 times | 0.419 | 130 | 400 |
| DH3 | 28.6 times / 5 sec. x 31.6 sec. = 181 times | 1.676 | 303 | 400 |
| DH5 | 19.4 times / 5 sec. x 31.6 sec. = 123 times | 2.927 | 360 | 400 |
| 3DH1 | 49.8 times / 5 sec. x 31.6 sec. = 315 times | 0.426 | 134 | 400 |
| 3DH3 | 26.8 times / 5 sec. x 31.6 sec. = 170 times | 1.677 | 285 | 400 |
| 3DH5 | 20.4 times / 5 sec. x 31.6 sec. = 129 times | 2.928 | 378 | 400 |

Sample Calculation

Result = Number of transmission x Length of transmission

*Average data of 5 tests.(except Inquiry)

| Mode | Sampling [times] | | | | | Average [times] |
|------|------------------|----|----|----|----|--------------------|
| | 1 | 2 | 3 | 4 | 5 | |
| DH1 | 47 | 51 | 48 | 49 | 50 | 49 |
| DH3 | 29 | 30 | 27 | 26 | 31 | 28.6 |
| DH5 | 22 | 18 | 16 | 20 | 21 | 19.4 |
| 3DH1 | 51 | 49 | 50 | 50 | 49 | 49.8 |
| 3DH3 | 27 | 28 | 25 | 26 | 28 | 26.8 |
| 3DH5 | 22 | 25 | 19 | 15 | 21 | 20.4 |

Sample Calculation

Average = Summation (Sampling 1 to 5) / 5

This device complies with the Bluetooth protocol for FHSS operation, employing a pseudo random channel selection and hopping rate to ensure that the occupancy time in $N \times 0.4s$, where N is the number of channels being used in the hopping sequence ($20 \leq N \leq 79$), is always less than $0.4s$ regardless of packet size. This is confirmed in the test report for $N = 79$.

Dwell time

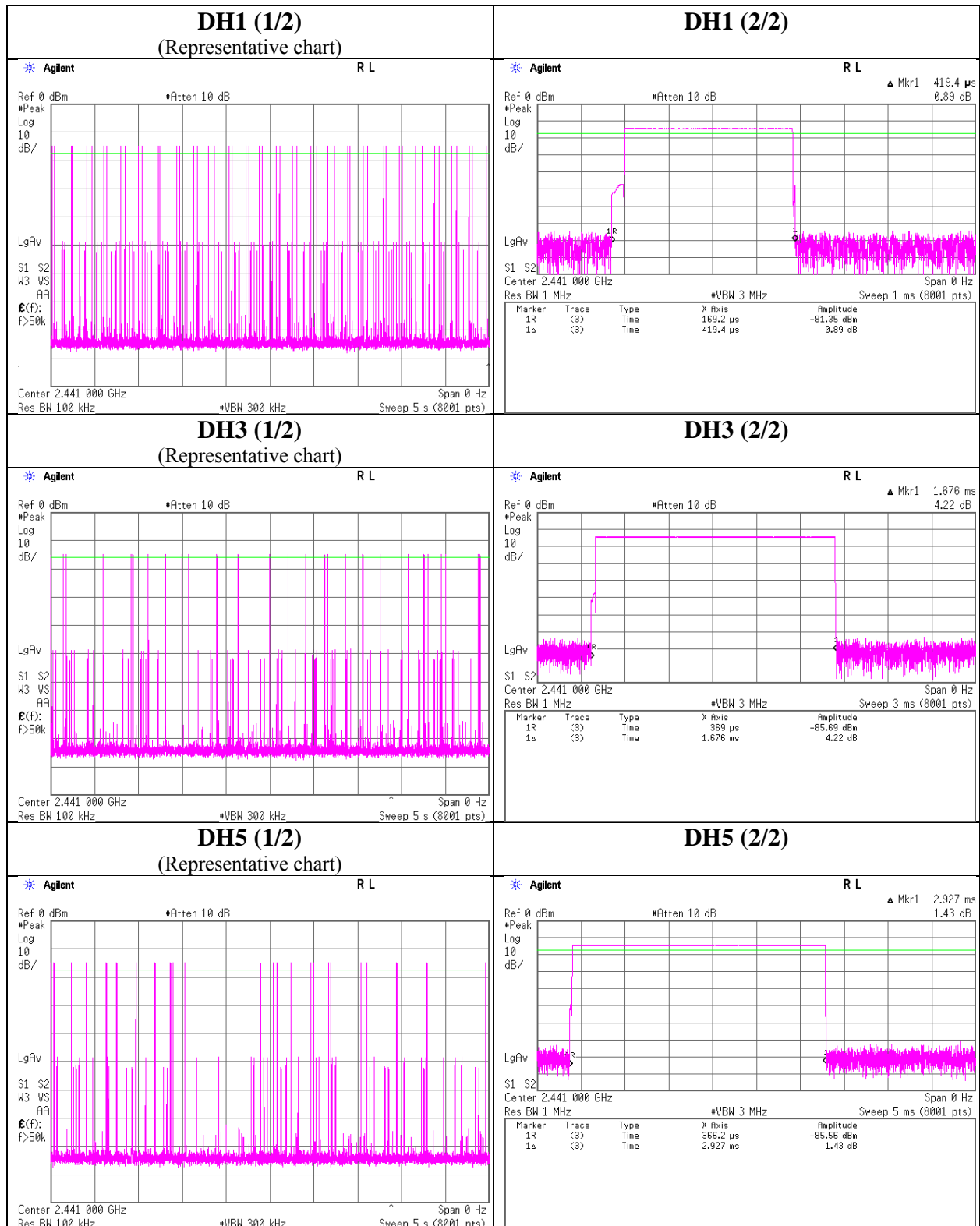

Dwell time

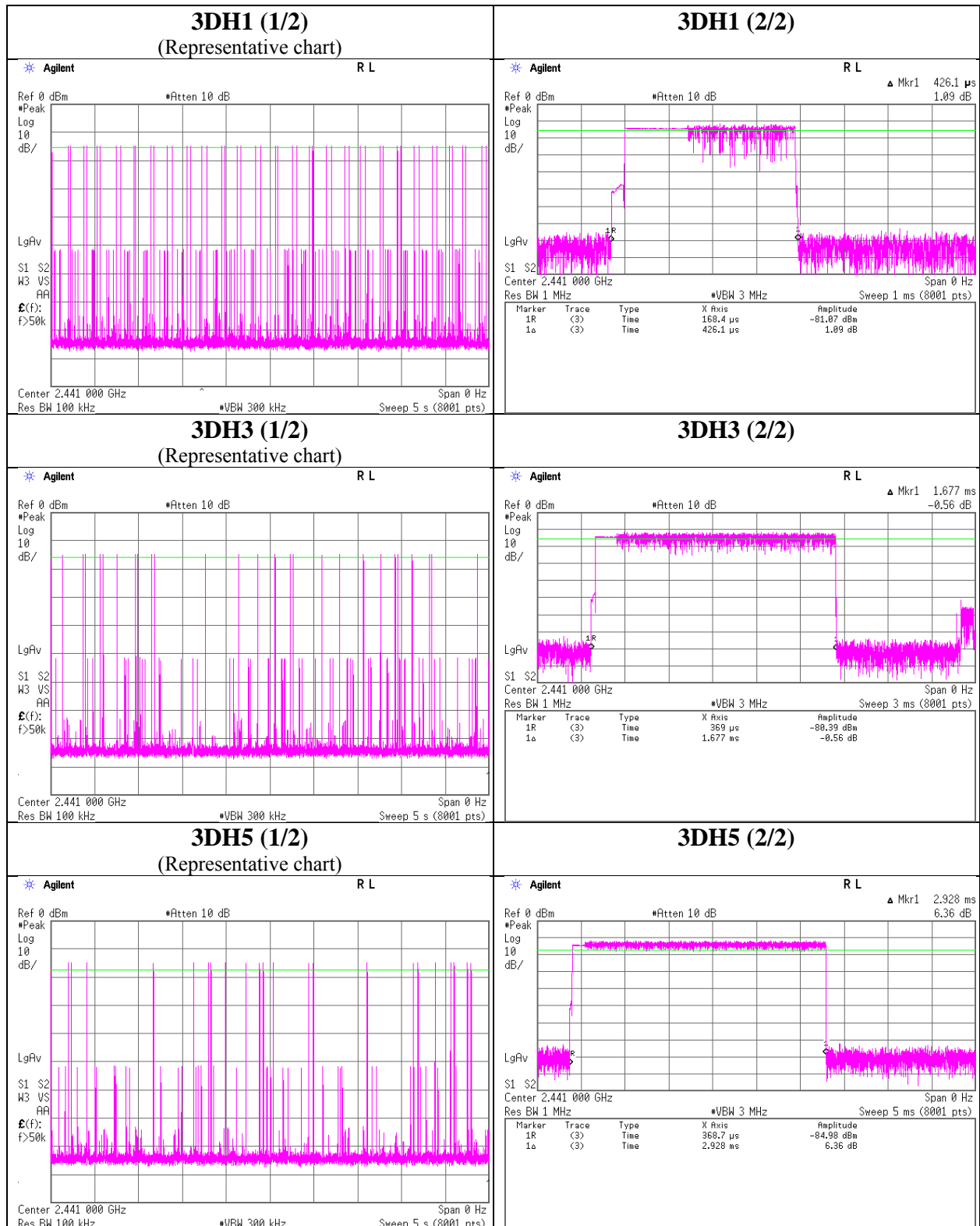

Maximum Peak Output Power

Test place Shonan EMC Lab. No.5 Shielded Room
Report No. 11307145S-A-R2
Date May 31, 2016
Temperature / Humidity 27 deg. C / 37 % RH
Engineer Wataru Kojima
Mode Tx, Hopping Off

| Mode | Freq. [MHz] | Reading [dBm] | Cable Loss [dB] | Atten. Loss [dB] | Result | | Limit | | Margin [dB] |
|------|----------------|------------------|-----------------------|------------------------|--------|------|-------|------|----------------|
| | | | | | [dBm] | [mW] | [dBm] | [mW] | |
| DH5 | 2402.0 | -11.80 | 2.10 | 9.67 | -0.03 | 0.99 | 20.96 | 125 | 20.99 |
| DH5 | 2441.0 | -11.98 | 2.07 | 9.67 | -0.24 | 0.95 | 20.96 | 125 | 21.20 |
| DH5 | 2480.0 | -12.69 | 2.09 | 9.67 | -0.93 | 0.81 | 20.96 | 125 | 21.89 |
| 2DH5 | 2402.0 | -9.50 | 2.10 | 9.67 | 2.27 | 1.69 | 20.96 | 125 | 18.69 |
| 2DH5 | 2441.0 | -9.67 | 2.07 | 9.67 | 2.07 | 1.61 | 20.96 | 125 | 18.89 |
| 2DH5 | 2480.0 | -10.53 | 2.09 | 9.67 | 1.23 | 1.33 | 20.96 | 125 | 19.73 |
| 3DH5 | 2402.0 | -9.20 | 2.10 | 9.67 | 2.57 | 1.81 | 20.96 | 125 | 18.39 |
| 3DH5 | 2441.0 | -9.46 | 2.07 | 9.67 | 2.28 | 1.69 | 20.96 | 125 | 18.68 |
| 3DH5 | 2480.0 | -10.28 | 2.09 | 9.67 | 1.48 | 1.41 | 20.96 | 125 | 19.48 |

Sample Calculation:

Result = Reading + Cable Loss (including the cable(s) customer supplied) + Attenuator Loss

*The equipment and cables were not used for factor 0 dB of the data sheets.

Test was not performed at AFH mode, because the decrease of number of channel (min: 20ch) at AFH mode does not influence on the output power and bandwidth of the EUT.

As this device had AFH mode and frequency separation could not meet the requirement of over 20dB BW without 2/3 relaxation, 125mW power limit was applied to it.

Average Output Power
(Reference data for RF Exposure)

Test place : Shonan EMC Lab. No.5 Shielded Room
Report No. : 11307145S-A-R2
Date : May 31, 2016
Temperature / Humidity : 27 deg. C / 37 % RH
Engineer : Wataru Kojima
Mode : Tx, Hopping Off

| Mode | Freq. [MHz] | Reading [dBm] | Cable Loss [dB] | Atten. Loss [dB] | Result (Frame power) | | Duty factor [dB] | Result (Burst power) | |
|------|----------------|------------------|-----------------------|------------------------|-------------------------|------|------------------------|-------------------------|------|
| | | | | | [dBm] | [mW] | | [dBm] | [mW] |
| DH5 | 2402.0 | -13.48 | 2.10 | 9.67 | -1.71 | 0.67 | 1.08 | -0.63 | 0.86 |
| DH5 | 2441.0 | -13.66 | 2.07 | 9.67 | -1.92 | 0.64 | 1.08 | -0.84 | 0.82 |
| DH5 | 2480.0 | -14.51 | 2.09 | 9.67 | -2.75 | 0.53 | 1.08 | -1.67 | 0.68 |
| 2DH5 | 2402.0 | -13.38 | 2.10 | 9.67 | -1.61 | 0.69 | 1.07 | -0.54 | 0.88 |
| 2DH5 | 2441.0 | -13.69 | 2.07 | 9.67 | -1.95 | 0.64 | 1.07 | -0.88 | 0.82 |
| 2DH5 | 2480.0 | -14.66 | 2.09 | 9.67 | -2.90 | 0.51 | 1.07 | -1.83 | 0.66 |
| 3DH5 | 2402.0 | -13.38 | 2.10 | 9.67 | -1.61 | 0.69 | 1.07 | -0.54 | 0.88 |
| 3DH5 | 2441.0 | -13.70 | 2.07 | 9.67 | -1.96 | 0.64 | 1.07 | -0.89 | 0.81 |
| 3DH5 | 2480.0 | -14.47 | 2.09 | 9.67 | -2.71 | 0.54 | 1.07 | -1.64 | 0.69 |

Sample Calculation:

Result (Frame power) = Reading + Cable Loss (including the cable(s) customer supplied) + Attenuator Loss

Result (Burst power) = Frame power + Duty factor

*The equipment and cables were not used for factor 0 dB of the data sheets.

Burst Rate Confirmation

| | |
|------------------------|------------------------------------|
| Test place | Shonan EMC Lab. No.5 Shielded Room |
| Report No. | 11307145S-A-R2 |
| Date | May 31, 2016 |
| Temperature / Humidity | 27 deg. C / 37 % RH |
| Engineer | Wataru Kojima |
| Mode | Tx, Hopping Off |

DH5

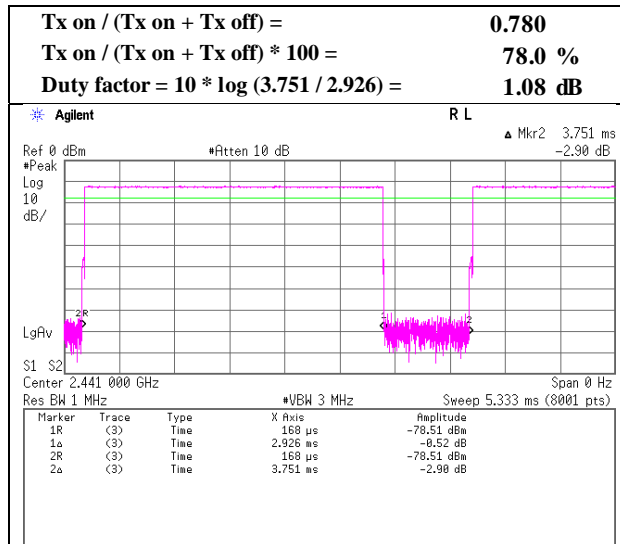

2DH5

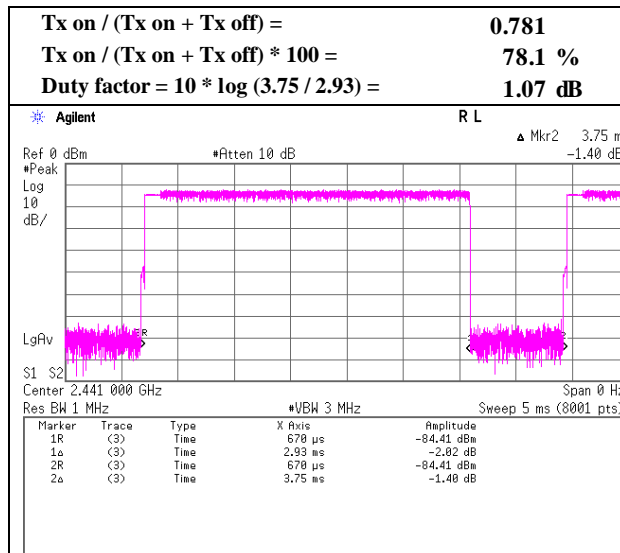

3DH5

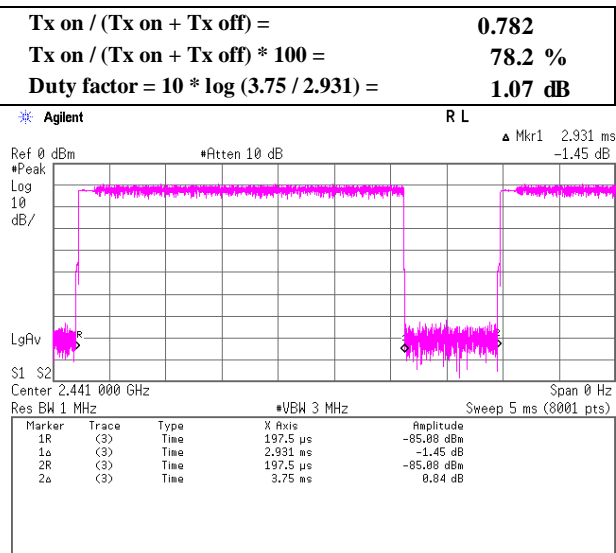

Radiated Spurious Emission

| | | |
|------------------------|--|---------------------|
| Test place | Shonan EMC Lab. No.3 Semi Anechoic Chamber | |
| Report No. | 11307145S-A-R2 | |
| Date | June 7, 2016 | June 8, 2016 |
| Temperature / Humidity | 23 deg. C / 47 % RH | 22 deg. C / 54 % RH |
| Engineer | Makoto Hosaka | Wataru Kojima |
| | (30-1000MHz, 18-26.5GHz) (1-13GHz, 13-18GHz) | |
| Mode | Tx, Hopping Off, DH5 2402 MHz | |

(* PK: Peak, AV: Average, QP: Quasi-Peak)

| Polarity | Frequency [MHz] | Detector | Reading [dBuV] | Ant.Fac. [dB/m] | Loss [dB] | Gain [dB] | Distance Factor [dB] | Result [dBuV/m] | Limit [dBuV/m] | Margin [dB] | Height [cm] | Angle [deg] | Remark |
|----------|-----------------|----------|----------------|-----------------|-----------|-----------|----------------------|-----------------|----------------|-------------|-------------|-------------|--------|
| Hori. | 148.028 | QP | 32.1 | 14.5 | 7.8 | 32.1 | 0.0 | 22.3 | 43.5 | 21.2 | 220 | 127 | |
| Hori. | 185.035 | QP | 33.6 | 16.0 | 8.0 | 32.1 | 0.0 | 25.5 | 43.5 | 18.0 | 246 | 228 | |
| Hori. | 259.049 | QP | 32.5 | 17.5 | 8.5 | 32.0 | 0.0 | 26.5 | 46.0 | 19.5 | 133 | 244 | |
| Hori. | 333.062 | QP | 31.7 | 14.6 | 8.9 | 31.9 | 0.0 | 23.3 | 46.0 | 22.7 | 100 | 240 | |
| Hori. | 370.068 | QP | 31.2 | 15.4 | 9.0 | 31.9 | 0.0 | 23.7 | 46.0 | 22.3 | 100 | 244 | |
| Hori. | 2390.000 | PK | 46.0 | 27.8 | 13.8 | 41.0 | 3.1 | 49.7 | 73.9 | 24.2 | 147 | 76 | |
| Hori. | 4804.000 | PK | 46.9 | 31.4 | 5.8 | 39.6 | 3.1 | 47.6 | 73.9 | 26.3 | 150 | 0 | |
| Hori. | 7206.000 | PK | 46.2 | 36.9 | 7.1 | 40.1 | 3.1 | 53.2 | 73.9 | 20.7 | 150 | 0 | |
| Hori. | 9608.000 | PK | 45.5 | 38.5 | 8.1 | 39.6 | 3.1 | 55.6 | 73.9 | 18.3 | 150 | 0 | |
| Hori. | 2390.000 | AV | 33.9 | 27.8 | 13.8 | 41.0 | 3.1 | 37.6 | 53.9 | 16.3 | 147 | 76 | |
| Hori. | 4804.000 | AV | 35.5 | 31.4 | 5.8 | 39.6 | 3.1 | 36.2 | 53.9 | 17.7 | 150 | 0 | |
| Hori. | 7206.000 | AV | 35.3 | 36.9 | 7.1 | 40.1 | 3.1 | 42.3 | 53.9 | 11.6 | 150 | 0 | |
| Hori. | 9608.000 | AV | 33.9 | 38.5 | 8.1 | 39.6 | 3.1 | 44.0 | 53.9 | 9.9 | 150 | 0 | |
| Vert. | 37.007 | QP | 30.0 | 15.0 | 6.8 | 32.2 | 0.0 | 19.6 | 40.0 | 20.4 | 100 | 175 | |
| Vert. | 111.021 | QP | 32.6 | 11.3 | 7.5 | 32.1 | 0.0 | 19.3 | 43.5 | 24.2 | 100 | 262 | |
| Vert. | 148.028 | QP | 32.6 | 14.5 | 7.8 | 32.1 | 0.0 | 22.8 | 43.5 | 20.7 | 100 | 42 | |
| Vert. | 180.014 | QP | 30.0 | 15.9 | 8.0 | 32.1 | 0.0 | 21.8 | 43.5 | 21.7 | 100 | 179 | |
| Vert. | 185.035 | QP | 33.1 | 16.0 | 8.0 | 32.1 | 0.0 | 25.0 | 43.5 | 18.5 | 100 | 10 | |
| Vert. | 618.236 | QP | 21.6 | 19.2 | 10.1 | 31.9 | 0.0 | 19.0 | 46.0 | 27.0 | 100 | 182 | |
| Vert. | 2390.000 | PK | 45.9 | 27.8 | 13.8 | 41.0 | 3.1 | 49.6 | 73.9 | 24.3 | 181 | 315 | |
| Vert. | 4804.000 | PK | 47.0 | 31.4 | 5.8 | 39.6 | 3.1 | 47.7 | 73.9 | 26.2 | 150 | 0 | |
| Vert. | 7206.000 | PK | 46.6 | 36.9 | 7.1 | 40.1 | 3.1 | 53.6 | 73.9 | 20.3 | 150 | 0 | |
| Vert. | 9608.000 | PK | 45.9 | 38.5 | 8.1 | 39.6 | 3.1 | 56.0 | 73.9 | 17.9 | 150 | 0 | |
| Vert. | 2390.000 | AV | 33.8 | 27.8 | 13.8 | 41.0 | 3.1 | 37.5 | 53.9 | 16.4 | 181 | 315 | |
| Vert. | 4804.000 | AV | 35.5 | 31.4 | 5.8 | 39.6 | 3.1 | 36.2 | 53.9 | 17.7 | 150 | 0 | |
| Vert. | 7206.000 | AV | 35.3 | 36.9 | 7.1 | 40.1 | 3.1 | 42.3 | 53.9 | 11.6 | 150 | 0 | |
| Vert. | 9608.000 | AV | 34.6 | 38.5 | 8.1 | 39.6 | 3.1 | 44.7 | 53.9 | 9.2 | 150 | 0 | |

Result = Reading + Ant.Fac. + Loss (Cable+(Attenuator or Filter)(below 18 GHz)) - Gain(Amplifier) + Distance factor

Distance factor : 1 GHz - 13 GHz : 20log(4.3 m / 3.0 m) = 3.13 dB

13 GHz - 40 GHz : 20log(1.0 m / 3.0 m) = -9.5 dB

*These results have sufficient margin without taking account Dwell time factor.

20 dBc Data Sheet (RBW 100 kHz, VBW 300 kHz)

| Polarity | Frequency [MHz] | Detector | Reading [dBuV] | Ant.Fac. [dB/m] | Loss [dB] | Gain [dB] | Distance Factor [dB] | Result [dBuV/m] | Limit [dBuV/m] | Margin [dB] | Remark |
|----------|-----------------|----------|----------------|-----------------|-----------|-----------|----------------------|-----------------|----------------|-------------|---------|
| Hori. | 2402.000 | PK | 85.4 | 27.8 | 13.8 | 41.0 | 3.1 | 89.1 | - | - | Carrier |
| Hori. | 2400.000 | PK | 36.8 | 27.8 | 13.8 | 41.0 | 3.1 | 40.5 | 69.1 | 28.6 | |
| Vert. | 2402.000 | PK | 86.7 | 27.8 | 13.8 | 41.0 | 3.1 | 90.4 | - | - | Carrier |
| Vert. | 2400.000 | PK | 36.8 | 27.8 | 13.8 | 41.0 | 3.1 | 40.5 | 70.4 | 29.9 | |

Result = Reading + Ant.Fac. + Loss (Cable+(Attenuator or Filter)(below 18 GHz)) - Gain(Amplifier) + Distance factor

Distance factor : 1 GHz - 13 GHz : 20log(4.3 m / 3.0 m) = 3.13 dB

13 GHz - 40 GHz : 20log(1.0 m / 3.0 m) = -9.5 dB

Radiated Spurious Emission (Reference Plot for band-edge)

| | |
|------------------------|--|
| Test place | Shonan EMC Lab. No.3 Semi Anechoic Chamber |
| Report No. | 11307145S-A-R2 |
| Date | June 8, 2016 |
| Temperature / Humidity | 22 deg. C / 54 % RH |
| Engineer | Wataru Kojima (1-13GHz) |
| Mode | Tx, Hopping Off, DH5 2402 MHz |

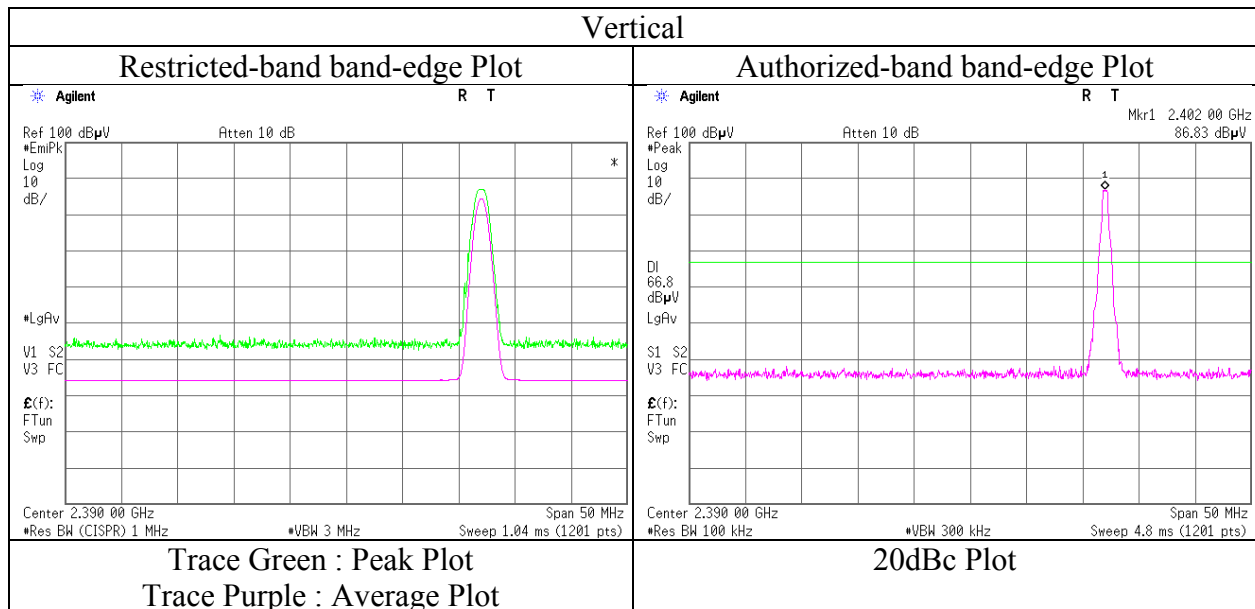
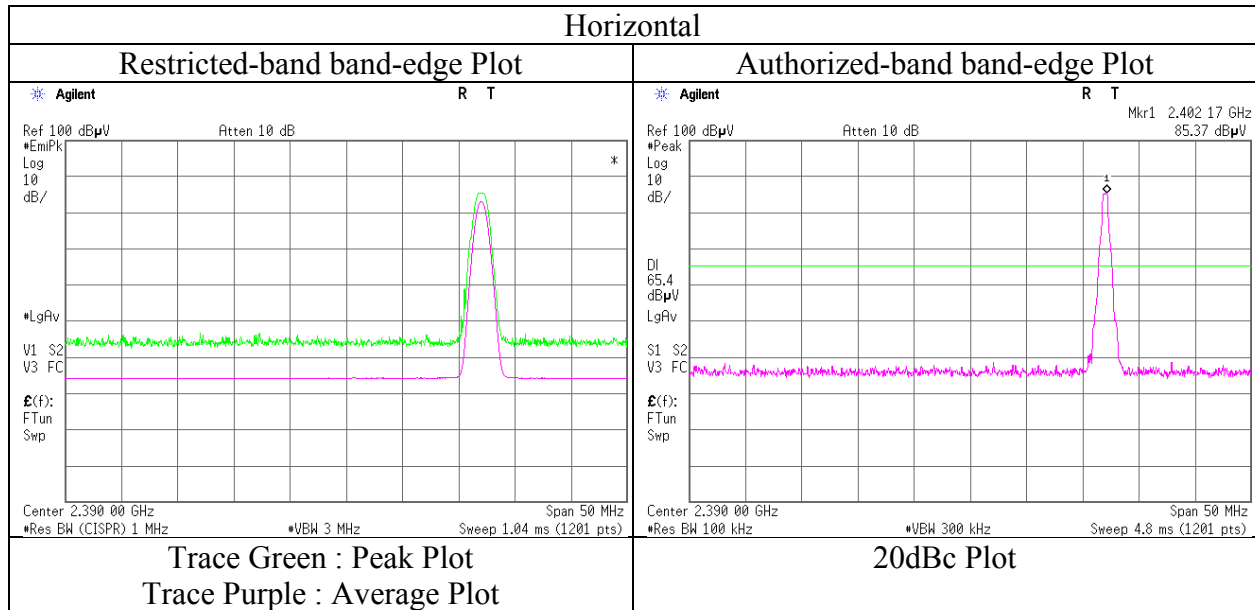

* Final result of restricted band edge was shown in tabular data.

Radiated Spurious Emission

| | | |
|------------------------|--|---------------------|
| Test place | Shonan EMC Lab. No.3 Semi Anechoic Chamber | |
| Report No. | 11307145S-A-R2 | |
| Date | June 7, 2016 | June 8, 2016 |
| Temperature / Humidity | 23 deg. C / 47 % RH | 22 deg. C / 54 % RH |
| Engineer | Makoto Hosaka | Wataru Kojima |
| | (30-1000MHz, 18-26.5GHz) (1-13GHz, 13-18GHz) | |
| Mode | Tx, Hopping Off, DH5 2441 MHz | |

(* PK: Peak, AV: Average, QP: Quasi-Peak)

| Polarity | Frequency [MHz] | Detector | Reading [dBuV] | Ant.Fac. [dB/m] | Loss [dB] | Gain [dB] | Distance Factor [dB] | Result [dBuV/m] | Limit [dBuV/m] | Margin [dB] | Height [cm] | Angle [deg] | Remark |
|----------|-----------------|----------|----------------|-----------------|-----------|-----------|----------------------|-----------------|----------------|-------------|-------------|-------------|--------|
| Hori. | 127.997 | QP | 30.6 | 13.2 | 7.6 | 32.1 | 0.0 | 19.3 | 43.5 | 24.2 | 262 | 78 | |
| Hori. | 147.996 | QP | 31.3 | 14.5 | 7.8 | 32.1 | 0.0 | 21.5 | 43.5 | 22.0 | 222 | 120 | |
| Hori. | 185.003 | QP | 32.8 | 16.0 | 8.0 | 32.1 | 0.0 | 24.7 | 43.5 | 18.8 | 254 | 242 | |
| Hori. | 259.048 | QP | 33.5 | 17.5 | 8.5 | 32.0 | 0.0 | 27.5 | 46.0 | 18.5 | 183 | 122 | |
| Hori. | 333.062 | QP | 30.4 | 14.6 | 8.9 | 31.9 | 0.0 | 22.0 | 46.0 | 24.0 | 100 | 252 | |
| Hori. | 370.069 | QP | 33.8 | 15.4 | 9.0 | 31.9 | 0.0 | 26.3 | 46.0 | 19.7 | 162 | 79 | |
| Hori. | 4882.000 | PK | 46.3 | 31.7 | 5.9 | 39.5 | 3.1 | 47.5 | 73.9 | 26.4 | 150 | 0 | |
| Hori. | 7323.000 | PK | 46.0 | 36.9 | 7.2 | 40.2 | 3.1 | 53.0 | 73.9 | 20.9 | 150 | 0 | |
| Hori. | 9764.000 | PK | 45.6 | 38.5 | 8.1 | 39.5 | 3.1 | 55.8 | 73.9 | 18.1 | 150 | 0 | |
| Hori. | 4882.000 | AV | 35.2 | 31.7 | 5.9 | 39.5 | 3.1 | 36.4 | 53.9 | 17.5 | 150 | 0 | |
| Hori. | 7323.000 | AV | 33.5 | 36.9 | 7.2 | 40.2 | 3.1 | 40.5 | 53.9 | 13.4 | 150 | 0 | |
| Hori. | 9764.000 | AV | 32.1 | 38.5 | 8.1 | 39.5 | 3.1 | 42.3 | 53.9 | 11.6 | 150 | 0 | |
| Vert. | 37.007 | QP | 30.0 | 15.0 | 6.8 | 32.2 | 0.0 | 19.6 | 40.0 | 20.4 | 100 | 152 | |
| Vert. | 111.022 | QP | 32.5 | 11.3 | 7.5 | 32.1 | 0.0 | 19.2 | 43.5 | 24.3 | 100 | 270 | |
| Vert. | 148.028 | QP | 32.8 | 14.5 | 7.8 | 32.1 | 0.0 | 23.0 | 43.5 | 20.5 | 100 | 24 | |
| Vert. | 180.006 | QP | 30.1 | 15.9 | 8.0 | 32.1 | 0.0 | 21.9 | 43.5 | 21.6 | 100 | 178 | |
| Vert. | 185.034 | QP | 33.1 | 16.0 | 8.0 | 32.1 | 0.0 | 25.0 | 43.5 | 18.5 | 100 | 14 | |
| Vert. | 4882.000 | PK | 46.4 | 31.7 | 5.9 | 39.5 | 3.1 | 47.6 | 73.9 | 26.3 | 150 | 0 | |
| Vert. | 7323.000 | PK | 45.7 | 36.9 | 7.2 | 40.2 | 3.1 | 52.7 | 73.9 | 21.2 | 150 | 0 | |
| Vert. | 9764.000 | PK | 44.5 | 38.5 | 8.1 | 39.5 | 3.1 | 54.7 | 73.9 | 19.2 | 150 | 0 | |
| Vert. | 4882.000 | AV | 33.8 | 31.7 | 5.9 | 39.5 | 3.1 | 35.0 | 53.9 | 18.9 | 150 | 0 | |
| Vert. | 7323.000 | AV | 33.5 | 36.9 | 7.2 | 40.2 | 3.1 | 40.5 | 53.9 | 13.4 | 150 | 0 | |
| Vert. | 9764.000 | AV | 32.1 | 38.5 | 8.1 | 39.5 | 3.1 | 42.3 | 53.9 | 11.6 | 150 | 0 | |

Result = Reading + Ant.Fac. + Loss (Cable+(Attenuator or Filter)(below 18 GHz)) - Gain(Amplifier) + Distance factor

Distance factor : 1 GHz - 13 GHz : $20\log(4.3\text{ m} / 3.0\text{ m}) = 3.13\text{ dB}$

13 GHz - 40 GHz : $20\log(1.0\text{ m} / 3.0\text{ m}) = -9.5\text{ dB}$

* These results have sufficient margin without taking account Dwell time factor.

Radiated Spurious Emission

Test place : Shonan EMC Lab. No.3 Semi Anechoic Chamber
Report No. : 11307145S-A-R2
Date : June 7, 2016 June 8, 2016
Temperature / Humidity : 23 deg. C / 47 % RH 22 deg. C / 54 % RH
Engineer : Makoto Hosaka Wataru Kojima
 (30-1000MHz, 18-26.5GHz) (1-13GHz, 13-18GHz)
Mode : Tx, Hopping Off, DH5 2480 MHz

(* PK: Peak, AV: Average, QP: Quasi-Peak)

| Polarity | Frequency [MHz] | Detector | Reading [dBuV] | Ant.Fac. [dB/m] | Loss [dB] | Gain [dB] | Distance Factor [dB] | Result [dBuV/m] | Limit [dBuV/m] | Margin [dB] | Height [cm] | Angle [deg] | Remark |
|----------|-----------------|----------|----------------|-----------------|-----------|-----------|----------------------|-----------------|----------------|-------------|-------------|-------------|--------|
| Hori. | 138.776 | QP | 30.9 | 14.0 | 7.7 | 32.1 | 0.0 | 20.5 | 43.5 | 23.0 | 342 | 94 | |
| Hori. | 148.028 | QP | 32.2 | 14.5 | 7.8 | 32.1 | 0.0 | 22.4 | 43.5 | 21.1 | 218 | 103 | |
| Hori. | 185.034 | QP | 33.8 | 16.0 | 8.0 | 32.1 | 0.0 | 25.7 | 43.5 | 17.8 | 256 | 239 | |
| Hori. | 259.048 | QP | 33.9 | 17.5 | 8.5 | 32.0 | 0.0 | 27.9 | 46.0 | 18.1 | 139 | 117 | |
| Hori. | 333.062 | QP | 32.4 | 14.6 | 8.9 | 31.9 | 0.0 | 24.0 | 46.0 | 22.0 | 111 | 245 | |
| Hori. | 370.069 | QP | 32.0 | 15.4 | 9.0 | 31.9 | 0.0 | 24.5 | 46.0 | 21.5 | 150 | 71 | |
| Hori. | 2483.500 | PK | 45.9 | 27.9 | 13.9 | 41.0 | 3.1 | 49.8 | 73.9 | 24.1 | 234 | 300 | |
| Hori. | 4960.000 | PK | 46.7 | 32.0 | 5.9 | 39.4 | 3.1 | 48.3 | 73.9 | 25.6 | 150 | 0 | |
| Hori. | 7440.000 | PK | 46.4 | 37.0 | 7.3 | 40.4 | 3.1 | 53.4 | 73.9 | 20.5 | 150 | 0 | |
| Hori. | 9920.000 | PK | 44.4 | 38.4 | 8.2 | 39.4 | 3.1 | 54.7 | 73.9 | 19.2 | 150 | 0 | |
| Hori. | 2483.500 | AV | 32.3 | 27.9 | 13.9 | 41.0 | 3.1 | 36.2 | 53.9 | 17.7 | 234 | 300 | |
| Hori. | 4960.000 | AV | 34.6 | 32.0 | 5.9 | 39.4 | 3.1 | 36.2 | 53.9 | 17.7 | 150 | 0 | |
| Hori. | 7440.000 | AV | 34.1 | 37.0 | 7.3 | 40.4 | 3.1 | 41.1 | 53.9 | 12.8 | 150 | 0 | |
| Hori. | 9920.000 | AV | 32.3 | 38.4 | 8.2 | 39.4 | 3.1 | 42.6 | 53.9 | 11.3 | 150 | 0 | |
| Vert. | 37.007 | QP | 30.1 | 15.0 | 6.8 | 32.2 | 0.0 | 19.7 | 40.0 | 20.3 | 100 | 164 | |
| Vert. | 74.014 | QP | 33.6 | 5.9 | 7.2 | 32.2 | 0.0 | 14.5 | 40.0 | 25.5 | 167 | 217 | |
| Vert. | 111.021 | QP | 32.9 | 11.3 | 7.5 | 32.1 | 0.0 | 19.6 | 43.5 | 23.9 | 100 | 272 | |
| Vert. | 148.028 | QP | 32.4 | 14.5 | 7.8 | 32.1 | 0.0 | 22.6 | 43.5 | 20.9 | 100 | 33 | |
| Vert. | 180.014 | QP | 30.3 | 15.9 | 8.0 | 32.1 | 0.0 | 22.1 | 43.5 | 21.4 | 100 | 173 | |
| Vert. | 185.035 | QP | 32.9 | 16.0 | 8.0 | 32.1 | 0.0 | 24.8 | 43.5 | 18.7 | 100 | 14 | |
| Vert. | 2483.500 | PK | 45.4 | 27.9 | 13.9 | 41.0 | 3.1 | 49.3 | 73.9 | 24.6 | 173 | 314 | |
| Vert. | 4960.000 | PK | 46.4 | 32.0 | 5.9 | 39.4 | 3.1 | 48.0 | 73.9 | 25.9 | 150 | 0 | |
| Vert. | 7440.000 | PK | 46.7 | 37.0 | 7.3 | 40.4 | 3.1 | 53.7 | 73.9 | 20.2 | 150 | 0 | |
| Vert. | 9920.000 | PK | 44.5 | 38.4 | 8.2 | 39.4 | 3.1 | 54.8 | 73.9 | 19.1 | 150 | 0 | |
| Vert. | 2483.500 | AV | 33.8 | 27.9 | 13.9 | 41.0 | 3.1 | 37.7 | 53.9 | 16.2 | 173 | 314 | |
| Vert. | 4960.000 | AV | 34.6 | 32.0 | 5.9 | 39.4 | 3.1 | 36.2 | 53.9 | 17.7 | 150 | 0 | |
| Vert. | 7440.000 | AV | 34.0 | 37.0 | 7.3 | 40.4 | 3.1 | 41.0 | 53.9 | 12.9 | 150 | 0 | |
| Vert. | 9920.000 | AV | 32.2 | 38.4 | 8.2 | 39.4 | 3.1 | 42.5 | 53.9 | 11.4 | 150 | 0 | |

Result = Reading + Ant.Fac. + Loss (Cable+(Attenuator or Filter)(below 18 GHz)) - Gain(Amplifier) + Distance factor

Distance factor : 1 GHz - 13 GHz : $20\log(4.3 \text{ m} / 3.0 \text{ m}) = 3.13 \text{ dB}$

13 GHz - 40 GHz : $20\log(1.0 \text{ m} / 3.0 \text{ m}) = -9.5 \text{ dB}$

* These results have sufficient margin without taking account Dwell time factor.

UL Japan, Inc.

Shonan EMC Lab.

1-22-3 Megumigaoka, Hiratsuka-shi, Kanagawa-ken, 259-1220 JAPAN

Telephone : +81 463 50 6400

Facsimile : +81 463 50 6401

13-EM-F0429

Radiated Spurious Emission
(Reference Plot for band-edge)

Test place : Shonan EMC Lab. No.3 Semi Anechoic Chamber
Report No. : 11307145S-A-R2
Date : June 8, 2016
Temperature / Humidity : 22 deg. C / 54 % RH
Engineer : Wataru Kojima
(1-13GHz)
Mode : Tx, Hopping Off, DH5 2480 MHz

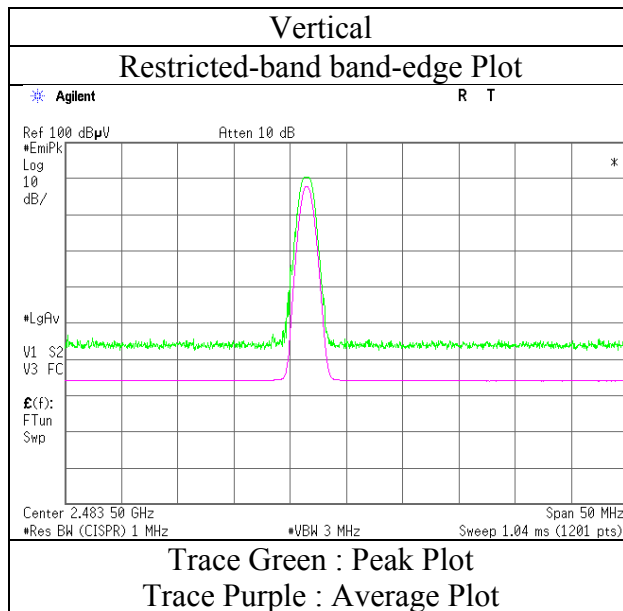
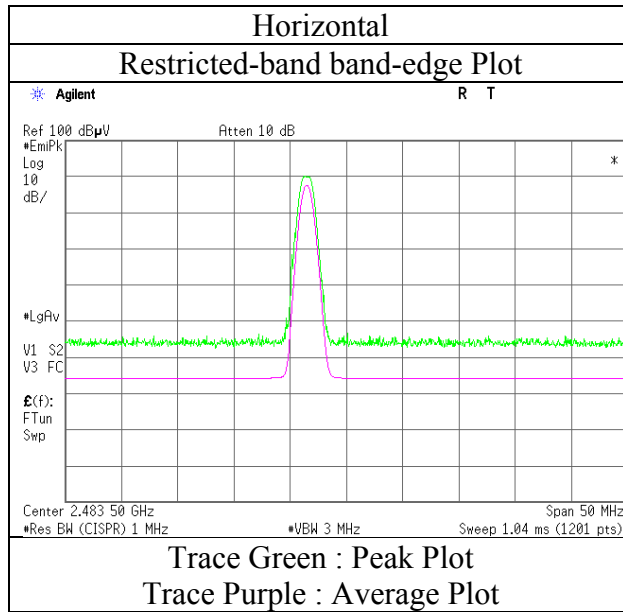

* Final result of restricted band edge was shown in tabular data.

Radiated Spurious Emission

Test place : Shonan EMC Lab. No.3 Semi Anechoic Chamber
Report No. : 11307145S-A-R2
Date : June 7, 2016 June 8, 2016
Temperature / Humidity : 23 deg. C / 47 % RH 22 deg. C / 54 % RH
Engineer : Makoto Hosaka Wataru Kojima
(30-1000MHz, 18-26.5GHz) (1-13GHz, 13-18GHz)
Mode : Tx, Hopping Off, 3DH5 2402 MHz

(* PK: Peak, AV: Average, QP: Quasi-Peak)

| Polarity | Frequency [MHz] | Detector | Reading [dBuV] | Ant.Fac. [dB/m] | Loss [dB] | Gain [dB] | Distance Factor [dB] | Result [dBuV/m] | Limit [dBuV/m] | Margin [dB] | Height [cm] | Angle [deg] | Remark |
|----------|-----------------|----------|----------------|-----------------|-----------|-----------|----------------------|-----------------|----------------|-------------|-------------|-------------|--------|
| Hori. | 148.029 | QP | 30.6 | 14.5 | 7.8 | 32.1 | 0.0 | 20.8 | 43.5 | 22.7 | 300 | 96 | |
| Hori. | 185.034 | QP | 32.3 | 16.0 | 8.0 | 32.1 | 0.0 | 24.2 | 43.5 | 19.3 | 248 | 130 | |
| Hori. | 259.049 | QP | 34.1 | 17.5 | 8.5 | 32.0 | 0.0 | 28.1 | 46.0 | 17.9 | 135 | 127 | |
| Hori. | 333.062 | QP | 31.4 | 14.6 | 8.9 | 31.9 | 0.0 | 23.0 | 46.0 | 23.0 | 100 | 230 | |
| Hori. | 370.076 | QP | 28.8 | 15.4 | 9.0 | 31.9 | 0.0 | 21.3 | 46.0 | 24.7 | 150 | 77 | |
| Hori. | 479.999 | QP | 28.2 | 17.1 | 9.5 | 31.9 | 0.0 | 22.9 | 46.0 | 23.1 | 126 | 206 | |
| Hori. | 2390.000 | PK | 45.9 | 27.8 | 13.8 | 41.0 | 3.1 | 49.6 | 73.9 | 24.3 | 149 | 66 | |
| Hori. | 4804.000 | PK | 46.9 | 31.4 | 5.8 | 39.6 | 3.1 | 47.6 | 73.9 | 26.3 | 150 | 0 | |
| Hori. | 7206.000 | PK | 47.4 | 36.9 | 7.1 | 40.1 | 3.1 | 54.4 | 73.9 | 19.5 | 150 | 0 | |
| Hori. | 9608.000 | PK | 46.9 | 38.5 | 8.1 | 39.6 | 3.1 | 57.0 | 73.9 | 16.9 | 150 | 0 | |
| Hori. | 2390.000 | AV | 32.4 | 27.8 | 13.8 | 41.0 | 3.1 | 36.1 | 53.9 | 17.8 | 149 | 66 | |
| Hori. | 4804.000 | AV | 34.9 | 31.4 | 5.8 | 39.6 | 3.1 | 35.6 | 53.9 | 18.3 | 150 | 0 | |
| Hori. | 7206.000 | AV | 34.8 | 36.9 | 7.1 | 40.1 | 3.1 | 41.8 | 53.9 | 12.1 | 150 | 0 | |
| Hori. | 9608.000 | AV | 34.1 | 38.5 | 8.1 | 39.6 | 3.1 | 44.2 | 53.9 | 9.7 | 150 | 0 | |
| Vert. | 37.007 | QP | 31.9 | 15.0 | 6.8 | 32.2 | 0.0 | 21.5 | 40.0 | 18.5 | 100 | 114 | |
| Vert. | 111.021 | QP | 34.5 | 11.3 | 7.5 | 32.1 | 0.0 | 21.2 | 43.5 | 22.3 | 100 | 275 | |
| Vert. | 148.027 | QP | 30.2 | 14.5 | 7.8 | 32.1 | 0.0 | 20.4 | 43.5 | 23.1 | 100 | 31 | |
| Vert. | 180.004 | QP | 30.1 | 15.9 | 8.0 | 32.1 | 0.0 | 21.9 | 43.5 | 21.6 | 100 | 170 | |
| Vert. | 185.035 | QP | 33.1 | 16.0 | 8.0 | 32.1 | 0.0 | 25.0 | 43.5 | 18.5 | 100 | 6 | |
| Vert. | 2390.000 | PK | 47.5 | 27.8 | 13.8 | 41.0 | 3.1 | 51.2 | 73.9 | 22.7 | 145 | 304 | |
| Vert. | 4804.000 | PK | 46.2 | 31.4 | 5.8 | 39.6 | 3.1 | 46.9 | 73.9 | 27.0 | 150 | 0 | |
| Vert. | 7206.000 | PK | 46.7 | 36.9 | 7.1 | 40.1 | 3.1 | 53.7 | 73.9 | 20.2 | 150 | 0 | |
| Vert. | 9608.000 | PK | 46.0 | 38.5 | 8.1 | 39.6 | 3.1 | 56.1 | 73.9 | 17.8 | 150 | 0 | |
| Vert. | 2390.000 | AV | 35.1 | 27.8 | 13.8 | 41.0 | 3.1 | 38.8 | 53.9 | 15.1 | 145 | 304 | |
| Vert. | 4804.000 | AV | 34.9 | 31.4 | 5.8 | 39.6 | 3.1 | 35.6 | 53.9 | 18.3 | 150 | 0 | |
| Vert. | 7206.000 | AV | 34.9 | 36.9 | 7.1 | 40.1 | 3.1 | 41.9 | 53.9 | 12.0 | 150 | 0 | |
| Vert. | 9608.000 | AV | 34.1 | 38.5 | 8.1 | 39.6 | 3.1 | 44.2 | 53.9 | 9.7 | 150 | 0 | |

Result = Reading + Ant.Fac. + Loss (Cable+(Attenuator or Filter)(below 18 GHz)) - Gain(Amplifier) + Distance factor

Distance factor : 1 GHz - 13 GHz : $20\log(4.3\text{ m} / 3.0\text{ m}) = 3.13\text{ dB}$

13 GHz - 40 GHz : $20\log(1.0\text{ m} / 3.0\text{ m}) = -9.5\text{ dB}$

* These results have sufficient margin without taking account Dwell time factor.

20 dBc Data Sheet (RBW 100 kHz, VBW 300 kHz)

| Polarity | Frequency [MHz] | Detector | Reading [dBuV] | Ant.Fac. [dB/m] | Loss [dB] | Gain [dB] | Distance Factor [dB] | Result [dBuV/m] | Limit [dBuV/m] | Margin [dB] | Remark |
|----------|-----------------|----------|----------------|-----------------|-----------|-----------|----------------------|-----------------|----------------|-------------|---------|
| Hori. | 2402.000 | PK | 87.1 | 27.8 | 13.8 | 41.0 | 3.1 | 90.8 | - | - | Carrier |
| Hori. | 2400.000 | PK | 37.5 | 27.8 | 13.8 | 41.0 | 3.1 | 41.2 | 70.8 | 29.6 | |
| Vert. | 2402.000 | PK | 86.4 | 27.8 | 13.8 | 41.0 | 3.1 | 90.1 | - | - | Carrier |
| Vert. | 2400.000 | PK | 37.8 | 27.8 | 13.8 | 41.0 | 3.1 | 41.5 | 70.1 | 28.6 | |

Result = Reading + Ant.Fac. + Loss (Cable+(Attenuator or Filter)(below 18 GHz)) - Gain(Amplifier) + Distance factor

Distance factor : 1 GHz - 13 GHz : $20\log(4.3\text{ m} / 3.0\text{ m}) = 3.13\text{ dB}$

13 GHz - 40 GHz : $20\log(1.0\text{ m} / 3.0\text{ m}) = -9.5\text{ dB}$

Radiated Spurious Emission
(Reference Plot for band-edge)

| | |
|------------------------|--|
| Test place | Shonan EMC Lab. No.3 Semi Anechoic Chamber |
| Report No. | 11307145S-A-R2 |
| Date | June 8, 2016 |
| Temperature / Humidity | 22 deg. C / 54 % RH |
| Engineer | Wataru Kojima (1-13GHz) |
| Mode | Tx, Hopping Off, 3DH5 2402 MHz |

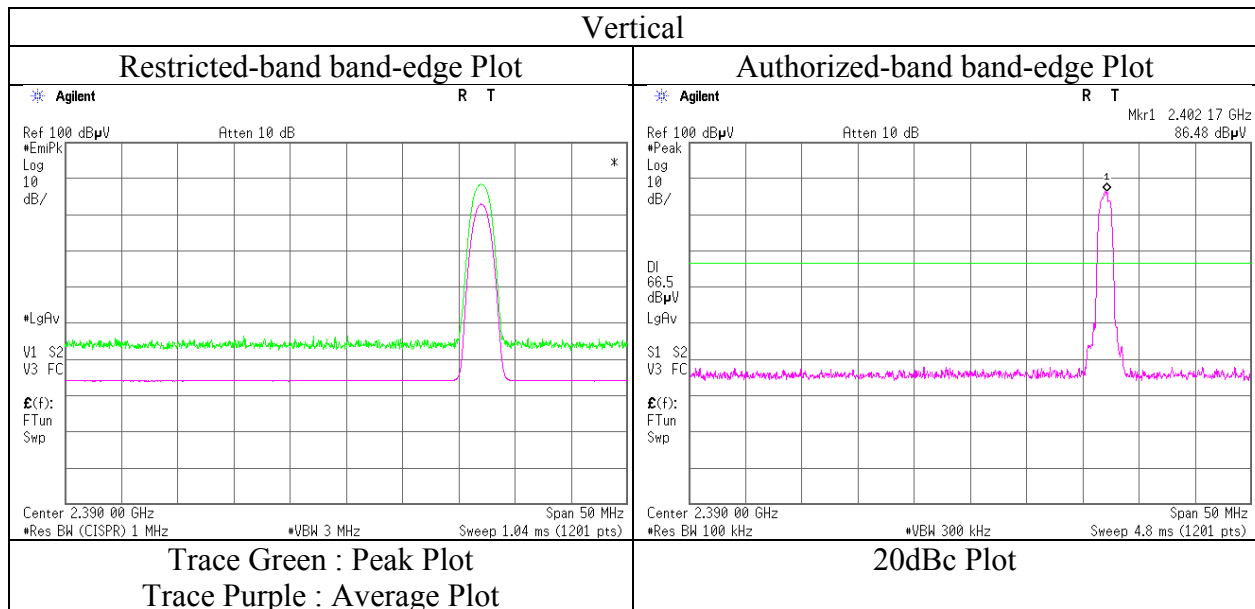
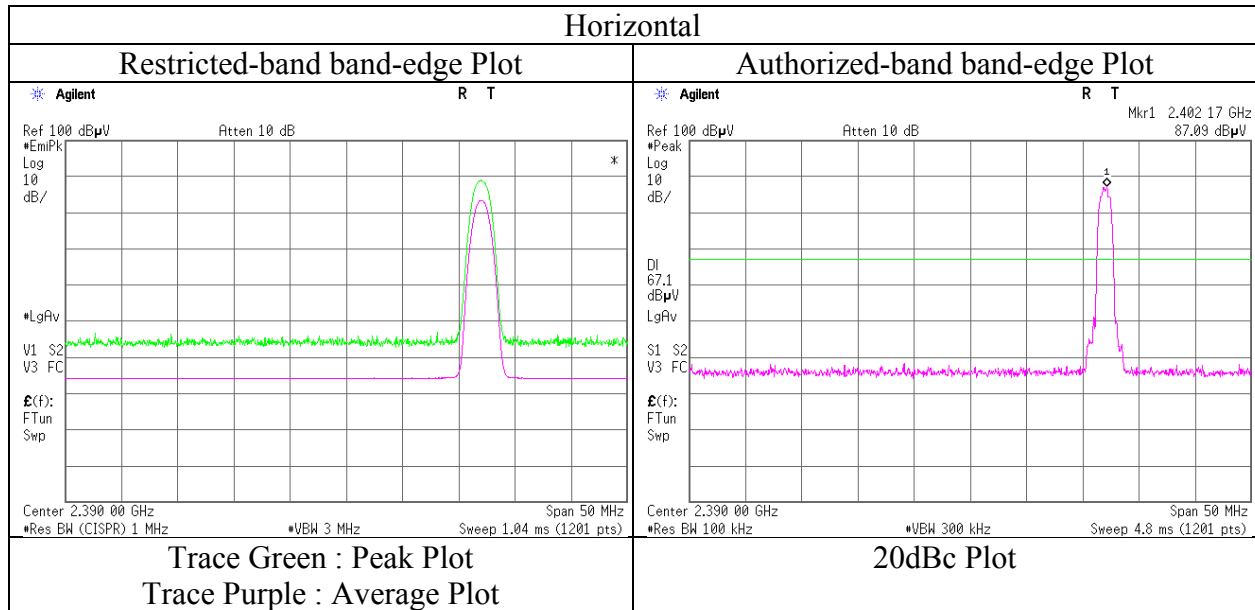

* Final result of restricted band edge was shown in tabular data.

Radiated Spurious Emission

| | | |
|------------------------|--|---------------------|
| Test place | Shonan EMC Lab. No.3 Semi Anechoic Chamber | |
| Report No. | 11307145S-A-R2 | |
| Date | June 7, 2016 | June 8, 2016 |
| Temperature / Humidity | 23 deg. C / 47 % RH | 22 deg. C / 54 % RH |
| Engineer | Makoto Hosaka | Wataru Kojima |
| | (30-1000MHz, 18-26.5GHz) (1-13GHz, 13-18GHz) | |
| Mode | Tx, Hopping Off, 3DH5 2441 MHz | |

(* PK: Peak, AV: Average, QP: Quasi-Peak)

| Polarity | Frequency [MHz] | Detector | Reading [dBuV] | Ant.Fac. [dB/m] | Loss [dB] | Gain [dB] | Distance Factor [dB] | Result [dBuV/m] | Limit [dBuV/m] | Margin [dB] | Height [cm] | Angle [deg] | Remark |
|----------|-----------------|----------|----------------|-----------------|-----------|-----------|----------------------|-----------------|----------------|-------------|-------------|-------------|--------|
| Hori. | 120.275 | QP | 33.4 | 12.6 | 7.6 | 32.1 | 0.0 | 21.5 | 43.5 | 22.0 | 295 | 91 | |
| Hori. | 138.764 | QP | 32.2 | 14.0 | 7.7 | 32.1 | 0.0 | 21.8 | 43.5 | 21.7 | 334 | 88 | |
| Hori. | 185.034 | QP | 33.1 | 16.0 | 8.0 | 32.1 | 0.0 | 25.0 | 43.5 | 18.5 | 247 | 232 | |
| Hori. | 259.048 | QP | 33.4 | 17.5 | 8.5 | 32.0 | 0.0 | 27.4 | 46.0 | 18.6 | 129 | 121 | |
| Hori. | 333.063 | QP | 30.9 | 14.6 | 8.9 | 31.9 | 0.0 | 22.5 | 46.0 | 23.5 | 163 | 48 | |
| Hori. | 370.070 | QP | 31.3 | 15.4 | 9.0 | 31.9 | 0.0 | 23.8 | 46.0 | 22.2 | 146 | 64 | |
| Hori. | 4882.000 | PK | 47.4 | 31.7 | 5.9 | 39.5 | 3.1 | 48.6 | 73.9 | 25.3 | 150 | 0 | |
| Hori. | 7323.000 | PK | 46.1 | 36.9 | 7.2 | 40.2 | 3.1 | 53.1 | 73.9 | 20.8 | 150 | 0 | |
| Hori. | 9764.000 | PK | 45.2 | 38.5 | 8.1 | 39.5 | 3.1 | 55.4 | 73.9 | 18.5 | 150 | 0 | |
| Hori. | 4882.000 | AV | 34.7 | 31.7 | 5.9 | 39.5 | 3.1 | 35.9 | 53.9 | 18.0 | 150 | 0 | |
| Hori. | 7323.000 | AV | 34.5 | 36.9 | 7.2 | 40.2 | 3.1 | 41.5 | 53.9 | 12.4 | 150 | 0 | |
| Hori. | 9764.000 | AV | 33.0 | 38.5 | 8.1 | 39.5 | 3.1 | 43.2 | 53.9 | 10.7 | 150 | 0 | |
| Vert. | 30.539 | QP | 22.9 | 16.8 | 6.8 | 32.2 | 0.0 | 14.3 | 40.0 | 25.7 | 100 | -1 | |
| Vert. | 37.008 | QP | 35.2 | 15.0 | 6.8 | 32.2 | 0.0 | 24.8 | 40.0 | 15.2 | 100 | 108 | |
| Vert. | 111.020 | QP | 34.5 | 11.3 | 7.5 | 32.1 | 0.0 | 21.2 | 43.5 | 22.3 | 100 | 239 | |
| Vert. | 185.036 | QP | 31.6 | 16.0 | 8.0 | 32.1 | 0.0 | 23.5 | 43.5 | 20.0 | 100 | 360 | |
| Vert. | 4882.000 | PK | 47.3 | 31.7 | 5.9 | 39.5 | 3.1 | 48.5 | 73.9 | 25.4 | 150 | 0 | |
| Vert. | 7323.000 | PK | 45.8 | 36.9 | 7.2 | 40.2 | 3.1 | 52.8 | 73.9 | 21.1 | 150 | 0 | |
| Vert. | 9764.000 | PK | 45.0 | 38.5 | 8.1 | 39.5 | 3.1 | 55.2 | 73.9 | 18.7 | 150 | 0 | |
| Vert. | 4882.000 | AV | 34.7 | 31.7 | 5.9 | 39.5 | 3.1 | 35.9 | 53.9 | 18.0 | 150 | 0 | |
| Vert. | 7323.000 | AV | 34.3 | 36.9 | 7.2 | 40.2 | 3.1 | 41.3 | 53.9 | 12.6 | 150 | 0 | |
| Vert. | 9764.000 | AV | 33.1 | 38.5 | 8.1 | 39.5 | 3.1 | 43.3 | 53.9 | 10.6 | 150 | 0 | |

Result = Reading + Ant.Fac. + Loss (Cable+(Attenuator or Filter)(below 18 GHz)) - Gain(Amplifier) + Distance factor

Distance factor : 1 GHz - 13 GHz : 20log(4.3 m / 3.0 m) = 3.13 dB

13 GHz - 40 GHz : 20log(1.0 m / 3.0 m) = -9.5 dB

* These results have sufficient margin without taking account Dwell time factor.

Radiated Spurious Emission

| | | |
|------------------------|--|---------------------|
| Test place | Shonan EMC Lab. No.3 Semi Anechoic Chamber | |
| Report No. | 11307145S-A-R2 | |
| Date | June 7, 2016 | June 8, 2016 |
| Temperature / Humidity | 23 deg. C / 47 % RH | 22 deg. C / 54 % RH |
| Engineer | Makoto Hosaka | Wataru Kojima |
| | (30-1000MHz, 18-26.5GHz) (1-13GHz, 13-18GHz) | |
| Mode | Tx, Hopping Off, 3DH5 2480 MHz | |

(* PK: Peak, AV: Average, QP: Quasi-Peak)

| Polarity | Frequency [MHz] | Detector | Reading [dBuV] | Ant. Fac. [dB/m] | Loss [dB] | Gain [dB] | Distance Factor [dB] | Result [dBuV/m] | Limit [dBuV/m] | Margin [dB] | Height [cm] | Angle [deg] | Remark |
|----------|-----------------|----------|----------------|------------------|-----------|-----------|----------------------|-----------------|----------------|-------------|-------------|-------------|--------|
| Hori. | 127.997 | QP | 30.2 | 13.2 | 7.6 | 32.1 | 0.0 | 18.9 | 43.5 | 24.6 | 333 | 67 | |
| Hori. | 138.776 | QP | 30.7 | 14.0 | 7.7 | 32.1 | 0.0 | 20.3 | 43.5 | 23.2 | 222 | 124 | |
| Hori. | 148.028 | QP | 32.4 | 14.5 | 7.8 | 32.1 | 0.0 | 22.6 | 43.5 | 20.9 | 224 | 92 | |
| Hori. | 185.035 | QP | 33.6 | 16.0 | 8.0 | 32.1 | 0.0 | 25.5 | 43.5 | 18.0 | 248 | 233 | |
| Hori. | 259.047 | QP | 33.7 | 17.5 | 8.5 | 32.0 | 0.0 | 27.7 | 46.0 | 18.3 | 131 | 123 | |
| Hori. | 333.062 | QP | 31.5 | 14.6 | 8.9 | 31.9 | 0.0 | 23.1 | 46.0 | 22.9 | 158 | 49 | |
| Hori. | 370.069 | QP | 31.0 | 15.4 | 9.0 | 31.9 | 0.0 | 23.5 | 46.0 | 22.5 | 163 | 69 | |
| Hori. | 2483.500 | PK | 46.6 | 27.9 | 13.9 | 41.0 | 3.1 | 50.5 | 73.9 | 23.4 | 140 | 307 | |
| Hori. | 4960.000 | PK | 46.4 | 32.0 | 5.9 | 39.4 | 3.1 | 48.0 | 73.9 | 25.9 | 150 | 0 | |
| Hori. | 7440.000 | PK | 46.1 | 37.0 | 7.3 | 40.4 | 3.1 | 53.1 | 73.9 | 20.8 | 150 | 0 | |
| Hori. | 9920.000 | PK | 43.7 | 38.4 | 8.2 | 39.4 | 3.1 | 54.0 | 73.9 | 19.9 | 150 | 0 | |
| Hori. | 2483.500 | AV | 32.2 | 27.9 | 13.9 | 41.0 | 3.1 | 36.1 | 53.9 | 17.8 | 140 | 307 | |
| Hori. | 4960.000 | AV | 34.6 | 32.0 | 5.9 | 39.4 | 3.1 | 36.2 | 53.9 | 17.7 | 150 | 0 | |
| Hori. | 7440.000 | AV | 34.0 | 37.0 | 7.3 | 40.4 | 3.1 | 41.0 | 53.9 | 12.9 | 150 | 0 | |
| Hori. | 9920.000 | AV | 32.2 | 38.4 | 8.2 | 39.4 | 3.1 | 42.5 | 53.9 | 11.4 | 150 | 0 | |
| Vert. | 37.007 | QP | 29.6 | 15.0 | 6.8 | 32.2 | 0.0 | 19.2 | 40.0 | 20.8 | 100 | 187 | |
| Vert. | 111.021 | QP | 31.1 | 11.3 | 7.5 | 32.1 | 0.0 | 17.8 | 43.5 | 25.7 | 100 | 104 | |
| Vert. | 148.028 | QP | 32.0 | 14.5 | 7.8 | 32.1 | 0.0 | 22.2 | 43.5 | 21.3 | 100 | 27 | |
| Vert. | 185.034 | QP | 32.7 | 16.0 | 8.0 | 32.1 | 0.0 | 24.6 | 43.5 | 18.9 | 100 | 7 | |
| Vert. | 2483.500 | PK | 45.3 | 27.9 | 13.9 | 41.0 | 3.1 | 49.2 | 73.9 | 24.7 | 162 | 316 | |
| Vert. | 4960.000 | PK | 46.9 | 32.0 | 5.9 | 39.4 | 3.1 | 48.5 | 73.9 | 25.4 | 150 | 0 | |
| Vert. | 7440.000 | PK | 45.8 | 37.0 | 7.3 | 40.4 | 3.1 | 52.8 | 73.9 | 21.1 | 150 | 0 | |
| Vert. | 9920.000 | PK | 44.3 | 38.4 | 8.2 | 39.4 | 3.1 | 54.6 | 73.9 | 19.3 | 150 | 0 | |
| Vert. | 2483.500 | AV | 33.8 | 27.9 | 13.9 | 41.0 | 3.1 | 37.7 | 53.9 | 16.2 | 162 | 316 | |
| Vert. | 4960.000 | AV | 34.5 | 32.0 | 5.9 | 39.4 | 3.1 | 36.1 | 53.9 | 17.8 | 150 | 0 | |
| Vert. | 7440.000 | AV | 34.0 | 37.0 | 7.3 | 40.4 | 3.1 | 41.0 | 53.9 | 12.9 | 150 | 0 | |
| Vert. | 9920.000 | AV | 32.2 | 38.4 | 8.2 | 39.4 | 3.1 | 42.5 | 53.9 | 11.4 | 150 | 0 | |

Result = Reading + Ant. Fac. + Loss (Cable+(Attenuator or Filter)(below 18 GHz)) - Gain(Amplifier) + Distance factor

Distance factor : 1 GHz - 13 GHz : $20\log(4.3\text{ m} / 3.0\text{ m}) = 3.13\text{ dB}$

13 GHz - 40 GHz : $20\log(1.0\text{ m} / 3.0\text{ m}) = -9.5\text{ dB}$

* These results have sufficient margin without taking account Dwell time factor.

UL Japan, Inc.

Shonan EMC Lab.

1-22-3 Megumigaoka, Hiratsuka-shi, Kanagawa-ken, 259-1220 JAPAN

Telephone : +81 463 50 6400

Facsimile : +81 463 50 6401

13-EM-F0429

Radiated Spurious Emission
(Reference Plot for band-edge)

| | |
|------------------------|--|
| Test place | Shonan EMC Lab. No.3 Semi Anechoic Chamber |
| Report No. | 11307145S-A-R2 |
| Date | June 8, 2016 |
| Temperature / Humidity | 22 deg. C / 54 % RH |
| Engineer | Wataru Kojima (1-13GHz) |
| Mode | Tx, Hopping Off, 3DH5 2480 MHz |

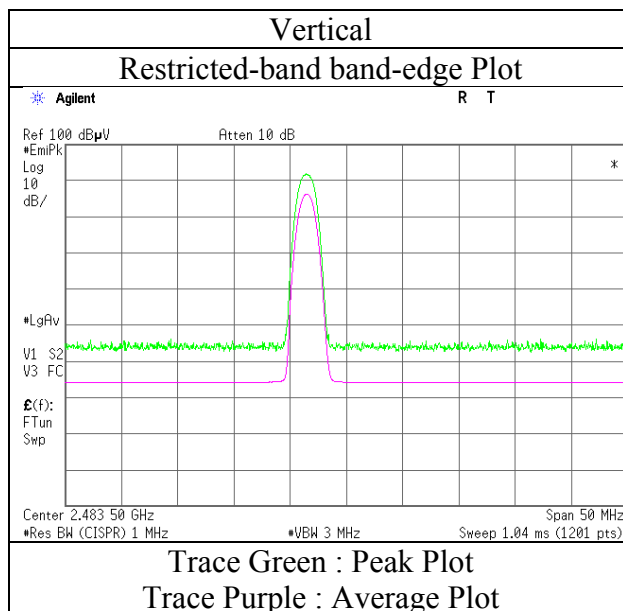
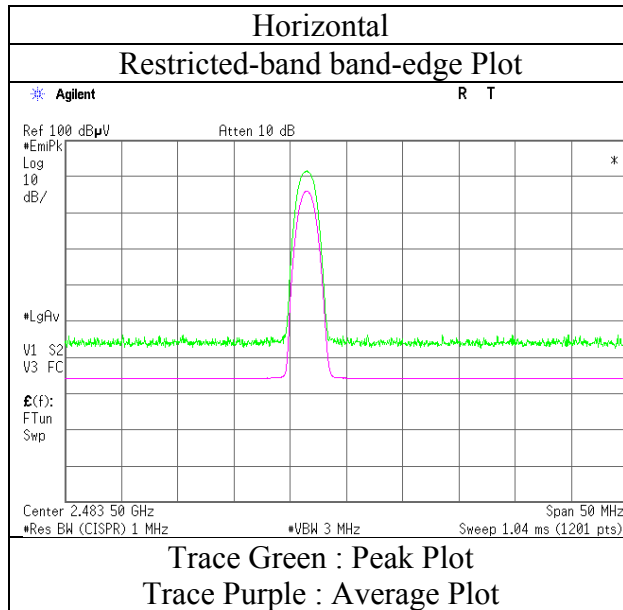

* Final result of restricted band edge was shown in tabular data.

Radiated Spurious Emission
(Plot data, Worst case)

| | | |
|------------------------|--|---------------------|
| Test place | Shonan EMC Lab. No.3 Semi Anechoic Chamber | |
| Report No. | 11307145S-A-R2 | |
| Date | June 7, 2016 | June 8, 2016 |
| Temperature / Humidity | 23 deg. C / 47 % RH | 22 deg. C / 54 % RH |
| Engineer | Makoto Hosaka | Wataru Kojima |
| | (30-1000MHz, 18-26.5GHz) | (1-13GHz, 13-18GHz) |
| Mode | Tx, Hopping Off, DH5 2402 MHz | |

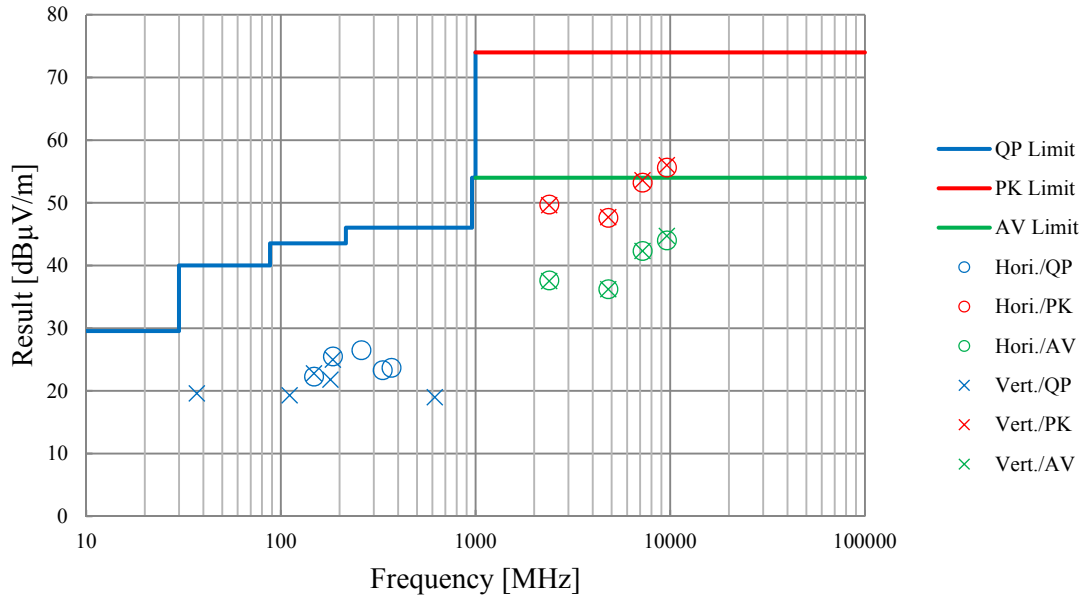

*These plots data contains sufficient number to show the trend of characteristic features for EUT.

Conducted Spurious Emission

| | |
|------------------------|------------------------------------|
| Test place | Shonan EMC Lab. No.5 Shielded Room |
| Report No. | 11307145S-A-R2 |
| Date | May 31, 2016 |
| Temperature / Humidity | 27 deg. C / 37 % RH |
| Engineer | Wataru Kojima |
| Mode | Tx, Hopping Off, DH5 |

2402 MHz

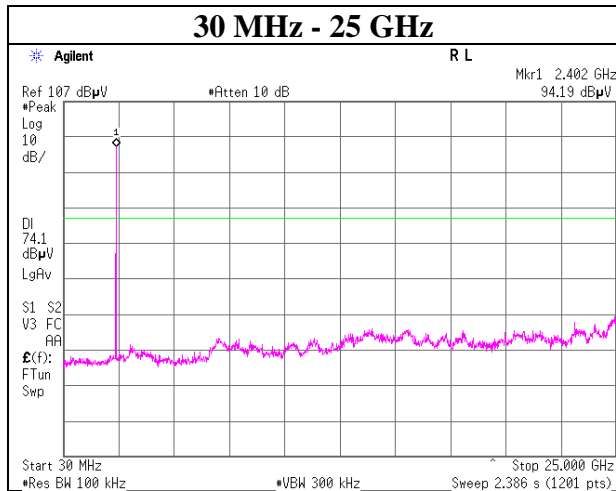
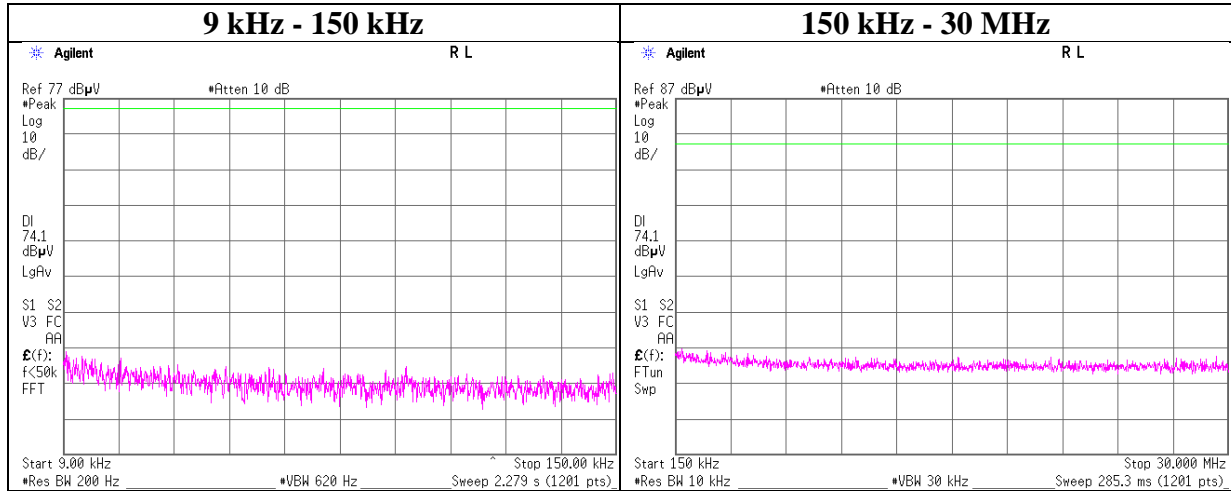

Conducted Spurious Emission

| | |
|------------------------|------------------------------------|
| Test place | Shonan EMC Lab. No.5 Shielded Room |
| Report No. | 11307145S-A-R2 |
| Date | May 31, 2016 |
| Temperature / Humidity | 27 deg. C / 37 % RH |
| Engineer | Wataru Kojima |
| Mode | Tx, Hopping Off, DH5 |

2441 MHz

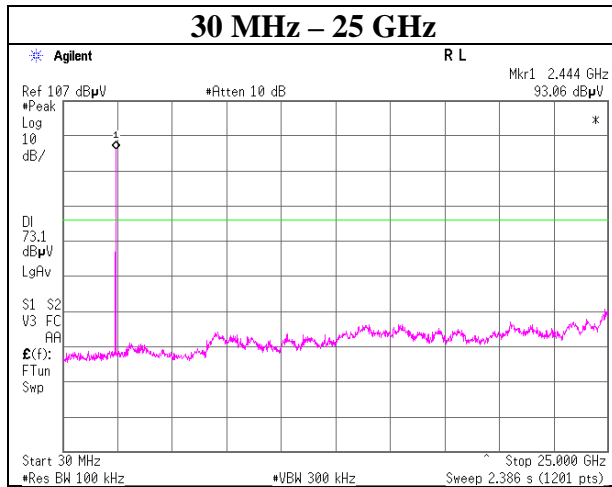
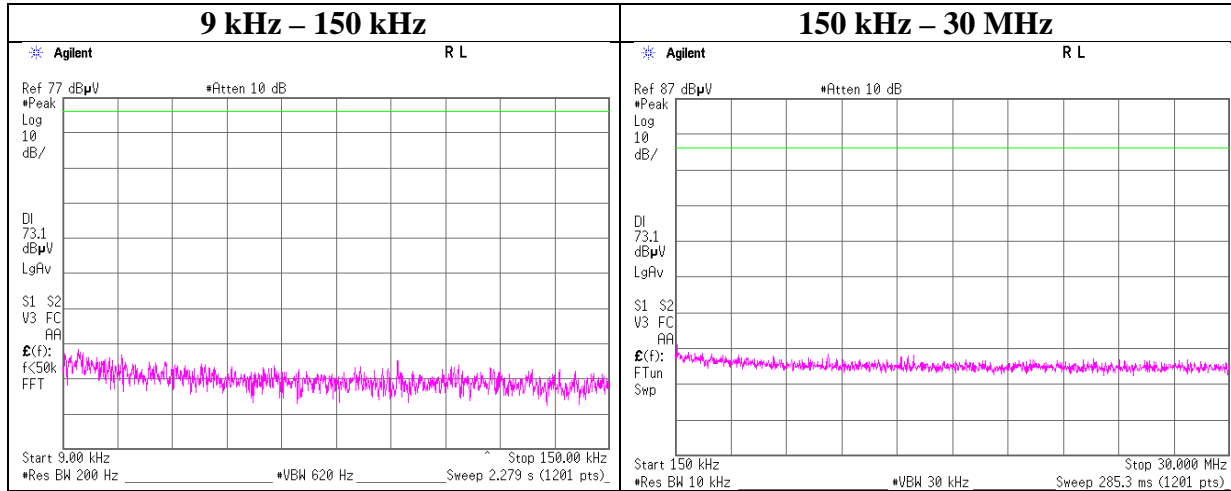

Conducted Spurious Emission

| | |
|------------------------|------------------------------------|
| Test place | Shonan EMC Lab. No.5 Shielded Room |
| Report No. | 11307145S-A-R2 |
| Date | May 31, 2016 |
| Temperature / Humidity | 27 deg. C / 37 % RH |
| Engineer | Wataru Kojima |
| Mode | Tx, Hopping Off, DH5 |

2480 MHz

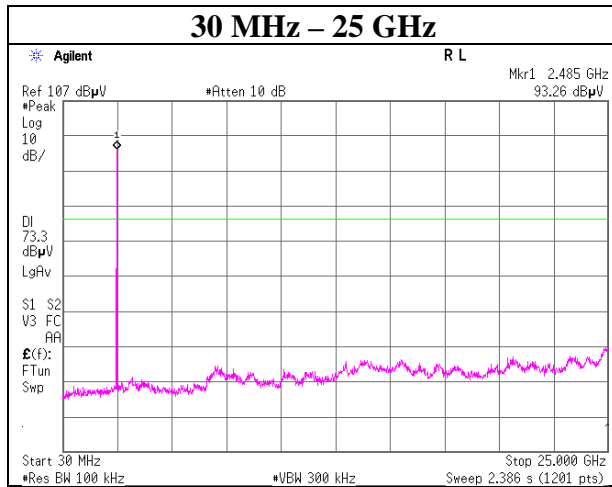
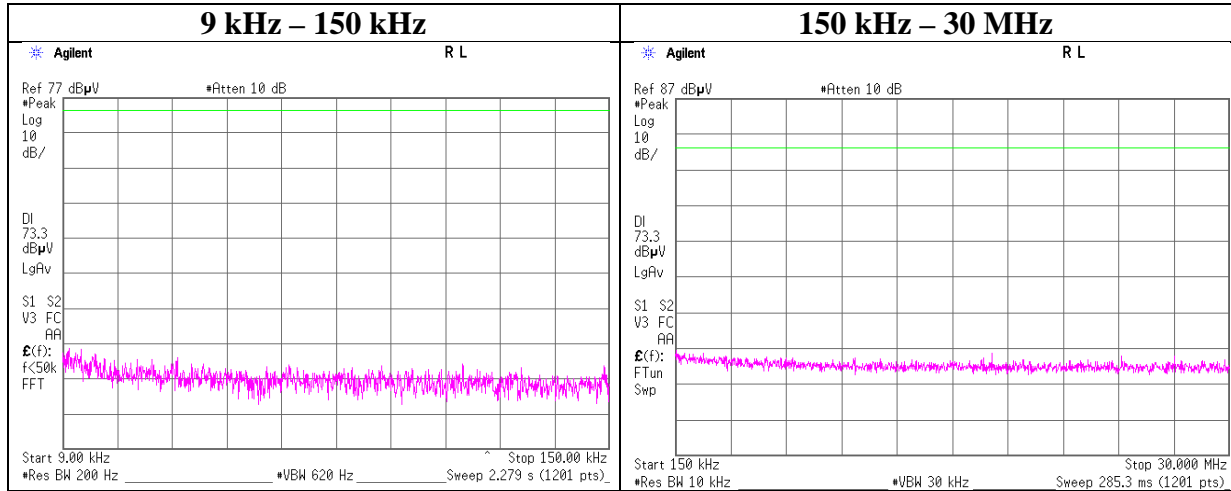

Conducted Spurious Emission

| | |
|------------------------|------------------------------------|
| Test place | Shonan EMC Lab. No.5 Shielded Room |
| Report No. | 11307145S-A-R2 |
| Date | May 31, 2016 |
| Temperature / Humidity | 27 deg. C / 37 % RH |
| Engineer | Wataru Kojima |
| Mode | Tx, Hopping Off, 3DH5 |

2402 MHz

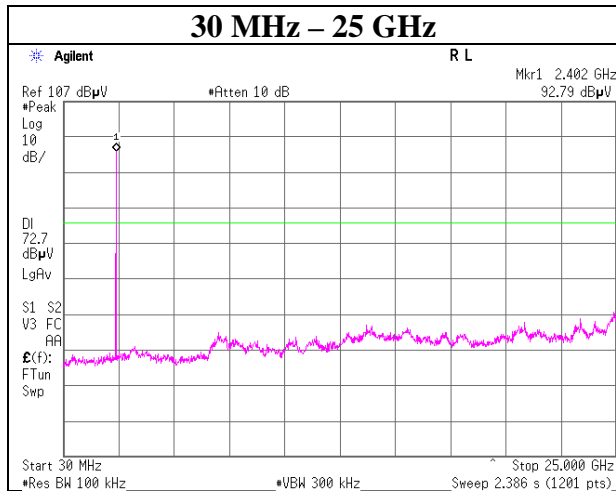
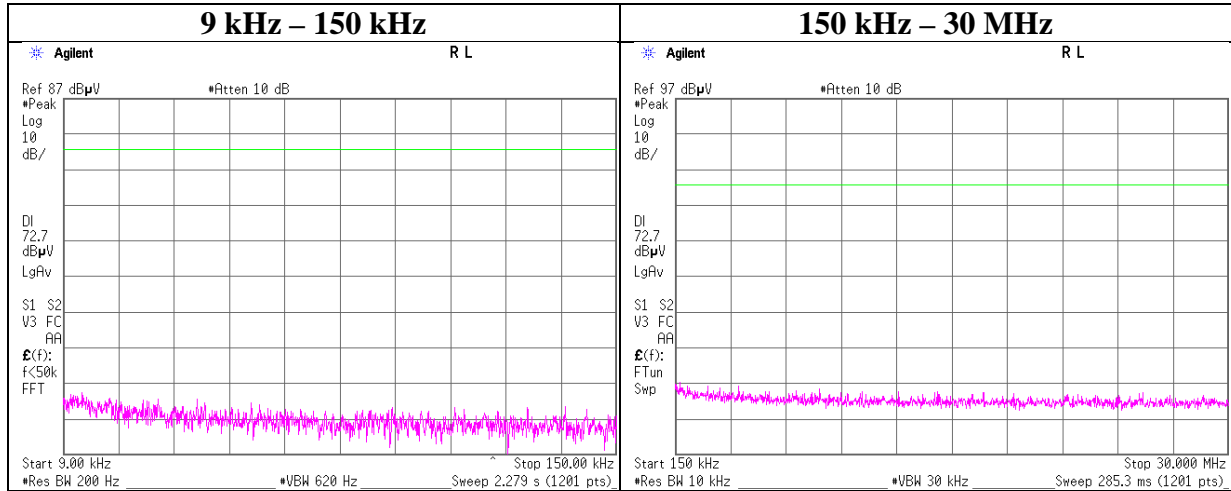

Conducted Spurious Emission

| | |
|------------------------|------------------------------------|
| Test place | Shonan EMC Lab. No.5 Shielded Room |
| Report No. | 11307145S-A-R2 |
| Date | May 31, 2016 |
| Temperature / Humidity | 27 deg. C / 37 % RH |
| Engineer | Wataru Kojima |
| Mode | Tx, Hopping Off, 3DH5 |

2441 MHz

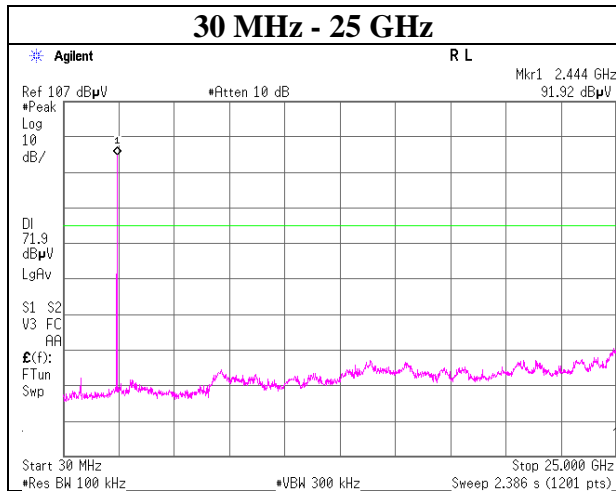
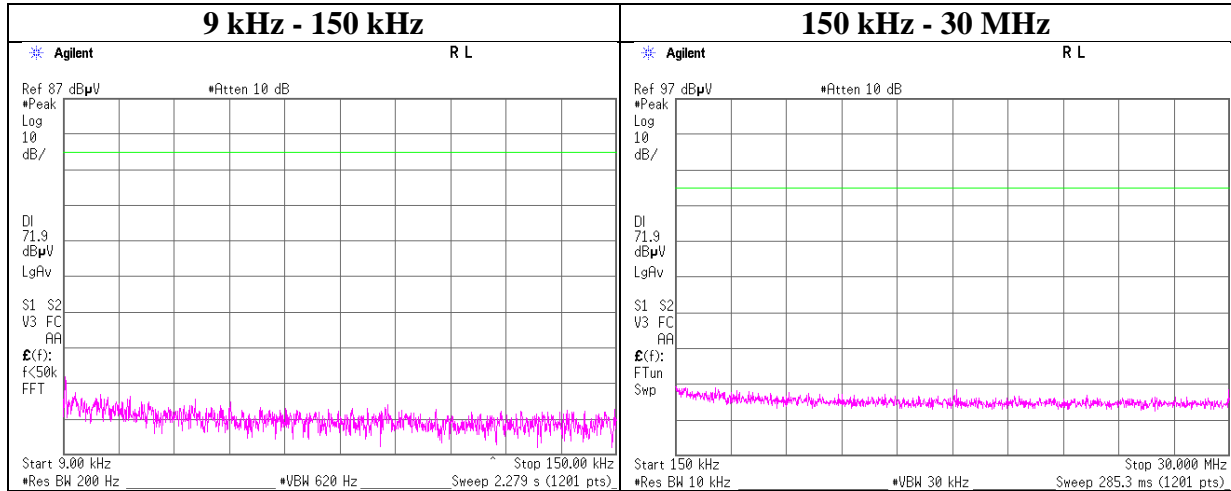

Conducted Spurious Emission

| | |
|------------------------|------------------------------------|
| Test place | Shonan EMC Lab. No.5 Shielded Room |
| Report No. | 11307145S-A-R2 |
| Date | May 31, 2016 |
| Temperature / Humidity | 27 deg. C / 37 % RH |
| Engineer | Wataru Kojima |
| Mode | Tx, Hopping Off, 3DH5 |

2480 MHz

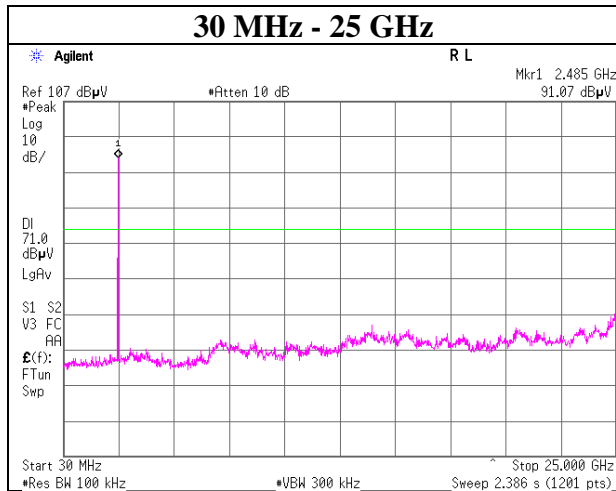
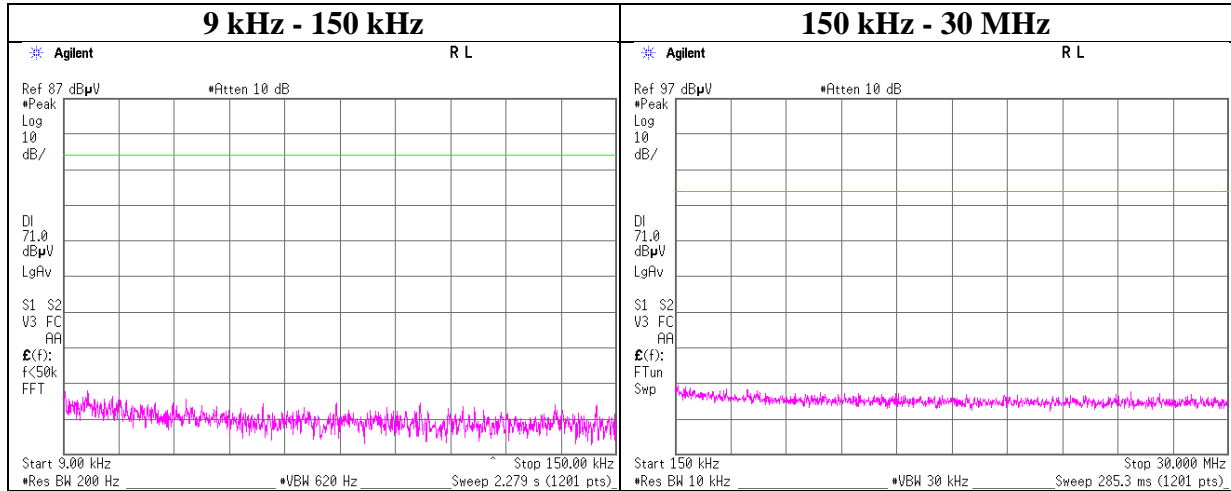

Conducted Emission Band Edge compliance

| | |
|------------------------|------------------------------------|
| Test place | Shonan EMC Lab. No.5 Shielded Room |
| Report No. | 11307145S-A-R2 |
| Date | May 31, 2016 |
| Temperature / Humidity | 27 deg. C / 37 % RH |
| Engineer | Wataru Kojima |
| Mode | Tx DH5 |

Hopping On

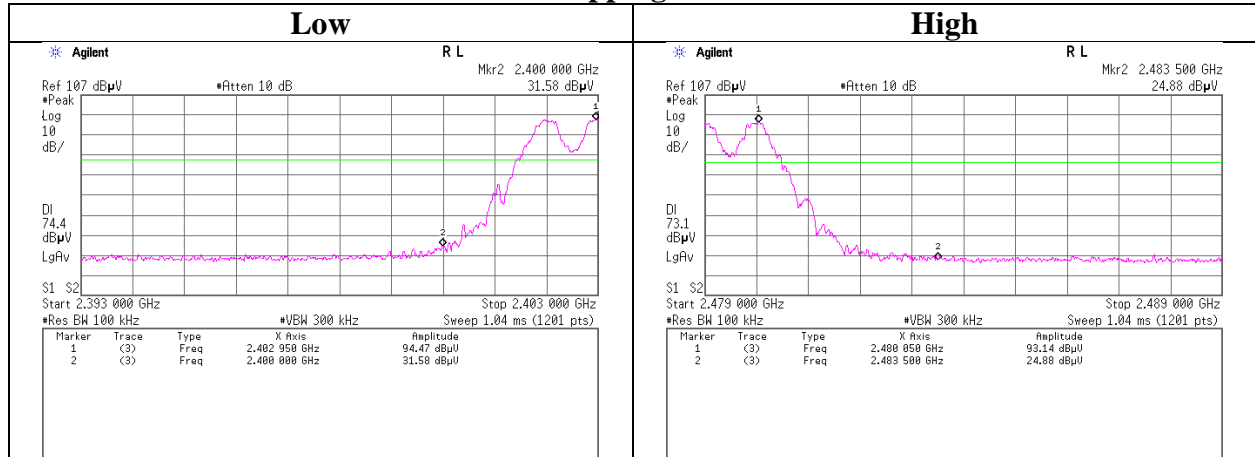

Hopping Off

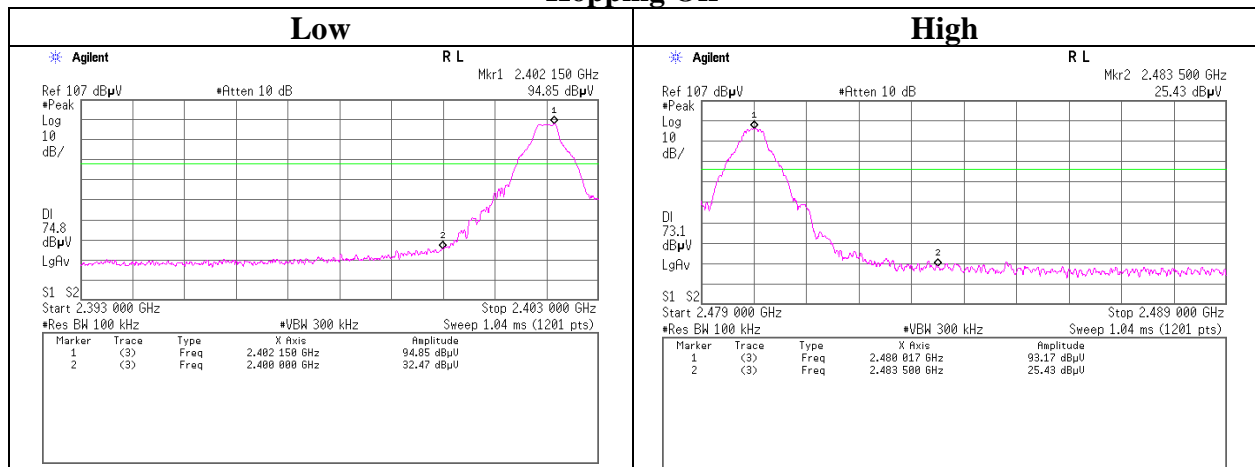

Conducted Emission Band Edge compliance

| | |
|------------------------|------------------------------------|
| Test place | Shonan EMC Lab. No.5 Shielded Room |
| Report No. | 11307145S-A-R2 |
| Date | May 31, 2016 |
| Temperature / Humidity | 27 deg. C / 37 % RH |
| Engineer | Wataru Kojima |
| Mode | Tx 3DH5 |

Hopping On

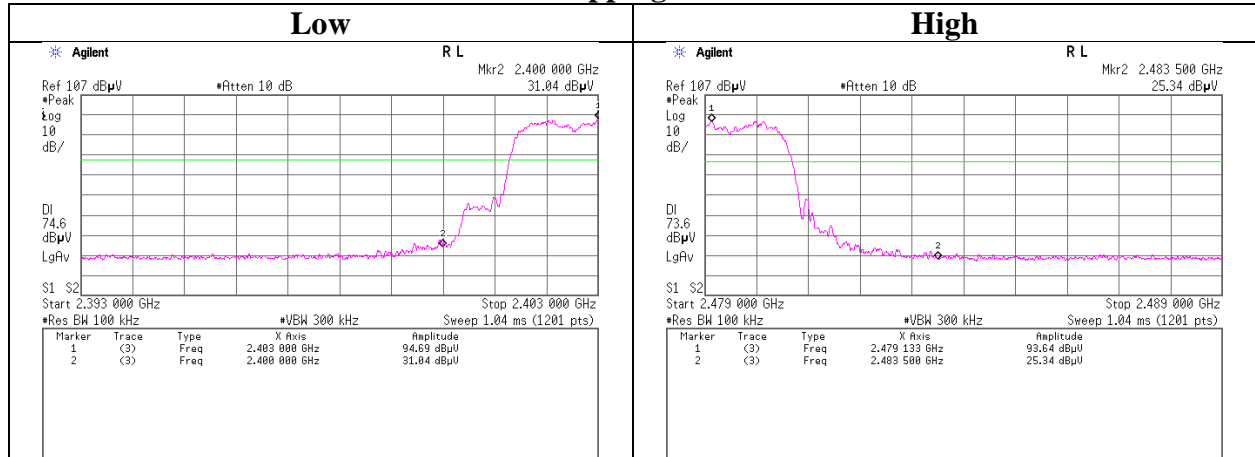

Hopping Off

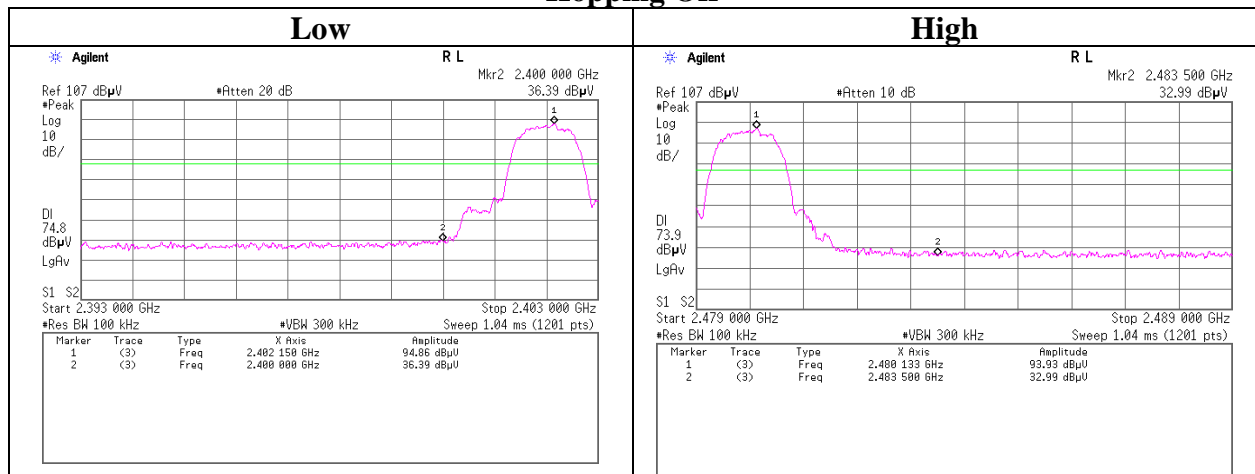

99%Occupied Bandwidth

| | |
|--|--|
| Test place Report No. Date Temperature / Humidity Engineer Mode | Shonan EMC Lab. No.5 Shielded Room 11307145S-A-R2 May 31, 2016 27 deg. C / 37 % RH Wataru Kojima Tx Hopping Off |
|--|--|

Hopping Off, DH5 2402 MHz

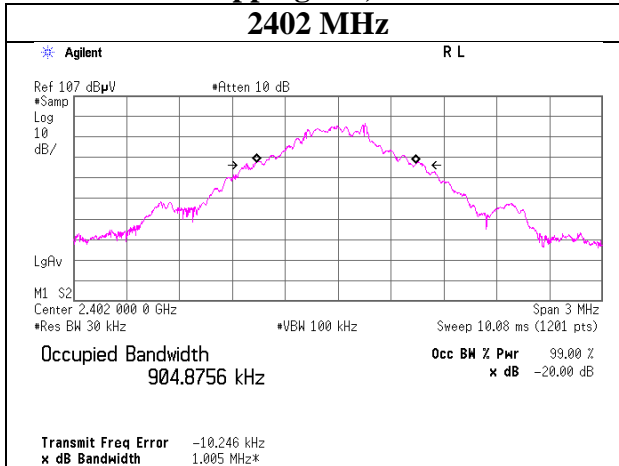

Hopping Off, 3DH5 2402 MHz

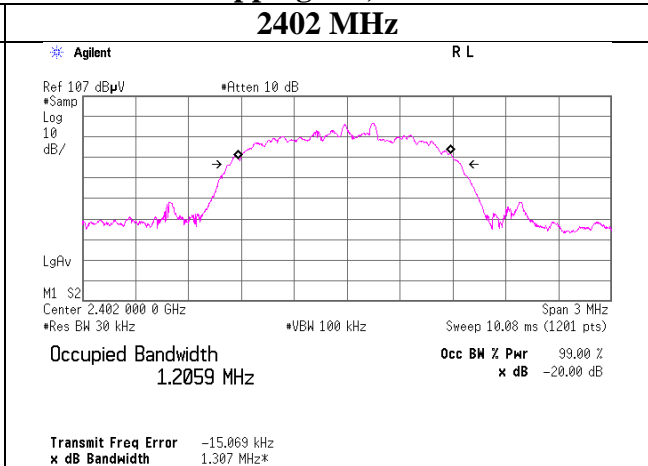

2441 MHz

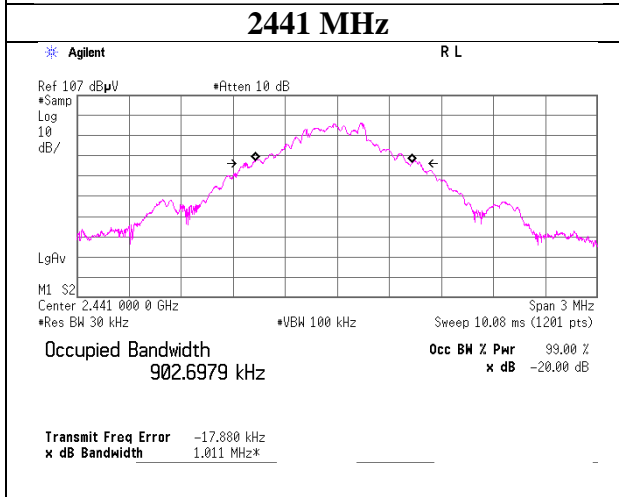

2441 MHz

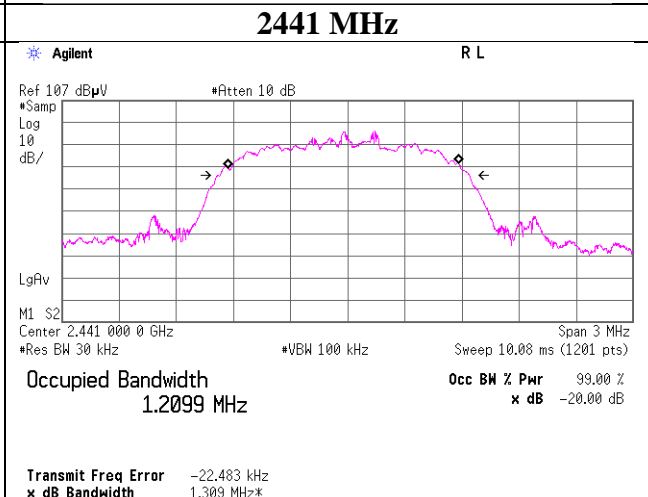

2480 MHz

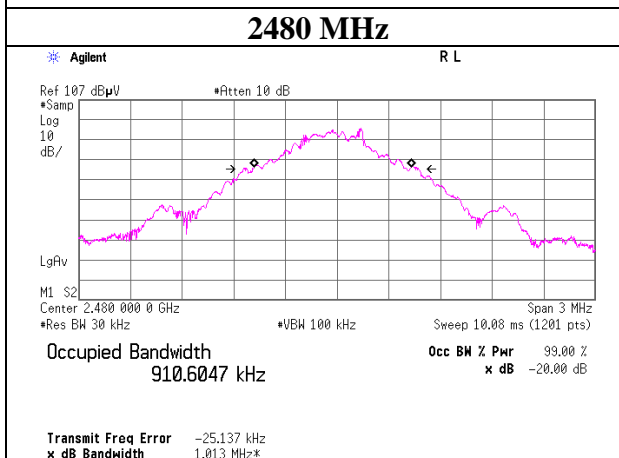

2480 MHz

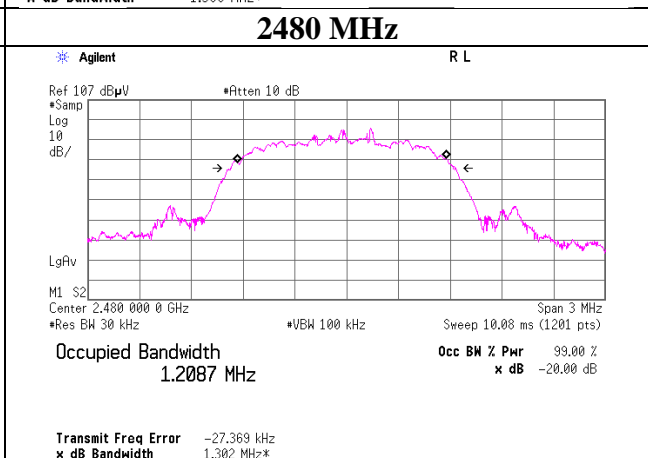

UL Japan, Inc.
Shonan EMC Lab.

1-22-3 Megumigaoka, Hiratsuka-shi, Kanagawa-ken, 259-1220 JAPAN
 Telephone : +81 463 50 6400
 Facsimile : +81 463 50 6401

99% Occupied Bandwidth

| | |
|------------------------|------------------------------------|
| Test place | Shonan EMC Lab. No.5 Shielded Room |
| Report No. | 11307145S-A-R2 |
| Date | May 31, 2016 |
| Temperature / Humidity | 27 deg. C / 37 % RH |
| Engineer | Wataru Kojima |
| Mode | Tx Hopping On |

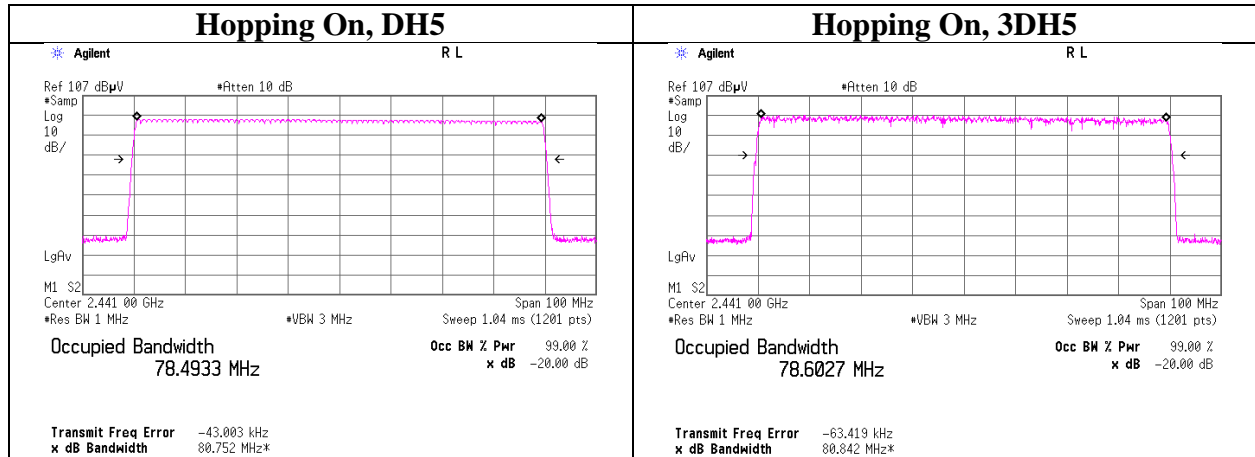

APPENDIX 2: Test instruments

Test equipment

| Control No. | Instrument | Manufacturer | Model No | Serial No | Test Item | Calibration Date * Interval(month) |
|--|------------------------------|--|--|----------------------------|-----------|---------------------------------------|
| SPM-07 | Power Meter | Agilent | 8990B | MY5100272 | AT | 2016/04/04 * 12 |
| SPSS-04 | Power sensor | Agilent | N1923A | MY5326009 | AT | 2016/04/04 * 12 |
| KSA-08 | Spectrum Analyzer | Agilent | E4446A | MY46180525 | AT | 2016/03/28 * 12 |
| SAT10-09 | Attenuator | Weinschel Corp. | 54A-10 | W5692 | AT | 2015/11/04 * 12 |
| SCC-G14 | Coaxial Cable | Suhner | SUCOFLEX 102 | 31600/2 | AT | 2016/03/23 * 12 |
| SOS-10 | Humidity Indicator | A&D | AD-5681 | 4064561 | AT | 2015/10/22 * 12 |
| STS-06 | Digital Hitester | Hioki | 3805-50 | 080997830 | AT | 2016/03/22 * 12 |
| SAEC-03(NSA) | Semi-Anechoic Chamber | TDK | SAEC-03(NSA) | 3 | RE | 2015/07/16 * 12 |
| SBA-03 | Biconical Antenna | Schwarzbeck | BBA9106 | 91032666 | RE | 2015/10/11 * 12 |
| SLA-03 | Logperiodic Antenna | Schwarzbeck | UHALP9108A | UHALP 9108-A 0901 | RE | 2015/10/11 * 12 |
| SAT6-08 | Attenuator | HIROSE ELECTRIC CO.,LTD. | AT-406(40) | - | RE | 2015/08/31 * 12 |
| SCC-C1/C2/C3/ C4/C5/C10/SRS E-03 | Coaxial Cable&RF Selector | Fujikura/Fujikura/Suhner/ Suhner/Suhner/Suhner/T OYO | 8D2W/12DSFA/141 PE/141PE/141PE/14 1PE/NS4906 | -/0901-271(RF Selector) | RE | 2016/04/22 * 12 |
| SAF-03 | Pre Amplifier | SONOMA | 310N | 290213 | RE | 2016/02/25 * 12 |
| STR-06 | Test Receiver | Rohde & Schwarz | ESCI | 101259 | RE | 2016/03/28 * 12 |
| COTS-SEMI-1 | EMI Software | TSJ | TEPTO-DV(RE,CE, RFI,MF) | - | RE | - |
| SOS-05 | Humidity Indicator | A&D | AD-5681 | 4062518 | RE | 2015/10/22 * 12 |
| SJM-15 | Measure | ASKUL | - | - | RE | - |
| STS-03 | Digital Hitester | Hioki | 3805-50 | 080997823 | RE | 2015/11/18 * 12 |
| SSA-01 | Spectrum Analyzer | Agilent | N9010A-526 | MY48031482 | RE | 2016/04/28 * 12 |
| SCC-G15 | Coaxial Cable | Suhner | SUCOFLEX 102 | 32703/2 | RE | 2016/03/08 * 12 |
| SCC-G33 | Coaxial Cable | Junkosha | MWX241-01000K MSKMS | - | RE | 2016/04/18 * 12 |
| SHA-04 | Horn Antenna | ETS LINDGREN | 3160-09 | LM3640 | RE | 2016/03/15 * 12 |
| SAF-08 | Pre Amplifier | TOYO Corporation | HAP18-26W | 00000019 | RE | 2016/03/23 * 12 |
| SAF-04 | Pre Amplifier | TOYO Corporation | TPA0118-36 | 1440489 | RE | 2016/03/22 * 12 |
| SCC-G04 | Coaxial Cable | Junkosha | J12J102207-00 | JUN-12-14-018 | RE | 2015/06/08 * 12 |
| SCC-G23 | Coaxial Cable | Suhner | SUCOFLEX 104 | 297342/4 | RE | 2016/05/11 * 12 |
| SHA-03 | Horn Antenna | Schwarzbeck | BBHA9120D | 9120D-739 | RE | 2015/08/11 * 12 |
| SSA-02 | Spectrum Analyzer | Agilent | E4448A | MY48250106 | RE | 2016/03/23 * 12 |
| SAEC-03(SVSW R) | Semi-Anechoic Chamber | TDK | SAEC-03(SVSWR) | 3 | RE | 2015/08/28 * 12 |
| SAT10-05 | Attenuator(above1GHz) | Agilent | 8493C-010 | 74864 | RE | 2015/11/04 * 12 |
| SFL-18 | Highpass Filter | MICRO-TRONICS | HPM50111 | 119 | RE | 2016/04/18 * 12 |

The expiration date of the calibration is the end of the expired month.

All equipment is calibrated with valid calibrations. Each measurement data is traceable to the national or international standards.

As for some calibrations performed after the tested dates, those test equipment have been controlled by means of an unbroken chains of calibrations.

Test Item: CE: Conducted Emission test
RE: Radiated Emission test
AT: Antenna Terminal Conducted test